



This is a digital copy of a book that was preserved for generations on library shelves before it was carefully scanned by Google as part of a project to make the world's books discoverable online.

It has survived long enough for the copyright to expire and the book to enter the public domain. A public domain book is one that was never subject to copyright or whose legal copyright term has expired. Whether a book is in the public domain may vary country to country. Public domain books are our gateways to the past, representing a wealth of history, culture and knowledge that's often difficult to discover.

Marks, notations and other marginalia present in the original volume will appear in this file - a reminder of this book's long journey from the publisher to a library and finally to you.

Usage guidelines

Google is proud to partner with libraries to digitize public domain materials and make them widely accessible. Public domain books belong to the public and we are merely their custodians. Nevertheless, this work is expensive, so in order to keep providing this resource, we have taken steps to prevent abuse by commercial parties, including placing technical restrictions on automated querying.

We also ask that you:

- + *Make non-commercial use of the files* We designed Google Book Search for use by individuals, and we request that you use these files for personal, non-commercial purposes.
- + *Refrain from automated querying* Do not send automated queries of any sort to Google's system: If you are conducting research on machine translation, optical character recognition or other areas where access to a large amount of text is helpful, please contact us. We encourage the use of public domain materials for these purposes and may be able to help.
- + *Maintain attribution* The Google "watermark" you see on each file is essential for informing people about this project and helping them find additional materials through Google Book Search. Please do not remove it.
- + *Keep it legal* Whatever your use, remember that you are responsible for ensuring that what you are doing is legal. Do not assume that just because we believe a book is in the public domain for users in the United States, that the work is also in the public domain for users in other countries. Whether a book is still in copyright varies from country to country, and we can't offer guidance on whether any specific use of any specific book is allowed. Please do not assume that a book's appearance in Google Book Search means it can be used in any manner anywhere in the world. Copyright infringement liability can be quite severe.

About Google Book Search

Google's mission is to organize the world's information and to make it universally accessible and useful. Google Book Search helps readers discover the world's books while helping authors and publishers reach new audiences. You can search through the full text of this book on the web at <http://books.google.com/>

C 447,244



C 447,244

PROPERTY OF

*The
University of
Michigan
Libraries*

1817

ARTES SCIENTIA VERITAS

...is found without
...are available



THE AUTOMOBILE

WEEKLY

NEW YORK, — THURSDAY, JANUARY 7, 1909 — CHICAGO

10 CENTS

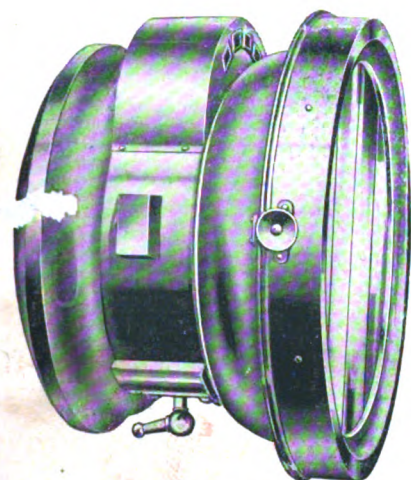

Style No. 98

THE HIGH STANDARD IN LAMPS

ENGINE
TL

Maintained for years
by



Style No. 838

GRAY & DAVIS

seems fully appreciated by the best class of automobile manufacturers of two continents, exhibiting at the Palace, as is attested by their use on the following cars:

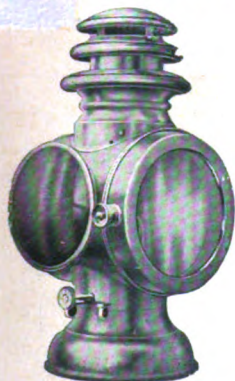

Style No. 917

NEW YORK CITY
377 West Broadway

Foreign
Lancia
Isotta
C. G. V.
Del A Hays

American
Welch
Premier
Mora
Jackson
Speedwell

Foreign
Renault
Hotchkiss
De Dion



Style No. 934

BOSTON, MASS.
749 Boylston Street

GRAY & DAVIS

Main Office and Factory
AMESBURY, MASS.

STROMBERG

SIMPLY A PERFECT
CARBURETER

THE
STAR EXHIBIT
AT ALL THE SHOWS



**TRY
ONE
AT
OUR EXPENSE**

Circular No. 1 illustrates, explains and proves ALL WE CLAIM for it. Ask and receive.

STROMBERG MOTOR DEVICES COMPANY

Main Office and Factory, 1253-1255 Michigan Ave., CHICAGO

EASTERN BRANCH—N. Y. C., 241-2 Thoroughfare Building, B'way and 58th Street, C. S. Gibson, Mgr.
NEW ENGLAND BRANCH—Boston, Massachusetts, 319 Columbus Avenue, E. H. Gross, Mgr.
WESTERN BRANCH—San Francisco, California, 426-8 Van Ness Avenue, Wm. R. Johnson, Mgr.

"SPECIAL"



"OFFSET"

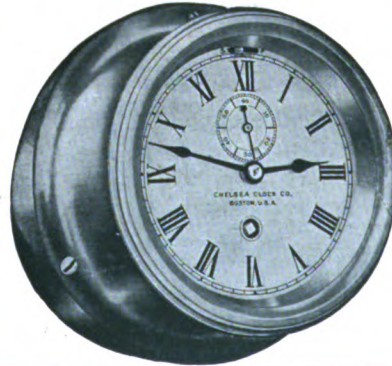

"ROUND"



The justly
CELEBRATED
8-Day, High-Grade

"CHELSEA" AUTO CLOCK
(Trade Mark)

Clocks built with a view to stand the jars and jolts and rough riding of Automobiles. Reputation the highest. Used by parties demanding the BEST.

ALL SIZES STATED ARE THE APPROXIMATE DIAMETERS OF THE DIALS.
All are 8-day High-Grade. All are in DUPLEX (patent applied for) polished cast brass cases, the most thoroughly water-proof case on the market. The "SPECIAL" clocks show dial on an angle; its inner cased clock when removed from outer (locked) case is excellent for use on mantels, bureaus, etc., when touring; its outer case is screwed to dashboard by hidden screws. The "SPECIAL" clocks are in large demand from dealers for owners of finest cars.

The MOTOR CLOCK has the same clock movement which for years we have supplied for the hard use on Locomotives, Steam Fire Engines, etc.; its dial is of same appearance as the AUTO Clock dial, but the Auto Clock movement has a somewhat finer train.

The 3 1-2 MOTOR "OFFSET" is likely to prove a quick, ready seller. Very attractive.

PRICE LIST

Size	"Round"	"Offset"	"Special"	"Limousine"
2 3-4-inch Auto Clock	\$26.00	\$28.00	\$36.00	\$28.50
3 1-2-inch Auto Clock	28.00	30.00	45.00	
3 1-2-inch Motor Clock	24.00	26.00	41.00	

"Chelsea" CHELSEA CLOCK CO., 16 State St., BOSTON, U.S.A. Ask for the "CHELSEA"

Largest makers in America of exclusively 8-Day—High-Grade Clocks—Mantel, Marine, Office, Ship's Bell Clocks, Auto Clocks, etc.

"LIMOUSINE"



Primarily intended for use inside the bodies of large enclosed cars, and for such use its case can be given a variety of fine finishes. It also makes an attractive clock for use on dashboards. Only made in 2 3-4-inch size.

THE AUTOMOBILE

PALACE EXHIBITION SUPPLIES EVIDENCE IN PLENTY

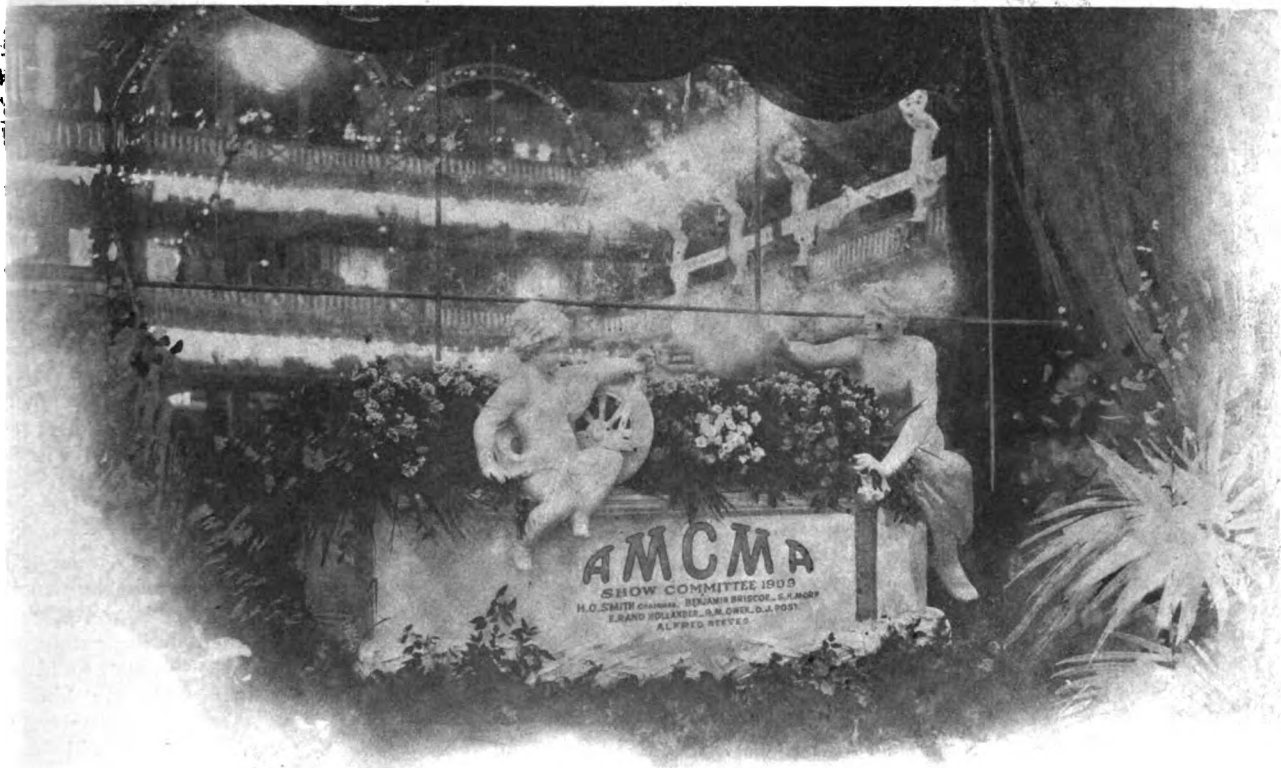

It is a great automobile show that to-night closes in the Grand Central Palace, where it has continued for the past week most successfully under the management of the American Motor Car Manufacturers' Association, with the Motor & Accessory Manufacturers occupying innumerable spaces and the members of the Importers' Automobile Salon contributing the international feature of the exhibition.

In a building which is not suited to the needs of an automobile show, the handicaps of the Palace have been adequately overcome, due to the energy of a competent show committee guided by the managing hand of an energetic director in the person of one Alfred Reeves, who steps into the limelight as an exhibition manager second to none.

Furthermore, it is apparent that people nowadays attend automobile shows because they are interested in automobiles and not through any sentimental regard for any club or organization of which they may be members. 'Tis now a business proposition pure and simple, and the man who goes to look at the cars does so because the cars are there and he wants to see them. At the same time all credit is due to an organization like the Automobile Club of America for its pioneer endeavors in the show line and other fields of activity. Its care of the "infant industry" was timely and deserving of the results obtained, but this prodigy quickly learned to work and soon emerged from its swaddling clothes. Now it's capable and desirous of running its own race, and that's what it is doing, and the evidence of it is supplied in the huge success of the Palace exhibition.

Of course, "Society" does attend automobile shows as before, but the greater number of automobile buyers now come from the middle classes who utilize automobiles from the standpoints of necessity and pleasure, for it is a pleasurable necessity that the average man of some means does not care to do without in these quick-moving days. Quick individual transport was something that mankind had needed for many a day, and the automobile naturally came into its own as soon as it demonstrated reliability and flexibility with economical habits, which were not, unfortunately, apparent in the beginning.

The amount of education supplied by an automobile exhibition, especially in the metropolis of a country, should be commensurate with the undoubted heavy expense for several years to come, even though the Frenchman, who once occupied the center of the stage, wants to discontinue his elaborate show function—providing the Britisher, who is doing quite well, thank you, agrees to follow suit, which he won't do so long as he is ahead in the homestretch. There is such a thing as false economy and

was "Society Day," but, unfortunately, the rain came down more or less in torrents the greater part of the afternoon and evening. 'Tis doubtful if "Society" will have any more special days at Palace shows, possibly because they object to being placed on parade, as it were, though 'tis suspected that there are those who enjoy this to the fullest extent. For the seven days some 75,000 must have paid their way into the Palace.

It is always a question strewed with difficulty to attempt a forecast of the actual returns in immediate dollars due to an exhibition of automobiles and accessories. On the other hand, mere curiosity would not coax an audience to any such place on an amusement basis, day after day. The Palace has been attended by prosperous looking autoists to an extent which makes for great discomfiture nearly all the time, from the opening of the doors to the closing at night, day after day; they talk automobile, discuss the points of merit, and act as if they appreciate the situation in all its phases.

In the meantime there is no doubt of the fact that methods are undergoing change on a basis that can be regarded as even fundamental. Take for illustration the question of accessories: the exhibition is largely one of the makers of these necessities, and that they are doing more of a wholesale business at the show than was the case formerly is assured. On the other hand, it is not assured that the retail business at the show is increasing at the same rate. There is nothing in this to be commented upon, unless favorably, since if the makers of accessories can bring their samples to some center mart of trade, and there meet all their customers, the end will be a reduction in the cost of disposing of goods, which as a rule foots up to a pretty penny.

Should the retailer ultimately find it unprofitable to go to the show with his wares, he will be benefited to the extent that customers will come to his place of business and save him the cost of the especial display. In this way, customers will be able to look at the samples at the ex-

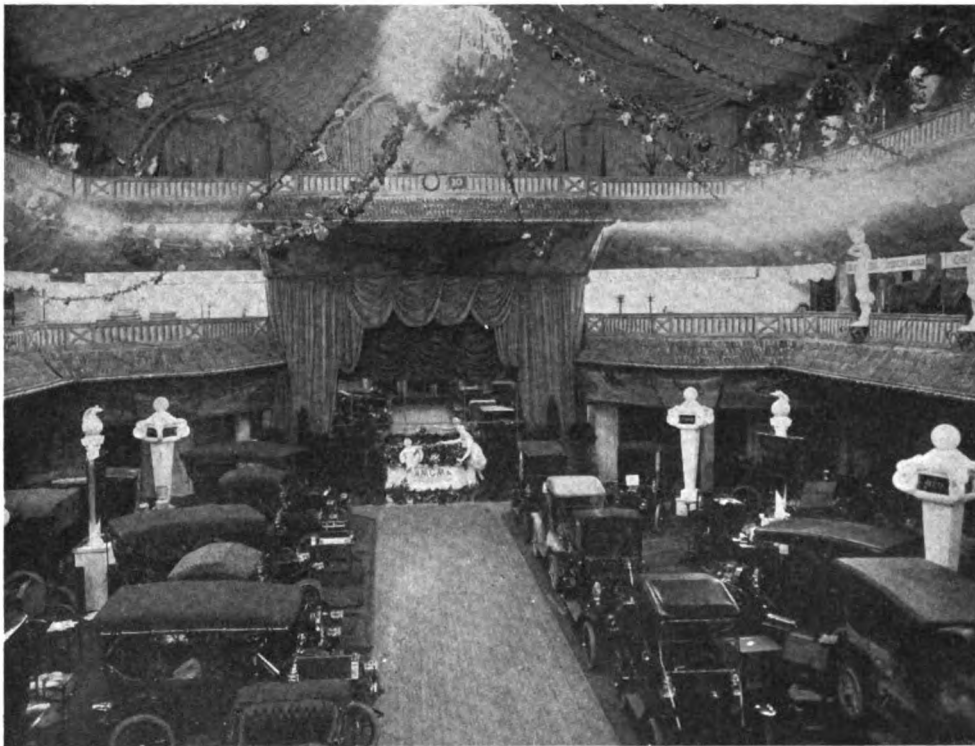

Looking Down the Main Aisle of the Central Exhibition Hall.

giving the public an erroneous idea, which might be detrimental to the continued and increased prosperity of the industry. Added to the desire to discontinue shows, or make them every other year, the Frenchman has decided upon the conclusion of high speed racing, in which direction the American has been an eleventh hour preparer, with the inevitable consequences of defeat when pitted against a rival that was invariably at the starting line long before the firing of the gun.

American progressiveness is the keynote of the Palace show, and even though compared with the best of the foreign makers, the home product holds its own and bids for patronage without any request of special favor for lesser price.

The attendance at the Palace, according to carefully prepared figures by the management, would make it certain that it will close with the best record of any previous American exhibition, and this means that thousands of people have carefully inspected automobiles for the first time, and many of them either have or will own motor-driven vehicles in the near future.

It would appear that the show is still an excellent asset for the industry in this country, for the interest of the public is always a good thermometer by which to reckon. For instance, Monday the figures showed over 15,000 attendance. Tuesday

inhibition, and get a line upon the improvements wrought; the retailer will have the advantage of being able to select from the several available sources the goods that, in his judgment, will find a ready market. Besides, it will be more easy to determine the likes and avoid the dislikes of the ultimate buyers.

The medium-priced automobiles, judging from show indications, are finding ready buyers on an extended scale, and this is a sign that means far more than the mere statement implies. In ordinary times it is a well-known fact that the prospectives go to the show to look. They decide on the circle of cars that they will give more detailed attention later on. The actual placing of orders is a matter that they extend into the future, and the exhibitors formerly regarded this state of affairs as equal to orders.

This year's automobiles were heralded as of great money value, months before the show opened, and in some measure sales were depressed in consequence; autoists having decided to await the show and take their pick of the best the market affords. They are now taking their pick, and the volume of trade is large, with perceptible haste in the buying, due in no small measure to the fact that there is a threatened famine of automobiles of the class in greatest demand.

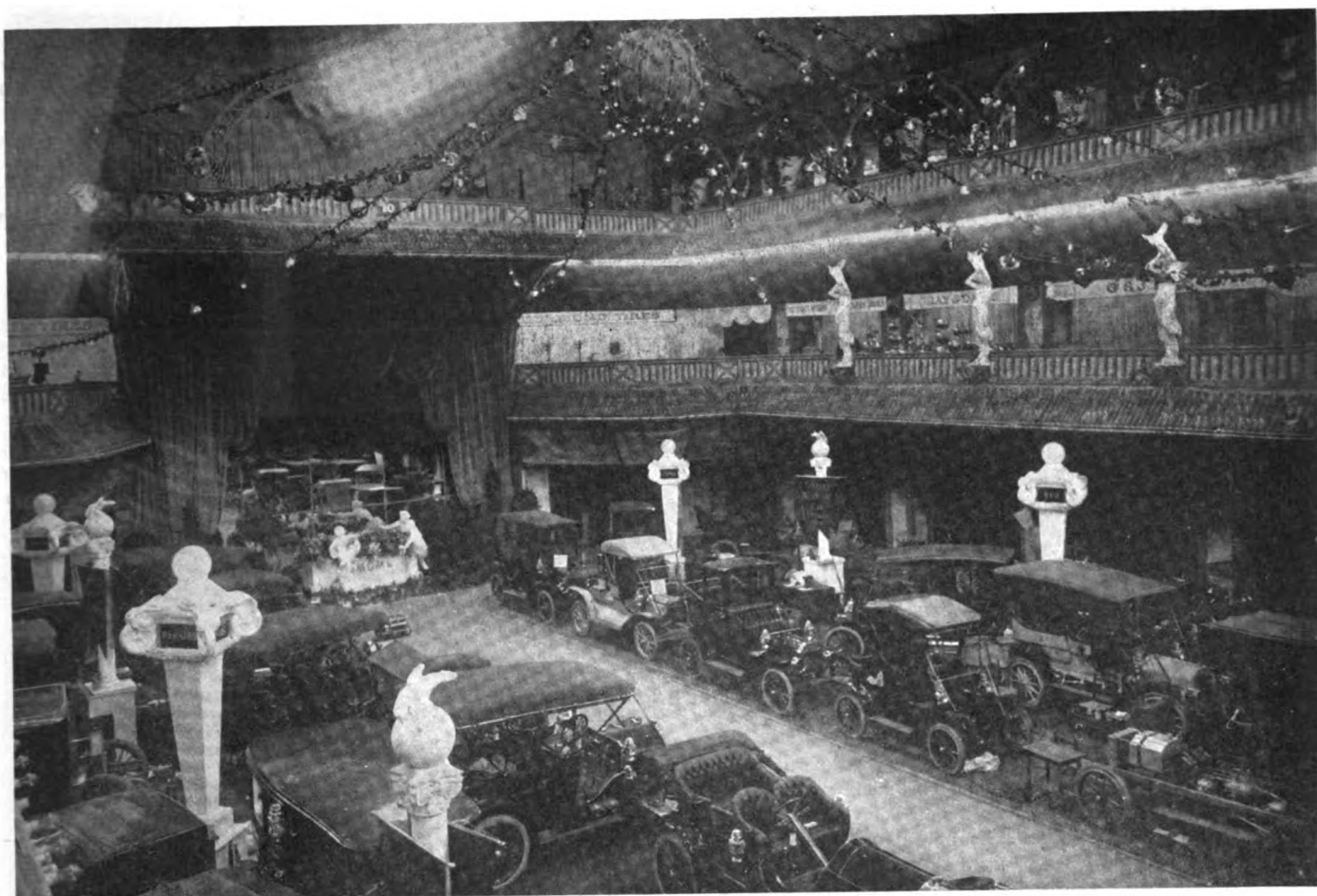

Looking Northwest from the East Gallery, Where the General View of Exhibits Can Be Seen to Fine Advantage.

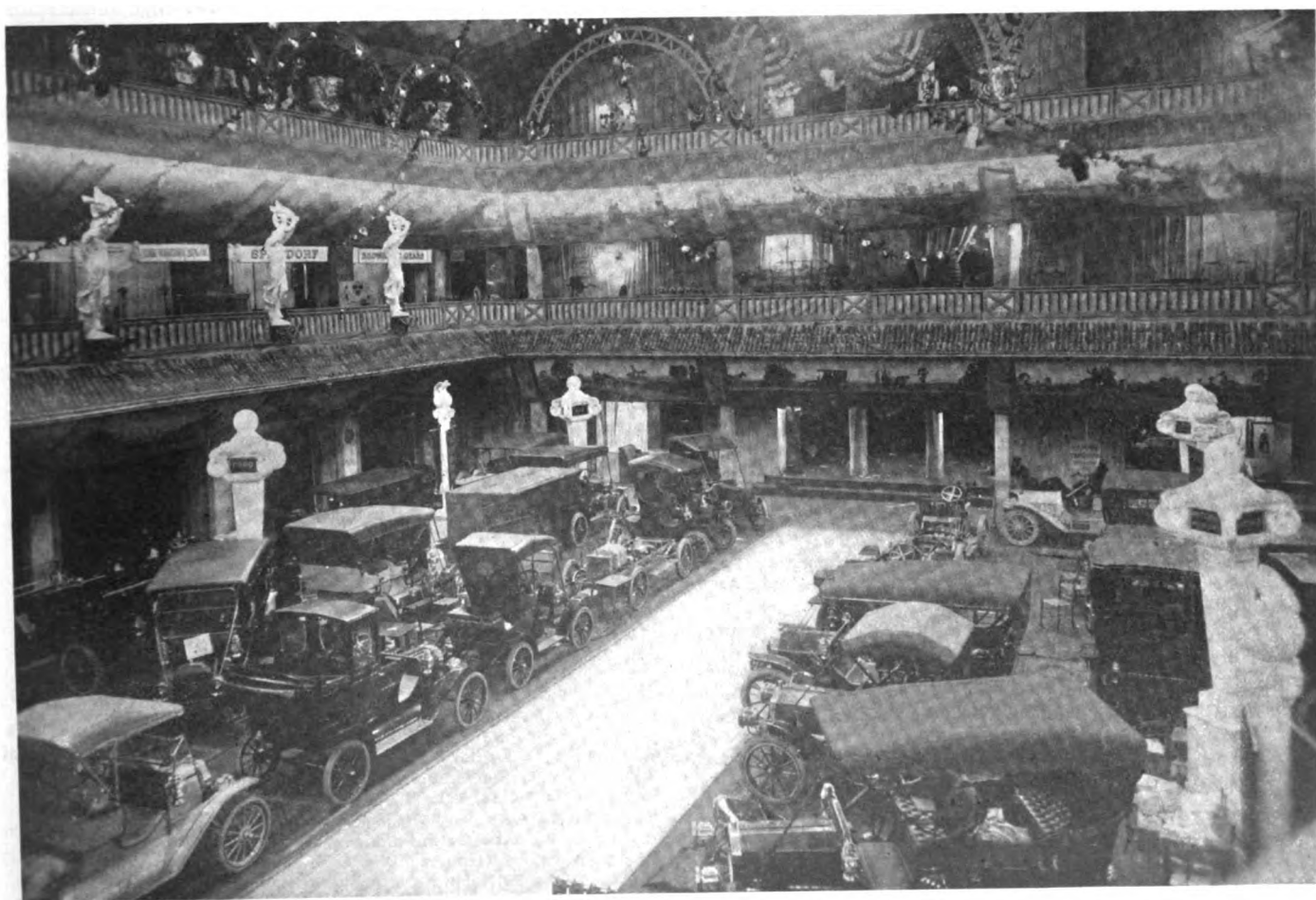

From the West Gallery, Looking Toward the Main Entrance, the Setting is in Good Taste and Picturesque.



Of the higher priced cars there is less of uncertainty than formerly, due to the lack of any great influence on the situation at the behest of the makers of foreign automobiles. The foreign makers can scarcely create a ripple on what seems to be a very placid situation.

There are examples of the best types of American cars at the show that "shine" alongside of any product from any land, and it is fortunate for the industry that the buyers of this class of cars know it. This situation is not actually new, but the patrons of the industry were a little slow in their appreciation of the fact. In other words, last year's cars were every whit as good as any product in all ways. This year the situation is even better in view of the fact that the American cars are with superior materials and it is not at all certain that the "foreigners" can hold to quality and lower the price as well. One thing is dead sure, they are not here for their health, and they will not hand out two dollars of material for less than two dollars.

The old skepticism is below the surface, if it exists at all. Dealing is on a far more pleasant basis, and the public is not so hungry for "ghost stories." Formerly it was claimed that to sell a car it was necessary to "invent" improvements, and some went so far as to talk about things that did not exist excepting in the imagination of the salesman (?). In a word, the public has improved in its understanding of what an automobile really

is and do not ask questions to which there is no answer. The makers of cars have taken cognizance of the better tone, and they are probably glad that the old "stringing" game is gone. To entirely eliminate this sad state of affairs, it has been necessary to provide salesmen of integrity, rather than "drummers."

Of the visitors at the show it would be impossible to state just how many carriage makers mingle with the rest. It is assured, however, that they are there in "droves." That many of them propose to "slide" into the automobile business is now assured, and it is up to them to settle upon the phase of the situation most likely to gibe with their facilities, assuming there is a market for the product. The buggy type of automobile is, to them, a great attraction, and they are endeavoring to ascertain the attitude of the public.

Of course, New York is not the greatest center of the users of buggy types of cars, but it is a fact, even so, that the demand for the buggy type is brisk, and the buyers come from Pennsylvania, "up state," and all the way from Portland, Me., and to the North. Last year, when sales were as scarce as "chicken's teeth," makers of buggy types of automobiles sold out at the New York show. This was one of the surprises of the year, and it is in a fair way to repeat. It is not to be wondered at then, if the carriage makers come to the Palace to feel the pulse of the public.

THE AUTOMOBILE CALENDAR.

- | | | | |
|------------------|--|------------------|---|
| Jan. 16-23..... | New York City, Madison Square Garden, Ninth Annual National Show of the Association of Licensed Automobile Manufacturers. M. L. Downs, Secretary, 7 West 42d St., New York City. | Feb. 16-18..... | Denver, Col., Auditorium, First Annual Automobile Show, Denver Motor Club. |
| Jan. 19..... | Adjourned Fourth Annual Meeting, Society of Automobile Engineers. | Feb. 18-25..... | Toronto, St. Lawrence Arena, Third Annual National Automobile, Motor Boat and Sportsmen's Exhibition. Ontario Motor League. R. M. Jaffray, Manager. |
| Jan. 27-Feb. 3.. | Philadelphia, Second Regiment Armory, Eighth Annual Show, Philadelphia Automobile Trade Association. | Feb. 20-27..... | Newark, N. J., Essex Troop Armory, Roseville Avenue. Second Annual Show New Jersey Automobile Trade Association. H. A. Bonnell, Manager. |
| Feb. 6-13..... | Chicago Coliseum and First Regiment Armory, Eighth Annual National Exhibition, National Association of Automobile Manufacturers. S. A. Miles, Manager, 7 East 42d St., New York. | Feb. 20-27..... | Hartford, Conn. Second Annual Show Hartford Automobile Dealers' Association. |
| Feb. 15-20..... | St. Louis, New Coliseum Building, Third Annual Show, St. Louis Automobile Manufacturers' and Dealers' Association. John J. Behan, Chairman. | Feb. 24-27..... | Omaha, Fourth Annual Automobile Show, Omaha Automobile Show Association, C. N. Powell, Secretary. |
| Feb. 15-20..... | Detroit, Wayne Pavilion, Annual Show, Detroit Automobile Dealers' Association. E. LeRoy Pelletier, Manager. | Mar. 1-6..... | Buffalo, Convention Hall, Annual Show, Automobile Club of Buffalo. D. H. Lewis, Secretary. |
| Feb. 15-20..... | Cleveland, First Regiment Armory, Annual Show, Cleveland Automobile Dealers' Company. | Mar. 6-13..... | Boston, Mechanics Building, Seventh Annual Automobile Show, Boston Automobile Dealers' Association. C. I. Campbell, Manager, 5 Park Square. |
| | | Mar. 8-13..... | Kansas City, Kansas City Automobile Dealers' Association Show. |
| | | Mar. 27-Apr. 3.. | Pittsburg, Duquesne Garden, Automobile Show, Pittsburg Automobile Dealers' Association. |

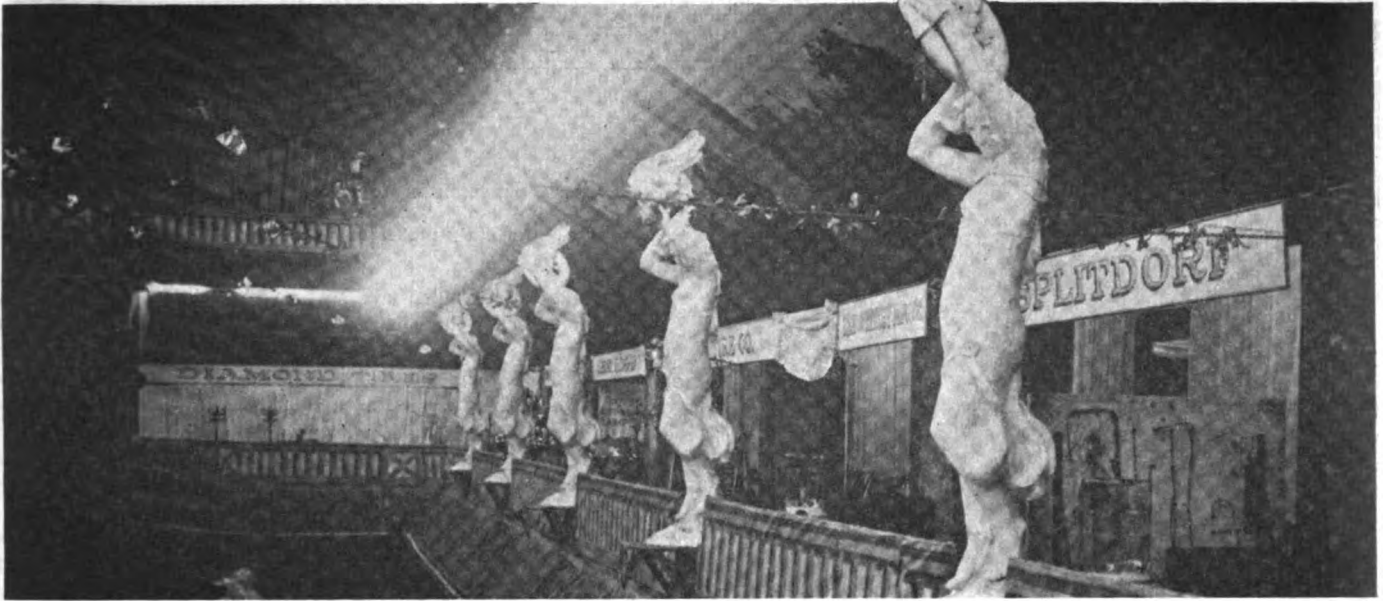

LEVEL ON WHICH MERIT STANDS IS CONGESTED

By THOS. J. FAY.

FIRST approximations always have to be reviewed if it is desired to get at the bare facts; nor does it matter what the problem is when it comes down to a cold and critical review. The earlier review of the automobiles at the show was naturally the immature reflections which indicated what might well be termed "a lick and a promise," excepting that the tabulations were made with care, using the best information possible to procure.

The fear was that the first approximation, so called, might hold in its makeup that class of fallacies which generally does follow when one is a little charitable. As it is, in the light of further knowledge, gained by a close examination of the cars at the show, proof of a lack of sufficient knowledge of the real advance looms up like ghosts that do beset a stricken conscience. If it is not too late to revise the first impressions, in some particulars at any rate, it will be to do scant justice to the situation.

In former shows it was generally the case that here and there a fine example of the best types of cars could be seen if one were practiced in the art of "shopping"; a practice which is said to make one proficient when it comes to wading through a vast assemblage. On this occasion instead of the isolated cases of fine cars, it is to note but few of the class to be styled "below standard." But some joker stole the old standard, and in the replacing of it a better one was substituted; so much better, in fact, that the wonder is that any of the cars came quite up to it. In any attempt, then, to classify any of the cars as "below standard," it must be in the light of the fact that the standard was reconstructed on a basis which is a stranger to the autoist of a year ago.

Thus, to proceed and not to amplify the statements in a manner sufficient to exclude extravagance would be a waste of time. If the automobiles at the show are so much better than they were last year, in what way, how? It will not be possible to take each automobile at the show and tell of the ways in which each car stands out.

Materials as they are used in automobiles are from certain sources, and the first question is, are the materials to be had better than they were? If it can be shown that the materials are superior, then it will be possible to consider that the cars may reflect this condition.

Even if the materials have moved up it will be possible to have variations in design, and then it will be possible to consider

that some of the designs may not be so good as the others on the ground that all the designers are not of the same competence. Let us take a second look at this phase of the situation and see if it, too, has not a loophole in it. The lowest priced cars at the show are the ones that might be regarded as likely to hold undesirable features in their makeup. This is a fair assumption. But is it borne out by the facts? If the low-priced cars take advantage of the facilities of the "parts makers," of which there are several who have made a name in the trade, how can the cars be any worse than the parts of which they are composed? Is it not merely a case of the low price because the parts are turned out in vast quantities by men who have all kinds of experience in the respective lines which go to make the cars when the parts are assembled?

Let it not be supposed that the writer is advocating either low-priced cars or parts makers. The cars are at the show and the idea is to tell about them as they are. To sing a song of quality and not show the way in which it can be arrived at is to go it blind. The point to be made is this: The finest cars at the show are so self-evidently fine that the mere statement of fact is all that is necessary. The cars that do not show on the surface the qualities which reside in them are the cars, then, that must be laid bare to the eyes which will have to pay the bill in the long run.

Any purchaser of sense enough to roll off a log can tell at a glance the cars which are being carried along in the vortex of a great industry, and it will be impossible to discover any reason why a review of the industry should specifically pick out "black sheep," if such there are. On the other hand, it is far from right to assume that a car will always be faulty merely because on some occasion the designer made a slip. The sum and substance of the whole thing must be along lines taking into account the general trend. Is the general trend on the same level as last year, or did the art keep pace with time?

This is the question which has to be answered, rather than to say that every detail of every car in the show is up to a standard such as would please some overfastidious individual. And, again, the point of view must be taken into account. It would be perfectly foolish to assume, even for a moment, that a buggy type of automobile can serve as the equivalent of a standard touring car. On the other hand, the touring car cannot do the work that might be fairly expected of a buggy type. By this

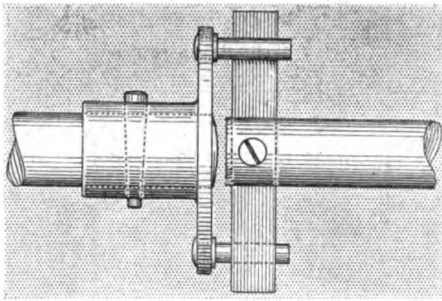

Fig. 1—A modern universal joint for pumps.

process of reasoning it is fair to conclude that the cars at the show have their respective tasks to perform, and the only question is, how well will they do it?

Every purchaser must decide for himself the kind of a car he may

want, in view of the work to be done, and purchasers can be mistaken about it. A mistake in the selection of a car for a given task would in no way affect the quality of the car, although it might add evidence by way of indicating more conclusively the fact that the car as selected would render more satisfactory service in some other zone of activity. In other words, the quality of a car will be, (a) in the abstract, (b) for a given task to be performed. If a purchaser buys a car for a given purpose, and the car is not suited to the work, it is the purchaser's mistake and he will have to be content to charge the expense to profit and loss, mostly loss, and he will be in great good luck if it does not prove to be a dead loss.

It seems to be necessary to thus explain the influence of selection upon the question in order not to give the impression that this review is not by way of kind words. Of course, there is nothing in being too critical, especially since there is ample room for an honest difference of opinion in not a few cases. With this understanding it will be possible to put proper weight on

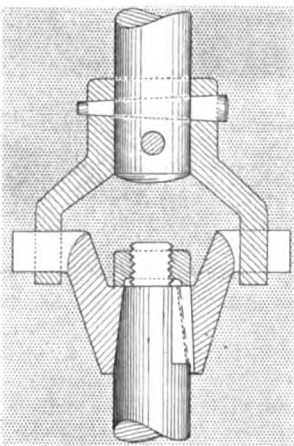

Fig. 2—Rather formidable magneto drive.

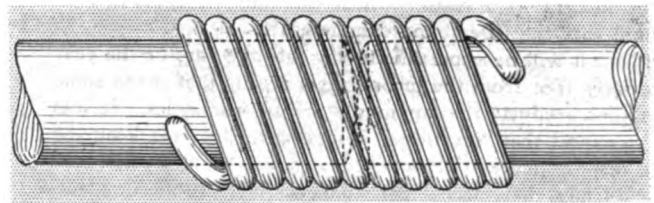

Fig. 5—An early makeshift that finds few advocates.

inferior materials would have to be obtained as "special" at a higher price. That there is plenty of room for improvement is a settled matter, but that the cars are abreast of the times is equally assured. If the Chinese invented the telephone five centuries ago, they were too early, since it was not possible to put them to commercial use until the world moved up to a "hot-foot" pace. In the same way it will be proper to await the time when the world will stand for more improvements in the automobile than are now in evidence.

As respects design features, there are a few things to say which will clear the atmosphere a little, and for the purpose of rendering the text a little more clear, it is proposed to illustrate the points. Fig. 1 shows a universal "safety" joint such as is used on cars of the superior design not to the exclusion of other and equally good methods. As will be observed, this joint is so made that if a pump is "froze up," the flat spring will snap around and the operator will be warned. The shaft will not be twisted off, because the spring is weaker than the shaft.

From this to Fig 2 is a long way in the wrong direction, and the designer who substituted a casting for the spring must have had water on the brain. This would not be so much of a crime were it not for the fact that the method was reported in a "technical paper" as one of the approved methods to use in automobile work.

In the same paper the scheme Fig. 3 was offered as a means to be employed. The screw used to connect the two members might stay in place long enough to go a couple of hundred miles, but it would surely be the first thing in the car to fail. The first thing that is likely to fail in a car is the first thing to eliminate, and, while the matter is up, it may as well be said that the item in the makeup of a car that will last the longest is a little too good for the place if the quality that goes to make it everlasting is at any extra cost.

Fig. 4 is another idea that does not seem to be in the cars at the show, although it is recommended by some of the sharps of the technical press. In this cut it will be noticed that one of the enlargements is held in place with a taper pin and the other is integral. Surely this is not on the road to harmony in design that looks and is so good.

Fig. 5 is a makeshift, which is only recommended by the paper sharps; it can scarcely find many advocates on the ground that sooner or later the spring will be cut through by the sharp edges at the ends of the shafts; anyway, it is nothing to pay money for.

Fig. 6 is a very bad imitation of the device as illustrated in Fig. 1, and it is just as well to say many of the better designs have from time to time been badly copied, but it is fair to relate that the cars of the year are more nearly free of such things than they were in former years.

Fig. 7 is another variation of Fig. 4; but it is better, since there is no spring to cause thrust. Why one of the enlargements

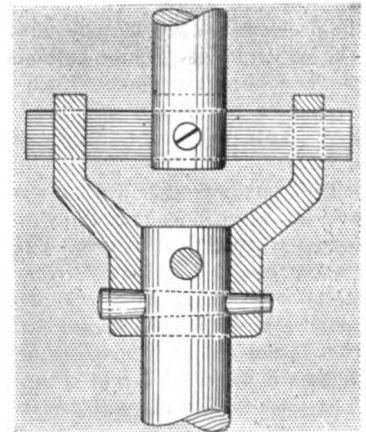

Fig. 6—Safety water pump drive.

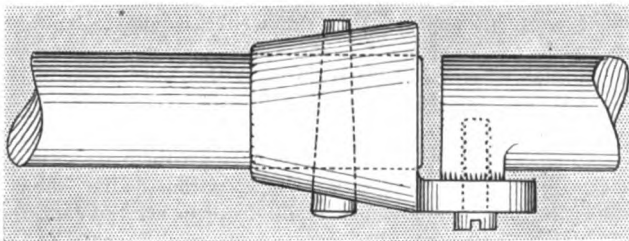

Fig. 3—Exit. A typical flimsy scheme of the past.

the statements and inferences with small chance of going wrong in the main.

All along the line the question is one in which it is almost impossible for a man to actually procure distinctly inferior products, simply because the standard has moved up, and the

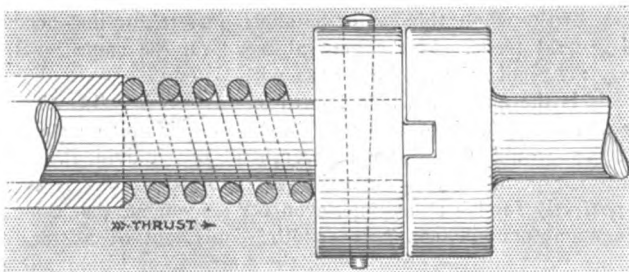

Fig. 4—It is no longer to be recommended.

should be integral is a matter which can only be explained on the ground that the assembling demanded it.

Right here it will be opportune to say that the cars of the year are singularly free from the incongruous details that made some of the earlier products the laughing stock of mechanics. It was natural to expect that "inventors" would leave their mark on the cars and that the mark itself would be by way of ideas, however good, in settings that mechanical engineers less prolific in ideas, but more skilled, would have to erase or revise.

There has been a goodly lot of this erasing, and of revising, so much so that any attempt at reiteration would be an impossible task. The old bicycle days are gone, the impossibles of the taper pin are too well known to be imposed upon buyers of cars, and good, sound mechanical work is having its day. Weight is eliminated in so far as this phenomenon is a detriment, and it is now known that a certain amount of weight is as necessary as the gasoline or the crankshaft. Of course it is possible to foresee a day when the gasoline will give out, and that the crankshaft will be eliminated in time—maybe a long time—to make way for the "gas turbine." When the day of no gasoline arrives it is certain that something better will be at hand to take its place. As to the turbine, it is of the future, with no chance of influencing the automobiles as they obtain at the present time.

There is one more point that is good to relate, i.e., while the body work of the present is high in the scale of quality, it is a fact that fine body work does not now throw dust in the eyes of buyers, as was the case in the early days. When some of the cars could not be sold because they did not grow a reputa-

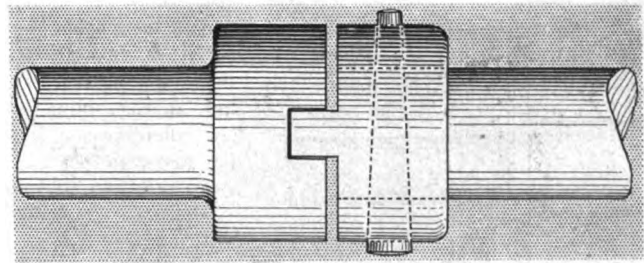

Fig. 7—One of the early types of joint.

tion on the merit of the chassis, it was formerly easy enough to hide the machinery under a fine body and sell the whole. As it is, while the patrons want good bodies, they also want good machinery. Fortunately, the makers of cars arrived at the same conclusion at about the same time, and it is a happy state of affairs that enables the patrons to find what they want at the show at the price which fits their inclination, assuming that necessity is not at the bottom of the wish. The fact remains that scant pocketbooks can do very well, especially now that the cost of keeping a car is within the bounds of reason.

If the discussion thus far will serve to indicate more nearly why the claim of superiority is not merely extravagant, it will be possible to mention such of the cars at the show as will fall within the deadline, in so far as the author has been able to give the details of the cars a fair measure of attention in the limited time at his disposal.

SALIENT FEATURES OF THE AMERICAN MAKES

AMERICAN: American Motor Car Company, Indianapolis.—The underslung frame chassis of the American has always made it a car to be known even at a great distance away. The wheels are of greater diameter than is the usual custom, and the car looks long and low, thus giving the appearance of speed, which is also a phenomenon in cars of this make. The "Traveler" type of the American with 40-inch wheels is one of the most distinctive looking cars built, and this line is drawing the sight-seers at the show. The "Traveler" type is equipped with a 50-60-horsepower four-cylinder water-cooled motor, with cylinders 5 3-8 x 5 1-2 inches bore and stroke respectively, and the ignition is by "Bosch" magneto. The wheelbase is 122 inches, and the shaft drive is to a "floating" live rear axle of the best construction. In general the American cars bare the earmarks of the designer with a sharp pencil and a "think-tank" full of good ideas.

AMERICAN-SIMPLEX: Simplex Motor Car Company, Mishawaka, Ind.—This company has made a good success of the two-cycle proposition, and the cars in use are regarded

as up to a fitting standard. The 50-horsepower four-cylinder motor of the line with 5 x 5 cylinders is well liked by those who have given it a trial, and that the power is there is assured. Probably the one feature that will be of the greatest interest is that the flexibility of the motor is remarkable. This fact is worth bringing out because it is not uncommon to hear the four-cycle sharps make the claim that the two-cycle motor lacks in this essential particular. They know all about four-cycle work, and have no time to look into the virtues of the two-cycle motor. Of course, it is a good idea to be proficient in one language, so to speak. The fact does not debar the other methods. As Schley said: "There is glory enough for all."

AUSTIN: Austin Automobile Company, Grand Rapids, Mich.—This company turns out a 45-horsepower car as a runabout, the price of which is \$2,850, and the motor is a vertical six-cylinder, 4 1-2 inches square, with magneto and auxiliary coil and all the accessories which go to make a power plant complete. With a multiple disc clutch, a three-speed selective transmission gearset, and shaft drive, the car takes on

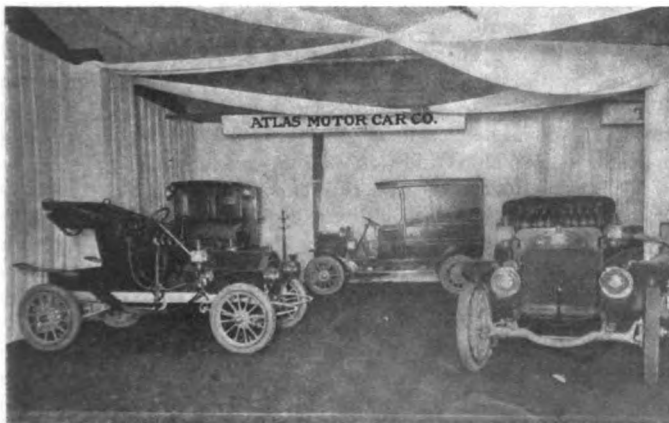

The Atlas Line Looked Substantial and Staple.



A New One Made In New York City—The Benner.

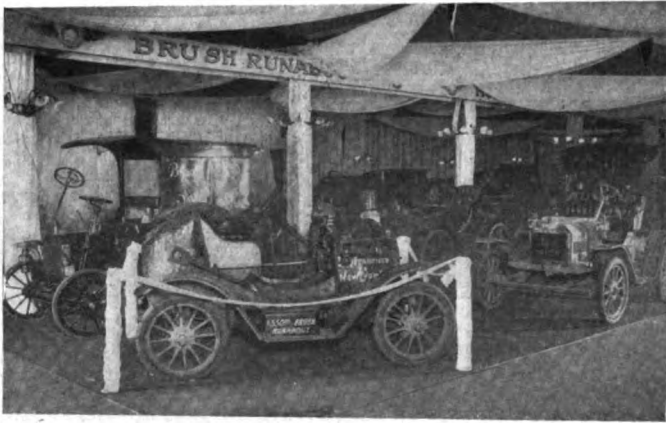

Brush Runabout, that Climbed Pike's Peak, in Foreground.

the characteristics of a splendid proposition and serves as an index to the Austin line of cars the like of which is worth going to the show to look upon, even assuming that the reasonable price asked is in excess of the surplus available in any given case. Of course this car as a runabout is intended as a vehicle to take no man's dust.

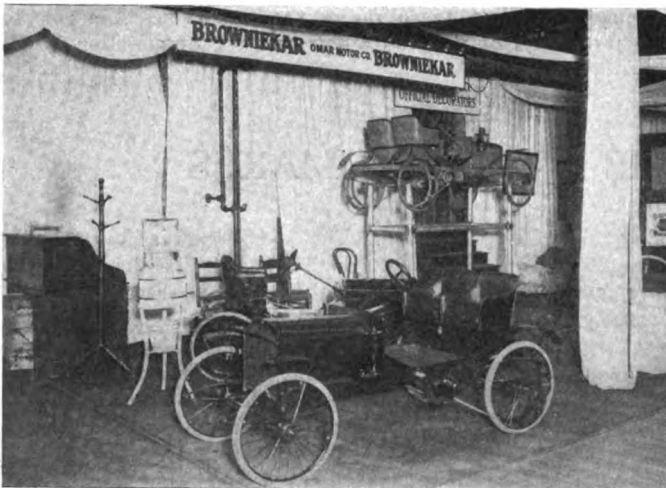

A Little but Active Auto for the Young Generation.

ACME: Acme Motor Car Company, Reading, Pa.—The Acme line is most complete, and a motorist who can not find among the Acme cars one to suit is rather overdoing it. The Acme "thirty" with a four-cylinder motor, cylinders 4 5-8 x 5 inches bore and stroke respectively, is conservatively rated, and in all respects it looks like a car for the man that cannot afford to buy one every year or two.



The Array of Powerful Chadwicks Was Imposing.

ALLEN-KINGSTON: Allen-Kingston Motor Car Company, Kingston, N. Y.—While this company makes two models—one of which is a 17-horsepower touring car and the other of much higher power—48-horsepower—the idea will be to concentrate the present discussion on the 17-horsepower car, which belongs to the more recent types involving "en bloc" cylinders, and it is worthy of note that in the cars of this company's make, "New Departure," two-in-one ball bearings are used, almost to the entire exclusion of plain bearings.

BRUSH: Brush Runabout Company, Detroit.—The model B with a 7-horsepower motor and a runabout body is sold at the low price of \$550, and in the home town (Detroit) there are a large number of these little cars treading their way around in a manner that lends them an air of utility which is rendered most apparent by beholding them. It is claimed that "no man is a prophet at home." This is a way of saying that the folks at home know just how much stock to take in any given proposition. It looks as if the "Brush" is pretty well liked at home, and it is a good sign. As well as the runabout the Brush delivery wagon is taking among merchants of business acumen.

CAMERON: Cameron Car Company, Beverly, Mass.—As the song went, "the Camerons are coming," etc. The song is out of date; the Camerons are here, and air-cooled at that. The four-cylinder runabout sells at \$900, with 3 7-8 by 3 1-2-inch cylinders' bore and stroke respectively. The car is one to attract more than passing notice especially among the friends of the air-cooled proposition, which for that matter is now in a fair way to come into its very own. The motor is equipped with a Remy magneto, and on the whole a healthy ignition system which is half the battle in any automobile. The cone type of clutch is big enough to do the work, and a selective three-speed transmission intervenes a shaft drive. The wheelbase is 96 inches, which is a fine length for a car of the class, and the wheels are fitted with 30 x 3-inch tires, in which is seen a desire to meet the tire situation in a fair manner. There are other Camerons, and the intending purchaser can find the data in "The Automobile."

COATES-GOSHEN: Coates-Goshen Company, Goshen, N. Y.—This company comes to the show for the first time with two chassis models—a 25-horsepower and a 32-horsepower—in which are incorporated a number of special features. The torsion member is a tube which parallels the propeller shaft and is fastened to it at the forward end by a collar. The housing tube terminates in a hollow ball joint within which the double universal centers, thus pivoting the propeller shaft and the torsion tube on a common center. The extensive use of ball and socket joints, ball bearings in transmission, straight-line drive, positive gasoline feed, and standard construction in motor and transmission, all go to complete a design which will attract attention. The cars present a good appearance and the body work is of the most recent class, both in point of design and finish. Beneath the surface, the body work is well executed, and time should not tell so seriously against it.

CHADWICK: Chadwick Engineering Works, Pottstown, Pa.—It was in the Chadwick that one of the important "foreign" companies found the "double bevel gear" that led to the adoption of the "direct on high" idea now so much in vogue. This incident is mentioned to bring out the fact that it is not, as some suppose, a case of going abroad to get ideas. As a matter of fact, the Chadwick set of brains was on the job on that occasion, and even a passing examination of this company's cars will disclose a baker's dozen of nuggets that would adorn any foreign make of car. The Chadwick has never resorted to "house top" methods of crying their wares; indeed, a look at the cars is enough to convince anyone that the company has been in the automobile business for some years.

In the car at the show the Chadwick Company offers to autoists a number of improvements for the first time, improvements that should go a long way towards advancing the automobile as a whole. Take, for illustration, the scheme by means of which the magneto armature is "twirled" in order that the magneto will

"spark" when it is desired to start the motor. With the magneto fitted out in the manner used by the Chadwick it is certainly possible to do with a magneto all that can be done with a coil and a battery during cranking. The Chadwick clutch is by way of an expanding band, the mechanism of which is very ingenious, in which a rack and pinion do the work, and do it well.

The transmission is semi-progressive, which is intended to give all the advantages of both the selective and the progressive systems, eliminating all chance of mistake on the one hand and reducing space and weight on the other. The side chains are in boots and the differential brakes look like practice boiled down. The cardan shaft is terminated in flexible ball joints, which have the facility of affording the requisite flexibility, and at the same time it is possible to disassemble the whole in the shortest time without moving the motor or the gearset. The chassis frame is reinforced at the narrowing point back of the motor and is made of chrome nickel steel. The crankshaft and the gears are also of this same material; indeed, the Chadwick situation throughout is on a basis using the finest materials for the purpose.

CARTERCAR: Motorcar Company, Pontiac, Mich.—The 18-20-horsepower runabout of this make is one to attract more than a little attention, the price of which is \$1,000, and in many respects the car is a revelation.

CRAWFORD: Crawford Automobile Company, Hagerstown, Md.—Hagerstown was always more or less addicted to the habit of supporting an industrial contingent, and it is even fair to say that this habit is stronger in Hagerstown than in most of the centers on the border of or below Mason and Dixon line. The Crawford seems to be a good representative of what can be done down there.

DE LUXE: De Luxe Motor Car Company, Detroit.—A \$5,000 automobile, and, as the name implies, it is in the class of the highest type of designed automobiles. Nor is the company content to be merely in the class. As a matter of fact, it is a case of design all over, using modern methods, inventing when methods of quality are not to be had, while the materials used are the best that money can buy, with a fine sense of discrimination when it comes to the placing of the materials. The 50-60-horsepower De Luxe model is a car such as will attract notice in any company.

FORD: Ford Motor Company, Detroit.—Henry Ford made a name for himself which will cling for all time when he handed out a replica of a full-fledged automobile of the four-cylinder type at the price of a runabout—nay, at the price of the cheapest runabouts. Model T of the Ford line is in the same class, in that it is all automobile and no price. The Ford process ends in the delivery of nearly a hundred automobiles every working day, and, in spite of the low price, the quality of the cars and the enormity of the undertaking, it is generally conceded that Ford makes money.

GAETH: Gaeth Automobile Company, Cleveland.—Paul Gaeth is surely an automobile engineer. He may try to crawl out of it as Edison once tried to say he was not an electrical engineer, but the monument is there, and all who read may know. The Gaeth line differs from cars as they may be regarded in general, in that the problems are solved in a manner such as leaves the footprints of genius all over them. Gaeth does not set up the claim that his is the only way under the sun, but the users of Gaeth cars say it is a mighty good way, and that is more to the point. The cars of this make were written up in "The Automobile" a few weeks ago, and more than a little attention was called to the fact that the ignition, for illustration, was an ingenious piece of work. The "close coupled" is a neat automobile, with a 38-horsepower motor, four cylinders, 4 7-8 x 5 1-4 inches bore and stroke respectively. The ignition includes a magneto; the water cooling is of the thermo-syphon system, and the transmission is progressive with three speeds and a shaft-drive. The Gaeth line includes a delivery wagon, which makes for success.

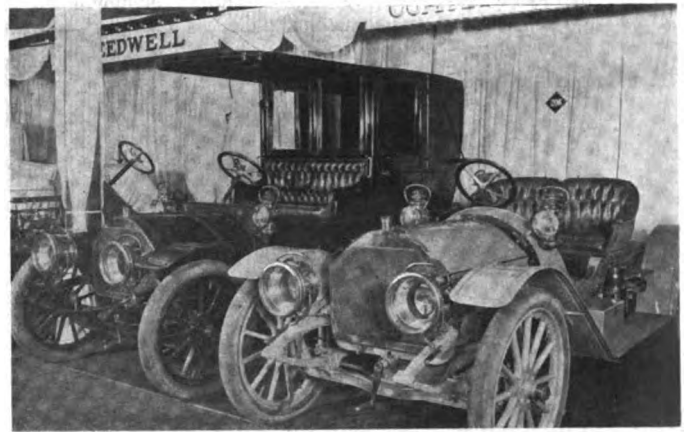

Another Newcomer—the Coates-Goshen, from Goshen, N. Y.

GYROSCOPE: Gyroscope Automobile Company, New York City.—Made by the Bloomstrom Mfg. Company, this product has secured quite a name for itself and is attracting its share of attention at the show. The speed changes are made by the transverse travel of a disc wheel across the face of the fly-wheel, and the increments of speed change are, therefore, as

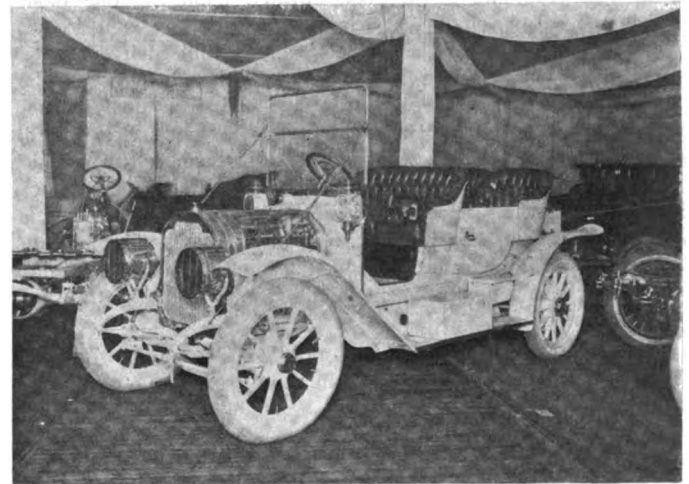

The De Luxe Company Showed a Fine Model in White.

numerous as the increments of travel. The two-cylinder opposed motor is so disposed as to allow of this mode of procedure. In many respects this scheme is of great merit.

INTER-STATE: Inter-State Automobile Company, Muncie, Ind.—In any other business the older the company the more chance there would seem for commercial success. The automobile situation is different because there are not enough

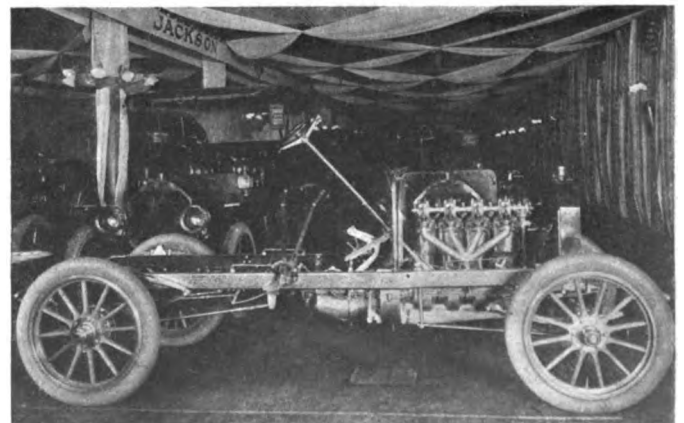

Jacksons Were Shown in Profusion and Advantageously.



A Western Line of Good Ones that is Popular.

cars made to go around and if a company will make a point of building good cars, it will have little trouble in the act of getting rid of them. The Inter-State is a new car, but the designers seem to know what is expected and to produce just the kind of an automobile that is wanted by the patrons of the industry. The company very wisely refrained from endeavoring to put out a line of cars and having concentrated upon the one model it has the earmarks of that careful attention to detail so necessary to the success of a new company, if indeed it is not the secret of success in any case. The motor is a 4 1-4 x 5 inches bore and stroke respectively with four cylinders, dual ignition, and positive water circulation, as will be more clearly indicated by consulting "The Automobile" of December 31, in which tables of the data of cars were afforded. In divers ways the car is distinctive. The selective transmission is carried on the front end of the tubular housing of the propeller shaft. The motor is self-contained, and separated from the multiple disc clutch, since the clutch is in a compartment in the front end of the transmission gear set.

JACKSON: Jackson Automobile Company, Jackson, Mich.—Michigan seems to be the home of many makers of automobiles, and among them will be found the Jackson, which is neither last nor least. The model H "thirty" is drawing well, and it promises to be a popular Jackson model with the buying public as well. Some cars take with the public at large, and then there are the cars that are popular with hair-splitting experts, but Model H has decided to choose the "buying public" as its associates. Seems to be a good idea.

KISSELKAR: Kissel Motor Car Company, Hartford, Wis.—The Northwest is a favorable country in which to manufacture automobiles, because it is full of the finest mechanics, and materials are there in profusion. It is no wonder then that the KisselKar is well up to the mark. The price is low, due to the favorable circumstances attending its construction, and the company is well equipped to handle its vastly expanding

trade. The new model "thirty" is something to take a look at, and the company has a "six" rated at 60 horsepower, using both the magneto and the Atwater-Kent system of ignition besides a lot of other equally good improvements.

LAMBERT: Buckeye Manufacturing Company, Anderson, Ind.—Originators of friction drives of the kind that have delivered satisfaction to users, the Lambert adheres to that method, which is a good indication of the practicability of the scheme, since to change would be a simple choice were the company so inclined. The line has expanded, and in numerous respects refinements have kept pace with time. Morse silent chains are used and with Rutenber motors, in conjunction with the Lambert friction drive, the line is in a way to prosper. Hyatt roller bearings are used wherever the responsibility demands anti-friction members. The new "thirty" is looked upon with favor.

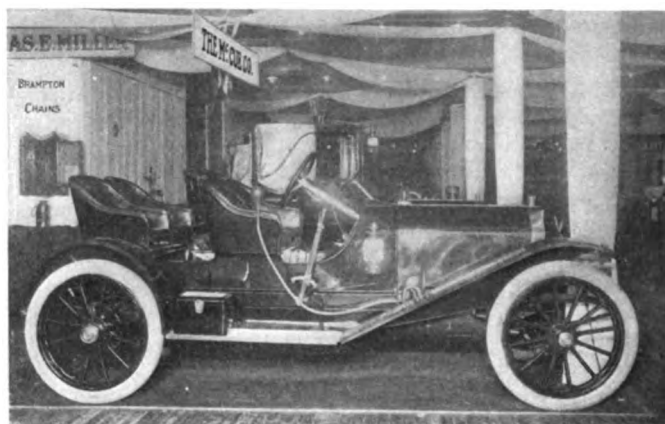

The McCue Company's Exhibit—A New Connecticut Car.



Fine Taxies and Other Cars from the Hoosier Capital.

LANE: Lane Motor Vehicle Company, Poughkeepsie, N. Y.—The Lane has the distinction of being the "steamer" in the show. It is a pretty good illustration along steamer lines, and one would judge that the steamer contingent is wideawake from the many who take a keen interest in the Lane, which is developed to a high state of perfection.

McCUE: McCue Company, Hartford, Conn.—The cars of this make are new to the visitors at shows, but the principles of the McCue are those of the accepted practices of recent years. In other words, the McCue is an up-to-date car with a four-cylinder 30-horsepower motor, selective three-speed transmission, cone clutch, and shaft drive. The car looks like a decidedly good piece of work, and there is no reason why the McCue should fail to entertain its audience. As a matter of fact, few go by the car without giving it the benefit of their distinguished consideration.

MARION: Marion Motor Car Company, Indianapolis.—The "six" of this make looks like something good, and the auto-



Kiblinger High Wheelers were Attractively Displayed.

ists who make a point of studying cars must be of this opinion since they give it generous mention. This model is very complete, including a magneto in the ignition system and such other 1909 improvements as will be found on the more perfect cars of the year. The Marion line includes a "four" that is worthy of more than passing notice, if indeed it is not a car that should command the respect of the man with a pocketbook.

MARMON: Nordyke & Marmon, Indianapolis.—The new "32" of this line has the selective transmission swung in the rear axle, and the plant is one in which road inequalities can have little effect, even under the most severe conditions. The four-cylinder motor is of the water-cooled variety, and the cylinders are 4 1-2 x 4 1-4 inches bore and stroke respectively. The chassis frame is of the conventional type, the double three-point Marmon idea having been disposed of in this model. The three-point suspension principle is applied, however, and the motor is so suspended.

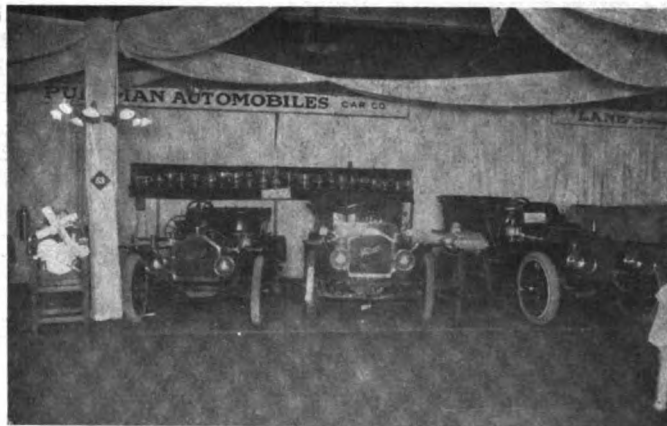

Prize Winning Pullmans and Some Trophies They Won.



Oaklands from Pontiac, Mich., Made a Good Showing.

have kept abreast of the improvements wrought in materials, and in the several details of any moment. The thermo-syphon system of water cooling that has been a success on these cars is, of course, retained, and the main features have proven to be so good that to change to some half-baked new ideas would have been foolhardy. The little runabout at the low price of \$500 is taking like hot cakes, and the doctor's car is one of the best of the line. The "double-opposed" touring car is still a very popular automobile, while more pretentious cars are available for the autoist who can afford to pay more at the hands of the Maxwell.

MIDDLEBY: Middleby Automobile Company, Reading, Pa.—The cars of this make are made in the shop once famous for the production of the Duryea. The situation is apparently well in hand, and the company offers a rather promising looking proposition by way of a runabout, and a surrey type is also built.

MIDLAND: Midland Motor Company, Moline, Ill.—With two models to choose from, the patrons of the company will surely find one to please. The Model E, for illustration, has a motor the cylinders of which are 4 1-4 x 5 inches bore and stroke respectively, and with four cylinders is rated at 25-30 horsepower. With a three-speed selective transmission, and evidence of good methods of design all the way through, it does look as if the Midland will make a good showing. The second model is with more power and is a more pretentious car in keeping with the difference in price.

MITCHELL: Mitchell Motor Car Company, Racine, Wis.—Racine is one of the greatest industrial centers in the State, and the Mitchell is one of the leading industries to be found there. Mitchell cars are in great numbers on the road, and even some of the oldest of them seem to run quite as noiselessly as any car should. The company took time by the forelock and

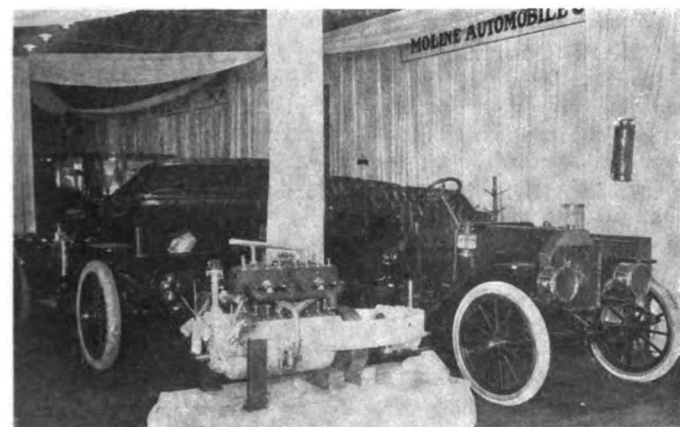

The Moline Had Ample Quarters—They Were Well Staged.

MAXWELL: Maxwell-Briscoe Motor Company, Tarrytown, N. Y.—"Consistency is a jewel," and it is the consistency of the Maxwell that has never departed from its stable abode. Maxwell cars are as numerous as the countless fireflies which illuminate the meadows in the lowlands, and in every case Maxwell is inscribed on the front of the approaching car, only to be repeated at every angle that parallels the line of vision as it intercepts the car. Maxwell stands for stability in design, and a buyer does not have to consider the question of the next year's car because they will look like the cars of the year before. The metal bodywork does not have to be replaced; a fresh coat of varnish, and the whole situation takes on the newness that can only be possible if the foundation is there. The Maxwell line is extensive, and the cars of the several makes, or models, properly speaking, are well suited to the work they are intended to do. In spite of a certain sameness which the Maxwell has adhered to, the cars of this make

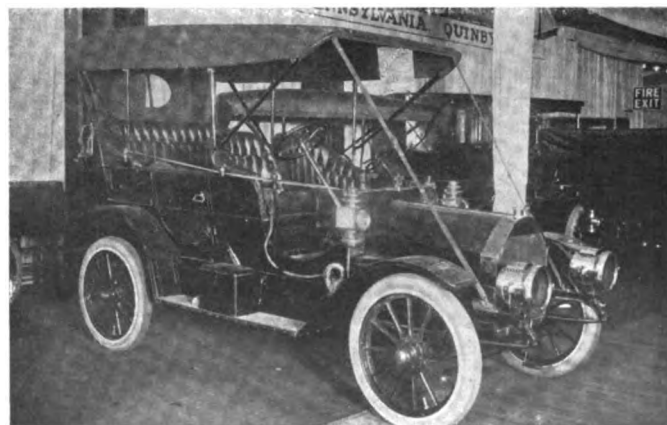

Pennsylvanias Shared This Space With Quinby Bodies.

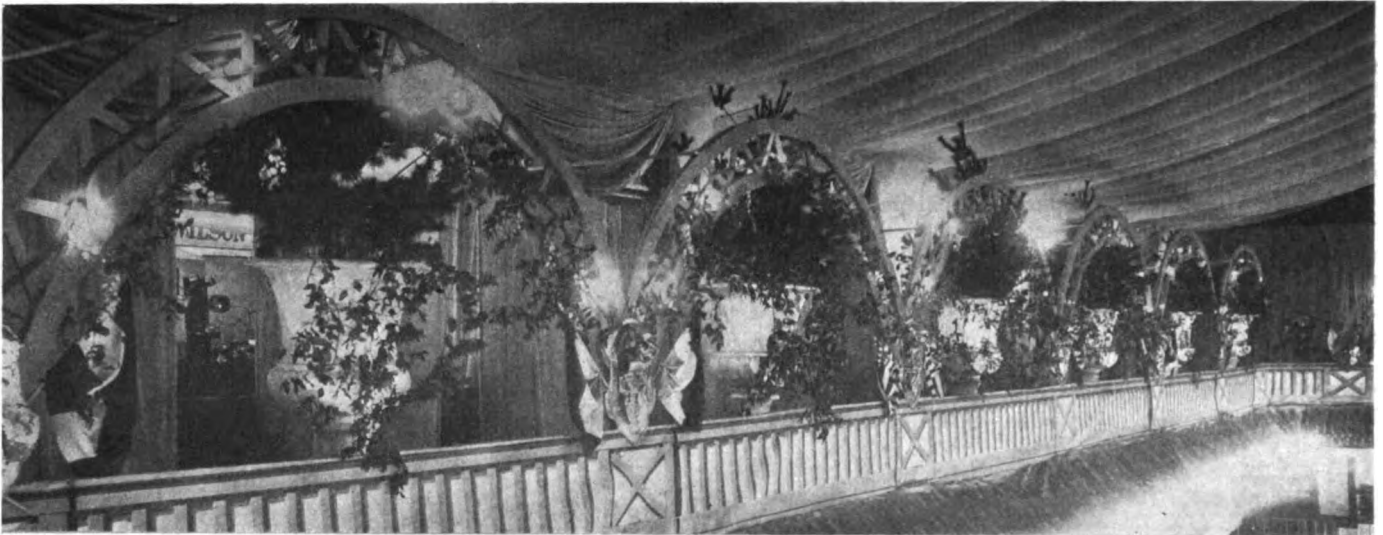

The Top Gallery Decorations Artistically Blended into the Scheme Without Any Overdoing of the Plan.

put out a popular-priced touring car, which for size and general getup is of the greatest merit. The leader of the line is the "thirty," a four-cylinder car of the conventional sort, using a dual ignition system including a magneto, and in other respects it is plain that when a Mitchell is purchased at the price of the car, the purchase price is not merely a license to spend more money.

MOLINE: Moline Automobile Company, East Moline, Ill.—The Model M of the Moline line is a low-priced car which is attracting a good deal of notice. It is rated at 24-horsepower, and the cylinders are 3 7-8 x 4 1-2 inches bore and stroke respectively. The car is very complete, and should be a quick seller to autoists of discrimination. Model K is a higher powered car, with all the Moline earmarks.

MOON: Moon Motor Car Company, St. Louis.—The Moon ideas are still present in the products of the company, and getatableness is the underlying principle. True, the designs have grown and amplified, but the germ is there, and it is not one to be lightly thrust aside. Every autoist knows that trouble can creep into any part of a machine, and to be able to see, feel and work on the parts that require attention is a necessity if a repair shop is not carried along. Moon car work belongs to a school that can well be allowed to expand, and the models at the show are receiving a fair share of the attention of the visitors.

MORA: Mora Motor Car Company, Newark, N. Y.—Of "sealed bonnet fame," with cars which are looked upon by the autoists so fortunate as to own one as a possession enough for a king. The light six is a fine illustration of Mora practice in which the motor is rated as 42-50 horsepower. It is with six cylinders, 4 x 5 1-8 inches bore and stroke respectively. The selective three-speed transmission connects with a shaft drive, and the wheelbase is just about right, considering 36 x 3 1-2-inch tires, to give to the "light six" all the characteristics of road performance to be used to advantage. The Mora line is complete and interesting.

NATIONAL: National Motor Vehicle Company, Indianapolis.—In the class with the advanced designers along lines consistent with the accepted practices as they stand approved by the autoists of experience and discrimination, the National will face the world with two "fours" and a pair of "sixes." These cars have ball-bearing crankshafts, and since it is not new with them, it is assured that the ball-bearing crankshaft is well worth whatever the cost may be, although it is a fact that National cars are not high priced, if account is taken of the plan on which they are built. As a matter of fact, a "six" at \$4,200 is a car of wide promise at a very low price, as automobile value goes. In the cars of this year, of the make under

discussion, will be found many refinements, the character of which will round out a line of cars long regarded as prominent.

OAKLAND: Oakland Motor Car Company, Pontiac, Mich.—Put to a wide range of uses and well up in the scale of quality cars, once the "Spain castles" of the autoists who lent support to the industry in its infancy, who by their experience were enabled to picture in the mind's eye what a truly good automobile would be like. Many of the sturdy supporters of the industry now sport cars like the Oakland, and they are, a contented lot; even the "old grumbler" who would kick if he drew a box seat in heaven, will be found purring like a contented cat in an Oakland. Take the Oakland "40," for instance, with its four-cylinder motor, with cylinders 4 1-2 x 5, 112-inch wheelbase and 34 x 4-inch tires. The car is one to give good satisfaction, and the price is \$1,600.

OMAR: Omar Motor Company, Newark, N. Y.—It would be jolly to be a "kid" if only to own one of the little Omar cars, built especially for boys and girls. The Omar is a real automobile, only it is the smallest real car offered and is intended to make life worth living—as a boy.

OVERLAND: Overland Automobile Company, Indianapolis.—With two additional models and all the features of Overland merit rounded out in a manner to suit the most fastidious, this company is in a position to do justice to its reputation. The new "six," with cylinders 4 x 4 1-2 inches bore and stroke respectively, is rated at 45 horsepower, which, with magneto, and all the improvements that belong on any automobile, makes a car that should take rank with the road performers of the day. The flexibility of this car is favorably commented upon, and as to the materials it is understood within the circle of the knowing ones that everything is all right.

PENNSYLVANIA: Pennsylvania Auto-Motor Company, Bryn Mawr, Pa.—This company, with a well-arranged plant and every facility for the purpose, has a fine line of cars to offer and they are attracting the notice of buyers of acumen. The model D 28.9-horsepower car with a four-cylinder motor, 4 1-2 square, is one of the line that seems to sell very well indeed. The price, \$2,100, is well within reach and the car at the price is one to consider.

PULLMAN: York Motor Car Company, York, Pa.—The model K Pullman is a car at \$2,000, with a 4 1-2 square, four-cylinder motor, ignited by Bosch magneto service, in which the details are worked out in a way consistent with the good qualities of the car as a whole. There is a certain simplicity about Pullman designs that seems to be difficult of attainment; and it is a good idea to tie up to. The Pullman line is complete, and there is also the fact that it is a product built under the direction of the company's own men in all particulars.

PREMIER: R. M. Owen & Company, New York City.—The "six" at \$3,600 and the "four" at \$2,500 make a fine pair, which, coupled with the performance of these models, accounts for the success of the company. It was one of the "Premier" cars which went and went until it collected some twelve successive centuries in as many days, and the worst thing said of it by the judges was that a brake-shoe "dragged" slightly, otherwise the brakes were unimpaired. It was understood among the members of the "inner circle" that the car did not have a fair show even as it was, because it had to be rushed to completion to be ready for the test on time. Of course, the Premier methods accounted in a measure for the fact that the "rush" did no great harm. A rigid system of inspection may be a nuisance according to the man who would like to get through, but it shows up well in a pinch and when it does not come to the surface it is still there "just lying dormant" awaiting the emergency which will ultimately render its presence manifest.

REO: Reo Motor Car Company, Lansing, Mich.—The \$500 Reo runabout is so well and favorably known, and has so many thousands of users, that anything which one might say in its favor would be "stale news." This car formerly sold at \$650, and while the price is lower this year, the quality is better if anything. The roadster will sell for \$1,000, and so will the touring car. Both of these cars have the same chassis, and the double opposed motor is rated at 22 horsepower, which is conservative enough for a double opposed motor with cylinders 4 3-4 x 6 inches bore and stroke respectively. The Reo is a "sweet" running plant, and the fellow of the lean pocket book can well afford to look it over.

REGAL: Regal Motor Car Company, Detroit.—"The day of the inflated ideas and the enormous profit is past." So says the Regal. It must be when the four-cylinder "thirty" sells at \$1,250 and especially in view of the fact that the car is in every way a "conventional" proposition with just the design and the features that are supposed to be characteristic of a real automobile. The wheelbase is 105 inches, and the control is absolutely standard in every way. With a high tension magneto, water-cooling and a carbureter that eliminates dead points, the flexibility is thoroughly good in every way. As they say, if just a good automobile is wanted, "look it over."

SPEEDWELL: Speedwell Motor Car Company, Dayton, O.—Difficult to get near enough to the exhibition to have a good look at the Speedwell. Fortunately, data was available from more reliable sources, and the general appearance of the car accounts for the "congregation." Must be a congregation, didn't look like a "soup house" contingent, and if they were short a few cents to make up the requisite \$2,500 they could easily borrow the difference on an "I. O. U." The motor in the Speedwell "40" is of the four-cylinder water-cooled type, with "Bosch" magneto and cylinders 4 3-4 x 5 inches bore and stroke respectively. A selective three-speed transmission serves as "catcher" for a cone clutch, and the shaft drive leads to a live rear axle with

Timken roller bearings to take the brunt of it. The 34 x 4-inch tires do the rest, and they are about the right size to be sure of the result.

SHARP: Sharp Arrow Automobile Company, Trenton, N. J.—Full 40-horsepower, no discount, assured since the four-cylinder motor has 5-inch square cylinders, and the "Bosch" magneto does the rest. The Sharp is just such a car as one would expect to do a mile-a-minute and not get out of breath. All the features are along recognized lines, and the car is attracting a good deal of favorable comment. The materials are rather good, and the distribution of the materials used is in accord with the actual needs in view of the arduousness of the service.

STODDARD-DAYTON: Dayton Motor Car Company, Dayton, O.—The last few years have seen a fine display of the cars of this make, not only at the shows but on the road. It is a little difficult to go anywhere and not see a shapely and graceful Stoddard-Dayton under happy auspices every once and a while. For \$2,500 the four-cylinder 45-horsepower is a thoroughly good proposition, and with a roadster body it is a road performer of no mean merit. The cylinders are 4 3-4 x 5 bore and stroke respectively, and with a magneto for ignition purposes and a good control all around, this car with its rather long wheelbase performs extremely well. It is a shaft-drive with a three-speed selective gear, well designed live rear axle, and the wheels are fitted with 34 x 4-inch tires. The touring model is in brisk demand, and the company belongs to the class that starts out right and do not have to come out with revisions every season. True, the Stoddard-Dayton is kept up to date—strictly, but it is rather well understood that "revisions" are by way of the elimination of mistakes in most cases. The cars of this make at the show present a fine appearance, despite the "jam." Certainly it would be well worth while to look them over in detail, under conditions such as would enable one to enjoy what seems to be a picture in harmony. Then, there is the assurance of past favorable performance.

WELCH: Welch Motor Car Company, Pontiac, Mich.—If Pontiac, Mich., never produced anything but the Welch automobile, it would still be doing its full duty to the nation. The visitors at the show with few exceptions will be wholly unaware of the fine qualities of the materials used in the Welch models; they will not know that the alloy steel in the crankshafts is the choicest of the choice. They probably will not appreciate the refinements in design that cost "midnight oil" and not a few of the spectators would say, "what's the use." On the other hand, it is just such painstaking care and the use of fine materials that make automobiles in the long run. If a pioneer cannot realize in coin of the realm, he can be satisfied with being right as he sees it, and he will surely benefit the industry as a whole in the long run. The Welch models at the show are attracting the visitors, and it is pleasing to note that a good many of them know a good car when they see it.

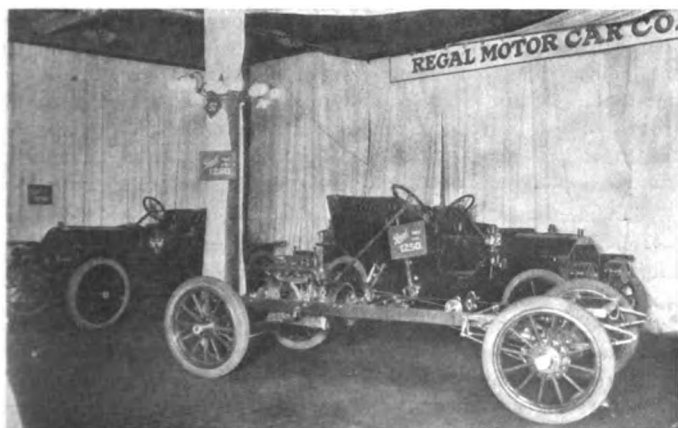

This Newcomer from Detroit Attracted Much Attention.

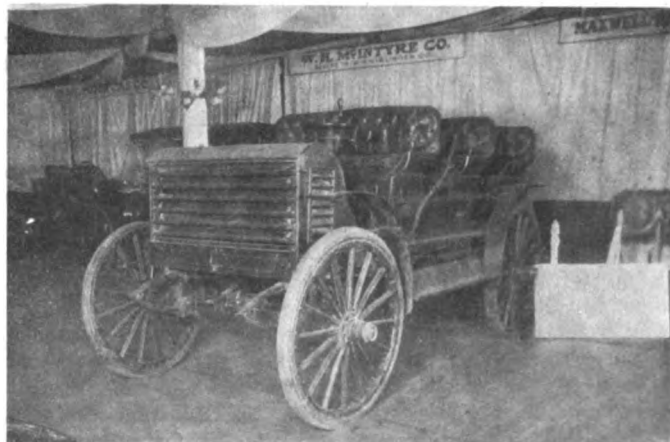

This Old-timer of 1876 Has a History, Told Elsewhere.



The Popular Renault Was Shown by Numerous Models.

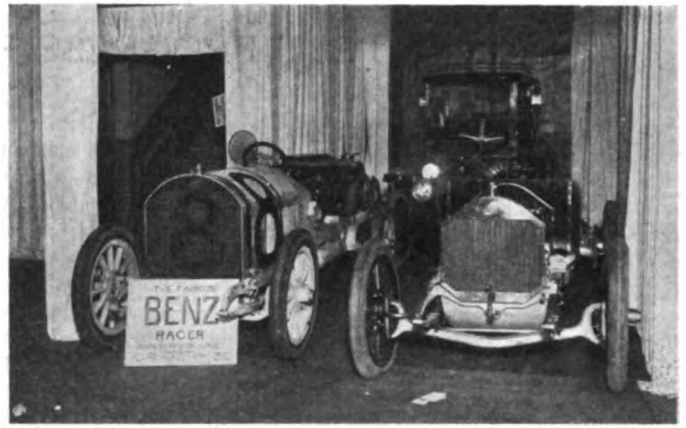

A Pioneer German Car that is Making Headway Here.

AMERICAN STATUS OF FOREIGN AUTOMOBILES DEFINED

THE law of the survival of the fittest will apply to this situation as it does to every undertaking. All that remains is to define the fittest and the situation will be as bare as the Sahara. In the first place, the fittest in France, or in Germany, or in Italy, will not of necessity fill that coveted niche in "the land of the free." American roads may have much to do with the situation, but it is the American method of doing business that must in the long run obtain.

In America, for illustration, it is but to a small extent possible to trade on precedent. What Mr. A. does, the car he prefers to air himself in, will not serve for long as a "puller in" for all mankind in this country, because all are not sheep. Then, again, there is the question of discrimination to take into account. In this country it will not do to "discount" Mr. A. and "soak" Mr. B. Some of the buyers will stand for it, for the reason that "social" considerations will control; but in the long run it is not an American method, and the name—discrimination—once it is on the tag of a company will have much to do with the future of that company. Then there is the question of selling cars on a basis of "new," when, as a matter of fact, they are not new—after they change hands a few times. Moreover, the idea of giving a chauffeur say \$1,500 if his "master" buys a car is bad. All these methods bode ill for the company that does business on such a basis, and while it may take time to have the cat get out of the bag, the fact remains that the cat will get out.

Of the foreign companies doing business in America it is a fact that the companies whose business methods are sound are the ones that will remain, and they are the companies which cater to the wants of the community delivering a dollar's worth of automobile for a dollar. The dollar's worth of automobile should include a profit for the maker and the cost of dealing with the purchaser; but there is no reason why it should include a house and lot for the chauffeur. The car should be brand new, and it should be in good working order, or the seller should stand behind it for a reasonable length of time.

The average maker of cars in America knows full well that there is an everlasting penalty attached to the gross violation of sound methods of doing business, and if he expects to stay on the market, to avoid undue pitfalls is the natural thing to do. The wise ones from "the other side" with good cars to dispose of have refrained from offending to the greatest possible extent, possibly to the same extent that the American makers have kept away from "the pace that kills." At all events, it is a case of the survival of the fittest, and the fittest is measured in terms of business stability now that there are enough "good" American cars to go around. There are now no secrets in connection with the question of materials, and American makers were always in a position to furnish machine tools in keeping with the most

exacting situation, so that it is a fair inference that quality resides in cars from several sources.

When it comes to skilled labor, the educated workman in the long run prove to be the one of dependable characteristics, and if he does get more dollars per week, he does more work in a week, thus giving to the patrons of the industry the benefit of brains, after they have gone through a course of sprouts.

That the foreign automobile has been a blessing in more ways than one is to be conceded by any fair-minded man, but it does not follow that the foreign maker can cash his check more than once. On the whole, even taking all these matters into account, it is a fact that some of the foreign cars are certain to survive, primarily because the cars are good, and again in view of the business acumen of the men behind them. They are the men who know the peculiarities of the American, and they do not risk loss by grossly offending.

RENAULT: Renault Frères Selling Agency, New York City.—The foreign car situation is not in a precarious state as far as this agency is concerned, for there is a good demand for the Renault, which car has earned and maintained a reputation in America that will hold it in good stead in the future. The Renault has always maintained that it is not good business to build fine racing cars, and on the reputation gained by them exploit the American public. As a result, the Renault exhibition is well patronized, and there are evidences of undoubted prosperity in the Renault zone of activity.

LANCIA: Hol-Tan Company, New York City.—The famous racing driver of this name, who made so many friends while in this country, seems to have imparted some of his enthusiasm into his product, for to say that this little car has "taken" would be putting it mildly. A motor with 3.5 inches bore and 3.9 inches stroke, driving through a selective type transmission to a final shaft drive, furnishes power sufficient to accomplish some surprising results. With the same cylinder dimensions a "six" is also built, the wheelbase being increased from 110 inches to 128 inches for this model. The special chassis, the "Lampo," which won the light car race at Savannah, has slightly larger bore and in general lighter construction throughout.

BENZ: Benz Import Company of America, New York City.—This company is not so well known to the American public, but it has ample opportunity to show its business acumen, and the reputation it brings from the other side is such as to serve as a good introduction. The Benz car was one of the pioneers of the world, and it is a dominant factor in Europe, both in racing and in the more useful fields of endeavor. Benz cars are to be had in the several customary sizes and with optional bodywork on a scale not to be outdone in pleasure cars.

GREATEST PROGRESS POSSIBLE IN TAXICAB SECTION

ONE of the most marked phases of the taxicab situation, with reference to the progress made in the past year and the changes brought about in the working out of this progress, is the great gain in favor for the left-hand control. The strange part of this is the fact that left-hand control was tried, condemned and abandoned some years ago. To-day for taxicab use it is in favor, and most of the newer makes exhibited for the first time are so arranged.

In cars arranged essentially for public service use, the tendency toward unit construction, each unit being of the "quick detachable" type is very marked. This works out in engine arrangements which allow of a complete change in forty minutes, transmission layouts with which a shift to a new unit can be made in twenty minutes, and similarly with axles, clutches and other vital parts. In the way of giving the maximum possible mileage from a chassis, and consequently the maximum of profit, these arrangements come as near being perfect as is now possible.

Dropped frames allowing a very low center of gravity, and, incidentally, less racking, are now very general, while in conjunction with them three-quarter elliptic rear springs are universally used.

More provision is now made than formerly for baggage, the single front seat leaving a large space which, when suitably ironed, is very serviceable for this purpose.

A tendency is shown toward lower powers, the argument being that the public service car of hard usage must have a marked economy of operation to offset the high depreciation factor. This is only obtained with the very efficient and small motor. To carry the argument further, the manufacturers say that it is better to be underpowered 5 per cent. of the time and economical for 100 per cent., than to be overpowered for 100 per cent. and economical for 5. This is good logic from the point of view of the cab operator, as one spells failure while the other has success written on it in large letters. As bearing out this line of argument, witness the 10, 12, 14, 16 and 18-horsepower cabs shown, varying from a single cylinder up to "fours," most of the latter being *en bloc*.

ATLAS.—The new and growing field of the taxicab and its closely related field, town cars, are both well represented, the American makers vying with the foreigners as to who shall show the greater number. The foreign makers, however, are behind in one respect, viz., they have never paid any attention to the two-cycle motor; at least to qualify this, the makers represented at the Palace show have not. So in the two-cycle field of the taxicab makers the Atlas Motor Car Company stands alone. This company show a taxicab with their two-cylinder, two-cycle, 4 1-2 by 4 1-2 motor with offset crankshaft. As a public service vehicle the simple ignition system would be a big talking point, since it allows in part for a driver of lesser intelligence.

C. G. V. TOWN CAR.—The sloping hood made famous by this company is continued, the radiator now being placed in front of the dash instead of low down in front as formerly. Following latter-day practice, no torque rod is used, the shaft encasing tube which is made to take torque being strengthened above and below by light but strong truss rods. The motor is of the style now popular for small powers; that is, with cylinders cast *en bloc*. This maker pays particular attention to the proper relations existing between the tread, wheelbase and steering lock, with the result that an unusually short turning radius is obtained, almost short enough to turn in a Boston street.

DE DION TAXICAB.—One of the oldest and most successful of French makers, having specialized on single cylinder vertical motors, would naturally be expected to do something nice in the single cylinder town car section, and in this respect the De Dion-Bouton Company's exhibit is no disappointment. Following the latest foreign practice the dash is clean, all accessories being under the hood. This gives the car an excellent appearance when viewed from the side, the clean businesslike look being a very favorable one.

FORD CAB.—The most noticeable feature of this cab is the left-hand control, which allows the driver to look back, which is a big advantage in crowded streets. These enclosed cars showed up very well, the body work and upholstering surpassing the usual work of this nature turned out by this company. The Model T was shown in both landaulet and limousine bodies, either one of which would be suitable for town car work, although for taxicabs the former is usually fitted. A short wheelbase and a narrow tread give a very short turning radius, particularly desirable on the public service cars.

GENEVA CAB.—Among the many newcomers at the show, none made a better appearance than the Geneva cab, designed by Louis Mooers and shown for the first time. In common with many of the older makers, this company has decided to use left-hand control, a single driver's seat being fitted on this side with a large trunk space on the right side, suitably ironed to prevent damage to the car. A frame with a big drop just forward of the rear axle and the use of three-quarter elliptic springs gives the required low center of gravity with good riding qualities. In the construction of this vehicle, the manufacturers have taken the stand that public service cars or taxicabs are subjected to unusually severe strains, not only from the nature of the service, but from inexperienced drivers and a desire on the management's part to keep the car in operation as much as possible. A clean dash of selected circassian walnut, an aluminum foot and toe board and a Ewing landaulet body, combine to give a very harmonious picture.

ROCKWELL CAB.—The Bristol Engineering Company has developed the Rockwell public service cab. A close inspec-

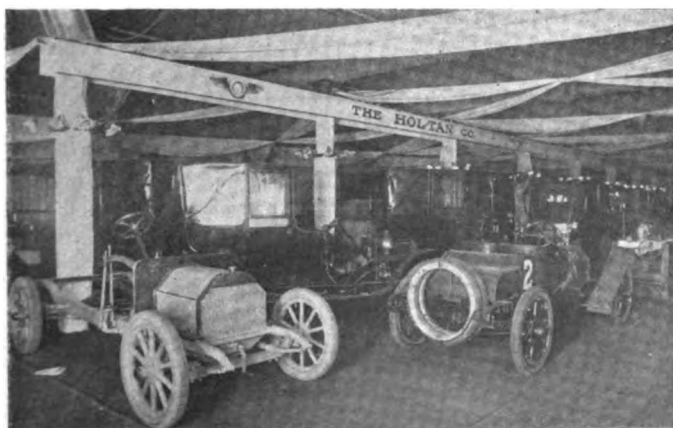

Where the Lanclas Were Shown by the Hol-Tan Co.



Designer Mooer's Geneva Cab—Cleveland Autocab Co.

tion of this shows a very clear insight into the work that such a car must do and a very ingenious design with the idea in view. This car is all new and in no sense a copy. Commencing with left-hand control, continuing with *en bloc* motor, absence of spark advance, guard for radiator front, quick removable motor and transmission both on three-point suspensions, etc., right through, the thought bestowed on the design and construction is self-evident. In the matter of ready removal of either engine or transmission, it is said that the former may be taken out in less than an hour, while half that time will suffice to replace a transmission. In getting maximum mileage out of any given chassis, this feature will add a great deal, for by having extra engines

and transmissions in stock, the change can be made in about the time necessary to get out another substitute cab.

SULTAN CAB.—The majority of manufacturers in starting the production of a taxicab were obliged to copy from some other manufacturer or go through the bitter trials of experimentation. The latter course, if sufficiently remote, is by far the most preferable one, so that any company which can truthfully lay claim to being a pioneer has a big advantage over competitors. This holds true of the manufacturers in this company of the Sultan cabs, the Sultan Motor Company, which, although but four years old, is building under a license from the old French firm of Lethimonnier & Cie.

MOTOR BUGGY ADVOCATES PLEASED AT THE SHOWING

NOT to be outdone by the larger and more expensive heavy trucks or the smaller and more costly cabs, the buggy type seems to gather to itself more friends every year. The number of exhibitors was greater, the number of cars exhibited was increased in numbers, both by a natural increase and by the greater number of exhibitors. The progress shown in this category is none the less marked because it consists mainly of improvement in small details rather than principles. The latter was proven correct years ago, and now it only remains to put on the finishing touches.

A decrease is to be noted in the size of wheels, but this is probably a sacrifice to appearances rather than the abandonment of a principle, the idea being to look as nearly like the touring car as is possible without altering other things. This is not carried to extremes, 34 inches being the popular as well as the minimum size. The use of water-cooled motors seems to have gained a little ground on the air coolers, as has wheel steering over the more simple lever. Some offshoot of the newer cab tendency to place the control on the left side was also seen.

ANDERSON.—These are being used largely in the Middle West by doctors, salesmen, collectors, farmers and business men in general. Their use is extending hand in hand with the pleasure car of small wheels and pneumatic tires, and women learn to drive them readily because of their simplicity, lightness and ease of operation. Three models are produced—A, B, and C, the latter having an optional equipment which includes artillery wheels with 30 x 3 pneumatics. All models are equipped with a new type of air-cooled motor of superior efficiency, having the valves in the head. The drive from the planetary transmission to the jack shaft is by single roller chain and to the rear axle by double chains, the latter being very short. Wheel steer is provided on all models. One interesting point brought out at this display is that the ordinary divided countershaft is weak because divided.

BLACK.—Another Chicago firm specializing in this type of car is the Black Manufacturing Company, of Chicago, which showed a number of types. These vary in bodies and wheel base, the largest having a nine-passenger body suitable for station wagons, summer resort use, etc. The smallest, on the other hand, is Model 12, a smart two-passenger runabout. The latter is the firm's leader for the coming year and is one of the lowest priced cars made anywhere. This, placing it within the reach of the multitude, should result in large sales, particularly as the details of the car show merit. One most peculiar thing on this car is the double frame. The rear axle, front axle and the tie rods joining them form one, the lower, while the upper framework of angle iron carries the power plant.

HOLSMAN.—The oldest and largest of the motor buggy manufacturers, the Holsman Automobile Company, of Chicago, were unfortunate in their choice of space, the section selected coming next to and across the aisle from high-priced high-grade touring cars. The comparison between the two made by the ordinary showgoer would therefore be less favorable to the former than it would have been if located among the motor

buggies. In the latter situation the many meritorious features which have kept this car in the foreground and helped it to win the many reliability contests would have appeared to better advantage. This maker has steadfastly adhered to the chain cable, the final drive being a specially prepared cable, while the secondary drive to the transmission shaft is by silent chains, this feature making for noiselessness. In opposition with others who have slavishly followed automobile practice and fitted a steering wheel, this firm has continued to use lever steer, and all cars exhibited are so fitted. For the coming year a new higher-powered car with four-cylinder motor will be featured, known as Model H-15.

INVINCIBLE SCHACHT.—The increased number of high wheelers exhibited was a fair criterion of the increased interest in this type of car. It is said of one county in Kansas that six hundred machines are owned and another hundred ordered, of which over three-quarters are of the high-wheel type. This car appeals to the farmer and people in rural districts because of its inherent simplicity, lack of noise and low upkeep cost, due to fuel economy. This Cincinnati firm, the Schacht Mfg. Co., is prepared to get their share and more of this business with a simple, practical and economical car.

KIBLINGER.—While in the motor buggy class, the name of high-wheeler really is a misnomer for these cars, as the wheels are not high in the accepted sense of the word, 34 inches being the standard size on all models regardless of body, passenger capacity or type. In every other feature, however, this product follows in the lines of construction peculiar to the high-wheel cars or motor-buggies, as they are sometimes called. The power is furnished by a two-cylinder horizontal opposed air-cooled motor, and varies, 13½ to 16 horsepower being furnished on an equal number of classes, three each. In addition a larger model with 27 horsepower is now listed.

RELIABLE DAYTON.—Chicago seems to be the home of motor buggies; at least one might be inclined to think so, judging from the number of large manufacturers of this type of car located there. The firm in question has produced a thoroughly reliable machine of this type, so much so in fact that it has been dubbed "the first real successor to the horse." This reliability is brought about by the utilization of a water-cooled engine and of a sliding gear transmission. This sounds big and complicated, too much so in fact for a motor buggy, but as worked out in practice it is so small and compact that it would go in your hat. In fact one visitor at this company's exhibit overlooked it entirely, and looking at the chassis on exhibition, asked where the transmission was! Despite the extra cost of double chain drive over shaft drive this concern has stuck to the chains, and expects to continue using them forever. Following the better-touring-car practice, brakes are in the rear wheels, both internal expanding. A liberal use of ball and roller bearing throughout the car adds to the price, but also to the durability in a much larger proportion. The Reliable Dayton Motor Car Company, Chicago, is the manufacturer. The company reports good business and comment on the product is decidedly favorable.

HEAVY TRUCKS SHOW MARKED ADVANCEMENT

By MORRIS A. HALL.

WHILE not as marked as its spread through the list of heavy trucks, the essential improvement in the other commercial fields, viz., the quick-removable unit construction, the left-hand control and other ideas, all made progress. This field was extended somewhat by the return of two of last year's exhibitors under new names and with an infusion of new life and many new ideas. Also, by the addition to the heavy car list of one of the light commercial car manufacturers. The latter showed for the first time a very heavily constructed truck rated nominally at five tons, but easily capable of a 60 per cent. overload. The bare fact that the maker tested it out under this excessive overload would show that our commercial manufacturers are learning fast the conditions under which their product works.

The exhibition of one of the best foreign trucks with a whole host of new ideas was one that doubtless was good for our builders. This truck is fitted with a self-starting device that actually works, an arrangement for using the motor as a brake by running it two-cycle and thus doubling the compression or

are shown and no advocates of this drive have changed sides. This situation is anomalous, to say the least, that the buying public should buy these drives without a cover for the dirt. From the manufacturers' side, the idea seems to prevail that there is no use complicating the situation and adding to the cost until the public demands a cessation of noise and is willing to pay for it. The silent chain drive so prevalent in England and elsewhere abroad has made no progress on this side, strange as it may seem.

Bodies on heavy trucks were few, most builders being willing to expose the mechanism to the public and explain the working of the same to the uninitiated. The few bodies shown gave evidence of a more advanced stage in wood working, as well as superior painting, trimming and upholstering.

AMERICAN: American Motor Truck Company, Lockport, N. Y.—Along the row of big trucks in the commercial vehicle section of the show, the product of the American Motor Truck Company was to be found occupying a central position. The

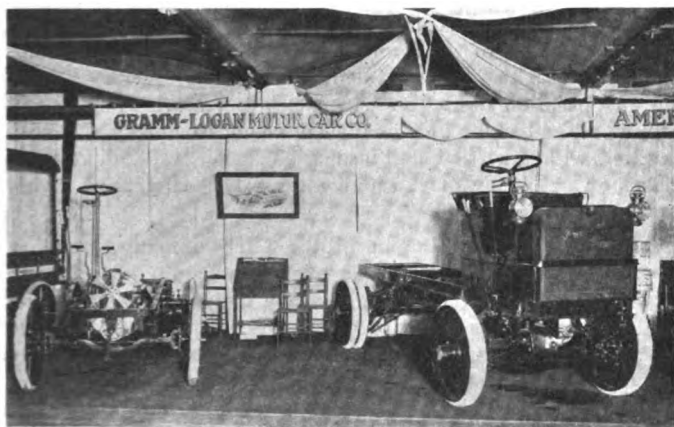

The Logan Was Easily Distinguished in New Guise.

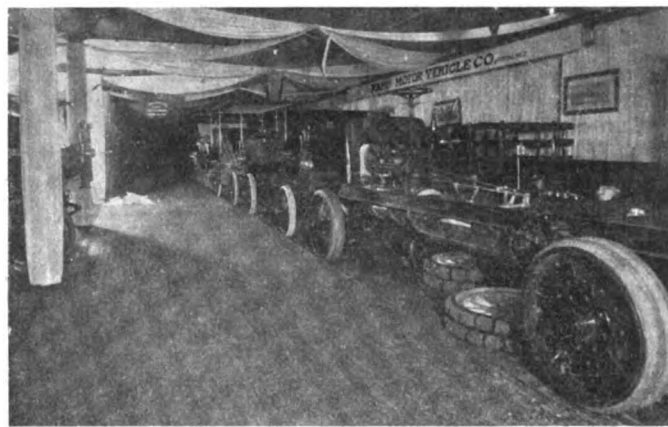

Rapids Were Shown in Profuse Sizes and Styles.

braking strokes, fully lubricated springs and shackles, an unusually efficient carbureter and other features which will, at least, give our manufacturers food for thought.

Among the domestic trucks, the use of sprags to prevent a car backing down hill is on the increase. These do not always take the same form, some using but one, while others show a preference for two. The added weight in proportion to the total is so very slight that it would seem as if (granting that they are worth while putting on) two was the correct number. One maker very cleverly adopted a feature of railroad practice when he placed a sand box on the rear of the chassis with a lead to the ground a few inches in front of each rear wheel. A foot button is arranged to open both valves so that on reaching a slippery place the driver simply presses the button and sands the rails, so to speak.

Increased attention has been given to the running gear, if one may so designate the axles, springs and wheels. Axles are larger and heavier than before with stronger reinforcements. The new big truck, for instance, had a rear axle 4 1-4 inches in diameter of very heavy steel tubing. In the line of springs, superior material is being used and lubricated in some cases. This, while not a good report, is a positive advance over previous years. Wheels throughout are heavier, and now that prices have been cut, we find larger tires freely used. The use of twin rear tires is universal, but the full solid is losing some ground in favor of the sectional block or partially replaceable tire. No examples of wooden or steel tires were to be seen, although makers are known to be experimenting with the former type.

The question of final drive stands still, no new opposition has developed to the double chains, no new chain covers or boots

exhibit consisted of a five-ton standard truck chassis, which is unchanged from former years with four-cylinder motor, having individually cast cylinders, valves on the left, a governor for regulating the speed, planetary transmission, double side chain drive, and very heavy construction throughout, as would naturally be used on a truck of this capacity. The feature of the exhibit, however, was the showing of one of the new models. This was a one-ton delivery wagon known as Model S. This new "American" shows a few departures from the larger previous constructions, but these are more in the nature of up-to-date refinements than radical changes. The engine is a four-cylinder unit rated at 25 horsepower and has the cylinders cast in pairs with valves on opposite sides. From this very neat and compact power unit the drive is by shaft to a sliding gear transmission and thence by double side chains. While any type of body may be had the one shown was the standard box or delivery wagon body. The neat lines of this showed that the American people have excellent facilities for turning out good work, being an excellent sample of the body-builders' art.

For the coming season this company is listing for the first time, besides Model S just mentioned and the two old standbys, the 3 and 5-ton trucks, Model M, 1 1-2 and 2-ton truck, Model T, 1,000-pound delivery, and Models E and D, 16 and 20 passenger cars, respectively.

ATLAS: Atlas Motor Car Company, Springfield, Mass.—At the Atlas stand, hidden away in one corner, was one of the neatest little delivery wagons shown. This little power wagon was half hidden among the more popular touring cars, runabouts and town cars which surrounded it, but any one really interested in the work vehicles could not miss it. The body and

general chassis lines follow standard practice, but the main feature which makes this car different lies in the power plant, the principal part of the car. In this case it is an excellent example of the two-cylinder, two-cycle motor to which this firm has pinned its faith. A second feature which will be noted is the control, this being grouped on the left-hand side contrary to usual practice. The idea in this case is to allow the driver to look back when obliged to stop or reverse. With a weight of 2,300 pounds, a carrying capacity of 1,200 pounds and a motor conservatively rated at 20 horsepower, this car, known as the car that "delivers the goods," is well equipped and should show up well in actual service.

BRUSH: Brush Runabout Company, Detroit, Mich.—The prime feature of the Brush exhibit and one that was given the place of honor was the little runabout that climbed Pike's Peak. With all of the Western dirt and grime still on it, this sturdy little customer still looked ready for more. Besides this veteran and a sample pair of Pike's Peak-eaten tires, a delivery wagon, three passenger runabouts and chassis were shown.

CARTERCAR: Motorcar Company, Pontiac, Mich.—This strenuous advocate of the friction drive, recently removed from Detroit to Pontiac, Mich., where larger facilities are available, showed a model of each of Type H and the new Type K, as well as a convincing example of the friction drive in operation. The touring car chassis and the sample transmission shown served to show the delivery wagon made by this firm, the departures being (aside from the body, of course), few and insignificant, such as wheels, tires, etc. The success of this friction drive has been astonishing to advocates as well as skeptics. In fact, in the hands of this company so much progress has been made with it that they are offering a thousand dollars to any one who will slip the discs.

COMMERCIAL: Commercial Motor Truck Company, Philadelphia.—Another exhibit which was hidden away in a corner where no one would see it was that of the Commercial Truck Company of America, but one who was interested in electric trucks would take the trouble to hunt them up and find a chassis of the 1,000-pound wagon and a 2,000-pound delivery built for John Wanamaker & Company. These have a single motor shaft drive using worm and gear, only the rear wheels being driven. On the larger models, however, four-wheel drive and steer is employed, the motors being mounted directly upon the wheels. This interesting type was not exhibited.

GAETH: Gaeth Automobile Company, Cleveland, O.—While not advertising nor showing a delivery wagon, the Gaeth Automobile Company are building and cataloguing one, known as Type K. This is a one-ton machine with a single cylinder motor conveniently located under the footboard, which is readily removable for inspection or repairs. This is fitted with an excellent appearing closed delivery body and the whole appearance of the car is good. The makers state, however, that they have had very little demand for power wagons and consider the production of one at this time a trifle premature, which is their reason for not exhibiting a sample of the Type K wagon.

GRABOWSKY: Grabowsky Power Wagon Company, Detroit.—With a single exception this young and energetic manufacturer showed the largest exhibit of commercial cars. These were four in number, consisting of a state truck, express truck, sixteen passenger sight-seeing cars and a chassis. The latter was used to demonstrate the idea of this make, viz., quick demountable power unit. The truck is constructed with this idea in view, and as a result the power plant may be removed and another one installed in a remarkably short time, some claim as short as 10 minutes. This is accomplished by mounting the engine and transmission on a subframe of inverted V section. This in turn slides on the top and outside of another permanent subframe of V section. By opening the front of the frame, disconnecting six unions and a few bolts, this whole power department may be slid forward. Then a short piece of angle with a roller at one end and a special connection at the other attaches

to the ends of this subframe, four of these converting it into a truck with the engine and transmission on top.

HART KRAFT: Hart Kraft Motor Company, York, Pa.—There were many new faces to be seen, among which were the Hart Kraft Motor Company, with a new delivery wagon. This new company have wisely decided to concentrate their energies on a single type 1,000-pound delivery, which will be turned out in large quantities. This has a readily removable type of power plant, the engine, transmission, etc., being mounted upon a subframe which can be completely removed in less than an hour. This readily removable power plant idea is one that is gaining many friends and advocates every day, and the new company is to be congratulated on their foresight in choosing this feature.

LAMBERT: Buckeye Manufacturing Company, Anderson, Ind.—Among the numerous advocates of the friction drive is the Buckeye Manufacturing Company. This Indiana concern has gone in strong for it, and as turned out by them it has been a very successful device for the transmission of power. Whatever the individual may think cannot be put up against positive proof, as shown by such experiments as placing the front of the car against a brick wall, then turning on the power. This test the Lambert drive has gone through successfully a number of times. It is to be regretted that they did not show a delivery wagon, but the chassis and the various touring models shown conveyed the idea of the form of construction quite well, perhaps fully as well as the completed delivery would have, without wasting any space on the latter. An exclusive feature by this company is the utilization of a final silent chain drive, which, in conjunction with the friction transmission and a well-built engine, makes an absolutely quiet running car. This latter is a highly commendable feature.

LOGAN: Gramm Logan Motor Car Company, Bowling Green, O.—An old friend in new clothes would not classify as a new friend, so the Logan company under a new name will hardly come in the category of newcomers. These people showed two excellent examples of commercial wagons, one a 1,500-pound delivery car and the other a well-worked out example of a three-ton truck. The former shows very little change from the proven features of last year, including 25 horsepower, air-cooled motor, two-speed progressive transmission multiple disc clutch, double chain drive, etc.

The latter, on the other hand, while following last year's general lines, has a number of new features, many of them entirely original. Thus the fitting of a sand box to sand both rear wheels is a new one, as is also the use of hard steel rollers on one end of each spring in place of a shackle. A three-speed progressive gear set is out of the ordinary; so, too, are many of the excellent little details all over the chassis.

MAXWELL: Maxwell-Briscoe Motor Company, Tarrytown, Pa.—In bringing out their thousand-pound delivery wagon along the same lines that have been successful on thousands of touring cars and proven right by hundreds of tests, this company have made no mistake. This little work vehicle has the unit power plant multiple disc clutch and other features which have made the Maxwell a byword in every nook and corner of the land. The body work on a car of this sort does not need a piano finish, nor on the other hand would it be advisable to try to sell it without any paint or varnish. In this the Maxwell people have struck a happy average. The body has neat, pleasing lines and is painted and varnished just enough to make a nice appearance and wear well.

MANHATTAN: Mack Bros. Motor Car Company, Allentown, Pa.—This eccentric manufacturer shows the same as last year, one passenger car and one three-ton truck. The former, however, is a new departure in bodies, being of the sixteen passenger enclosed bus type arranged to be used for a pay-as-you-enter car. With this idea in view the driver is shifted to the left side, where he not only controls the car but the entrance and exit of the passengers as well. This type should have a good field in small towns.

LANSDEN: Lansden Company, Newark, N. J.—The attraction at this booth was the new dock truck especially built to work around docks, piers and terminals. This is a large platform, 14 feet x 4 feet and 28 inches off the ground, mounted on two wheels side by side equipped with 24 x 6 rubber tires and an additional maneuvering steel wheel at each end. The power is electric, Edison batteries being used and may be controlled from either end. Despite the ten-foot wheelbase, the truck may be turned around in its own length, owing to both front and rear wheels steering.

PITTSBURG: Pittsburg Motor Vehicle Company, Pittsburg, Pa.—The keen competition of recent years has had its result in the redesigning or improving of all cars. Particularly is this true of electrics. Among those electric commercial vehicles which have shown a big advance is the Pittsburg. This wagon has a very light weight for its carrying capacity, due to a superior battery of decreased weight and very light weight driving mechanism. Two cars are shown in the Palace exhibit, both new designs, one of 750 pounds and the other of 1,500 pounds capacity. Both of these are guaranteed for an overload capacity of 33 per cent., which speaks well of the maker's confidence in his product. Another strong point, although a little one, is the use throughout the car of standard threads and standard nuts, interchangeability and ready replacement being thus secured. This extends even to the wheels, all four of which are interchangeable.

RAPID: Rapid Motor Vehicle Company, Pontiac, Mich.—The largest, most complete and most interesting exhibit of commercial cars is that of the Rapid Motor Vehicle Company. Beginning with the new five-ton truck chassis and ending with the motor propelled chemical wagon, each separate car is of absorbing interest to any one vitally interested in these work vehicles.

The five-ton truck has many interesting new features. Among these are the use of the Hedgeland equalizer in place of a hit-or-miss differential, the telper spring above the rear axle, which only comes into play after about three tons of load have been put on, the sprags attached to the rear axle and operated by cables from the dashboard, the extra large tubular rear axle 4 1-4 inches in diameter, etc. The truck is built very heavy throughout, more so than its rating of five tons would warrant, so it is not surprising to learn that the factory have used it for weeks at a time with eight-ton loads.

Other exhibits are a very neat ambulance finished in white, a one-ton delivery, one and a half ton stake truck, one and a half ton standard chassis, twelve and twenty passenger sight-seeing cars, the Glidden tour truck, and in conjunction with the Tea Tray Company of Newark, a fire department or chemical wagon. The chassis of the latter was furnished by the Rapid company, while the equipment is by the Tea Tray Company. This consists of two large forty-gallon tanks connected to a reel of 3-4-inch hose. These tanks are arranged so that both may be used simultaneously for chemicals, both for water or one for chemicals and one for water: 250 feet of hose in 50-foot lengths is furnished

on the reel. In addition, there are axes, crow bars, bell, lanterns, lockers under the three seats, a 24-foot extension ladder, four three-gallon and two or more one-gallon hand extinguishers. Indestructible steel wheels are used and the car is geared to 25 miles per hour. The capacity of 12 men is afforded by three cross seats and three steps each for two men.

RELIANCE: Reliance Motor Truck Company, Owosso, Mich.—This company, like the Logan, is an old friend under a new name, the new company having just completed and moved into a large new building in Owosso, Mich. The cars exhibited are a two and a three-ton truck, and in addition a transmission. The latter, resembling nothing quite as much as a bathtub, is of cast iron, showing the modern tendency to eliminate aluminum on power wagons. These trucks are unchanged in detail from last year, the most notable feature being the engine, which is of the two-cycle type. The majority of these trucks are sold in the Middle West, where they are doing good work.

REO: Reo Motor Car Company, Lansing, Mich.—Naturally enough the pleasure car manufacturers, who have branched out in delivery wagons or other commercial ventures, consider this a subordinate matter and give first thought to the touring and other pleasure chasses. This is very noticeable on the ground floor of the Palace, where half a dozen of the large firms, who are known to have a power wagon of some sort on their list, have carefully refrained from taking up any space to exhibit them. In this category is included the Reo Motor Car Company. The public suffers a distinct loss in not seeing the neat little delivery wagon turned out by these people. Of small capacity and correspondingly small size, the power is well adapted to the work. The narrow tread and short wheelbase allow short, quick turns with a consequent saving of time which, according to John D. Rockinghorse, is money.

SPEEDWELL: Speedwell Motor Car Company, Dayton, O.—This new firm's commercial venture was recently pictured in these columns so that none of the details or description will be repeated. At the Palace show the commercial end was not exhibited, neither a chassis nor a complete truck. The builders state, however, that the features of their successful touring cars, which are applicable to commercial work, have been utilized on this newer venture and guarantee that the power wagons turned out will be fully up to the high standard of their touring car practice.

STODDARD-DAYTON: Dayton Motor Car Company, Dayton, O.—The makers of this popular car, the Dayton Motor Car Company, have recently announced the completion of a full line of power wagons in one, three and five-ton sizes, others being added to the line as necessity arises. However, none of these were shown at the Palace, the large space on the ground floor being given over entirely to touring cars and their motive power. An excellent example of a sectioned motor was shown, the upper part of the crankcase being glass covered to show the oiling system, while other sections showed the valves in action, the working of the piston, etc.

THE MAXWELL-BRISCOE COMPANY'S FIFTH ANNUAL DINNER

It was a "full house" that attended the fifth annual dinner of the sales organization of the Maxwell-Briscoe Motor Company, held Tuesday evening at the Hotel Manhattan. If anything were needed to supply evidence of the great growth of this up-to-date company, it certainly existed in the mammoth banquet hall filled to overflowing with district managers and agents from all over the country. Of course, Benjamin Briscoe, president and general manager, modestly told about the progress of the Maxwell, and J. D. Maxwell spoke most interestingly mechanically as to things here and abroad, he having recently returned from a visit to the Paris Salon. J. W. Wellington had for his subject "Accounting;" Ernest Coler spoke about "Adver-

tising," and C. W. Kesley's subject was "The Hustlers," he being the superintendent of sales. There were other excellent talkers, including Creswell McLaughlin, an after-dinner orator of the gatling gun order, his rapid firing calling for close attention. Lee B. Durstine made an efficient toastmaster. There is another slant to a gathering like this, coming as the participants do from all over the country. When each had told his story, it was plain to be seen that New York alone is not the palm of the hand of trade activity. The Maxwell line of cars, covering as it does a type of car to fill every want, enabled the representatives of the company to deal with all sorts of people from all over the land. All America is automobile excited and the fever is spreading.

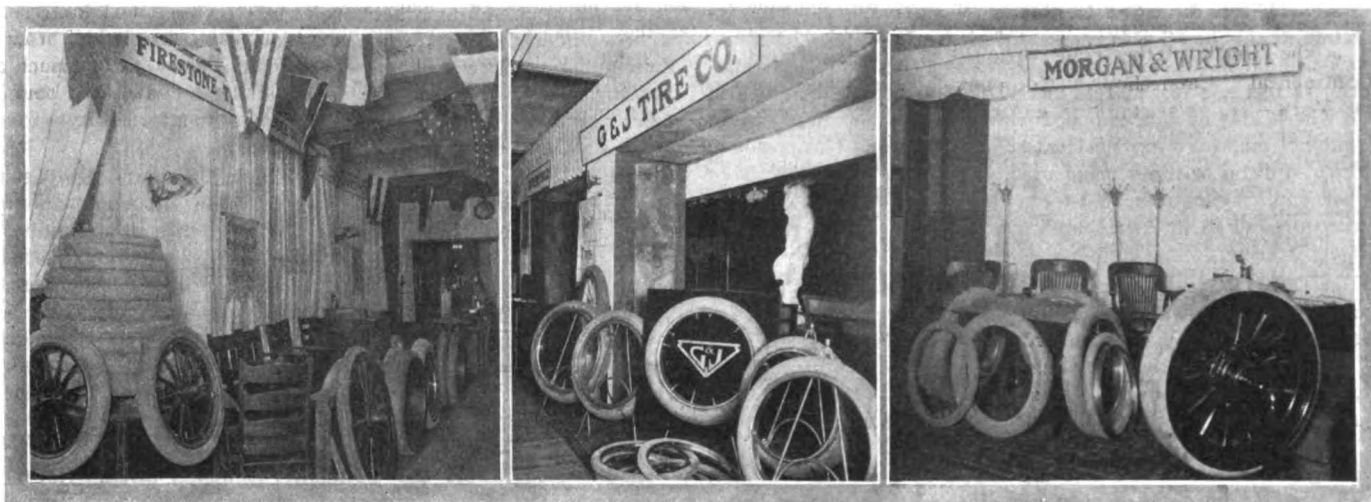

THE YEAR'S PROGRESS IN TIRE CONSTRUCTION

THE past year has doubtless been the greatest one in the history of the rubber trade, or to be more specific, in the automobile tire manufacturing business. In the automobile business every year shows progress, but this was not alone progress in that sense; it was an epochal year, a high-water mark so to speak. Following the lowest price of years for crude rubber, the past year witnessed a startling cut in prices. This cut was not made at the expense of the product, however, but was the natural result of three things, in almost every case investigated. These were: (1) the low price of the crude product mentioned above, which touched the lowest figure known in the past ten years, the same being equally true of fine up-river Para, Brazilian, and all other grades; that is, it was universal; (2) the completion of very extensive factory additions, some of which had been in the process of building for a very long time; and (3) the extreme outside pressure brought to bear upon the rubber companies by manufacturers and tire users, as a result of the hard times of the previous year and the extreme dullness in all lines of business resulting thereto.

With facilities equal to their enormous output and some natural future increase, and with improved mechanical devices installed coincident with the opening of large new buildings, it was possible to produce a better tire at a lower price.

Many and various were the improvements in factory methods which brought this about; thus in the matter of moulding or curing the complete tire the greatest improvement was manifested. This, which formerly took up three, four, and sometimes more operations, each of three to six hours' duration, is now usually completed in one operation of five to six hours. Not only does this save in time and material, but most of all the saving is in labor of handling, which is reduced to 20 or 25 per cent of its former bulk. As this is all high-priced labor, this big cut means a large amount of money as applied directly to a tire.

Notwithstanding the big cut in cost incident to superior methods of doing the work as shown above, it is now claimed that the single curing operation leaves the rubber in a superior condition

to that resulting formerly when curing took several operations.

Tubes are now made much heavier than formerly, and consequently less liable to puncture or rupture under excessive internal pressure. The paper thickness of the first bicycle tubes has gone and grown until the tube in excess of an eighth of an inch in thickness is the rule rather than the exception.

In shoes, however, the greatest progress has been made. The former trick which rubber and fabric had of getting an absolute separation from one another has now been eliminated, so that at best it is but as a memory. This happened, too, in the past with some forms of raised tread, the tread after some severe wear parting from the body of the tire. Superior methods of construction have obviated this. In shoe construction the non-skid or anti-skid treads have had a great deal of bearing on the result attained. The modern tendency has been in this direction, and no manufacturing process which did not take it into account was worth much. Even the largest tires with the heaviest beading or with the Bailey tread can be cured in a single operation with the rest of the tire.

An additional powerful influencing factor has been the matter of construction through the shape of the beading or other lower portion of the tire. This particular subject is of more interest to some than the tires themselves, and this feeling is partly responsible for the great progress made with these. They vary in size, style, types, and weight with the different inventors and the companies manufacturing them. In general it must be said that they represent a distinct stride in advance in one method of attacking the tire problem.

In conclusion one may sum up briefly the following advantages which the past year has brought to the automobile man in the way of tires: superior materials, better workmanship, more advanced methods of working the raw materials, heavier and more dependable tubes, more efficient treads on shoes either plain or for the prevention of skidding, progress in demountable tires, undoubted advances in removable rims, and, best of all, lower prices to the owner and operator.

Ajax-Grieb Rubber Company, Trenton, N. J.—This manufacturer of Ajax tires has built up a reputation, and incidentally a business, or perhaps this should be stated inversely, as a result of meeting the up-to-date "show me" tendency face to face. This was done with the guarantee proposition, which was nothing more nor less than a written guarantee for 5,000 miles of service with every tire. This guarantee was made in the full expectation of making it good, and subsequent experience with the working out of it showed the astonishingly low percentage of 2 per cent replacements. In making a business-like guarantee of this sort it was to be expected that a tire was made that was fully capable of being guaranteed, so that the buyer gets the best of it both ways; in fact, it is hard to see how he can lose. This company is distributing to its friends souvenirs in the form of an indelible pencil, whose construction re-

sembles the now-popular ink pencil very markedly. By pressing the small end of the pencil, the lead is allowed to drop out into place at the other end.

Batavia Rubber Company, Batavia, N. Y.—The new Security tread used on Batavia pneumatic tires consists of two rows of depressions extending transversely on the tread from either side of a broad central tread part, which is left plain. These depressions are three-quarters of an

inch wide and one-quarter inch deep at the tread strip, and gradually decrease to zero at the outside of the tread portion.

Continental Caoutchouc Company, New York.—At this stand is exhibited Continental ready-flated tire and the demountable rim with which these tires may be used. These tires and rims have caused no little talk and aroused any amount of interest in this solution of the tire problem. In favor of this combination it is stated that a change can be made as quickly as an ordinary tire can be inflated. Continental round tread or A C flat, guaranteed for 3,500 miles; flat-tread type course, 4,500 miles, and non-skid steel studded, 2,000 miles, are fitted on Continental demountable rims. Those desiring to equip their car with quick tire repair devices should examine these tires and rims. The carrying of tires already inflated on spare rims has done more to eliminate tire trouble and make motoring a pleasure than any other product now on the market. The complete equipment consists of the necessary rim bands and attaching devices for four wheels, also two spare rims on which tires are carried already inflated. When trouble is met with the damaged tire and its rim have only to be removed and the already inflated tire carried as a spare exchanged in its place, taking less time than to pump the tire by the ordinary method. Each equipment is guaranteed to the extent that if not perfectly satisfactory it will be replaced at no cost to the purchaser. If the mileage above mentioned is not obtained, adjustments are made on this basis.

Courtney Rubber Company, New York City.—A line of extra heavy flat tread and anti-skid tread tires are shown, as well as the inner tubes which go with these pneumatics. Considerable handwork enters into the manufacture of these tires. The Courtney anti-skid consists of a triple line of steel studs, the feature of which is that it is possible to re-tread the tires. The handwork on these tires should be worth considerable to a prospective purchaser, for the very fact of hand work being used shows that the company is anxious to make a good tire. Similarly the re-treading feature of the anti-skid shoe is one well worth considering, this being impossible with most shoes.

Dayton Rubber Manufacturing Company, Dayton, O.—The product of this company is known as the airless tire, and this name indicates the type and construction of the tire itself. It might be called a cross between a pneumatic and a solid tire, or, to be more exact, call it a cushion tire. The construction, which is that of a solid tire with internal air pockets or chambers separated by walls of very thick rubber, has been likened to a bridge, the walls forming the columns, the reinforcement on the inside between the walls to the heavy floor beams, and the tread to the flooring or roadway. The claims made for this form of tire are that no pumping is necessary

as with pneumatics, nor are punctures or blowouts possible, that they will ride as easy as air-filled tires, will not crush under rated loads, are resilient and fast, will not eat up gasoline, nor deteriorate rapidly. To substantiate these claims only the best of Para rubber and Sea Island fabric are used, cured over a metal form in a single operation, and having the integrally cured walls proportioned to the rated load.

Diamond Rubber Co., Akron, O.—In the field of tire-makers the word Diamond stands out conspicuously as symbolical of all that the name implies. Time nor money have not been spared by the Diamond Rubber Company in working toward the end that what has been the constant source of annoyance and expense to the owner of an automobile, shall be materially improved each year. The tire man has been compelled to stand much hard criticism, and no one company is doing more than the Diamond to better this situation. For the coming season the product shows more than ever the advances in tire-making, and it only needs the months of usage to prove the claims made for the new product. The owner, or the prospective owner, will do well in equipping his car for 1909 to make a thorough examination of the demountable rim designed especially for touring purposes, and the steel-studded casing as a non-skid is worthy of much commendatory criticism. Heretofore the light car owner has not given so much attention to the tire question because it has been his particular luck not to have much trouble.

Dow Tire Company, Boston, Mass.—Dow non-deflation tubes are shown. As is well known this non-deflation quality is secured by means of a flexible fabric which is incorporated in the walls of the tube. This fabric, consisting of a plastic compound made of feathers and especially prepared cement. In case of a puncture, a fibrous plug mechanically seals the hole. The tubes are, of course, especially shaped to receive this compound, the upper two-thirds of the tube being double, with a space between. It is in this space that the compound is carried. The tubes are adapted for use with any outer shoe, the

makers of it, in fact, do not make a shoe of any kind, specializing on the self-healing tubes. These weigh three times as much as the ordinary tube, but, while this sounds large, the actual additional weight is very little.

Empire Automobile Tire Company, Trenton, N. J.—These tires are made in four styles, the difference lying wholly in the tread. This is made in the old plain round tread; in a single cured Bailey tread; the favorite raised tread, which has a double thickness of rubber just in the center of the tread where the wear is greatest; and, lastly, a brand new non-skid studded tread. The latter is put on over the raised tread, and consists of a narrow band of double chrome leather with four rows of rivets through both thicknesses. The difference from most studded tires, however, lies in the rivets themselves, which have a case-hardened head for wear and a very soft, flat inner end. For Winter use and all-the-year-use on bad roads these will be the firm's leaders. In connection with their unusually heavy inner tube, this company is calling attention to the fact that very few tires are pumped up to the tire pressure which will give the proper service and is distributing tables of necessary pressures and of tire carrying capacities.

Ennis Rubber Manufacturing Company, Newark, N. J.—Although the Ennis tire has been on the market but one year, the company made an elaborate display in the Palace. It showed a line of motor car pneumatics, inner tubes, and motor cycle and bicycle tires, which it has just started in to manufacture. Although a newcomer, a vigorous and aggressive policy will be adopted and prospective buyers are assured of the loyal support of a large company, whose factory is equipped with modern machinery. More than this the oldest and best established firms cannot do.

Faultless Auto Tube Company, New York City.—This company exhibited its multi-inner tube tire in which instead of one there are four concentric inner tubes, all connected with the same valve. Ordinarily the outer tube is inflated, the three others remaining deflated within it. Should this outer tube become punctured the next outer one is inflated, and so on until all four have become punctured. The valve is such that the air can be injected into whichever one of the four inner tubes is desired.

Firestone Tire and Rubber Co., Akron, O.—In its big exhibition on the gallery floor overlooking the central space below, the salient features of the Firestone exhibit are two in number, viz.: the demountable rim and the new non-skid tread. The demountable rim may be used in connection with clincher or quick detachable tires, and consists of three parts: channel rim, locking ring, and demountable portion containing the tire. It has no narrow wedge shapes and no sharp angles so that its parts cannot rust together and make the



rim difficult to manipulate. The non-skid tread is formed by the raised oblique lettering "Firestone Non-Skid" arranged in double rows across the tread surface of the tire. It presents a great number and variety of edges and points of road contact, thus securing better anti-skid properties. This exhibit includes the motor truck tire.

Fisk Rubber Company, Chicopee Falls, Mass.—Fostering the modern desire for quick-change tire devices, this company showed and demonstrated the removable rim fitted with the heavy-car type of bolted-on tire. This was shown and demonstrated to the exclusion of the other worthy types of tires made by this company, showing that this was looked upon as the best form for the average autoist. As demonstrated in the Glidden tour the change of a tire may be made in from a minute by an expert to less than three minutes by a novice, this change being a simple matter of taking off five nuts and a ring, then replacing the tire by a new one and putting the ring and nuts back on again. This concern also calls attention to the insufficient tire pressure usually used and asks to have Fisk 5-inch tires inflated to 90 pounds front and 100 pounds rear, with other sizes in proportion.

G. & J. Tire Company, Indianapolis, Ind.—The successful business man has been mindful of the demands of the public. This company, ever alert to the requirements which would be demanded by automobilists, has taken full recognition of these demands and produced to meet them a superior article in the tire line. This line of tires is made from the highest grade of rubber and fabric, with good workmanship and on outlines that are the most essential in pneumatic tire constructions. No radical departure in construction is made for 1909. There have been improvements in mechanical processes used in the construction of the tire which have resulted in added toughness to the rubber tread. The line as it is to be shown at the Palace consists of the Standard, Clincher, Dunlop, and quick detachable clincher, all of which are furnished in either the smooth or the Bailey tread. New in the line is the Indianapolis G. & J. motorcycle-tire of molded construction, made in the shape it assumes under inflation. This tire is supplied with corrugated, basket, or Bailey treads. Another motorcycle tire feature is the butt end tube, which is known as the Indianapolis socket-joint motorcycle tube, the name being derived from the ball-and-socket manner in which the ends slip together. The feature of this tube is that it can be removed from the tube or replaced without removing the wheel from the frame.

B. F. Goodrich, Akron, O.—The wonderful increase in the factory capacity of this company bespeaks the merit of its product, the past eighteen months alone having tripled the capacity, to say nothing of previous large additions and one at present under construction. The principal

feature of the exhibit at the Palace is the quick detachable tire, which is similar in construction to the regular clincher, but designed for easy application and removal without the necessity for any tools. This is accomplished by the use of detachable ring, provided with hooked ends which engage in slots in the rim. These hooked or locking ends can be released from position in remarkably short time, freeing the ring from the rim and leaving practically a flat surface for the tire to slide over. The ring is attached or locked to the rim just as easily and quickly as it is detached, the hooked ends engaging the rim slot almost automatically and in such a way that precludes any possibility of the ring working loose.

Goodyear Tire & Rubber Company, Akron, O.—After an unusually good year, the Goodyear people "bobbed up serenely" at the Palace show with the universal rim and the detachable tire. The latter is made with non-stretching piano wire tape in the base, which has got to break before the tire can be forced off. The rim made to be used in conjunction with this tire is demonstrated and a crowd keeps the demonstrator busy all day long putting the tire on and taking it off again. The famous racing driver, Barney Oldfield, makes use exclusively of these tires and rims on all of his racing machines, because of his high regard for them. The company is distributing a folder in which an extract from the *Chicago Record-Herald* gives an interesting account of Oldfield's own description of the sensations of record-breaking drives, in which incidentally he says a good word for this tire and rim.

Hartford Rubber Works Company, Hartford, Conn.—This concern offers for public inspection its line of tires and rims with which the public already is familiar. No additions to the line have been made, but the company is pointing with pride to its quick detachable rim, which is on exhibition. This is the rim approved by the mechanical branch of the A. L. A. M., which, by the way, is largely responsible for the form. It is adaptable to the standard clincher or the Dunlop tire by simply turning over the removable ring. In addition truck tires are shown, the only change being a minor one. This is the cutting away of the extreme corner of the base along a diagonal line, which results in a better holding device, and consequently a better cross compression. The tread is unchanged.

Healy Leather Tire Company, New York City.—Besides its well-known leather tire from which they take the name and which has attained considerable fame both here and abroad, this company shows its demountable wheel. This is very different from the ordinary run of demountables in that when removed the ends of the spokes are left bare and exposed. A tenon fits onto each spoke and an anchoring lock bolts to this and holds the rim firmly. Although there is thus a bolt for every spoke,

a special bit is provided for taking them off, and it is claimed that the complete change can be made by unskilled operators in less than three minutes.

Irving Snell, Little Falls, N. Y.—This maker exhibits a resilient cushion tire with a non-skid tread. The tire is made up of several layers of rubber mounted upon the felloe in such a manner as to slide laterally a short distance. This cushioning effect is increased by a number of holes, which extend through the length of the rubber. V-shaped ridges on the circumference or tread serve as cleats, increasing the traction, and act to prevent skidding. Air may circulate through between the ridges, and for this reason the additional claim is made that they raise less dust than other solid or cushion tires.

Michelin Tire Company, Milltown, N. J.—A number of tire accessories are shown, including the newest Michelin valve spreader, which is a little device that makes the use of security bolts and lugs unnecessary with clincher shoes. Of course, these were incidental to the large line of both commercial and racing types of demountable rims, and the full line of tires, including plain, flat tread, and non-skid. On the racing rim the tire is carried by a split ring, the ends of which are united by a turnbuckle. To remove all that is necessary is to turn this turnbuckle enough to allow the ends of the rim to slip off.

Morgan & Wright, Detroit, Mich.—Two new tires and a quick detachable rim are shown. The new rim is operated by snapping or unsnapping a locking ring, the only tool required being a small screwdriver or a sharp-pointed file, which can be used as a pry. The security of the fastening is entirely independent of the inflation of the tire. A heavy flat tread tire mounted on the standing universal quick detachable rim is in addition to the line. It has extra breadth and thickness in the tread. In addition, a new motorcycle tire is featured. This has a fastening arrangement of the clincher type, not the usual G. & J. clincher however, and is made with both non-skid and plain treads. A line of heavy truck tires are also shown, these being of the double side-wire fastening type, the twin tires having four wires.

Motz Clincher Tire and Rubber Company, Akron, O.—Besides showing the regular line of cushion and truck tires, this exhibit has two new tires. One is known as the special Long-Distance Electric and the other the Motor Buggy tire. The special long-distance electric is made on the order of the cushion tires except that the concave tread is cut deeper and the tread is scalloped in order to increase traction and eliminate skidding. The openings on the sides of the tire are made more than twice as large as formerly, thus allowing a greater range of flexibility and increased resilience. The motor buggy tire is of a clincher type. The tire is held in the rim by steel cross-bars placed slantwise in the

base of the tire, the ends of the bars extending under the flanges of the rim. One of the great features of the tire is that it can be applied by anyone, and should any portion of the tire become injured, the injured part can be cut out and a new piece put in without disturbing the rest of the tire.

Pennsylvania Rubber Company, Jeanette, Pa.—This concern features its non-skid tires for winter or rough use and produces figures to prove these more economical than plain tires, these figures having been deduced from actual practice. These are a steel studded tire with a leather tread, in which the studs are imbedded. The studs are of case-hardened steel and are set in a special process leather strip which encircles the tire. This tough leather not only serves to hold the studs securely in place, preventing their being torn from the tread, but it also protects the tire and renders it practically puncture proof. In opposition to usual practice this company recommends that at

Samson Leather Tire Company, New York City.—This is the well-known leather tire protector which may be applied to any tire. It consists of a leather tire cover, having an extra leather tread, to which steel non-skidding studs are attached, and an additional leather strip to be placed between the protectors and the tire to protect the latter from the ends of the rivets. This strip and the cover should be vulcanized on the tire to get the best results.

Swinehart Clincher Tire and Rubber Company, Akron, O.—Featured at this stand is the Swinehart rim attachment which permits of the fitting of Swinehart cushion tires without disturbing the original rim equipment or changing the road appearance of the car. It is possible, with this attachment, to use one or more cushion tires in connection with the pneumatics on the same car. In making the attachment, eight bolts come into play, which are placed on top of the rim and on the wheel,

Auto Improvement Company, New York City.—This concern exhibited a new demountable rim in which the clincher rim on the tire can be utilized in the demountable. On the wheel felloe is attached a thick metal rim with four cross-slots cut in it, each approximately one-quarter inch deep, and varying from one and one-half inch wide at the inner side of the rim to nearly two inches at the outer side. Into each of these slots fits a cross steel piece, formed clincher style, and riveted to the inner side of the clincher rim carrying the tire. In one side of this is a semi-circular recess, into which a locking cam carried in the wheel felloe enters. This cam is mounted eccentrically on the outer end of a radial bolt passing through the wheel felloe, and which can be locked in position by the nut on the inner end of the bolt. In removing the rim the four cams have to be oscillated back out of the recesses in the clincher rim cross pieces, after which the rim can be pulled off.

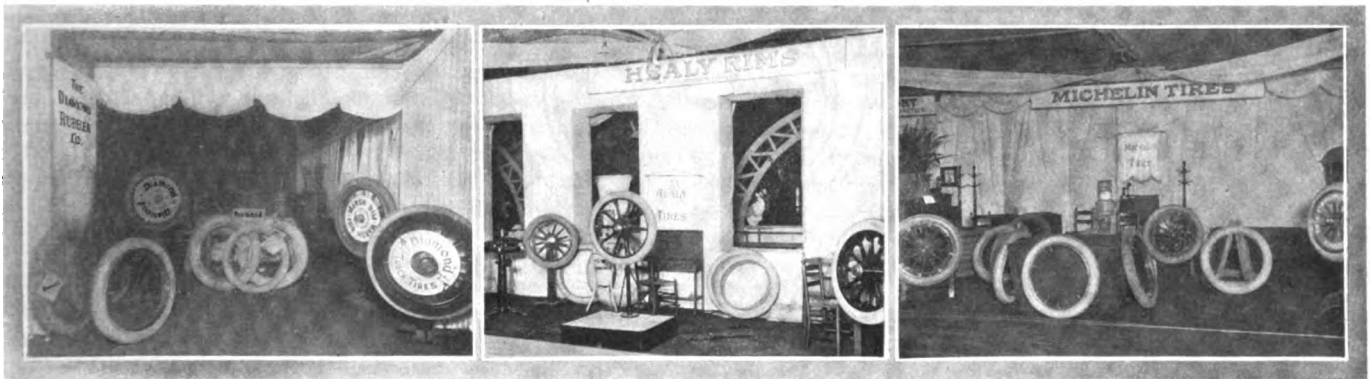

least one front wheel be equipped with non-skids besides both the rears, particularly if the car is used on city streets with asphalt pavement.

Pneu l'Electric Company, New York City.—This firm exhibits a full line of electric pneumatic tires, which are made in all of the standard metric sizes with either plain or other treads, as desired. In this age of specialization it is not strange to find a company thus making tires for one special branch of the industry. At any rate, the purchaser is assured of a product especially adapted to the work it has to do.

Republic Rubber Co., New York City.—One of the big interests for the people who attend seem to be the various non-skid devices. The Republic Company shows one that draws the crowd all right in the Staggard tread. This is a series of elongated projections, about two inches long and a half inch interval between. Six rows of these encircle the tread of the tire. Casings in this style may be had from 28 by 3 to 36 by 5, and in metric sizes from 910 by 90 to 935 by 135. In addition, the flat tread corrugated and plain clincher types are shown, the former having about seven small corrugations in the smaller sizes, and only two deep grooves in the 4½ and 5 sizes.

after which the tire rims are thrown into position. The bolts are then easily slipped around in proper position and tightened with a wrench, which securely clamps the rim and tire to the wheel. This attachment permits of it being utilized as a spare wheel.

A full line of these solid tires is shown in the sizes varying from the smallest and lightest adapted to delivery wagons and similar cars up to the big heavy twin tires for the heaviest loads, one ten-ton truck photograph being displayed. These latter are called demountable and detachable, because of the construction of the rims, which allow both features, the average time for demounting being less than twenty minutes.

TIRE ACCESSORIES.

Allen Auto Specialty Company, New York City.—At this exhibit is displayed a line of tire holders and tire covers. The latter are of fabric and completely encircle the spare tire carried, while the former are metal tire iron for fastening these covers with the enclosed tire to the car. The tire holders are made large enough for tires with demountable rims, spare wheels, or anything in the wheel or tire line, either with or without attached rims.

Auto Tire Inflating Company, New York City.—A feature of this inflating bottle for tires is the regulating valve in which a brass cup with an end of hard rubber guards the small exit for the inflating gas. This cap or valve is held seated through a stiff steel coil spring, on top of which is a small cap, on which bears the controlling screw. The use of a hard rubber valve and a spring medium between the valve and adjusting screw is to avoid destruction of the valve seat, and to eliminate any cringing that might otherwise occur.

Brown Company, Syracuse, N. Y.—In these days when the average motorist realizes the importance of keeping his tires pumped hard the necessity for having a positive method of accurately determining the pounds inflation is apparent. Figuring this way, the Brown Company is introducing for the first time a tire pressure indicator which is simple in operation. To determine the tire pressure this device is screwed on the valve stem of the tire and by the contact of the valve plunger with a similar device in the post of the indicator the air is allowed to pass into the gauge. At the same time, the pump can be applied to the other end of the indicator, and every pound forced into this registers itself on the gauge.

Garage Equipment Co., Milwaukee, Wis.—In the way of anti-skid devices, the Garage Equipment Co. calls attention to its emergency mud hooks, which are made in two styles, one for pneumatics and the other for solids. These mud hooks, as the name indicates, are for use on roads where the mud is deep or there is lots of sand. One hook goes on each wheel, and there is a projecting flange which digs into the dirt and gives it the desired traction. These hooks are made of malleable iron, weight five pounds per set, and will fit any tire from 3½ to 6 inches. Usually the projecting lug is two inches, but where the clearance between the fender and the tire is not enough to accommodate a large lug, a one-inch lug is provided. The mud hook designed for use on solid tires has a lug which projects only three-sixteenths of an inch beyond the tire. From four to six on each wheel are recommended when solid tires are used.

Gilbert Mfg. Co., New Haven, Conn.—One of the new Gilbert tire cases is of the buttoned or glove fastener type, with waterproofing flap, in which the glove fasteners are on the side of the case instead of on the inner face. The weather proofing flap is a semicircular flap dropping over the upper half of the joint only, the cover on the lower half overlapping as shingles on a roof and eliminating the necessity of the flap. Other new parts for this year by this company are pocket tool case to fit the hip pocket, gas tank key, single and dual tire clamps for running boards and magneto covers.

Newmastic Tire Company, New York City.—This firm does not make, so does not show, a tire, but rather a tire-filling compound which has been on the market for several years. An improvement has been made in the past year, however, by increasing the glue contents of this mixture to 10 per cent. and a similar increase in the glycerine, with the result that more resiliency is obtained. The compound is not as heavy as would be supposed, a 36 by 4 tire when filled weighing but 35 pounds.

C. A. Shaler, Waupun, Wis.—All who have had experience with pneumatic tires realize that anything which tends to keep them in good condition will prolong their life to a marked degree. One of the greatest foes of tires are the sharp stones, etc., which cut holes in the casings regardless of the quality of the tire, and make disastrous blowouts possible. The vulcanizer designed especially for autoists by C. A. Shaler is of such merit that many disagreeable moments can easily be avoided by its use. It is the work of only a few spare minutes to take a look at the tires, and by the use of this appliance heal up all wounds to the casings so effectively that it would be hard to find where the hole had been. In the matter of patches it is equally good, and the work of only fifteen minutes to put the tube in condition.

J. H. Sager Company, Rochester, N. Y.—This firm has been aiming at producing a demountable rim both simple and strong which can be quickly detached or attached by even the novice. The rim which is shown at the show for the first time covers these points and will undoubtedly prove a valuable asset in the matter of quick and comparatively easy tire repairs. Any ordinary clincher rim is used, and the tire with its rim is reversible; that is, it may be put on either way as the beveled surfaces (B) are the same. A band (C) having one beveled surface extending inward is shrunk and otherwise secured to the felloe of the wheel, and the only loose part is the beveled ring (A). The hook bolts do not have to be removed, but simply loosened, when they will easily turn down out of the way. The ring (A)

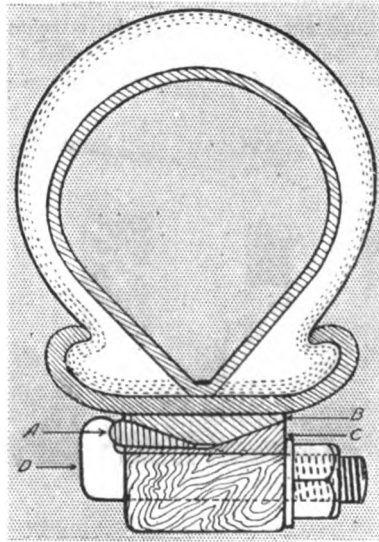

Section Sager Demountable Rim.

will take up any wear which might occur, and as it is split in one place, it immediately loosens up when the tension is taken off the bolt hooks, allowing the rim to slip away easily.

Seamless Rubber Company, New Haven, Conn.—The value of good inner tubes is not easily estimated, and having been actively engaged in the manufacture of rubber goods for nearly a third of a century, this concern enters the automobile world with a supply of inner tubes, gloves, patches, etc., in which are incorporated many ideas that have proved successful for years. The tubes are supplied for any standard make of casings.

Standard Leather Washer Mfg. Co., Newark, N. J.—This exhibit consists of leather tire bands of various kinds and the new Maison Gris tire pump. The tire pump is built to produce 100 pounds pressure in the tire without much labor. The Blanco band consists of a strip of rawhide tanned by a special process. It is 5-32 inch thick and is claimed to be free from grease and oil usually associated with rawhide. The Everwear tire band is a strip of four ply extra heavy woven canvas

1-8 inch thick, to which is cemented with waterproof cement a layer of mechanical mineral tanned leather. The band is then studded with hard steel rivets. The finished band is 3-16 inch thick over all. The studs projecting about 1-8 inch and fitted with heavy brass eyelets and slotted to permit close adjustment to the shoe.

Travers Blowout Patch Company, New York City.—This is a quick repair device, consisting of a patch made of a rubber and fabric combination which fits inside the shoe of the damaged tire and has flanges on each side which fit between the tire shoe and the rim. A friction surface on the patch prevents it from creeping around out of place. This is a very neat, quickly applied, and, therefore, very useful, besides taking up small space in the tool kit.

Weed Chain Tire Grip Co., New York City.—The necessity for providing automobile tires with some means to prevent slipping in times of rain, ice, or snow is universally recognized, and the presence of a set of Weed chains under the seat has many times saved the day. In the cities, where asphalt becomes really dangerous after the slightest wetting, some means to prevent skidding is an absolute requirement. Weed chains do the trick, and the cost of the chains is small indeed in comparison with the cost of possible accidents, to say nothing of the fact that it is "insurance" to have Weed chains in the kit.

The Leather Tire Goods Company, Upper Newton Falls, Mass., besides a full line of Woodworth adjustable treads, special and self-adjusting, show the "Kant-Skid," a series of small studded strips of leather encircling the tire and joined together around the inside and outside by a series of steel rings. These and the ends of the strips have an ingenious fastening device, which allows the removal or insertion of any strip or ring without disturbing the others. This consists of a pair of what are called "sister hooks," which are two hooks turned opposite ways and held close together by the natural spring in the steel wire. To remove or insert another ring, slip it between the two sisters and turn through 90 degrees when each hook will slip through the hole, but in opposite directions.

York Auto Wheel Co., York, Pa.—The device to be exhibited by this concern is styled a resilient wheel, but it comes in the demountable class. The tire inflated is fastened to an iron rim which is split and which has a turnbuckle arrangement in it. On the turnbuckle is a right and left-hand screw, by turning which the rim can be expanded enough to allow the flange on the inside of the rim to seat itself. To protect any possible weakness at this point the inventor runs a steel brace around the entire circumference of one side of the wheel. On the other there is a small section of steel which clamps into the opening where the turnbuckle is located.

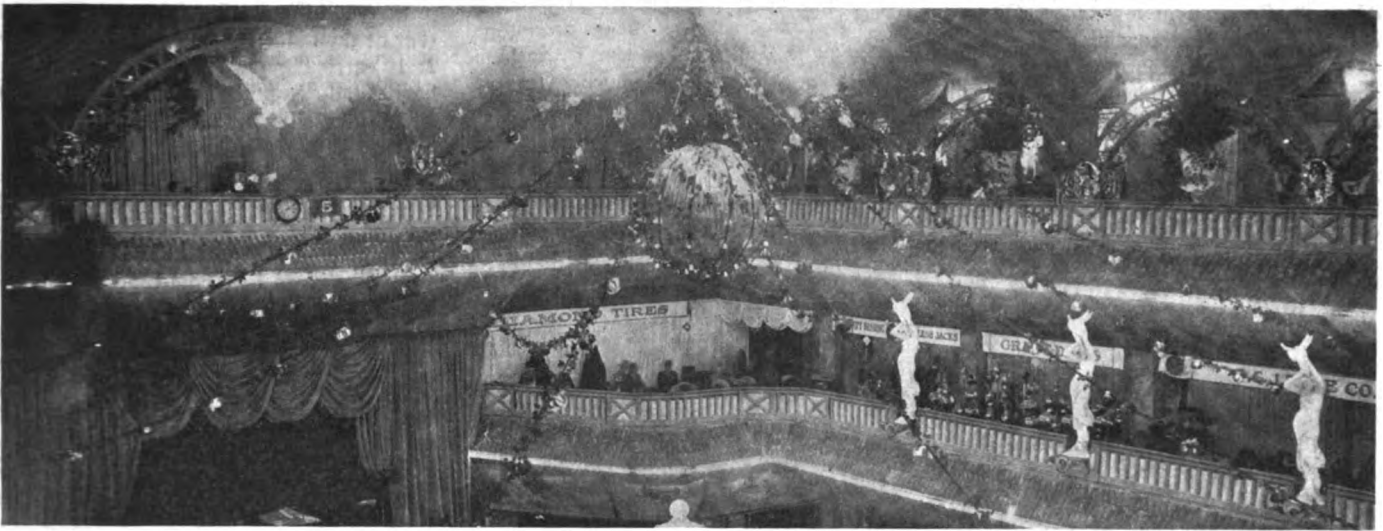

IGNITION EXHIBITS AT THE GRAND CENTRAL PALACE

By G. H. GODLEY.

ANY description of ignition accessories must of necessity begin with the magneto, for the almost universal adoption of this device is one of the noteworthy features of the show. Last year the specifications read "fitted for magneto" or "magneto extra." This year in most cases the magneto is taken for granted, and forms an integral part of the motor. However, there still remains much diversity of opinion as to the best system, and as to the desirability of an auxiliary battery. The low-tension make-and-break still holds its own on a few of the old guard, notably Premier, Gaeth and the larger Fiat models, and may receive a new lease of life from the invention of magnetic plugs, as used on the Mercedes.

Numerically the high-tension users are far in the lead. These in turn are divided between the high-tension, properly so-called, and the low-tension jump spark with separate coil. The former, in which the armature carries both primary and secondary windings, is entirely self contained and permits a simpler wiring system; usually there is but one secondary cable to each spark plug, and a primary wire to the switch. The separate coil system, on the other hand, is probably simpler in actual construction, and may more easily be fitted with an auxiliary battery, when this is

desired. In short, both types have their advantages and disadvantages, and the choice between them must in most cases rest simply on the excellence of design and workmanship. There may be seen, however, several interesting attempts to compromise between the two types, with the view of securing the best possible combination of the necessary elements.

The present popularity of magneto ignition is one of the best possible proofs of the generally excellent quality of the different machines. When they were first introduced the public had little confidence in them, and they were usually regarded as adapted only to cars that could have the constant attendance of an expert electrician. A complete battery system was always demanded in addition, separate even to the spark plugs. Although some automobile manufacturers still use the two entirely separate systems, this seems only a desire to give the customer his money's worth, rather than a sign of distrust of the magneto. This increased confidence is certainly warranted by the advances made in magneto construction. Noticeable improvements are the innumerable slight changes in the arrangement of the terminals, the heavier insulation, special alloys at the contact points and stronger and more permanent magnets.

J. S. Bretz Company, New York City.—The U. & H. magneto shown by this company is another example of the true high-tension type. The magneto itself follows standard designs, with such refinements as the makers have found desirable; its remarkable feature is the starting device, which does away with the rapid spinning of the crank often necessary to secure a spark. When the driving pinion of the magneto is rotated at a low speed the armature and timing devices at first remain stationary, and instead the driving force is utilized to wind up a coil spring. At the desired point the spring is tripped into action, and rotates the armature through the field of the magnets with a quick jerk, thus securing the maximum spark. As the speed increases the device is thrown out of action and the drive becomes direct and constant. A more detailed description of this device, with illustrations, appeared in a recent issue of *THE AUTOMOBILE*.

Bosch Magneto Company, New York City.—This company shows a very complete line of all types, but unquestionably the feature of their exhibit is the new

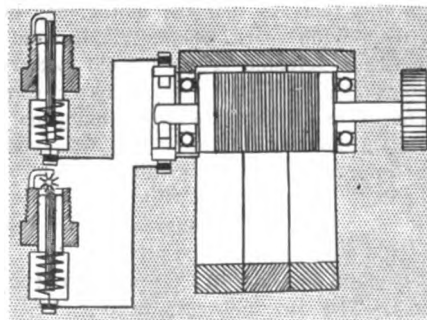

Sectional Plan Bosch Magneto.

magnetic make-and-break spark plug, on the Honold system. The magneto used with this system is a low-tension type with a primary timer sending the current to each plug in turn. The passage of the

current through a small coil in the body of the plug forms a magnetic field which attracts the movable electrode of the make-and-break device, causing it to spring away from the stationary electrode and break the circuit. A hot low-tension spark immediately leaps between them. The wiring consists of a primary connection to each plug and one to the switch—not quite as simple, it is true, as the single wire and bus-bar of the usual make-and-break system; but it has the great advantage that no moving parts must pass through the cylinder wall, and there are no cams or tappets required on the motor. In addition to this specialty the exhibit comprises the standard low-tension make-and-break and high-tension types familiar to the industry. The Bosch jump spark magnetos are all of the true high-tension type, with double armature windings, and may be had to run at either camshaft or crankshaft speed. There is also shown a compact coil and switch to be used.

Herz & Company, New York City.—The Herz magneto, according to the makers, is an attempt to secure as close an approach as possible to ideal efficiency, and with this end in view they have embodied a number of interesting features. The magnet system consists of several flat, round steel plates clamped together to form a cylindrical body, through which is then bored the "tunnel" for the armature. There are no separate pole pieces, and thus no breaks or joints in the magnetic circuit. This idea is carried still farther by finishing the "tunnel" and the armature itself with such accuracy that they move within four one-thousandths of an inch of one another in perfect freedom. The armature carries both primary and secondary windings, with the condenser arranged in a cylindrical case on one end, and the contact-breaker, which forms a separate unit, just beyond. The single-cylinder magneto weighs but $4\frac{1}{4}$ pounds and the four-cylinder machine 8 pounds.

Hess-Bright Manufacturing Company, Philadelphia, Pa.—One of the most ingenious attempts to combine the advantages of the high-tension and low-tension jump spark magnetos may be seen in the Hess-Bright machine, recently brought out by the well-known manufacturers of ball bearings. Strictly, this magneto belongs to the low-tension group, but its appearance by no means indicates this fact. The armature carries a single primary winding, but the coil, instead of being housed in a separate case on the dash, is made very small and compact and inserted in the arch of the magnets, directly above the armature. This eliminates at one stroke all external primary connections, and gives the system the neatness and compactness of the true high-tension. Another feature is the method of advancing and retarding the spark. The armature is connected to the driving shaft through a spirally grooved sleeve, which may be slid back and forth to set the armature either ahead of or behind its drive. The contact-breaker and distributor of course move with the armature. In this way a change of as much as 60 degrees may be obtained with no variation in the current induced. The condenser is unusually large, and the armature shaft runs on H-B bearings specially designed for magneto use, in which an attempt is made to afford the maximum simplicity, coupled with the longevity of the regular types of H-B ball bearings.

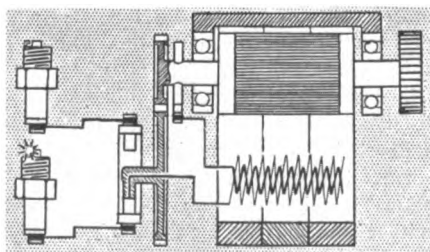

Section Hess-Bright Magneto.

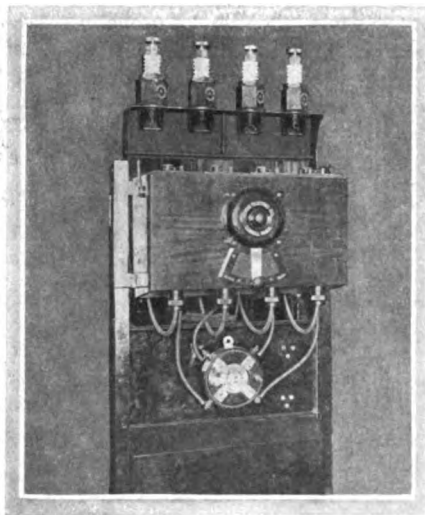

Helnze Spark Coil Exhibit.

Heinze Electric Company, Lowell, Mass.—To its line of spark coils and other ignition apparatus this company has recently added a magneto. This device, unlike the majority of magnetos exhibited, makes no attempt to concentrate in itself a complete ignition system, but simply takes the place of a battery. It generates a low-tension current and operates through the usual timer and vibrating spark coils. The magneto is small and compact, being in the shape of a cylinder with the driving pinion on the axis at one end, and the terminals at the other. It sells at an unusually low price.

Lavalette & Company, New York City.—Prominent among the types which make use of an entirely separate coil is the Eismann-Lavalette, a French device which is included as standard equipment on a number of both foreign and American cars. The coil box may be mounted on either the front or rear side of the dash, according to the preference of the user. The advantage claimed for this construction is that, there being no especial limitation on the space occupied by the coil, the insulation may be made very heavy, thus minimizing the danger of a short circuit. The auxiliary battery is regularly included with this type, so that the motor may be started on the spark whenever this would have been possible with the old battery system alone. The battery may be connected in two different ways, forming more or less a separate system; it may either use the timer and coil of the magneto, or be provided with a separate coil and timer, in both cases using the magneto distributor and the same set of spark plugs.

Pittsfield Spark Coil Company, Dalton, Mass.—The Pittsfield magneto makes a wide departure from usual designs and is rather difficult to classify, but it seems to have more of the characteristics of the true high-tension type. The armature consists of a simple laminated inductor, with no winding whatever. What would otherwise be a double armature winding, both

primary and secondary, is placed to the rear of the inductor and remains stationary. It is carried by two steel bars projecting horizontally from the poles of the magnets, and its core is included in the magnetic circuit. This winding or coil forms a separate unit and may be easily removed upon taking off the back cover of the machine. The circuit-breaker is mounted between the armature and the stationary coil. There are four pole pieces instead of two, these being arranged in the form of a sleeve about the armature. As a result the magneto gives four impulses of current to each revolution, and must be driven at camshaft speed. This makes it possible to mount the distributor directly on the front end of the armature shaft, dispensing with the usual secondary shaft and half-time gears. Timing is effected by shifting the pole pieces.

Remy Electric Company, Anderson, Ind.—Remy is an adherent of the standard low-tension type with separate coil. However, an interesting change in the construction of the magneto itself may be noted. The winding of the armature is stationary and imbedded in the pole pieces of the magnets, and the rotating part or inductor is a simple forging mounted on the driving shaft. This does away with moving contacts in the primary circuit—a frequent source of trouble. It is claimed that the wave outline of the current shows a very abrupt rise and fall, with an almost flat top, permitting a considerable change in timing at the same strength of current. The auxiliary battery system which is regularly used acts through the magneto timer, coil and distributor. The coil, which is carried in a neat box on the dash, also contains the switch and a push button for starting on the spark.

C. F. Splittdorf & Company, 1679 Broadway, New York City.—After an unsuccessful experiment with the high-tension magneto, the Splittdorf company turned to the separate coil type, and are showing a complete line of these machines in addition to their well-known spark coils, plugs and timers. Their magneto is adapted for the use of an auxiliary battery, but this is not needed except for starting on the spark, as the magneto itself gives a sure spark at speeds as low as 40 r.p.m. To demonstrate this, their exhibit included a magneto fitted with a crank that could be turned by hand, connected to a set of spark plugs; a very slow turn of the crank was sufficient to produce vigorous sparks.

Wheeler & Schebler, Indianapolis, Ind.—The Wheeler & Schebler magneto is intended simply to take the place of the battery, and acts through the usual separate timer, and vibrating coils, or a single coil and distributor may be used. Its rotation need not be synchronous with that of the motor, so that it may be driven either by gear, friction or belt. The speed is about three times that of the motor. Unlike most machines of this type, it requires no gov-

error. Among the advantages claimed are the absence of wound rotators and the mounting of the shaft on annular ball bearings, the importance of which cannot be overestimated, in view of the location.

Witherbee Igniter Company, New York City.—The Volta magneto marketed by this company belongs to the high-tension type and is entirely self-contained. The armature is of the standard H-section,

of gray iron, and revolves between two pole pieces of the same metal attached to the magnets. The windings are carefully arranged and insulated to prevent short-circuiting, which is an important matter.

THOSE WHO WERE EXHIBITING BATTERIES

THE sudden wave of popularity of the magneto does not appear to have injured the business of the battery makers to any extent, but rather has stimulated them to make every possible improvement and secure every advantage which the battery possesses over its rival. In numbers the storage battery has the advantage, but the dry cell has received a considerable

impulse through recent improvements in timer and coil construction, reducing the consumption of current. Most of the storage batteries exhibited show that the maker has taken unusual care to prevent creeping of the electrolyte and corrosion of the terminals, with the gratifying result that this branch of the ignition field will be better taken care of than ever.

Electric Storage Battery Company, Philadelphia, Pa.—This company's "Exide" storage battery for ignition purposes was first placed on the market in 1903, and is thus one of the pioneers in this line. Improvements for 1909 include a new terminal post designed to prevent creeping of the electrolyte, the reinforcement of the plates at the points where they rest on the ribs at the bottom of the jars, and the thickening of the separators. But perhaps the most welcome innovation will be the "duplex" model, which contains, in addition to the three standard cells, three small ones to act as a reserve. The principle is like that of the reserve supply gasoline tank. The additional cells increase the size of the battery case but little, and have a capacity of about five amperes, amply enough in case of accident to take the car to the nearest charging station.

Federal Manufacturing Company, Lowell, Mass.—One of the features of the Rex storage battery manufactured by this company is the "triple armored" casing, which consists of a quartered oak box on the outside, next a lining of shock-absorbing, acid-proof material and finally the hard rubber jar, the whole cemented together. No brass or iron screws or bolts are used, so that there is nothing to be corroded by the acid. Each cell is enclosed by an individual cover.

Geiszler Brothers, New York City.—The Geiszler product is known as the "non-sulphating" storage battery, as the makers claim that by a special chemical treatment of the active material this trouble is absolutely precluded. No injury results from leaving the batteries discharged or without recharging for any length of time. The separate compartments are sealed by an inner hard rubber cover and a thick layer of cement, insuring both acid and watertight construction. Corrosion has been eliminated by silver-plating the screws of the terminal binding posts.

General Storage Battery Company, Boonton, N. J.—It is claimed that the grids of the Bijur storage battery, manufactured by this concern, are 40 per cent. lead and 60 per cent. active material. The positives are made twice as thick as the negatives, and the mud space is of double the usual capacity. The battery is fitted with a master cover which conceals all the metal parts, leaving none exposed.

Marko Storage Battery Company, Brooklyn, N. Y.—The grids of the Marko batteries are treated by a special process which is claimed to prevent shedding and disintegration; they are also made extra strong to avoid buckling. The battery is provided with a master cover which conceals all interior connections, only the main terminals and the vents projecting.

National Battery Company, Buffalo, N. Y.—Although most of this company's product consists of large batteries for electric vehicles, they have brought out a specially designed battery of suitable size and construction for ignition purposes. The positive grids are strengthened by solid vertical and horizontal cross-bars; the negatives are designed to allow for shrinkage, so that when this takes place the active material is drawn more closely around the projections on its surface, with the extensive experience gained in storage battery work.

Westchester Appliance Company, New York City.—The dry batteries manufactured by this concern are especially designed for automobile ignition. Long life and great recuperative power are obtained by the use of only the best materials. The electrolyte is so balanced that there is no possibility of short circuit or polarization.

Witherbee Igniter Company, New York City.—This company exhibits its well known storage batteries with the "busy bee" trade mark. The former models are retained practically without change, but a new "Witherbee Jr." battery has also been brought out in response to the demand for a high-class battery at a lower price. The wood case is in bog oak and the metal parts are finished in black acid-proof lacquer.

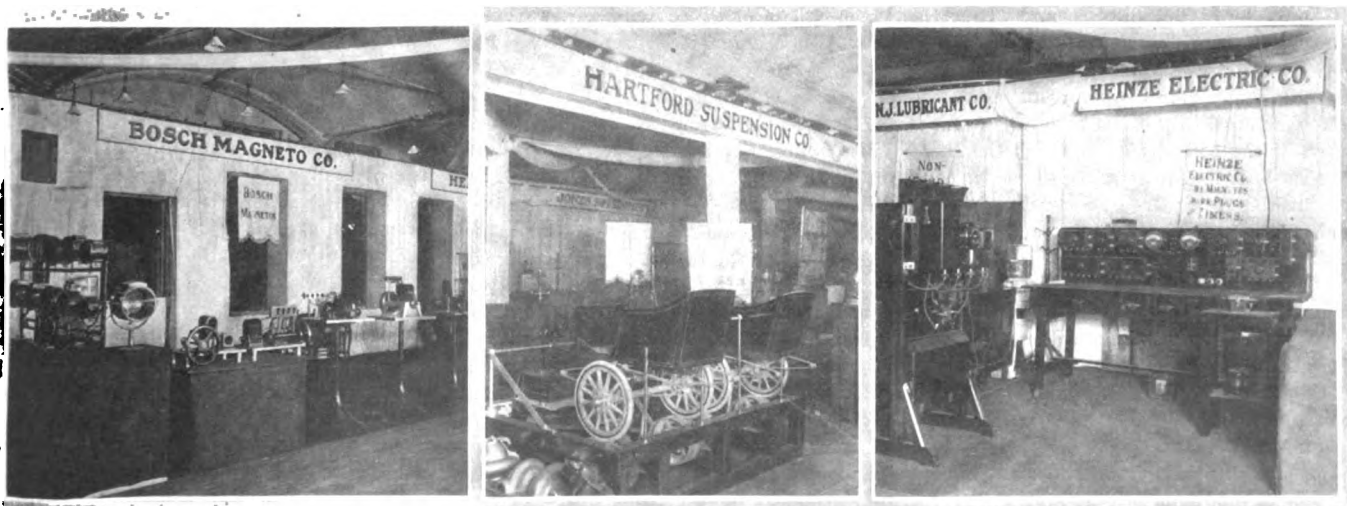

IN THE LINE OF TIMERS AND COILS.

AS nearly all companies that make timers or coils make both, these two components naturally group themselves together. The coil makers have often said that they were forced to make timers in self-protection, on account of the uneconomical operation of the original designs. Whatever truth there may be in this assertion, it is undoubtedly to the advantage of the industry that the same company should manufacture all the necessary accessories in any given line, so that these may be designed to act in harmony with each other and form a homogeneous sys-

tem. The most noticeable improvement in timer construction is in the greater solidity and stability of the new devices. Ball bearings are used in many cases, and a firm support is always provided. In the line of coils, the unit construction is now universal, although this may be changed by the recent announcement of a basic patent on this design. This is a question that cannot be settled with any degree of certainty until the attitude of the makers is known. As to what they will do, and when, is a matter that will have to bide its time.

Atwater-Kent Manufacturing Works, Philadelphia, Pa.—The Atwater-Kent "spark generator" is unique in that it combines in itself timer, coil and distributor. It is one of the few devices operated exclusively by battery current that seem to be able to resist the advance of the magneto. The design is such as to obtain the highest possible efficiency and economy in current consumption, so that the ignition of a four-cylinder car may be effected by a single set of dry batteries. But one spark is produced for the ignition of each cylinder, and the duration of the contact is as short as possible. In this way it is claimed that a mileage of 1,500 to 2,000 miles can be obtained on six dry cells.

The Autocoil Company, Jersey City, N. J.—The Autocoil Company shows their new battery-saving timer, which is claimed to double the life of a set of batteries. The length of contact usually found necessary to insure firing under all conditions is about 45 degrees, and most timers are designed on this basis. For ordinary touring, however, this company believes that 15 degrees of contact is sufficient. Accordingly the Autocoil timers are made for 15 degrees contact in normal position, but by means of a foot lever the contact can be increased to 45 degrees for high-speed work. This end is attained by the use of a second set of contact plungers—a feature which in itself would secure additional certainty of firing. Autocoil spark coils are listed in the usual models, with or without kick switch and ammeter.

Connecticut Telephone and Electric Company, Meriden, Conn.—This company exhibits its standard line of coils, for which great economy of current consumption is claimed. It has also brought out a timer, of the roller type, in which the shaft runs on a double row of balls, one on each side of the roller arm. Special swivelling connections are fitted. Another addition to the line is a high-tension distributor and a coil specially designed for use in connection with it.

Federal Manufacturing Company, Lowell, Mass.—The feature of the Federal spark coils is the "torsional" vibrator, which, it is said, enables the coil to work on one-tenth of an ampere. The vibrator points are of iridio-platinum, much harder than pure platinum. The unit coil cases are of hard rubber instead of wood, so

that they cannot swell or warp and are practically indestructible. The secondary coils are wound in layers with insulation between each layer, obviating any possibility of leakage. The vibrator cannot be thrown out of its working range by any possible misadjustment.

Heinze Electric Company, Lowell, Mass.—The standard models of Heinze coils may be seen at this exhibit, and also the latest type of timer. This has a wipe contact, secured by a steel arm passing over the upper surface of a fiber disk, from which project the heads of hardened steel

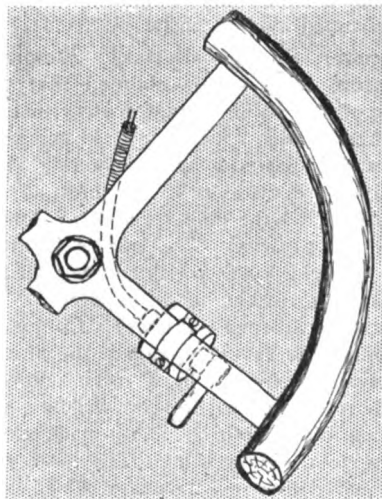

Connecticut Steering Wheel Switch.

screws connected to the binding posts. Their coil is provided with a new type of kick switch, actuated by a projecting lever of sufficient size to be easily thrown over by the driver's foot.

Herz & Company, New York City.—This company holds the agency for two well-known French coils, the Gianoli and the Guenet. They still make the familiar snap-off and "tangent" timers and their high-tension distributor, in which all contacts are between hardened tool steel, with shafts running on ball bearings. The distributor is provided with swivelling ball-joint terminals for all high-tension wires.

Kokomo Electric Company, Kokomo, Ind.—The Kokomo Electric Company manufactures the Kingston line of ignition specialties, among which is a new coil with the terminals on the back side. The terminal posts are extended sufficiently to be

flush with the front side of the dash. In this position they are unaffected by dirt or moisture, and a considerable amount of cable is saved. The company also makes a neat and compact roller-contact timer.

Monitor Manufacturing Company, Boston, Mass.—Bemus timers and Monitor distributors are shown at this exhibit. The former device retains its ball contact pieces, but for the ball center contact of former models a conical roller has been substituted. As this roller touches in turn the outer ball contacts, these are rotated in all directions, and whatever wear may take place is thus equalized. A special ground connection from the roller is provided, so that the current does not have to pass through a bearing of more or less resistance. The shaft, of course, runs on ball bearings.

National Coil Company, Lansing, Mich.—After a considerable period of experimenting this company has perfected a master vibrator system for multi-cylinder motors, which is said to be very simple in its adjustments and connections, and to greatly improve the running of the motor. The system consists of a single vibrator mounted on the dash, and a transforming coil for each cylinder made in unit form, preferably located near the cylinders. In all coils the insulating is of the highest grade, no paraffine being used, and the condenser capacity is very large.

Witherbee Igniter Company, New York City.—Another member of the very complete "Wico" line of ignition specialties is the spark coil. This has been designed especially to conform with the batteries, timers and plugs of this company. The timer is of the roller type, but instead of the roller touching the contacts directly, it runs in a loose steel ring. The contacts are of tool steel and project slightly, but recede as the ring passes over them. Thus a smooth path is provided for the roller, and the timer operates at all speeds without noise or wear.

PLUGS, SWITCHES, SUPPLIES.

Bosch Magneto Company, New York City.—This company has brought out a spark plug especially designed to work with their magneto. It can be provided with one, two or four electrodes, according to the work for which it is to be used.

J. H. Bunnell & Co., New York City.—There are always times when the dry cell proves its value as an emergency standby, and while it has been supplanted to a considerable extent by other forms of ignition, the number of cars which still use dry cells as their regular equipment for this essential is large, and, strange as it may seem, is increasing rather than diminishing, due to improved forms of timers and coils, which do not waste such a great proportion of the current. This company markets a dry cell that has been especially developed for auto use, and manufactures it in a square form, which increases the capacity of the cell without requiring additional room, and also facilitates carrying it, as it is proof against rattling round in the battery box.

Connecticut Telephone and Electric Company, Meriden, Conn.—One of the neatest little devices at the show is this company's new steering wheel switch. The switch contacts are contained in a compact box about 1 1-2 inches in diameter and 1 inch thick, which is clamped to the under side of one of the spokes of the steering wheel. It is operated by a lever arm which projects in such a way that the driver can reach it with his thumb without taking his hand from the wheel. The connections are carried through a flexible metal tube running down the steering column.

Herz & Company, New York City.—The "Bougie Mercedes" plugs of this company are familiar to all automobile users. They are still made with their double insulation of unbreakable stone, and are especially recommended for use with high-tension magnetos. The Herz foot switch and a complete line of terminals of all varieties are also shown.

Kokomo Electric Company, Kokomo, Ind.—The insulation of the Kingston plug shown by this company is built up of mica with a special fireproof cement under high pressure and then baked. They are made in 1-2-inch standard and A. L. A. M. sizes only.

C. A. Mezger, New York City.—The Mezger soot-proof spark plug has a deep annular space between the body of the plug and the insulation, and between the insulation and the central electrode. In this way an extremely long insulating surface is formed.

A. R. Mosler & Company, New York City.—The distinguishing feature of the Mosler plugs is the deep chamber in the base, which on the compression stroke is filled with the mixture. When the spark comes, this mixture is fired first, and rushes out through the narrow opening of the chamber with considerable force, so that the plug may be said to "spit fire." There is also exhibited at this stand a signal

called the "Ist," to be carried on the tail lamp for night driving. By means of a lever on the steering column the driver can cause the signals "slow" and "stop" to appear for the benefit of any vehicle behind him.

National Coil Company, Detroit, Mich.—This exhibit includes a plug made for use with the National coils, which is distinguished by its four sparking points. These consist of triangular extensions of the body of the plug bent inward toward the central electrode.

Stanley & Patterson, New York City.—This concern shows battery boxes made to hold various numbers and combinations of dry cells, the feature of which is that all connections are made automatically by the mere insertion of the cell into a socket in the box. All the boxes are strictly waterproof.

Witherbee Igniter Co., New York City.—The Wico spark plug is distinguished by its micrometer adjustment, by means of which the distance between the central electrode and the sparking points—here five in number—may be regulated to the thousandths of an inch. Another plug is also shown without this feature, at a somewhat lower price. The adjustable spark plug should find favor at the hands of autoists, in view of the ease with which it may be adjusted.

IN THE IMPORTANT FIELD OF THE CARBURETER

Albert E. Otto, New York City.—A novelty was shown in the imported Economy carbureter, manufactured by Adolf Saurer, of Switzerland, which has two spraying nozzles located side by side, the tip of one extending into a strangling tube of one diameter and the other extending into a tube of much larger diameter. The larger tube is normally closed at its upper end by a hinged flap valve held closed by dashpot and spring contrivance outside of the carbureter casing, so that until the suction of the motor reaches a certain limit, all of the mixture used passes by way of the small strangling tube, but above that the flap door opens and both tubes and both nozzles furnish the supply. In other respects the carbureter is a conventional construction.

Allen Fire Department Supply Company, Providence.—This concern showed a two-port carbureter, the leading characteristic of which is that the vertical central air opening within the ring float is divided into halves by a vertical partition, and the spraying nozzle is located in one of the passages, and the other serves solely as an air entrance. The top of each passage is guarded by a sliding horizontal throttle having a circular opening equal in diameter to the combined area of the mixture and air passages. In this throttle also is an adjustable minimum air opening which

prevents, if desired, shutting the motor off entirely when the normal throttle opening is completely closed. The needle valve regulating the gasoline entrance is oper-

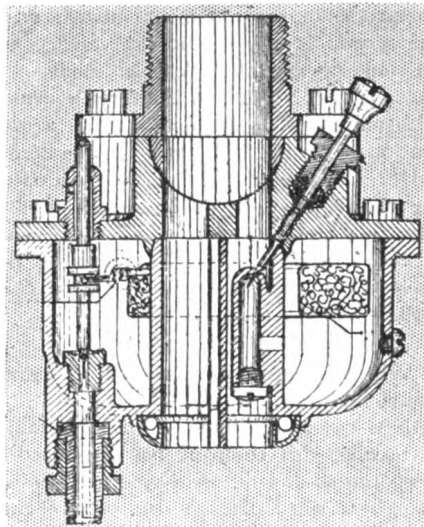

Allen Two-Port Carbureter.

ated by lever from the float. The only two adjustable parts about the carbureter are the minimum air passage controlled by screw and the needle valve in the spraying nozzle. Trouble of any sort is aborted by absence of loose parts.

F. E. Bowers Company, New Haven, Conn.—The Bowers concentric-float carbureter has been improved by the addition of a peculiar type of auxiliary air valve in the form of three openings each guarded by a leaf spring, the suction having to overcome these springs before additional air enters. The air for these openings is taken through ports in the sides of an expansion of the mixing chamber, whereas the main air passage is a vertical one past the nozzle.

Breeze Carbureter Company, Newark, N. J.—The improvement in the Breeze carbureter is the control of the needle valve in the spraying nozzle, whereby with every opening or closing of the throttle there is a corresponding opening or closing of the needle valve, thus varying the gasoline flow in proportion with the amount of mixture required. This is accomplished by a cross track placed as a diameter of the vertical cylindrical throttle. The track is supported at one end by a high-speed adjusting button, and at the other end by a low-speed adjusting button. On the needle valve stem is a wheel which rides on this track and through which the throttle changes are transmitted to the needle valve. By means of the external high and low-speed adjusting buttons all carbureter adjustments can be quickly made from the outside.

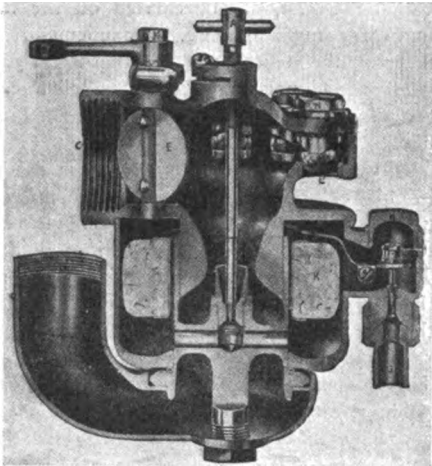

Section View Kingston Carbureter.

Byrne, Kingston & Company, Kokomo, Ind.—The new Kingston carbureter differs from previous types, in that the auxiliary air valve takes the form of five air openings, each guarded by a metal ball which must be lifted from the seating in the air port before air enters. The five balls are all of the same diameter and weight, and are distributed in semi-circular form in the floor of the mixing chamber extension. The air entering by way of these ball-guarded ports does not pass the spraying nozzle, in which is an adjustable needle valve. This carbureter is made with the main air entrance in the form of a vertical passage within the ring float.

Stromberg Motor Devices Company, Chicago.—In addition to its regular 1908 carbureter, the Stromberg company exhibited its new concentric-float type, designed for air-cooled and small motor work. This carbureter uses the glass float chamber and the nozzle without a needle valve. A new principle in it is the method of raising or lowering the float level. The float is supported on the long end of a horizontal lever, with the needle valve regulating the gasoline entrance on the short arm. Ordinarily the float end of the lever



is down, but additional pressure can be placed on the needle valve end by changing the tension of a coil spring surrounding the needle valve. Increasing the spring tension makes the float easier to lift, and, consequently, the gasoline level in the float chamber is lowered, whereas lessening the tension makes the float harder to lift and raises the gasoline level. The spring is adjusted from an external lock nutting device. A retained feature in this carbureter is the double spring control of the auxiliary air valve, one of the springs coming into use immediately the valve begins opening, and termed the slow-speed spring, and the other coming into action only on further opening of the valve, and styled the high-speed spring. External means are provided for adjusting each spring from the outside.

Wheeler & Schebler, Indianapolis.—The feature of one new Schebler model is the control of the gasoline supply past the needle valve in the nozzle by the auxiliary air valve. This is accomplished by a linkage connected with the valve, which connects with a rocking piece carrying the needle valve. A flat adjusting spring determines the amount of lift given the needle, and acting behind this spring are two screws which change the spring contour, one changing it towards one end to give greater gasoline feed at low speeds, and the other acting at the other end to vary the feed on high speeds. By varying these two screws any desired mixture can be had. In order to prevent injuring the needle valve point by screwing it too tightly on its seating, the stem is made with a ball on its upper end resting in a socket holder to permit of universal movement, and behind the ball a spring is interposed between it and the adjusting screw, which spring compresses under too much movement of the screw, thereby saving the valve point. In some of the other Schebler models the gasoline is controlled by the throttle, which with more or less opening there is a proportionate raising or lowering of the needle valve. The amount of lift for a given opening of the throttle can be varied by two adjusting screws, and in addition to which is the regular screw adjustment of the valve. The auxiliary valve is spring controlled, and the main air opening is a central passage through the ring float.

Willet Engine & Carbureter Company, Buffalo, N. Y.—In connection with its two-cycle engine with rotary crankcase valve, this company has developed a new original and different type of carbureter. In a word, this consists of two carbureters in one, each with its own spray nozzle and adjustment.

This carbureter is of the double automatic type, using a small carbureter on the low speeds, and a second, cutting in automatically, for intermediate and high speeds. Each carbureter is adjusted by an individual needle valve, and both carbureters are entirely surrounded by a hot water jacket.

There is a throttle (marked "D" on the half-section drawing) which, when closed up, creates a strong vacuum on the spray nozzle, thus drawing a rich mixture to make easy starting possible. The valve is then opened to its normal position, which is wide open. Should the weather be cold and a richer mixture required, this valve may be closed somewhat. This may be done from the dash, while the car is running, without disturbing the needle valves; thus it is possible to change the mixture in the carbureter without disturbing the needle valve adjustment. Perfect mixture is obtained by this carbureter from very low speeds to extremely high speeds owing to the independent adjustments. The automatic valve (marked "F") has a slight spring tension back of it. This valve cuts in the second carbureter whenever necessary. The entire carbureter is controlled by a butterfly throttle valve (marked "A"). Ports in the intake chamber are lined with a fine mesh brass screen, which keeps all dirt

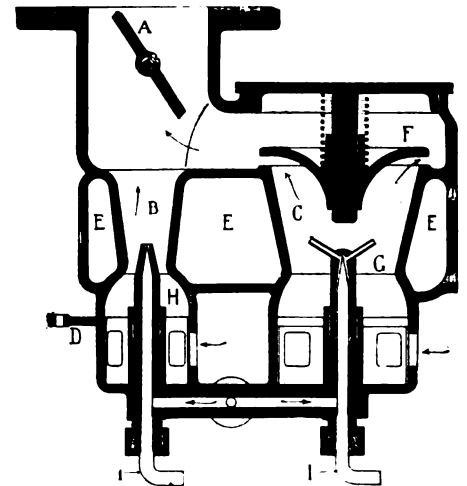

Details of the Willet Carbureter.

from entering. A strainer is also fitted in the coupling underneath the float chamber, which keeps dirt from getting into the float chamber through the gasoline intake pipe. Float is of weighted cork, suspending a ball valve on bottom of carbureter.

The needle valves (marked "H & G") can be readily removed for inspection, and replaced without losing their adjustment. A singular jet is used on the low speed in the small carbureter, and a series of four jets, controlled by one needle valve, is used on the second carbureter (or the one marked "C").

GASOLINE INDICATOR.

Randall-Faichney Company, Boston, Mass.—This company is handling the product of the Webster Mfg. Company, which consists of a gasoline indicator. In substance this is exceedingly simple, a float at the end of a metal arm turning one of a pair of gears, the other being on the bottom of the spindle, which carries the indicator hand, turns with it, thus indicating the amount of gasoline left in the tank.



MATERIALS USED IN AUTOMOBILES AND ACCESSORIES

STRIPPING the whole question of the glittering generalities that follow in the wake of the enthusiasts who cluster around the automobiles at the show from morning until the orchestra sounds the "retreat," taking into account a previous detailed knowledge of the practices and the incentives—even allowing that some of the things can be improved—it is possible to detail a story of the use of good materials and to show that they are available for service.

When a builder of automobiles says good materials are used, that die forgings are in the axles, that forgings are made in one piece—no welds—that the dynamic ability of the parts that have to sustain under severe conditions of shock service is adequate, than it is time to look for the evidences of ability and the question is, Where did the quality grow?

If good materials are to be had, they must be on the surface, in plain sight; few, indeed, are the men who hide their light under a bushel. Look around the show, see the exhibitions of accessories, note the display of materials of every kind. The evolution of a half-score of years hangs to the show like a specter, steeped in the persistence which, like time, is dyed in the wool. Go down the line and every foot of the way will be contested by things that compel attention. View the whole situation with a critical eye and what will be the result?

The automobile industry is out of its knickerbockers, and it has conducted a "Cook's tour" of accessories along with it; it may be the conductor, but it is only one swallow; the accessories are as the rest of the flock. Along with the accessories will be found the "parts." Makers of automobiles use parts, and they get them—in the majority of cases—from the parts makers. The claim is frequently made that an automobile is not so good because parts are used, parts that are made outside of the assembling shop. Is a Waltham watch bad because the case is made in another shop?

All shops are divided into departments, and each department is under the guidance of separate men. Does the fact that the same "board of directors" controls the several departments ac-

count for the good work in them? The board of directors merely authorize the work. They do none of it. The same conclusion is that in which allowance can be made for good work in any shop, and if the products are all as per drawing, and the materials are all good, the sum will be a good automobile, watch, or whatnot. But if a company does not pay the price that will command good things, it is as sure as shooting they will not be good. This is the phase of the situation which leads to discussion along lines reflecting the bad qualities that can, and sometimes do, reside in assembled automobiles.

The makers of accessories and of parts are wise enough to know that the thing for them to do is to charge for good work, suitable material, and the finish that will reflect credit upon them. They know that purchasers will in the long run say what they will have, and refuse what they think is not worth the price. The result is, the makers of accessories and of parts are in a large measure responsible for the quality that resides in automobiles as displayed at the show; they made the low prices possible.

Specialists doing some one thing can do it well and quickly. These same specialists can quote a low price, and they can make it worth while to an assembler to use their product. As a matter of fact there is no better sign of quality in many of the cars of the day than the fact that "so and so" furnishes the axles, or the ball bearings are of such a make, and so on all along the line. When it comes to certain parts of automobiles, as magnetos, spark coils, batteries, spark plugs, and, in fine, a wide range of the materials used, they are almost invariably the products of separate establishments.

That good cars are good because they are so made is assured; it is not because they are segregated from the parts to be had from available sources, nor because of a two-ring circus under one canvas. That good accessories and parts of great merit may be had, is proven by the fact that they are at the show, open to the light of day, or the critical inspection of any man who is looking for quality rather than trouble. They are there and the price is very reasonable, indeed.

AXLES AND BEARINGS

American Ball Bearing Co., Cleveland, O.—In the trade this company has a wide circle of acquaintance because of the vast number of high-grade balls turned out at the works. But if the company produces this product, it is also a fact that of ball and roller bearings a liberal quota comes from the Cleveland plant. Then, it is true as well that the American output of live rear and other axles and auto parts generally runs into a vast annual product.

The class of work turned out by the company is best sized up by noting that American products are found in nearly all of the finest cars.

Hess-Bright Manufacturing Co., Philadelphia.—There "with the goods," the Hess-Bright Company is in supreme presence, with ball bearings (the H-B and D.W.F. kind) known in every land to which the automobile has traveled and returned without trouble in the bearings. This year the company is offering to the trade a "magneto," the qualities of which

are assured by the endorsement of Henry Hess. This year sees this company with a line of "auto-hubs" of a distinctive character in which H-B ball bearings are used, and in which all possible means for safety are incorporated in the thorough manner to be expected under the guiding hand of engineers of such well-known skill. In the hubs the ball bearing spacers are also used, to take the responsibility should one of the ball bearings fail in service. History does not seem to know of a case of failure, and were it not for the fact that the spacers

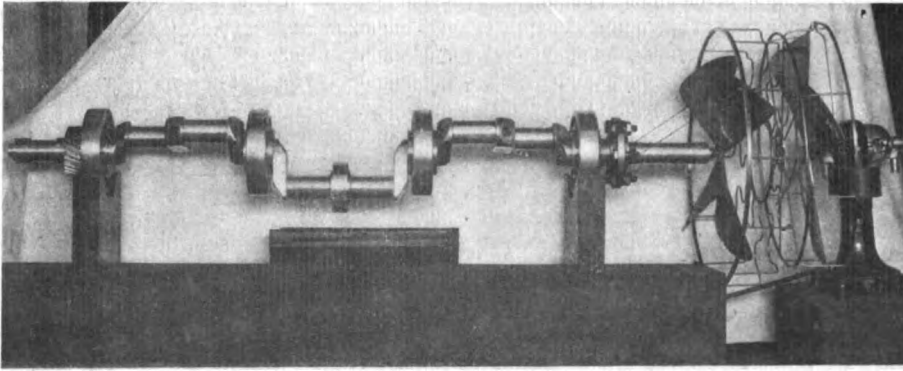

Hess-Bright Ball Bearing Propelled by Air Fan.

have to be used anyway, it would look like an addition without a compensation. At all events, it is a "safety" at no extra cost, and as "Bob" Clingen, of the "Hess staff" puts it: "Mr. Hess takes no chances." That H-B ball bearings are regarded as valuable is proven by the fact that, at the show, they are all nailed down to the show board. Otherwise they might make fine souvenirs.

Hyatt Roller Bearing Co., Newark, N. J.—If "ham" spells "pig," "Hyatt" should spell "success." Anti-friction bearings are looked upon as of the utmost importance in automobile work, and it was

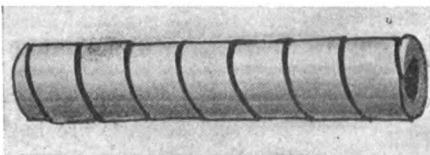

Type of Hyatt Roller.

the privilege of the Hyatt Company that had as much to do as any one with the question of how the bearings shall be. Hyatt roller bearings are used in live rear axles, transmission gearsets, and, in fact, in all the places of responsibility which call for the use of an anti-friction type of bearing. The "improved cage" holds the flexible rollers in correct alignment. The company now has some fifty distinct sizes in such shape as to assure prompt delivery. In 1901 only two cars were fitted with Hyatt bearings; 1907 saw twelve times as many makes of cars rolling on Hyatts, with another big increase in 1908.

New Departure Manufacturing Co., Bristol, Conn.—In this age of sharp competition the idea of "waylaying the early bird" is rather bold, and to "get the drop" is a necessity, since the bird goes armed with merit, as a rule. The early bird is a clever chap, but the New Departure ball bearing will pull tail feathers if not well watched. In any case, the New Departure is out for its share of the glory, and it will be all right if the same is accompanied with a little profit, not only for the company, but for the users of the bearings as well. In a matter of this sort an advantage is—like the New Departure ball bearing—"two in one." This type of bearing takes thrust and radial loads, and its

value has been tried out in "taxicabs" under conditions such as they obtain in New York City. D. F. Graham, in charge of sales for the company, who was formerly superintendent of the New York Taxicab

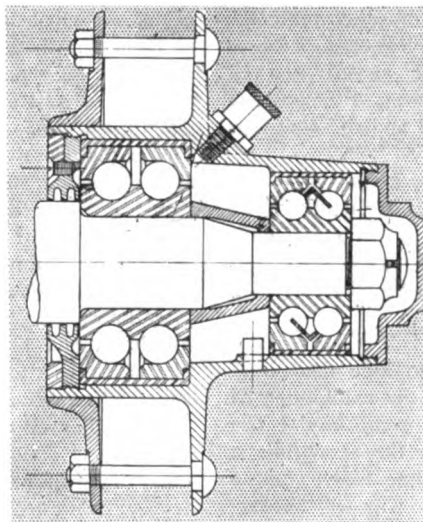

New Departure Ball Bearing.

Company, sets forth the claims of the New Departure in convincing language, and his experience in this line gives him advantages which tell. The "two in one" idea is adequately illustrated at the show in that the bearings are placed to support a big flywheel that puts thrust and radial load on the bearings.

Standard Roller Bearings Company, Philadelphia.—This company offers ball or roller bearings in every place of any considerable responsibility. For standard journal work there is the well-known Standard roller bearing; then there is a line of shafting hanger bearings and thrust bearings in ball and roller types. Of annular ball bearings the Standard Company has a full line, and they are so much used that reiteration is a mere matter of form. When it comes to balls the Standard makes them from "tool steel" to the line, such as serves well the purpose in bearings for even "lawn mowers," and it is not too much to say that a Standard bearing can be had for every application under the sun.

Timken Roller Bearing Axle Co., Canton, O.—Roller bearings of this make are used in so many of the automobiles of worth that the company is known throughout the length and breadth of the land. The home of the "Timken" is worth going there to see. At the show, the "Timken" has a new 1,500-pound type of front and rear axles that draw the "magnates." The front axle is of the I section of the usual Timken shape and accuracy of design, while the rear axle is "live," light, strong and complete. The new line of Timken—"short"—taper roller bearings is so much of an advance in the industry that it cannot well go unnoticed. Then, there is the Timken truck front axles in one, three and

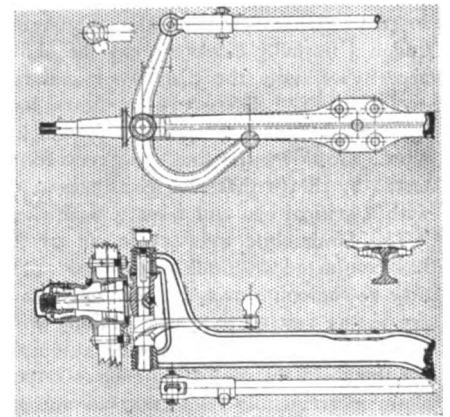

Timken Front Axle.

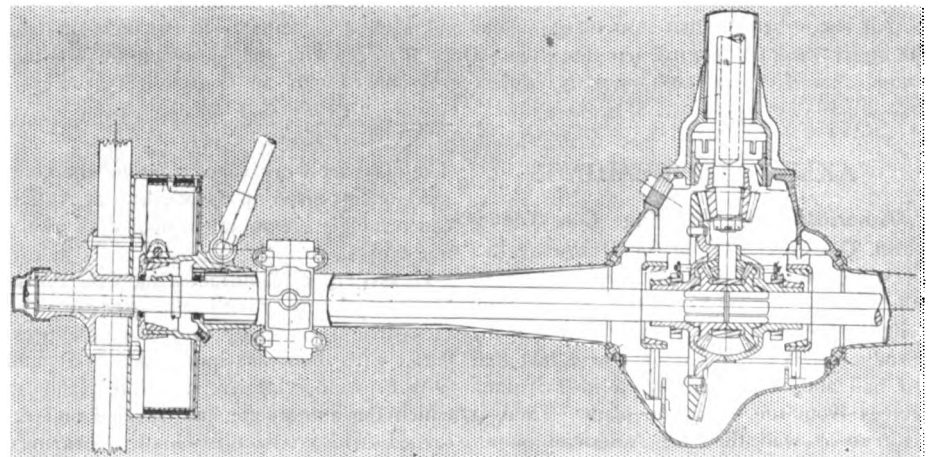

Timken Live Rear Axle—New 1,500-Pound Type.

five-ton sizes, with Timken roller bearings in the knuckles, which should go a long way towards rendering steering pleasurable and safe.

CASTINGS.

William Cramp & Sons Ship and Engine Building Co., Philadelphia.—Axles, motor cases, steering gear housings, side levers, motor arms, connecting rods, linkages, brackets and multitudinous small parts, all of Parsons manganese bronze, from the famous plant of the great ship builders, Wm. Cramp & Sons, are in splendid profusion at the show. It looks like gold, this bronze. In practice it is like gold, in that it does the work up to the standard of the highest expectations, and it lends itself to the task in a manner not to be imitated, since it can be cast in intricate shapes with no limit to size. "As strong as an ox," is an old and trite saying that fits the case, as the following record of a test of "Parsons" will indicate: Tensile strength per square inch, 79,800 pounds; elastic limit per square inch, 42,500 pounds; elongation in 2 inches, 40 per cent.; reduction of area, 40.6 per cent. "Think it over," is what the expositor says.

Henry Hess, Philadelphia.—German made steel castings will be a Hess specialty pending the time when Henry Hess, of Nineteenth Street and Hamilton Avenue, Philadelphia, will fit out a steel casting plant. The examples of steel castings to be seen at the show are of more than passing interest because the shapes are intricate and the castings are of fine appearance, thus indicating that the claims made for them are not without good ground. Mr. Hess contends that the process used eliminates all the old drawbacks that long stood in the way of steel castings for many purposes.

The United States McAdamite Metal Co., Brooklyn, N. Y.—McAdamite belongs to the aluminum genera. It came on the market a few years ago when aluminum was a little uncertain, but it has never shown any of the uncertainties of aluminum. It is used for every purpose that aluminum can be used, and its range of uses expands far beyond. Aluminum is light. McAdamite is light. Aluminum is strong; McAdamite is stronger. If aeronautics expand, it will be the metal of them all to do the work, and it is now largely used in this service, even for motor connecting rods. The price of this metal is low enough to enable it to be used in any place requiring light, strong metal, and as to the strength it is best disposed of by a record of a test as follows: Tensile strength per square inch, 44,250 pounds; compression per square inch, 126,000 pounds; torsion per square inch, 66,300 pounds; specific gravity, 3.20; fusing point, 1,040 deg. F.

Light Manufacturing Co., Pottstown, Pa.—The exhibition is of a "foundry

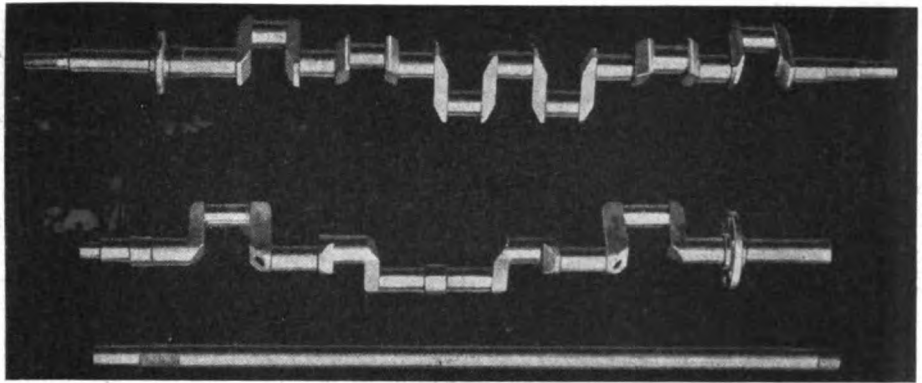

Dreggs-Seabury Alloy Steel Crankshaft Work Portrayed.

product," comprising aluminum, manganese bronze, phosphor bronze, plastic bronze and babbitts. The best reason why the Light Manufacturing Co., of Pottstown, Pa., will be able to deliver satisfactory castings of the kind is as the company states: "We are machining them every day and this helps us to know what we are doing, instead of waiting to have our customers tell us." At all events, this company is doing a large share of aluminum casting work, and on the basis that "a customer is a partner" the situation is one

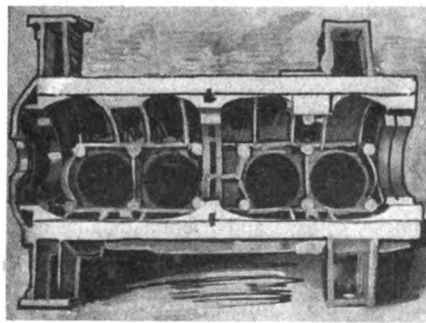

Light Mfg. Co. Aluminum Work.

without a loophole through which a flaw can meander in.

Wetherell Finished Castings Co., Philadelphia.—The name spells finished castings all over, and there is no use to which castings can be put that this company will not undertake. The Wetherell Company is in a position to make everything by way of castings that can be used to advantage in automobile work, and a visit to the show will be incomplete without paying a visit to the Wetherell.

PRESSED STEEL

Dreggs-Seabury Ordnance Corp., Sharon, Pa.—The gunmakers of Sharon, Pa., with a plant, which on a war footing could supply the army with guns and ordnance a plenty, is well equipped to do automobile work, now that the automobile is up to the high level which was always essential when reference is had to ordnance. When the rush of the show is off, it will make fine reading; a story of how they do it at Sharon, those gunmakers, and

in the meantime it will be well to call attention to the fact that the Dreggs-Seabury "pressed steel rear axle housing" is the acme of stability, and the weight is down where it belongs. Fine material and the process that is natural to a plant which does work for "Uncle Sam" must in the long run find its way into such important parts as the housings for live rear axles. But the Sharon plant is not confined to just these parts, for at the show there are "drop forgings" gears and chassis frames as well as crankshafts and such like. This company can make anything in pressed steel, forge hammered and forged in dies. The materials the company uses are so fine that it is only in a gun or an automobile that they would find a resting place. Indeed, the Sharon plant will furnish drop forgings in all the tough-hard grades of alloy steel, as well as the products in carbon steel, a matter of greatest importance.

A. O. Smith Company, Milwaukee, Wis.—Pressed steel is now used for many purposes besides chassis frames in automobiles and the A. O. Smith Co. is "on the job." When it comes to chassis frames this company has them in all the forms, from the latest "drop frame" to the big channel shapes for trucks that stretch from "here to there." In material the parts are made in all choice selections, as alloy steel, special carbon and mild steel. There are cross members in intricate shapes that would be considered out the question a couple of years ago, and from brake-drums to spring suspenders the display is well worth spending the time if only to speculate as to how they do it. Nor is it so much a question of the diversity in form, from the point of view of "pressed steel," as it is the fact that this is an enormous industry that the automobile gave birth to, and the A. O. Smith Co. had a large say in the making of it. It was not a question of nerve, so much as a matter of business acumen and courage that brought results.

CHAINS

Baldwin Chain & Manufacturing Company, Worcester, Mass.—In addition to its regular line, Baldwin roller chains, sprockets, and the new Baldwin improved

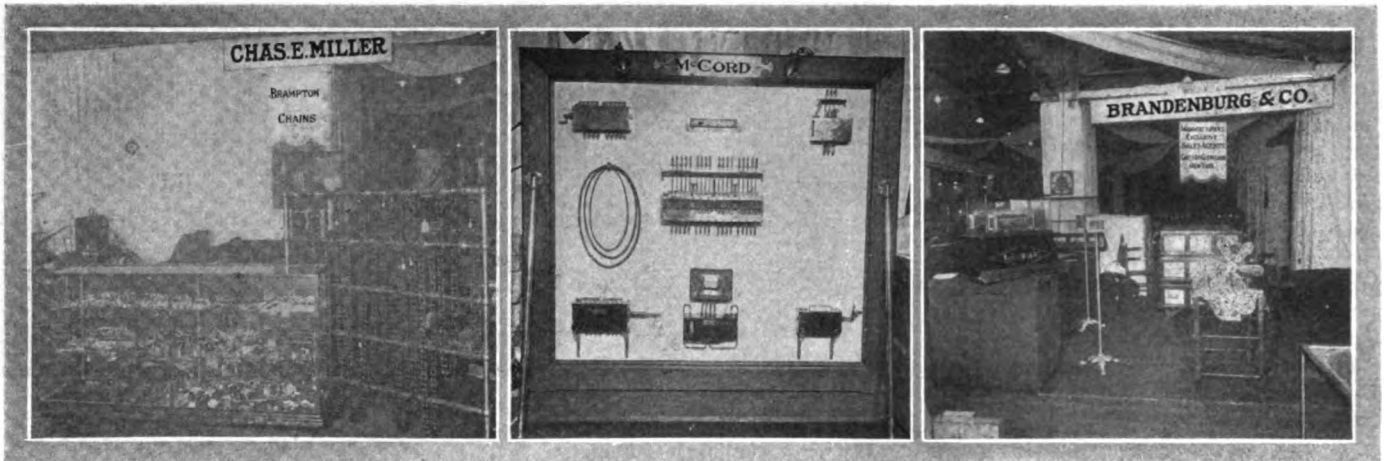

detachable chains, especially designed for automobile use, this company is now placing on the market a new and improved type of automobile steering gear. This is designed along totally different lines from those now favored by current practise for this purpose and the result has been not only to greatly simplify the gear as a whole, but likewise to make it an extremely reliable device in which wear has been distributed over such a large surface as to be practically a negligible quantity. A detailed description of this new steering gear will be given in a later issue.

Charles E. Miller, New York City.—The space allotted to this accessory dealer is not equal to his importance, and the large line of goods handled, besides which, it is not well located, being hard to find and sandwiched in between two automobiles. The principal feature of an excellent exhibit is the English made "Brampton" chain, which may now be had in American sizes, as well as the former metric sizes. These celebrated driving chains are made throughout of self-hardening steel of superior quality, made accurately to gauge, and carefully assembled and polished so as to fit the sprocket with a minimum of friction. No provision is made for replacing the heavy chamfered side plate, because in the history of the company no torn, broken or sheared side plate has ever been brought to their attention. This fact in itself speaks volumes for the merit of the "Brampton" chain.

Diamond Chain & Manufacturing Company, Indianapolis, Ind.—One of the most interesting parts of the Diamond exhibit is something that the average visitor is not apt to realize the value of unless his attention is called to it, and that is "Pamphlet D," the mission of which is to describe "Diamond Chains, as Applied to Chain-Driven Automobiles." It is of more than ordinary interest for the owner of a chain-driven car of any type or model, since it not only gives the names of makers and the models on which they are now using chains, but every model of chain-driven car that has ever been made in this country. The width, length and number

of chains used, i. e., whether single or double side chain-driven, is given in every instance so that the pamphlet is an aid in ordering a replacement for an old car. Attention is also called to the fact that Diamond chains are made to fit sprockets of any standard, and can be used on American chain-driven cars of any make. Nickel steel rivets are used in the manufacture of all Diamond auto chains.

Whitney Manufacturing Company, Hartford, Conn.—In addition to the "Wizard" chains and sprockets, rollers and block chains, made by the Whitney Company, and which are too familiar to call for extended mention, this concern also shows a number of specialties for automobile manufacturers, such as the Woodruff system key cutters, water tool grinders, hand and weight feed milling machines, "Presto" chucks, collects and friction tapping devices and the like. "Whitney Chains and the Cars They Drive" is the title of a booklet under date of July 1, 1908, detailing the dimensions of Whitney chains used on many of the leading makes of American cars, and attention is called to the fact that the Whitney Company is now preparing to furnish cars, whether the sprockets are cut to the

Whitney standard or not, special attention being paid to odd sizes.

SPRINGS.

Burnet Compound Spring (Inc.), Newark, N. J.—The "Burnet" is there, and its non-shock qualities are being demonstrated in a manner intended to convince the interested spectators. The spring consists essentially of two superimposed elliptic springs so designed as to afford that flexibility so much desired, without the spring play that generally goes with it.

J. H. Sager Co., Rochester, N. Y.—A line of equalizing springs that promise immunity from the ills of road inequalities and the large cost of maintenance that follows. In action, the "Sager" type of spring works freely, and in reaction the violent upward tendency is checked without any undue rate of change of motion.

Perfection Spring Company, Cleveland.—The use of fine materials, such as "Krupp" steel for springs, renders it possible for the Perfection Spring Co. to hold the reputation for quality that its springs have made for it in automobile work. The "Perfection" is a special spring with easy riding qualities as a proven fact, and hundreds of testimonials to show for it. The company also makes springs after designs by the makers of cars, adding the knowledge due to a wide experience if the designers so indicate. On the other hand, if car builders have just what they want, the Perfection company sticks to the specifications.

FORGINGS, TUBINGS, JOINTS.

Anderson Forge and Machine Co., Detroit, Mich.—Located in the heart of the Michigan automobile industry, it is not to be wondered at that this company has progressed along lines such as ended in a line of "drop forgings" for automobiles, including crankshafts, connecting rods, and, in fine, everything that can be of any value in automobile work. The company is equipped to do a vast amount of the highest grade of drop-forging work, and the materials used by it are of the superior grades for the purpose.

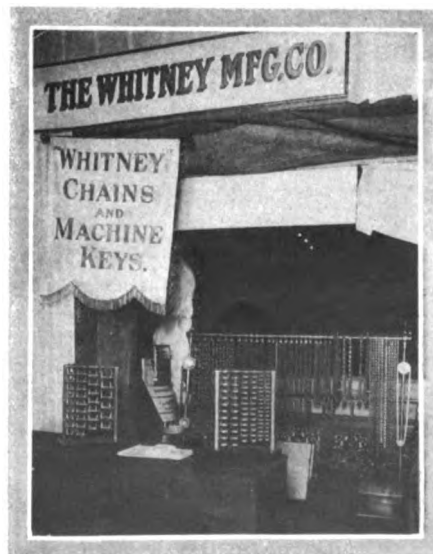

Spicer Universal Joint Mfg. Co., Plainfield, N. J.—This concern shows by its line that it has fully realized the importance of universal joints as one of the vital parts of a complete car if the full power of the motor is to be properly applied to the rear wheels. For the coming season it is producing a line of these joints in about a dozen different varieties, from the simplest to the complete propeller shaft with double universal. Recognizing the fact that there is a change in the velocity between the driving shaft and the driven member where only one universal is used, models No. 26 and No. 30 are especially designed to overcome this. Spicer universal joints have a large bearing surface, are easy to take apart, and protection from "grit" is adequate.

Standard Electric Welding Co., Cleveland, O.—This company turns out seamless steel tubing and steel rings, as well as axle housings in the same way, clincher rims and all the other things of steel electrically welded or in seamless form. The Standard exhibition is of the greatest interest, and the company probably plays a far more important part in the trade than the average designer of automobiles dreams of. The "parts makers" all claim the Standard as a twin brother, and when the Society of Automobile Engineers went to Cleveland last Summer they visited the plant of the Standard Welding Co., in which they were enabled to "see things."

Shelby Steel Tube Co., New York.—Shelby steel tubing is the subject, and the wide range of this material offered by the company is reflected at the show. This tubing is made in rounds, squares, and special shapes that have to be good to stand the process, which process, however, improves the quality of the material, in that "fabrication" when properly conducted always adds to the physical properties of steel, if the material is of a quality such as will stand the process. The "show board" of the Shelby is a picture to behold; upon it will be found all sorts of products, hubs for wire wheels, bicycle forks, pump barrels, taper tubes, gas engine cylinders, upset tubes, etc. What attracts much notice is a tube tied in a knot. This in itself demonstrates that the ma-



Shelby Steel Tube Upset at Both Ends, Showing Quality.

terial is of fine character. Shelby steel tubing has a wide range of uses in automobile work, and it has always had the reputation of making good.

RADIATORS.

McCord & Co., Chicago.—For general appearance the radiators as made by this company are all that can be desired. The plan is one that results in great stability, and the efficiency of the radiator has been

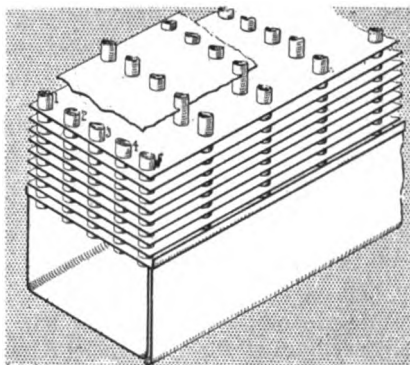

Section of McCord Radiator.

pronounced good by the many users of the type. It will be remembered that in the McCord the water tubes are vertical and flat plates, quite closely spaced, serve to radiate off the heat.

Briscoe Mfg. Co., Detroit, Mich., and Newark, N. J.—This concern has for this year tubular and cellular radiators. The horizontal tubular type contains flat tubes extending from right to left and arranged so that two tubes side by side alternate with one placed centrally. Cooling is by vertical metal plates whose edges face for-

wards. The Briscoe honeycomb radiator is made by taking lengths of seamless tubing almost one inch in diameter. By pressing in a form this tube is made into three diamond-shaped tubes, the ends being diamonded and the central parts slightly corrugated, so that when two or more sets of these three tubes are put together, a water place is left between them; but the regular diamond-shaped ends unite forming a containing wall. This allows of a vertical water flow and a horizontal flow between each two, three or five squares.

GEAR SETS, ETC.

Brown-Lipe Gear Company, Syracuse, N. Y.—The new transmission gearset of the Brown-Lipe make is styled after the same make of transmission as used on "Thomas" cars, excepting that the position of the "second" shaft is reversed. It is a neat piece of work, well up to this company's standard, with alloy steel gears and parts of responsibility. The case is of aluminum. The greatest advance, perhaps, lies in the methods of heat treatment this product is subjected to.

Merchant & Evans Co., Philadelphia.—The Hele-Shaw is the multiple disc clutch in which the discs "engage" on the grooved faces instead of on the flat. With ten sizes to choose from, the builders of automobiles are enabled to get what they want; for the little car with the "one lung" or for the ponderous racing car one will find a clutch to match. The Hele-Shaw idea came from abroad, as did many of the ideas which automobiles fell heir to, and it is one that has not been "messed up." The Merchants & Evans Co., report new converts to the swelling list.

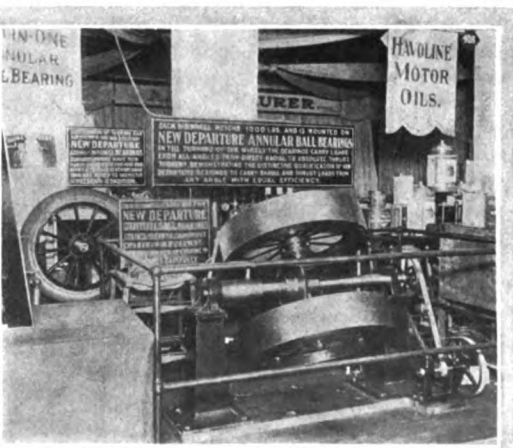

SHIELDS, TOPS, BODY MOUNTINGS, SHOCK ABSORBERS

E. T. Burrowes Company, Portland, Me.—The Burrowes windshield made in halves differs from many others in that the lower half can be set at any angle to the car dash, and the upper half also mounted at any angle to the lower half. The shield is supported without forward extending brace rods, but by short brace rods extending from projecting brackets on the rear of the dash. The brace rods attach to the top of the lower half and into a bracket on the bottom of the lower half, which bracket hinges to that on the dash, and is held at the desired angle by a thumb screw in the lower half bracket working in a quadrant slot in the bracket on the dash. The top half hinges to the lower half by end hinges, each hinge being made in halves with serrated opposing surfaces, so that by loosening a locking nut on each hinge the serrated faces separate enough to let one be slipped past the other until the top half is at the required tilt, when tightening the locking nut bring the serrations into engagement, thus forming a positive lock.

C. Cowles & Co., New Haven, Conn.—This very old and well-known company is at the show with a fine line of brass fittings as used in automobile work, and among other things the limousine case in two styles attracts much attention. The case for ladies is a marvel of completeness. Besides a watch that will keep time without any question, the case holds all the requisites, among which is a hand-mirror, on the back of which is a slate. Then there is a card case and memorandum books, also a record book, not to mention a "puff." For men the case includes a cigar holder and a container for cigar ashes. These cases are not only of the greatest utility, but they are artistic and distinctive.

C. A. Mezger, New York City.—In the Mezger windshield the upper half hinges to the lower, and in lowering it nothing has to be done but pull it closed. This is made possible by a spiral spring so placed that it tends to hold it in the up or closed position. The shield is further locked in the up position by an inverted L-shaped hinged catch, the upper or horizontal part of which fits over a toe on the frame of the upper half and is held thereon by plunger and spring, a sudden jerk being sufficient to free the toe from the catch.

Sprague Umbrella Co., Norwalk, O.—The tops and windshields made by the Sprague company show that Col. Sprague has profited by his wide experience in this field of work. Besides the regular full line of tops and shields, this concern is offering for the coming season a top designed to meet the demands for runabout use. It is so arranged that the long front bows sometimes used have been done away

with in order to facilitate entering and leaving the car. The forward bows on this top will slide down on the middle one, giving additional ease in lowering and raising. With its long front overhang and sharp turn it makes an ideal protection for either bad weather or hot sun.

Troy Carriage Sunshade Company, Troy, O.—The Troy windshield for runabouts with the angular lower half is fitted with a device to prevent the lower half from breaking when being folded forward to the horizontal position. This, in brief, is a telescopic brace rod, the inner member of which has a split end within which is an expanding nut controlled by a finger wheel at the end of the upper half and in easy reach of the driver from the seat. To lower the shield, it is but necessary to turn the finger wheel, after which the air cushion in the telescopic tube will prevent a too rapid fall.

Vanguard Mfg. Co., Joliet, Ill.—The display of the Vanguard at the show attracted much attention on account of the high character of the devices, notably the Vanguard windshield. Besides a certain desirable stability, this windshield is adjustable from the seat, is both light and strong, and moreover it will not rattle.

Pantasote Co., New York City.—As a substitute for leather, Pantasote is now so well known as not to require a long reiteration of its lasting qualities. As a matter of fact, Pantasote is superior for the several purposes to inferior grades of leather, and for that matter it is so well made that it looks quite as good as most grades of

leather in upholstery work, once it is in place, if the workmanship is well executed. There are imitations of Pantasote that do not come up to the scratch, and it is these imitations that should not be used in any comparison to be made. Pantasote is made in all shades of colors and in the several weights.

SHOCK ABSORBERS.

Ernst Flentje, Cambridge, Mass.—A certain amount of interest is centered around the shock preventer as exhibited by Ernst Flentje. Recourse has been made to the glycerine cylinder with a piston, which has a very simple valve arrangement allowing for compression of the springs without hindrance, but prevents the quick throw-back, as the area of the holes through which the liquid passes on the compression stroke is about five times what it is for the opening. The valve opening is very short and quick of action in both directions. No matter how sudden the closing of the spring, the recoil is smooth and easy, due to the slow passage of the glycerine through the restricted ports.

F. R. V. Auto Parts Company, New York City.—The F. R. V. shock absorber consists of a belt, which at one end is looped around the car axle, and at the other fits over a drum secured to the car frame and attaches to a radial arm carried on a stud, to which a coiled spring is secured. Normally the spring is under tension. When the frame drops as the wheel enters a depression, the strap slackens, but all of this slack is immediately taken up by the coil spring, the belt being wound on the drum. When the rebound starts, it is resisted by the spring tension as well as the friction of the two or three loops of belting on the drum. The principle is the same as when a rope is wound once or twice around a shaft in order to support a weight, or to lower it more easily. The only difference over last year's design is that the spring tension or adjustment of the absorber can be accomplished from the outside without removing the cover cap.

Hartford Suspension Co., Jersey City, N. J.—"Over twenty automobile companies now use them." Truffault-Hartfords are so well and favorably known as to require no further introduction, unless to run over to "old standbys" and to note that they are alive to the advances that time interjects into a "live" industry, which life the "Hartford" did its share—liberally—to interject. In the meantime it is interesting to note that the Hartford Suspension Co., at its plant in Jersey City, is running full capacity, with small chance of doing more than to keep above the orders that naturally are due.

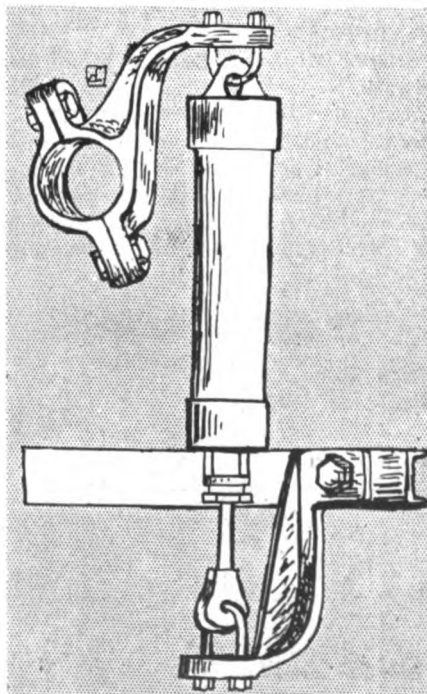

Flentje Shock Absorber.



ARTISTIC AND SCIENTIFICALLY DESIGNED LAMPS

Atwood-Castle Co., Amesbury, Mass.—The new double-drip generator of this company's make is well worth the close attention of the users of generators, and the "black-nickel finish" is certainly something to consider when lamps are being selected. In square shapes, the company's line is artistic, and as to utility, the lamps "stay lit." On the whole the Atwood-Castle line covers everything in lamps and generators for the automobile.

Badger Brass Co., Kenosha, Wis.—The exhibit of this company at the show represents an extensive line, with a style of lamp for every purpose in automobile work. The "Solarclipse" and the "Auto-clipse" types are handsome and of greatest value in automobile work. Then, again, there is the patent-leather finish" in all the styles of Solar lamps and generators. A leader in the line is the new square carriage there is the "patent-leather finish" in all the Solar motorcycle lamp, in a headlight pattern, including a generator.

Gray & Davis, Amesbury, Mass.—Lamps and generators of this make are known in every nook and corner in the land. The display this year at the show is extensive, indeed, and the company proposes to maintain a lead its goods enjoy in certain quarters, which, however, is not to be the limit of the company's endeavor. In square effects the Gray & Davis oil lamps are of the greatest utility, and the general appearance is handsome. The lamps, with lenses, are of the class in which

the lenses can be removed, and the old game of soldering and riveting is not present in Gray & Davis lamps. The generators of these lamps are of the class that commands attention.

C. T. Ham Mfg. Co., Rochester, N. Y.—These makers of the Ham "cold-blast" auto lamps are at the show with a full line, and visitors comment favorably upon the display. This company is furnishing lamps in the usual "bright" finish or in the "black nickel finish" so prone to be the feature of the year in lamp and generator finishes. In one other particular, the Ham lamps are worthy of more than a little attention: the oil lamps are so designed as to admit of the use of electric lights, or acetylene burners can be used instead. This is a feature that will be much appreciated by autoists in general.

Rushmore Dynamo Works, Plainfield, N. J.—In lamps and generators the Rushmore line is, as usual, so complete as to be up to every requirement of the autoist and the maker of automobiles, if quality *per se* is to be the guide. Rushmore also has the happy faculty of landing a surprise at regular intervals. This year the present from the Rushmore plant to the autoist by way of a generator will be "valveless." When this statement is made every autoist in the land will know what it means, and further comment is a waste of time. The new Rushmore idea is one that takes account of a perfectly even flow of the gas, at the required pressure, and it will be well

worth a trip to the show to see how Rushmore accomplishes the trick. That he does make good is assured. The new multiplex non-flickering glass system of the Rushmore line is attracting much attention.

Edmond & Jones Mfg. Co., Detroit, Mich.—This company has on exhibition a splendid line of lamps and generators in the regular finish as well as in the "black nickel" finish. The originality of some of the designs is favorably commented upon by the spectators, and the company reports good business. In side oil lights the square effect is something to take a second look at, and the generators by this company are of the greatest utility.

George S. Sherman, Great Neck, N. Y.—The circular rotary light as made by this company is something for every autoist to consider. By means of the Sherman equipment it is possible to project the light in any direction before the car turns. In this way the chances of getting off the road or of colliding with an obstruction, out of the line of the usual fixed light, is avoided.

J. W. Brown Mfg. Co., Columbus, O.—This company is at the show with a fine line of automobile lamps in all the latest shapes and finishes. The generator is of an approved pattern, free from any tendency to clog up, and by its principle of design the gas is furnished at an even pressure, free from impurities and capable of making a pure white light of great intensity. The company is in a position to entertain any lamp proposition involving quality.

TELL-TALE SPEEDOMETERS IN VARIETY

Auto Improvement Company, Brooklyn, N. Y.—These manufacturers of the Ever-Ready centrifugal-force speedometers, with which are incorporated odometers "made in Germany," have made a great improvement in all of its instruments by the use of the new direct drive which is made without any springs. A new Universal model has a floating indicator supported from the periphery of the dial, rather than a pointer supported at the center like the hands of a watch. All in-

struments are fitted with the straight vertical shaft drive.

Hicks Speed Indicator Co., Brooklyn, N. Y.—The Hicks indicator, made in four models, is characteristic because of its square glass, beneath which is a crescent-shaped dial, a clock, season and trip odometers, according to the model. This speedometer operates on the centrifugal force principle, the two oppositely placed ball governor weights being carried on a vertical shaft, which is within the instru-

ment. The regulation from the governor sleeve to the indicating needle is through a lever combination. One of the models is fitted with a maximum speed hand, while two others may be so fitted at an extra charge.

Hoffecker Company, Boston, Mass.—The Hoffecker for 1909 is made up of a combination speedometer and Chelsea clock with the total mileage and trip mileage indicators incorporated in the speedometer. To illustrate the steadiness of the hand

some ingenious person constructed a jolting apparatus on which the instrument is mounted and in operation at various speeds.

Jones Speedometer Company, New Rochelle, N. Y.—This old and well-established firm has met the demand for a more popular-priced instrument by placing upon the market, along with its regular line of about twenty different styles, three new models of the straight drive type. No. 27 and No. 28 indicate speeds up to 50 miles per hour and are fitted with odometers. No. 29 registers to 60 miles per hour.

Stewart & Clark Mfg. Co., Chicago, Ill.—Speedometers have come to be looked upon as almost a necessity in the equipment of a car, and this concern has constantly kept abreast of the times with a

complete line. For 1909 it has added to its already long list of types working on the centrifugal force principle, a magnetic one, No. 11, with the indicating hand carried in the center of the dial, the scale forming almost a complete circle. The season and trip odometer, with the new resetting device, are all incorporated in this type. All sorts of combinations of speedometers and clocks are made, and at prices which are within the reach of every owner.

Veeder Manufacturing Company, Hartford, Conn.—The exhibit of this firm is complete with a full line of its liquid speedometers in operation at different speeds. The liquid used is either colored alcohol or kerosene, held in a small reservoir at the bottom of the instrument, under which is a centrifugal pump driven by the flexible shaft. The liquid is forced up into

the calibrated vertical glass scale from the periphery of the pump, the height being relative to the speed. Both the odometers are held at the side of the vertical scale, where they may be easily read by the driver.

Warner Instrument Company, Beloit, Wis.—Although the outward appearance of the Warner instruments has been changed some for the coming season, the workmanship remains of the same high order as formerly. These recorders are of the magnetic type, furnished with 10,000-mile season and 1,000-mile trip registers, and an enclosed electric light. The Warner-Auto clock is mounted above the speed indicator if so desired. As an effective antidote for friction and wear, and to insure absolute accuracy of operation, the dial rides in sapphire jewel bearings.

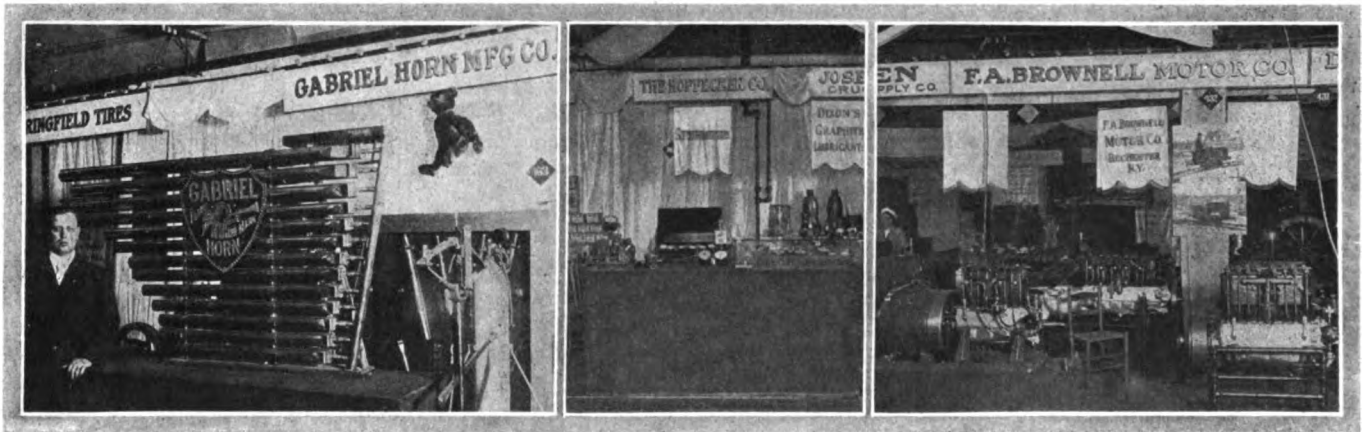

INIMITABLE SIGNAL SYSTEMS EXHIBITED

Automobile Supply Mfg. Co., Brooklyn, N. Y.—In common with many other sundries and accessories made and sold by this concern, the full line of Nonpareil horns was exhibited with telling effect. A new line is being brought out for the coming season, which will appeal to the particular buyer. These horns are on a new patented line and have a rich, penetrating tone. The novelty, compactness of construction, and reasonable prices should make these horns leaders for 1909.

Comptoir d'Innovation Pour Automobiles, New York City.—This concern with the unpronounceable name show an air compressor with another jaw-breaking name, the Delpeuch. This is an excellent little water-jacketed single-cylinder compressor of very simple construction, with no packing or washers. The diameter is 2 3/8 inches, and the stroke 5 1/2. It will work in any position, can be driven by hand, chain, belt, or otherwise, and can be used anywhere that compressed air is useful. This size will produce a pressure of over 100 pounds in a 50-gallon tank in less than 10 minutes, while a smaller size of a simi-

lar type and construction, but without the water-jacket, will give 90 pounds pressure in any tire in less than a minute. The Delpeuch jack and the "Nightingale" horn were also displayed.

Gabriel Horn Mfg. Co., Cleveland, O.—The product of this company is too well known to require any detailed description. So, too, was their exhibit, which was just a showing of good horns. These were present in all sizes, and a human exhaust seemed to be ready at all times to show the tone of any fancied horn. The growth in the use of these pleasant announcers of one's approach has been so great that factory additions are contemplated to care for the additional business. Realizing, too, that an efficient muffler cut-out in conjunction with the horn relieves back pressure and increases the motor power, they have introduced a new design of muffler cut-out valve, which is so designed as to decrease the back pressure.

Garage Equipment Co., Milwaukee, Wis.—Malleable instead of cast iron is used in the construction of the Hux combination muffler and chime valve. There is

a direct passage of the exhaust either to the horn or to the cut-out. While the latter is being used the horn generally is closed. The cut-out and horn valve are independent and both can be used separately, which does away with the necessity of having two valves. Butterflies are fitted and operate on brass pins.

Sireno Company, New York City.—This manufacturer of electric siren horns is showing, besides the older models, two new types for 1909. These, called respectively the "Sireno" and the "Sireno Junior," resemble in external appearance the ordinary searchlight. The former is for touring cars and the latter specially made for runabouts and other small cars. These two new additions to the Sireno family have embodied in their construction a number of improvements which make the horn more flexible, starting and stopping the instant the button is pushed. Both of these new types have ball-bearing motors and will operate on six volts. Interest displayed in these new horns must have been gratifying to the manufacturers, crowds surrounding the exhibit whenever observed.

OIL, GREASE, AND GRAPHITE LUBRICANTS

H. F. Alexander & Company, New York City.—The well-known Panhard cylinder oil, the oil in the checkerboard can, is shown by this firm, which manufactures it under a license. Grease made by these people was also shown. With the great interest displayed in all oiling devices this year, which cropped out in the form of oil or grease cups on every rotating part, it was not surprising to find a crowd before every oil and grease exhibit in the building. The Panhard oils attracted much attention.

Joseph Dixon Crucible Company, Jersey City, N. J.—The discussions in the trade papers during the past year on the relative merits of oil and graphite for lubrication purposes paved the way for the intense interest in the graphite exhibits. The largest of these was that of the Dixon Company, which showed flake graphite for mixture with oil to be used for crankcase lubrication, graphite cup grease, graphite wood-fiber grease for gear cases, chain compounds for chains, pipe-joint compounds for exhaust pipe joints, and many other forms of commercial graphite.

Duffy Grease Company, New York City.—A transmission in action, driven by an electric motor and packed with Duffy's grease, was a feature and attracted a lot of attention from the visitors to the gallery. This company specializes on greases not only for automobiles, but for all forms of machinery and all classes of moving and rotating mechanism. The grease showed that it is good stuff, as it had been running for over twenty-four hours when viewed. This long, hard use had not made it any more fluid than at the start, proving the truth of the company's motto, "Once a grease, always a grease."

A. W. Harris Oil Company, Providence, R. I.—This company adopted a most unusual and original method of displaying its lubricating oils. This consisted of a high, narrow stand on the top of which four slightly inclined cans were allowing oil of the four different grades to flow through a small capillary tube into a large glass stand-pipe, thus showing how the oil flowed and its even color. From the base of the stand-pipes, the oil rose to another series of cans, from which it was allowed to flow upward through a gauge glass drop by drop into a third series of cans. From these it was led out onto open inclined zinc troughs, where the oil could be examined and felt of. Four grades of oil were thus displayed, the light, medium preferred for cylinders, heavy and a new grade called superheated steam, which is of 700 deg. fire test. The whole exhibit was very interesting and instructive. In addition the company were giving away oil barrels—printed on heavy cardboard.

Havoline Oil Company, New York City.—These well-known makers of highest grade oils under the trade-mark Packard, showed small samples of their product, the idea being that the many well-distributed users were a better advertisement than a large space with many glittering lights, uniformed attendants, etc. A line of grease was also shown, including the Packard universal joint graphite grease, non-flowing gear compounds, etc. The exhibit which attracted the most attention, however, was the famous, but high-priced crystal oil, first manufactured regardless of price for the Locomobile racing car, but so good that quantities of it were sold at first at \$2 per gallon. Later an increased demand allowed greater production, which in turn allowed a big reduction of price down to a figure but slightly above the regular price of other oils.

N. Y. and N. J. Lubricant Co., New York City.—The well-known brand of non-fluid oils formed the basis of this exhibit, but the most interesting feature was perhaps the showing of the new Motorol brand of cylinder oil, exhibited for the first time. This is made in four grades: extra light, light, medium and heavy. A special non-fluid oil is shown for use in water pumps. This is a special waterproof production with a high melting point.

Keystone Lubricating Company, Philadelphia, Pa.—Grease, grease everywhere, but not a drop to drink! It is to be hoped at least that no one tried to drink, eat or otherwise dispose of any of the Keystone greases, good as they are for an automobile. Two grades are made, and both were well shown at the Palace exhibit. The No. 1 grade is solid for use on grease cups, axles, pumps and other places where a solid lubricant is advantageous. No. 2 grade, on the other hand, is but semi-solid for transmission and differential

cases, but is fluid enough to allow of its use in grease and oil guns. The quality of this grease cannot be shown in any exhibit, actual use being necessary only to prove their statement that a pound of it will out-wear three or four pounds of a cheap grease or five gallons of an inferior oil. Grease cups in all commercial sizes completed the exhibit.

LUBRICATORS.

McCord & Co., Chicago.—Prominent on the stand of McCord & Co. is a recently developed device styled a class O lubricator, which is designed to give constant sight feeds on the dash, without the necessity of the oiler itself being located there, or the alternative of two lines of piping for each sight feed up to the dash and back to the lubricator. This design attaches to the engine side of the dash with the sight feed projecting through. It is driven by a vertical shaft connecting with the camshaft of the engine, which method of driving, however, can be varied to suit different requirements. Originally the company had intended to get this oiler to draw its supply from an auxiliary tank by means of the combined suction stroke of the small plungers. Experiments, however, demonstrated that this proposition was too delicate for general use.

OIL GUNS, ETC.

Garage Equipment Co., Milwaukee, Wis.—The Perfect combination oil and grease gun is featured on this stand. The device is made of heavy seamless steel tubing with malleable iron top and bottom, while heavy leather washers are used in the plunger as a packing and on the pump between the cap and barrel. When the gun is used for grease it is operated by means of a crank. A gear on the crank is thrown in the mesh with a rack on the pump plunger, and it is operated by turning the crank, this securing a very high pressure. When it is used for oil the gear is slid out of mesh with the plunger rack and the plunger worked up and down in the usual manner. This gun also can handle gasoline.

Randall-Faichney Company, Boston.—Three new sizes of oil guns are ready for this year: a 5-ounce Broadway type, a 5-ounce Back Bay, and a 9-ounce Boulevard. The company is now making and marketing the Webster gasoline gauge, which consists of a hollow ball float resting on the top of the gasoline, and communicating with the dial through a miniature bevel gear on the opposite end of the float stem, meshing with a spur pinion on the lower end of the vertical shaft carrying the indicating needle. The gauge can now be attached without solder.



TOOLS FOR THE AUTOIST IN PROFUSION

W. M. Briggs, New York City.—As representative for a number of tool makers, W. M. Briggs has on exhibit a full line of jacks, tools, and garage equipment. The Joyce-Cridland telescoping jack has some features which single it out as worthy of

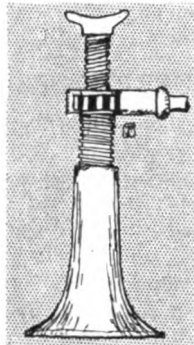

Joyce-Cridland Jack.

attention. It is designed on the double-screw principle, with both the right and left-hand screw working at the same time by the use of a ratchet handle. When down, the height is nine inches, and it has a capacity for three tons.

Coes Wrench Company, Worcester, Mass.—After seventy years of experience in the field of wrench making, the Coes company should be in a position to know something about how a serviceable wrench ought to be made, and the new line for 1909 clearly indicates that even if it is getting into a class ordinarily termed "has beens," where age counts, it will not apply to this firm. Good wrenches are an absolute necessity in the tool kit of an automobile, and the growing demand for those of Coes manufacture shows that they have withstood the hard usage to which wrenches are always subjected.

Elite Mfg. Company, Ashland, O.—“By all means get the best jack you can.” Naturally working along these lines a very excellent product is the result. This, the “Reliable Jack,” is simple, has very few parts, is strongly constructed, reverses readily, is clean to use, and has numerous other good features, which space will not allow mention or description of. This is a screw jack, the screw being turned by a bevel gear, and rotated by the hand lever which works like a ratchet. These jacks

are made in every size and capacity up to 10 tons.

Perfection Wrench Co., Port Chester, N. Y.—The absence of “back lash” in the Perfection wrench is one of its advantages, but it has so many good features that it will be out of the question to do more than call attention to the fact that the wrench can be seen at the show. It will be remembered that this is the wrench which takes the place of a whole kit of wrenches because it is a combination wrench, including the features of a “monkey” and a “Stilson.”

Quincy, Manchester, Sargent Co., Plainfield, N. J.—Tools which are designed to meet the various uses demanded in automobile construction are always a handy thing to have in the kit. This company hit the nail squarely on the head with its Auto Cle wrench, and now comes forth with a junior edition, the Titus Cle, which will probably prove just as useful. This smaller set is furnished complete with handle and set of sockets carried in a small, compact canvas case, which will well repay the initial expense.

ACCESSORIES FOR EVERY POSSIBLE NEED

Austro-American Separator Co., Cleveland, O.—No-Shamy is the name given by the Austro-American company to its gasoline and water funnels, which are to be displayed. As its name indicates, this funnel may be used without chamois, it being claimed that this device separates all water and dirt from the gasoline and prevents it from going into the tank. This is accomplished by means of a double separating process. The automatic separator is installed in the gasoline line, under the footboard of the car between the tank and the carbureter, and it is said that even if the tank is full of water not a drop can reach the carbureter.

Brandenburg & Company, New York City.—This firm's large space is devoted to large things handled by them, as engines, metal bodies, lubricators, etc., so that one interested in wind shields had to look carefully to find it. However, the Ross & Browne shield, which the firm handles, is well worth the search. As shown, it is carefully made of mahogany, brass bound, with plate-glass, and divided just below the line of vision. An unusually stout construction held the upper part up in place, without rattle or jar, and yet was easily and quickly loosened when it was desired to have the glass dropped down, a pair of large milled head screws of brass being the whole operating mechanism, which in itself is simple and effective.

Caloris Mfg. Company, Philadelphia, Pa.—This caloris or vacuum bottle for retaining heat or cold, according to which is desired, has a new feature in that the construction is such as to be practically indestructible. This is secured by making the inner glass bottle separable from the metal case, the bottom of which screws out and carries a spring base. Besides this spring a pad or cushion is used, which rests upon the spring, the bottom of the bottle in turn setting on this. By that method the bottle may be handled very roughly without danger of breakage, in which unexpected and rare event the whole bottle need not be returned to the factory; simply write for a new interior glass portion. For those who prefer it, the bottle may be had with a wicker jacket, which is much lighter than the metal and not so fragile. The efficiency of these were being demonstrated by ice and hot water.

Gemmer Manufacturing Co., Detroit, Mich.—The importance of “steering gear” is well understood by all who may have given the matter a moment's thought. However faithful the pilot, it counts for

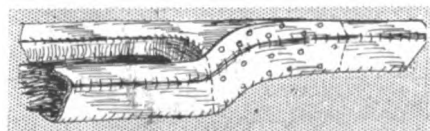

Reinforced Chadwick Frame.

naught if the “wheel” fails to command, and “lost motion,” next to a wheel adrift, is the bane that leads to the “mahogany.” The Gemmer is well represented, and the fitting qualities of the “Gemmer” are clearly portrayed. The double screw idea with means for adjusting to compensate for lost motion is of the greatest value, which, along with the fine materials used in the type, goes the greatest possible distance in the direction of safety.

Gloversville Auto Glove Company, Gloversville, N. Y.—The Ideal Separable glove, for instance, is a new idea, two gloves in one, normally fastened together, but separated at will. The outer is a hard service leather envelope with no opening in front, but fastened at the wrist by means of a strap and button. The inner real imported Angora glove is for warmth and has a double wristlet wrist of extra length. Either may be worn alone or when both are worn together if wet they may be separated and quickly dried. Besides, a full line of excellent gauntlets is displayed. All gloves have the seam on the side and not on the under part of the thumb, where the hand grasps the steering wheel. These gloves are all sewn with “C” silk, no thread being used, and they may be had in any of the popular colors. The cuffs—so important to the automobile driver—are all made of solid leather, on M. W. M. design.

Hydraulic Oil Storage Co., New York City.—The garage system evolved by the Hydraulic Oil Storage Co., is designed to eliminate all gasoline valves. This system, known as the Snell Hydraulic, is based upon the difference in the specific gravity between gasoline and water, and the fact that they do not mix. The tank always is full of liquid, and the fact that there is no air to come into contact with the gasoline prevents a loss by evaporation and protects the tank from possible explosions by fire, electric spark, or lightning. In order to prevent water or dirt being drawn in, the clean oil is drawn from the top of the tank above the water head.

High Wheel Auto Parts Company, Muncie, Ind.—Of absorbing interest to manufacturers, or more particularly assemblers of high wheeled motor buggies or small runabouts, is the complete exhibit of this concern. The principal showing is of the "Wide Range" transmission jackshaft, which could be arranged to be used as a rear axle also. It consists of a two-speed planetary transmission arranged with a shaft encased in a tube. Intended for 10 to 18-horsepower, the sizes of the members, bearings, etc., are large enough to allow a proper margin of safety at the upper figure. Numerous other similar types are made, and the transmission and shaft can be had separately if so desired. In addition, brakes, differentials and other parts are shown.

H. & C. Bottle Mfg. Company, New York City.—The comfort of the drinkers, hard, soft and otherwise, was carefully looked after by these manufacturers of the "Janus" vacuum bottle, when they provided a bottle that can stand an excess of hard usage without in the least endangering the glass interior. This safety is accomplished by the liberal use of rubber, the bottle proper resting upon a pad of it. The makers guarantee the strength, workmanship and durability of the "Janus" to the extent of replacing the whole or any part within sixty days of its purchase. This is the best evidence of its quality, for if it wasn't well made the makers couldn't afford to guarantee it.

Motor Accessories Co., New York City.—This company has on show a full line of accessories of the class now in brisk demand, and it is apparent from an inspection of the accessories offered that the wants of autoists will be well cared for in the hands of this well-known company. All the devices necessary to safely care for gasoline will be found in the list, and the M. & S. magneto is also handled by the company.

Motsinger Device Mfg. Co., Pendleton, Ind.—A new combination cut-out valve capable of cutting out the muffler and blowing a horn was exhibited by this concern. The housing containing it is a tubular cross, two opposite arms of which are equal in diameter to the exhaust pipe

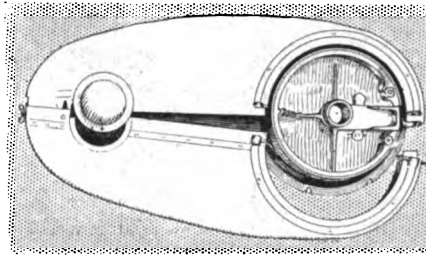

Chadwick Side Chain Boot.

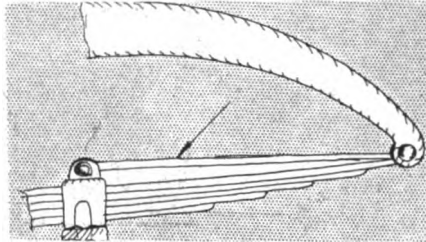

Chadwick Front Spring Spacer.

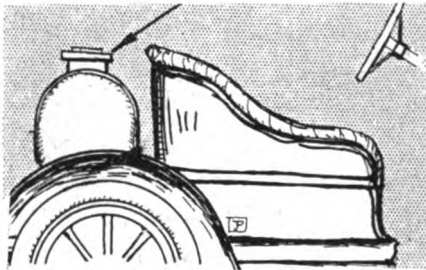

Chadwick Gasoline Tank Filler.

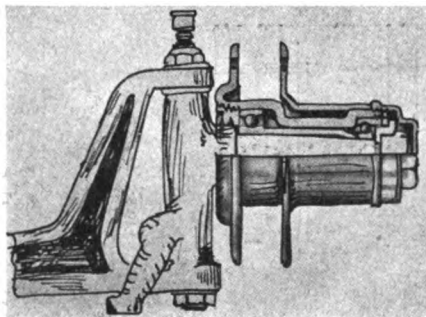

Hess-Bright Ball Bearing Hub.

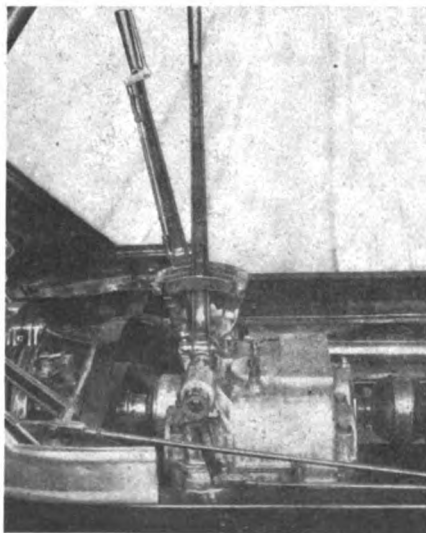

Rockwell Removable Transmission

and threaded to be screwed into the exhaust pipe. The other arms are of different size, that for the whistle being the smaller. Guarding the entrance to these arms are sector-shaped valves rocked by two levers, permitting a separate cut-out and horn control, or both could be in operation at the same time. Also new is the switchboard used for battery charging from the Motsinger igniter. The switch has a three-fold control to allow for charging from the igniter, to run direct from the igniter, or to run from the battery.

Raines & Co., New York City.—The metal polish handled by Raines & Co. is displayed plentifully. In decorating its booth a huge fac-simile tin is used of its Globe liquid polish, five feet high and dummed on a pedestal surrounded by dummy tins of all sizes in both paste and liquid form.

Royal Equipment Co., Bridgeport, Conn.—Besides the well-known brakes for automobiles, this exhibit consists of brake linings. The principal one of these is that which is known by the trade name of "Raybestos," which consists of a wire-woven asbestos tape made from the highest quality asbestos. The belting, for it assumes that form, is made in one integral part or it may be had stamped out for disc clutches, the stamping in no way disintegrating the fabric because of the copper alloy wire freely used in the weaving. Its use is economical because it does not easily burn out or carbonize under the most intense heat. The coefficient of friction is high and it wears for thousands of miles.

John S. Wilkinson, Newburgh, N. Y.—To thoroughly enjoy the advantages which are afforded by owning an automobile, one should have the proper clothing, especially in winter and stormy weather. This company carries a complete line of fur coats, robes, gloves, etc., which are worth looking at. The double plush robe, 54x72 inches, with a rubber inter-lining, furnished with or without muffs, is particularly adapted to automobile use.

SPARE WHEELS

E. T. Burrowes Co., Portland, Me.—As a spare wheel proposition the Burrowes is one now much in use, and, contrary to the predictions of "wiseacres," the spare wheel scheme is spreading like "wildfire." The extra shoe and the tube within is protected while not in use, and when it does become necessary to change, the amount of work to be done is reduced to a minimum.

Spare Motor Wheel Co. of America, Chicago, Ill.—This concern, manufacturers of the well-known Stepney spare wheel, are almost too well known to need mention. This device for helping to save time, when the ever occurring tack or blow-out appears, is simply a standard clincher rim, without the hub or spokes, having four clamps for securing it to the rim holding the injured tire.



Annual Show Luncheon of the American Motor Car Manufacturers' Association, Held at the Hotel Manhattan, Tuesday Noon, January 5.

THE ANNUAL A. M. C. M. A. SHOW LUNCHEON

MOST successful yet of its annual show luncheons was the usual function of the A. M. C. M. A., held Tuesday noon at the Hotel Manhattan, with covers laid for some 200 participants. Benjamin Briscoe, chairman of the association's committee of management, and H. O. Smith, chairman of the show committee, flanked Job E. Hedges, the effervescent toastmaster of the occasion. R. M. Owen, S. H. Mora, E. R. Hollander and D. J. Post were other committeemen in evidence at the speaker's table, with Alfred Reeves, the general manager, modestly seated down the line. Others at the center board were Roger B. McMullen, the former general manager of the association; H. S. White, president, and Peter S. Steenstrup, secretary, of the Motor and Accessory Manufacturers; James Couzens, former chairman of the committee of management; Robert Lee Morrell, representing the Automobile Club of America; F. H. Elliott, secretary, American Automobile Association; Jefferson deMont Thompson, ex-chairman A. A. A. Racing Board; A. R. Pardington, general manager Long Island Motor Parkway; Henry Ford, R. E. Olds, J. D. Maxwell, W. C. Marmon, W. H. Van Dervoort, G. Vernon Rogers, R. A. Parker, J. B. Prindle, Horace DeLisser, Henry M. Duncan and Marcus Nathan. Scattered about the room were many notables of the trade and sport, F. B. Hower, chairman of the A. A. A. Contest Board, being one of these.

Following the facetious introduction of Toastmaster Hedges, Chairman Briscoe indulged in a little humor himself and then developed seriousness as herewith presented:

What Chairman Briscoe Had to Say.

I would, did it not appear vain, congratulate the entire automobile industry on the great success of this show, but just bear with me when I say, "they have got to go some to beat it." (Applause.) Surely it is, in attendance, in business interest manifested, in completeness of preparation, one of the greatest automobile shows ever held in this country. (Applause.)

Publicly I want to thank the Show Committee members, Messrs. Smith, Hollander, Post, Owen, and Mora, for the good work they have done.

I feel impelled also to voice the most universal thought held in connection with this show. I will lead up to it by saying that we all know that it is a more valuable attribute to be able to pick "good ones" than to be "good ones" yourselves, and by that token does the Committee of Management of our association shine in at least one particular, for it picked not only a "good one," but one that makes good anywhere you put him, a manager six and a half feet tall in sincerity, in judgment, in intuition, and in energy, and all else that goes to make a true, a noble, and an efficient man. Mr. Manager Reeves, on behalf of this association and on behalf of the exhibitors, I thank you most heartily.

I never participate in any gathering of men in this industry, representative of all its branches, but that I congratulate myself at being among them, and that together it has been our privilege to be the pioneers of the automobile. For this industry is even now but in its infancy, and it is we who are having its early burdens to carry and who are making the experiments and the sacrifices of pioneerhood.

In time to come, say fifty or one hundred years from now, when the apex of its development will have been reached—when the automobile will then have been so long a universal thing that those generations will not even stop to think or to be concerned about where and how it came—when we who are here now will but exist only in the memories of the oldest inhabitants, and when whatever fame we may have been possessed of may rest only as it is chronicled in the dusty and brittle pages of those few copies of the trade papers which may have perchance survived the ravages of time—then, gentlemen, where'er our spirits dwell, they may be justly proud (were such a mortal attribute still possible with them) of having dwelt within our earthly selves, and that we helped according to our ability and our inspiration in these, the early stages of the development of the automobile.

For it is good work we are doing—a worth while mission to accomplish. 'Tis true we are but plain business men, yet this particular work has been given us to do: to pioneer one of the greatest complements of civilization. The greatest economizer of time since the telephone and the telegraph; the greatest lifter of man's burdens since the steam locomotive, for truly it is, as Macaulay says: "Of all inventions, the alphabet and the printing press alone excepted, those inventions which abridge distance have done most to advance civilization."

Busy as we are, then, gentlemen, it is well for us to stop often and consider the important part that has been given to us to play in the drama of life. The more we do, the broader and less selfish men we will be, and the more and more will we grow into an appreciation of our true responsibilities, and especially of the co-operative relationship we bear toward one another.

We must not allow ourselves to think loosely of the part our neighbor plays, nor to uncharitably criticize or gossip of his works or his errors, but we must push forward, shoulder to shoulder, as pioneers should, remembering that though various are our talents, yet have we all our own particular colors to brush upon the picture, and that as our hearts and our minds are, so will that picture be of our life's work, as perfectly and as beautifully done as we ourselves may make it, and as our inheritance to posterity.

Chairman Smith on the Show Question.

Next came H. O. Smith, chairman of the show committee, and among other things he said:

I cannot refrain from comparing this gathering with another held four years since at the Breslin Hotel, with a total attendance of four. I refer to the first meeting which had to do with the forming of the American Motor Car Manufacturers' Association; and yet if we reflect, we will see that the growth of this association has been but a few years.

While this industry has already taken a position of prominence among the first in the country, who would attempt to predict its limitations five or ten years hence? The automobile shows have unquestionably supplied their part in the great march of progress. While it is a fact that most practices employed in the modern motor car are old mechanics, being merely put to new uses, yet experience was necessary to guide the builders in determining the conditions to be met and the best way to overcome the obstacles.

The shows have proved a clearing house for ideas, until to-day, with the wonderful fundamentals characterizing each type, we can agree that we have gone far toward standardization. The shows have also had the effect of not only interesting the public in motor cars, but impressing the importance and magnitude of the industry. May I add, in conclusion, that the management feels grateful to the exhibitors, the dealers, and patrons who have contributed to the success of the Ninth International Automobile Show and made it the greatest ever held in point of attendance, general interest, and actual business transactions?

S. H. Mora, another member of the show committee, interested his hearers and told of the unsought "honors" which come to a hard working member of the show committee.

Robert Lee Morrell spoke for the Automobile Club of America, he being one of its vice-presidents. He expressed the opinion that the show was the best one of its kind the city had ever seen, despite the fact that it was the first year in which the A. C. A. had not been identified with such an exhibition. He told of the efforts of the club in desiring to better automobile conditions generally.

Henry M. Duncan supplied humor which met with considerable success at the hands of his hearers.

All around, the affair was enjoyable, with just about enough talk to satisfy those present.

CROSBY NOW PRESIDENT A. A. C. OF N. J.

NEWARK, N. J., Jan. 4.—The Associated Automobile Clubs of New Jersey held their annual meeting Saturday night at the clubhouse of the New Jersey Automobile and Motor Club, the election of officers resulting as follows:

President, W. Clive Crosby, of Orange; first vice-president, Walter E. Edge, of Atlantic City; second vice-president, E. H. Radel, of New Brunswick; secretary and treasurer, Horace A. Bonnell, of East Orange.

There followed a conference on the legislative situation, though nothing was announced concerning it through the usual channels of publicity. The impression prevails that some modifications of the present unsatisfactory law will be obtained before the Winter session of the legislature is over.

Besides the "trapping" abuses, the lack of reciprocity with other States in registration is the particular phase of the present law which excites the greatest antagonism.



Members of the Society of Automobile Engineers Assembled in the Dynamometer Room of the Automobile Club of America.

AUTOMOBILE ENGINEERS MEET AND ELECT NEW OFFICERS

By CHARLES B. HAYWARD.

AT the fourth annual meeting of the Society of Automobile Engineers, held at the Automobile Club of America, Tuesday, the following officers were elected for the coming year:

President, Henry Hess, Hess-Bright Manufacturing Company, Philadelphia; first vice-president, Russell Huff, chief engineer of the Packard Motor Car Company, Detroit; second vice-president, B. D. Gray, chief engineer of the American Locomotive Company, Providence; treasurer, Allan H. Whiting, New York.

The two managers for the term of three years to fill the vacancies expiring at this meeting are David Fergusson, chief engineer of the George N. Pierce Company, Buffalo, and Prof. R. C. Carpenter, of Cornell.

Despite the unpleasant weather, the largest number of members of the society that has ever attended a meeting convened at 10 o'clock in the morning. It was the fourth annual gathering, and the prospect of having an opportunity of inspecting the club's fine dynamometer proved an attraction to many of the members from the West. By 10.30 there were 80 members on hand, and the morning session then began, with President Thos. J. Fay in the chair.

The first thing on the program was an inspection of the dynamometer, an explanation of its construction and workings being given by Henry Souther, a member of the society, and the chairman of the A. C. A. technical committee. After having detailed the operation of the various parts of the apparatus at length, a Pierce Great Arrow 6-60, 1909 model, was run upon the rollers, through the courtesy of Chief Engineer Fergusson, of the George N. Pierce Company.

Owing to the large number in attendance, which made it difficult for more than a small part of the members to observe the action of any one of the recording instruments, with the exception of the huge chart, it was deemed inadvisable to attempt to carry out a regulation test, so that after the car had

been run at various speeds and loads simply to illustrate the operation of the dynamometer as a whole, a 10-minute test on the high speed was made, the car showing 44 horsepower at a speed of 46.2 miles, the drawbar pull of 355 pounds indicating that the load applied by the hydraulic brake on the drums gave the equivalent of a grade slightly in excess of 10 per cent. The members then adjourned to the floor below for an inspection of that part of the apparatus situated below the floor on which the recording instruments are placed. This consists of the drums, the hydraulic brake, and an electric motor, all mounted upon the same shaft, which is carried on large annular ball bearings to minimize the friction losses at that point, making the error in readings on that account practically a negligible factor. The electric motor is employed to run the drums when it is desired to measure the friction losses in a car.

Following this, the members adjourned to the reception room on the main floor of the club for an informal discussion of the dynamometer and its operation, as well as the value of its records. Numerous points were taken up, but the discussion chiefly bore upon the factor of power loss due to the tires alone. Not only tires of different makes, but different tires of the same make will be responsible for varying percentages of power loss at the driving wheels, while different types of tires of the same make, such as the round and flat tread, introduce a further variable, so that the tire factor in this connection was very aptly described by Mr. Souther as a "multiple variable." It has long been well known that tires were responsible for a difference in the mileage of an electric vehicle, frequently amounting to as much as 60 per cent., where a specially light, single-tube type was employed, as compared with what is known as the regulation "gasoline" type of tire, i.e., one consisting of a separate tube and a heavy outer shoe. The use of any form of non-skid device, such as studs of any nature, is responsible for a further

increase in the power loss at the road wheels, a series of tire tests now being carried on by Mr. Souther showing that the amount absorbed at this point ranges as high as 2.5 horsepower per wheel in some cases, and drops very low in others, although as yet there has not been sufficient time to test more than a limited number of types.

It was contended by some of the members that this extreme variation in the power loss due to different tires was likely to render the dynamometer readings of very uncertain value as records of the transmission losses in a chassis, and that the only way of overcoming this would be to mount the same tires successively on the rear wheels of the cars under test in order to obtain a constant. But a further difficulty crops up there in that the wheel diameters vary and that this introduces a further variable in that the loss is decreased with the increasing diameter of the wheel, besides being altered by differences in the cross section of the tire.

The discussion was very general, and during the course of an hour or more a great many points of interest were brought out in connection with tests on the club dynamometer, as well as with regard to tests generally. Owing to the temporarily enforced absence of Mr. Souther, his assistant, Mr. Chase, took his place in the discussion.

An adjournment was had for lunch about 1 P. M., which was served at the club, and immediately upon the conclusion of this the business meeting was called to order by President Fay. The report of the finance committee for the previous year was then read by the treasurer, Henry Hess. It showed the society to be in a most prosperous condition, its income for 1908 being close to \$8,000, whereas for 1907 it was less than \$1,500.

In the absence of the chairman of the membership committee, the report of the latter was read by Secretary Hayward, and it revealed a correspondingly great amount of progress, the membership having jumped from 116 at the end of 1907 to 280 at the close of the past year.

The report of Chairman P. M. Heldt, of the committee on professional papers, was also read by the secretary. During the past year no less than 19 papers have been prepared and read at the four quarterly meetings, but difficulty has frequently been experienced in getting them ready on time, due to members either not fulfilling their promises to supply copy and illustrations at a certain date, or, what has been equally frequent, not at all. This was followed by the report of the secretary, giving a general résumé of the activities of the society during the year just past, and dwelling particularly upon the establishment of the society's employment bureau. Considerable attention was also devoted to the matter of a more generous response to the call for papers than has hitherto been the case, the suggestion of Mr. Heldt that it be made a feature of the dinners held in connection with the society meetings to call for suggestions for new papers being heartily seconded. The reports of the various committees were approved as read, and it was decided that they be published in the following issue of the transactions.

President Fay then appointed Joseph Tracy chief teller of election, with Alexander Churchward, Henri G. Chatain, A. Bergman and J. G. Crowley as assistant tellers, to count the ballots cast for the nominees for offices falling vacant at the fourth annual meeting. Mr. Tracy announced that a total of 88 ballots was cast, of which five were void, the remainder being straight tickets, so that the election was unanimous.

President Hess then took the chair, and the paper on "The Modern Trend of Brake Design," by Lawrence Whitcomb and Thomas J. Fay, was read by Mr. Fay. A number of interesting points were brought out in the discussion, which lasted considerably more than an hour.

"What Constitutes Ignition Reliability," by A. Atwater Kent, was then read by the author, and during the course of the reading of his paper Mr. Kent illustrated, by means of an apparatus which he had constructed for the purpose, a number of the points dwelt upon in his paper, showing in a striking manner the contrast between the duration of the contact dwell of the ordinary form of roller timer and that of the Atwater Kent

contact maker, as well as the lag at various speeds. A lively discussion ensued, and, as is always the case where the subject of ignition comes up, many questions of general interest apart from the subject as treated by the paper were brought up. Chief among these was that of the advantage of a fixed point of ignition, as compared with provision for advancing or retarding the time of ignition, a paper being promised on this subject for the first quarterly meeting of 1909 at Boston.

At 7 P. M. the members sat down to the annual dinner of the society, which was served by the Automobile Club, and upon the conclusion of this an adjournment was taken to Tuesday, January 19. A vote of thanks was tendered the club for its hospitality.

On that date members will again meet at the Automobile Club at 10 A. M. for a session with the club dynamometer, following which the technical sessions will be held in the Engineering Societies' Building, in Thirty-ninth street. The papers to be read are: "The Economics of Weight Reduction," by F. D. Howe; "An Improved Type of Compression Coupling," by W. S. Noyes; "Standardizing Motor Bearings," by S. P. Wetherill, Jr.; "Some Practical Considerations in Autogenous Welding," by Henry Cave, and "An Indicator with Continuously Rotating Drum," by S. W. Rushmore and H. L. Towle.

Among those present as shown by the register were: A. Atwater Kent, E. T. Birdsall, A. L. Riker, H. M. Swetland, David Ferguson, Thos. J. Fay, Lawrence Whitcomb, Henry Hess, Prof. R. C. Carpenter, Prof. F. R. Hutton, H. Vanderbeek, A. H. Raymond, Ernest L. Smith, René M. Petard, Amasa Trowbridge, Chester E. Clemens, Charles B. Kirkham, H. H. Brown, Louis M. Pawlett, Henri G. Chatain, H. F. Donaldson, Henry Souther, Alanson P. Brush, J. W. Bate, Joseph Tracy, J. A. Anglada, Alexander Churchward, H. L. Towle, Dempster M. Smith, Charles Cuno, George C. McMullen, Charles E. Reddig, W. R. Hudson, C. E. Davies, B. D. Gray, Lindley D. Hubbell, Julian Chase, M. R. Hutchinson, W. B. Hasselkus, Al C. Bergman, Frederick Charavay, E. S. Foljambé, Marcel de Jarny, E. W. Winans, B. G. von Rottweiler, A. L. McMurtry, Raymond Cilley, M. S. Young, Henry Cave, H. K. Holsman, R. E. Northway, Ernest Wilcox, W. G. Wall, W. T. Powers, William Herreshoff, Clarence E. Whitney, R. S. McLaughlin, P. M. Heldt, J. G. Crowley, M. C. Krarup, E. F. Schnuck, C. B. Hayward and a number of guests.

SILENT KNIGHT IS COMING HOME.

Within a fortnight it is expected that one of the new Daimler demonstrating automobiles will arrive in America, and the fraternity will have a chance to gaze upon the latest phase of the "Silent Knight" motor, as it is now being used in Daimler cars. One of the make is now in the country in the hands of a private owner. D. W. Whitford, until recently connected with Palmer & Singer Company, but now associated with K. Mandell, of K. Mandell & Company, exporters and importers, at 79 Worth street, New York City, is to manage the agency. While the Knight motor will be the "novelty" in the 1909 British Daimler, the fact that wire wheels are used will attract more than a little attention in this country. As respects the Knight motor, it will be remembered that it is an American invention that drifted across, after a trial here that did not seem to make a commercial go of it. Some changes have been made.

WRIGHT HOPES TO SAIL FOR FOUR HOURS.

LE MANS, France, Jan. 2.—Wilbur Wright gave his last airship demonstration here to-day, carrying with him in four different flights members of the Aero Club of Sarthe. Mr. Wright is preparing to proceed to Pau, where he will remain a month, giving instructions as to the handling of his machine. He then goes to the United States.

Mr. Wright said to-day that he expected at an early date to fly for more than four hours, and from 125 to 150 miles, by the use of new motors.

GENERAL GOSSIP OF THE PALACE SHOW

The First Automobile.—The old steamboat shown at the Maxwell-Briscoe commercial space caused many people to remark: "What is that old thing?" Now, it seems that the remark, particularly the "old" portion of it, was in good form, for this car was built in San Francisco in 1876 by a Mr. Wilkins. It is believed by the present owners, the Maxwell-Briscoe Motor Company, that this was the first gas-propelled vehicle ever built. As shown on another page, it will be seen to resemble closely the modern high-wheeler or motor buggy, with the exception perhaps of the "blinds" in front and the three seats.

Typographical Error.—In our large show issue of December 31, an error in the advertising of George A. Haws, manufacturer of the well-known Panhard oil, "put up in the checker-board can," made it appear that this lubricant has been on the market since 1903, when the fact is that it was not produced until November, 1904.

Holsman Entertains Its Agents.—The Holsman agents in attendance at the show were entertained at a Sunday dinner at the Hotel Knickerbocker by the Holsman Company. Plans and policies for 1909 were outlined, and the new 26-horsepower, four-cylinder, all ball and bearing motor, was thoroughly discussed. This motor has aroused a remarkable interest among visiting agents and prospective purchasers.

Moon Very Busy.—The press of business at the Moon Motor Car Company's factory, at St. Louis, was so great that Stewart McDonald, vice-president and general manager, was unable to get away for the Palace show. New agencies, particularly in the Southwest, are so urgent that the factory must be pressed to its fullest capacity, and "Mac" had to stay home and do the pressing.

The A. A. A. Tour to Be in July.—Chairman F. B. Hower, of the contest committee of the American Automobile Association, announced Tuesday that the entry list for the 1909 A. A. A. tour, which includes the contests for the Glidden and Hower trophies, is now open and that the date of the start would be some time during the week beginning July 5. Chairman Hower and Secretary D. H. Lewis were visitors at the A. M. C. M. A. show in the Palace, but would give no information concerning the route or any further particulars of the tour. A fee of \$200 will be charged for cars entered prior to May 15, and \$300 thereafter until June 15, when the entry list will be closed. The temporary blank calls upon the entrant to state whether his machine is a touring or roadster type and the style of body, also whether it is entered for the trophy certificate or in the non-contestant class. An inventory of all parts carried must be furnished in addition.

Cork Inserts on the Job.—The Premier Century car, of which so much has been heard in the past half year, is at the show, and from all appearances and reports is ready at a moment's notice to repeat its 1908 century and other performances. This car's brakes are fitted with the cork inserts of the National Brake & Clutch Company, Boston, and it was the verdict of the judges who examined the car at the end of the century-a-day-for-a-hundred-days' performance that these brakes merely showed that they had been in use, so little did the cork inserts show the evidences of that furious test.

FRANCE WILL NOT HAVE ITS GRAND PRIX.

According to private information received this week from the Automobile Club of France, a sufficient number of entries have not been secured for the Grand Prix, scheduled to be run in the Château country in July. Only nine actual entries were made when the minimum required by the club was placed at thirty. Therefore, there will be no Grand Prix, and probably no Circuit des Ardennes and no Florio Cup race. Exactly what will happen now in foreign automobile racing remains to be seen.

American Automobile Association, 437 Fifth Avenue, New York.—The booth of the A. A. A. was a rendezvous for visiting autoists from all parts of the country, the information sought in the majority of instances naturally being that concerning the holding of the annual "three A" tour for the Glidden and Hower trophies this Summer. Secretary Elliot was in charge to answer questions regarding the advantages of being an A. A. A. member, and numerous applications were received. Numerous pamphlets detailing the varied activities of the association were distributed.

Automobile Club of America, West Fifty-fourth Street, New York.—The club devoted its exhibit at the show, which is the first in which it has not participated in a managerial capacity, to the work of its touring bureau, of which Waldron Williams is the chairman. The bureau is actually in charge of A. L. Westgard.

National Retail Automobile Dealers' Association, Oshkosh, Wis.—One of the meetings held during the course of the show was that of the new organization of retail automobile dealers, which first came into existence during the Chicago show last year. The objects of the association are to better the conditions of its members generally and to place them on a better footing with the manufacturers, and the subjects discussed at the meeting were entirely on lines such as discounts, methods of selling, demonstrating cars, and the like.

International School of Aeronautics, Morris Park, N. Y.—There have been few shows which have not been productive of some entirely new form of exhibit as the result of developments either in automobiling or in lines associated with it, and the show at the Palace proved no exception, as may be seen from the present instance. Naturally such a school would not have a great deal to exhibit, apart from apparatus and photos of ascensions, but it was an interesting spot for a large number of visitors.

Big Smoker at the A. C. A.—Probably what was the largest crowd ever assembled in the home of the Automobile Club of America was that which attended the show smoker of Saturday evening last. The big assembly hall was filled to suffocation, and the smoke was so thick that it could be cut with a dull knife. Chairman Orrel A. Parker, of the club's entertainment committee, provided satisfactory enjoyment for those present.

The Assistant of the General Manager.—First the A. M. C. M. A. had to find a good general manager. Alfred Reeves got the job. Then the general manager needed a good right-hand man. Lee Myron Bradley secured the place. That he fills it exceptionally well has been apparent to all those who have come in contact with him before and during the show. Once upon a time he lived in Providence, and he is an ex-newspaper man.

Humphreys, Editor "The Missing Spark."—There's a very conservative and excellent paper called the New York *Evening Post*. It doesn't give its automobile expert any vast amount of space for his gossip of the industry and sport. Therefore, Major Humphreys periodically issues *The Missing Spark*, wherein he gives personal attention to his friends in scintillating paragraphs.

FINAL PLANS FOR BUFFALO SHOW.

BUFFALO, Jan. 6.—The 1909 directors of the Automobile Club of Buffalo held a meeting yesterday afternoon, at which the 1909 Buffalo Automobile Show question was definitely settled. It is to be run by the Automobile Club of Buffalo, the week of March 1. The Buffalo Automobile Trade Association has been given the privilege of appointing one of its members, the trade interests outside to appoint another one, and the two to appoint a third person to form a committee of three.

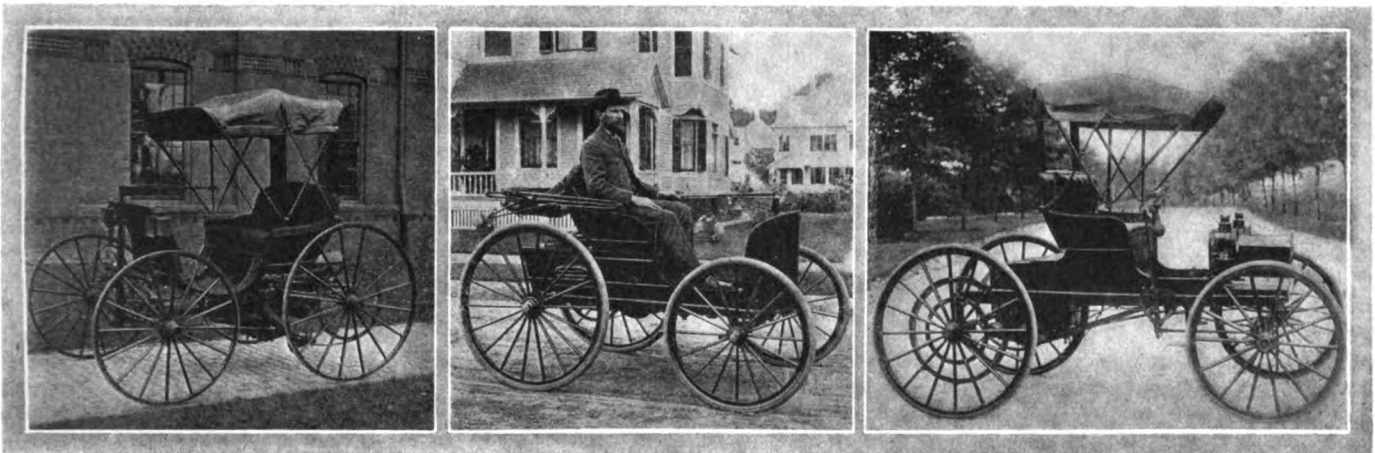

Duryea Gasoline Buggy of 1893.

Single-cylinder friction transmission, electric ignition, spray carbureter, one-hand central control.

Winner Chicago "Times-Herald" Contest.

Two-cylinder, double gear drive, individual clutches, three speeds forward and reverse, artillery wheels.

Duryea Buggyabout, 1909 Pattern.

Two-cylinder, two-cycle, air-cooled, fitted with Duryea grooved roller drive.

AS IT WAS IN THE BEGINNING

By CHARLES E. DURVEA.

“WHAT started the demand for automobiles, and who first attempted to fill it?” Quite a natural question, but it is based on a misapprehension. Radical things are never demanded. Improvements are sometimes asked for, but the really great steps in advance are usually so far ahead of the public that they decry rather than ask for them. The first Jacquard looms were destroyed; harvesting machines burned in the fields; the telephone was laughed at as a funny toy; and the power vehicle, “Pooh! I prefer to drive something with life.”

Such was the feeling of the public toward a self-propelled buggy during the '80s, when I was considering it most carefully. The idea was not a new one. It ran back beyond the dawn of history. Homer describes Vulcan's work for one day as “a full score of wheeled tripods, spirit moved.” Many a modern factory would be proud of such an output. Time and again the problem was essayed by some venturesome mechanic or engineer, only to end in ridicule and failure.

About a century ago, when the new steam engine was being developed, many attempts at self-propulsion were made, and from 1820 to 1844 motor passenger vehicles and stage coaches were much used in England and carried thousands of passengers. The advent of the locomotive and restrictive laws drove the auto out of existence there, and left it for Germany, France and America to revive 50 years later.

With the expiration of the Otto patents on the four-cycle engine in 1886 there began a great advance in this type, and some very light ones were produced by Daimler and Benz in Germany and taken up by French makers in the early '90s and pushed so vigorously that all the world took notice.

About this same time I concluded the public would be ready to accept a power buggy by the time one could be perfected, and in 1891 I began work on a simple design, which followed horse buggy lines as closely as possible. It was my thought that a buggy which ate no oats and caused no expense when not in use could be sold to people unable to afford horses, and that the more closely it copied the horse buggy the better. A driver of horses during all my early life, I too, felt the love of the animal and did not believe that any one able to have the horse-drawn vehicle would care to use the machine. But I expected the low price and maintenance cost to go far toward creating a demand.

The first one, finished in 1892, was, like all first attempts, underpowered and given very little service; and so careful was I to avoid any more charges of lunacy than necessary, that it was not shown to many and was not photographed. It was partly rebuilt, and then abandoned to build an entire new rig, which was completed in September, 1893. This is shown in the accompanying photo and was finished before the product of any other

present-day American maker had been begun. It ran many miles and opened a new era. It demonstrated that the power vehicle was superior to a horse-drawn one and that the market desired could be created among the wealthy if the product was superior. It was entered for exhibition at the Chicago World's Fair, but not exhibited because it was not the future immediate type.

Its successor, begun in the winter of 1893-4, was finished in the Fall of 1894 and was a modern automobile in that it had multiple cylinders, three speeds forward and reverse, transmission by gears, pneumatic tires, artillery hubs, water tank in front, engine shaft lengthwise the vehicle, throttle control, spray carbureter, electric ignition and many similar features, some of which its predecessor did not have. After a successful service during the summer of 1895, it was entered in the first auto event in America, the *Times-Herald* race at Chicago, on Thanksgiving Day, November 25, 1895.

This contest was an attempt to duplicate over the vile roads of America the splendid successes which the power vehicles of France had shown in a French race in June of the same year. Prizes amounting to \$5,000 were offered and 83 entries secured. But the American winter was perverse and an unusual blizzard had buried the roads beneath 18 inches of snow, which on the morning of the race was covered with a frozen crust on which pedestrians walked and sleighs glided, while horses and heavier vehicles cut through. No wonder that but seven started in the face of this, and it is great wonder that any got through; but the Duryea won (first prize \$2,000) and was the only vehicle to finish without being pushed or towed and the only one to leave and return to its garage under its own power.

The best German and French vehicles were entered, but only one, a Benz, was able to get through, winning the second prize. The prize winner was used for a year or so as a demonstrator, and then sold for \$1,000 at second-hand and gave its buyer good service, a clear proof of the superiority of American autos even at that date. Its neat and graceful lines, as shown in the photo herewith, would not make it look out of place among some of the high-grade electrics of to-day.

But skeptical buyers could see no good at home. The faults of the foreign cars were not visible. And the gasoline car could not win popularity on its own soil. Foreign makers said, “We were beaten by the weather.”

So when the first British run was announced, a Duryea rig took its position well to the rear of nearly thirty entries, including the three leading vehicles in the great French race of 1896 and the drivers that had run them to victory. The distance to Brighton was 52 miles, and the Duryea covered this so quickly

that it was ahead of the judges and assumed not to be in the race, having beaten the next vehicle by about an hour. This happened November 14, 1896, in the "Liberty day Run," held to celebrate the legal victory which undid the oppressive law of 1844.

For years this unique victory of an American auto over foreigners on their own soil was the only instance of its kind, but not till American buyers and makers had gotten their fill of toy steamers and such follies could the gasoline vehicle come into its own. And even then it was necessary to go abroad for designs. Such is the peculiarity of human nature.

And the end is not yet. That vehicle which meets the needs of wealthy tourists in Europe is not the one for the great American masses. Thousands of small copies well made and very capable are being sold, but slowly the American public are learning by experience that their daily needs can be better served by reversion to the original type. The prejudice against power vehicles has been largely broken, the sanction of the leading classes has been gained, the auto has won its spurs and proven its ability at all seasons of the year.

The 34-inch and 38-inch wheels of the "London to Brighton" winner find their counterparts on nearly all the better autos at

the 1909 auto shows, and one really wonders, "Why the small wheels of five years ago?" The absence of single cylinders suggests that the Chicago winner and its successors ought to have been followed. Other features could be mentioned, but the question is, "What is the lesson?" Simply this: The needs of the masses who could not afford horse-drawn vehicles in 1891 are still unsupplied in 1909. The masses to-day are rapidly beginning to demand the motor buggy or some power vehicle which will take the place of the horse vehicle so largely used. The conventional auto has required the most expensive selling machinery ever utilized to market any product, but as the public become convinced of the economy of the motor buggy, the demand will rapidly grow and the foresight of the prophets of 15 years ago will be fully vindicated in the very near future.

The number of motor buggies now being offered is rapidly increasing, some of them are extremely simple and therefore almost certainly free from trouble. They are light in weight, economical in fuel, easy on tires and for speeds below 20 miles per hour are extremely satisfactory. They may be accepted as a very proper reversion to the original type in mind when the first autos were constructed.

CONCERNING NOISE AND ITS AVOIDANCE

By C. H. TANGEMAN.

"KNOWLEDGE" applied to automobile construction is the ability to design a chassis in which those features of construction that tend to noise are ingeniously dealt with, and the ability to assemble the parts of the motor and transmission in a manner which tends to produce the least noise.

In a car where construction details include the elimination of noise, as in the case of such cars as the Lancia, which we happen to handle, there are practically only two details to be considered: First, the motor; second, the transmission. In the motor are the valve lifts, which, actuated by camshafts, strike and then lift the valve from its seat. It can readily be understood how this process of striking of the valve stem, as with a hammer, produces noise. This can be eradicated only by reducing the blow to a minimum. In the Lancia this is accomplished by timing the valve lifts so that there is virtually no lost motion between the lift and valve stem. In a chassis recently arrived from Europe we found that even the thickness of a single sheet of cigarette (tissue) paper cannot be introduced between these two parts. When the lift, therefore, rises and strikes the valve stem, it has not as yet attained a great speed, as the cam is only commencing its lift; the blow is therefore very light and the noise consequently reduced to a minimum. As an illustration of the foregoing, try striking a nail with a hammer. When the hammer is held only an inch from the head of the nail less

noise will result upon striking than when held a foot or more away and the nail then struck from that distance.

The only other noise connected with the motor is that of the exhaust gas. This subject, which must be carefully considered in designing the exhaust piping and muffler, is one which in the Lancia has been very satisfactorily treated, resulting in an exhaust pipe of unusually large size in a muffler much larger than has heretofore been considered necessary for a motor of the dimensions employed. The gas, therefore, expands freely and rapidly, and by the time it is discharged into the atmosphere the noise has been muffled or deadened by its extreme expansion. I do not believe that in any motor the noise caused by the explosion within the cylinders is heard by the riders in the car, or even by people passed along the road, except the motor is of very high compression and then it can only be heard when the car is at a standstill and the bonnet opened.

Taking up the transmission of the car, which is the only remaining source of noise, I contend that it is merely a matter of proper design, assembly and finish to overcome all noise.

There is no "trick" employed in attaining this most sought-for feature. It is merely knowledge of the causes of noise and then the ability to reduce it to a minimum. Absolute silence is an impossibility in the present practice of the art, but each year we acquire more knowledge and greater ability.

COL. CLIFTON ON THE RECENT PARIS SALON

"AS a demonstration of the discrimination of the American automobile buyer, the Salon was a marked success," in the opinion of Charles Clifton, of the George N. Pierce Company, Buffalo. Col. Clifton attended the annual exhibition at Paris and has just returned home.

"Ever since automobiles were first manufactured in Europe," Col. Clifton says, "the makers of France particularly, and Germany and Italy to a great extent, have depended on England and the United States for a market for a large part of their product. This foreign trade has encouraged them to make advances in construction and bring out new ideas. But this country and England have progressed now to a point where our practices are, at least, on a par with continental Europe. Discriminating buyers have come to realize that the car built in this country is suited best to the needs of this country. He realizes, too, that his American-made car answers his purpose in Europe

as well as any European-made car. The consequence is that the encouragement they received formerly has been taken from the makers of France, Germany and Italy. Little has been done by way of improving their cars and bringing out new models.

"It would not have paid the automobile enthusiast to visit the Salon this year with the sole view of seeing new models. There have been no radical or even pronounced changes in construction. The automobile designer would have found less to interest him than at any previous Salon, although there were matters that would have caught his attention. These were principally in the way of new materials for certain parts and improvements in accessories.

"Altogether the Paris Salon gave the impression of being a striking illustration of the trend of American buying—the fact that the people of the United States are now buying cars made in their own country."

Matheson Gets Three Out of Four in Quaker Club Run

BY G. M. SCHELL

PHILADELPHIA, Jan. 4.— If Friday's and Saturday's performance of the contenders in the third annual New Year's run of the Quaker City Motor Club means anything, 1909 will be a Matheson year. Under conditions which precluded the possibility of all-round clean scores, the three Matheson entries finished 1-3-4; the Franklin "28," driven by C. S. Carris, capturing second place. A pair of Cadillac "30's," driven respectively by Edward Burnshaw and William Crawford, finished fifth and sixth— noteworthy performances, both of them.

The last-named car was the winner of the \$500 side wager with the Class B Maxwell 24-28, driven by William Longstreth, the terms of the bet being that any car listed at \$2,000 or under that would have a lower score than the Maxwell should scoop the pot. The Cadillac-lackers called the defi, put up their \$500, and suffered but 139 demerits, as against the 528 chalked up against the Maxwell. The winning car was F. M. Kirby's 45-50 Matheson, and the 11 points penalty was made up of one observer's demerit and 10 inflicted by the technical committee. Aside from this one point, which was garnered on the second day, the road work of the Matheson trio was perfect, the other demerits being made up of faults found by Chairman Swain's technical sharps.

Class B honors went to "Bill" Reuss's Peerless "30," a private car, as was also the winning machine in Class A.

The high totals in the checkers' penalty column are due entirely to Pennsylvania's icy mountains, and the bulk of them were accumulated almost before the contestants had a chance to warm up after the start from Wilkes-Barre. It was the famous old Giant's Despair which claimed victim after victim, and put them so far behind that each succeeding control only added to the totals of points. Some of the contestants, disgusted with their positions, failed to turn in cards, and came right through regardless of schedules. Others played the game out to the limit, took their medicine like little men, letting the points pile up as they might. Giant's Despair certainly took a cruel revenge for its Memorial Day buffet-



First - Matheson Tourer

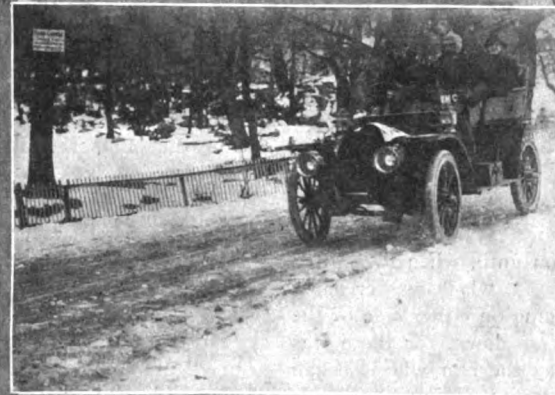

Second - Franklin Tourer



First - Peerless Runabout



Second - Maxwell Runabout

ings of past years. Some of the cars unloaded their passengers to reach the top, and were disqualified therefor. Others hunted up block and tackle, or made a path of robes to secure traction on the slippery surface.

But one car submitted to the technical committee came out unscathed—the Premier, driven by Roy McNamara. It is understood that the failure to consider that car's performance was due to the unloading of the car in order to reach the top of Giant's Despair. The Studebaker, the Franklin, the Oldsmobiles were among other cars which were penalized but lightly by the technical committee. The Stoddard Dayton's road and observer's penalties were due entirely to running shy of water in the radiator and the consequent delay in procuring the necessary aqueous in a houseless mountain district. The hot engine was responsible for some of the technical demerits. A succession of exasperating tire troubles was responsible for the accumulation of 648 checker's penalties by Frank Yerger's Studebaker "30," which had the fewest technical penalties of any of the cars which officially finished.

Considering the difficulties of the route, and the exceptionally adverse conditions, the almost utter absence of vital breaks—apart from those resulting from collisions—was little short of wonderful. Without exception, all the spills and collisions were due to the coating of ice which covered the hills, and which made the negotiation of turns at even medium speed a dangerous proceeding. The result can only be considered a triumph for American automobiles, for never were conditions worse for an endurance contest. Men and cars suffered alike. "Whisker coats" in many cases failed to keep their wearers warm in the frigid air and with a 20-mile head wind from the northwest, and on the last control of the first day a sharp snowstorm for an hour or so. Frozen cheeks and toes—not to mention bad cases of "cold feet" when cars began to slide backward on the mountain roads—were complained of here and there. It was a sure endurance run.

On the theory that "misery loves company," the colossus after whom

Senator Morgan named the Wilkes-Barre mountain road must have chuckled to himself as he witnessed the difficulties encountered by the 25 contestants remaining from the original field of 31 starters shortly after the start of the second day's trip. The surface of the steep and winding way was a sheet of hard, glassy ice, into which chains and anti-skids could not penetrate sufficiently deep to afford a firm hold for traction. The Wilkes-Barre Automobile Club had caused a few barrels of ashes to be scattered here and there on the turns. The straights were allowed to remain as the combination of a stiff grade, a six-inch snowfall followed by a thawing rain and then by a hard freeze had made them when the contestants tobogganned down the mountain the previous afternoon—perhaps that exhilarating sleigh ride had made Giant's Despair a trifle slipper, if possible.

The route out of Wilkes-Barre toward Hazleton, the first control, led directly up the mountain, and the first indication of what was coming to them was given the contestants when they heard that "Doc" Overpeck, in the Mitchell pilot car, finding he was ripping the chains off his wheels, and that his load of confetti was not sufficiently heavy to give his car traction, sidestepped the hill and sped Hazletonward over the much more practicable boulevard route. The contestants, however, could not follow the pilot's example; they were compelled to adhere to the official route or suffer disqualification. Cadillacs Nos. 2 and 3 had a slight advantage, and by picking the rough places here and there managed to reach the top after much difficulty. No. 4, a six-cylinder 45-horsepower Acme, was driven by Al. McCormick, and he had figured it out that his best chance lay in "rushing" the hill. His plan was working to perfection until, when two-thirds of the way up, he overtook Cadillac No. 3, which was creeping up as best it could, picking the rough going on either side of the road. Of course, McCormick had to slow down, for there was no room to pass. As the Acme lost way the rear wheels began to slip, and in a few moments the car was sliding backwards down the hill. Quickly a sprag was dropped, which held the car, but at each attempt to go forward the chains did nothing more than wear a pair of polished grooves in the hard ice as they whirled around. The crews of the Matheson, Nos. 6 and 7, immediately behind the Acme, knew the mountain thoroughly, and after sizing up the situation figured it out that they could just squeeze past the panting Acme by taking a chance; they took it, and won out. Shirk, in Stoddard-Dayton, No. 8, tried the same trick, but couldn't get around, and dropped back. Then a collection of robes was taken up from the string of stalled cars, and by pushing and pulling, and filling up the tonneau of the Acme with bystanders to put weight on the rear of the car, in order to make the chains "bite," the road was finally cleared. Those cars which were blocked on the stiffest grade were compelled to drop back to a place where they could get a chance to get up a little headway. It was a good hour and a half before the last car had mastered the icy slope. Despite the 15-degree temperature, the air was kept warm with imprecations, and it will be many a long day ere the memory of that early morning struggle with the slopes of Giant's Despair and Jack Frost fades from the memory of the participants.

In this connection it is proper to point out that the contest committee, a few days before the run, had inserted a new rule in the regulations governing the contest, allowing time to any car which might be compelled to stop owing to being blocked on a narrow road by another car in distress. The Acmeites claim that they were so blocked by the Cadillacs; that they had ample power, as witness the overloading of the tonneau to get traction. Those behind the Acme claim the latter was stalled, and some of the latter, when they tried to go forward, found it impossible to do so for awhile, and they came in for blame from those behind them. It was a case of "every fellow could have gone up easily if the fellow ahead of him hadn't stalled." The shower of protests hurled at the contest committee at the finish gave that body many hours of earnest discussion, which lasted well over into Sunday, and a decision was not made in time for the morning papers to publish the results.

Another knotty problem that the committee was compelled to solve was whether in case of a tie an engine stop of 30 seconds should be given a win over a similar stop of 45 seconds—observers' reports turned in at the end of the first day brought up the question. The rules say that a one-point penalty shall be inflicted for each such stop or fraction of a minute it continues. Another mix-up came as a result of the adoption of a schedule wherein the 20-mile-an-hour basis was reckoned out in the hours, minutes and seconds. The Cram and Freitag Mitchells, Nos. 9 and 10, claimed to have lost clean scores the first day by adhering to the printed schedule, while the finish officials were ignoring the odd seconds. No. 10 was given one demerit for crossing the finish line the fraction of a minute to the bad, whereas if they had been allowed the odd seconds the Mitchellites claim they would have finished clean.

A combination of unforeseen circumstances resulted in a dearth of accommodations for pressmen on the run, and as a result there was a rush for the 8:30 express as soon as the last Class B car had been sent away from the Hotel Walton at 8:02 A. M. The officials and the Fourth Estate men quite filled the only Pullman, and on arriving at Wilkes-Barre at 10 o'clock "The Automobile" representative and a photographer stole a march on the others by securing a Matheson tester and beating it for the Mountain House to snap the cars coming down Giant's Despair. After the pilots the first two to strike the toboggan were the Matheson duo, Nos. 6A and 7A. From the porch of the Mountain House could be heard the cannon shots which welcomed their arrival at the hotel a few minutes later. Wilkes-Barre is certainly loyal to its own.

The tenderness with which most of the drivers tackled the descent of the crack hill-climbing course was remarked upon by the dozen shivering enthusiasts gathered at the windy lookout. The Mathesonites evidently knew their ground, for confidence was written on their frozen faces as they swung and skidded around the turns at a fair rate of speed. Out-of-towners felt their way cautiously. The observer in Mitchell No. 9, which slid down toward the Mountain House with wheels locked, lost his nerve and jumped from the car, and a couple of minutes were lost before he could be induced to get aboard again and continue the journey. No. 9 was penalized about that much at the finish for late arrival. Rambler No. 19 (Class A) began to coast with rear wheels set, all hands meanwhile looking as if they were prepared to jump. At the same time the car began to swing round, and, after making a full revolution and a half, stopped with front wheels in the ditch, completely blocking the road for the following car, which came within an ace of ramming the Rambler. Berger's 42-inch-wheeled Oldsmobile No. 23 (Class A) next in order took to the ditch to avoid a collision, and got into such a bad position that fully 15 minutes were lost getting the car back onto the toboggan again. Some of the rear cars came down the mountain after dark, but just how they did it they couldn't tell themselves. Joe Keir, who followed the run in an 18-horsepower Autocar truck loaded with Ajax tires, declares it came down sidewise and backward. It was 9:30 at night, and the only things to be seen were the lights of Wilkes-Barre down below.

Following is the schedule, showing the distances between controls and the time allowances:

FIRST DAY.				
	Miles.	Time.	Total Miles.	Total Time.
Philadelphia to Sellersville.....	33.3	1:39:54		
Sellersville to Allentown.....	21.0	1:03:00	54.3	2:42:54
Allentown to Stroudsburg.....	49.9	2:29:42	104.2	5:12:36
Stroudsburg to Wilkes-Barre.....	50.1	2:30:18	154.3	7:42:54
SECOND DAY.				
	Miles.	Time.	Total Miles.	Total Time.
Wilkes-Barre to Hazleton.....	36.9	1:50:42		
Hazleton to Hamburg.....	35.0	1:45:00	71.9	3:35:42
Hamburg to Reading.....	16.2	:48:36	88.1	4:24:18
Reading to Pottstown.....	16.7	:50:06	104.8	5:14:24
Pottstown to Norristown.....	19.3	:57:54	124.1	6:12:18
Norristown to Philadelphia.....	22.3	1:06:54	146.4	7:19:12

It was plain sailing on the first control, few of the cars failing to arrive at Sellersville with at least 15 minutes to spare. On the second control several stiff foot hills of the Alleghanias are en-

countered, and then began the series of accidents which gradually mowed down the list of competitors. At Centre Valley "Dan" Webster, driving an Oldsmobile "35" Class B roadster, skidded at the turn from the Bethlehem pike into the Allentown road, and came to close quarters with a telegraph pole, with the usual result, as far as the car was concerned, but with, fortunately, only a few bruises for his mechanic and a beautiful black eye for "Dan." The glasses which the latter wore at the time were not broken; neither were his goggles.

On Lehigh Mountain—one of the above-mentioned foothills—Bert Maucher's Peerless No. 1 (Class A) came to grief by skidding across the icy road and into a deep ditch, breaking a wheel and topsy-turvyng the car. Apart from a severe shaking up for all hands, there were no ill effects suffered by the occupants.

After checking out of Allentown, Frank Hardart, Jr.'s, Elmore (Class A) was making excellent weather of it when in the outskirts of Bethlehem the chains failed to hold the car on the icy road at a sharp turn and the outfit ramm'd a house close to the roadside; it chopped off a portion of its porch as clean as a whistle. Again the car was put out of action and the passengers escaped without injury.

Five miles below Allentown, Franklin, No. 16 (Class A), driven by Ed. Luckenbach, turned turtle as the result of a skid on the ice, throwing all hands out and clear of the car. The result was a broken wheel and the destruction of the car's chances, but, again, fortunately, the hospital failed to corral a solitary victim.

The experience of J. A. Depew in his Winton (No. 11, Class A) gives a body blow to the pessimist who claims that the existence of the milk of human kindness is an ancient fallacy, and that it is not to be found in the market these days. In Easton, in order to avoid a woman, who suddenly stepped into the street directly in the path of his car, Depew chose to drive into the curb rather than hit her. The result was a smashed front wheel. Nearby was another Winton, belonging to an Eastonian, who insisted that Depew should take one of his wheels and continue, saying he could himself borrow a wheel in town and move along somehow until Depew could express him his wheel on his return to Philadelphia. Later, however, it developed that the collision with the curb had shaken up the car rather badly, for while tobogganning down Giant's Despair his shaft broke between the clutch and the transmission.

Another Winton, No. 17 (Class A), driven by Joseph H. Schenck, Jr., so strained its transmission in getting out of a deep ditch into which it had skidded at an icy turn that the last two-

thirds of the journey to Wilkes-Barre had to be covered with the low gear, the result being 170 points penalty for being the same number of minutes behind its schedule at the finish.

Thus the completion of the first day's run saw only 12 of the 23 Class A starters remaining with clean road scores, and two of the eight Class B contingent—and of the 17 derelicts, six were entirely down and out of the running, the remaining 11 having suffered various penalizations for lateness at controls. For reasons best known to themselves, the committeemen refused to make known the technical penalties imposed upon the contestants.

The Wilkes-Barreans fairly outdid themselves in entertaining their guests. Besides an all-day lunch, there was a reception and smoker in the ballroom of the Hotel Sterling, with solid and liquid refreshments galore. Even the chauffeurs of the town took a hand. The drivers recently formed a club and established quarters at No. 45 Simon Long Building. Here they entertained visiting chauffeurs, clubmen and newspaper men, setting out a tasty lunch and smoke goods all the afternoon and evening. There are about 25 members in the Wilkes-Barre Chauffeurs' Club, and every man of them was on the job. President George P. Kessler was assiduous in his attentions to the many visitors.

How Latest Official Standing Was Arrived At.

PHILADELPHIA, Jan. 4.—The final standing of the contestants in the Philadelphia-Wilkes-Barre endurance run, as officially announced early Sunday morning, underwent a shake-up this afternoon, when a protest filed in behalf of the Oldsmobile (Class A) cars, driven by Folberth and Berger, and which were originally placed in eighth and tenth places, had the bulk of their road penalties lifted, and as a result moved up into second and third places, with 13 and 15 demerits, respectively. This dims the glory of the Matheson victory somewhat, although Miller, with but 11 bad marks, still heads the list. The Anderson and Dietrich Mathesons, as a result of the decision, are fifth and sixth, respectively, with Carris' Franklin fourth.

When Folberth reached the impasse on Giant's Despair he refused to take a chance of crippling his car by taking to the ditch in an effort to get around the stranded Acme. An eleventh-hour amendment of the rules had covered this contingency; it provided for the lifting of any penalties inflicted upon a car held up by a narrow road being blocked by a stalled machine.

The Oldsmobile case was reinforced by positive testimony of observers and passengers, and was such a strong one that the contest committee upheld the protest after but a few minutes' deliberation. Final result:

OFFICIAL STANDING ACCORDING TO REVISED REPORT OF QUAKER CITY MOTOR CLUB'S CONTEST COMMITTEE

CLASS A—TOURING CARS					PENALTIES				
No.	CAR	H.P.	Cyl.	Entrant	Driver	Checkers	Observers	Technical	Total
7	MATHESON	15-50	4	Matheson Motor Car Co.	W. P. Miller	0	1	10	11
12	OLDSMOBILE	40	4	Olds Motor Works Branch	F. G. Folberth	0	4	9	13
23	OLDSMOBILE	54	6	Olds Motor Works	T. W. Berger	5	0	10	15
18	FRANKLIN	28	4	Franklin Motor Car Co.	C. S. Carris	14	3	5	22
15	MATHESON	60	4	Ross Anderson	Koss Anderson	0	0	23	23
6	MATHESON	45-50	4	Matheson Motor Car Co.	J. M. Dietrich	0	0	37	37
3	CADILLAC	30	4	Auto Sales Corporation	Ed. Burnshaw	43	1	37	81
2	CADILLAC	30	4	Auto Sales Corporation	Wm. Crawford	116	0	23	139
8	STODDARD-DAYTON	40-45	4	A. Hamilton, Jr.	R. Shirk	37	77	26	140
24	STEARNS	30-60	4	Wyckoff, Church & Partridge	Laurent Grosso	219	1	29	249
4	ACME	45	6	Theobald Motor Car Co.	A. McCormick	604	2	31	637
14	STUDEBAKER	30	4	Studebaker Co.	F. H. Yergler	648	2	4	654
10	MITCHELL	40	4	Penn Motor Car Co.	Wm. Freitag	671	2	15	688
20	MAXWELL	24-28	4	Maxwell-Briscoe Co.	A. H. Bitner	895	34	265	1,194
19	RAMBLER	34	4	T. B. Jeffery & Co.	P. W. Darnstaedt	720	Out	9	729
9	STODDARD-DAYTON	30-35	4	Hamilton Auto Co.	H. B. Tuttle	727	Out	45	772
13	MITCHELL	30	4	Penn Motor Car Co.	W. M. Cram	1,282	No cards	42	1,324
21	PEERLESS	30-35	4	H. O. Smith	R. McNamara	18	Out	0	18
1	PEERLESS	30	4	Auto Sales Corporation	Bert Maucher	Out first day	—	—	skidded and overturned on Lehigh Mountain.
5	ELMOXE	35	4	Frank Hardart, Jr.	F. Hardart, Jr.	Out first day	—	—	skidded into porch in Bethlehem and smashed 2 wheels.
11	WINTON	48.6	6	J. A. Depew	J. A. Depew	Out first day	—	—	broke shaft between clutch and transmission on Giant's Despair.
16	FRANKLIN	42	6	Geo. B. Mauser	E. Luckenbach	Out first day	—	—	skidded and overturned 7.5 miles below Allentown.
17	WINTON	48.6	6	Jos. H. Schenck	J. H. Schenck, Jr.	Out first day	—	—	after third control.

CLASS B—ROADSTERS AND RUNABOUTS					PENALTIES				
No.	CAR	H.P.	Cyl.	Entrant	Driver	Checkers	Observers	Technical	Total
5	PEERLESS	30	4	Wm. Reuss	W. G. Brooks	246	2	22	270
4	MAXWELL	24-28	4	Longstreth Motor Car Co.	W. C. Longstreth	452	1	75	528
3	OLDSMOBILE	35	4	Olds Motor Works Branch	Dan Webster	Upset at Centre Valley and bent gear-shifting levers.	—	—	—
8	BUICK	18	4	Edward Wilkie	T. Wilkie	Sideswiped wagon at Bethlehem; smashed wheels.	—	—	—
1	STODDARD-DAYTON	45	4	H. C. Vetterlein	H. C. Vetterlein	Out on first control second day.	—	—	—
2	MITCHELL	20	4	Penn Motor Car Co.	C. Borie, 3d	" " " " " "	—	—	—
6	KNOX	38.25	4	Knox Auto Co.	W. Bourque	" " " " " "	—	—	—
7	RAMBLER	32	4	Brown Auto Top Co.	I. L. Brown	" " " " " "	—	—	—



Vol. XX Thursday, January 7, 1909 No. 1

THE CLASS JOURNAL COMPANY
Thirty-ninth Street Building, 231-241 West 39th St.
New York City

H. M. SWETLAND, President

EDITORIAL DEPARTMENT

A. G. BATCHELDER, Managing Editor
R. F. KELSEY, Associate Editor C. B. HAYWARD, Engineering Editor
W. F. BRADLEY, Foreign Representative

BUSINESS DEPARTMENT

A. B. SWETLAND, Business Manager
LOUIS R. SMITH FRANK B. BARNETT
W. I. RALPH, 1035 Old South Building, Boston, Mass.
C. H. GURNETT, 1200 Michigan Ave., Chicago, Ill.
F. W. VAN SICKLEN, Mich.
H. H. GILL, Detroit, Mich.
T. B. VAN ALSTYNE, Philadelphia, Pa.

Cable Address - - - - - Autoland, New York
Long Distance Telephone - - - - - 2046 Bryant, New York

SUBSCRIPTION RATES:

United States and Mexico - - - - - One Year, \$3.00
Other Countries in Postal Union, including Canada - - - - - One Year, 5.00
To Subscribers—Do not send money by ordinary mail. Remit by Draft,
Post-Office or Express Money Order, or Register your letter.

FOREIGN SUBSCRIPTION AGENTS:

ENGLAND:—W. H. Smith & Sons, Ltd., 186 Strand, London, W. C., and all their
railroad bookstalls and agencies throughout Great Britain; also in Paris
at 248 Rue de Rivoli.
FRANCE:—L. Baudry de Saunier, offices of "Omnia," 20 Rue Duret, Avenue
de la Grande Armee, Paris.
GERMANY:—A. Seydel, Mohrenstrasse 9, Berlin.

Entered at New York, N. Y., as second-class matter.
The Automobile is a consolidation of The Automobile (monthly) and the Motor
Review (weekly), May, 1902, Dealer and Repairman (monthly), October, 1903,
and the Automobile Magazine (monthly), July, 1907.

ANENT THE PASSING SHOW

To say that the Grand Central Palace show indicates progress is both trite and commonplace. But this progress is noted in the mechanical features and in the body work which the individual prospective purchaser can see, appreciate, and willingly pay for.

A large amount of substantial growth is apparent in the commercial vehicle section, which seems to grow every year. A year or two more and an entirely separate show for the power wagons will be a necessity.

A fine lot of taxicabs of vastly improved appearance and superior mechanically are to be seen, many of the newcomers being in this group.

The high-wheel section, to the partisan of that type, is numerous and, beyond mere numbers, are worthy of very close attention.

The constant ramification of the industry is shown by the exhibition of a well worked out children's car along simple lines, small and compact, but complete in every minor detail.

But the delightful part of the show to any real optimist is the touring section. This individual with the roseate views of life wants no sombre matter of fact commercial vehicle, no homely but useful motor buggy, nothing but the high-powered high-grade distance traveler. And it is present in force, too.

To the cheerful optimist, the show really is an expression of optimism: Talk of big outputs, factory enlarge-

ments, doubling the working force, etc. On every hand you meet it. Every one is cheerful, confident, smiling, sure of a pleasant and profitable future. Manufacturers are unwilling to talk of conservatism, or to croak or discredit the present outlook for the biggest year the industry has ever known. Agents who had sold their allotment came begging, imploring, demanding more cars. They are sure they can sell them; regardless of the section of the country, the car or the price, they can sell anything. Of this they are confident.

Back of all this can be but one thing, the biggest and the most cheerful optimist of them all, the great American public, which has shown that it wants American cars and wants them badly. Not only do they want them now, but they are going to continue to do so, to-morrow and the next day, and a year from now. It is the manufacturer who sees and appreciates this that is building the big three-story additions. The numerous garage buildings all over the country is but a straw in the wind which promises soon to be a gale. The vast extension of the accessory business is another indication of it. On every hand, signs are not lacking to show that any optimistic view of the automobile situation, no matter how roseate, is not without a solid foundation.



PLANS OF CARRIAGE BUILDERS INDICATED

Doubtless the average automobile builder looks upon the buggy type as the carriage builders' concession in recognition of the growth of the automobile industry and the fear that the tide is waxing strong, so strong in fact, as to sound the death knell of the horse as an animal of traction; hence the carriage that the horse made possible. A canvass of the situation as it is reflected at the show would seem to indicate that the carriage man has gone a little farther, in that he has evolved the buggy type quite a little. In other words, the crude power buggy of a year ago is rapidly reducing itself to a machine, with higher wheels than the wheels as they obtain on automobiles, and the question arises if it is not really a reduction to practice of the "solid tire" in the buggy type as against the pneumatic tire in automobiles. True, the buggy types have held to what the automobile builder calls crude methods, many of which were cast aside several years ago by the builders of automobiles. On the other hand, it is easy enough to prove that the very automobile designers who see no good in the buggy have been increasing the diameters of their wheels year after year as the cost of pneumatics fell away. And who will deny that they will not continue the process for some time to come, as the cost of the tires is reduced? On the whole, then, is it not a fair indication of the drift to take into account the desires rather than the products? That a half loaf is better than no bread is assured, and that the pneumatics were held to a low diameter for several years was because none could afford to pay for more. In the meantime, solid tires made slow but sure progress, and the carriage makers were compelled to use them—or build automobiles. They struck the trail with solids, and used the carriage type of car in the process. The end is, as might have been predicted, the buggy type of mechanical car, which has simmered down to a proposition in which the advantages of resilient high wheels coupled with solid tires produced a situation of more than passing interest; and the end is not yet in sight.

AUTO ANGLES OF THE RECENT TARIFF HEARINGS

WASHINGTON, D. C., Jan. 3.—The recent tariff hearings before the Ways and Means Committee have developed the interesting news that the Fiat Automobile Co., of Turin, Italy, is contemplating the establishment of a factory in this country. This fact was conveyed to the committee by Henry B. Joy, of the Packard Motor Car Co., in the following to Chairman Payne:

"I take the liberty of advising you that in the brief of the motor car manufacturers, which we are struggling to get ready, we suggest that the Fiat Automobile Co. in New York is connected so closely with the Fiat Automobile Co. of Turin, Italy, that the sales prices of cars between the factory and the New York store for the purposes of custom-house valuation may not be exactly on the level. In support of this I have seen the original letter of the Fiat Automobile Co. of New York to the Mayor of Detroit, a copy of which I enclose to you, in which the Fiat Automobile Co., being the New York company, speaks constantly throughout the letter of its relationship to the parent factory in Turin, Italy, which may be of interest to your committee. It is also worthy of note that the tariff laws as they now exist have produced an intent in the minds of the Turin company to remove its major part to America."

The letter to the Mayor of Detroit, referred to by Mr. Joy, is dated New York, December 15, 1908, and is signed by The Fiat Automobile Co., E. R. Hollander, vice-president. It follows:

"Owing to the strong probability that there will be no relief for imported cars in any customs revision that may be made under the new administration, we have decided to establish a large factory in this country for the manufacture of our cars and to remove to it a large portion of our manufacturing machinery, as well as our organization from Turin. We are therefore looking about for a suitable place to locate this new factory, which will be of very large proportions, and are writing you with the hope that you will do us the courtesy of bringing this question before the proper persons or organization in your city, with the idea that we may ascertain what inducements would be made, if any, for the establish-

ment of such a plant in Detroit. We would guarantee to employ 500 skilled mechanics to begin and within a year employ 2,000. One of the officers of this company expects to sail for Europe about the middle of January, and any proposition that we might receive from your city will be submitted to our directors in Italy, upon his arrival, when the matter will be definitely settled.

In connection with the duty on antifriction ball bearings, the Packard Motor Car Co. sends the following communication to the Ways and Means Committee:

"Relative to duty on ball bearings, I would like to register with the Ways and Means Committee the attitude of this company toward the duty on ball bearings. This company favors the retention of the existing duty, namely, 45 per cent., on ball bearings. We are now large importers of ball bearings, importing over \$100,000 worth from Germany and other European countries each year, on which we pay 45 per cent. duty. We do this because there are no ball bearings made in America of the same quality and durability as those which we import. We feel that with the existing tariff the American ball-bearing manufacturers may learn to make better bearings, as good as those in Germany, in the course of time. In this event the American competition would naturally reduce the price. American ball-bearing manufacturers have not yet gotten to a competitive basis. They have all been so busy supplying a new trade that it was more of a question to get the stuff out than it was as to price or quality, but the whole situation is rapidly shaking itself down to a competitive basis."

The various automobile manufacturers, including the Diamond Chain & Mfg. Co., Indianapolis; Whitney Mfg. Co., Hartford; Baldwin Chain & Mfg. Co., Springfield; Lefever Arms Co., Syracuse, and Link Belt Co., Indianapolis, have joined in asking the Ways and Means Committee that no reduction be made in the present tariff of 45 per cent. ad. valorem on their product. They presented reasons why the present duty should be retained.

NEW YORK'S GOVERNOR ASKS FOR MOTOR LAW REVISION

ALBANY, N. Y., Jan. 6.—Governor Hughes in his message to the Legislature, read in both Senate and Assembly at noon to-day, has a recommendation which will interest all automobile owners. The Governor recommends a heavier tax on motor vehicles, the proceeds to be used for the repair of highways, and also drastic legislation and penalties for the protection of those whose lives he now seems to believe are imperiled by the reckless driving of automobiles. The Governor combines his good roads and motor vehicle recommendations under the same sub-head of "Highways and Motor Vehicles," and says:

There have been 809 miles of State roads completed during the past year. The new Highway law is now in effect and provides for an improved system of administration designed to perfect methods and secure proper continuity of organization and policy. It is of little purpose to build new roads unless the roads which are constructed are also properly maintained. And in no department of the State's work are there more serious problems and

greater need of the utmost efficiency. It is believed that these necessities are fully appreciated by the people and that in response to their demand we shall be able to secure a system of improved highways worthy of the State.

The difficulty of maintaining our highways has been so largely increased by the use of motor vehicles that I recommend for your consideration the advisability of imposing a substantial license tax for the privilege of operating motor vehicles within the State, the proceeds to be devoted to highway repair. It is desirable that such license fees should be uniform in our State and in the States with which we are in contact, and in advance of legislation opportunity should be offered for prompt interchange of opinion and for securing an agreed basis of action. This, it would seem, might be accomplished through the Commissioners on Uniform Laws.

The reckless disregard of human life that is so frequently manifested in the driving of automobiles calls for drastic measures of protection, both with regard to means of identifying vehicles and in providing an increased punishment where those guilty of criminal conduct seek to escape arrest. And I invite your attention to this matter.

HOUPT IN THE ROLE OF MAKER.

Several unofficial reports dealing with the relations between the Harry S. Houpt Company and the E. R. Thomas Motor Company have indicated a severance of these relations in the near future. Mr. Houpt will handle the new Herreshoff car as a private venture and not as the Harry S. Houpt Company, because of the contract which the latter company has with the Thomas people. This is in force at present, and will continue until next August, Houpt energy to be devoted to the same line as before.

Upon the expiration of this contract, however, a switch will be made to a new line of cars, including the Herreshoff in the "fifteen-hundred class," and a new big car to bear the Houpt name. The details of this new one and of its manufacture have not been made public.

A. B. TUCKER DIES VERY SUDDENLY.

A. B. Tucker, well known in automobile circles, succumbed to heart disease early Monday morning of this week at his home in New York City. Mr. Tucker had many friends in automobiling, and had been a prominent figure in the promoting line for several years, though his first important position was that of secretary of the National Association of Automobile Manufacturers. Subsequently he served as secretary of the special A. A. A. touring committee having in charge the annual tour for the Glidden trophy. Later Mr. Tucker became secretary of the New York Motor Club, and later was identified with the New York Automobile Club. During the past two years he has looked after publicity matters for several concerns, at which work he was exceptionally successful.

CLUBS PREPARE FOR WORK OF NEW YEAR

DENVER AUTOISTS TO HAVE LIVE SEASON.

DENVER, COLO., Jan. 2.—There promises to be considerable activity in automobiling circles in Denver during the coming year, according to the strenuous program being mapped out by the Denver Motor Club. It is proposed by the club that every man, woman, and child in Denver, the people of Colorado, and the whole country in general, shall know that the club is living up to its motto of "Do Something." The membership is now climbing rapidly toward the 400 mark, and it is expected to have double that number enrolled when the A. A. A. tourists arrive in Denver next July.

The most conspicuous event now on the Club's calendar is the automobile show, which will be held February 16 to 18 at the Auditorium. This show promises to surpass any exhibition of the kind ever held west of Chicago. The local dealers have entered enthusiastically into the project, and are urging the Eastern manufacturers to come to the front and send exhibits here. The show committee is in receipt of assurances from Eastern manufacturers who have no representatives here in which they say they will send exhibits to the Denver show.

Some time in April it is planned to have an illuminated parade. The principal streets will be decorated and the cars will be illuminated with electric lights in the club colors. Handsome prizes will be given to stimulate interest in the event.

In May there will be a gymkhana. There will be obstacle races, slow races, balancing the cars on a teeter board, spearing Greeley potatoes suspended on a string, and other interesting events.

Orphans' Day will be observed early in June. On this day every member of the club is expected to furnish his car and aid in giving the fatherless and motherless boys and girls of Denver a good long automobile ride. The various institutions of the city will be called upon to furnish the children and there will be plenty of cars to accommodate them all.

In July the A. A. A. Tour will hold the boards. When the army of Eastern motorists swoop down on Denver after their long journey across the continent, the Denver Motor Club will be prepared to give them a genuine, old-fashioned Western welcome. The city will be decorated in their honor and for a week at least there will be a continuous round of motoring entertainment such as the Glidden tourists of former years have never before witnessed. There will be a road race, a hill climb, and other attractions, so that the tourists will not have an idle time on their hands during their stay in Colorado.

Sandwiched in between these events, the club is arranging for week-end runs to various towns and mountain resorts where splendid dinners and various mild sorts of entertainment will be given. The club is now fairly settled in its new quarters, 1407 Cleveland place, where the members and their guests find all the comforts of home.

OHIO AUTO LAW DEVELOPS AN IMPERFECTION.

COLUMBUS, O., Jan. 5.—A queer freak has developed in the State Motor Vehicle Law, for there is no provision to compel the changing of colors on the tags each year. Consequently this feature of the law received considerable attention at the meeting of the directors of the State Automobile Association in the rooms of the Columbus Automobile Club last week. An attempt will be made to secure the passage of such an amendment, and also one which shall provide that all licenses must expire at a certain time of year, say January 1, in order that the task of renewing them may be made much lighter. A number of other amendments were suggested, but because of the opposition by some of the members of the Legislature to anything pertaining to automobiles it was thought better not to go too far, for fear the entire bill might be declared unconstitutional. In the meantime all the interested ones are working for the amendment:

SPEARE AGAIN BAY STATE PRESIDENT.

BOSTON, Jan. 4.—The annual meeting of the Bay State Automobile Association was held to-day in the clubrooms in the Hotel Carlton, and Lewis R. Speare, former president of the association, was again chosen president, succeeding Elliott C. Lee in that office. Harlan W. Whipple was reelected vice-president. J. S. Hathaway, manager of the White Company branch in this city, is the new treasurer. Secretary James Fortescue was reelected secretary.

The new directors are George W. McNear, Dr. Julius F. Hovestadt, F. A. Hinchcliffe, manager of the Winton branch; K. M. Blake, manager of the Locomobile branch, and C. F. Whitney, manager of the Park Square Auto Station and agent for the Alco and the Stoddard-Dayton. The efforts of the retiring officers to free the association from debt were successful, and the report of the treasurer showed that the association no longer was encumbered by a debt, and that it was in excellent condition financially.

BRONXVILLE CLUB HOLDS ANNUAL MEETING.

BRONXVILLE, N. Y., Jan. 5.—At the second annual meeting of the Bronxville Automobile Club, held at the Hotel Gramatan, the following board of governors was chosen for the ensuing year: H. Ward Leonard, Arthur W. Lawrence, H. R. Burt, Frederick Ackerman, Frederick H. Elliott, W. K. Fertig, Eugene Southack. In executive session the board elected the following officers: President, H. Ward Leonard; vice-president, Frederick Ackerman; secretary-treasurer, H. R. Burt.

The club has been very active in the erection of road signs, and has held several successful runs during the past year. It has been suggested that a new modern garage should be erected to care for the large number of cars now owned in Bronxville, and it is quite probable that the local club officers will assist in the selection of a site which would be convenient to all, especially the visiting autoists, many of whom are patrons of the Hotel Gramatan.

LOUISIANA MOTOR LEAGUE JOINS A. A. A.

NEW ORLEANS, Jan. 4.—The State Automobile Association, the Louisiana Motor League, has made application for admittance to the American Automobile Association, and has announced that it will hold weekly meetings hereafter. The league is interested in the establishment of good roads in the South, and is planning a steady campaign in that direction. It will work in unison with the New Orleans Automobile Club.

Extensive preparations are being made for the races during Mardi Gras week, February 20-22, at the fair grounds track. These races are under the auspices of the New Orleans Automobile Club, and will be one of the chief attractions for Mardi Gras visitors. Fred J. Wagner, of New York, has been engaged to act as referee and starter and general manager for the New Orleans races. He has already assumed charge of the preliminaries.

WILLIMANTIC CLUB VOTED FOR LINCOLN.

WILLIMANTIC, CONN., Jan. 4.—At the annual meeting of the Willimantic Automobile Club the following officers were elected: President, Louis B. Lincoln; vice-president, Walter B. Knight; secretary, Frank H. Elmore; treasurer, Edward F. Whitmore; board of governors, the officers and Ernest P. Chesbro, Arthur B. Small, Frank L. Powell; directors, Connecticut State Automobile Association, Edward F. Whitmore and Harry J. Cotter; member Good Roads Committee, E. P. Chesbro. The treasurer reported money in the treasury and the expenditure of new funds for good road work. The club then adjourned until after the holidays, when the work for the new year will be mapped out.



Reos Being Towed from D. L. & W. R. R. Ferry to R. M. Owen & Co., 1759 Broadway, New York.

Maxim Invents Novel Tire Pump.—

The demand for mechanical tire pumps has produced many of these, but one of the latest to come out bids fair to be the simplest, and, therefore, the best of all this line of labor saving devices. In this new device the exhaust from the motor is used instead of atmospheric air. H. P. Maxim has introduced this new and novel tire pump, which is readily attached to any gas engine and which is actuated by the exhaust. The inflator is carried along the sides or tops of the cylinders and will fit any car with slight alterations. It consists of a copper tube and series of coils permanently attached to the relief cock, by which the exhaust gas is cooled and forced into the tires. It is claimed that the exhaust gas is a better inflating agent than air, for the reason that it is non-oxidizing. In place of the conventional relief cock, there is inserted the connection of the pump, which is nothing more or less than a long copper tube containing several coils with a cock at each end. One of these cocks is inserted in the place of the relief cock and contains a small steel ball. The long copper tube is carried out to the dash convenient to the driver's seat. When it is desired to utilize the pump, the exhaust gas is permitted to pass through the copper tube and the coils tend to cool it as well as care for foreign matter. A pressure gauge is attached to the dash. It requires about two minutes and a half to inflate a tire with the device.

Duluth Wants a Motor Patrol.—Bids will be opened December 30 for an automobile patrol wagon which must be delivered within two months. Power is required to climb any of the city's big hills, but the speeds specified are low, 20 m.h.p. maximum, 4 m.h.p. minimum. A seating capacity of ten is called for, as well as stretchers. The successful bidder must operate for thirty days at his own expense and guarantee the machine for a year. In addition, the cost must not exceed \$2,500.

Autos Popular with Kansas Farmers.—To demonstrate the extent of the adoption of the automobile in the rural districts, some enthusiast has collected figures which show that over 600 farmers in Central Kansas alone own cars, with orders of Spring delivery of 100 more.

Advance Show.—An interesting little exhibit is the advance showing of the Winton Motor Carriage Company at its Broadway salesrooms, New York City. This includes all of its Garden Show cars, and the Winton phaeton sold to Robert Allison, of Port Carbon, Pa., in 1898, said to be the first bona-fide sale of an American made gasoline car. The "six," which won the first prize in the upkeep contest, is also on display.

Nitro-glycerine Automobile.—Probably nothing during the past year has indicated more clearly the advance automobile construction, carrying with it the total absence of vibration, than the announcement of the recent use of an ordinary car to carry 40 quarts of nitro-glycerine a distance of 100 miles over roads not particularly good. This was done by W. D. Tracy, an oil well shooter of Bolivar, N. Y., and the trip was from that town to Bristol, where Mr. Tracy shot a gas well for the Ontario Gas Company.

Automobile Service for Municipality.—An American consul in Western Europe reports that a company has been organized for the purpose of establishing automobile service for the city in which he is located. It is proposed to increase the stock of the company as business grows. The consul has forwarded the company such catalogues of American cars as he had on file, and suggests that manufacturers write direct to the director of the company, whose address is given in the report. In writing for this report, refer to No. 2,903.

Firestone Jollification.—To celebrate the completion of a four-story building, the officials and employees of the Firestone Tire & Rubber Company joined in a jollification supper and dance Tuesday evening, December 29. Nearly a thousand guests were present, filling the whole fourth floor, and all voted it the best time ever. This new building will be exclusively for the manufacturing equipment of the new non-skid tire.

Auto Stages for Florida Resorts.—A regular line of automobile service between Ormond, Daytona and Palm Beach is about to be inaugurated by the Florida East Coast Hotel Company, for the benefit of the guests at the hotels of those resorts. The service will be furnished by three forty-horsepower "A. L. Co." cars, which were shopped a few days ago by the American Locomotive Company.

Big Demand for Anti-Skid Tires.—Due to the great run on the staggard tread tires, the Republic Rubber Company, of New York, has been obliged to move to larger quarters. Their new home will be at 229 West Fifty-eighth street, where a four-story building will triple their floor space afforded by the present building across the street.

Benefit Association for Firestone Company.—The factory and office employees

of the Firestone Tire & Rubber Company have organized the Firestone Mutual Benefit Association, for the purpose of providing a benefit fund. The aim will be to furnish both sick and death benefits for all members by a series of social gatherings to strengthen the relations between them.

More Fire Wagons.—The White Garage Company has been awarded the contract to furnish the fire department of Baltimore with two White steamers. The company's bid was \$4,194. The cars will be used in responding to alarms by Chief Horton and Deputy Chief Emrich.

Speedwell Building Again.—The Speedwell Motor Car Company, of Dayton, O., will soon begin work on another new building. This will be used for chassis painting only. They are also erecting a 12,000-gallon water tower, being outside of the city fire limits.

Truck Company Moving.—The Reliance Motor Truck Company is now busy moving from Detroit to their new and extensive plant in Owosso, Mich., where the full line of Reliance trucks with two-cycle motors will hereafter be built.

IN AND ABOUT THE AGENCIES.

The Pierce Arrow Again Stands the Strain.—The builders of the Pierce Arrow have just been notified of an incident which happened to a California owner of a Pierce, the results of which make them feel that they have again been justified in their policy of refusing to sacrifice strength for light weight. A. A. Busey, of Oakland, Cal., with a party of eight in his six-cylinder Pierce, was compelled to drive his car over an eight-foot embankment to avoid collision with a railroad train. According to the story, the car turned over three times before coming to a stop, with the result that the occupants received a severe shaking up with a few bruises. The top, glass front, and radiator were smashed, but on righting the car no serious damage was found and it left the scene under its own power.

Ramblers Long-Lived.—The statement was recently made that the average life of an automobile was about five years. Figures given out by Thomas B. Jeffery & Company, relative to Rambler cars, would seem to indicate that this was a very conservative estimate. The statement is made that 13,800 Ramblers have been built and are now running, of which 400 are seven years old, 1,500 are six years old, 2,100 admit to five years, 2,300 are no less than four years, while the remaining 5,000 have been built in the past two years. Another similar significant fact is that the repair parts in the past year amounted to but \$213,438.86, an average of \$15.25 per car.

Goodyear, Boston.—Owing to the increase of business, the Goodyear Tire & Rubber Company has acquired new quarters at 669 Boylston street, and is tearing down the old building now standing on that lot and erecting a new five-story building, with all modern improvements and fully equipped for business. The new building will contain over 10,000 square feet of floor space. An up-to-date repair shop is included, with all the latest improvements. The branch expects to be in the new quarters about May 1.

Speedwell.—These cars will be handled in Pittsburg during the coming year by the Speedwell Automobile Company, with salesrooms and garage at 5986 Center avenue; in Philadelphia by the Standard Motor Car Company, 616 North Broad street, and in Chicago by the Speedwell Motor Car Company, with of-

ices and salesrooms at 1355 Michigan avenue. The Speedwell Motor Car Company, Dayton, O., are the makers.

Stevens-Duryea, New York City and Philadelphia.—The A. G. Spalding & Bros. announce the enlargement of their New York and Philadelphia salesrooms, the latter including a new building at 202-204 North Broad street, which is considered one of the handsomest in the row. The Stevens-Duryea line for the coming year will be a continuance of the successful "fours" and "sixes" of the past season.

Franklin.—The H. H. Franklin Mfg. Company has appointed the following additional agents for 1909: Springfield, O., William Gaitter; Cherokee, Ia., William R. Johnson; Coffeyville, Kan., Brown Brokerage Company at Coffman's Auto Garage; Pierre, S. D., Gas Belt Land and Abstract Company; Aberdeen, S. D., F. W. Boettcher; Columbus, Ga., C. E. Shultz.

Winton, Baltimore.—The Winton Motor Carriage Company has secured more extensive location on Liberty street, near Lexington. This is in the business district. The new store will be ready for occupancy January 15. The local branch house has been at North avenue and St. Paul street since it was established a little more than a year ago.

Changed Their Name.—The Marion-Overland Auto Company, of 1875 Broadway, New York City, sales agent for both the Marion and Overland cars, has obtained the consent of the Supreme Court to change its name to the Overland Company, of New York. This will be adopted January 7 without any change in the personnel of the company.

Velie, Chicago.—The new Chicago branch of the Velie Motor Vehicle Company, of Moline, Ill., will occupy the building at 1615-1617 Michigan avenue, now tenanted by the Packard agency, which will move in the Spring. H. G. Moore, former secretary of the McDuffie Automobile Company, will have charge.

Pope-Waverley, Oakland, Cal.—The Western Electric Vehicle Company has now located in their new building at Thirty-fourth and Telegraph avenue. Besides maintaining an ambulance service, they will conduct a garage and handle the Pope-Waverley, Baker and Detroit electrics.

Packard, Providence.—The Flint Motor Car Company, agents for the Packard, has been obliged to double their floor space. The large store adjacent to the present agency has been leased and the partition walls are now being torn out.

Winton, Baltimore.—The Baltimore branch house of the Winton Motor Carriage Company has removed to Liberty street at Lexington avenue, where fine new quarters have been secured.

Elmore, Utica, N. Y.—I. R. Gardiner, with offices in the Commercial Travelers' Building, has been appointed agent for the Elmore car in Oneida and Herkimer counties.

Renault, Brooklyn, N. Y.—Alexandre Clement, the well-known racing driver, has taken over the Plaza Garage, 920-922 Union street. He is the agent for the Renault car.

Maxwell, Trenton, N. J.—Thoman Bros., agents in this city for the Maxwell car, has placed a sub-agency in Bordentown. Bernard H. Adams is to be in charge.

Franklin, Kalamazoo.—The E. J. Dayton Motor Company, who will handle the Oldsmobile and Franklin, has opened headquarters on Water street.

R. and L. Electric, Pittsburg.—C. P. Bowdion, of the Mutual Motor Car Company has taken the agency for the Rauch and Lang electric car.

Thomas, Wilkes-Barre, Pa.—The Coward & Long Company has taken a sub-agency for the Thomas in this vicinity.

Oldsmobile, Newark.—Sanford J. Wise will have charge of the new branch at 81 Washington street, Newark.

Reo, Trenton, N. J.—Dr. A. H. Boice has been appointed agent for the Reo car.

PERSONAL TRADE MENTION.

Wallace L'Hommedieu, formerly with the Autocar Company, Ardmore, Pa., and the Electric Vehicle Company, Hartford, Conn., has just joined the sales forces of the Apperson Brothers' Automobile Company, Kokomo, Ind.

John B. Guthrie will represent the Carpenter Steel Company after January 1 in the Pittsburg district, with offices in the Columbia Bank building, Fourth avenue and Wood street, Pittsburg.

F. A. Brezina, formerly with the Electric Vehicle Company as purchasing agent, is now connected with the Locomobile Company of America, Bridgeport, Conn.

Emory Carhart, salesman for the Denver branch of the Studebaker Company, tendered his resignation, which took effect January 1.

Elliott S. Church is now connected with the sales force of the George H. Dunham Company, Boston.

Robert W. Blake has joined the local force of salesmen for the Pullman car in Philadelphia.

RECENT INCORPORATIONS.

MotoBloc Import Company, New York City, with a capital of \$5,000, will manufacture, deal in and rent automobiles. Incorporators: H. M. Brown, F. W. Mills, and E. J. Forham, 154 Nassau street.

Garwood Electric Company, Garwood, N. J., capital \$250,000. Incorporators: E. A. Keegan, A. K. Westerdahl, G. N. Williams and G. W. Archinon.

F. & D. Mfg. Co., Portland, Me., capital \$400,000, will do a general automobile business. C. E. Eaton is president and T. L. Croken, clerk.

Fritz Bros. Automobile Company, Oklahoma City, capital \$40,000. Incorporators: C. D. Fritz, E. J. Fritz and R. W. Yantis.

F. S. Hoaglin Automobile Company, Oshkosh, Wis., capital \$10,000. Incorporators: F. S. Hoaglin, A. E. Badger and L. O. Chase.

Read Garage and Machine Company, Belfast, Me., capital \$10,000, will work a garage and machine shop.

Star Garage Company, Londonville, N. Y., capital \$25,000, to do a general garage business.

Hitchcock Banks Motor Car Company, of Providence, R. I., with capital stock of \$25,000.

Norris Motor Company, Cambridge, Mass., capital \$50,000. President, W. S. Young.

Pioneer Motor Car Company, of Muskegon, Mich., with capital stock of \$10,000.

Farmobile Manufacturing Company, of Columbus, O., with capital of \$200,000.

Markle-Light Motor Car Company, of Pottstown, with capital of \$150,000.

Jewel Motor Car Company, of New York, with capital stock of \$10,000.

Automobile Coaching Company, of Boston, with capital of \$20,000.

M. F. D. Motor Parts Company, Dover, Del., capital \$25,000.

Pierson Garage Company, Janesville, Wis., capital \$1,000.

RECENT PUBLICATIONS.

The Girl and the Motor, by Hilda Ward; 120 pp., cloth, illustrated; the Gas Engine Publishing Company, Cincinnati, O.; price, \$1. It is not often that a girl writes a book on gas engine troubles, and a good, readable book at that, but that is the fact of this case. There is no plot, but quite a little romance, some good descriptions of beautiful Long Island scenery, and a touch of the eternally feminine to take the subject, the real subject of the book, completely out of one's mind. The story deals with the unusual, or, perhaps, a better word would be unique experiences of a young lady who, without previous experience in that line, buys first a small motor boat, later a small 6-horsepower machine, and finally a 20-horsepower automobile. Some of her experiences call for feminine remedies, which are described in language that is truly feminine, as, for instance, "gaskets with buttonholes for the bolts to go through"; a commutator, "the under side of which consisted of a piece of brass set in a fiber bracelet around its shaft," etc. It is a pleasant, readable little book, gotten up in the style of a gift edition, on heavy book paper, with wide margins, pretty type face, and a good binding. The novice and some "experts" will learn much from the troubles experienced by the author and their solutions.

Standard Roller Bearing Company, Philadelphia.—Engineers and others interested in ball or roller bearings should send for No. 24 catalogue of the Standard Roller Bearing Company. This 200-page booklet in pocket size not only contains pictures taken in the various shops showing the manufacturing processes, efficiency, power and friction curves, together with a full description and prices of all S. R. B. products. These include ball and roller bearings, complete front and rear axles, gray iron, brass and crucible steel castings, drop forgings and machine work on particular duplicate parts, which can be handled in automatic machinery.

National Brake & Electric Company, Milwaukee, Wis.—Under the title, "Air Compressors for Industrial Service," this concern has issued a little pamphlet that will greatly interest garagemen and others having necessity for compressed air. Besides a regular line varying from a single-cylinder, 1-2 by 4 1-2 machine up to three-cylinder, 11 1-8 by 15 1-2, the company is now turning out a portable outfit in several styles. This consists of a small compressor and motive power mounted on a hand truck, the whole being made narrow enough to go through ordinary doors. Dimensions, capacity and other data are given in tabular form.

Premier Motor Mfg. Co., Indianapolis.—The frontispiece of the early catalogue of the Premier Motor Mfg. Co. shows an interesting photo of the 100-miles-for-100-days car passing the 5,000-mile mark on the second day of the Glidden Tour. This leaflet is a brief description of the mechanical details of this Indianapolis product. The changes indicated are very few and far between, being refinements rather than changes. The low-tension make and break ignition is now regular on both the four and six-cylinder models. This company may be fairly numbered among the American advocates of this type of ignition.

Hart-Kraft Motor Wagons, York, Pa.—Catalogue B, describing the commercial power wagons recently placed on the market. These include four types of body on the same chassis, all of 1,000 pounds capacity. The feature is an interchangeable self-contained unit power plant which may be removed at very short notice by the simple removal of five bolts. This allows the withdrawal of the complete power plant and the immediate substitution of another with a minimum amount of lost time.

A. S. Noonan Tool & Machine Works, Rome, N. Y.—Catalogue showing automobile, motorcycle and bicycle tools manufactured by this firm. These include valve spring lifters, tire holders, muffler cutouts, spark plug terminals, etc.

**INDEX
TO ADVERTISERS**

Abrams-Mason Co.....97	Eberman Auto Appliance Co...76	Lockwood Bros.....102	Rome-Turney Radiator Co....80
Acetylene Gas Illuminating Co. 62	Echo Horn Co.....30	Locomobile Co. of America.....64	Robinson & Sons Co., Wm. C. 65
Acme Motor Car Co.....64	Edison Auto Accessories Co. 62	Long Arm System Co.....79	Rockwood Mfg. Co.....67
Adams Co.....64	Edmunds & Jones Mfg. Co. 76	Long Island Auto Supply Mfg. Co. 97	Royal Equipment Co.....79-83
Ajax-Grieb Rubber Co.....64	Eldredge Electric Mfg. Co. 67	Long Mfg. Co.....80	Royal Tourist Motor Car Co. 110
Allen-Kingston Motor Car Co. 110	Elite Mfg. Co.....118	Madison Square Garden Show. 89	Rushmore Dynamo Works.....92
Air-Tight Steel Tank Co.....101	Elmore Mfg. Co.....122	Magna Mfg. Co., R. W.....98	Sager Co., J. H.....112
Allen Auto Specialty Co.....102	Empire Automobile Tire Co. 106	Masury & Son, John W.....101	Springfield Portable House Co. 73
American Distributing Co.....103	Everett-Metzger-Flanders Co. 103	Matheson Automobile Co.....96	Stitch-in-Time Vulcanizer Co. 76
American Electric Fuse Co.....100	Excelsior Supply Co.....73	Maxwell-Briscoe Motor Co. 84	Safety Device Co.....83
American Motor Car Co.....104	Excellor Tire Co.....59	McCord Mfg. Co.....68	Salisbury Wheel & Mfg. Co. 86
Anderson Forge & Machine Co. 66	Fedders Mfg. Co.....102	McCue Co.....109	Samson Leather Tire Co. 67
Ashtabula Bow Socket Co.....65	Firestone Tire & Rubber Co. 115	Mechanical & Elec. Mfg. Co. 65	Schenectady Spark Plug Co. 77
Atwater-Kent Mfg. Works.....87	Fisk Rubber Co.....100	Merritt & Co.....62	Schrader's Son, A.....62
Atwood-Castle Co.....Cover	Flentje, Ernst.....79	Maple City Mfg. Co.....63	Schubert Bros. Gear Co.....102
Austin Automobile Co.....91	Fort Pitt Motor Car Co.....61	Michelin Tire Co.....84	Selden Motor Vehicle Co.....123
Auto Car Equipment Co.....109	Franklin Mfg. Co., H. H.....64	Midland Motor Car Co.....103	Shaler Co., C. A.....97
Auto Pump Co.....68	French Mfg. Co.....68	Miller & Starr.....63	Shawyer Co.....73
Auto & Supply Mfg. Co.....76	G & J Tire Co.....106-107	Miller, Chas. E.....73	Sireno Co.....66
Avery Portable Lighting Co.....69	Gabriel Horn Mfg. Co.....38	Mitchell Motor Car Co.....105	Spacke Machine Co., F. W.....65
Baker Motor Vehicle Co.....64	Gaeth Automobile Co.....103	Model Automobile Co.....124	Spare Motor Wheel of Am.....103
Baker Mfg. Co.....61	Gearless Motor Car Co.....64	Moline Automobile Co.....104	Speed Changing Pulley Co.....101
Baldwin Chain & Mfg. Co.....66	Gelsler Bros.....63	Moon Motor Car Co.....64	Speedwell Motor Car Co.....76
Baum Iron Co.....80	General Accumulator & Battery Co.....62	Morgan & Wright.....87	Spicer Universal Joint Mfg. Co. 70
Beaver Mfg. Co.....63	Goodrich Co., B. F.....65	Mosler & Co., A. R.....66	Splittdorf, C. F.....97
Benz Auto Import Co.....60	Goodyear Tire & Rubber Co. 32	Moss Photo Engraving Co.....83	Standard Co.....72
Billings & Spencer Co.....61	Gordon Automobile Supply Co. 62	Motz Clincher Tire & Rub. Co. 65	Standard Roller Bearing Co. 97
Bi-Motor Equipment Co.....62	GrammLogan Motor Car Co. 64	Muller, Albert.....62	Standard Welding Co.....106
Black Mfg. Co.....67	Graves & Congdon Co.....102	Mutty Co., L. J.....65	Stanley & Paterson.....108
Boston Auto Gage Co.....63	Gray & Davis.....Cover	New Process Rawhide Co.....97	Star Speedometer Co.....86
Bliss-Chester Co.....62	Grout Auto Co.....77	Nightingale Whistle Mfg. Co. 65	Stearns Co., F. B.....105
Bartholomew Co.....112	Ham Mfg. Co., C. T.....68	National Brake & Clutch Co. 66	Stevens-Britton-Maurel Co. 62
Brown Co.....102	Hardy Co., The R. E.....63	National Motor Vehicle Co.....110	Stevens-Duryea Co.....113
Borbeln Auto Co.....68	Harris Oil Co.....86	National Tube Co.....61	Stewart & Clark Mfg. Co.....71
Boston Auto Gage Co.....63	Hartford Suspension Co.....85	Neustadt Auto & Supply Co. 67	Stromberg Motor Device Co., Cover
Bowser & Co., S. F.....63	Haws, George A.....65	Nevermiss Spark Plug Co. 77	Studebaker Automobile Co.....64
Boyle & Co., John.....108	Haynes Automobile Co.....121	New Departure Mfg. Co.....111	Success Auto Buggy Co.....64
Bretz & Co., J. S.....106	Healy Leather Tire Co.....65	New Idea Sales Co.....69	Supplementary Spiral Spring Co. 108
Briscoe Mfg. Co.....95	Helnze Electric Co.....72	N. Y. & N. J. Lubricant Co. 99	Swinehart Clincher Tire Co. 98
Brown & Co., S. N.....65	Herschell-Spillman Co. 66	Nordyke & Marmon Co.....113	Syracuse Alum. & Bronze Co. 99
Brownell Motor Co., F. A.....66	Herz & Co.....66	Northway Motor & Mfg. Co. 79	Syracuse Chemical Fire Extinguisher Co. 81
Buckeye Jack Mfg. Co.....67	Hess-Bright Co.....89	Nuttall Co., R. D.....66	Thomas Motor Co., E. R.....104
Buckeye Mfg. Co.....90	Hoffman, Geo. W.....62	Oldfeldt & Sons, F. W.....63	Timken Roller Bearing Axle Co. 120
Buffalo Specialty Co.....82	Holly Bros. Co., W.....117	Olfs Motor Works.....64	Trade Directory.....78
Buob & Scheu.....65	Hopewell Bros.....62	Overland Automobile Co.....126	Tray Plate Battery Co.....98
Burnett-Compound Spring Co. 80	Hotel Woodstock.....88	Owen & Co., R. M.....64	Trenton Rubber Mfg. Co.....65
Byrne-Kingston Co.....70	Howard Motor Works.....84	Page-Storms Drop Forge Co. 65	Trimont Mfg. Co.....77
Cadillac Motor Car Co.....64	Hotel Tuller.....98	Palmer & Singer Mfg. Co. 64	Triple Action Spring Co.....98
Cameron Car Co.....83	Hoyt Electrical Ins. Works. 100	Pantasote Co.....65	Trojan Hydro Pneumatic Wheel Co. 81
Canton Drop Forging Co.....66	Indestructible Steel Wheel Co. 66	Parish & Bingham.....66	Tucker, C. F.....62
Cook's Sons, Adam.....97	Industrious Automobile Co.....94	Parker Mfg. Co.....62	Tudor Mfg. Co.....98
Chicago Show.....114	Jeffery-DeWitt Co.....80	Parker, Stearns & Co.....65	Uncas Specialty Co.....98
Carr, F. S.....65	Jeffery & Co., Thos. B. 125	Peerless Specialty Co.....105	Universal Tire Protector Co. 103
Cartercar Co.....104	Jewell Motor Car Co.....105	Pennsylvania Auto Motor Co. 82	Universal Tire Remover.....62
Chadwick Engineering Works. 108	Johnson Co., Iver.....65	Perfection Non-Skid Climber Co. 108	Utility Co.....63
Chase Motor Truck Co.....105	Johnson Service Co.....61	Perfection Wrench Co.....66	Van Wagner Mfg. Co., E. B. 63
Chelsea Clock Co.....Cover	Joyce-Cridland Co.....64	Petrel Motor Car Co.....109	Veeder Mfg. Co.....85
Cleanola Co.....106	K. W. Ignition Co.....99	Peugeot Freres.....66	Velle Motor Vehicle Co.....75
Coes Wrench Co.....57	Karl & Co., Adolph.....64	Pierome Hide Co.....66	Victor Clutch Compound Co. 62
Columbia Lubricants Co.....79	Keystone Lubricating Co. Cover	Pioneer Brass Works.....66	Victor Lamp Co.....86
Conn. Tel. & Elec. Co.....88	Kimball Tire Case Co.....67	Pirelli & Co.....68	Victor Tire Traction Co.....72
Continental Caoutchouc Co. 64	Kissel Motor Car Co.....104	Prest-O-Lite Co.....68	Waban Webbing Co.....63
Continental Motor Mfg. Co. 69	Kitsee Storage Battery Co. 77	Price Co., Henry W.....83	Warner Instrument Co.....100
Corbin Motor Vehicle Corp. 104	Knox Automobile Co.....111	Prosser & Sons, Thos.....107	Watt-Detroit Carburetor Co. 80
Corcoran Lamp Co.....76	Konigsow, Otto.....66	Puritan Gas Tank Co.....62	Weed Chain Tire Grip Co. 80
Cornish Friedburg Motor Car. 64	Larchmont Mfg. Co.....63	Quincy Co., J. M.....72	Weston Elec. Instrument Co. 81
Correspondence School of Motor Car practice.....62	Leather Tire Goods Co.....65	Quincy - Manchester Sargent Co. 101	Wheeler & Schebler.....119
Cowles & Co., C.....62	Lehman Mfg. Co., J. H.....64	Ralmes & Co.....62	White Co.....93
Cullman Wheel Co.....66	Life Publishing Co.....62	Rauch & Lang Carriage Co. 104	White & Bagley Co.....102
Dayton Motor Car Co.....103	Lipman Mfg. Co.....63	Regal Motor Car Co.....79	Whitlock Coil Pipe Co.....109
Dayton Rubber Mfg. Co.....64	Locke Pump & Machinery Co. 63	Remy Electric Co.....62	Whitney Mfg. Co.....107
DeLux Motor Car Co.....64	Locke & Co.....108	Republic Rubber Co.....65	Widmer Machine Works, C. A. 98
Davies Co., J. P.....97	Lockwood Bros.....102	Robert Instrument Co.....62	Willard Storage Battery Co. 79
Diamond Chain & Mfg. Co. 66	Locomobile Co. of America.....64		Winton Motor Carriage Co. 128
Diamond Rubber Co.....116	Long Arm System Co.....79		Witherbee Igniter Co.....65
Dietz Co., R. E.....72	Long Island Auto Supply Mfg. Co. 97		Wyman & Gordon Co.....107
	Long Mfg. Co.....80		York Motor Car Co.....101

FOR UNMATCHABLE QUALITY BUY

COES

STEEL HANDLE MODEL WRENCH

91

91

Look for the name—COES

THE WRENCH for Automobilists

High-grade quality in every detail of design, material, workmanship and up-to-date improvement. Excellence with extremely reasonable cost.

NON-BREAKABLE CASTINGS
NON-STRIPABLE THREADS
NON-TROUBLESOME PARTS

QUALITY
Through and Through.

70 years splendid reputation worthy maintained right up to the present time as the World's Best Wrench Makers. Write for "Wrench Book" free.

COES WRENCH CO., WORCESTER, MASS.



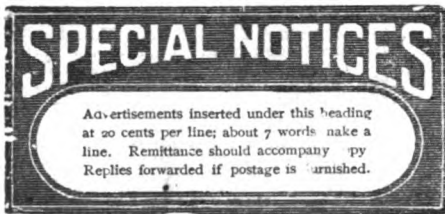

Cars for Sale

A 1909 seven-passenger Apperson, cost \$4,700. February delivery. Failure in speculation forces me to sell my contract at a loss of \$1,000; this your gain. F. P., care The Automobile.

A 1907 24-H.P. JACKSON runabout, shaft drive, top and glass front, nearly new.....\$700
1907 35-h.p. Grout, 5-passenger, with top, Rutenber motor.....\$800
Thomas B. Jeffery & Co., 1462 Michigan Ave., Chicago, Ill.

A N ELECTRIC VICTORIA in fine order; batteries nearly new; demonstration; using gas car, reason for selling; cost \$1,375; price \$500. Address "E," Room 1004, 261 Broadway, New York City.

A LL KINDS of cars at all kinds of prices, \$150 and up. Write us or call and we can satisfy you. Western Auto Sales Co., 309, 10-11 Michigan Ave., Chicago, Ill.

A PIERCE-ARROW car, 40-h.p., 1907 model, full equipment, regular Pierce top, and glass front. The car is in first-class condition. For further particulars, address George A. Driggs, Waterbury, Conn.

A PPERSON touring car, cost \$3,750. In perfect condition, with top, glass front, extra tires, etc., \$1,750 in money (not farms or mining stock). E. Hambley, S. E. Eighth and Main Sts., Cincinnati, Ohio.

A UTO BARGAINS.—Before you buy, talk to us. We have them from one to five hundred dollars and can save you money. Ewing-Kean Machine Co., 723 W. Fort, Detroit, Mich. Phone, West 1253-R.

A UTOBILIE BARGAINS. — Used machines, all kinds, \$150 and up. Send for our complete list. Johnson Auto Co., 4390 Olive St., St. Louis, Mo.

A UTOBILIEs less a dealer's profit. Selling for owners on 5 per cent. commission, you get your car here less the usual profit demanded by the dealer. In the largest garage in New York we have 250 cars to select from. We are two blocks from Broadway, and each block represents many thousands saved in rent. Our system and location make it evident why our prices are often less than one-half what dealers ask. Among recent arrivals are the following special tonneaus:

Matheson, 45-50-h.p., \$1,500; Royal Tourist, \$950; Stoddard-Dayton, \$950; DeDietrich, \$1,000; Pope-Toledo, \$750; Locomobile, \$800; Pope-Hartford, \$400. In runabouts we have Cadillac, \$275; Knox, \$300; Darracq, \$300; Oldsmobile Tourabout, with rumble seat, \$1,000. All the above cars are in A-1 condition. We quote prices because they are the best argument. Don't buy a car until you have inspected our many offers. Manhattan Storage Co., 334-340 West 44th St., New York City.

B. L. M., 35-h.p. 1908 model, high-speed runabout; very best condition; complete equipment and spare parts. Address "Duncan," care The Automobile.

C AMERON, air-cooled, three-passenger roadster, four-cylinder; taken in exchange and thoroughly overhauled; perfect running order; \$550. Cameron Agency, Room 601, 546 Fifth Ave., New York City.

C ORBIN touring cars and runabouts, \$800 and up. Thoroughly overhauled by us and guaranteed. Corbin Motor Vehicle Cop'n of N. Y., 1888 Broadway, near 62d St., New York City.

D ON'T PAY TOO MUCH or too little for a slightly used or second-hand automobile. Extravagant claims are made for automobiles at your own price. We have 150 to 200 types and models of various makes of automobiles at a full dollar of automobile value for every dollar of price. Much detailed information of great economic interest to prospective purchasers is here for you; and you will be truly grateful after investigating by a personal call or through the medium of our price list. International Auto Co., 542-544 Wabash Ave., successors to Chicago Auto Warehouse and Chicago Auto Commission Co., Chicago, Ill.

ELMORE CAR, fully equipped, \$350.00. Box 519, Mountain Dale, N. Y.

FRANKLIN RUNABOUT FOR SALE—Excellent condition; good tires. 1007 Wylie Ave., Pittsburg, Pa.

FRANKLIN light touring car; all in fine condition; extra equipment; specifications and photo sent on request; price, \$300. H. J. Daniels, Norwich, N. Y.

HAVING PURCHASED next year's model, will let go my 35-h.p. Peerless, demilimousine body, for \$1,250; completely equipped and put in A-1 shape; no agents need answer. Address Box 134, care The Automobile.

HOLSMAN.—Just overhauled; Schebler carburetor, leather top, special battery case; low price. 47 William St., Newark, N. J.

MAXWELL runabout model LC 1908, with top, gas lamps and generator complete; good as new, only run a short while. Will sell for \$600 and guarantee it to be in perfect order. Write J. O. Sparks, Gaffney, S. C.

MODEL S, "07" HAYNES, 4-cylinder, 5-passenger touring car, in first-class condition; car and equipment cost \$2,800; will sell for less than half cost. Write for particulars to G. A. St. Germain, 241 Main St., Berlin, N. H.

MUST be sold immediately regardless of value one 14-h.p. two-cylinder chainless runabout automobile, with top; in fine running condition, etc. First check for \$395 takes it. Box 99, Sumter, S. C.

MUST DISPOSE of my Stoddard-Dayton roadster for cash at once; was purchased in May, 1908, and run only 2,000 miles; looks just like new; has four cylinders, 40-h.p. motor; in perfect condition; first offer for \$1,400 gets it; dealers need not answer. Address Box 23, care The Automobile.

ONE 1907 Model G touring car, fully equipped, in A-1 condition; run about 5,000 miles; will sell at a bargain. Dauer Auto Co., Providence, R. I.

ONE 1907 STEVENS-DURYEA 5-passenger, 6-cylinder car; one 1906 Stevens-Duryea Model R 4-cylinder, 5-passenger car; one 1906 5-passenger, 4-cylinder Oldsmobile. For full information inquire Maine Motor Carriage Co., Portland, Me.

ONE 1907 POPE-HARTFORD roadster. One 1908, Type 12, Pope Toledo touring car. One 1907, Model R, 4-cylinder Stevens-Duryea. One 1907, Model U, 6-cylinder Stevens-Duryea. One 1908, Model S, Ford roadster. One Model E, single-cylinder Rambler. All these cars in good condition and will be sold cheap. For further particulars write The Arthur Gardiner Garage, Kenosha, Wis.

ONE 1906 WHITE steam touring car, equipped with top, etc.; price, \$1,000. One 1906 Model "G" Franklin touring car, equipped with top; A-1 condition; price, \$850. One 1908 Model "10" runabout; used a few times for demonstrating; A-1 shape; price, \$850. One 1904 Cadillac touring car; good condition; price, \$350. 1907 Oldsmobile runabout, A-1 condition; price, \$1,800. One 1906 Model R Stevens-Duryea, overhauled and repainted; price, \$1,200. One 1907 White steam runabout, good condition; price, \$1,300. One 1908 Thomas with tourabout body; first-class condition; price, \$1,500. Halsey Automobile Co., St. Louis, Mo.

PEERLESS "30" 1909.—Regular touring body, with removable glass enclosure for winter; especially fine job; cost \$5,400; family going abroad; will sell at a reduction. Address "G. R.," care The Automobile.

STODDARD-DAYTON—Some slightly used cars for sale; runabout, roadster, touring car and limousine; in A-1 condition. The Dayton Motor Car Co., Dayton, Ohio.

THOMAS 1907 DETROIT, 40 H. P., in excellent condition. Will sell cheap for cash. Write "H. L.," care The Automobile.

THOMAS 1908, 6-cylinder, 70 h. p., 7-passenger touring car; top, glass front, 100-mile Warner electric lights; all accessories in excellent condition. Will sell cheap for cash. "A. L.," care The Automobile.

WANTED TO SELL or exchange, demilimousine 30-35 Rainier, for a small runabout 1908 Buick. Gem, 86 Warren St., New York City.

WE HAVE for sale the following second-hand cars at bargain prices: 1907 Model D touring car; 1906 Model D touring car; 1907 Model G runabout. Franklin Automobile Company, 73d St., Amsterdam Ave. and Broadway, New York.

WHITE steam touring car, 1908 Model K. used only five months and in superb condition throughout; nicely equipped and will be sold at a bargain if taken at once. Address White Steamer, 1200 Niagara St., Buffalo, N. Y.

WHITE STEAMER, 30-h.p., Model G, with 1908 regulation touring body; this car cost \$3,750 without the extras; has fine leather top, Sprague wind shield, Jones speedometer, double tire holders, shock absorbers; car has been driven by the owner and is in fine shape; engine has been overhauled and is in perfect running order; the paint is a dark maroon with black stripes; the tires are practically new. Owner has ordered a new 1909 White. The first check for \$1,500 takes it. Address, 532 Canal St., New Orleans, La.

WINTON '06 four-cylinder touring car, in perfect condition, fully equipped, top \$300. The Fulton Garage, Fulton, N. Y.

WINTON SIXTEEN-SIX, 1908 model, nicely equipped and in absolutely fine condition; will accept \$2,400 if taken at once. E. R. Thomas Motor Co., Second-Hand Department, 1200 Niagara St., Buffalo, N. Y.

WHO wants my Duryea 3-cylinder, 20-h.p. runabout? Leather top, horn, lamps, searchlight, generator, tools, etc.; very powerful, any hill on high gear; demonstration given; sell cheap; write for price or make offer. C. L. Jones, Haskell, N. J.

WRITE for our second-hand bargain list. The Speedwell Motor Car Co., Dayton, Ohio.

20-PASSENGER 50-h.p. sight-seeing car, fully equipped; speed 5 to 30 miles on high; great on hills; bargain if taken at once. E. D. Schultz, 414 W. Ferry St., Buffalo, N. Y.

\$1000 Haynes 50-h.p. touring car, new. Braby & Myers, 364 Columbus Ave., Boston, Mass.

1906 CADILLAC touring car, 1908 Great Western No. 12 touring car, 24-h.p.; 1907 Reo touring car, 20-h.p.; 1906 Oldsmobile, all in good condition. The Fulton Garage, Fulton, N. Y.

1908 REO roadster; 5 lamps, top, Warner speedometer, extra rear seats. F. E. Mason, 93 Exchange St., Rochester, N. Y.

1908 STEVENS-DURYEA Model S, 50-h. p., 7-passenger car; full equipment; as good as new. Will be sold at great sacrifice. Inquire Maine Motor Carriage Co., Portland, Me.

1908 FRANKLIN Model D touring car, 28-h.p., has been used as demonstrator, with double system ignition, Bosch magneto, in first-class condition, with top, glass front and all extras, at a very reasonable figure. Dauer Auto Co., Providence, R. I.

1908 MAXWELL, Cameron, runabout and touring cars; 1907 Ford, Pullman, Stoddard-Dayton, Buick and Reo runabout and touring cars; 1906 Acme touring car; 1905 Rambler and Locomobile touring cars; get prices and specification forms. Berks Auto & Garage Co., Reading, Pa.

Cars Wanted

FOR EXCHANGE.—Attractive motor boat, with standing top; length, 42 ft. 6 in., beam, 7 ft. 6 in., draught, 3 ft.; 40-h.p. Winton motor; Michigan reversible propeller; speed, 13 miles; built by Seabury & Co. hull and machinery in best condition; for 60-h.p. or 40-h.p., 6-cylinder, 1908 Pierce Arrow Automobile. Box 115, care The Automobile.

HAVE ABOUT \$500; want an automobile; must be 4-cylinder, shaft driven, sliding gear; no objection to one out of repair or broken, if of good make. Correspondence solicited. 725 E. Water St., Syracuse, N. Y.

WE WILL PAY full value in spot cash for your automobiles in quantities from one to one hundred. Call or mail descriptions. Broadway Mammoth Automobile Exchange, 245 West 56th St., New York City.

WANTED.—Runabout, new or second-hand, in exchange for the services of an architect and engineer. M., 1227 Herkimer St., Brooklyn, N. Y.

Parts and Accessories

(FOR SALE.)

A LIMOUSINE BODY for sale; in first-class condition; fits any car; cost \$2,200; bargain. 1225 McGee St., Kansas City, Mo.

AUTO TIRES.—All the best makes of tires on hand, at cut prices; big stock of "specials" and "seconds" at "Bargain Counter Prices"; we will save you money on any make and any size; write or call. Broadway Mammoth Automobile Exchange, 245 West 56th St., New York City.

AUTO TIRES.—28x3, \$10; 30x3, \$11; 30x3½, \$13. These are brand new, clean goods. Overstocked. Must sell. Write to-day for new 1909 prices on any size. Will surprise you. A. H. Kasner, 152 Church St., New York City.

AUTO TIRES, new clincher casings, fresh stock, every one a bargain:

28x3\$10.65	30x4\$17.90
30x311.15	32x418.90
32x311.75	34x421.00
28x3½13.00	36x422.00
30x3½13.50	34x4½21.50
32x3½15.80	36x4½23.50
34x3½16.50	36x526.00
36x3½16.50		

W. M. Sharpe, 118 West Broadway, New York City.

BARGAINS in new inner tubes; all guaranteed to hold air. Purchased at special sale.

28x2½, 28x3½, 30x4\$2.50
28x3, 30x3, 30x3½3.00
32x3½, 32x4, 34x3½3.50
34x4, 34x4½, 34x54.00
36x3½, 36x4, 36x4½, 36x54.50

Write for prices on other supplies. We also repair any make of tire. All work guaranteed. Chicago Vulcanizing Co., 1400 Michigan Ave., Chicago, Ill.

BOOTH'S FELT PACKINGS for repairing automobiles are designed to retain the oil, exclude the dust and tighten loose joints, and are absolutely necessary in connection with ball, roller and plain bearings, hubs and transmission cases, and are made in strips and endless rings of any size and thickness to fit any car; dust rings for the hubs, strips for transmission cases, washers for all lubricating and dust-excluding purposes. I have dies to fit any bearing of any make of car, and can fill any order within twenty-four hours. You will get exactly what you want, and the price will be right. There are so many sizes, no dealer carries a full stock. Write for prices and give dimensions. N. E. Booth, 741 39th St., Brooklyn, N. Y.

BRAKES.—External double-acting band brakes; 939-9½"x1½"; 72-9"x2½"; 57-6"x2". No better made; will sacrifice to quick buyer. Address Blackwell Brake Co., Box 1031, Bridgeport, Conn.

DOUBLE-CYLINDER, air-cooled, opposed motor, 4x4, for sale, or would trade for marine engine; price, \$75. Comet Motor Works, 17 West Madison St., Chicago, Ill.

FOLDING wind shield, never used, fit any car; cheap; exceptional bargain. 130 W. 64th St., New York City.

FOR SALE OR TRADE.—Four sets of Kimball steel tire casings, new; one Prest-O-Lite tank; steel coil and one 1906 single-cylinder Olds runabout. P. P. Pagett, General Delivery, Indianapolis, Ind.

FOR SALE.—300 sets 28x3 best grade artillery wheels fitted with clincher rings, less hubs; write for bargain prices on single sets or the lot. Thomas B. Jeffery & Co., Kenosha, Wis.

FOR SALE OR EXCHANGE, being overstocked; several standard high tension magnetos, also double ignition systems, coil and distributors. Wanted cash offer, or will accept in exchange, any standard tires (sizes wanted, 34x4 and 36x4½), or New Victor Talking Machines. Offer also wanted on a 1909 Continental car, valued \$3,500. Full particulars, address "Retired Auto Manufacturer," care The Automobile.

FORD RUNABOUT owners, now is the time to order our outfit to change your N. S. or R. into new "S" roadster, new fenders, and rumble seats, dash hoods, folding hoods, glass fronts, tops, oilers, magnetos. Write for catalogue to-day. Auto Rebuilding Co., 1349 Michigan Ave., Chicago, Ill.

FOUR-H.P. air-cooled engine, with drop-forged crank, one-piece cylinder and head, other valuable features, \$58. Climax Electric Works, New Salem, Mass.

GOODS at less than manufacturers' cost! Bevel gear axles, \$80 per pair; pressed steel frames, \$18; wood wheels, new, 28x2½, \$14 a set; Olds type axles, front, \$10; rear, \$25; tonneau top, upholstered in leather, \$60; four speed oilers, \$3.75; five speed mechanically-operated oilers, \$8; two cylinder Splittendorf dashboard coil, \$12.50; 28x3 tires, \$9; tubes, \$1.50; 12 tube radiators, \$6; hood radiators, \$20; Cotta transmissions, \$60; planetary transmissions, \$23; marine motors, \$28; Warner differential gears, \$9; cylinder oilers, 75 cents; 4½x5 water-cooled motors, \$70; wood wheels, 30x2, with solid tires, \$25; fenders, \$8 a set; 4½x4 air-cooled motor, \$75. Get our bargain sheet. Auto Parts Co., 52 W. Jackson Blvd., Chicago.

NEW five-barrel Bowser, Cut No. 41, self-measuring gasoline tank, with fixtures; tank was only buried a few days; liberal discount made from price paid. J. G. Turnbull, Orleans, Vt.

ONE APPLE 11-S automatic cut-out and voltmeter, \$9. Potter Studio, Camden, Me.

PROTECT YOUR TIRES with Garlick Auto Props; strong and durable. Set of four, \$2.50; with jack attachment, \$4.00; fit any car. Garlick Auto Prop Co., Paterson, N. J.

RADIATORS, hoods, mud guards, metal dishes, gasoline and water tanks. If building or remodeling a car, it will pay you to write us, as we lead in this line. Auto Sheet Metal Works, 2230 Michigan Ave., Chicago, Ill.

RUMBLE SEATS and "baby" tonneaus, for Ford, Maxwell, Buick, Cadillac and other cars, fenders, radiators, hoods. We are the big mail-order rebuilding house. Send for catalogue. Auto Rebuilding Co., 1349 Michigan Ave., Chicago, Ill.

SIX CYLINDERS, \$1.50; four cylinders, \$1; two cylinders, 50 cents, is all you have to pay for the most indispensable auto tool made. "The Trouble Finder." When put on the spark plug you can tell if your timer is in the right place; you can tell which cylinder is not doing its work, caused by leaky valves or a faulty spark plug. Works the same on dry cells, storage or magneto. A good investment for the owner, chauffeur and the repairman. Sent prepaid for stamps, check or currency. Sallander Auto Co., Fort Madison, Iowa.

SPECIAL LOT supplementary springs, wind shields, storage batteries, tire treads, repair kits, boots and patches. Factory prices. Auto Economy Co., 1426 Michigan Ave., Chicago.

SPECIAL LOT 1909 Schebler Carbureter outfits, complete for Reo, Ford, Buick, Maxwell, Cadillac, and other cars; more power, easier starting, better control; \$10.75 to \$18 complete. Jenkins Specialty Mfg. Co., Sumter, S. C.

STEVENS-DURVEA repair parts.—15 per cent. discount. C. D. Snow, 62 Glenham St., Providence, R. I.

TIRE BARGAINS.—25 sets 36x3½", 5 sets 32x4½" Dunlop Universal tires; also several sets Clincher tires, millimeter sizes, plain and Midgley tread; all first-class goods; excellent value. C. A. Leonard, 691 Park St., Hartford, Conn.

TIRES, TIRES.—We can sell any make, any size or style tires or tubes for less money than any dealer in the United States. Do not buy until you get our prices. Send for complete list. Excelsior Tire Company, 1777 Broadway, New York City.

TIPES.—New goods, new goods, 1908 stock.

28x2½\$9.00	28x3\$10.00
30x311.00	34x420.00
30x3½13.00	30x417.50
32x3½16.00	32x419.00

Mail orders filled promptly. We ship goods to every part of the globe. Anchor Tire Co., 88 Chambers St., New York City.

1 32 x 3 1/4 Michelin Dunlop case..... \$25.00
 1-34 x 4 1/2 Firestone Church case..... 32.00
 1-06 Thomas Flyer Buffalo carbureter 8.00
 1-Pittsfield coil unit..... 5.00
 1-08 Reo carbureter..... 7.00
 1-05 Autocar Runabout hnd spring.. 5.00
 1-06 Thomas Flyer hnd spring..... 10.00
 1-Ever Ready tire tools; each..... 3.50
 1-Presto gas tank, full..... 18.00
 New and in A1 shape. Champaign Automobile Co., Champaign, Ill.

1907 LIMOUSINE BODY, built by Rothschild in France, at a cost of \$3,800; will fit a Packard. Will sell for \$300. Frank Reese Automobile School, 2011 North Carlisle St., Philadelphia, Pa.

(Special Notices continued on page 60.)

**TIRES!
TIRES!!
TIRES!!!**

We can sell you any make, any size or style tire or tube for less money than any dealer anywhere in the United States.

We have contracts with the leading makers of automobile tires to sell for them any quantity of surplus stock, enabling us to quote these at 60% to 70% discount from the regular price. Do not buy tires until you get our prices. Bargains in all makes of tires and tubes.

**CLINCHERS
DUNLOPS**

QUICK DETACHABLES

We guarantee these brand new, clean, fresh 1908 stock. This lot includes Morgan & Wright, Ajax, Diamond, Continental, Ennis, Pennsylvania, etc. We are selling the lot while they last.

Size.	Casings.	Tubes.
28 x 2½	\$7.00	\$2.50
28 x 3	11.00	3.00
28 x 3½	15.00	3.50
30 x 2½	8.50	2.75
30 x 3	12.25	3.50
30 x 3½	15.25	3.75
30 x 4	18.50	5.25
32 x 3	10.50	3.25
32 x 3½	16.00	4.00
32 x 4	20.00	5.50
34 x 3	9.25	3.50
34 x 3½	16.00	4.25
34 x 4	22.50	5.75
34 x 4½	23.50	7.50
34 x 5	23.00	6.50
36 x 3½	13.25	4.25
36 x 4	21.50	6.25
36 x 4½	24.00	8.00
36 x 4	23.75	8.25

These prices are only good while our stock lasts, therefore place your order now to get the benefit of our low figures. TERMS are Cash. At the very low price we are selling them, we are obliged to get Cash with order. Do not hesitate to send us money. We are as good as the bank. All C. O. D. orders must be accompanied with 10% of purchase, to cover us on transportation charges.

If you are dissatisfied with your purchase upon receipt of goods, we will refund your money.

**Send for Complete List
Single Tube Tires**

26 x 2½	-	-	-	\$ 8.00
28 x 2½	-	-	-	9.00
28 x 3	-	-	-	11.00

By securing a very large quantity of these goods, we are enabled to quote you these extraordinary low prices.

**EXCELSIOR TIRE CO.
1777 Broadway
New York**

(Special Notices continued from page 59.)

10000 WRAPPED tread inner tubes in stock, brand new. Price, \$3 each. Small sizes, less, 6,000 clincher and quick detachable shoes. Do us a favor and write for prices to-day; will surprise you. A. H. Kasner, 152 Church St., New York City.

Parts and Accessories (WANTED)

GASOLINE ENGINES, all sizes; also transmission gears. G. W. Perkins, Schuylerville, N. Y.

TWO four or six-cylinder motors, 20 to 40-h.p.; must be in good shape. W. W. Butts, Oxford, N. Y.

WANTED.—Carrico two-cylinder air-cooled engine; must be cheap. L. T. Rhoades, Phoenixville, Pa.

Situations Wanted

AMBITIOUS, competent hustler, aged 23, desires position which requires full knowledge in automobiles, with some automobile company. Address Box 983, care The Automobile.

A POSITION as chauffeur by a young man of 28; competent, honest and strictly temperate, with 14 months' experience repairing and driving; gasoline car preferred. Address "Vermont," care The Automobile.

AS CHAUFFEUR, gas or steam cars; A-1 Chicago references; will go anywhere; now employed in Chicago. Address C. S. W., care The Automobile.

AS SALES MANAGER, factory representative or salesman for New England territory preferred, with Boston headquarters, handling automobiles or accessories. Will make change shortly. Fourteen years' successful experience with A-1 record. Salary and commission basis. H. S. C., care The Automobile.

BROAD GAUGE man, with large automobile experience on high-grade work, capable of taking entire charge of coach end, will consider change; good opening with some reputable automobile company preferred. Would like personal appointment at either New York Show. Address "Executive," care The Automobile.

FIRST-CLASS RPAIRMAN AND DRIVER wants position; is thoroughly competent and can furnish own tools; six years' experience, with A1 references. Will go anywhere. W. S. Quigley, Gen'l Del'y, Jacksonville, Fla.

FOREMAN or assistant, or head repairman in garage or factory; several years' experience repairing and adjusting gasoline and electric automobiles; first-class reference. Fills good position at present, but desires change. Thoroughly familiar with all foreign and American made cars, large trucks, etc. "A. T.," Box 512, Groton, Conn.

POSITION WANTED as driver or repairman; private party or shop; any make car; country preferred. Repairman, 104 West 24th St., Wilmington, Del.

Help Wanted

AGENTS.—A new invention, Cling-tight storm apron, holds lap robe around you; keeps wind and water out and comfort in; perfect freedom for hands and feet to drive an auto; put on or off instantly. Sent on approval. Beebe-Elliott Co., 614 Wisconsin St., Racine, Wis.

MAN familiar with construction of gasoline cars, to take charge of storage department of large garage. Must have experience and fair amount of executive ability. Good salary and steady position for right party. Keystone Automobile Company, 5905-5915 Centre Ave., Pittsburg, Pa.

MEN.—Wanted, ambitious and energetic men to learn to repair and run automobiles; home study course if desired, or we will pay your railroad fare to Philadelphia and two weeks' board; easy payments; good pay when competent; free booklet. Automobile School, 752 South Broad St., Philadelphia, Pa.

RAPID and accurate designer and detailer, by large Chicago Auto Manufacturing concern. Steady work and good salary; state previous experience. Address Box 111, care The Automobile.

WANTED AT ONCE.—Man to take charge of an up-to-date garage handling Studebaker cars only, in a city of 12,000 inhabitants; must have five years' experience on all makes of cars; no one need apply without excellent references; man from some factory preferred. Address Eclipse Garage, Box 584, Wilson, N. C.

WANTED.—For storage battery manufactory, man capable of taking complete charge of factory, near Chicago; fine opening for good man; give experience. Address L. Vizay, Lock Box 230, Chicago, Ill.

Insurance

INSURANCE for automobiles.—Broad, safe policies at lowest prices; insurance against fire, self-ignited explosions, transportation hazards, theft, etc.; best services guaranteed, no matter where insurer is located. For particulars address H. W. Beals, 76 William St., New York City. Phone, 3052 John.

Auto Schools

AUTOMOBILE ENGINEERING by correspondence. Course prepared by A. L. Dyke, first auto supply man. New system with mechanical charts. Course, \$10. Something new. Free pamphlet. Investigate. Dyke's Correspondence School of Motoring, St. Louis, Mo.

THE AUTOMOBILE SCHOOL of the West Side Y. M. C. A., the largest in the country, begins its fifth year for instruction. Men are trained efficiently in a 4 or 8 weeks' course, with personal instruction in road work, and in small group classes in shop work. Send for catalog. 310 West 57th St., New York City.

THE AUTOMOBILE INDUSTRY offers a great opportunity for the ambitious man to secure a permanent paying profession. Its growth has been marvelous. It is yet in its infancy. New York City alone will require within two years 5,000 taxicab drivers; commercial vehicles as many more. A competent, careful driver is always in demand for pleasure cars. The supply is limited and the salaries high; the associations are first-class. We can make you a skilled driver, mechanic or salesman. Also course on automobile designing. Write us now for prospectus of terms, etc. New York School of Automobile Engineers, Inc., 145 West 56th St., New York City.

Miscellaneous

AUTOMOBILE TIRES, rebuilt, retreaded, relined, rim cuts and blowouts repaired, inner tubes repaired and respiced; all work thoroughly tested before shipment and fully guaranteed. Thomas Rubber Vulcanizing Co., 227 South St. Joseph St., South Bend, Ind.

AUTOMOBILISTS, ATTENTION!—A grand pair of cinnamon bear robes, \$30; cost \$200; fur-lined coat, lined throughout with the best Australian mink, Persian lamb collar, sell for \$35; cost \$150 in Montreal. Call or write J. Loew, 520 West 145th St., New York City.

COIL REPAIRING.—Ship your coils. We repair them at the lowest expense and guarantee our work for two years. Our unexcelled facilities enable us to do this. "We do things here." Marinette Electrical Repair Co., Marinette, Wis.

CRATE FOR PACKARD TOURING CAR for sale. Any one expecting to tour Europe will do well to consult C. L. Candee, Princeton, N. J.

IF YOU feel you are paying too much for supplies, write for our catalogue and save money. Agents take notice and write today and let us know what cars you sell. Kansas City Automobile Supply Co., 609A 15th St., Kansas City, Mo.

RADIATORS and lamps repaired by experts. Ship to us and follow with letter. Auto Rebuilding Co., 1349 Michigan Ave., Chicago, Ill.

SAVE DOLLARS—Charge and renew old batteries; formula, 10-cent coin. Box 204, Waterloo, Iowa.

THE CAR OF EMPERORS THE EMPEROR OF CARS BENZ MOTOR CARS The Benz Auto Import Co. of America made the First Exhibit of Benz Cars at the Automobile Show, Grand Central Palace, December 31 to January 7. The Benz Cars will not be exhibited at the Madison Square Garden Show. Carl Benz made the first automobile. The first 50 Benz cars were sold in France. The first motor car, as invented by Benz, is in the National Museum at Munich, Germany. Ask us for photo of it, free. The Benz Company has had the honor of supplying Benz Cars to: II. I. M. the Emperor of Germany (3). II. I. M. the Czar of Russia (2). H. M. the King of Sweden. H. M. the Dowager Queen of Sweden. H. R. H. Prince Henry of Prussia (7). H. R. H. the Grand Duke Friedrich of Baden. H. R. H. Prince Waldemar of Prussia. H. R. H. the Grand Duke of Saxe-Weimar-Eisenach. H. R. H. the Grand Duke of Oldenburg. H. R. H. the Grand Duke of Mecklenburg-Strelitz. H. R. H. Prince Eitel Friedrich of Prussia. H. R. H. Prince Leopold of Prussia. H. I. H. Princess Wilhelm of Baden. H. R. H. the Duke Siegfried of Bavaria. H. R. H. Prince Ludwig Ferdinand of Bavaria. H. R. H. the Duke of Calabria, Prince of Bourbon. H. R. H. the Duke of Parma, Prince of Bourbon. H. I. H. the Grand Duke Alexis Alexandrovitch. H. R. H. the Crown Prince Gustav of Sweden. H. R. H. Prince Gustav Adolf of Sweden. H. R. H. Prince Eugene of Sweden. H. R. H. Prince Charles of Sweden. H. H. Prince Alexander of Oldenburg. H. R. H. Princess Stephanie of Belgium. H. R. H. Prince Ibrahim Halim Pascha. H. H. Prince Maximilian of Baden. H. H. the Duke Regent Johann Albrecht of Brunswick. H. H. the Duchess of Anhalt. H. H. the Hereditary Grand Duke Adolf Friedrich of Mecklenburg-Strelitz. H. H. Prince Karl Anton of Hohenzollern. H. H. the Duke Adolf Friedrich of Mecklenburg. H. H. Prince Ernst of Saxe-Weimar. H. H. Prince Wilhelm of Saxe-Weimar. H. H. Prince Maximilian of Thurn and Taxis. H. H. Prince Moritz of Hohenlohe-Schillingsfürst. H. H. Prince Karl Gottfried of Hohenlohe-Ingelfingen. H. H. the Duke of Hatzfeldt and Trachenberg. H. H. Prince Richard of Sayn-Wittgenstein-Berleburg. H. H. the Prince of Leiningen. H. H. the Prince of Lichnowsky. H. H. the Prince of Oettingen-Spielberg. H. H. the Prince of Oettingen-Wallerstein. H. H. the Prince of Quadt-Wykradt-Isny. H. H. the Prince Lwoff. H. E. Count Wedel, Imperial Governor of Alsace-Lorraine. See the Benz Racing Car, as driven by Hemery in the Grand Prize at Savannah. 1909 CATALOGUE NOW READY Temporary American Offices and Salesrooms. The Benz Auto Import Co. of America, 1597-1599-1601 Broadway (Between 48th and 50th Sts.), New York City. Telephone, 3423—Bryant. Cable address:—Benzauto, New York.

SECOND-HAND Indian and Columbia motorcycles. Excelsior autocyce agency. The Ambold Sporting Goods Co., Waco, Tex.

SHINEBRIGHT METAL POLISH is absolutely the best on the market; sample and quotation furnished upon request. Shove & Gage Co., Inc., Providence, R. I.

THIS IS THE TIME of year to send in your old tires and have them put in A-1 shape for spring service. We are not the largest, but the best, tire repair company in the country. We also supply and sell all makes of solid vehicle tires; also all makes of new auto casings and tubes. We have on hand a full line of second-hand tires and tubes, at one-third the list price of new tires and tubes. This is not hot air. Give us a trial and be convinced. Chicago Tire Repair Co., Michigan Blvd., at 35th St., Chicago.

TIRES.—Model Vulcanizing Co. tires. Have your tires repaired and vulcanized by reliable experts. All work guaranteed. Let us save you money on new tires. We repair all types of Clincher motor cycle casings and tubes, and also repair and apply solid vehicle tires. Our motto: Right and reasonable. Model Vulcanizing Co., 1547 Michigan Ave., Chicago, Ill.

U-AUTO POLISH will keep the varnished parts of your automobile or carriage in excellent shape. Address Shove & Gage Co., Inc., Providence, R. I., for sample.

TIRES REPAIRED.—Automobile owners, do you want your tires repaired or recovered by the people who know how? Give us a trial and be convinced. Inner tubes vulcanized at short notice. Jungkind & Vogler, 158 Chambers St., New York City. Telephone, 3386 Cortlandt.

TWO TWIN-ENGINE Indian Motorcycles; one 8-horsepower Minerva. H. E. Coryell, rear 353 Main St., East Orange, N. J.

STEAM CAR OWNERS—Send for sample of engine and pump packing. R. A. Robbel, 221 East 31st St., Chicago, Ill.

Do You Want The Agency

for the best gasoline car ever made for the money and one as good as any at whatever price? Write

Johnson Service Company
MILWAUKEE, WIS.
Cor. Michigan and Jefferson Sts.

AUTOMOBILE CATECHISM

For the Use of Owners and Drivers of Cars Fitted with Internal Combustion Motors

By **FORREST R. JONES, M.E.**
President of the Manhattan Automobile School

THIS is the most practical, up-to-date work on the subject in the English language. It is published in pocketbook form, with high-grade leather cover, and printed on especially tough paper, as it is intended to be the inseparable companion of the autoist when on tour. Size, 4½x7 inches. Pages 134. With Drawings.

PRICE, IN GENUINE MOROCCO COVER, GILT EDGES, \$2.00, INCLUDING POSTAGE

The **CLASS JOURNAL COMPANY**
231-241 West 39th Street, New York

Advertisements inserted in Special Notice columns at 20 cents per line; seven words make a line. Remittances should accompany copy. Replies forwarded, if postage is furnished. The Automobile, 231-241 W. 39th St., New York.



OWNERS OF AUTOMOBILES SHOULD HAVE

SELF-PROPELLED VEHICLES

IN THEIR LIBRARIES

IT'S a new book by J. E. Homans, A.M., and tells the whole story. It explains in simple, non-technical language the mechanism and management of every type of automobile. 640 pages; 500 illustrations; complete diagrams; ready reference index. \$2.00.

Address
Book Dept., **CLASS JOURNAL CO.**
231-241 W. 39th St., New York



SHELBY SEAMLESS STEEL TUBING

ADAPTED FOR A VARIETY OF USES IN MECHANICAL AND ENGINEERING LINES

SEND FOR ILLUSTRATED BROCHURE ON SEAMLESS TUBES.

NATIONAL TUBE COMPANY
GENERAL OFFICES: FRICK BUILDING
PITTSBURGH, PA.

DISTRICT SALES OFFICES

Atlanta	New York	San Francisco
Chicago	Philadelphia	St. Louis
Denver	Pittsburgh	Salt Lake City
New Orleans	Portland	Seattle

Construction of a Gasoline Motor Vehicle

By **C. C. BRAMWELL.** Contains 150 pages, 6 x 9; one hundred illustrations and diagrams. Publisher's price, \$2.00; our price, 50 cents. Address, The Automobile, 231-241 West 39th Street, New York.

The Wyman & Gordon Co.

MAKE



DROP FORGINGS

THAT ARE STRONG

WORCESTER MASS. FORGED WITHOUT WELDS CLEVELAND OHIO

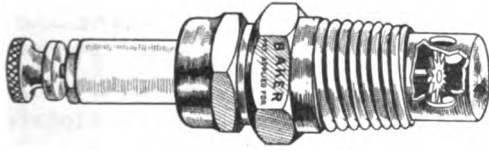

"BAKER" SPARK PLUG A permanent fixture to your engine. You do not have to take it out and clean it—it cannot foul or short circuit under the severest conditions. Enclosed ignition chamber and the multiple sparking points insure positive ignition, and the highest degree of efficiency is obtained regardless of conditions imposed. Sparks in oil, and never fails to ignite under the least electromotive force. You never saw anything half so good as this. Order one to-day and try it.

The Baker Mfg. Co., (Inc.) Cor. East & Chapel Sts. NEW HAVEN, CT.
See our Exhibit, Space No. 433, 3d Tier, Garden Show

"ALL STEEL"

The **B & S "All Steel" Screw Driver**—new and improved—complete in one piece—drop forged of steel throughout with carefully tempered point. Specially designed handle for insuring positive and easy grip.



Nothing to get out of order—SIMPLE LIGHT, EFFECTIVE and DURABLE. Made in eleven sizes—including two of heavier model with square shank for the application of a wrench. Write for prices. **THE BILLINGS & SPENCER CO.,** Mfrs., Hartford Conn.



THE MARK OF QUALITY
THE BILLINGS & SPENCER CO.
HARTFORD

OUTFITS AND SUPPLIES

C. COWLES & CO., New Haven, Conn.

We will exhibit at the Grand Central Palace, space 149, section "S," gallery also at the Madison Square Garden, Concert Hall, space 319.

Don't fail to see our particularly interesting Exhibit of Novelties.

C. COWLES & CO., New Haven, Conn.



Universal Auto-Tire Remover
removes any Standard Clincher or Quick Detachable Tire. Send for one at once, you don't know how soon you may need it. Price, \$3.
948 Market St. (Room 412) SAN FRANCISCO

ESTABLISHED 1844.



SCHRADER UNIVERSAL VALVES
TRADE MARK REGISTERED APRIL 30, 1885.
The Standard American Valves for Automobile, Bicycle & Vehicle tires
Manufactured by
A. SCHRADER'S SON, INC.
78-79 Rose St., New York, U.S.A.

Complete Course
Automobile Instruction
Invaluable to the owner or prospective owner of a motor car
Practical and to the Point
Send for Prospectus to the
Correspondence School of Motor Car Practice,
Tarrytown, N. Y.

LIFE

is the greatest medium for selling Automobiles and Accessories.
I have figures which prove my claims. Address,
George B. Richardson, Manager Advertising Department.
LIFE PUBLISHING CO., 19 W. 31st St., New York City

SUBSCRIBE FOR THE AUTOMOBILE WEEKLY—\$3.00 PER YEAR

THIS MAGNETO IS "FOOL-PROOF"
The most un-killful driver can install the Remy 1909 High-Tension Magneto. Improper connection cannot injure it, and no amount of tinkering will put it out of commission. The Remy will stand more neglect, oil, dirt and water than any other ignition system in the world. More than 17,000 Remy's have already been sold for 1909 cars—more Remy's than all others combined. Write for illustrations and description.
THE REMY ELECTRIC CO., Dept. 12, Anderson, Ind.
We have opened a branch house in Thoroughfare Bldg., Broadway and 47th St., New York.



U.S. METAL POLISH
Highest Award
Chicago World's Fair 1898.
Louisiana Purchase Exposition, St. Louis, Mo., 1894.
3-oz. Box for 10 cents.
Sold by Agents and Dealers all over the world. Ask or write for FREE samples.
5-lb. Pails, \$1.00.
GEO. W. HOFFMAN
Expert Polish Maker
Indianapolis, Indiana.
Sold by Dealers.
New York City Office,
1-8 Park St.

METAL POLISH
Highest Award
Chicago World's Fair 1898.
Louisiana Purchase Exposition, St. Louis, Mo., 1894.
3-oz. Box for 10 cents.
Sold by Agents and Dealers all over the world. Ask or write for FREE samples.
5-lb. Pails, \$1.00.
GEO. W. HOFFMAN
Expert Polish Maker
Indianapolis, Indiana.
Sold by Dealers.
New York City Office,
1-8 Park St.



DUPLEX WIRE TERMINALS
PREVENT LOOSE WIRES & POOR CONNECTIONS
SIZES FOR BATTERY, PRIMARY, AND SECONDARY WIRES CARRIED IN STOCK.
Send 50 Cents for Assorted Package
FLEXIBLE BATTERY CONNECTORS.
THE BLISS-CHESTER CO. PROVIDENCE, R.I.



HOPEWELL TIRE CASE
All Styles—All Sizes
FABRIC SUPPLIES, ROBES, TOOL ROLLS, VEST PROTECTORS, ETC., AT ATTRACTIVE PRICES.
HOPEWELL BROS., Cambridge, Mass.

Stevens-Britton-Maurel Co.
AUTO ACCESSORIES
MANUFACTURERS' AGENTS
1783 Broadway, N. Y. Tel. 6105 Col.

UNVARYING QUALITY.
Quality so high, that
"GLOBE" METAL POLISH
"It stays bright"
is the first selection wherever polish is used
Sold by the best dealers in every city
RAIMES & CO. Ferry St., N. Y. City

CANDY CARBIDE
Trade Mark
No more trouble with generators. Sold only in 10 lb. cans, with green labels. Price \$2.00 each, from all Auto Supply Houses. A 10 lb. can, 5" x 11", will make gas enough to fill up two of the largest gas tanks in the market.
ACETYLENE GAS ILLUMINATING CO.
405 Broome Street, New York

EDISON
DOUBLE SYSTEM SPARK PLUG
.. \$2.50 ..
EDISON AUTO ACCESSORIES CO.
1779 BROADWAY NEW YORK CITY

Automobile Supplies
Motor Cycles, Bicycles and Sundries
Our New Adjustable Tire Bracket is Ready



Schebler Carbureters
Nonpareil Horns
N. E. Agents
Pittsburg Lamps
Prices right Deliveries Prompt

Daylight Continuous! Puritan Gas Tanks
Manufactured by
PURITAN GAS TANK COMPANY
45 Milk Street - Boston, Mass.
Agencies in leading cities. Don't have to cut prices. Send for description.

The A.B.C. of Dust Proof Oil Mole Covers, learned in the school of experience. Get busy, join the class.
Style B Style C Style A
C. F. TUCKER Hartford, Conn.



Test your batteries with a meter that is accurate, durable and guaranteed.
ROBERT VOLT-AMMETERS, \$6.00
" VOLT-METERS, \$4.00
" AMMETERS, \$4.00
including leather case.
Send for catalog
Robert Instrument Co.
66 Shelby St., Detroit, Mich.



DECARBONIZER
chemically removes carbon from cylinders, piston valves and rings. INCREASES POWER 20 per cent.
Volatilizes carbon in which form it passes out exhaust. Injury to metal work impossible. Agents wanted in certain localities. Write to-day for particulars.
General Accumulator & Battery Co.
150 Second St., Milwaukee, Wis.

Gordon Spark Plug
Best Porcelain Plug Made
Price, \$1.25 Each
Makers of Eisner Spark Coils, Timers and Distributors. New England Agents for "Yankee" Silent Mufflers. We repair all makes of ignition.
Gordon Automobile Supply Co.
H. Eisner, Manager
1024 BOYLSTON ST. BOSTON, MASS.



Poro Ignitor Storage Batteries
Put up in celluloid cases
Guaranteed to give satisfaction. Write for price list.
Manufactured by
ALBERT MULLER
145 West 49 Street
New York City

TRY VICTOR CLUTCH COMPOUND FOR A SLIPPING CLUTCH
MANUFACTURED BY
VICTOR CLUTCH COMPOUND CO., NASHUA N.H.

EXPANDED METAL LOCKERS
Sheet Steel Material Closets
MERRITT & CO.
45 ARCH STREET CAMDEN, N. J.



STANDARD (Trade Mark)
SPEED-METER
Accuracy and durability guaranteed. Hand is absolutely steady at all speeds.
40, 60, 80-mile instruments.
Send for catalogue and prices. Agents wanted.
PARKER MFG. CO., 8 Clifton St. Boston, Mass.

F. W. OFELDT & SONS
Nyack-on-the-Hudson, N. Y.
MANUFACTURERS OF
Blue Flame Kerosene Burner
Safety Water Tube Boiler
Automatic Water Regulator
Automatic Fuel Regulator
Feed Water Heater
Compound Steam Engines
Our Kerosene Burner works to perfection on White Steamers



BEAVER MOTORS
6 cylinder, vertical, 40-45 H.P.
4 cylinder, vertical, 28-30 and 35 40 H.P.
2 cylinder, horizontal opposed 10 12 14-16 and 18 20 H.P.
4 cylinder, horizontal opposed (special for commercial trucks) 35 40 H.P.
Center Crank Oiling Device.—4-cylinder. Free Booklet.
Beaver Manufacturing Company
143 Burrell Street, MILWAUKEE, WIS.



ALCO-METER
(Patent Pending)
Tells you just what degree of cold your radiator solution will withstand. Delivered anywhere on receipt of price \$4.00. Satisfaction guaranteed or money refunded.
LARCHMONT MFG. CO.
LARCHMONT, N. Y.

Send for Catalog
Rotary Pumps
for Circulation of Water and Oil on Automobile, Marine or Stationary Engines, and for bilge purposes. All sizes and capacities
THE LIPMAN MFG. CO
210 Pleasant Street, Beloit, Wis.



GEISZLER STORAGE BATTERY
Non-Sulphating
6 VOLT, 60 AMPERE HOUR
Price, \$15.00
GUARANTEED FOR ONE YEAR
Send for Catalog A
GEISZLER BROS.
514 W. 57th St., New York City



No. 55
The "GOTHAM" STA-RITE will end your spark plug troubles. Soot can't stick to the porcelain. Won't short-circuit. Never leaks. Can be taken apart and cleaned with ease. Of dealers or direct, \$1.00
The R. E. HARDY CO., 25 W. 42d St., New York



GIVE IT A TRIAL
The Raymond Brake
Simple—Strong—Sure
ROYAL EQUIPMENT CO.
155 Heusatonic Ave., Bridgeport, Conn.



Let us send you a **DUPLEX COIL** to use on your car 30 days free in place of your present coil. If the Duplex Coil doesn't cure 90% of your engine troubles, send it back collect, and replace your old coil. Write on your business stationery, giving name of car, number of cylinders, and any good reference and we'll send you a Duplex Coil by first express.
Address Station N,
DUPLEX COIL CO., Fond du Lac, Wis.

BULLET-PROOF
Inner Tube Protecting Webbing
3-inch 25c. per yard 4-inch 40c. per yard
WABAN WEBBING CO.
Boston, Mass.

IF you want good circulation on your automobile, launch or motor boat, use a
LOBEE PUMP
LOBEE PUMP AND MACHINERY CO.
130 Terrace Buffalo N. Y.



"UKO" FIFTH YEAR OF PERFECT PERFORMANCE.
SOLID MICA ALL SIZES UNLIMITED GUARANTEE.
BY MAIL UKO 75¢
THE UTILITY CO.
639 W. 44th ST. NEW YORK.



AUTOMOBILE TURNTABLE
Patented December 28, 1905
The easiest running table made. Built strong, and the heaviest cars can be turned with ease.
Price of wood construction: 1) feet, \$175; 12 feet, \$200; and 15 feet, \$250.
Price of steel construction: 10 feet, \$200; 12 feet, \$275; and 15 feet, \$350.
Portland Garage Co., Portland, Me.



PERFECTION SPRING CO.
Manufacturers of HIGH GRADE AUTOMOBILE
SPRINGS. VANADIUM A SPECIALTY.
Write for price list.
2413 Superior Ave., N. W., CLEVELAND, OHIO



AUTOMOBILE RECORD
By SIGMUND KRAUZZ
EXPENSE account for fifty-two weeks, with columns for cost of gasoline, carbide, kerosene, repairs, replacement, daily runs, chauffeur's salary, garage expenses, speed record, starting point, destination, motor laws of thirty-five States and names of others having no laws. Totals expenses and runs for any period shown at a glance.
MOROCCO COVER, ONE DOLLAR
The CLASS JOURNAL COMPANY
231-241 West 39th Street, New York

Auto Pump Oiler
The only pump oiler on the market designed for automobile oiling. Pumps the oil to the bearings in just the quantity desired. Spouts from 3-inch to 9-inch and all interchangeable.
For Sale by All Leading Jobbers
MAPLE CITY MFG. CO.
Monmouth, Ill.

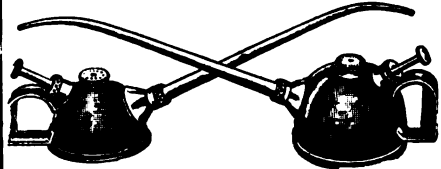

PLEASE MENTION THE AUTOMOBILE WHEN WRITING TO ADVERTISERS

TRIUMPH GAGE
FOR Gasoline Tanks
BOSTON AUTO GAGE CO.
10 Wakham Street BOSTON, MASS.



MILLER GREASE GUN Four-in-one The Standard of the World
Quick operating, Self-filler, Ejector and Cup Filler The gun that always stays, always leads, always improves, always outwears and always outsells all others, is the "MILLER."
No other Gun equals it—bold claim; but there's proof aplenty. Ask your hardware dealer or will mail you a gun on receipt of \$3.00. Orders filled same day received.
MILLER & STARR, 250 Greene St., Brooklyn, N.Y.

THE GAS ENGINE HANDBOOK
By E. W. ROBERTS, M. E.
A VERY useful manual of information about American practice in the construction and operation of stationary gas engines, for the use of the designer and engineer. Very little space is wasted on past history, for the book is of use for to-day. It contains many useful tables and formulas and a number of helpful drawings illustrate the text. Size, 3 1/2 by 5 1/2. Pages, 264.
Flexible Covers One Dollar Fifty
The CLASS JOURNAL COMPANY
231-241 W. 39th Street, New York

E. B. Van Wagner Mfg. Co.
SYRACUSE, N. Y.
Finished Die Moulded CASTINGS
Timer Parts and Bearings Our Specialty
30 years' experience in the Mfg. of Alloys



THE STANDARD GARAGE EQUIPMENT FOR GASOLINE STORAGE
THAT'S THE **BOWSER**
Send for Catalog J
S. F. BOWSER & CO., Inc., Fort Wayne, Ind.
NEW YORK BOSTON CHICAGO TORONTO

"THE CAR THAT CONTINUES TO MAKE GOOD"



ACME MOTOR CAR COMPANY, Reading, Pa.

FRANKLIN Automobiles

On the Franklin Automobiles tires last longer than those on any other automobile.

Weight Is What Wears Out Tires

H. H. FRANKLIN MFG. CO.
Syracuse, N. Y.

PALMER SINGER



PALMER MFG. & SINGER CO.

1620-22-24 Broadway, New York. 1321 Michigan Avenue, Chicago, Ill.



A Paradox - The ADAMS-FARWELL is air cooled and has light valves, but they never warp or need grinding. Get posted.

The Adams Co., Dubuque, Iowa

GEARLESS CARS

\$2750 to \$3250

Write for Catalogue

GEARLESS MOTOR CAR CO.

295 Plymouth Ave., Rochester, N. Y.

REO \$500 and \$1000

Gets-there-and-back, every day in the year, and that's what counts most. Send for catalogue.

R. M. OWEN & CO., Lansing, Mich.

General Sales Agents for the REO Motor Car Co.

J. H. LEHMAN MFG. CO.

170 Broadway, New York

Lehman Distributors and Timers

The "FULMINA" High-Tension MAGNETO

All Types

THE GRAMM-LOGAN MOTOR CAR CO.

BOWLING GREEN, OHIO

Write for Circular describing our several models



Gasoline and Electric - for Pleasure and Business

Studebaker Automobile Co., South Bend, Indiana

This Little Space

is intended to serve as a reminder of **BAKER ELECTRICS**

the electric carriage of distinctive merit and remarkable quality. Made in the largest and best equipped electric automobile factory in the world. Write for Catalogue.

THE BAKER MOTOR VEHICLE CO.
20 80th St., N. W. Cleveland, O.



Assemble your 6 cylinder CAR

Write for circular

HOWARD MOTOR WORKS. Yonkers, N. Y.



Get the \$250 Original Motor Buggy \$400 for 12 H.P. Top \$25 extra. Over 600 in use. Invented by an engineer after 10 years labor in auto work. Speed 4 to 40 miles per hour. 50 to 100 miles on one gallon of gasoline. Will climb steep hills and run in mud and sand. Guaranteed for one year. Write for catalogue, testimonial letters, etc.

Success Auto Buggy Mfg. Co. (Incorporated)
528 De Baliviere Ave., St. Louis, Mo.

THE TRUTH ABOUT THE AUTOMOBILE

And What It Costs to Maintain One

A 64-page booklet containing sworn statements of 158 users of the **SINGLE CYLINDER CADILLAC** showing actual cost of maintaining their cars. It also contains much advice of value to the automobile buyer.

Ask for free copy of Booklet No. 7.

Cadillac Motor Car Company, Detroit, Mich.



The Jack That Doesn't Come Down

It's the XX CENTURY, the jack with a patented reversing lever, which makes it the safest automobile jack on the market.

At your dealer's or write for prices and literature.

Joyce-Cridland Company
Dayton, Ohio
NEW YORK: 136 Liberty Street

AJAX TIRES

Built of high class materials by intelligent workmen in a new factory equipped with modern machinery. A 5,000 mile written guarantee reflects the confidence of the makers in this product.

Write for a Copy

AJAX-GRIEB RUBBER CO.
Gen. Offices, 1778 B'way, N. Y. City. Factories, Trenton, N. J.



The Greatest Value Ever Offered

\$2,250

4 Cylinder 35 H.P. Motor

Cornish-Friedberg Motor Car Co.
1233 Michigan Avenue CHICAGO

The *Locomobile* Co. of America

BRIDGEPORT, CONN.

A. L. A. M.

Continental

READY FLATED TIRES UNIVERSALLY APPROVED BY ALL MOTORISTS.

CONTINENTAL CAOUTCHOUC COMPANY
1788-80 Broadway New York City

Write for information and prices

THE CAR De Luxe

MoonCars

IF YOU HAVE NOT SENT FOR OUR CATALOGUE DESCRIBING OUR WONDERFUL LINE, WRITE ME AT ONCE

MOON MOTOR CAR CO. ST. LOUIS, MO.
Jos. W. Moon, Pres.

DAYTON AIRLESS TIRES

are the kind of tires you have been looking for. No punctures, blowouts or tire trouble of any kind. Look like pneumatics and just as resilient. Send for booklet.

THE DAYTON RUBBER MFG. CO.
1204 KISER ST., DAYTON, OHIO

"PITTSBURGH SIX" FOR 1909

Now Ready

6 Cylinders, 60 Horse Power, Fully Equipped. 4 Models

\$2,750 \$2,500 \$3,000 \$3,250

Send for Catalog

FORT PITT MOTOR MFG. CO.
NEW KENSINGTON, PA.

OLDSMOBILE

You see them wherever you go
They go wherever you see them

OLDS MOTOR WORKS
Lansing, Mich.

MEMBERS A.L.A.M.



Tire Troubles? Use Permanit

Demonstrated before Board of Governors Harrisburg Motor Club with great success.

For particulars write **ADOLPH KARL & CO**
239 Washington St Newark, N. J.

HEALY
RAPID
REMOVABLE
RIM

A perfect rim for practical purposes. Cuts out 95 per cent. tire troubles; permits complete change of tire in 3 minutes; lightest, simplest removable rim. Guaranteed to stand hardest wear. Costs \$60. equipped with extra rim and wrench. Write to-day for booklet.
HEALY LEATHER TIRE CO.
88-90 Gold St., New York

To prevent the substitution of a cheap, inferior material, and to obtain the best made, SPECIFY and DEMAND

Pantasote

FOR TCPS, SLIPCOVERS AND BOATS

THE PANTASOTE CO.
NEW YORK CHICAGO

AUTOLINE The Perfected Lubricating Oil for all types of Automobiles and Motor Boats. "Ask the Garage Man for it." Will not Carbonize or Boot. Manufactured by

WM. C. ROBINSON & SON COMPANY
MAIN OFFICE, BALTIMORE, MD.

BRANCHES: Boston, Mass., Philadelphia, Pa., Pittsburg, Pa., Cincinnati, O., Indianapolis, Ind., Terre Haute, Ind.

STOP YOUR SKIDDING

Use Johnson Tire Chains State size of tire; enclose \$5.00 and we will send you a set, express prepaid

Iver Johnson Co., BOSTON, MASS.

Auto Top
Materials
of Every Description
MANUFACTURED BY
F. S. CARR, 74 Pearl Street, Boston
Send for samples and prices.

WICO Adjustable Spark Plug **\$1.00**
Each



Guaranteed one year,
Witherbee Igniter Co., 1786 B'way, New York



WOODWORTH
Detachable TREAD Adjustable
"Saves More Than Half" the Tire Bill
LEATHER TIRE GOODS CO.
NEWTON UPPER FALLS, MASS.
New York Store, 1662 Broadway

TOPS
AUTOMOBILE
\$14.00 AND UPWARDS
Write for Catalogue and Prices
BUOB & SCHEU 1555 Court Street
Cincinnati, Ohio

THE NIGHTINGALE WHISTLE
NOW SELLS AT THE REDUCED PRICE **\$7.00**

The Nightingale Whistle Manufacturing Company have taken over the American business of the Comptoir d'Innovations pour Automobiles,
1693 BROADWAY, NEW YORK

The New Motz Non-Skid Cushion Tire

Fits Universal and Standard Clincher rims. We furnish a tool for applying. Send for circular J.

The Motz Clincher Tire & Rubber Co.
Akron Ohio

The Oldest Manufacturers of Bow Sockets in the World
THE ASHTABULA BOW SOCKET COMPANY
ASHTABULA, OHIO

AUTOMOBILE PARTS

See our advertisement in last or next issue of THE AUTOMOBILE

F. W. SPACKE MACHINE CO., Indianapolis, Ind.

P S & CO.
RED INNER TUBES
GUARANTEED
PURE PARA RUBBER
PARKER, STEARNS & CO., NEW YORK

Automobile and Vehicle BOWS



THE ABOVE ARE THE DIFFERENT SHAPES WE MAKE
S. N. BROWN & COMPANY, Dayton, O.

AUTO-TOP FABRICS OF EVERY DESCRIPTION

SAMPLES AND PRICES ON REQUEST

L. J. MUTTY CO., Boston

Republic Tires
Republic Rubber Company
Youngstown, Ohio

New York City, 234 W. 58th St.
Boston, 221 Pleasant Street
Philadelphia, 290 N. Broad St.
Chicago, 116 Lake Street
Detroit, 246 Jefferson Ave.
St. Louis, 394 Olive Street
Pittsburg, 136 Sixth St.
Denver, 2721 Stout Street

Seattle, 2419 Broadway
San Francisco, 166 First St.
Cincinnati, 8th and Walnut Sts
Toledo, 2255 Monroe St.
Indianapolis, 208 S. Illinois St.
Cleveland, 1120 Euclid Ave.
Los Angeles, 2046 S. Main St.
Milwaukee, 457 Milwaukee St.

GOODRICH
TIRES

Go farthest "in the long Run"

It's aggravating when your auto won't start
It's dangerous when it won't stop

USE

THERMOID BRAKE LINING

Trenton Rubber Mfg. Co., Trenton, N. J.

Triumph Valve Remover Adjustable Ball Joints



HERE IT IS IN ACTION
No waste of time

Enables you to remove valve key or valve spring with no side strain or bending of valve stem. Price, \$1.00 each. Discounts to manufacturers and jobbers. For sale by supply dealers throughout the United States. If your dealer cannot supply you send us P. O. Order for \$1.00 and the Remover will be sent you postpaid.

Patented April 24, 1908

for throttle and spark levers, connecting carburetor and timer with levers on wheel steer, eliminating all lost motion and giving a more perfect control to these levers at all times Easily and perfectly adjustable. Adjustable stock size, steel, 40c ea. Adjustable stock size, brass 50c ea. Non-adjustable stock size, steel, 20c ea.

PRICE, 40c
Cut shows exact size

Labels: SCREW, SOCKET, BALL, D 5/16 T 18, D 10 T 3/2, PAT. PEND.

For Spark & Throttle Levers

Manufactured by
MECHANICAL & ELECTRICAL MFG. CO. 50 N. Desplaines St., CHICAGO

BUY PANHARD OIL
"THE OIL IN THE CHECKERBOARD CAN"

It's the oil that saves your motor, contains no carbon to carbonize your cylinders, prevents pounding, saves the expense of the repair shop. Only one quality—the best—three grades.

GEORGE A. HAWS
76 Pine Street NEW YORK

HERSCHELL-SPILLMAN MOTORS
AUTOMOBILE and MARINE
 16-18; 24-30; Vertical Four and
 45-55 H. P. Six Cylinder Types
HERSCHELL-SPILLMAN CO.
 North Tonawanda, N. Y.

THE MOSLER
Spit Fire Spark Plugs
Are the Best
 A. R. MOSLER & CO.
 163 West 20th Street - New York City

Quality Counts
 There are many reasons for the popular endorsement of the BROWNELL Gasoline Motors. Ask any user, or write us, and we will tell you all about it.
 4, 6 and 8 Cylinders. 14 to 150 H. P.
F. A. BROWNELL MOTOR COMPANY
 634-666 Lexington Ave., Rochester, N. Y.

CORK INSERTS
 For particulars apply to the
 OWNER and PATENTEE
The NATIONAL BRAKE & CLUTCH CO.,
 16 State St., BOSTON, MASS.

Automobile Wheels and Axles
SALISBURY WHEEL & MFG. CO.
 MANUFACTURERS
 JAMESTOWN, NEW YORK

CULLMAN SPROCKETS

 and Differentials in stock and to order also. Baldwin, Diamond and Whitney Chain. Send for new Catalog.
Cullman Wheel Co.
 1027 Dunning St., Chicago

PARISH & BINGHAM
 PRESSED STEEL
FRAMES ARE STANDARD
 WRITE FOR ESTIMATES
 CLEVELAND, - OHIO

THE PERFECTION WRENCH
 The newest and best wrench made. All steel. Great strength. Instantly adjusted. Easily and quickly operated. Positive grip. Immense time, trouble and temper saver. Indispensable to automobilists. Best "all round" tool ever offered for sale. Must be seen to be appreciated. "You'll want one when you see it."
 For circular address
THE PERFECTION WRENCH CO.,
 Box 426. Port Chester, N. Y.

Automobile Gears

 If in a hurry, wire us
R. D. Nuttall Company
 Pittsburg, Pa.

DROP FORGINGS
 FOR AUTOMOBILE AND MACHINERY MANUFACTURERS

 WE ALSO MANUFACTURE STEAM HAMMER FORGED
HIGH GRADE CRANK SHAFTS
 EITHER ROUGH FORGINGS, OR COMPLETELY MACHINED.
ANDERSON FORGE & MACHINE CO.
 No. 18 STAUBIN AVE.
 DETROIT, MICH.

"THE KING OF NOISE-PRODUCERS"
 THE
SIRENO HORN
 THE SIRENO COMPANY
 89-41 Certlandt Street, New York City

WE ARE EXHIBITING AT THE
GRAND CENTRAL PALACE SHOW
 CALL AND SEE OUR NEW SPECIALTIES
HERZ & CO., 203 Lafayette St. NEW YORK

100 Manufacturers
 Using and Testing
INDESTRUCTIBLE STEEL WHEELS
 O.K. them in every way. Write us for information
INDESTRUCTIBLE STEEL WHEEL CO.
 1224 Michigan Ave. CHICAGO

DIAMOND CHAINS
 drive their cars more miles per dollar cost than any others

 TRADE MARK
DIAMOND CHAIN & MFG CO.
 236 W. Georgia St. INDIANAPOLIS, IND.

Special Drop Forgings in Quantities
 Chrome Nickel and all Special Steels
 Oil Treating and Annealing
 The Canton Drop Forging and Mfg. Co.
 CANTON, O., U.S.A.

PEUGEOT CHAINS
 "STRONGEST IN THE WORLD."
296 BROADWAY, NEW YORK

The Practical Gas Engineer
 WHAT TO DO AND HOW TO DO IT.
 A book of 150 pages, neatly bound in cloth. Sent postpaid for \$1.00. Address
 The Automobile, 231-241 W. 30th Street, New York.

Drive Chains
 —AND—
Sprockets
 of all kinds for
Automobiles

Baldwin Chain & Mfg. Co. Worcester, Mass.

QURIDE
 (REGISTERED)
FILLED GEARS
 ARE SILENT RUNNING
 Let us tell you more about "QURIDE"
Picrome Hide Co., Syracuse, N. Y.

ALUMINUM CASTINGS
 PHOSPHOR BRONZE and BRASS
 FOR AUTOMOBILE WORK
PIONEER BRASS WKS., INDIANAPOLIS, IND.

PRESSED STEEL
OTTO KONIGSLOW MFG. CO.
 CLEVELAND

HALF PRICE

To clean up Surplus Stock

Semi Annual CLEARING SALE

of

Automobile Supplies and Accessories

Send for Flyer No. 18

NEUSTADT AUTOMOBILE & SUPPLY CO.

3054 Olive Street, St. Louis, Mo.

Simplifies the Automobile

Friction-drive does away with the clutch, gears, universal joints, saves power, lessens weight and cost, and gives unlimited speed changes, instantly made without noise or fear of breakage.

ROCKWOOD PAPER FRICTIONS

Are the standard for friction drive. Our treatise, "Friction Transmission," gives valuable facts and formulas for the designer. Sent Free on Request to those who state occupation and firm connected with. Assistance in designing cheerfully furnished.

The Rockwood Mfg. Co.
1917 English Ave. 6
Indianapolis, Ind., U.S.A.

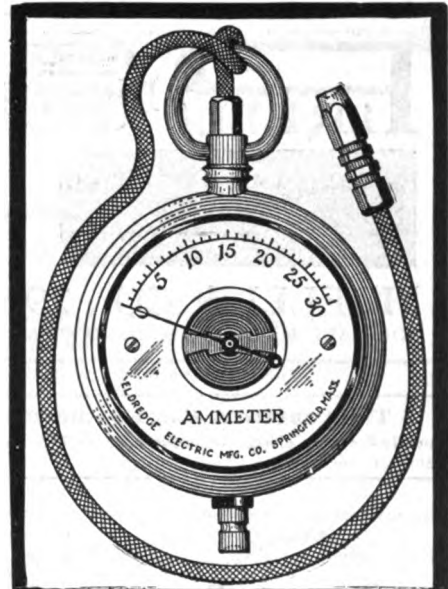

VOLTMETERS

Advance Pocket Volt-Ammeter

0 to 8 Volts and 0 to 30 Amperes

This instrument is jeweled, ensuring greater accuracy and wearing qualities.

It indicates in either direction of current.

The scales, which are quite uniform, are each calibrated individually by hand.



AMMETERS

"EXPRESS" Spark Coil Current Indicator

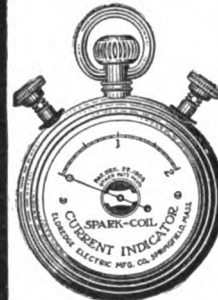

The instrument shown herewith has a standard range of 0-2 amperes in tenths of an ampere; has two connecting posts on case for a double conductor-cord leading to the switch on coil.

ELDREDGE ELECTRIC MFG. CO. SPRINGFIELD, MASS.

Buckeye Automobile JACKS

The Jack for Real Service

STRONG, SAFE AND RELIABLE

Made only by **Buckeye Jack Mfg. Co.**
Louisville, Ohio

M. G. WEST & CO.,
San Francisco, Cal.,
Distributing Agents for the Western Coast.



SAMSON TYPE COURSE RUBBER TUBES

MADE IN FRANCE

KING OF TIRES TIRE OF KINGS

SAMSON LEATHER TIRE CO.,
1634 to 1642 BROADWAY
G. de PONTAC
Gen. Mgr. NEW YORK CITY

STEEL TIRES

Full of Air. Can't Puncture. Steel link bands hook to rim. A few sections will hold any old blowout. The only protector that will hold rim cut.

Cover tires with this armor and they will last forever; how can they get away if encircled by steel?

As flexible as rubber. Anti-Skid. Thousands in use. Tire bills cut in two.

KIMBALL TIRE CASE CO.

171 Broadway, Council Bluffs, Iowa



THE EMERGENCY WHEEL

NOTICE!

Big Reduction in Prices
Write for revised price list

Black Mfg. Co., Ft. Wayne, Ind.

PIRELLI  **CABLE**

Our Cable Card illustrating 11 varieties of cable in actual sizes mailed upon request.

This is No. 254 R, 15 m. m. High-Tension Rubber. Price, 30c. per foot. To avoid ignition trouble, specify PIRELLI wire.

PIRELLI & CO., 296 Broadway, New York
FOR SALE by MOTOR CAR EQUIPMENT CO., 55 Warren Street and 177 Broadway

THE SPENCER POWER AIR PUMP

Inflates Largest Tires in Less Than Two Minutes. The Motor Does the Work

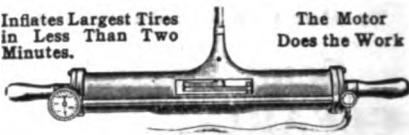

THE AUTO PUMP CO.
Write for Circular. 14 Main St., Springville, N. Y.

DISTRIBUTORS:
S. F. HEATH & CO., 266 Columbus Ave., Boston, Mass.
GEO. W. EDGE, 2024 Olive St., St. Louis, Mo.
AMERICAN AUTOMOBILE CO., 187 Wisconsin St., Milwaukee, Wis.
GEO. P. WELLS, 472 Golden Gate Ave., San Francisco, Cal.
THE AUTO PUMP CO., 101 W. 66th St., N. E. cor. Broadway, New York.

The Practical Gas Engineer. What to Do and How to Do It. A book of 150 pages, neatly bound in cloth. Sent postpaid for \$1. Address Book Department, The Automobile, 231-241 W. 39th St., New York.

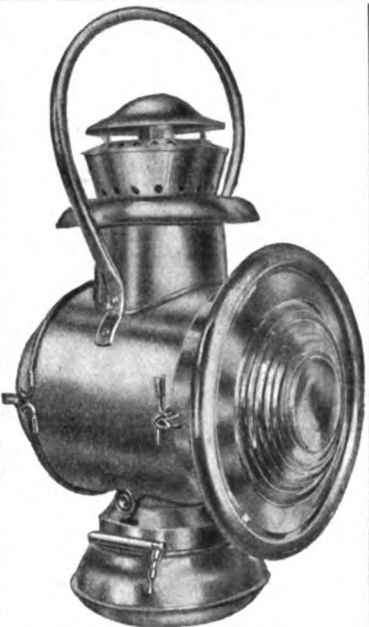

DID YOU SEE US AT THE PALACE SHOW?

We were there and showing the handsomest line of oil-burning Automobile Lamps ever offered to the American public.

We will also exhibit at the Madison Square Garden Show, opening January 16th.

It will pay you to investigate our line before placing your orders. Upon request, we will be very glad to send you one of our handsome new 1909 catalogues. Address "Dept. B."

C. T. HAM MFG. CO.
ROCHESTER, N. Y.

HAM'S TOURIST

THE FRENCH MFG. CO.
132 ROBBINS ST WATERBURY, CONN.
Manufacturers of

SEAMLESS TUBING

Thin Gauges Small Sizes

Brass, Copper, Bronze and White Metal

SPECIALTIES:
Irregular Shapes, Solid Drawn Work and Hydro-Carbon Lighting Tubing

Auto Running Gears

With chain or shaft drive axles, any wheel base and any height of wheels.



Write for our new Catalog.

ALSO ALL KINDS OF BODIES



Borbein Auto Co. 2109 N. 9th St. St. Louis, Mo.

Comfort without Extravagance

Hotel Woodstock
127 West 43rd St., New York.

H. H. Valiquette, Manager.

Rooms, with bath, \$2.50 to \$3.50
Suits, \$5.00 to \$6.00



TIMES BUILDING **TIMES SQUARE** HOTEL WOODSTOCK

McCORD FORCE FEED LUBRICATOR

"The Mark of a Good Motor Car"

RADIATORS : CARBURETERS
McKIM
COPPER : ASBESTOS GASKETS

McCORD MFG. CO.
DETROIT, MICH.
N.Y. Office: Hudson Terminal, 50 Church St.

Equip Your Car With The
New Idea Auto Light



and you will always be able to locate "trouble" without fire danger. Hangs from any part of car desired and can be used for a working light in ANY position. It's a portable electric light plant. Lift bulb off hook and it's lighted to stay lighted until hung up again. Big bulb in master reflector gives brilliant light. Equipped with long elastic bulb cord and perpetual battery, price \$3.00. Order to-day.

THE NEW IDEA SALES CO.
Dept. T. A.
CORNING, N. Y.

1-16 Size.

"Continental Motors Are Standard"

They are made by MOTOR

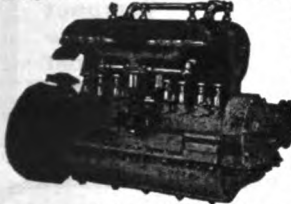

SPECIALISTS in four cylinder types from 24 to 40 Horse Power and are equipped with self-contained oiling system insuring lubrication and are ready for coupling any standard type of magneto.

Increased facilities enable us to guarantee quality and deliveries. Also clutches and transmissions. Send for catalogue.

CONTINENTAL MOTOR MFG. CO.
MUSKEGON, MICH.

K. Franklin Peterson, Western Representative, 166 East Lake Street, Chicago, Ill.
Thos. J. Wetzel, Eastern Representative, 29 West 42d Street, New York, N.Y.

AUTOGAS

SUPPLIES LIGHT TO ANY
AUTOMOBILE LAMP
LASTS FOR MONTHS

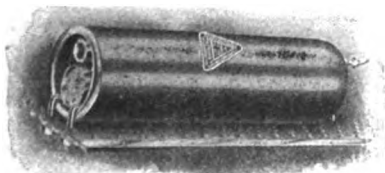

IT GIVES TWICE THE SERVICE OF
ANY OTHER GAS TANK. WRITE US

**Avery Portable Lighting
Company**

MILWAUKEE, WIS.

NEW YORK OFFICE: 243-245 W. 57th St.
CHICAGO BRANCH: 1209 Michigan Ave.

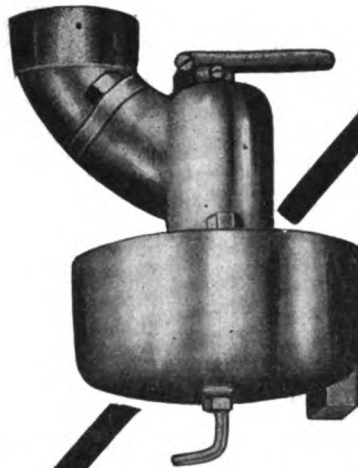

Are you a Doubting Thomas?
Don't you believe there is a
better Carbureter than you
now use, no matter how good
it may be?

We can prove that

"The Duplex"

is superior to any Carbureter
you ever saw or used

Write to Us To-day

An inquiry carries no obligation but will supply you with Facts which, if acted upon, will eliminate all carbureter troubles and make the running of your car better and more economical.

"The Duplex" is adapted to any engine

Constructed on scientific principles incorporating extreme simplicity and highest efficiency.

No springs; no auxiliary valve; no flooding; no leakage; no power restriction; no priming.

Only one adjustment; one throttle; perfect control

A Carbureter that will make your car run better, with more power and greater economy. **TRY IT.**

THE DUPLEX COMPANY

BELFAST, MAINE

Designers, Pattern Makers, Iron, Brass and Bronze Founders, Machinists, and BUILDERS OF
HIGH SPEED MOTOR BOATS.

DEALERS! Write for our Special Discounts



**PAGE-STORMS
DROP FORGE CO.**
INCORPORATED

Chicopee, Mass., U. S. A.

MAKERS OF

DROP FORGINGS

OF ALL DESCRIPTIONS

AUTOMOBILE WORK OUR SPECIALTY

THE above illustration of our new plant conveys some idea of the great area covered; this coupled with the assurance that all available floor space is occupied by the most improved and up-to-date machinery and operated by skilled workmen gives you

A Guarantee of our ability to handle your order promptly and in the most satisfactory manner

Our Forgings are used on the best American built cars and are giving universal satisfaction. We will be pleased to furnish on receipt of blue prints or models full information and prices.



INSIST ON

SPICER UNIVERSAL JOINTS

BEING ON YOUR CAR BEFORE YOU BUY

The Standard for Strength and Durability

Far the BEST joint in the world and used on the BEST Cars

Your Car cannot be The BEST Car without the BEST joints. See that your old car and NEW one is equipped with "SPICER."

Only the very best material is used—Steel drop forgings being used for all parts under stress of Power Transmission. All bearings are hardened and accurately ground, and all parts are interchangeable. Lubrication is practically perfect; joints will outwear the rest of the car.

Send for descriptive circular and full particulars

**SPICER
UNIVERSAL JOINT CO.**
15 Madison Ave.
PLAINFIELD, N. J.

See our exhibit at the Grand Central Palace Show, opening in New York on New Year's Eve.

**Simple Efficient
Dust-proof
Oil-tight
Strong
Compact
Inexpensive
Most Durable**



END YOUR CARBURATION TROUBLES WITH THE PERFECTED KINGSTON CARBURETOR

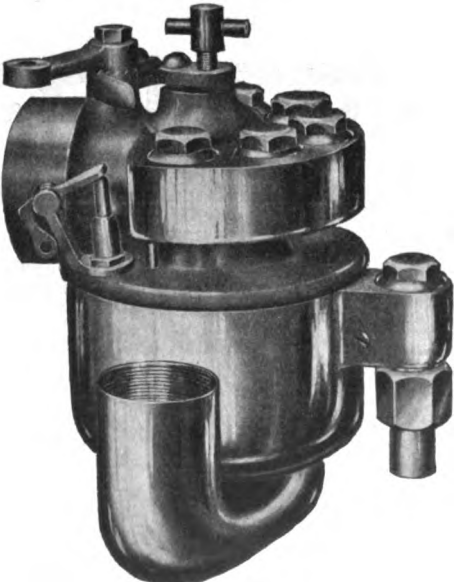

FLOATING BALL TYPE—SINGLE ADJUSTMENT

The latest type of the Kingston Carburetor is a revelation to the user and a source of never ending satisfaction—it is readily adjusted for any motor and once adjusted it is **right for all speeds**—on road or hill—the supplemental air supply inlets absolutely automatic and governed by 5 Ball Valves, each acting independently and called into use as increased power is demanded, takes care of the gas supply increasing or lessening same as needed. If your carburetor is not satisfactory, try a Kingston Floating Ball Type—it will end your carburetor troubles. Vertical or Horizontal Outlets—All Standard Sizes—No Springs—Noiseless.

Write for full descriptive pamphlet

Byrne, Kingston & Co.

SOLE MANUFACTURERS
KOKOMO, INDIANA

OVER 100,000 KINGSTON CARBURETORS IN USE

See Our Exhibits New York: Jan. 16-23, Madison Square Garden, Space 157
Chicago: Feb. 6-13, Coliseum Gallery, Space 78

A PLANT



For the manufacture of speedometers that is unique.

An organization for making and selling that is effective, yet not wasteful.

STEWART SPEEDOMETER

A product that is pre-eminent as regards quality, finish and performance.

A clientele that is the most numerous and most enthusiastic.

Stewart & Clark Mfg. Co.
506 Diversey Boulevard Chicago, Illinois, U. S. A.



MODEL 4—Four-inch, 60-mile dial, enclosed season odometer and automatic resetting trip register and maximum speed hand, price.. **\$40**

Victor wears three times as long as any other device



The tension spring keeps it always snug

COURT REFUSES

to grant injunction applied for by Weed Chain Grip Company to restrain manufacture, use and sale of

VICTOR ANTI-SKIDS

Opinion by Judge Hale, of the United States Circuit Court, District of New Hampshire, dated Oct. 22, 1908.

Long, hard usage has demonstrated that "VICTOR ANTI-SKIDS" are the best in the world. They have smooth, round spring rollers which cannot cut the tire and cannot skid—they wear three times as long as any other—they are always snug on the tire—absolutely silent and cannot rattle or slash the mud guards. All others wear sharp on the edges and out and dig the tire. The revolving "Victor" roller always remains round. THE LATEST IMPROVED "VICTOR ANTI-SKIDS" ARE BETTER THAN EVER. They have defeated all other anti-skids in the fight for commercial supremacy. "VICTOR ANTI-SKIDS" will always win both before the public and before the courts. Manufactured by

VICTOR TIRE TRACTION COMPANY
NASHUA, NEW HAMPSHIRE

Excelsior Supply Co., Western Distributors, Chicago, Ill.

W. J. Connell, New England Sales Agent, Boston, Mass.

"BREECH-BLOCK" PLUG



with improved clip and handle. A perfect sparking device of never-failing dependability. Completely eliminates spark-plug troubles. Perfectly constructed of the best material throughout. Try one—that's the best test. At least get full particulars—write. The Standard Co., Torrington, Conn.

PLEASE MENTION THE AUTOMOBILE WHEN WRITING TO ADVERTISERS

"ISOTTA" | "PENNSYLVANIA"
Milan, Italy | Bryn Mawr, Pa.

Complete Cars

Bodies Repaired, Trimmed and Painted
Chassis Repair Department

J. M. Quinby & Co.
Automobile Body Builders
NEWARK, N. J.

OWNERS WILL GET MAXIMUM COIL EFFICIENCY



HEINZE COILS

WRITE US
If your dealer does not carry them.

HEINZE ELECTRIC CO.
LOWELL, MASS.

Makers of High-Grade
Coils and Electric Ignition Apparatus of Every Kind



Type B. 35 4-Cyl. Interchangeable Unit Spark Coil

Established 1840

DIETZ SQUARE LAMPS
(Kerosene)

"Sterling" and "Sterling Junior"



These Lamps are the handsomest on the market; made of heavy materials. Genuine Diets "Cold Blast" principle; therefore burn well. Finished in Polished Brass.

"STERLING" \$15.00 pr.
"STERLING JUNIOR" \$12.00 pr.
DISCOUNT TO DEALERS

R. E. DIETZ COMPANY
60 Light Street NEW YORK
Pioneers and Leaders

Send for our large motor lamp catalogue

SPRINGFIELD PORTABLE GARAGE

A garage built along the lines of not how cheap, but how good. You always have your car ready for instant use.

Write for full particulars and prices.

SPRINGFIELD PORTABLE HOUSE CO.

58 Waltham Street, SPRINGFIELD, MASS.



**Here's
the
Stuff**

Dixon's Motor Graphite helps compression in cylinders, quiets noise in gears, makes smooth running throughout. Booklet 9 G tells

how to use it. Write for free copy.

JOSEPH DIXON CRUCIBLE CO.

JERSEY CITY, N. J.

SPRINGFIELD JACKS

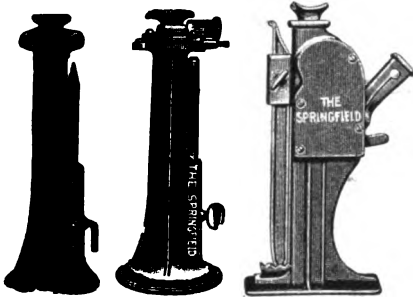

No. 1 \$1.50 No. 2 \$2.00 No. 3 \$4.00

SHAWVER CO., Springfield, O.

The Best
of
EVERYTHING
for
EVERYBODY

That Ever Drives
a Motor Machine

WRITE FOR CATALOGUE 70

EXCELSIOR SUPPLY COMPANY.

Established 1876

233-235-237 Randolph Street
CHICAGO

SERVICE

3 CYLINDERS 30 H. P. 4 " 40 H. P. 6 " 60 H. P.	EWELL NALLE, AGENT FOR THE THOMAS "FLYER," Automobile Touring Car. 601-623 E. SIXTH ST. TELEPHONE 172.	THE AUTOMOBILE OF STYLE AND QUALITY. SIDE ENTRANCE
--	--	--

AUSTIN, TEXAS, August 18th 1908.

Chas. E. Miller,
New York, N. Y.

Dear Sir:-

It affords me much pleasure to write and tell you what fine success I have had using your Brampton Chains on Buick Model "7" cars, which as you know are very hard on driving chains.

After trying almost every known American chain with little success, I tried one of your Brampton chain on a Buick demonstrator, and same has been run over ten thousand miles, and not a broken roller or link has shown up, the chain holding its length no matter how hard the pull, and I have not been required to even lengthen the radius rods, although the car has been through Texas black lands, a foot deep in mud. This chain has been so satisfactory, I have equipped seven Buicks Model "7" cars, and there has not been one complaint as yet, although when my customers had American chains, there was always trouble from broken links and rollers.

I have had such good success on these Buicks cars, I have just started to equip a Thomas Flyer with your Brampton chains, having had more or less trouble with the American side chains which came with the car, but now I have no fear but what my trouble over chains is at an end.

Wishing you the best of success with these Brampton Chains, which are the best made, I remain,

Yours very truly,

THE Brampton Motor Chain

is made of self-hardening Steel; the strongest Chain in the World. All parts polished; fits sprockets (that are properly cut) without friction.
LARGE SALES and SMALL PROFIT with thousands of satisfied customers is our best advertisement.

PRICE

The price being equal, it's presumable you want the best, and full value for your money. In such cases, the BRAMPTON FILLS THE BILL, and the prices are the same to manufacturers, jobbers, dealers and consumers as any other chain of equal size.

We have all sizes in stock to fit American and Foreign Cars. We are the sole American agent for Brampton Chains. Our Large Catalog Mailed on Request.

CHAS. E. MILLER, Manufacturer, Jobber
Exporter and Importer
Home Office 97-99-101 Reade Street, NEW YORK CITY

BRANCHES: New York City, 824 Eighth Ave.; Philadelphia, Pa., 218-220 N. Broad St.; Cleveland, Ohio, 1329 Euclid Ave.; Boston, Mass., 202-204 Columbus Ave.; Detroit, Mich., 227 1/2 and 229 Jefferson Ave.; Buffalo, N. Y., 324 Main St.; Brooklyn, N. Y., 1832 Bedford Ave.

To Know What to Do and How to Do It

When your gasoline motor or gas engine gets stubborn, can be quickly learned by owning a copy of the

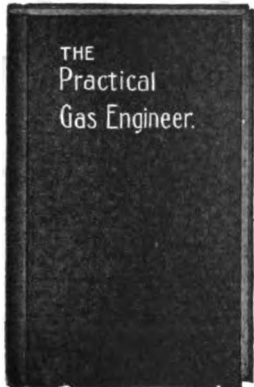

A Book of 172 Pages
Neatly Bound in Cloth
Sent postpaid on
receipt of price, \$1.

Practical Gas Engineer

By E. W. LONGNECKER. Twelve years' constant experience with Hydro-Carbon Engines.

SIXTH EDITION JUST OUT and selling rapidly. First and Second Editions exhausted in thirteen months. Special Chapter on Automobile and Motor Engines

How to start, how to operate, and how to care for all classes of explosive motors or engines using gas, gasoline or similar fuels.

A full and exhaustive chapter on electric and other systems of igniting.

Also chapters covering in a thorough manner troubles and remedies encountered in operating engines in motor vehicles, launches, shops or on the farm.

Every line tells something.
Every page full of interest.

The Class Journal Co.
231-241 W. 39th St. New York

Self-Propelled Vehicles

By JAMES E. HOMANS, A.M.

A practical treatise on the theory, construction, operation, care and management of all forms of automobiles, with upwards of 500 illustrations and diagrams, giving the essential details of construction and many important points on the successful operation of the various types of motor carriages driven by steam, gasoline and electricity. This is probably the best comprehensive treatise published in simple language, so that the contents may be readily understood by the intelligent reader, especially if he has a machine to which he can refer for demonstration of many points discussed. For one who desires to understand automobiles, it is an excellent work to begin with before going deeper into the subject along highly specialized lines.

Size 5 1-2 x 8 1-2. Pages, 652
With Drawings and Half-Tones
Cloth bound \$2.00

The Class Journal Co.
231-241 W. 39th St., New York

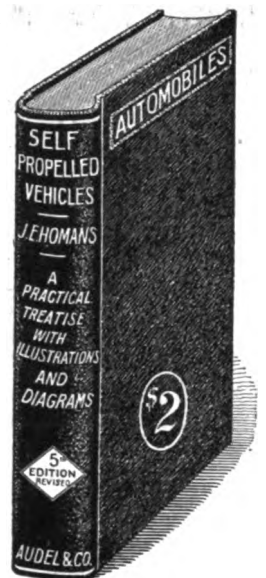

Automobile Catechism

For the Use of Owners and Drivers of Cars Fitted with Internal Combustion Motors

By

FORREST R. JONES, M.E.

President of the Manhattan Automobile School

Size, 4 1/2 x 7 inches. Pages, 134.
With Drawings.

Price, in genuine Morocco Cover, gilt edges, \$2.00, including postage.

Order from the publishers

The Class Journal Co.
231-241 W. 39th St., New York

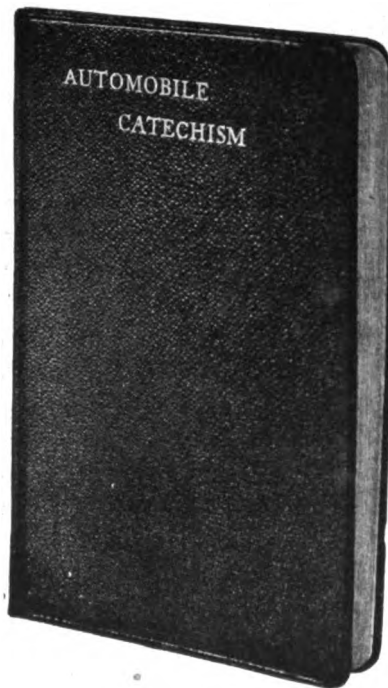

The Automobile Catechism is the most practical, up-to-date work on the subject in the English language. It is published in pocketbook form, with high-grade leather cover, and printed on especially tough paper, as it is intended to be the inseparable companion of the autoist when on tour. Not a line is wasted on obsolete constructions or descriptions of unfamiliar apparatus. It treats of the automobile in modern form and of all the troubles that may arise in the course of ordinary use and that may be remedied by the driver himself. It is written in plain language and is the most helpful, authoritative, and comprehensive manual that has yet appeared. The subject matter is in the form of question and answer, and an exhaustive cross index makes immediate reference possible in any particular case.

Gas Engine Manual

This volume just published gives the latest and most helpful information respecting the construction, care, and management of Gas, Gasoline, and Oil Engines, Marine Motors and Automobile Engines, including chapters on Producer Gas Plants and the Alcohol Motor.

Each chapter is illustrated by diagrams which make it a thoroughly helpful volume, containing 512 pages, 156 drawings, printed in large clear type on fine paper, handsomely bound in rich red cloth, with gold top and title, measuring 5 1-2 x 8 1-2 inches and weighing over two pounds.

The book is a practical educator from cover to cover and is worth many times the price to any one using a gas engine of any type or size. Price, \$2.00 Postpaid.

Send all orders to

The Class Journal Co.
231-241 W. 39th St. New York

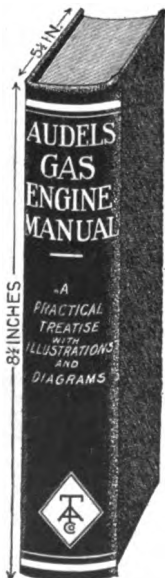

**The Automobile Business in all its Phases
Krausz's ABC of Motoring**

Presenting the information in a fascinating, concise, and comprehensive manner. Different types of automobiles lucidly described, the anatomy of the gasoline mechanism clearly explained, and chapters on the care of the automobile, the art of driving, automobile etiquette, and troubles of the road, etc., etc. Instructive, Convenient, Reliable, Racing Statistics, Rules of Associations, Frontier Regulations, Speed Tables, Automobile Laws of the States, and numerous other matters important to the autoist.

Preface by the President of the American Automobile Association. The endorsement by Mr. John Parson is a guarantee that the work is up-to-date and of practical value to all automobilists.

Leather Binding, \$2.00

Send all orders to

The Class Journal Co.
231-241 W. 39th St. New York



"CAR COMING!"



We will NOT Exhibit at the Shows

We will NOT Exhibit at the Shows

"In building the Velie Automobiles, we have sought to employ the same correct, modern and economical methods of manufacture that have brought so prominently into good repute the vehicle of the same name."

VELIE MOTOR VEHICLE CO.

CHICAGO BRANCH
1615-17 Michigan Ave.

MOLINE, ILL.

\$1750

F. O. B. MOLINE

Equipped with Magneto, Speedometer, Glass Front, 5 Lamps, Generator, Jack and Tools. Guaranteed.

\$1750

F. O. B. MOLINE

The "VELIE 30" has a 30 H. P. Motor, Selective Type Transmission, Floating Type of Axle, 110-inch Wheel Base, Touring Car, Baby Tonneau and Roadster.

AGENTS THERE ARE REASONS WHY THIS AGENCY IS VALUABLE TO YOU. WRITE FOR REASONS AND DETAILS

VELIE MOTOR VEHICLE CO.

1615-17 Michigan Avenue

FACTORY: MOLINE, ILL.

CHICAGO, ILL.



Patent applied for
Cut shows Pump attached to frame with wheel locked against motor flywheel.

EBERMAN AUTO-POWER TIRE PUMP

The Engine Does the Work
Happy New Year

At least 75 per cent. of Auto owners spend much more on the upkeep of their tires than they should, because they find it too hard work to inflate them to proper pressure with the ordinary methods. An Eberman pump makes this easy.

See last week's and next week's ads for further points.

Model A, \$15 Model B, \$20
EBERMAN AUTO APPLIANCE CO. (Not Inc.)
HARRY H. REYNOLDS, *Manufacturer's Sales Agent*
1205 Monadnock Block, Chicago
Eastern Sales Agents: Stevens & Britton, 1773 Broadway, N.Y.

SIMPLICITY RECTIFIER

for charging ignition batteries from an alternating current.



Durable	Simple
Compact	Safe
Efficient	Fireproof

THE AUTO & SUPPLY MFG. CO.
2248 Woodhill Rd., Cleveland, Ohio.

The Practical Gas Engineer

What It Is and How To Do It. A book of 150 pages neatly bound in cloth. Sent postpaid for \$1. Address Book Department, The Automobile, 231-241 W. 39th St., New York.

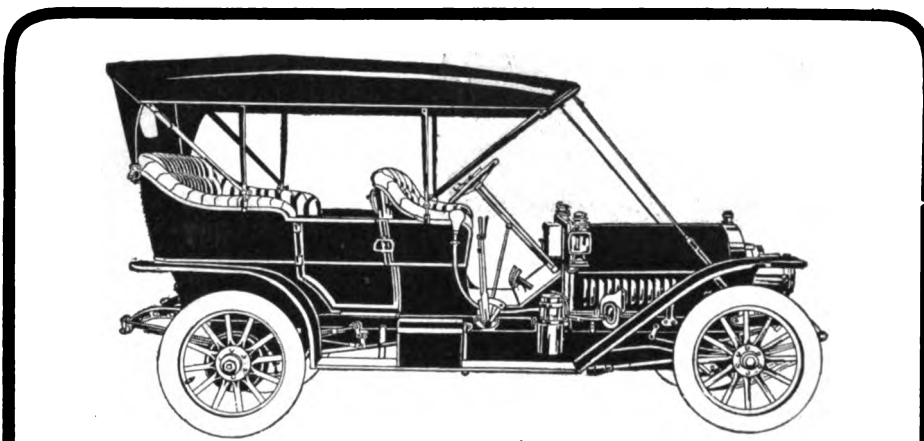

TRADE MARK
STITCH-IN-TIME VULCANIZER CO.
ANYBODY CAN USE ONE

Electric, Gas or Gasoline Heated.

Mend your own casings and inner tubes with our Vulcanizers.

Booklet on tires and tire repairing for the asking. Let us tell you how to do it. Sold on Guarantee.

TOPEKA KANSAS
UNITED STATES

The 1909 Speedwell

This car, produced after eight years of experimenting and thoroughly tested during the past two years of service, has been pronounced the *finest* car that money and skill can produce, no matter what the selling price may be.

A 40 horse power car today and five years from today—good for a mile a minute. A wonderful hill climber.

Many cars selling up to \$4,000 do not equal it. No *other* car excels it. The Speedwell represents the highest development of automobile construction and is sold at the highest price that anyone should pay for *any* car.

It sells at \$2,500 completely equipped, excepting top

A beautifully printed folder describing the remarkable features of this very remarkable car will be sent upon request. It will pay you to secure a copy of this folder before placing your order for **any** car, as it contains facts that will surprise you.

The Speedwell Motor Car Co., Dayton, Ohio

New York Office: 2002 Broadway, at 68th Street
Chicago Office: - - 1355 Michigan Avenue



CORCORAN

CINCINNATI, OHIO.

No. 22

Auto Lamps of all Descriptions

We Lead in
Quality, Style and Finish



1909 Catalogue Ready

Gas, Oil & Elec. Lamps
EDMUNDS & JONES
MFG. CO.
Detroit, Mich.

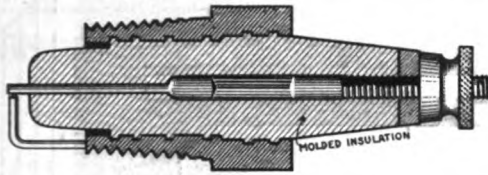

Something New—Distinctly Better than Any you've ever see before.
THE "SCHENECTADY" SPARK PLUG With Indestructible INSULATION
 As you know the whole value of a spark plug lies in its insulation. The "Schenectady" is perfectly insulated with a moulded compound that will not break under high voltage, nor has any of the faults of Porcelain or Mica. Is not affected by sudden changes of temperature; will not crack, break, absorb oil or dampness and is so designed that the explosion keeps it clean and free from soot. Price \$1.25. Examine it—you'll be interested. Write for one to-day.
SCHENECTADY SPARK PLUG CO., No. 1259 State Street, Schenectady, New York
 LIBERAL DISCOUNTS TO DEALERS



NARROW JAW WRENCH "TRIMO SPECIAL"
 INVALUABLE FOR "AUTO KITS"
 THIS WRENCH is designed for close work. Insertible, interchangeable jaws prolong life of this wrench indefinitely. The jaws are narrowed materially, and can be used in close-quarter places. Made in 10-inch only.
 It is light in weight, and particularly designed for Automobile use. No Auto outfit complete without this tool. Write for Catalog No. 70.
TRIMONT MANUFACTURING COMPANY, Roxbury, Mass.

"K. C."
"Kitsee Changeable"
DRY STORAGE BATTERY
 WOULD A SPARKING BATTERY WITH
A LIFE GUARANTEE
 INTEREST YOU?
 Would you like a battery that you could exchange when discharged for a fully charged battery with any dealer, regardless of where purchased, by paying 35 Cents per Cell and without the annoyance of delay? Then ask your dealer about it or write us.
SEE OUR EXHIBIT
At MADISON SQUARE SHOW
 JAN. 16-23, 1909
 EBEN L. BEVAN, Gen'l Sales Agent
KITSEE STORAGE BATTERY CO.
 629 Connell Bldg SCRANTON, PA.

THE POWERFUL
Grout

Is there any good reason why you should spend \$5,000 for a car when you can get the "Grout" for \$2,500? Of course it's your money you're spending and it's your right to pass it out as you choose; only it seems singular for a man to put up \$5,000 for what he can get for \$2,500.

THOUSANDS
 Who bought cheap plugs are coming back to
NEVER-MISS No. 8
 Why not buy THEM first?
A YEAR'S WEAR FOR ONE DOLLAR
 Seven years' of knowing how, with the largest and best equipped factory in the country has made Never-Miss No. 8 THE PLUG.
No. 8 Mica Plug \$1.50
 Your Jobber or Dealer
NOW
 Prepaid for One Dollar Any Size
Never - Miss Spark Plug Company
 Lansing - Michigan

"THE GROUT" is the greatest proposition in cars that there is. "THE GROUT" has had design and construction with the end to satisfying very particular people; people who are exacting investigators; people who expect full measure in return for their expenditures and who are not satisfied to take less; people who feel that it is a waste of money to pay double price for some fancied value in a name plate.

"THE GROUT" has every efficiency, every reliability, is just as handsome, just as powerful, just as speedy, just as everything appertaining to a car costing twice as much. So where is the wisdom in spending twice as much?

Here and there in the United States are chances for local agents to handle the "GROUT" Car. Such agents, judging from those already at work, should do a fine business. Better get next to the "GROUT" 1909 proposition—better do it right away—to-day is none too soon.

Grout Automobile Co., Orange, Mass.

AGENTS
 CHICAGO, ILL.—H. E. Halbert, 437 Douglass Blvd.
 PHILA. BRANCH—1521 Spring St., Phila., Pa.
 NEWARK, N. J.—P. H. Johnston, 267 Halsey St.
 BOSTON, MASS.—H. F. Farrow, 94 Mass. Ave.
 NEW HAVEN, CONN.—J. A. Petrie.
 ATLANTA, GA.—J. Aldredge, 60 Peachtree St.
 PROVIDENCE, R. I.—Etna Bottle & Stopper Co., 34 Peck St.
 PATTON, PA.—Cole Bros.
 PATERSON, N. J.—Brown & Schmidt, 203 Paterson St.
 GLEN COVE, L. I.—H. K. Dodge.

THE AUTOMOBILE TRADE DIRECTORY

PUBLISHED QUARTERLY
231-241 WEST 39th STREET
NEW YORK

JANUARY, 1909

SUBSCRIPTION PRICE
\$5.00 PER YEAR
\$1.50 PER COPY

¶ This is the one and only recognized Directory of the American Automobile industry. From 1903, when it entered the field as a 32-page pamphlet, up to the issue of October, 1908, containing 466 pages, this publication has kept abreast of the rapidly-growing industry it represents, and is the only absolutely complete and covering work of its kind.

¶ Its foundation was built on solid business principles, and it has since been conducted along those lines. Years of steady and constant growth tell their own story of progress.

¶ It has been, and is now, imitated and copied, showing beyond question its substantial and solid worth.

¶ The advertising pages of The Directory offer an exceptional opportunity for the manufacturers of automobile parts and accessories who want to keep in touch with the whole vast field covered by this publication—a field made up of those who recommend, specify and buy.

¶ January issue is now in preparation.

¶ Rates for advertising space and full information regarding Mailing List service sent on request.

THE AUTOMOBILE TRADE DIRECTORY

231-241 West 39th Street
NEW YORK

E. Flentje's Improved Glycerine Hydraulic Jounce and Recoil Preventer
for Automobiles
 Patented Sept. 29, 1908

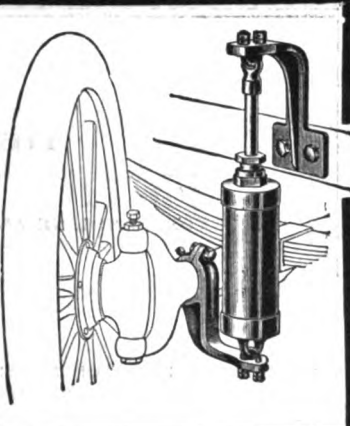

Best in the world when patented. \$2,000 against \$1,000 to any shock absorber manufacturer who can disprove my statement. To show my confidence in my invention, 60 days on trial and one year guarantee.

For catalogue, testimonials and full particulars of the merits of my device, please send to

ERNST FLENTJE
 1643 Cambridge St., Cambridge, Mass.

Northway Motors are Powerful and Silent

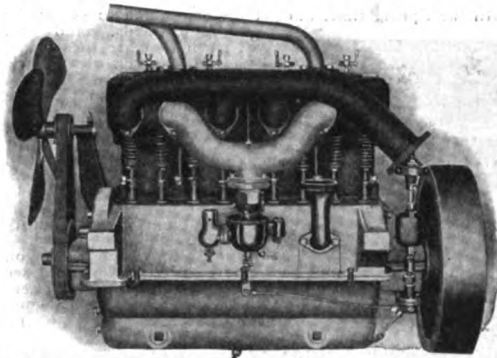

They include integral oiling system, fan, timer, carbureter, magneto provision. In three sizes, 20-25-32 H. P.

Write for Bulletin.

Northway Motor & Mfg. Co., Detroit, Mich.

"Long-Arm" Transmissions

Three speeds and reverse, selective types. The best of material and workmanship. Our experience in gear cutting and manufacturing Automobile Parts enables us to equal the best transmissions built. Let us figure on your requirements. We also build a complete line of Axles, Clutches, Steering Reaches, Hand Levers, etc.

The "Long-Arm" System Co., Cleveland, O.

Sales Department:
 The American Distributing Co., American Trust Bldg., Cleveland, O.

Raybestos

A FRICTION FACING FOR AUTOMOBILE BRAKES AND CLUTCHES

Raybestos is heat proof, oil proof, water proof, weather proof (almost) wear proof.

Raybestos is absolutely the only lining on the market creating friction greater than metal to metal and making sure a quick and easy stop on the steepest grade.

ROYAL EQUIPMENT CO. - 155 Housatonic Ave., BRIDGEPORT, CONN.

Induction Coils

Give easily understood explanations of the operation of coils. Of great value to the autoist. By H. S. NORRIE, 265 pages. Numerous illustrations Cloth bound. Price, \$1.00. Address The Automobile, 231-241 West 39th Street, New York.

DOW TUBES

The Best Tubes Ever Manufactured
 Are the Most Economical. Do Not Deflate When Punctured.

DOW TIRE COMPANY,
 2000 Broadway, N. Y. 889 Boylston St., Boston, Mass.

If a manufacturer will spend \$25,000.00 to build a racing car, he will certainly get the BEST oil irrespective of price. The first three cars to finish in the Vanderbilt Cup Race, and the first five cars to finish in the Grand Prize Race used

MONOGRAM OIL

and the fact that they came in winners proved that it is

THE BEST

Manufactured Solely By
The COLUMBIA LUBRICANTS COMPANY of New York
 116 BROAD STREET MONOGRAM OIL is sold at all garages

LIGHT YOUR AUTOMOBILE BY ELECTRICITY

THE GREAT WHITE LIGHT MAKES DAYLIGHT AT NIGHT

Willard Storage Batteries AND Tungsten Lamps

THE WILLARD STORAGE BATTERY COMPANY
 CLEVELAND, OHIO

The REGAL



The Regal at \$1,250 has solved that eternal question of quality and price. The machine is free from any freakish ideas. It is simply a high-grade, honest car, sold at an honest price. They are built entirely from our own design and constructed in our own factory. Not thrown together from stock parts. A year ago our competitors said a car like the Regal could not be built to sell for less than \$2,000.00. We proved it could and now others are trying to do it. We lead, others follow.

Mr. Dealer: We have some unoccupied territory. Get our proposition before it is too late.

30 H. P., 4-cylinder, water-cooled, shaft drive, 3 speeds and reverse, selective type sliding gear transmission.

Runabouts Tourabouts Touring Cars
REGAL MOTOR CAR COMPANY, - DETROIT, MICH.

Packard Ignition Cable

Finest Rubber Insulation protected by whip cord braids and an elastic enamel coating. Every foot tested to twenty times required voltage by our patented process

HEAT, OIL, GREASE AND WATERPROOF

THE PACKARD ELECTRIC COMPANY, 302 Dana Avenue, Warren, Ohio

WESTON ELECTRICAL INSTRUMENT CO.

Electrical Measuring Instruments

FOR USE IN

Electrical Carriages and in Charging Stations

Send for Catalogue

Main Office and Works, Waverly Park, Newark, N. J.
New York Office, 74 Cortlandt Street

London Branch: Audrey House, Ely Place, Holborn.
Paris, France: E. H. Cadiot, 12 Rue St. Georges.
Berlin: European Weston Electrical Instrument Co., Ritterstrasse, No. 88.

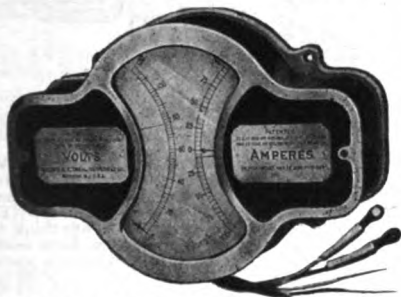

Combination Volt and Ammeter Model 36



Switchboard Instrument Model 150

"The SYRACUSE" Special Auto and Boat Chemical Fire Extinguisher



Not Necessary to Remove Bottle from Bottle Holder when Recharging. Saves Time. No Danger of Burning Hands with Acid. Both Very IMPORTANT FEATURES in the Construction of a Chemical Fire Extinguisher.

will extinguish gasoline (or any other) fire instantly. The ONLY chemical hand extinguisher which is specially designed and practical for use aboard the auto or yacht. "The Syracuse" is not affected by heavy seas. Rough Roads have no effect on "The Syracuse."

Expensive fire insurance will not save life and property.—"The Syracuse" will do both at small expense.

It is absolutely certain to operate every time.

Write for full information and prices and special discounts to dealers.

The SYRACUSE CHEMICAL FIRE EXTINGUISHER CO.
Sole Manufacturers.

Factory and General Offices:
100 West Fayette St., Syracuse, N. Y., U.S.A.



Special Auto and Yacht Extinguisher with Adjustable Holder

The HYDRO-PNEUMATIC SPRING is THE THING

Just Stop and Think

Will smooth down the roughest roads

Our Springs in connection with solid tires will make your car ride easier than with pneumatics, and consequently save all tire troubles and expenses, and eliminate all dangers connected with pneumatics. Guaranteed air tight forever.

For full information ask for booklets A and B

TROJAN HYDRO-PNEUMATIC WHEEL CO. (Inc)
WATERVLIET, NEW YORK



Don't Guess Which Tire Is Best— Here Is Proof

In New York City there are 1,000 Taxicabs.

On the tires, more than on any other one thing, depends the profit of the Taxicab business.

You may be sure that the owners of the 1,000 Taxicabs did not GUESS.

They TRIED all the tires that were offered, and checked them up with the TAXIMETER—which told them the mileage unerringly, indisputably.

There was no personal preference. No friendship. No prejudice. It was a cold-blooded BUSINESS test.

And the result: 800 out of the 1,000 Taxicabs in New York, operated by several competing owners, have contracted for Goodyear Tires to be used EXCLUSIVELY.

GOOD YEAR



To understand why the Goodyear Tire stood head and shoulders above its competitors in this Taxicab test, you must understand, first, the difference between a moulded tire and a wrapped tread tire.

The moulded tire is built up, layer by layer, on an iron core. Over it is clamped an iron mould. When the heat of the curing process is applied, that rubber expands—and in expanding, forces a perfect union between the various layers of rubber and of fabric.

With the moulded tire, so far so good.

But in building up that tire on its iron core a skilled workman lays fabric on fabric, rubber on rubber.

Yet, skilled as he may be, he cannot wholly avoid wrinkles, irregularities, unevenness, which, under the pressure of curing, multiply themselves into hidden weaknesses and defects.

Some tires, instead of being cured on an iron core, are cured on an air bag, which is really an extra strong inner tube.

When the air bag has been inserted in the built-up tire, strong tape is wound around it, and then it is cured in live steam.

The advantage of the wrapped tread process is that the air bag, full of compressed air, smoothes out these wrinkles and irregularities and prevents those hidden weaknesses and defects.

The advantage of the wrapped tread process is, for this reason, immeasurable.

But the tire made by this process does not get the terrific squeeze that the moulded tire gets when the heat expands it between core and mould—the squeeze that forces the rubber into the fabric, making a perfect union between fabric and rubber.

In losing that squeeze, it loses durability, strength, unity—which more than offsets the fact that the wrapped tread tire can have no hidden wrinkles or unevenness.

Obviously, the tire you ought to have is the one which is built up on an iron core, squeezed the same as a

moulded tire—and finished on an air bag to smooth out the irregularities.

There is just one tire made in this way—only one. It is the Goodyear Quick Detachable.

This one point of superiority is reason enough why the Goodyear Quick Detachable should have won the Taxicab test.

But there are other reasons—other superiorities.

The Goodyear Quick Detachable is, for example, an oversize tire.

The Goodyear tire is made larger than the specifications call for. It is simply 15% larger than any other tire marked the same size.

Among the countless other Goodyear superiorities is the patent rubber-rivet breaker-strip, which makes it impossible for the tread to split or peel from the carcass of the tire.

Goodyear superiorities extend from the raw materials to the workmanship—from scores of exclusive Goodyear processes to the Goodyear piano-wire tape which would hold the tire on the rim, even if both the detachable flanges were off.

When you think of tires, think of that Taxicab test.

Those 800 Taxicabs in New York are doing 50,000,000 tire miles a year! More than 1,000,000 tire miles a week!

And what is true of the Taxicabs of New York is equally true of practically every large Eastern city where Taxicabs are used.

Eight out of every ten of them are using Goodyear tires exclusively.

Think of that, you who have bought tires because you have heard of their use on some tour or some race!

Think of that, you who blindly groped at the tire problem—you who have bought tires wholly by hearsay!

Isn't the tire that the Taxicab took—Isn't that the tire for you?

A hundred times more about tires than can be explained here, can be found in our book, "How to Select an Auto Tire."

Send for it now. It is free.

The Goodyear Tire & Rubber Co., Freedom St., Akron, O.

THE GOODYEAR TIRE & RUBBER CO., Freedom St., Akron, O.

I want to know more about tires. Send on your free book, "How to Select an Auto Tire."

Name _____

Address _____

THOMAS SHOCK ABSORBERS PREVENT SPRINGS BREAKING

MAKE US

PROVE IT

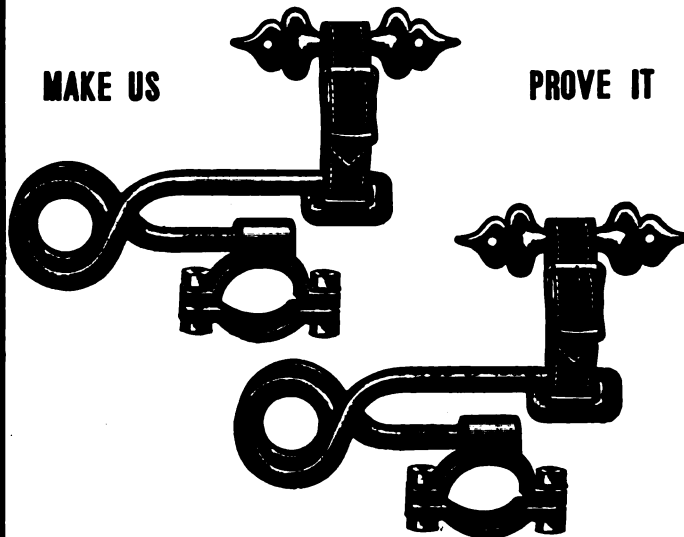

You don't have to BUY Thomas Shock Absorbers to TRY them. We will send them to you to use for 30 days, at our expense. If at the end of that period you do not believe that they positively eliminate upthrow, thus ensuring easier riding—more speed—less wear on tires—NO BROKEN SPRINGS and fewer repairs, just send them back. Could anything be fairer? Can we make our guarantee stronger? Remember you have nothing to lose—everything to gain. Send for full particulars—they are worth real money to you.

BUFFALO SPECIALTY CO., 370 Ellicott Street, Buffalo, N. Y.



TYPE "C" FIFTY

Unchanged—is a model universally endorsed and effectively proved by its consistent winnings in all racing events for endurance, hill climbing and speed, during 1908.

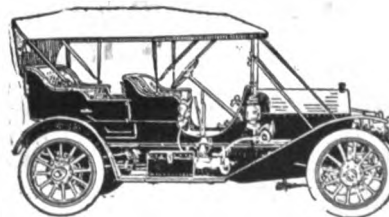

TOURING CAR OR BABY TONNEAU

\$3000

Bosch Magneto and Gas Tank

Pennsylvania Auto Motor Company

Bryn Mawr, Penna.

GET ALL THAT'S COMING TO YOU

When you buy your new car this year. Insist on getting a "Break Circuit Auto-Lock" as part of the regular equipment, to protect your car from theft. If they don't furnish you with one, the stolen car will be your loss, not theirs.

MEET US AT NEW YORK AUTOMOBILE SHOW IN THE GRAND CENTRAL PALACE, Dec. 31 to Jan. 8th, and we will tell you all about it. Will be glad to entertain you.

THE SAFETY DEVICE CO.

INDIANAPOLIS,

U. S. A.

PRICE AUTO GLOVES

Embody remarkable features of convenience. Even when closed, the cuff is wider than on ordinary auto gloves, and when unclasped the folding gore allows sufficient width to readily admit the most bulky overcoat; it then snaps down tight and close. The automatic solid leather snap-strap at the wrist insures a snug, comfortable fit. On request, we will be glad to send our catalog showing the complete line.

HENRY W. PRICE CO.
Dept. 25 ROCKFORD, ILL.

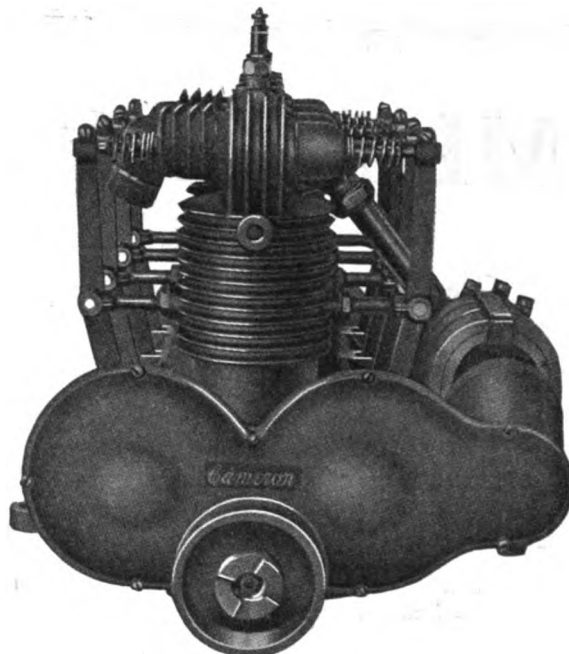

The CAMERON 4-Cylinder Motor

This motor is more efficient under every condition than any motor of its size in the world. Have you ever seen a cleaner, simpler, more business-like looking automobile engine? The best of it is, it's just as good as it looks. It carries its load 25 to 35 miles per gallon of gasoline and 40 to 50 miles per pint of lubricating oil, depending upon the gear ratio of the model in which it is used.

Model 14—4 cyl., 20-24 h. p. Runabout	\$900
Model 14—4 cyl., 20-24 h. p. Roadster (3 pass.).....	950
Model 15—4 cyl., 20-24 h. p. Featherweight Flyer (2 pass.)..	1,000
Model 16—4 cyl., 20-24 h. p. Baby Tonneau (5 pass.).....	1,100
Model 16—4 cyl., 20-24 h. p. Roadster (4 pass.).....	1,050
Model 11—6 cyl., 30-36 h. p. Touring Car or Roadster.....	1,500

Equipment of all models includes 5 lamps, horn, tools and Remy High-Tension Magneto.

The oiling system used on all our motors is worthy of particular attention. Constant fixed level is automatically maintained in engine base by means of a gear pump. The system requires no attention whatever other than keeping supply tank filled.

The Cameron patented direct drive, three speed transmission is as far ahead of the regular planetary or sliding gear types as our motor is ahead of the "water boilers." Details of the system can be easily appreciated by referring to the cut. Our cars abound in refinements of every description, many of which are far in advance of present general practice.

There are no more better balanced, economical cars in the world than you will find in the 1909 Cameron line.

Send for complete specifications.

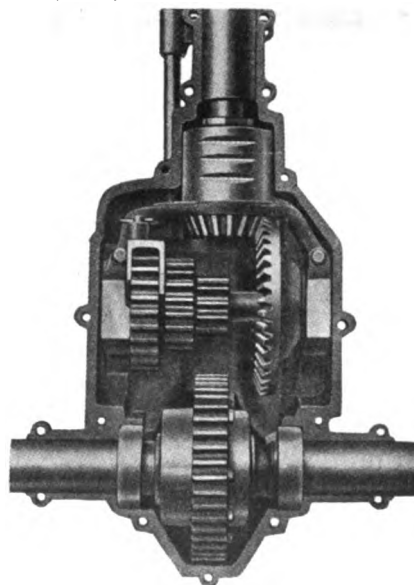

CAMERON MOTOR COMPANY

Works: (SELLING AGENTS)
BEVERLY, MASS. 231 West 54th Street, NEW YORK CITY
NEW LONDON, CONN.

If you want an establishment which will handle your engraving promptly and furnish you cuts that will add 100 per cent to the selling quality and pulling power of your printed matter, send your orders to the

MOSS PHOTO-ENGRAVING COMPANY

295-309 LAFAYETTE ST.,
Cor Houston "Puck" Bldg.
NEW YORK

Engravings of every kind either in colors or black and white; as perfect cuts as can be produced for letter-press printing.

MICHELIN

First, as usual, at the
Grand Central Palace Show

MICHELIN

Tires on show cars

260

Nearest competitor 120

And more than the two nearest
competitors combined

WHY?

Michelin Tire Co.
Milltown, New Jersey, U.S. A.

BRANCHES:

- NEW YORK, 1763 Broadway
- CHICAGO, 1344 Michigan Ave.
- BOSTON, 95 Boylston St.
- BUFFALO, 908 Main St.
- PHILADELPHIA, 320 N. Broad St.
- DETROIT, 247 Jefferson Ave.
- CLEVELAND, 2001 Euclid Ave.
- DENVER, 15 E. Colfax Ave.
- LOS ANGELES, 1200 So. Main St.
- SAN FRANCISCO, 308-314 Van Ness Ave.

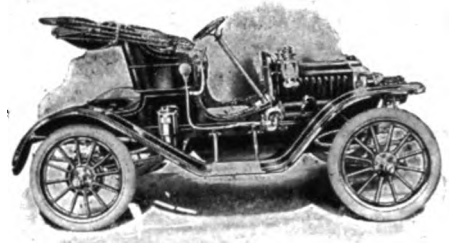

The Aristocrat of Runabouts. Model LD., 2 cyl. 14 H. P.

**Twelve thousand
Maxwell Owners
Prove our Claims
that**

“Maxwell”

automobiles, though moderate
in price, are made of as
good material, with as careful
workmanship under as rigid
inspection, and are as durable
as *should be* the best high-
priced cars.

**Perfectly Simple
Simply Perfect**

1909—The Maxwell Line—1909

4 Cyl. 30 H. P. Touring Car	- - - - -	\$1,750
4 Cyl. 30 H. P. Gentleman's Roadster	- - - - -	1,750
2 Cyl. 20 H. P. Touring Car	- - - - -	1,450
2 Cyl. 20 H. P. Roadster	- - - - -	1,350
2 Cyl. 14. Tourabout	- - - - -	825
2 Cyl. 10, Maxwell Junior-	- - - - -	500
4 Cyl. 30 H. P. Touring Car, Model DA.,		\$1,750.

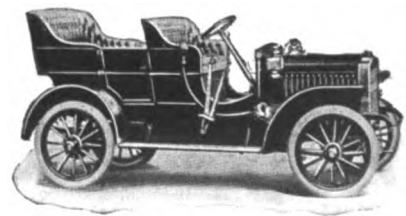

Maxwell-Briscoe Motor Co.

P. O. Box 10, Tarrytown, N. Y.
Main Office and Factory

PAWTUCKET, R. I.

NEW CASTLE, IND.

WE CAN PROVE YOU NEED A SET OF SHOCK ABSORBERS
—Then, of course, it will be the
TRUFFAULT-HARTFORD

"The Standard of the World"

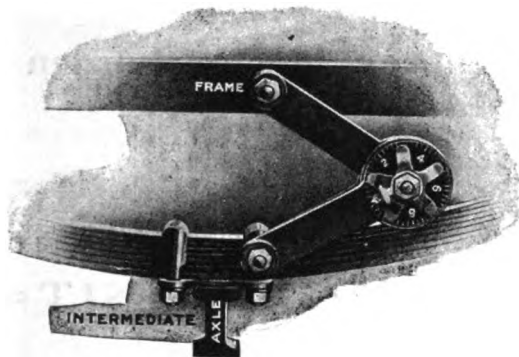

Automatically Lubricated, They Require No Attention

EVERY great speed contest, both in America and Europe, has been won by cars equipped with Truffault-Hartford Shock Absorbers.

For touring, they are a necessity—prevent the breaking of springs, prolong the life of tires and save YOU from the jars of rough roads.

Over twenty Automobile Manufacturers use them as standard equipment. Why? Because they know that their cars will give better satisfaction—ride more comfortably. That's the best proof we know that you need them too.

Order a set now—make your winter motoring a pleasure. A postal will bring full particulars. State make, model and year of car and let us advise you.

STANDARD, for cars over 1,800 lbs. (per set of four) . . . \$60.00
 INTERMEDIATE, for cars of 1,200-1,800 (per set of four) . . . 40.00
 JUNIOR, for smaller cars and Runabouts, weighing up to 1,200 lbs. (per set of four) 25.00

HARTFORD SUSPENSION COMPANY
 140 Bay Street, Jersey City, N. J.

Branches: NEW YORK, 212-214 W. 88th Street
 BOSTON, 319 Columbus Avenue

"It's nice to know how far you go;
 And this will show the speed,—also."

Veeder
TACHODOMETER

THE SCIENTIST'S SPEED INDICATOR

Registers how far, total, and for each trip. Double scale shows each speed at all times, from zero to 62 miles per hour.

ONLY SPEED INDICATOR THAT CAN BE ACCURATELY SET TO ZERO AT ANY TIME BY THE OWNER.

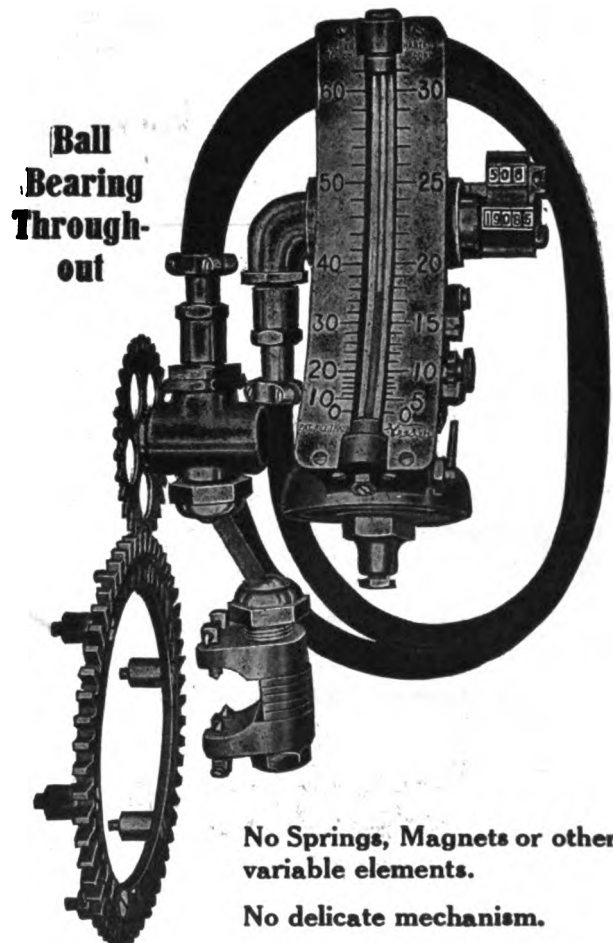

Ball Bearing Through-out

No Springs, Magnets or other variable elements.

No delicate mechanism.

Only One Moving Part.

Price, complete, ready to put on any car \$50.00

Thousands of Veeder Odometers in use to one of any other make.

The Veeder Mfg. Co.,
 22 Sargeant St.,
 HARTFORD, CONN.

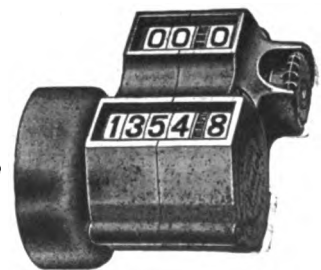

Represented in Great Britain by Messrs. Mark & Co., Ltd., 6 City Road, Finsbury Square, London, E. C., England.

FORM D or DASHBOARD ODOMETER. Complete with flexible shaft and attaching fixtures, ready to put on any car, \$25.00.

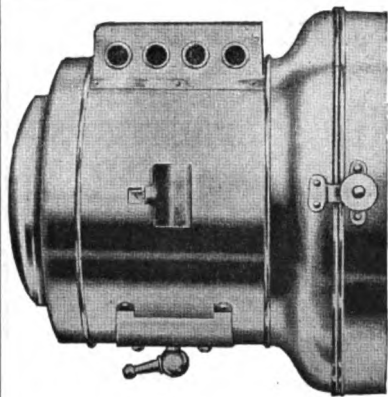

Lamp Equipments
AT
Popular Prices

In the first place we make Lamps as well as they can be made; after that, we sell them at a very modest price, quite a low price, in fact.

May we send you a sample? So's you may inspect and know all about it.

We are especially proud of our lamps for moderate-priced cars.



VICTOR LAMP CO., Cincinnati, O.

HARRIS OILS
TRADE MARK-REG. U. S. PAT. OFF.

MADE FAMOUS
BY
1908 Racing Events

YOU MAY SEE THEM NEXT
AT
Madison Square Garden

Elevated Platform
Space No. 159

January 16 to 23

==PAY US A VISIT==

A. W. HARRIS OIL CO.
PROVIDENCE, R. I.

Prest-O-Lite Gas Tank



The Light That Fails Not

Strong, steady dependable light, turned on and off like a gas jet. Clean, safe and economical.

Used by all experienced motorists. Refilled tanks obtainable everywhere. Beware of imitations.

The Prest-O-Lite Co.

New York, 1904 Broadway
Indianapolis, 229 E. South St.
Philadelphia, Race and Carlisle Sts.

Boston, 607 Boylston St.
San Francisco, 520 Van Ness Ave.
Toronto, 6 King St. W.

2500 Exchange Agen's

"THE STAR"



Scale 50 miles. Price \$25.00.
STYLE No. 960

The best popular priced Speedometer on the market. We give 30 days in which to prove it. Write for Catalogue and full particulars.

STAR SPEEDOMETER COMPANY, Danville, Penna.
New York City, 1679 Broadway. Boston, Mass., 222 Elliot St.
Phila., Penna., Geo. W. Nock Co., 126 N. 4th St.

HOW THE "GOODNESS" IS PUT INTO MORGAN & WRIGHT TIRES

1. By using only the best grade of pure Para rubber and finest quality of long Sea Island cotton fabric it is possible to buy.
2. By employing the most experienced help to be had, going on the principle that with materials of a high grade the quality of a completed tire is dependent upon the amount of brains put into its making.
3. By making them in the light of twenty-eight years' experience in the manufacture of rubber goods.
4. By making them in the newest and best equipped rubber plant in the world.
5. By adhering to this unvarying rule: That *every* tire that leaves the factory shall be as perfect in material and construction as money and skill can make it.

If you want your tires made that way, why not specify Morgan & Wright's on your car for next year? They cost no more than other brands.

MORGAN & WRIGHT, Detroit

The Unisparker

A Simplified Form of the Atwater Kent Spark Generator

Every owner of a car with batteries and trembler coils has wished for a more reliable ignition system. Those who have tried the Atwater Kent Spark Generator have pronounced it the cure of all their troubles. But, to the owner of a car already built, the gear-driven Spark Generator is sometimes troublesome to install.

To meet the demand of those wishing a simple and easily applied apparatus we have arranged the Contact Maker—the vital element of the Spark Generator—in a form attachable to any convenient half-time shaft, exactly like the ordinary timer. Combined with it is a compact Distributor. The Coil is separate and goes on the dashboard. On it is a kick switch with special contact for starting on the spark.

The greatest merit of the Atwater Kent Spark Generator is not its battery economy—high though that is—but its extraordinary *reliability*. In the UNISPARKER we place that unique advantage within the reach of every owner of a car.

Prices of UNISPARKER and Coil:

6 cylinder, \$50; 4 and 3 cylinder, \$45; 2 cylinder (switch not self-starting), \$35. Collar for attaching to half-time shaft, 50 cents additional. Specify size of shaft and direction of rotation (clockwise or counter-clockwise) when ordering.

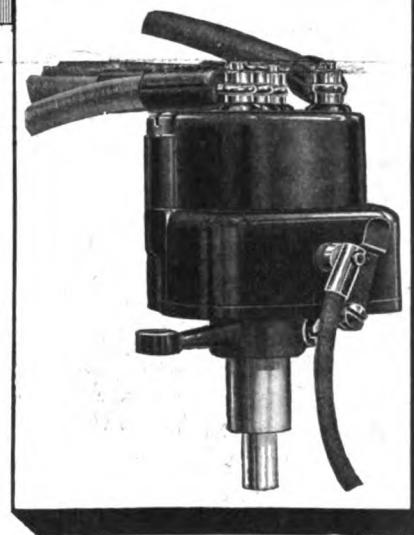

Atwater Kent Manufacturing Co.
N. Sixth St. Philadelphia, Pa

GABRIEL 1909



In order to maintain the high standard which the products of our factory have acquired, many improvements have been made in the 1909 models of The Gabriel Horn, The Gabriel Shock Absorber and The Gabriel Cut-Out Valve. Gabriel Products still set the pace which competing lines try to follow.



A POLITE REQUEST

The rich, mellow notes of THE GABRIEL HORN act as a polite request, not a harsh demand. It warns without frightening. By a new device its sweet musical three note tone used for city purposes can be caused to rise in unison for a penetrating warning on country roads. The Gabriel Horn is used exclusively on the personal cars of King Edward of England, Emperor William of Germany and other crowned heads of Europe.

1909 GABRIEL HORN AND CUT-OUT VALVE

We have perfected a new valve which is used both for operating exhaust horn and for cut-out purposes. For cut-out purposes remove the disc in main channel, thereby relieving back pressure from muffler through additional opening of 1 3/4 inches. Made to fit exhaust pipes 1 inch to 2 1/2 inch outside diameter. Warranted not to stick under any condition.

GOING UP

is pleasant enough, but coming down with a thud is what makes the nerves quiver and cry for

1909 GABRIEL SHOCK ABSORBERS

A retardating friction gradually applied in proportion to the shock takes up all jolts and jars, and makes riding over rough roads or bumpy pavements a positive pleasure. The 1909 Model has improvements which give increased bearing surface, eliminate noise or rattle and greatly increase its efficiency and durability. Thermoid used for friction pad. Can be attached to any car or any type of spring.







Write for booklet illustrating and describing our 1909 products.

GABRIEL HORN MFG. CO.

1410 East 40th Street
CLEVELAND, OHIO

CONNECTICUT



IF it's a COIL (1, 2, 3, 4 or 6 Cylinder), Distributor, Timer, Terminal, Coil Current Indicator, Ammeter, Switch or Exploring Lamp, we have them in Quality a little better than the best

SEND FOR CATALOG 13-B

CONNECTICUT TELEPHONE AND ELECTRIC CO.

50 Britannia Street MERIDEN, CONN.



Ninth National Automobile Show

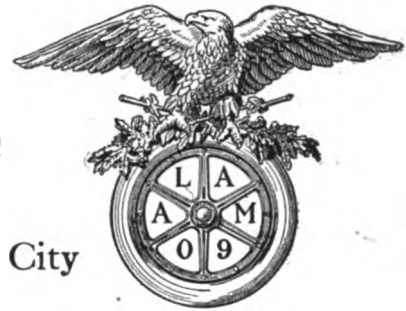

Madison Square Garden

January 16 to 23, 1909, New York City

Under the Auspices of the

Association of Licensed Automobile Manufacturers

Exhibiting standard Gasoline Cars licensed under the Selden patent

LICENSED GASOLINE CARS

Apperson	Columbia	Hewitt	Packard	Royal Tourist	Stevens-Duryea
Autocar	Elmore	Knox	Peerless	Sampson	Studebaker
Buick	E-N-F-	Locomobile	Pierce Arrow	Selden	Thomas
Cadillac	Franklin	Lozier	Pope Hartford	Simplex	Walter
Chalmers-Detroit	Haynes	Matheson	Pope Toledo	Stearns	Waltham
Corbin					Winton
Anderson	Bailey	Champion	General Vehicle Co.	Studebaker	Woods
Babcock	Baker	Columbia	Rauch & Lang	Waverly	

ELECTRIC

STEAM White

Complete exhibit by the Motor & Accessory Manufacturers. The only complete Motorcycle exhibit in New York, by the Motorcycle Manufacturers' Association, Commercial Vehicles, Town Cars and Taxicabs.

SOON OR LATE
YOU ALSO MUST USE
HESS-BRIGHT PRODUCTS

BALL
BEARINGS

WHY?
BELOW

MAGNETOS

Because of the HB determination (backed by the most complete specialized ball bearing plants in the world) to build always nothing but the best.

THE HESS-BRIGHT MANUFACTURING COMPANY
2106 FAIRMOUNT AVENUE, PHILADELPHIA, PA.

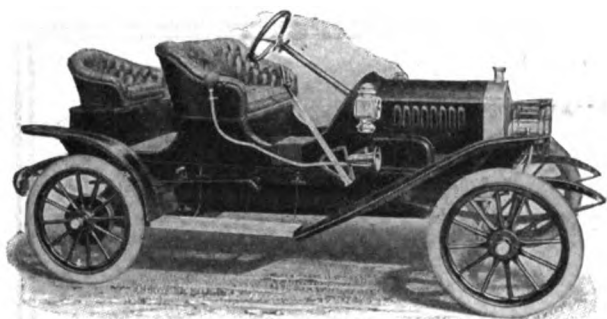

Model A-1. \$800

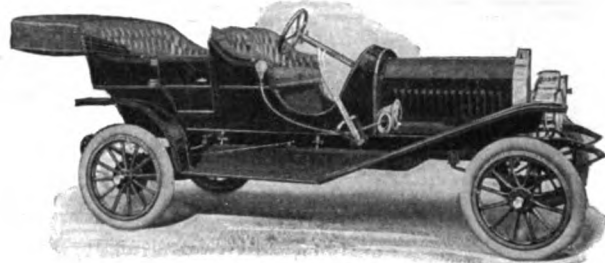

Lambert "30." \$1250

LAMBERT FRICTION-DRIVE CARS

The Economical Lambert

THE LAMBERT is a simple car—correct in principle and design, sturdy in construction. It is as reliable, as **sure-going** as a car can be made.

There is just one thing that makes possible the manufacture of so good a car as the Lambert Car at a cost permitting us to sell it at the **low price** we do.

This one thing is the **Lambert Friction Drive** transmission. The cost of producing this **most efficient (proven)** transmission is so much lower than the cost of **any** type of the complicated gear transmission that we can—and do—put more real automobile worth into

every Lambert Car than the manufacturer of **any** gear-transmission car can give for the same money.

The Lambert Car—each of our six models—has a full dollar's worth of power, speed, endurance, style and finished for every dollar of the price—and more too—if judged by ordinary standards. Each Lambert model—from the \$800 Runabout Model A-I up to the big roomy 7-passenger Lambert at \$2000—is a positive leader in its class—the choice of people who "find out" **before** they buy.

Our 1909 Proposition to Agents

We offer an exceptional proposition to agents and dealers in territory not now occupied by Lambert representatives. The demand for **good** automobiles at a low price cannot be denied.

We want the right kind of men to represent the **best** low-priced car—the Lambert Car.

In writing for full details please state what cars you are now handling and what your facilities are for taking care of our interests.

ADDRESS

Buckeye Mfg. Co., Anderson, Ind.

1815 Columbus Avenue

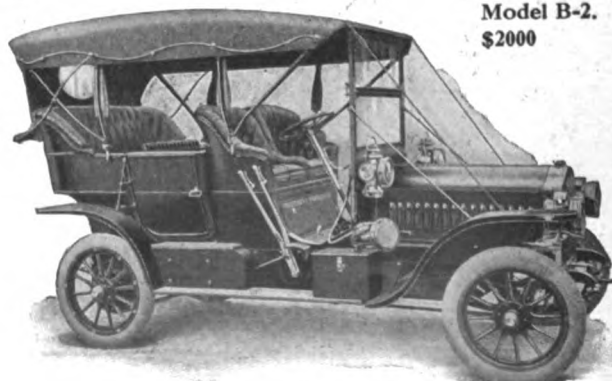

Model 19. \$1750

Model B-2.
\$2000

"AUSTIN"

The Car That "JUST SUITS" Everybody

Here's the New Car They Are All Talking About—Model "45"

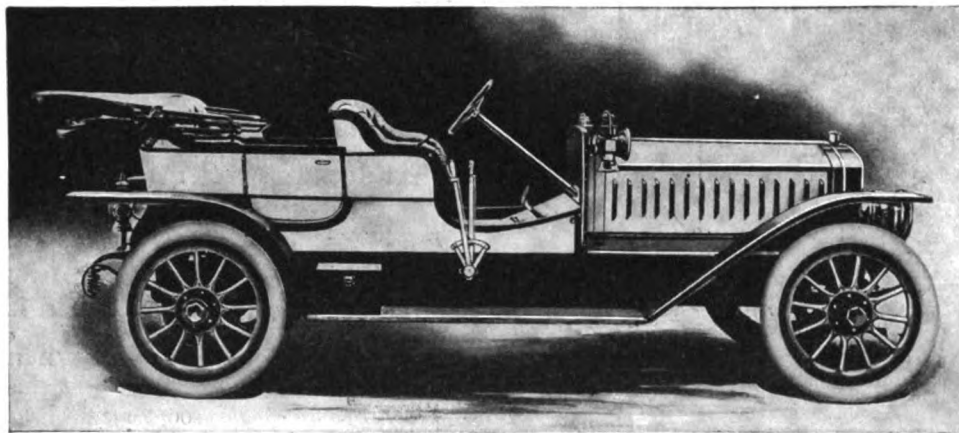

Six Cylinders, 45-50 H. P., 2250 Pounds, \$3,000.00

The New AUSTIN "45" illustrated above is a car for everybody at all times. It is a five-passenger Touring Car with a Detachable Tonneau that can be replaced by a Rumble Seat in three minutes. Double Ignition, Selective Transmission, Floating Rear Axle, 36-inch Wheels, 125-inch Wheel Base; and the same highest quality of Material, Workmanship and Finish for which all "AUSTIN" cars have always been noted.

OUR 1909 LINE

Model 60—60-90 H. P., 6-Cyl., 5 1-2 x 5 1-2, 7-Passenger Touring Car, \$5000.00

Model 50—50-60 H. P., 4-Cyl., 5 1-2 x 5 1-2, 7-Passenger Touring Car, \$4000.00

Model 45—45-50 H. P., 6-Cyl., 4 1-4 x 4 1-2, 5-Passenger Touring Car, \$3000.00

All above models furnished with detachable Limousine Top, \$1000.00 Extra

Meet us at the Grand Central Palace Show, New York City, Dec. 31st to Jan. 7th. Meanwhile, send for our Advance Circular and complete description of our 1909 Models.

Standard Manufacturers A. M. C. M. A.

AUSTIN AUTOMOBILE CO.,
GRAND RAPIDS, MICH.
 Chicago Branch, 1420 Michigan Ave.

The AUTOMATIC SHAKING GRATE GENERATOR

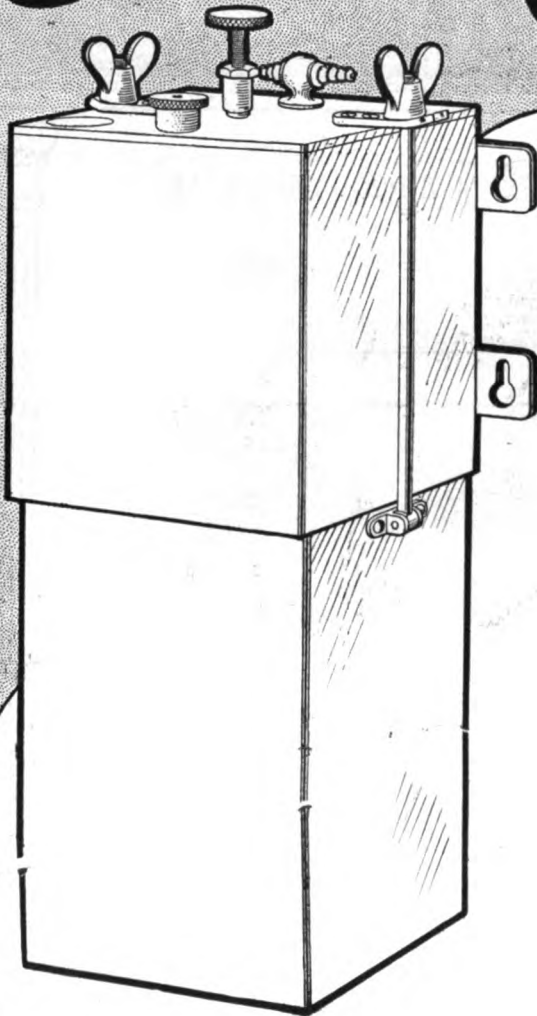

A GENERATOR minus the familiar frailties of the generator kind.

- that does not overheat
- that does not clog up
- that does not wet the lime
- that stops working when you want it to.
- does not waste carbide when idle
- and gives gas in a jiffy when re-started
- that doesn't crack the lens mirrors, waste gas by flaring, or burn dim when you most need the light
- but gives a perfectly steady pressure all the time
- that uses commercial lump carbide, giving four feet of gas per pound
- that holds carbide enough for twenty feet of gas at a charging, and holds it till it is all used up.

If you had such a generator as that, is it likely you would pay six prices for stored gas, and return the tank a quarter full because experience had taught you not to take chances?

We commend to your careful study the RUSHMORE AUTOMATIC SHAKING GRATE GENERATOR, No. 2. The new catalog describes it fully.

RUSHMORE DYNAMO WORKS

PLAINFIELD, N.J.—CHICAGO, ILL.—LONDON.—PARIS.

THE WHITE STEAMER IS THE ONLY CAR of dis- tinctively American design

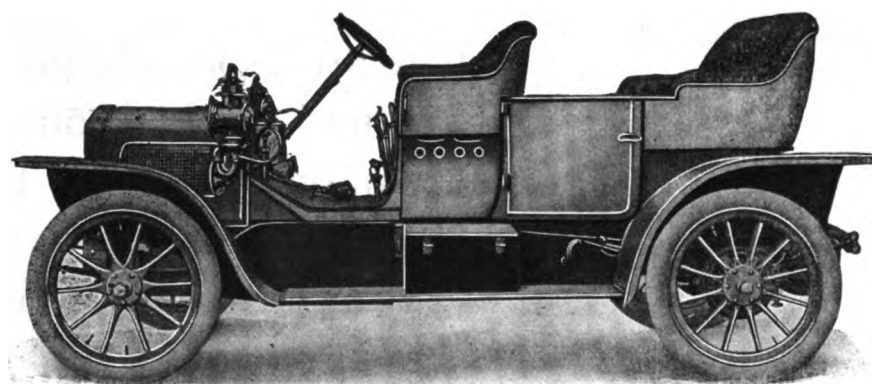

The White is the only car which is not a copy or an imitation of some foreign product. In almost every class of machinery—typewriters, sewing machines, agricultural implements, machine tools, etc.—American ideas of construction have eventually proved triumphant, and so it is with the White Steamer. The White is sold in quantities abroad in competition with the home product and, as regards this country, there are more Whites in use than any other make of large touring car.

The White possesses so many points of superiority over other types of automobiles that any one who purchases a car without first investigating the White is acting with only a partial understanding of the possibilities of automobile construction. We can meet the requirements of almost any pocketbook with either our 20-horse-power car at \$2000 (shown above) or our 40-horse-power car at \$4000. The United States Government, the most discriminating of purchasers, owns more White Steamers than all other makes combined. Our cars are used by the War, Navy and Executive Departments.

Write for Descriptive Matter

THE WHITE COMPANY

CLEVELAND, OHIO

NEW YORK CITY, Broadway at 62d Street
BOSTON, 320 Newbury Street
PHILADELPHIA, 629-33 North Broad Street
PITTSBURG, 136-48 Beatty Street

CLEVELAND, 407 Rockwell Avenue
CHICAGO, 240 Michigan Avenue
SAN FRANCISCO, Market Street
at Van Ness Avenue
ATLANTA, 120-122 Marietta Street

Jackson
AUTOMOBILES
**Season
of 1909**

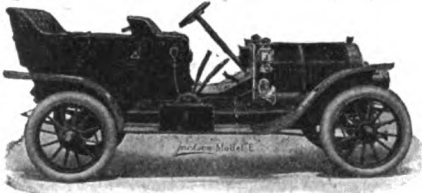

Model E \$3000. 4 cyl.

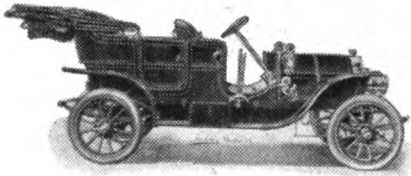

Model H \$1600. 4 cyl.

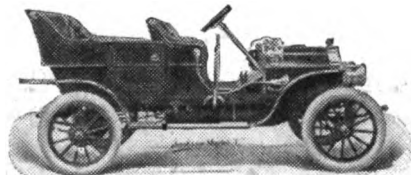

Model C \$1250. 2 cyl.



Model K \$950. 2 cyl.



Model F \$850. 2 cyl.

Dealers:—

If you want a clean cut, up-to-date, snappy, reliable line of cars—a complete line—a dependable line it is pleasant and profitable to sell—get the JACKSON Agency!

There are especially good features to be found in Jackson cars which give them individuality. Every point is made a substantial point. Every unnecessary frill is cut out. Every possible provision is made for the comfort of those who ride in Jackson cars—notably our Jackson special full elliptic springs, front and rear, made right and tempered right in our own spring plant. Jackson cars are not only practical in every sense, but luxurious in their easy riding qualities.

1909 Models will be exhibited and demonstrated at the Coliseum Show, Chicago, Feb. 6 to 13.

No Sand Too Deep—
No Hill Too Steep

JACKSON AUTOMOBILE COMPANY
JACKSON, MICHIGAN

Briscoe Manufacturing Company

Largest
Manufacturers
of
Automobile
Accessories
in the World

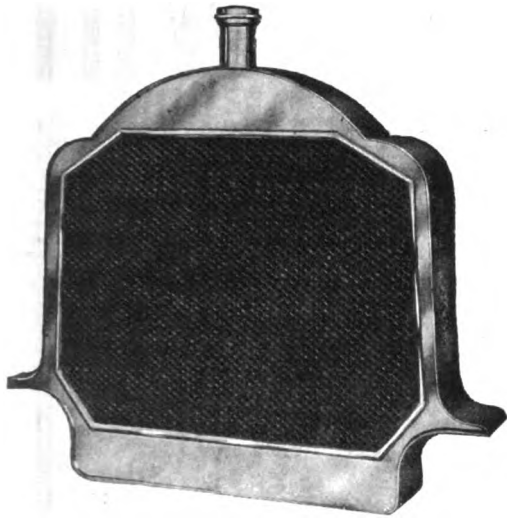

HONEYCOMB



VERTICAL TUBE
CONTINUOUS FIN



HORIZONTAL TUBE

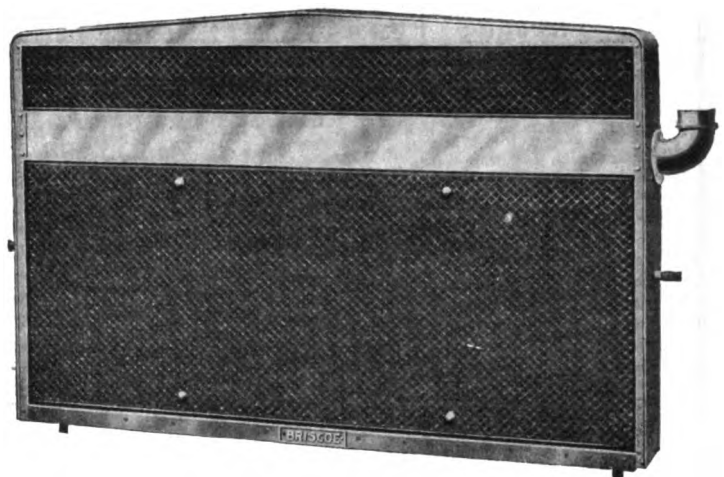

HONEYCOMB TRUCK

Material and Workmanship
Guaranteed

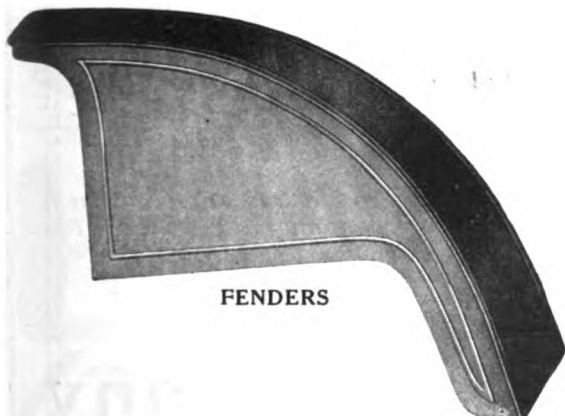

FENDERS

We Repair
All Makes of
Radiators

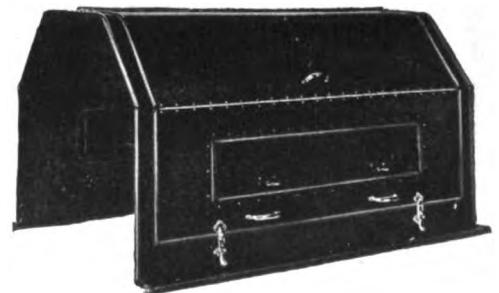

HOODS

Detroit, Mich.

WRITE EITHER FACTORY FOR
CATALOGUE AND QUOTATIONS

Newark, N. J.

Three Mathesons Win

FIRST, THIRD and FOURTH PLACES

in capturing MacDONALD & CAMPBELL \$600 Cup

300 Miles Mid-Winter Contest

From Philadelphia to Wilkesbarre and Return

Over the Pocono Mountains, making also the highest team score against a field of

32 Contestants

including these cars: 2 Peerless, 1 Stearns, 1 Studebaker, 2 Cadillacs, 1 Acme, 3 Stoddard Daytons, 1 Elmore, 2 Franklins, 3 Mitchells, 2 Wintons, 3 Oldsmobiles, 2 Maxwells, 2 Knoxes, 2 Ramblers, 1 Buick, 1 Premier.

Only three of the thirty-two cars had perfect time scores and these three were Mathesons

No. 7 Matheson Wins First Place

For MacDonald & Campbell \$500 Cup

This car, owned and entered by Mr. F. M. Kirby, Wilkesbarre, Pa., and driven by Mr. Kirby's chauffeur, William Miller, is a regular stock Matheson touring car which Mr. Kirby had driven over 7,000 miles prior to entering it in the contest. Actual running time, 5 hours and 31 minutes, breaking all previous records.

No. 15 Matheson Wins Third Place

This car, entered and driven by Mr. Ross Anderson, Wilkesbarre, Pa., was a regular stock Matheson touring car which had covered 18,000 miles in service prior to entering this contest. Actual running time, 6 hours and 4 minutes; also new record time.

No. 6 Matheson Wins Fourth Place

This car, entered by ourselves, was a regular stock Matheson touring car which had covered over 12,000 miles in service prior to entering this contest. Actual running time, 5 hours and 24 minutes, the fastest time ever made by any car over this course, Summer or Winter.

ALL THREE MATHESONS FINISH WITH ABSOLUTELY PERFECT ROAD SCORES, MAKING EVERY CONTROL ON TIME

Only one stop was made on account of tire trouble, proving our claim that the Matheson Car, due to its beautiful balance, chain drive and multiple disc clutch, is the easiest car on tires. Our customers usually cover from 5,000 to 10,000 miles on their original tires.

THE CONCLUSION: *The Matheson Car has proved in every endurance run it has entered that it is far and away the most reliable and serviceable as well as the most economical and the fastest touring car in all the world.*

AND THIS IS ALSO OUR GUARANTY

Matheson Automobile Company

1886-1888 BROADWAY, Corner 62d Street, NEW YORK CITY

We will exhibit only at Madison Square Garden Show, Jan. 16-23, 1909. Demonstrations by Appointment.

Members A. L. A. M.

The Cheapest Prices at Which Highest-Grade Accurate and Reliable Speed Indicators Were Ever Sold. \$15 and \$25

This great reduction in price is forced on us for the following reasons:

- (1) We have too many instruments on hand and must make room for our 1909 product.
- (2) We need the money.

THE HICKS SPEED INDICATOR

is too well known and by long and successful service its reputation too well established to need comment. There is no better or more reliable indicator made anywhere at any price. *These are proven facts.*

Over 5000 in use and not 2 per cent. ever returned for repairs. Written guarantee with every instrument. The indicator now offered at \$15 is our regular \$25 instrument.

The indicator now offered at \$25 is our regular \$50 instrument. Maximum hand added to either model for \$3 extra. This offer is for a limited time only. An opportunity for money-saving you should not miss.

In ordering, give make, year and model of your car. See "The Automobile," Aug. 27, for full particulars.

LONG ISLAND AUTO SUPPLY MFG. COMPANY
Office and Factory: 31-33 Grant Square, BROOKLYN, N. Y.



75% LESS REPAIR EXPENSE IF YOU USE

A SHALER VULCANIZER



Even a boy can vulcanize new rubber into cut and holes. It's the only portable vulcanizer safe in inexperienced hands. Keeps tires trim, prevents blow-outs—makes one tire wear as long as three. Write to-day for our free booklet "Care and Repair of Tires." SEE OUR EXHIBITS AT THE SHOWS

C. A. SHALER COMPANY, Box R., Waupun, Wis.

We cordially invite you to visit our exhibit of Automobile Ignition Apparatus at the Madison Square Garden Automobile Show, January 16-23. Elevated Platform, Space 102.

C. F. SPLITDORF

Walton Ave. and 138th St.

Branch: 1679 Broadway

NEW YORK



GEARS FOR REPAIRS RUSHED

We can furnish promptly spurs, bevels and internals of open hearth, nickel or chrome nickel steel properly hardened. Also bronze and fibre gears. Send us your samples.

THE NEW PROCESS RAW HIDE CO., SYRACUSE, N. Y.



"BUCKEYE" AUTO SOAP

Linseed oil soap—strictly neutral, leaves no smoky haze, removes dirt but never touches the varnish, preserves the finish and brings out the luster better than the ordinary kind. Goes twice as far.

Write for sample and prices if your garage doesn't keep it.

J. P. DAVIES CO., DAYTON, O.

BUCKEYE CLEANSER
GRABS THE DIRT AND GREASE
ECONOMICAL CONVENIENT FOR USE
STRICTLY NEUTRAL

THE J. P. DAVIES COMPANY
DAYTON, OHIO

USE HALF AS MUCH AS OF ORDINARY SOAP
QUICK WASH IN COLD WATER
RESPREST LUSTER
POLISHED SURFACES

JOT IT DOWN

to call at our exhibit at the coming Automobile Show at Madison Square Garden. You will find an interesting display of our product, including several new and distinctive features.

SPACE 311, A. L. A. M. SHOW

Standard Roller Bearing Co., PHILADELPHIA, PENNSYLVANIA



"THE LITTLE STEERSMAN"

A Wonderful Safe-Guard to Motoring

It is an automatic steering device that will guide your car should you lose control and insure the safety of both the occupants and the car. Seems incredible—but it's TRUE and we can prove it. Accidents are able to happen any time. Avoid the possibility by equipping your car NOW with "The Little Steersman." Ready attached to any auto. Once used you'd never be without it. **PRICE ONLY \$5.00**

Satisfaction Guaranteed.
Send your order TO-DAY or write for full particulars.

THE ABRAMS-MASON CO., Chatham, New York

YOUR LIFE AND THE SAFETY OF YOUR CAR IS WORTH MORE THAN \$5 ISN'T IT?
Of course—then this will interest you.

Patents Pending

There is only ONE

ALBANY GREASE



A Lubricant Unsurpassed for Automobiles and Motorboats

ONLY MADE BY **ADAM COOK'S SONS**
313 West St., N. Y. City

1909 WINNER—The Latest—Most Practical



**Reversible
Movable
Ratchet
Two Sizes**

**Universal
Steel
Handle
All Stores**

Descriptive Circular and Cuts for 1909 Catalogues Free
TUDOR MFG. CO., TAUNTON, MASS.

**LEAVITT
DISTRIBUTOR**

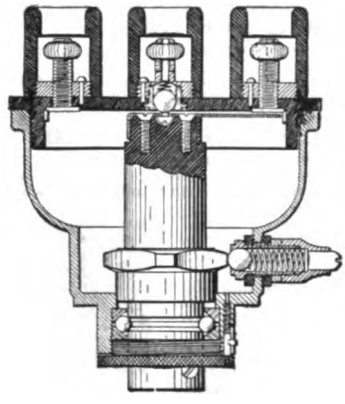

is built right and gets maximum results regardless of conditions. Its construction gives durability. All aluminum body. Rubber top. Water and heat proof. Sizes 2 to 8 cyl. (inclusive). Write for catalog.

**UNCAS SPECIALTY CO.
NORWICH, CONN.**
High-Grade Ignition Specialties

**A Happy
New Year**
to the thousands of
users of

Swinehart Tires
The Trouble-Proof Tires



Our heartfelt SYMPATHY is extended to those annoyed by the usual pneumatic tire troubles, and we cordially invite you to investigate our cushion tires by writing for our Booklet "C"

SWINEHART CLINCHER TIRE & RUBBER CO.
NEW YORK: Akron, O. CHICAGO: 1720 Michigan Av.
875 Seventh Av.



Hotel Tuller

ABSOLUTELY FIREPROOF

Adams Avenue and Park Street
DETROIT, MICHIGAN

Automobile Headquarters
In centre of Theatre, Shopping
and Business district.
Club Breakfast, - 40c. up
A la Carte Cafe
Grille Rooms
Every Room with Bath

Rates, \$1.50 Per Day, up

L. W. TULLER, Prop.
M. A. SHAW, Manager



**MAGNA QUICK
CHANGE RIGID
BATTERY HOLDER**



USES any STANDARD dry battery. NO connections to work loose. IMPOSSIBLE to connect cells up wrong. BATTERIES held absolutely rigid. TAKES less than two minutes to change set of six cells. BOX carried same as storage battery. Price, 6-cell box \$6.00

**R. J. W. MAGNA MFG. CO.,
Holyoke, Mass.**

Cuts now ready for 1909 accessory catalogues

**"NON-SWELL"
Silent-Running
FILLED GEARS**

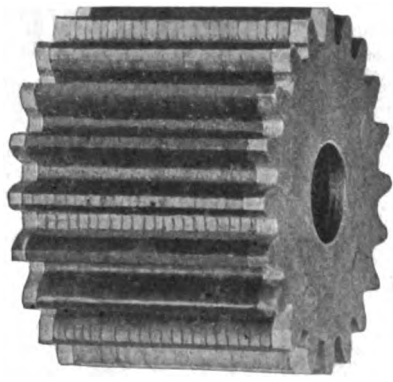

Little Giant
Steering Gear
Buggyabout
Steering Gear
Universal Joints
18-25-35 H. P.

C. A. WIDMER MACHINE WORKS, Detroit, Mich.

**High Efficiency
Non-Sulphating
Ignition Batteries**



Capacity Guaranteed

Tray Plate Battery Co.
5 Frederick St., Binghamton, N. Y.

**TRIPLE ACTION
SPRINGS**
WILL FIT ANY CAR



They add so much that's good and prevent so much that's bad, that it's hard to tell it all in any kind of ad. Vibration Absorbed Absolutely. Life of Tires Prolonged. Efficiency of Engine Increased. Less Road Resistance. Greater Speed, Less Fuel, No Broken Side Springs.

Guaranteed right in every detail. Write
Triple Action Spring Co.
68 East 21st St.
Chicago, Ill.

Type 11
Type 12

Let Us Make Your

HUB CAPS, SIDE LEVERS, and LAMP BRACKET CASTINGS

from

Manganese Bronze or Yellow Brass

They Will Be Smooth and Accurate to
Pattern.

**SYRACUSE ALUMINUM & BRONZE CO.,
SYRACUSE, NEW YORK**

THOS. J. WETZEL, Eastern Sales Agent, 29 W. 42nd St., New York City

NON-FLUID OILS

LOOK FOR THIS CAN



before you buy lubricants and you won't look for lubrication troubles afterward.

GREASES spread only when melted by frictional heat, and then they get too thin to remain between the rubbing surfaces.

NON-FLUID OILS spread before the bearings get hot, and they always remain dripless, instead of running away from the bearing.

NON-FLUID OILS are pure fine mineral oils condensed, and contain none of the talc, rosin, fats, waxes, etc., used as "fillers" in greases.

That is why they last longer, do their work better and are so clean.

Get a free sample can. Write to-day.

N. Y. & N. J. Lubricant Co.
ORIGINATORS AND
SOLE MANUFACTURERS
Dept. F, 14-16 Church St., New York

Automobile Catechism

For the Use of Owners and Drivers of Cars Fitted
with Internal Combustion Motors

BY
FORREST R. JONES, M.E.
President of the Manhattan Automobile School

THIS is the most practical, up-to-date work on the subject in the English language. It is published in pocketbook form, with high-grade leather cover, and printed on especially tough paper, as it is intended to be the inseparable companion of the autoist when on tour. Not a line is wasted on obsolete constructions or descriptions of unfamiliar apparatus. It treats of the automobile in modern form and of all the troubles that may arise in the course of ordinary use and that may be remedied by the driver himself. It is written in plain language and is the most helpful, authoritative, and comprehensive manual that has yet appeared. The subject matter is in the form of question and answer, and an exhaustive cross index makes immediate reference possible in any particular case.

Size, 4½ by 7 inches. Pages 134.
With Drawings.

Price, in genuine Morocco Cover, gilt edges, \$2.00
Including postage

Order from the publishers
The Class Journal Company
231-241 West 39th Street New York City

K-W K-W K-W K-W K-W K-W K-W K-W K-W K-W

Why is the

K-W Magneto

replacing so many complicated, high priced, high tension Magnetos of other makes?

Because

it will start the engine easily without batteries and run it perfectly at all speeds from the highest to the lowest. It is absolutely reliable at all times.

The K-W Magneto is simple and efficient because it is designed right; reliable and durable because it is built right; cheap because it is simple.

**You Can Pay More But
You Can't Buy Better**

The K-W Coil is the best on the market—you can't beat it. The K-W Magneto is made in eight models for belt, gear or friction. Tell us what car you have and we can cure your troubles.

K-W Ignition Company
34 Power Ave., Cleveland, Ohio

N. Y. Representative—A. H. Green & Co., 1686 Broadway, N. Y. City.
Boston —W. J. Forbes, 220 Congress Street.
Chicago —The Automobile Supply Co., 1339 Michigan Blvd.

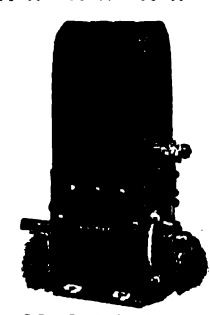

Model A, \$35.00

K-W K-W K-W K-W K-W K-W K-W K-W K-W K-W

THE WARNER AUTO-METER

Guaranteed Absolutely Accurate

is the only speed indicator made on the Magnetic Induction principle. Because of the principle it accurately indicates every range of speed from zero to the maximum.

All other instruments are made on the centrifugal principle. They fail to indicate any speed whatever under 5 to 10 miles per hour.

The Auto-Meter is so durably made that practical tests have shown that it will endure a MILLION MILES of riding without perceptible wear, or departing from absolute accuracy more than 10 feet to the mile.

WE INVITE COMPARATIVE TESTS. Before you decide on any Speed Indicator, put the Auto-Meter on one side of your dash and any other indicator at any price on the other. Then use your watch over a measured course. Keep the instrument which tells the truth. We know which it will be.

The Warner Instrument Company

Factory and Main Offices: 351 Wheeler Avenue, BELOIT, WIS.



BRANCH HOUSES
 New York, 1902 Broadway
 Boston, 925 Boylston St.
 Pittsburg, 3432 Forbes St.
 Cleveland, 2062 Euclid Ave.
 Philadelphia, Cor. Broad & Race
 San Francisco, 550 Golden Gate Av.
 Los Angeles, 1212 S. Main St.
 Indianapolis, 330½ N. Illinois St.

A Happy New Year

is in store for the motorist who pins his faith to

The American Igniter

One to six



Cylinders

A dust, heat and moisture-proof case containing a complete ignition system, *coil and all.*

Mounted directly on the timer shaft.

Attractive prices. Ask us about it.

American Electric Fuse Co.

MUSKOGON, MICH. NEW YORK, N. Y.

FISK TIRES

For any Rims

BOLTED-ON-CLINCHER-Q.D.CLINCHER

FISK TUBES

For all Tires

FISK REMOVABLE RIMS

WITH

BOLTED-ON-TIRES

FOR THE IDEAL TIRE EQUIPMENT



THE FISK RUBBER COMPANY
 CHICOPEE FALLS, MASS.



A NEW DEPARTURE in POCKET
 MEASURING INSTRUMENTS

The Hoyt Triune Voltammeter

THREE INSTRUMENTS IN ONE

Voltmeter scale 0-10	readable to 1-5	Volt
Ammeter " 0-30	" " 1-2	Ampere
" " 0-1 1-2	" " 1-20	"

This is not a cheap gage, but a ruggedly built, finely finished, D'Arsonval type Instrument. The moving parts rest in highly polished jewel bearings, and the Instrument is guaranteed accurate at all points on the scale. It is exceedingly dead beat in action, yet so sensitive that it will indicate 1-50 of an ampere. In short, this Instrument has been designed expressly for that large and representative class who want only the best and are willing to pay a fair price for it. Instrument is furnished in a morocco-bound, plush-lined case having a separate compartment for a pair of silk covered cables which accompany it. Size of case 4 x 3 1-4 x 2 inches; easily fits in coat pocket. Obtainable of any live dealer, or will be sent, express prepaid, on receipt of \$12.00.

Ask for Bulletin "A"

HOYT ELECTRICAL INSTRUMENT WORKS

PENACOOK, NEW HAMPSHIRE

DEALERS ATTENTION
"SEE WHO'S HERE"

AUTO CLE'S LITTLE
 BROTHER

THE TITUS CLE

A NEW SOCKET WRENCH
 BOUND TO BE
 POPULAR



SOLD BY ALL DEALERS

Distributing Agents:
FRANK MOSSBERG CO. **FACTORY SALE CORP'N**
 Attleboro, Mass. Chicago, Ill.

Manufactured by
QUINCY, MANCHESTER, SARGENT CO.
 Plainfield, N. J.

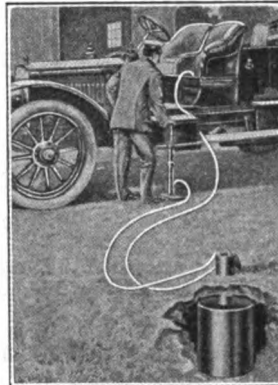

**GASOLINE
 IN BULK**

is an actual necessity to every owner of an automobile. The saving in cost and convenience of always having an available supply on hand make it so. But more important than either is the assurance of always having an un-deteriorated Gasoline.

Deteriorated Gasoline

invariably results where the container is not absolutely *Air-tight*.

"AIR-TIGHT" Steel Tanks

are the only Gasoline Reservoirs made of brazed steel practically all in one piece, without either rivet or solder joints to develop leaks.

"AIR-TIGHT" Steel Tanks

have heretofore been made only in two, three and five barrel sizes. We are now making a

One Barrel Air-Tight Brazed Steel Gasoline Reservoir that preserves absolutely the original high proof of the gasoline, is accident-proof, fire-proof, clean, safe and convenient.

PRICE \$28.00, complete, including Pump, delivered. Two-barrel size, \$58.00. Three-barrel size, \$67.00. Five-barrel size, \$85.00.
 Money refunded after thirty days' use if not entirely satisfactory. Write for illustrated descriptive booklet and treatise of Gasoline and how to prevent deterioration.

"Air-Tight" Steel Tank Co., 400 Wood St., Pittsburgh

1 9 0 9
MODEL "K" MOTOR

**FOR HIGH WHEEL BUGGY and
 LIGHT DELIVERY WAGON**

14 H.P. AIR COOLED 16 H.P. WATER COOLED

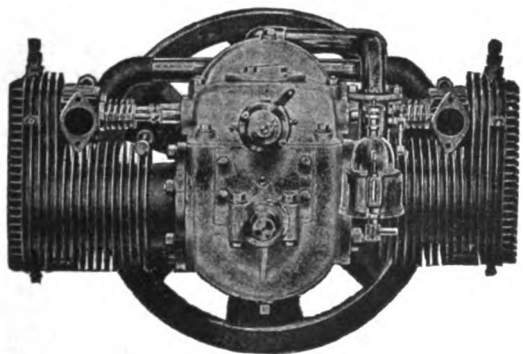

Off-set Cylinders
Straight Connecting Rods
Mechanically Operated Valves
Perfectly Balanced; Thoroughly High Grade
Overall Dimensions, Length 27 1/2", Width 15 1/2"
Depth, Including Fly wheel, 19 1/2"
Positively Guaranteed to Cool Perfectly

SPEED CHANGING PULLEY CO.
ANDERSON, IND.

MASURY

SUPERFINE

**AUTOMOBILE
 COLORS**

AND

VARNISHES

MANUFACTURED BY

JOHN W. MASURY & SON

NEW YORK
 CHICAGO - ST. LOUIS - MINNEAPOLIS

— ESTABLISHED 1835 —



G. and C. Revolving Auxiliary Chair Seat

It revolves in any position, folds up, and is fastened to the tonneau by a special bracket so it is easily adjusted or removed.

Sold in the white or upholstered.
High Grade Bodies. Limousines and Taximeter Cabs our specialty.

Graves & Congdon Co.
AMSBURY, MASS.

Pat. Applied For

Leaflet on request

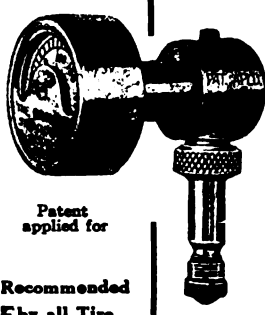

500 Miles More Per Tire

Does this interest you Mr. Motorist?

Brown Indicator

Accurate, automatic and practical. The proper inflation of tires is as necessary as gasoline.

The investment is small but the results are great. Price **\$3.00**

THE BROWN CO.
419 East Water Street, SYRACUSE, N. Y.

Patent applied for

Recommended by all Tire Manufacturers

LISTS

of all Automobile Dealers, Garages, Charging Stations, Repair Shops, Dealers and Jobbers of Supplies, Purchasing Agents, Mechanical Engineers, etc. Write for our proposition.

The AUTOMOBILE TRADE DIRECTORY 231-241 W. 39th St. New York



Allen Tire Covers
The Original Button Kind—Ask for them by name

We use Enameled DUCK—Not Drill Covers for all makes of Demountable Rims and Spare Wheels.

Allen Tire Locks
NONE BETTER MADE

Allen Tire Holders
ADJUSTABLE—DETACHABLE

THE ALLEN AUTO SPECIALTY CO.
Manufacturers
Phone, 5346 Col. 1931 Broadway, New York
We will exhibit at both New York Shows.

HOW WOULD YOU LIKE
A LITTLE DEVIL LIKE THIS TO HELP YOU DO YOUR CRANKING ?



We Guarantee He'll Do 90% of it
We Are Willing to Send Him On **10 DAYS TRIAL**
And if He Dont Make Good We Will Refund Your Money

EASILY ATTACHED To Dash of your car and connected to intake pipe with copper tubing



THE LOCKWOOD PRIMER PRICE \$5.00

MFGD BY **LOCKWOOD BROS. JACKSON, MICH.**

That New York To Paris Race



THE THOMAS FLYER which beat them all across the country was equipped with a **FEDDERS SQUARE TUBE RADIATOR**. It stood the bumps without injury. It never needed repairs and the car never overheated. But **FEDDERS RADIATORS** are made for just this kind of work, they stand the racket.

"Ask the chauffeur"

FEDDERS MFG. WORKS
BUFFALO, N. Y.

Oilzum Carbonless Cylinder Oil



The Finest Lubricant and Greatest Trouble-saver at present, or likely to be, produced. Name your car and we'll send sample and tell you why OILZUM is OIL-RIGHT.

The WHITE & BAGLEY CO., Mfrs.
WIGNEY & TOMLINSON, Coast Agents, 3626 Mettler St., Los Angeles, Cal. WORCESTER, Mass., U. S. A.

AUTOMOBILE BODIES

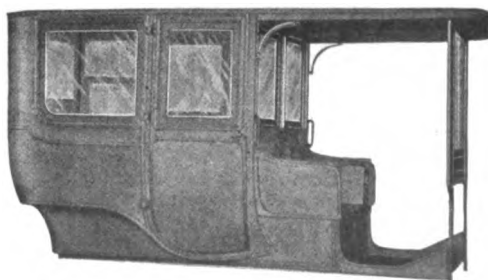

In Both Aluminum and Wood Panels

Limousine, Landauet, Taxicab and Touring Cars in the white or painted and trimmed complete.

Also Automobile Tops

Schubert Bros. Gear Co. 44 Cedar Street ONEIDA, N. Y.



The Stepney Spare Motor Wheel is a device the adoption of which will serve to obviate the tire troubles experienced in motoring.

It is simply a standard clincher steel rim, without hub or spokes, having four clamps (two stationary and two adjustable) for securing it to the rim of the injured wheel.

The Stepney is intended for your Spare Tire to be carried upon it fully inflated and ready for use. Any standard clincher tire can be used.

Write to-day for catalog B.

The SPARE MOTOR WHEEL CO. of America (Ltd.)
236 Michigan Avenue, Chicago

1909] PROMISES TO BE A BIG YEAR. YOU CAN "MAKE GOOD" ON ITS PROMISE WITH

THE GAETH

The best car of its class on the market. A representative line—including seven-passenger Touring Car, Short-Coupled Body, Tourabout and Limousine. \$3,500 the price. Write to-day for agency proposition and ask for a copy of our 1909 catalog, just off the press. Address Dept. A.

The GAETH AUTOMOBILE CO.
CLEVELAND - - - OHIO
MEMBER A. M. C. M. A.



" UNIVERSAL "

DETACHABLE FULL TREAD

YOU NEED IT! HERE IT IS!
The only tread on the market having an ADJUSTABLE TENSION ANCHORAGE.

Unlimited TENSION. Always Adjustable. Our Positive ANCHORAGE ELIMINATES TIRE INJURY. A Real PROTECTOR: ABSOLUTELY NON-SKID AND PUNCTURE PROOF. The SAFE AND SANE PROTECTOR for all road conditions.

Write to-day for Description Circular and prices.

UNIVERSAL TIRE PROTECTOR CO.
ANGOLA, IND.



One of the features of the Grand Central Palace Auto Show, opening in New York City on New Year's eve, will be the exhibit of the famous "MIDLAND MOTOR CAR." For its lightness, its enormous power and speed, the MIDLAND at \$2,250, has few rivals in the American field to-day. Its friends say of it that it's "Made right looks right and stays right."

MIDLAND MOTOR CO., Moline, Ill.

I HAVE A NORTHERN LIMOUSINE which, for the best of reasons, I want to sell quickly.

It is in perfect condition, having been driven less than 500 miles, and I think it's one of the swellest-running, handsomest-appearing town cars made.

Tires are brand new and the varnish isn't damaged—in fact, the car is just as good as new, when it sold for \$2500, and I'll sell it for half—\$1250.

Address, "E. M. M.," 382 Pennsylvania Ave., Detroit, Mich.

\$ 11,000,000

Worth of experience behind the new

\$1,500 Mitchell

This price includes \$300 worth of extra automobile value not included in other cars selling at this price. Learn what it is.

Write to-day for detailed description.

Mitchell Motor Car Co.
539 Mitchell Street, Racine, Wis.
Standard Manufacturers A.M.C.M.A.

ONE QUALITY FOR ALL MODELS
ONE PRICE FOR ALL BUYERS

Stoddard-Dayton

Touring Cars, Roadsters, Runabouts, Limousine, Coupe and Landulet. A Line of American cars that STAND OUT :: Write for '09 Catalog

THE DAYTON MOTOR CAR CO., Dayton, Ohio

THE GARFORD COMPANY, Elyria, Ohio

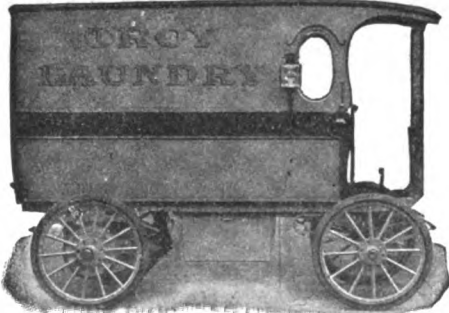

Parts for Power Wagons.

Heavy and Light Electric or Gasoline.

Equipment "L" makes the best Light Electric Delivery yet produced

Sold by THE AMERICAN DISTRIBUTING CO., American Trust Bldg. CLEVELAND, OHIO.



THE PERFECT ELECTRIC COUPE

Perfect in every department—as cozy and luxurious as any woman would have it—as able and efficient as any man would demand it to be.

Nothing is skimped in this car.

It is by far the handsomest coupe on the market to-day.

Write for our catalog describing mechanical features that will at once convince you that it's the soundest and strongest car of its kind in America.

See our exhibits at the New York and Chicago Shows. See if you know of a car half so good.

Any of the following agents will be pleased to demonstrate.

THE RAUCH & LANG CARRIAGE CO.

55 YEARS' EXPERIENCE BUILDING FINE CARRIAGES
 Dept. A, 2180 West 25th Street CLEVELAND, OHIO

CHICAGO, ILL.—C. F. Kimball & Co., 918 Michigan Ave.
 DETROIT, MICH.—Wm. P. Hennessey & Co., 1248 Woodward
 ST. LOUIS, MO.—Tolson Electric Light & Power Co.
 TOLEDO, OHIO—Toside Motor Car Co.
 BAYENSPORT, IOWA—Mason Carriage Co.
 BANGOR, ME.—J. A. Williams, Pembroke Building.
 BRISBANE, PA.—A. H. Murphy, 918 State St.
 OHAMA, NEBR.—J. D. Smith & Co., 110 Fourth Ave.
 PHILADELPHIA, PA.—Burgess Motor Car Company
 LIMA, OHIO—E. E. Rudy
 SAGINAW MOTOR CAR CO.—Buffalo, N. Y.
 LUBERK AUTOMOBILE CO.—Grand Rapids, Mich.
 OKLAHOMA CITY, OKLA.—A. F. Breen

CANTON, OHIO—Dissold Motor Car Co.
 DENVER, COLO.—Colburn Auto Co., 11th and Colfax Ave.
 KANSAS CITY, MO.—Fletcher Carriage, 1st Auto Co.
 BALTIMORE, MD.—Troy's Garage, North and Madison Ave.
 ST. PAUL, MINN.—F. W. Rasmussen, 260 Grand Ave.
 ROCHESTER, N. Y.—Arthur McNeil, South Union and Court
 Sts.
 COLUMBIA, IND.—Goshen Auto Co.
 MARIETTA, OHIO—H. & Co., 215 St. Clair Building.
 SPRINGFIELD, ILL.—H. Mass Assoc. Co., 200 E. Monroe St.
 ATLANTA, GA.—Rich
 CINCINNATI, OHIO—Hershey Motor Car Company.
 ST. WAYNE, IND.—Goshens Automobile Co.
 MUTUAL MOTOR CAR CO.—Pittsburg, Pa.
 AUTO INN—Lathrop, Ind.

THE THOMAS FLYER

CHAMPION STOCK CAR OF THE WORLD

Send 25 cents in stamps to cover cost of mailing and we will send you a beautifully illustrated book on the New York-Paris Race

ADDRESS DEPT. A

E. R. THOMAS MOTOR CO.,
 Buffalo, N. Y. Member A. L. A. M.

THE AMERICAN

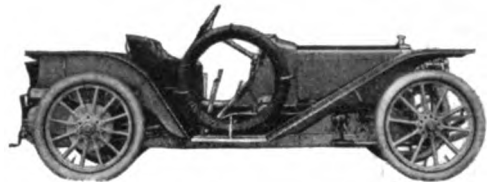

Roadster, Underlung Chassis, Four Cylinder, 50-60 H.P., \$3,750.

It was inevitable that the American line should be the center of interest at the Palace Show—more particularly to those to whom the finest in motor cars appeals. If you were not at the show, you owe it to yourself to get the 1909 literature, and that at once.

AMERICAN MOTOR CAR CO., Indianapolis, Ind.
 Standard Manufacturers A. M. C. M. A.

The Car with the Friction Drive

CARTERCAR



- No gears to strip
- No clutch to slip
- No grease packing
- No noise
- Only one lever

Write for Catalogue

The most simple, practical, all-around serviceable car built for \$1,350
The Cartercar Co., Detroit, Mich.

LONG LIFE IS WHAT EVERY MOTORIST WANTS IN HIS CAR

If it is a



imported ball bearings used wherever practical assure him of this result. Ask owners of Corbin cars how they stand up in every-day use or write for our testimonial booklet.

The Corbin Motor Vehicle Corporation
 New Britain, Conn.

Moline "1909"



INVESTIGATE EARLY

The numerous points of merit comprised in the "Moline" Roadster Model "S." We invite comparison, and it will

be a pleasure to show why you can not afford to overlook a car pleasing in appearance, but doubly attractive in ability and low cost of general up-keep.

MOLINE AUTOMOBILE CO. Member A.M.C.M.A. E. MOLINE, ILL.

Model L. D. 9. 4 cylinder—30 H. P. Roadster \$1,350—Touring Car \$1,500.
 Model D. 9. 4 cylinder—40 H. P. Roadster and Touring Cars \$2,000.
 Model G. 6 cylinder—60 H. P. \$3,000.

KISSEL KLAR

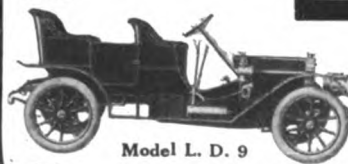

Model L. D. 9

Model L. D. 9. Selective type transmission, Timken roller bearings, 1/2 elliptic springs, floating type rear axle. Remy magneto with single non-vibrating coil and dry cells.

Model D. 9 and G. Remy magneto with single unit coil or Atwater-Kent generator and dry cells.

See our exhibits at New York and Chicago Shows

Write for Catalog

Kissel Motor Car Company, 122 Kissel Ave., Hartford, Wis.

Motoring Satisfaction

with Stearns Cars is Genuine



OUR 30-60 H. P. Model is ideal for those devotees who appreciate abundant reserve power, and a car as nearly perfect as is humanly possible.

Catalog upon request

The F. B. Stearns Co.

Member A. L. A. M.

Cleveland, Ohio

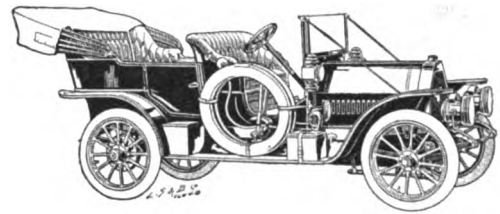

THE "JEWEL 40" TOURING CAR

SPECIFICATIONS

MOTOR	Rutenber. 4 1/2" bore, 5" stroke.
IGNITION	Two independent systems.
MAGNETO	Bosch. Type H. D. h.
COIL	Connecticut.
BATTERY	Exide.
LUBRICATION	Self-contained system.
TRANSMISSION	Selective type.
BEARINGS	Timken
WHEEL BASE	120"
WHEELS	36"
TIRES	4" front, 4 1/2" rear. Any make.
FRAME	Pressed steel.
SPRINGS	Semi-elliptic front, platform rear.
FRONT AXLE	One piece forging, I-section.
REAR AXLE	Full floating clutch driven type.
BRAKES	Two on each rear wheel.
BODY	Seven passenger.
EQUIPMENT	Two gas lamps, two side oil lamps, tail light, Prest-O-Lite Gas Tank, Hartford Shock Absorber, tire irons, trunk rack speedometer and clock.

Write for 1909 Catalog

THE JEWEL MOTOR CAR COMPANY

131 WALNUT STREET, MASSILLON, OHIO, U. S. A.



The Chase Motor Wagon

does the work of two horses at less than the cost of keeping one.

Simplest and Most Practical Engine in the World

two-cycle, air cooled. Not a delivery body with a touring car power plant, but built for business purposes only in a plant that makes nothing but business wagons.

Runs Twelve Miles An Hour—No Faster

You can't speed the Chase Motor Wagon, but it will run twelve miles an hour just as long as there is gasoline in the tank.

10 H.P. \$750.00. 15 H.P. \$900.00

Full particulars cheerfully given on request.

CHASE MOTOR TRUCK CO., 336 S. West St. SYRACUSE, N. Y.

We exhibit at Grand Central Palace Show, New York; also the Chicago Show and the Boston Show

**LOOK!
READ!
\$15.00**

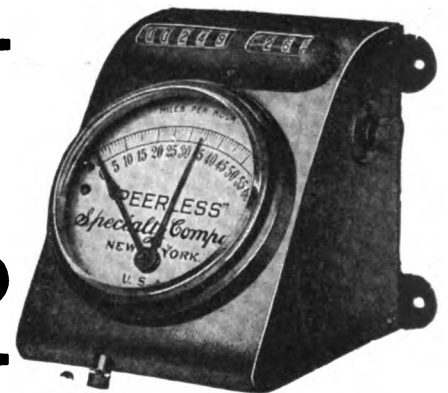

PEERLESS SPEEDODOMETER

with a 3-inch speed dial and hand reading from one to sixty miles. 10,000 season and 100-mile trip odometer complete with everything ready for attaching, \$15.00; with maximum hand, \$18.00.

This EXCEPTIONAL offer for advertising purposes on our regular \$30.00 instrument holds good until May 1st.

We have extended our special offer to above date by request of numerous prospective customers, who have not bought their cars.

PEERLESS SPECIALTY COMPANY

Broadway and 62nd Street,

Department 4
Phone 5091 Columbus

NEW YORK



G & J

THEY LEAD ALL OTHERS

G & J TIRE COMPANY



EVERY AUTOMOBILE AT THE SHOW

Will sooner or later be groomed with Cleanola



Nothing like Cleanola for cleaning and polishing all varnished surfaces. Removes mud stains and rain spots. Covers varnish cracks and scratches. Leaves hard, lustrous surface. Cleanola can be used with equally good results on Leather Tops and Seats. Most perfect cleaning compound for all varnished surfaces and the only one free from alkali or acid. Renews and lengthens life of the varnish.

Used by principal Railroads and Palace Car Companies. **THE CLEANOLA CO.** 25c. can sent as sample for 10c. postage and dealer's name.

Fulton Bldg. Dept. C, Pittsburg, Pa.



WELDING BY ELECTRICITY



INSURES
STRENGTH, ACCURACY AND DEPENDENCE

THE STANDARD WELDING CO. CLEVELAND.

U & H

HIGH TENSION MAGNETOS

J. S. BRETZ COMPANY
Sole Importers
TIMES BUILDING, NEW YORK



Construction of a Gasoline Motor Vehicle

By C. C. BRAMWELL. Contains 150 pages, 6x9; one hundred illustrations and diagrams. Publisher's price, \$2.00; our price, 50 cents. Address Book Department, The Automobile, 231-241 West 39th St., New York.



Empire Tires

WEAR LONGEST

EMPIRE AUTOMOBILE TIRE COMPANY, Trenton, N. J.

Branches—NEWARK—264 Halsey St. DETROIT—842 Woodward Ave. BOSTON—292 Devonshire St. CHICAGO—20 La Salle St.
 1301 Michigan Ave. NEW YORK—73d St. and Broadway, 148 Chambers St. Agencies—PITTSBURG—Consumers' Auto Supply Co. KANSAS
 CITY, MO.—Empire Tire & Rubber Co. ATLANTA, GA.—Dunham Rubber Co. CLEVELAND, O.—Motor Supply Agency Co. NORFOLK, VA.—Wm.
 H. Grover. DENVER, COL.—Denver Auto Goods Co. JACKSONVILLE, FLA.—Savell Rubber Co. PHILADELPHIA, PA.—Penn Auto Supply Co.
 LOS ANGELES, CAL.—Pacific Electrical Works. BUFFALO, N. Y.—Empire Sales Co. MINNEAPOLIS, MINN.—Empire Tire & Rubber Co.
 SAVANNAH, GA.—Harris Tire Co. NEW ORLEANS, LA.—H. A. Testard.

TIRES

IN QUALITY, TRY THEM
INDIANAPOLIS, IND.





1908 Model L—4 cyl. 20 H.P.
\$1500

Pullman Automobiles

We will shortly announced our complete line for 1909.

RUNABOUTS TOURING CAR
TAXICABS LIMOUSINES

See that your name is on our mailing list. Advance catalogs now ready.

York Motor Car Co., York, Pa.



1908 Model K—4 cyl. 30 H.P.
\$2000 including Bosch Magneto

“WHITNEY” CHAINS

KRUPP AUTOMOBILE CRANK SHAFTS, STEEL FORGINGS AND FRAME MEMBERS, GEAR BLANKS. KRUPP BAR STEEL BALL MILLS, TUBE MILLS AND OTHER MACHINERY

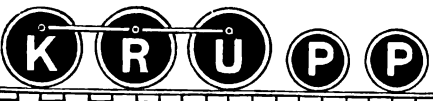

Chrome Nickel Steel, Round Bars in Stock, having Minimum Elastic Limit 95,000 lbs. per square inch. This Steel can be Oil or Case Hardened so as to have an Elastic Limit of over 200,000 lbs.

Use this “Toughest Stuff” and eliminate the Breakages you are now having.

THOMAS PROSSER & SON, 28 Platt Street, New York

CHILLED IRON ROLLS

KRUPP STEEL LOCOMOTIVE TIRES AND CAR WHEEL TIRES, CRANK SHAFTS, STEEL FORGINGS AND CASTINGS, STEEL TIERED CAR WHEELS, PROSSER BOILER TUBE EXPADERN

COL. SPRAGUE'S NEW 1909 AUTO TOPS and FRONTS

OUR NEW 1909 FRONTS

The only front that is imitated and acknowledged the only best.

- Absolutely simple.
- Absolutely strong.
- Absolutely easy to polish.
- Absolutely quiet.
- Absolutely good.
- Absolutely what you want if you desire the best.

Ask for our 1909 Catalogue.

It's an art gem. Inquire about our New Runabout Tops.

**THE SPRAGUE UMBRELLA CO.
NORWALK, OHIO**

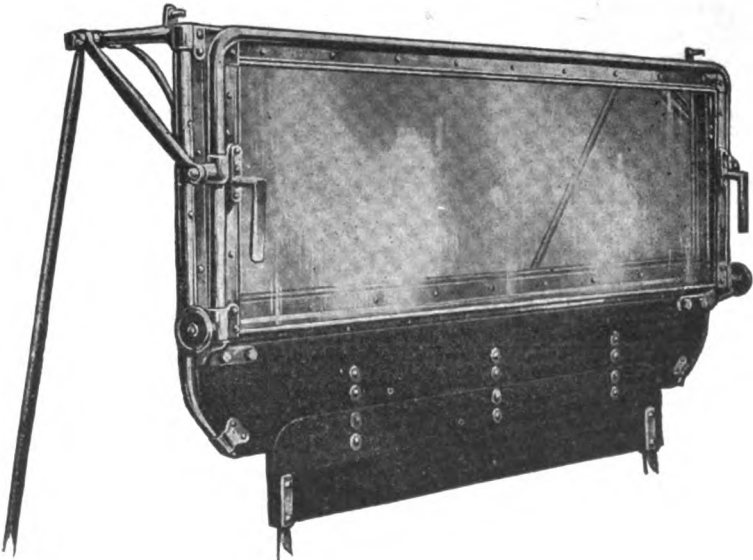



See that **BAR**

ROUND and SMOOTH on the TIRE-SIDE and too heavy to WEAR OUT—

The ONLY DEVICE RELIABLE and DURABLE for 3-inch and 4-inch Solid Tires. The tires may wear down to the rims without altering shape of shoes.

The PERFECTION SKID-PROOF CLIMBER

The PERFECTION is the only device which CANNOT CUT the Tires and WILL NOT WEAR OUT. It is noiseless, effective and indestructible. Write THE PERFECTION NON-SKID CLIMBER CO., EDON, OHIO

"You Screw the Battery In—We've Done the Rest"

PATTERSON WIRELESS DRY BATTERY HOLDER



Steel Battery Box

See our exhibit at Madison Square Garden, January 16 to 23—Space No. 522

ADMITTEDLY the **BEST** Battery Equipment for a Car, BECAUSE

- 1st—No binding posts or wires—setting up or renewal of battery as easy as an incandescent lamp—in fact, done in the same way!
- 2d—Connections can't jar loose! Contacts positive and instantly made. No binding posts or wires.
- 3d—Moulded rubber composition plate over rubber gasket waterproofs batteries absolutely!
- 4th—Automatic bridge in each receptacle permits removal of an exhausted cell without interrupting circuit.

You'll not both r with **Storage Batteries** after you've seen this battery set. It's IDEAL! Each unit renewable even with your gloves on. The **most-talked-of** invention in the electrical field. Send for Bulletin "62"

STANLEY & PATTERSON, 23 Murray St., New York

"Columbia," "Eastern," "Nungesser 1900," "Stackpole," "Red Seal," "Hi-up," "Mesco," and other makes of Batteries now furnished in this "Screw Top" Pattern. Just specify "Screw Top" in place of old Binding Post type of cell.



Mahogany Battery Box

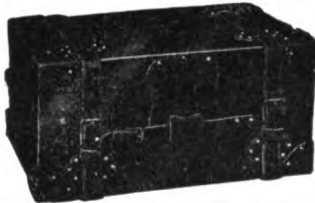

JOHN BOYLE TRUNKS

THE SUPERLATIVE IN AUTO TRUNK CONSTRUCTION

Each of the wide range of models is a masterpiece of **Quality—Style—Refinement—Lightness—Strength—Compactness—Capaciousness—Accessibility, and Absolutely Weather and Dust Proof.**

A good car deserves good equipage—why not get the **BEST**—the **JOHN BOYLE MAKE**—and secure lasting satisfaction.

JOHN BOYLE & CO., 112-114 Duane St., 70-72 Reade St., New York

Write for Style Book and Prices for the Various Makes of Cars

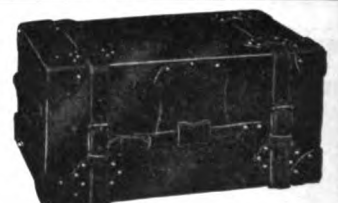

SUPPLEMENTARY SPIRAL SPRINGS



the greatest device in the world for saving your automobile. Applicable to all cars—efficient on all. The only practical cure for hard riding cars, relieving the body of all injurious shocks, jolts and jars. No more broken side springs. Fully patented and fully guaranteed. They will save their cost many times in a year and will add **NEW LUXURY, NEW LIFE, NEW SPEED, NEW COMFORT.**

THE PRICE—is about one-half that asked for complicated devices that at best can produce temporary results only. Write for full information and prices. BEWARE OF IMITATIONS.

SUPPLEMENTARY SPIRAL SPRING CO., 4520 Delmar Ave., ST. LOUIS, MO., New York Motor Mart Building. Branches: New York, Motor Mart Bldg., 1876 Broadway. Chicago, 1218-20 Michigan Ave. Boston, 880 Boylston St. Pacific Coast, Los Angeles, San Francisco.



LOCKE & COMPANY AUTOMOBILE BODIES

218-220 WEST 84th ST.,
NEW YORK

WITHOUT PARALLEL IN THIS COUNTRY OR ABROAD
COMBINE EXTREME ELEGANCE, MOST REFINED
DESIGNS AND UNEXCELLED DURABILITY

Chadwick
GREAT SIX

THE FASTEST STOCK CAR IN THE WORLD

It will instantly appeal to those requiring the VERY BEST

Six Cylinders, 5" bore, 6" stroke. Weight, exactly 3250 lbs.
For 1909—60 H.P., price, \$5,500 f.o.b. factory.

CHADWICK ENGINEERING WORKS

Pottstown, Pa.

"Standard Manufacturers A. M. C. M. A."

Three-Ton
Truck.
40 H.P.

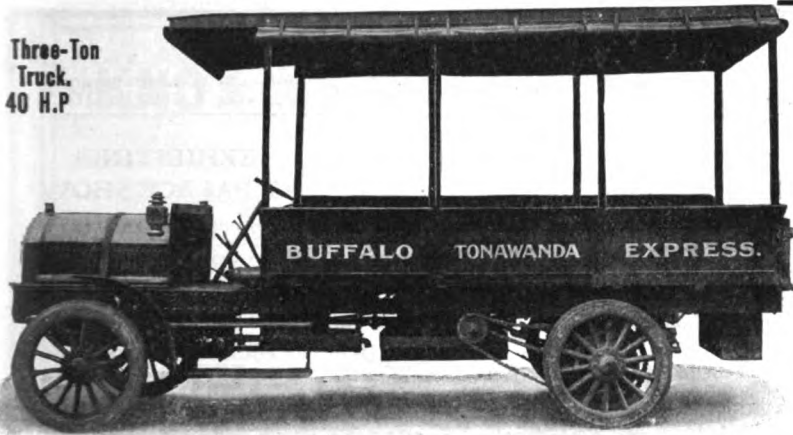

Gasoline **TRUCKS** Electric

We manufacture both electric and gasoline trucks in all capacities, from a light delivery car to a five-ton truck. Let us meet your requirements, as we are the oldest manufacturers in America.

Write for catalog and prices.

The Auto-Car Equipment Company

77 Edward Street, Buffalo, N. Y.

WHITLOCK
INTAKE, EXHAUST
Whitlock Coil Pipe Co.

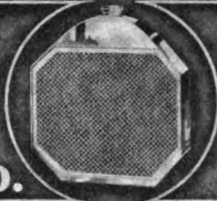

RADIATORS
AND WATER PIPES
Hartford, Conn.

The **MCCUE CAR**

Grand Central Palace Show, Dec. 31-Jan. 7



Petrel

CARBURETER

is absolutely the only one on the market to-day that maintains a uniform mixture in the

COLDEST WEATHER

Send for full particulars and proof of our claim

THE PETRE CARBURETER CO.
CLEVELAND, OHIO

High-grade cars need high-grade carbureters.
DEALERS — Don't fuss with any others.

PETREL
"6"
\$2500

Will Not Be at
New York Shows

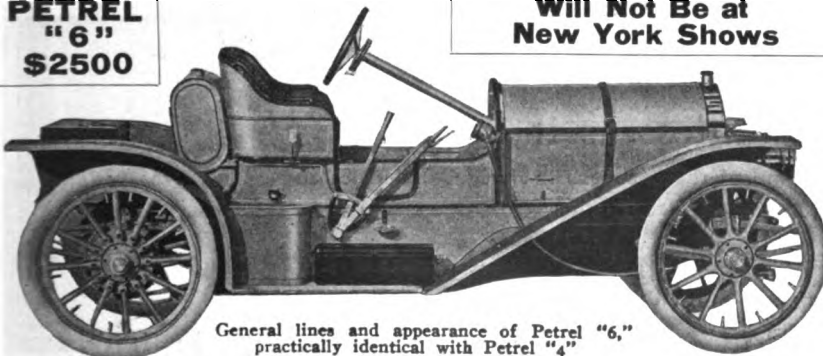

General lines and appearance of Petrel "6," practically identical with Petrel "4"

PETREL

Specifications

Petrel "4" Roadster, \$1350	Frame . . . Pressed Steel
Motor 4-cylinder	Tires 32 x 3 1-2
4 3-8 x 4 3-4	Wheel Base . 106 inches
Ignition Battery	Weight, 1800 pounds,
Drive, Waite Friction	60 pounds per horsepower
Double Chain	

PETREL MOTOR CAR CO.

KENOSHA, WISCONSIN

AGENTS WANTED WHERE NOT REPRESENTED

1909 MODELS include 48 H. P. Racers, Runabouts, Touring Cars & Limousines

MEDOWBROOK
MODEL

Winner of the \$1000
Cash Prize—Opening
of Vanderbilt Course

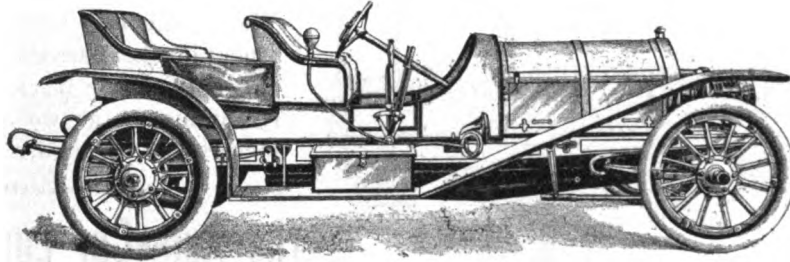

EXHIBITING
AT PALACE SHOW
17-22 H. P. TOWN
CARS \$3200.00
TAXICABS COMPLETE AND
CHASSIS
THE LARGEST AND BEST
EQUIPPED FACTORY IN
THE WORLD

Allen Kingston Motor Car Co., 3 WEST 44th STREET NEW YORK WALTER C. ALLEN, President

New England Agency
887 Boylston Street, Boston, Mass.

The 1909 ROYAL TOURIST

Speedier, longer, roomier, stronger, easier riding and more readily accessible, the Model "M" is without doubt the most permanent car in every particular that has yet been presented to the motor world.

The Royal Tourist Car Company, Cleveland, Ohio

THE TEST OF SERVICE IS ALL WE DEMAND

MEMBERS OF A. L. A. M.

The
1909

National

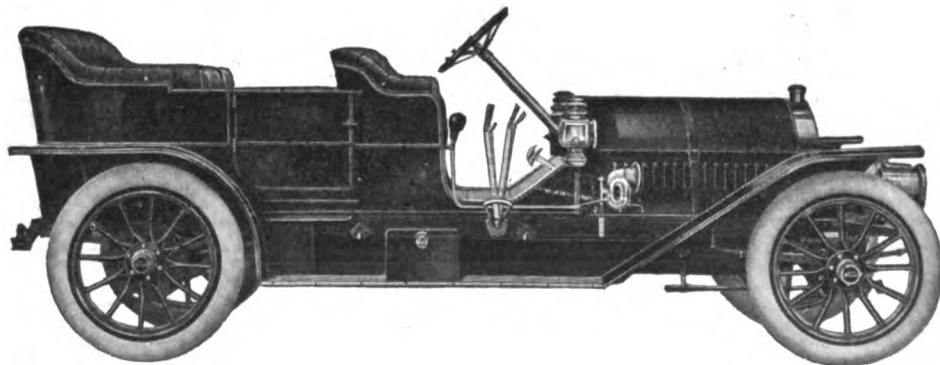

"Just as Faultless as it Looks"

Four Models, "Fours" and "Sixes," all of them superb in design, construction and service

Model "9-35".....Four Cylinders, 41x41.....\$2,750	Model "9-50".....Six Cylinders, 41x41.....\$4,200
Model "9-40".....Four Cylinders, 5 x5\$3,700	Model "9-60".....Six Cylinders, 5 x5\$5,000

Type of body is optional—Touring, Roadster, Limousine or Baby Tonneau

We have the best proposition for dealers with a high-class trade

National Motor Vehicle Co., 1000 East 22d St., Indianapolis, Ind.

Standard Mfrs. A. M. C. M. A

KNOX WEIGHT PROPORTIONATE TO HORSEPOWER

The proper weight in proportion to the power is a point very carefully considered by the motor car manufacturer. Any maker can build cars with this point in mind, but to build one that will withstand hard use and still be comparatively light requires the careful working out of all parts so that continued shocks and strains will prove their ability to stand hard service.

In designing Models "M" and "O" we have used our best endeavors to keep the weight as low as is consistent, and the following table will prove that we are considerably under the average maker when size and rated horsepower are taken into consideration:

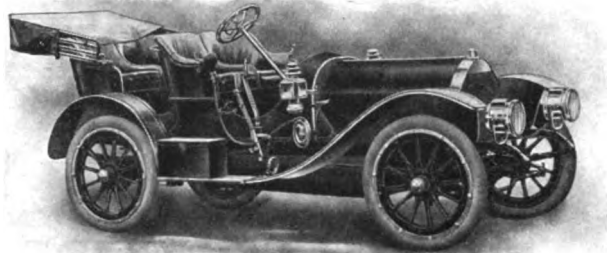

Knox Model "O" 38 H. P. Roadster. Weight, 2650 lbs., or 69.6 lbs. per Horsepower.

Model.	Weight as catalogued.	Rated power A. L. A. M. formula.	Pounds per rated H.P.
"O" Touring Car.....	2,850 lbs.	38.025	74.9
"O" Roadster.....	2,650 lbs.	38.025	69.6
"O" Tonneauette.....	2,800 lbs.	38.025	73.65
"O" Limousine.....	3,000 lbs.	38.025	78.9
"M" Touring Car.....	3,850 lbs.	55.	70.
"M" Limousine.....	4,350 lbs.	55.	79.
"M" Roadster.....	3,200 lbs.	55.	58.

Knox ability to win contests has been fully demonstrated in contests of 1908, and their ability to win customers is being proved daily.

Mr. Dealer: The cars having the most good qualities are the easiest as well as the best to sell.

Good representatives wanted in open territory. We will show at Madison Square Garden Show, Space 1, and Chicago Show, Space ... Write for catalogue and information.

Knox Automobile Company, Springfield, Mass.

Member A. L. A. M.

TWO-IN-ONE

NEW DEPARTURE TWO-IN-ONE BALL BEARING

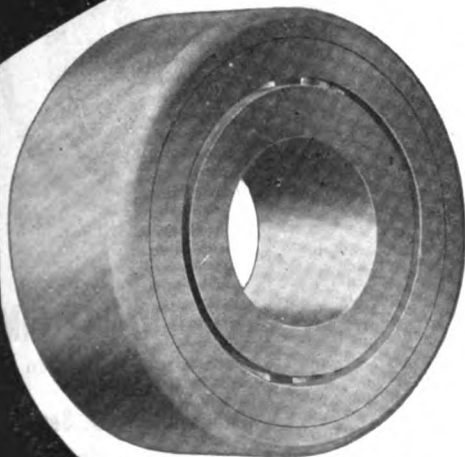

The only bearing that is **equally strong in all directions.**

The only bearing that will take thrust from any direction, or radial load or combination thrust and radial load.

Positively Economizes Space, Weight, Labor, Material, Cost.

FULLY GUARANTEED

All inquiries fully answered. Write

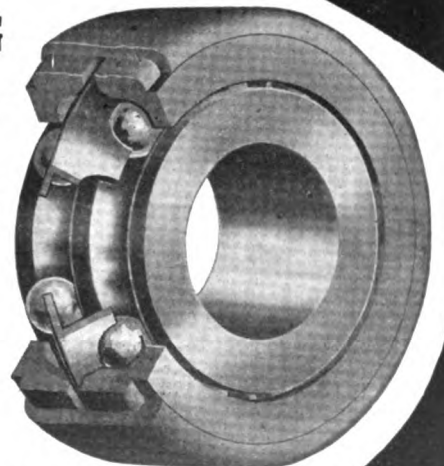

The New Departure Manufacturing Co.
BRISTOL, CONN.

We will exhibit at Grand Central Palace Show, New York, Space 407, Section J, third floor; also at Madison Square Garden Show.

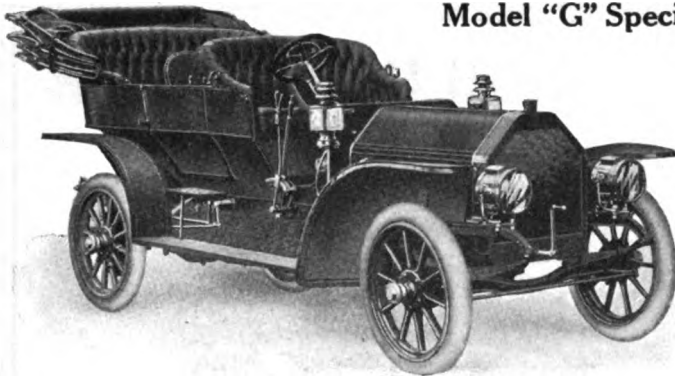

Model "G" Special

Glide

\$2500

You Know Automobiles

READ THESE GLIDE SPECIFICATIONS

THE Glide is the first car perfect in size, in mechanism and in action that has ever been offered to the public at a correct price.

Many years of automobile building are back of every Glide—years of fruitful experience that have added to the merits and popularity of GLIDE cars.

The power plant is a 4-cylinder (cast separately) 45 actual H.P. motor. The crank shaft has 5 bearings—as it should have.

A constant level oiling system, eliminating piping and automatically maintaining the proper level of oil in the crank case at all times.

An improved form of selective type of transmission, located just forward of the rear axle, reducing the angularity of the propeller shaft.

A rear axle with liberally proportioned parts, and of a construction that gives an absolute assurance of perfect work.

A multiple disc clutch with discs of large diameter.

Double set of brakes—internal expanding and external contracting. Brake drums are 16 inches diameter, 3-inch face—will hold the car on a mountain grade. Absolute confidence in ability to slow down or halt at will is established when Glide brake equipment is examined. No brake system on any American or Foreign car has ever before been so comprehensively treated.

One Universal Joint only in GLIDE cars, located between the motor and the

Glide Roadster Model "R"—same chassis—Wheel base—36 x 4-inch tires all around, with either close coupled body seating 4, or Runabout body seating 2—\$2,000.

Glide cars will be exhibited at the Chicago Show. Floor space H-I, immediately at the right of the main entrance—Wabash Ave.

The Bartholomew Co., Standard Manufacturers A. M. C. M. A. 235 Glide St., Peoria, Ill.

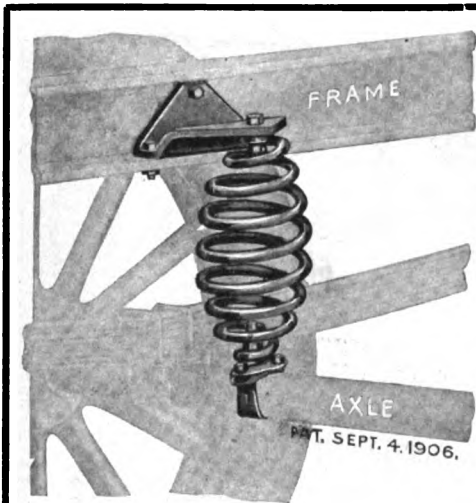

YOU'VE TRIED THE REST, NOW TRY THE BEST

- "We are entirely satisfied with them." **Elmore Mfg. Co.**
- "The 'Sager Device' presents advantages not found in other so called 'Shock Absorbers'." **Olds Motor Works.**
- "They add greatly to comfort and reliability." **Crawford Automobile Co.**
- "We find them indispensable." **Logan Construction Co.**
- "Our customers are more than satisfied with them." **Dorris Motor Car Co.**
- "Have given us very excellent satisfaction." **Thomas B. Jeffrey Co. (Rambler.)**
- "In the last three years we have used quantities of your springs, which have given excellent satisfaction." **Dayton Motor Car Co. (Stoddard-Dayton.)**
- "Used your springs with splendid success." **The Autocar Co.**
- "We claim 1908 will be a Sager year." **Meteor Automobile Works.**
- "A great benefit and we cannot speak too highly of them." **The Forest City Motor Car Co. (Jewel.)**
- "Give perfect satisfaction." **Evansville Automobile Co. (Gearless Automobile.)**
- "We found your springs to be satisfactory." **Pope Mfg. Co.**

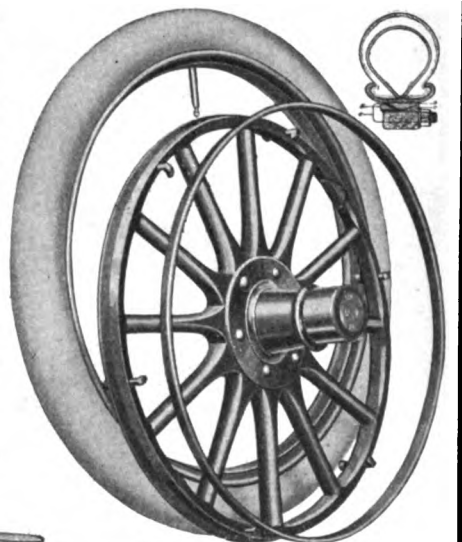

Pat. Appl'd For.

THE DEMOUNTABLE RIM

that you have been waiting for. Detached in 30 Seconds

See US at the Shows or write for particulars.

267 South Avenue ROCHESTER, N. Y.

PROTECTION BUMPER

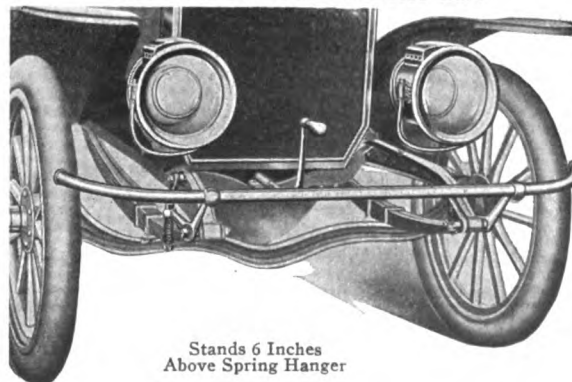

Stands 6 Inches Above Spring Hanger

Protects Lamps, Radiator and Tires. Easily attached to any Car.

Two Styles - Plain Black or Polished Brass.

Write to day for full particulars

SAGER EQUALIZERS

Over 35,000 in Use

18 Leading Makers Endorse Them. You will too if you try them.

J. H. Sager Co.

The New Stevens-Duryea Models XXX and Y

are typical Stevens-Duryea productions

The latest links in the chain of STEVENS-DURYEA SUCCESSES.

The XXX—A 24 Horse Power Four Cylinder Runabout - - - **Price, \$2,850**
The Y—A 6-40 Horse Power Six Cylinder Touring Car - - - **Price, \$4,000**

The Four Cylinder Model X, of the past season, and Six Cylinder Model U (Light Six) of the past two seasons, will also be 1909 STEVENS-DURYEA CARS.

On exhibition at 1909 Licensed Association Auto. Shows.

Write for Descriptive Literature.

Stevens-Duryea Company

900 Main Street

CHICOPEE FALLS, MASS.

Members Association Licensed Automobile Manufacturers

THE MARMON

"A Mechanical Masterpiece"



Marmon "Thirty-Two"
\$2400

This Car Represents Economy — Not Cheapness

Over and above the fact that this is a car that will live, that you can depend upon and be proud to own—

It is a car offering a positive, proven value which you can get right down to brass tacks and figure out.

Figure up its equipment, note that its design includes all the best things in motordom, take into consideration Marmon workmanship, materials and construction methods, and then compare it with anything on wheels at \$3,000 or less. Send for the detailed specifications.

Genuine Krupp and Chrome Nickel steels used for important parts. Bosch magneto and battery—dual system. Hess-Bright ball-bearings. Transmission and rear axle in one unit. Large brakes. Marmon oiling system. Weight, 2100 lbs. 32-40 H. P. Tires, 34x4, all around. Complete equipment. Touring Car, Roadster, Four-Passenger Suburban, Coupe, or Limousine Town Car.

The superb Marmon "Fifty" (Seven-Passenger Body), \$3750

Nordyke & Marmon Co. (Established 1851) Indianapolis, Ind.
Standard Mfrs. A. M. C. M. A.

At Chicago Show, February 6-13

The Easiest Riding Car In The World

OUR FACILITIES FOR MAKING

DROP FORGED

PRESSED STEEL

HAMMER FORGED

MACHINED and GROUND

Crank Shafts
Connecting Rods
Control Levers
Gear Blanks
Frames
Radius Rods
Rear Axle Housing
Small Parts
Crank
Front Axles

Parts of All
Descriptions

insure our customers against loss of material in process, also prevent delays.
We cordially invite an inspection of our works.

DRIGGS-SEABURY ORDNANCE CORPORATION, Sharon, Pa.

Send blueprints or sketches for quotation

THE NATIONAL SHOW CHICAGO

will be held as usual at

Under the auspices of the NATIONAL ASSOCIATION
OF AUTOMOBILE MANUFACTURERS, INC.

February 6 to 13

in the COLISEUM AND FIRST REGIMENT ARMORY, with all the
leading makers of Motor Cars, Motor Cycles and Accessories as exhibitors.

THE USUAL COURTESIES WILL BE EXTENDED TO VISITING AGENTS

S. A. MILES, Manager, 7 East 42d Street, New York

All the Manufacturers in One Show

AT THE PALACE SHOW: Their advance into third place in tire equipment by a wide margin is merely an incident in the

GROWING PRESTIGE

OF

“Firestone”

TIRES

It again emphasizes the trend of public preference away from the ordinary popular priced tires in favor of the best possible tire service.

**In the commercial vehicle section
Firestone Side-wire Tires as usual
led the nearest competitor three to
one.**

FIRESTONE TIRE & RUBBER COMPANY, AKRON, OHIO

Branches and Agencies almost everywhere.

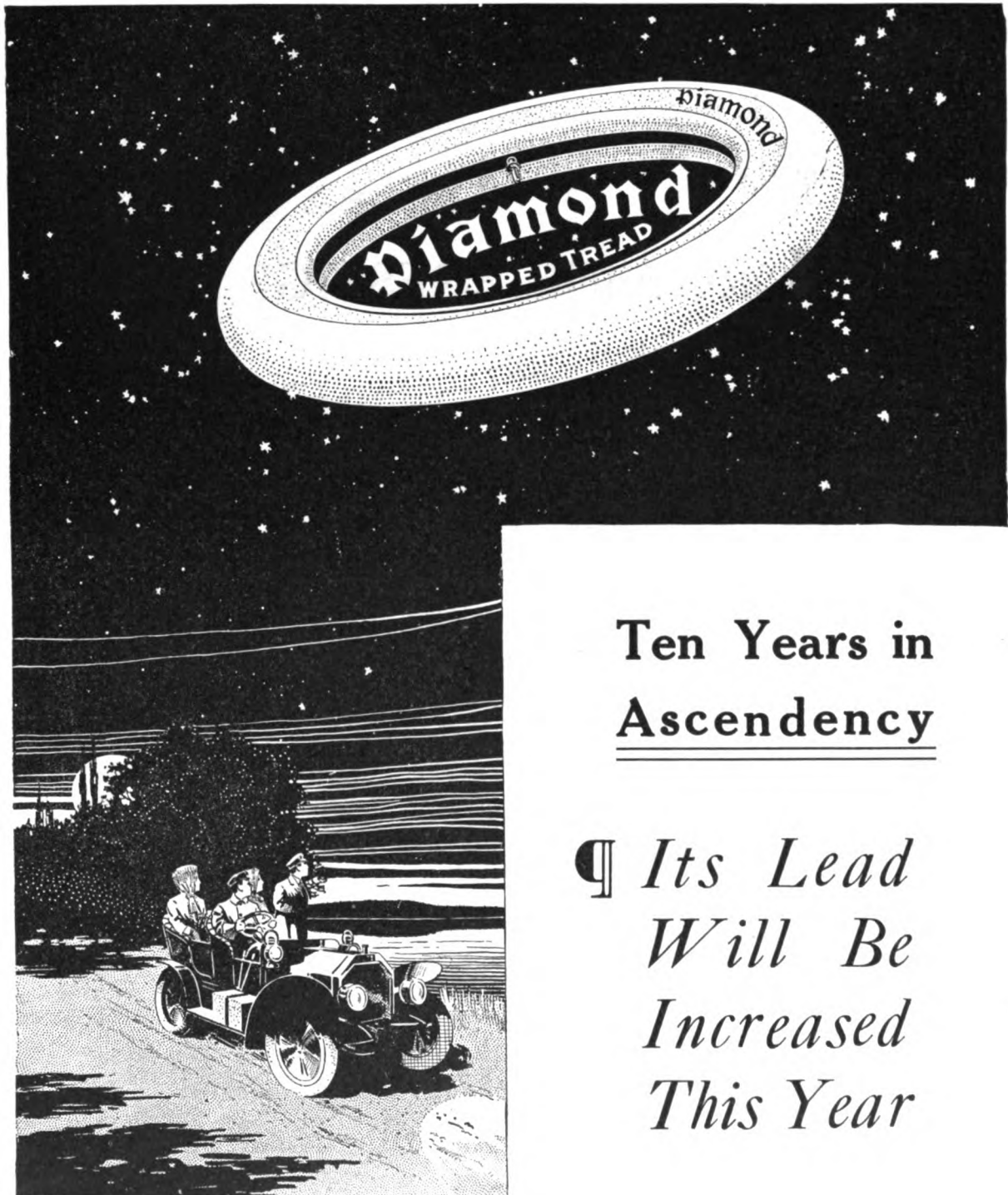

Ten Years in
Ascendency

¶ *Its Lead
Will Be
Increased
This Year*

The Diamond Rubber Co.

Akron, O.

Adjust the Mixture while you drive

by Using the Holley Model W Carburetor with Dashboard Adjustment

Changes in fuel density—changes in temperature and humidity of the air—and many slighter influences affect the quality of the mixture.

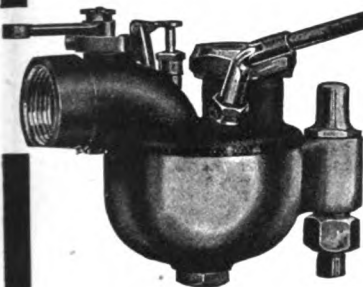

Adjusting the carburetor correctly with the car standing still and the motor running light is next to impossible; you do not get road conditions. If the carburetor has three or four adjustments, like most automatic carburetors, your way is doubly obscure; you are not sure which adjustment to change, and you are not sure whether an apparent gain in power will hold good on the road.

Because of the lack of certainty in multiple-adjustment carburetors, the fine day-to-day regulation which keeps the motor always working at concert pitch is generally neglected; an average adjustment is adopted, and is never or seldom changed.

The owner of a *Holley Model W* adjusts it *while he drives*, in an instant and without guesswork. A universal joint on the needle valve connects to a rod running through the dashboard. At the end of the rod is a graduated dial and lever. You can adjust for a cold start, for warming up, for a sudden shower, for a change in fuel density, for a bad hill or stretch of sand—for any special condition, no matter how sudden. There is but one thing to touch, and it is always under control. If dirt lodges in the needle orifice, you can momentarily open the needle and return it to the same setting, thus washing out the dirt—all while the car is running. And the gasoline you save in a season or two will pay for the carburetor.

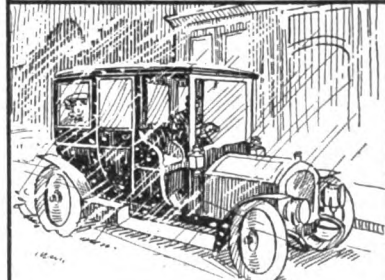
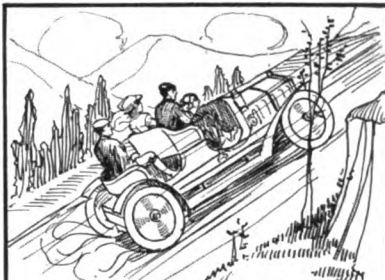

Regular Top or Side Outlet Models		With Universal Joint and Dial Adjustment— Top or Side Outlet	
2 1/2".....	\$7.50	3".....	\$10.50
1 3/4".....	7.50	1 3/4".....	10.50
1 1/2".....	8.00	1 1/2".....	11.00
1 1/4".....	9.00	1 1/4".....	12.00

HOLLEY BROTHERS CO., Detroit, Mich.

SELLING AGENTS
 New York City: New York Sporting Goods Co., 17 Warren Street
 Pacific Coast: San Francisco, Calif., Geo. P. Moore & Co.; Los Angeles, Calif., Geo. P. Moore & Co.;
 Oakland, Calif., Geo. P. Moore & Co.
 New England: Hartford, Conn., Post & Lester Co.; Boston, Mass., Post & Lester Co.

Common Sense About Auto Jacks

In advertising RELIABLE JACKS we don't ask you to take our word for anything. Not that our word isn't good, for it is, but we know that your judgment is more to you than our word.

We could tell you that the RELIABLE is the best automobile jack made, but we prefer to show you how it works and let you decide that for yourself. If you consider it from a wholly unprejudiced standpoint, there can be but one decision. We are willing to rest our case on your decision.

See for yourself the features upon which we lay our claims for the superiority of RELIABLE JACKS

Swivel top permits setting in any position most convenient to operate. Concave, holds axles, etc., firmly, without possibility of slipping off or marring paint. Compact top and screw have required strength and stability without interfering with trusses, bolts, spring seats, or any other points adjacent to desired point of lift.

This little latch is held in place by a light spring; raises and lowers automatically. Reversed by a touch.

Long handle gives great leverage; little strength required. Easy up and down movement. Lifts on the down stroke, giving the advantage of the operator's weight. Smooth and with rounded corners makes it easy on the hands.

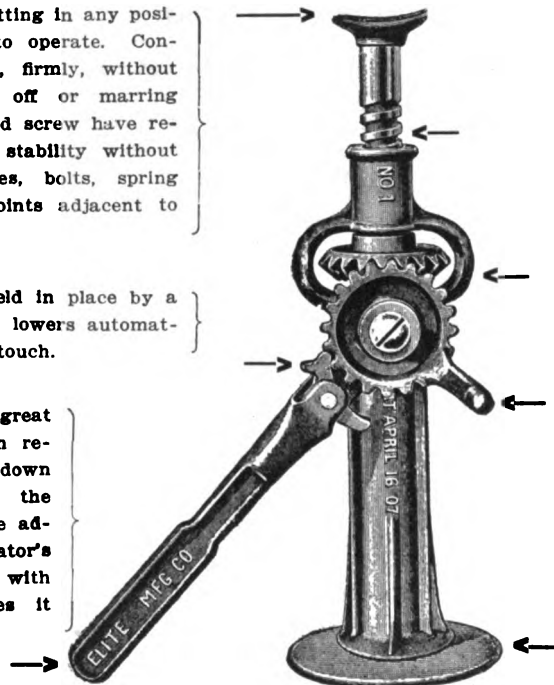

Large screw of special steel, carefully machined, works smoothly; gives straight, steady lift of unusual height.

These gears merely turn the screw, which in turn raises the load. Much easier than to lift direct as in rack and pawl jacks. Holds at any point without danger of slipping down.

This crank adjusts the screw up or down to the desired height, quickly, without pumping, and without soiling the hands on cogs or other parts.

Large flat base gives stability, lessens liability of car tipping or rolling off, and does not sink into soft earth so readily under weight.

Reliable Jacks

Six models—2 to 10 tons capacity. For Autos, High Wheeled Vehicles, Traction Engines, Street Cars, Etc.

THE JACK ILLUSTRATED ABOVE IS THE RELIABLE NO. 1, MADE IN TWO SIZES—2 AND 3 TONS CAPACITY, RESPECTIVELY. THE RELIABLE LINE ALSO INCLUDES FOUR OTHER MODELS WITH CAPACITIES FROM 2 TONS TO 10 TONS. THESE OTHER MODELS ALL HAVE THE SAME GENERAL FEATURES OF SUPERIORITY AS MODEL NO. 1, BUT VARY IN SIZE AND IN SUCH POINTS AS MUST NECESSARILY BE CHANGED FOR DIFFERENT KINDS OF SERVICE.

THERE IS A RELIABLE JACK BUILT FOR EVERY KIND OF JACK USE. IF YOU NEED ANY KIND OF A JACK, A RELIABLE IS WHAT YOU ARE LOOKING FOR. IF YOU ARE USING AND KIND OF A JACK, SEE THE RELIABLE, AND YOU'LL THROW THE OTHER AWAY.

SEE THE RELIABLE AT THE AUTOMOBILE SHOWS; ASK YOUR SUPPLY DEALER TO SHOW YOU ONE; WRITE US FOR LITERATURE DESCRIBING THE RELIABLE JACKS AND A SOUVENIR HANGER SHOWING THE CARS WITH WHICH THE RELIABLE IS REGULAR EQUIPMENT.

IF YOU ARE BUYING A NEW CAR INSIST THAT YOUR DEALER EQUIP IT WITH THE RELIABLE JACK YOU WANT.

THE ELITE MANUFACTURING COMPANY
ASHLAND, OHIO

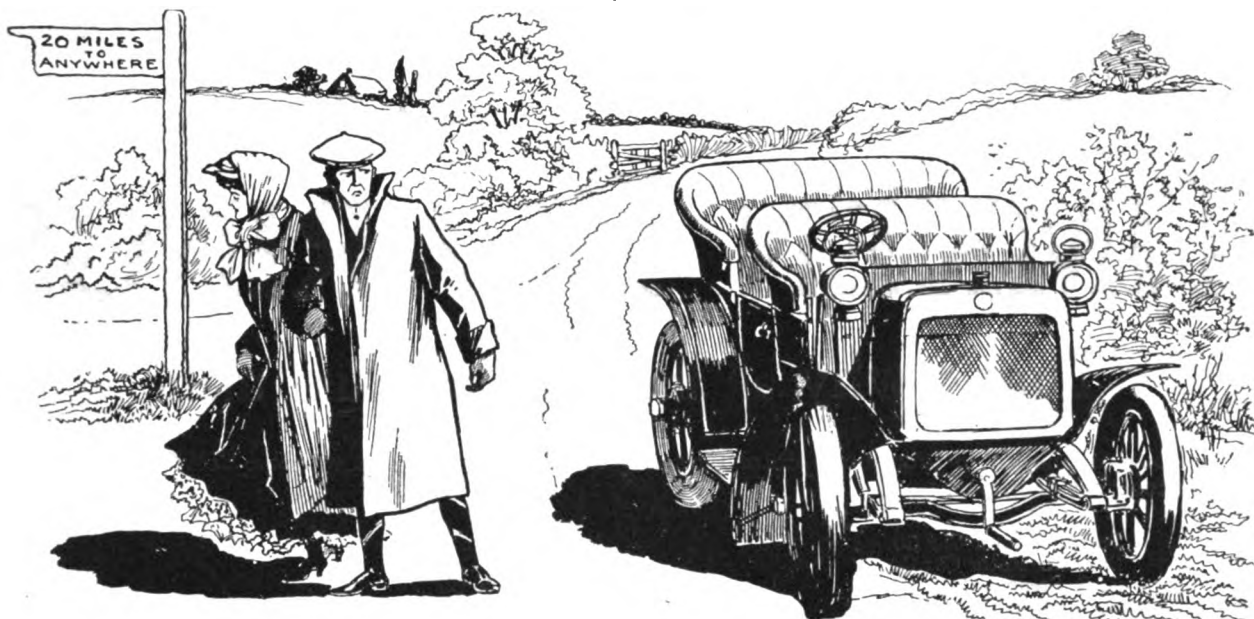

Get a Magneto You Can Depend on

The Wheeler & Schebler MAGNETO

Never Fails—Dependable Always

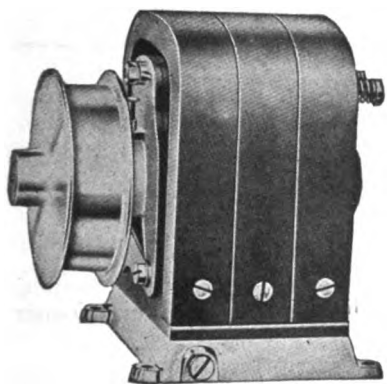

Side View

The greatest invention of the age for automobilists. Its use gives you positive assurance that all your ignition troubles are over.

You never know when you are going to have a breakdown with the old battery system; it's liable to happen any time—anywhere—in town or on tour—but when it does, that's when you appreciate the value of the dependable "Wheeler & Schebler" Magneto.

Why Take Chances When Certainty Is at Hand?

Equip your cars with "W & S" Magneto and you have absolutely the best, most perfect and economical system.

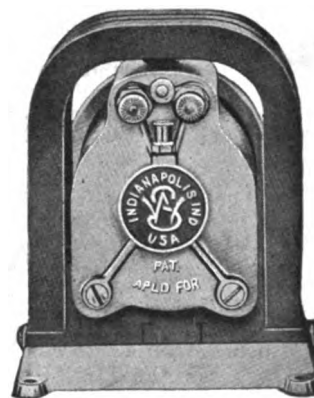

End View

The only wearing parts are a pair of imported annular Ball Bearings, we having done away with the commutator and brushes common on other makes. It has no wound rotators to burn out. It requires no governor, thus avoiding any trouble to which that part would be subject. It furnishes alternating current, making it impossible to burn out the coil. It does not pitt nor wear away the vibrator points. It is the only magneto which will give sparks each revolution at the shaft. It increases the power at the engine from ten to twenty per cent. over batteries.

Price \$35

It excels any ignition system on the market to-day, and we can prove it. WRITE TO-DAY.

WHEELER & SCHEBLER

MANUFACTURERS
INDIANAPOLIS, IND.

EVERY CAR runs "GOOD" on

TIMKEN BEARINGS

That's why all the good cars use them

Look at this list of prominent Motor Cars and Transmission Makers who use **TIMKEN BEARINGS** either altogether or in part.

Peerless Motor Car Co.
Packard Motor Car Co.
F. B. Stearns Co.
Locomobile Co. of America.
E. R. Thomas Motor Co.
Winton Motor Carriage Co.
Lozier Motor Co.
Royal Motor Car Co.
Apperson Bros. Auto. Co.
Austin Auto. Co.
Matheson Motor Car Co.
Olds Motor Works.
Dayton Motor Car Co.
Chalmers-Detroit Motor Co.
Pope Mfg. Co.
Haynes Auto. Co.
H. H. Franklin Mfg. Co.
Premier Motor Mfg. Co.
Electric Vehicle Co.
Nordyke & Marmon Co.
Buick Motor Co.
Dorris Motor Car Co.
Autocar Co.
York Motor Car Co.
Kissel Motor Car Co.
Bartholomew Co.
Acme Motor Car Co.
Speedwell Motor Car Co.
Forest City Motor Car Co.

Colburn Auto. Co.
Atlas Motor Car Co.
Auto Vehicle Co.
Buckeye Mfg. Co.
Bloomstrom Mfg. Co.
Duro Car Mfg. Co.
E. M. F. Co.
Grout Auto. Co.
Hewitt Motor Co.
T. B. Jeffrey & Co.
Oscar Lear Auto. Co.
Midland Motor Co.
Moline Auto. Co.
Marion Motor Car Co.
Mason Motor Car Co.
Smith Auto. Co.
Selden Motor Vehicle
Velie Motor Vehicle Co.
H. E. Wilcox Motor Co.
And many others.

ELECTRICS.

Anderson Electric Co.
Columbus Buggy Co.
Rauch & Lang Carriage Co.
Waverly Co.
C. P. Kimball & Co.
And many others.

There could be no more conclusive proof of merit than this practical endorsement.

ONCE A TIMKEN USER ALWAYS A TIMKEN USER

There's a reason.—Every Manufacturer knows it. Every Dealer should know it. Every Owner will insist on **TIMKEN BEARINGS** if they know it.

See the **TIMKEN EXHIBIT** at the Shows or write direct for illustrated descriptive matter.

We will exhibit—

Grand Central Palace, Dec. 31st-Jan. 7th.
Madison Square Garden, Jan. 16th-Jan. 23rd.
Chicago, Feb. 6th-Feb. 13th.

THE TIMKEN ROLLER BEARING AXLE CO.

CANTON, OHIO

BRANCHES

NEW YORK: 10 East 31st Street

CHICAGO: 429 Wabash Avenue

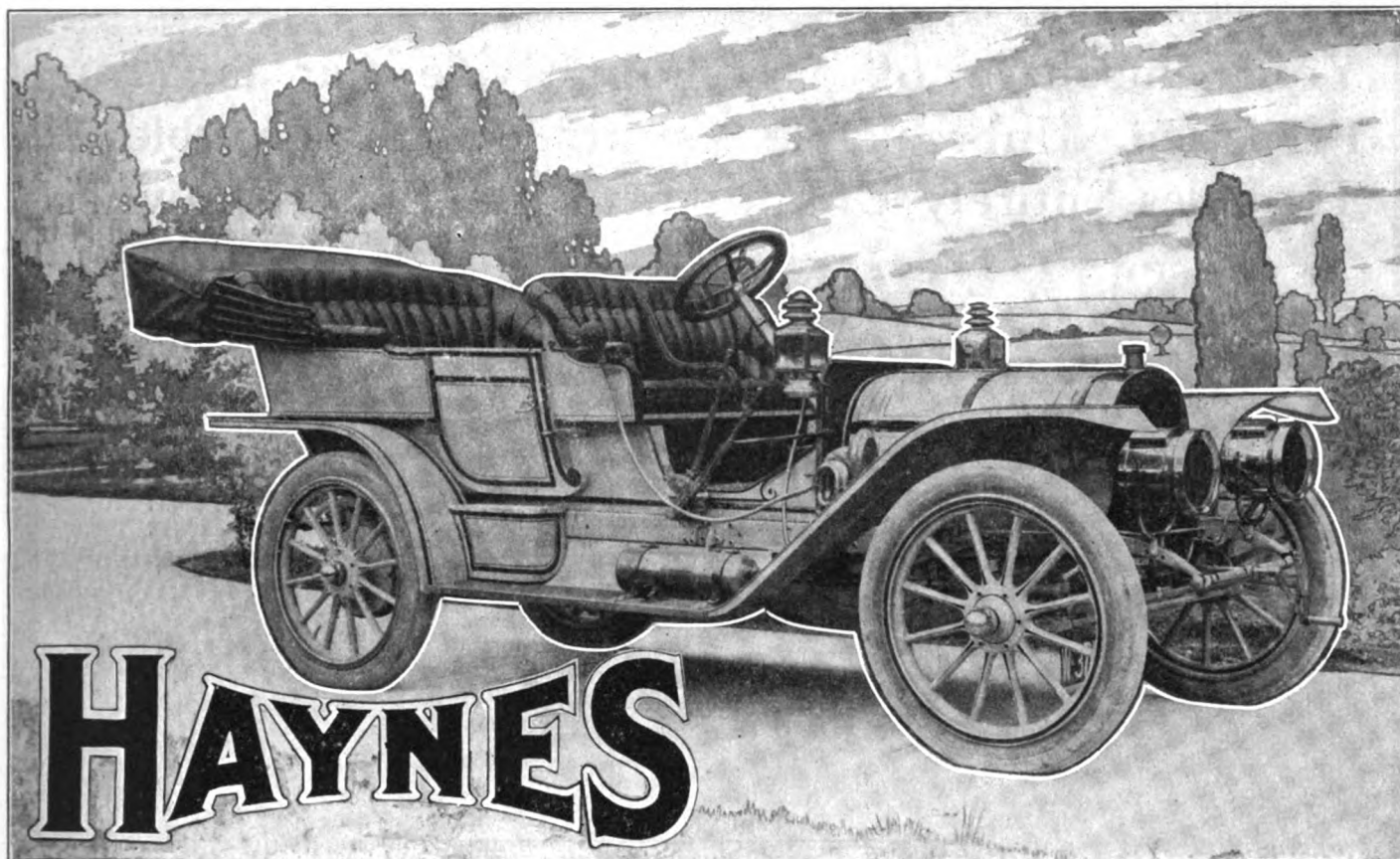

The Haynes for 1909—40 H P., \$3,000

The Car to Buy—And Why

Haynes Cars are built for strength. We use more different kinds of steel alloy than any other makers. We spend more money for the services of expert metallurgists. Everything about the Haynes is *big, solid, substantial*.

The results show in Reliability Runs. "The Haynes always makes a perfect score." Last year it won the only perfect score that was awarded in the big Chicago Motor Club Run. This year there were two Haynes entries. They both were among the five that won Perfect Scores.

We have been making cars since 1893. We sin-

cerely believe that our experts (who have been with us from the beginning) know more about making automobiles that run than any other makers. The results prove it.

The loyalty of Haynes owners to us is a big asset to an agent. Some of our friends who started automobiling in the nineties, when we were lone pioneers in the industry, are now owners of a fifth or sixth generation of Haynes Cars. We have an established clientele all over the country.

We want to place a few more good, hustling agencies. Write for particulars.

HAYNES AUTOMOBILE CO., Kokomo, Indiana

Oldest Automobile Manufacturers in America

NEW YORK, 1715 Broadway

42 Highest Awards and Perfect Scores

Members A. L. A. M.
CHICAGO, 1702 Michigan Ave

Your Purchase of Any Four-Cycle Car Is Your Perpetual, Unbreakable Contract with Troubles—Troubles Entirely Unknown to the Elmore Owner

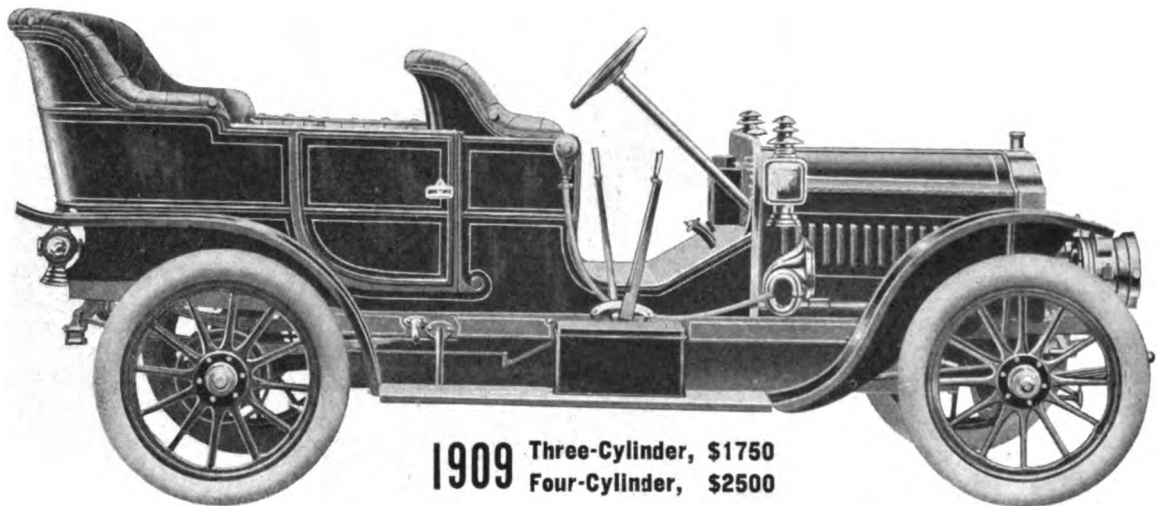

1909 Three-Cylinder, \$1750
Four-Cylinder, \$2500

Right now you are most likely considering the purchase of some four-cycle car.

The question that vexes most is whether it shall be one with a four-cylinder or a six-cylinder engine.

But that which seems so important to you shrivels to insignificance before the greater question of four-cycle or two-cycle.

For on the latter—**entirely** on the latter—depends your future satisfaction with the car you buy.

Yes, the very life of the car itself is prematurely shortened, or indefinitely prolonged, by the principle of its motor—four-cycle or two-cycle.

If you understood the Elmore valveless two-cycle car, there could be no question in your mind. Your decision in favor of the Elmore would be a foregone conclusion.

You would know why the Elmore runs



and runs and runs, with never a bit of unnecessary trouble or exasperation or expense—just as every present Elmore owner knows.

You would realize what you don't know

now—how all-powerful is the influence of valves.

The Elmore engine has no valves; it produces the smooth, constant rhythm of power known as continuous torque—something that no four-cycle engine, no matter how many cylinders it has, can do.

These differences are comprehensively explained in the 1909 literature. Get it and study it until you are perfectly familiar with the Elmore valveless two-cycle engine.

Then seek the Elmore dealer and a demonstration of the car. The dealer has been allotted as many cars as he can obtain, so you realize the necessity of deciding without delay.

THE ELMORE MFG. CO., 1304 Amanda Street, Clyde, O.

Member Association of Licensed Automobile Manufacturers

THE ELMORE WILL BE EXHIBITED ONLY AT THE MADISON SQUARE GARDEN SHOW, NEW YORK, JANUARY 16-23. STUDY IT THERE.

THE SELDEN CAR

MADE BY

"THE FATHER OF THEM ALL"

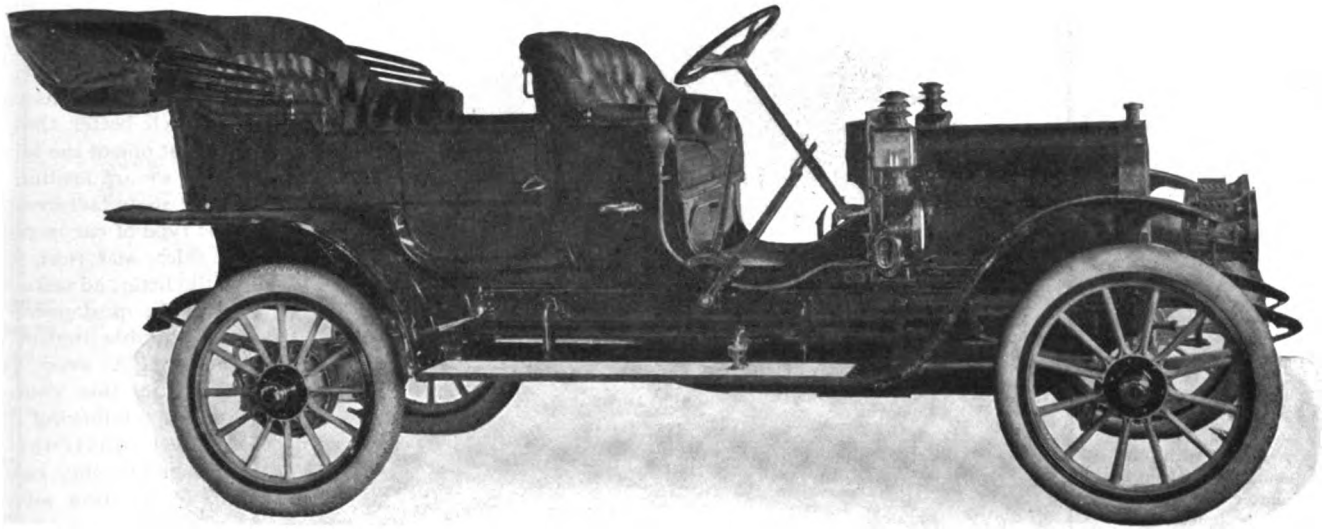

ONE PRICE, \$2000—F. O. B. ROCHESTER

TOURING CAR—ROADSTER—TOY TONNEAU

A genuinely good car cannot be made and sold for less than \$2000. By this we mean a car like the Selden, containing nothing but the best of materials, workmanship and finish. A car that the manufacturer can stand behind and guarantee for at least a year against any imperfections in workmanship or material.

We buy only the best materials, employ only skilled labor, and pay particular attention to details and finish, thereby producing a strictly high-grade car at the lowest possible price.

The up-keep and maintenance of a medium-priced car like the Selden is within the reach of any man of moderate means and the value of the car does not depreciate like that of the lower priced cars. This is the point to be considered by every purchaser.

The Selden Car is a 4 cylinder, 28-30 H. P. (developing 37 H. P.) five-passenger Touring Car, or three-passenger Roadster, with 114 inch wheel base, 34 inch wheels, shaft drive, selective control, pressed steel frame, metal body, fully equipped.

Superb riding, roomy tonneau, luxurious upholstery, smooth running, great hill-climber, flexible and easily handled, economical in maintenance and up-keep, fine finish, stylish and attractive.

THE COMING CAR OF MODERATE PRICE

Catalog and Agency Proposition Upon Request
Agencies Wanted Everywhere
We will Exhibit at Madison Square Garden Show

SELDEN MOTOR VEHICLE CO., ROCHESTER, N. Y.

GEORGE B. SELDEN, President

Members Association of Licensed Automobile Manufacturers

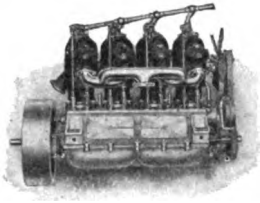

Note clean lines of design

1909 1909
Great Western

The only line in America of identically the same construction throughout the various types



No superfluous detail

NO. 20-A

With both single and double rumble seat; gas lamps and high tension magneto.

\$1600

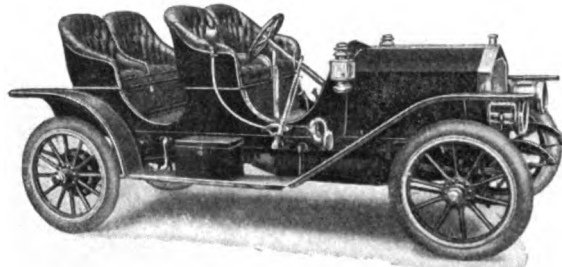

No. 20-A—63 1-3 lbs. per H. P. 30 H. P., 4 cylinder motor, 4-in. bore, 5-in. stroke. Weight, with complete equipment, 1,900 lbs.

NO. 20

5-passenger with full equipment. Gas lamps, generator and high tension magneto.

\$1600

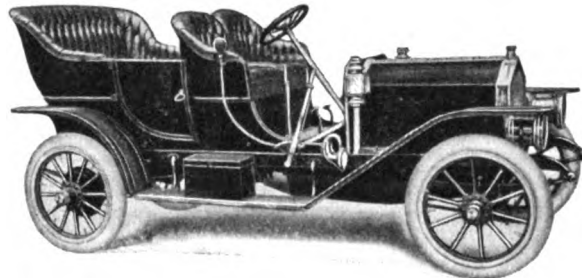

No. 20—66 2-3 lbs. per H. P. 30 H. P., 4 cylinder motor, 4-in. bore, 5-in. stroke. Weight, with complete equipment, 2,000 lbs.

NO. 21

5-passenger with full equipment. Lamps, gas tank, high tension magneto.

\$2500

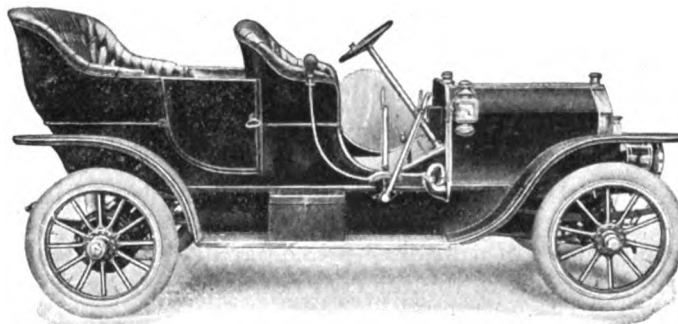

No. 21—62 1-2 lbs. per H. P. 40 H. P., 4 cylinder motor, 4 1-2 in. bore, 5 1-2 in. stroke. Weight, with complete equipment, 2,500 lbs.

NO. 22

7-passenger with full equipment.

\$4000

This is the car which in the past two years averaged from 9,000 to 12,000 miles with single set of tires. Cost of upkeep never equaled on any 7-passenger car. 60 lbs. lighter this year.

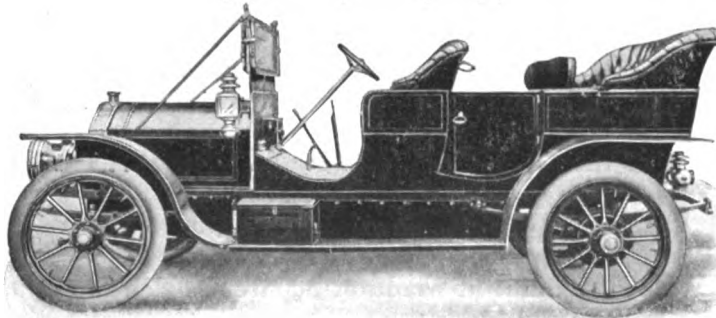

No. 22—58 4-5 lbs. per H. P. 50 H. P., 4 cylinder motor, 5-in. bore, 6 in. stroke. Weight, with full equipment, 2,940 lbs.

The past two years the showing of our 50-H. P., 7-passenger car has been so much better that in at least one of the larger cities we are leading all other manufacturers of this type of car in point of sales, and that, too, with little advertising. With the most powerful and durable motor for the weight ever produced in this country and by following the same construction throughout the car it is easy to show advantages over the heavy and cumbersome cars of same capacity and horsepower. The remarkable success of this car has induced us to duplicate it in two smaller sizes, and today we have the only line in which the lower price cars are of the same construction, except as to size. These smaller cars, No. 20 and No. 21, can be had with detachable tonneau, making an ideal car for doctors and contractors with comfortable space between front seat and dash. With such a line any good live dealer can go to the front and stay there if he is trying to build up a permanent business.

A visit to our factory where the adjacent country affords material for a thorough test of cars, will convince you that we have a line of better hill climbers and speedier cars than anything on the market today.

Distributing Agency
**GREAT WESTERN
AUTOMOBILE CO.**
1706-S Main Street
KANSAS CITY, MO.

MODEL AUTOMOBILE COMPANY
97 Smith Street, PERU, INDIANA, U. S. A.

Rambler

Breaks Los Angeles-San Diego Record

New 32-H. P. Four-Cylinder Rambler Roadster Beats By 45 Minutes Time Record Established By Six-Cylinder Car And Is Awarded The Chanslor-Lyons Challenge Cup.

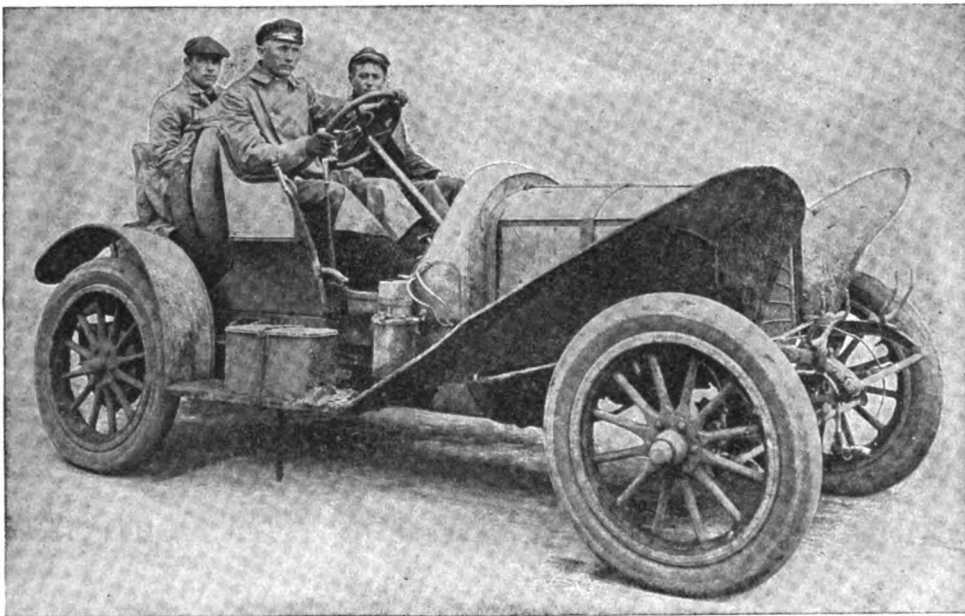

THREE hundred and thirty miles in ten hours and thirty-two minutes and not a single stop for repairs. That is the new round trip record between Los Angeles and San Diego, California, just established by the new 32 horse power, four-cylinder Rambler roadster.

This is the second time the Rambler has made this sensational run and each time it has broken all preceding records.

The first time the Rambler made the run in 11 hours and 31 minutes. Shortly afterwards a six-cylinder car reduced this time by a bare 14 minutes. The Rambler went after the record again, this time reducing its own time by nearly one hour.

There are certain mechanical features of the Rambler which make it possible for it to excel in consistent road performance any other car at any price. If you care to know what these features are, send us your address and we will be glad to send you our new catalog.

THE CAR OF STEADY SERVICE

Thomas B. Jeffery & Company, Main Office and Factory, Kenosha, Wis.

Branches and Distributing Agencies:

Chicago, Milwaukee, Boston, New York, Cleveland, San Francisco. Representatives in all leading cities.

The 1909

Overland

Catalog

Is Now Ready for Distribution

¶ It contains a full and exhaustive description, profusely illustrated, of the most wonderful line of automobiles ever placed on the American market

Consisting of

4 and 6 Cylinder

Roadsters, Touring Cars and Enclosed Cars

\$1250.00 \$2250.00

Write for a copy

Overland Automobile Co.

Indianapolis, Ind.

Packard

"THIRTY"
1909

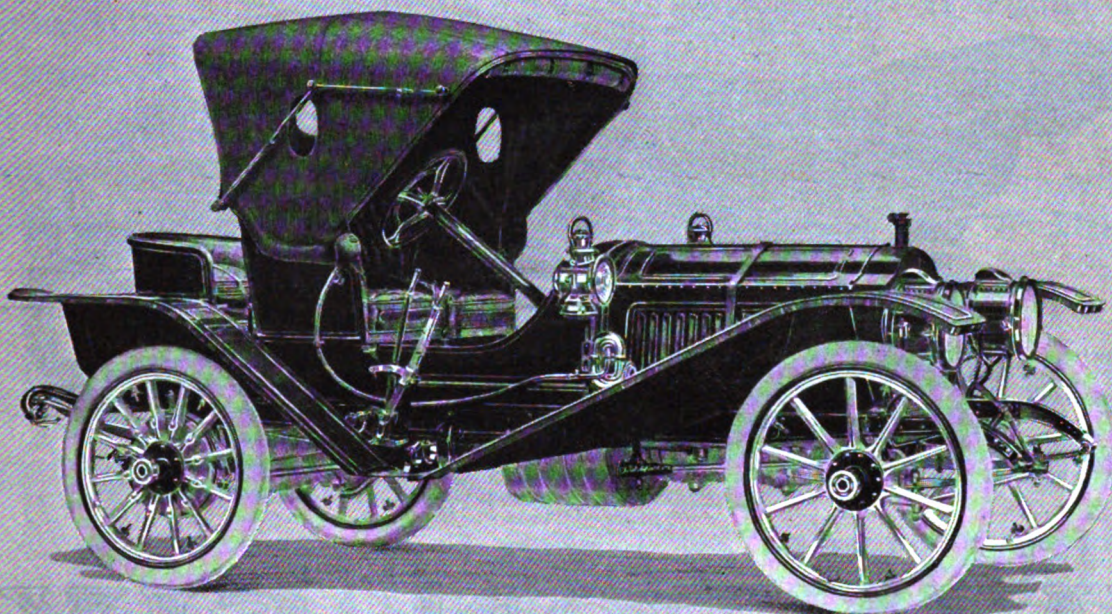

Packard "Thirty" Runabout with Victoria Top

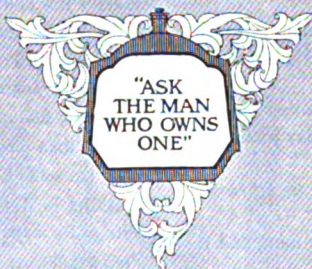

Packard Motor Car Company
Detroit, Michigan

Forced to make Six-Cylinder Cars

For several years Mr. Winton has known six-cylinder cars to be superior to fours. But originally he did not anticipate marketing a six until about 1910.

His belief was that the public would not be ready for sixes until then; and you know how unwise it is to try to hurry public opinion.

Well, after marketing the four-cylinder Winton Model M in 1907—a car that to this day has no superior among fours—and finding buyers clamoring for a new merit that fours could not satisfy, Mr. Winton had no alternative. He was forced to make and market the

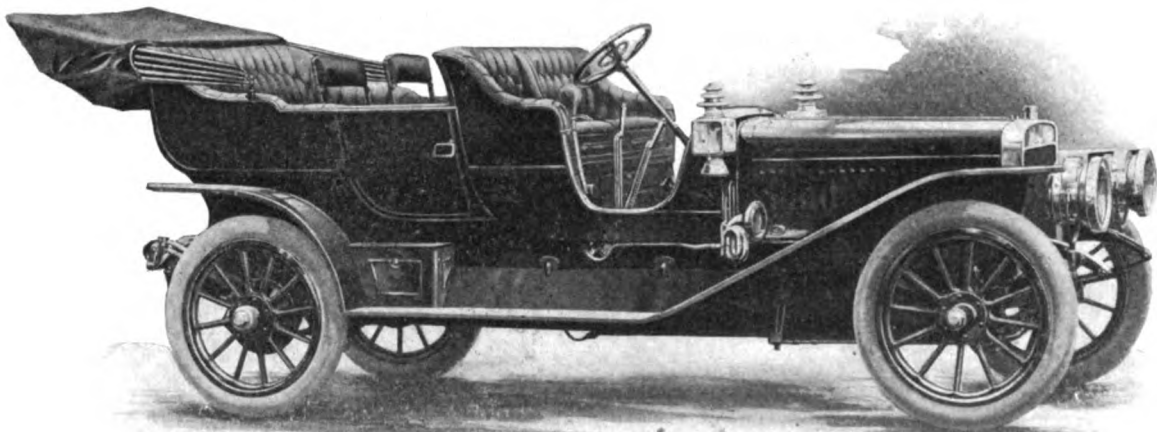

WINTON SIX

two years ahead of his schedule.

Then the four makers smiled knowingly. In their opinion it was a foolish thing to put all one's eggs in the six basket.

That was more than a year ago.

Today nearly every maker who isn't marketing a six is either wishing he were, or is experimenting with one in the hope that he may produce a six to equal the self-starting, sweet-running Winton Six.

Men who own Winton Sixes enjoy a contentment that no other car ever gave them.

That's why the Winton plant is working full force, full time, and is still behind orders.

If you want a new satisfaction in motoring, we suggest that you place your order early.

Our booklet, "Twelve Rules to Help Buyers," tells how to compare cars of all makes, styles and sizes. Another booklet, "The Difference

Between Price and Value," tells what you pay for when you buy a car. Both books sent upon request.

The Winton Six carries no starting crank in front. Starts from the seat without cranking.

So flexible that gear-changing is seldom required.

Quieter than nine-tenths of the electrics you pass on the street.

Goes the route like coasting down hill.

Beautiful in its lines, superb in the character of its design and the quality of its material and workmanship.

Precisely the car for the man who seeks the best there is.

Made in two sizes, with various body designs. Five-passenger, 48 h. p. Winton Six touring car \$3000. Seven-passenger, 60 h. p. Winton Six touring car \$4500.

Write for literature today.

THE WINTON MOTOR CARRIAGE CO.

Member Association Licensed Automobile Manufacturers

919 Berea Road, CLEVELAND, OHIO.

Winton Branch Houses in New York, Boston, Philadelphia, Baltimore, Pittsburg, Detroit, Chicago, Minneapolis, Seattle and San Francisco

SEE OUR EXHIBIT AT MADISON SQUARE GARDEN SHOW, NEW YORK, JANUARY 16-23

MAYO RADIATORS

Mayo Radiators perform their functions well under all conditions, and conditions at times are exacting. It is at just such times that Mayo quality asserts itself.



Most of the High Grade Cars built in America use Mayo Radiators as regular equipment
There's a Reason
Send for Catalog Showing 1909 Designs

MAYO RADIATOR COMPANY

New Haven, Conn.



**THE STAR EXHIBIT
AT ALL THE SHOWS**

STROMBERG

SIMPLY A PERFECT CARBURETER

Write for Circular No. 1. It tells, shows and explains ALL about it.

STROMBERG MOTOR DEVICES COMPANY
Main Office and Factory, 1253-1255 Michigan Ave., CHICAGO

EASTERN BRANCH—N. Y. C., 241-2 Thoroughfare Building, B'way and 58th Street; C. S. Gibson, Mgr.
NEW ENGLAND BRANCH—Boston, Massachusetts, 319 Columbus Avenue; E. H. Gross, Mgr.
WESTERN BRANCH—San Francisco, California, 426-8 Van Ness Avenue; Wm. R. Johnson, Mgr.

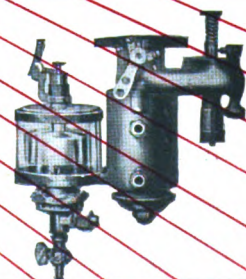

Peerless

All That The Name Implies

Silence

Comfort

These qualities are distinctly Peerless features.



*We shall exhibit in New York only at Madison Square Garden,
January 16-23, 1909.*

*Write to-day for our catalogue D which fully describes the
1909 Models.*

THE PEERLESS MOTOR CAR CO.

2461 Oakdale St., Cleveland, Ohio

Members of Association Licensed Automobile Manufacturers.

THE AUTOMOBILE

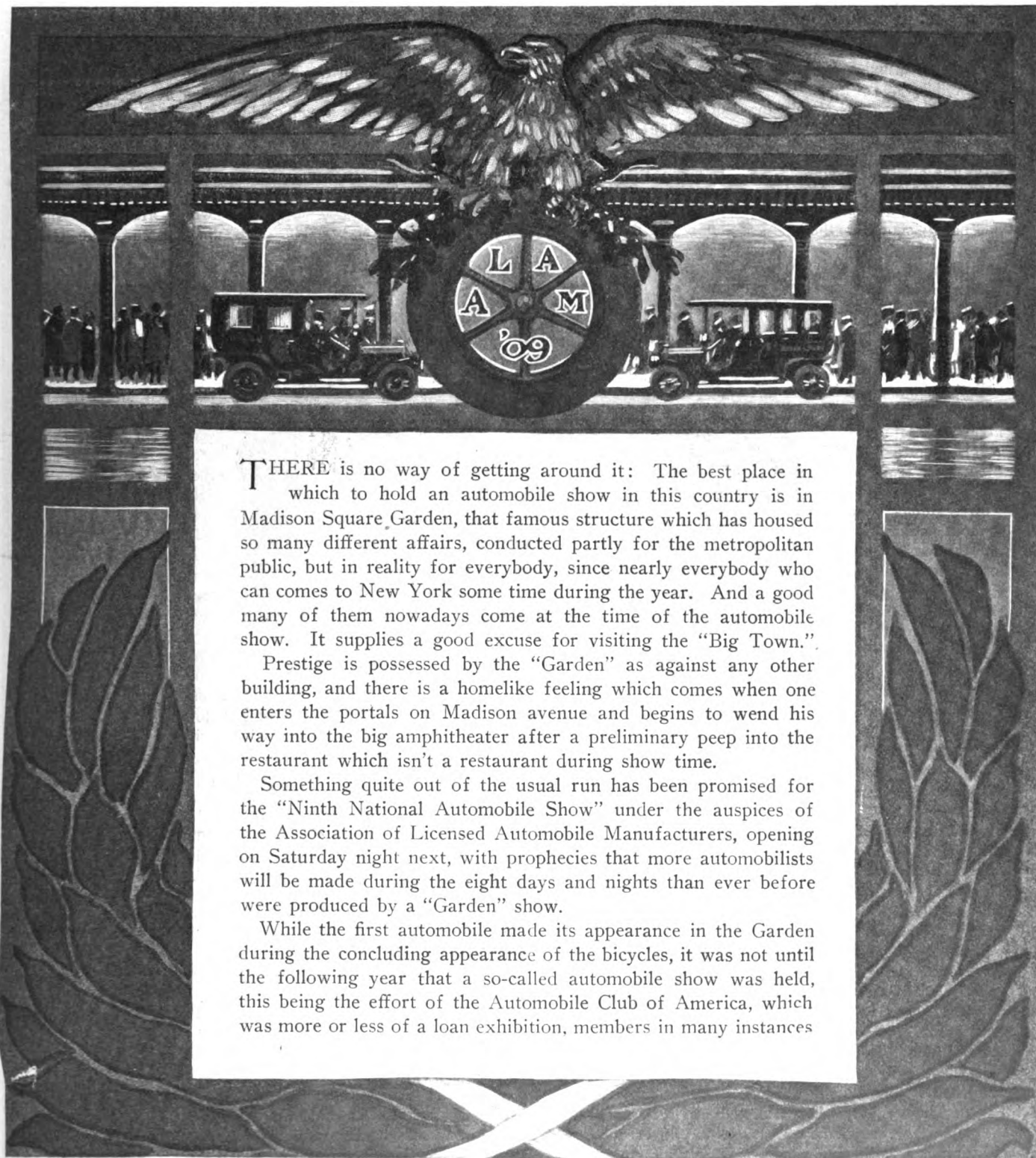

THERE is no way of getting around it: The best place in which to hold an automobile show in this country is in Madison Square Garden, that famous structure which has housed so many different affairs, conducted partly for the metropolitan public, but in reality for everybody, since nearly everybody who can comes to New York some time during the year. And a good many of them nowadays come at the time of the automobile show. It supplies a good excuse for visiting the "Big Town."

Prestige is possessed by the "Garden" as against any other building, and there is a homelike feeling which comes when one enters the portals on Madison avenue and begins to wend his way into the big amphitheater after a preliminary peep into the restaurant which isn't a restaurant during show time.

Something quite out of the usual run has been promised for the "Ninth National Automobile Show" under the auspices of the Association of Licensed Automobile Manufacturers, opening on Saturday night next, with prophecies that more automobilists will be made during the eight days and nights than ever before were produced by a "Garden" show.

While the first automobile made its appearance in the Garden during the concluding appearance of the bicycles, it was not until the following year that a so-called automobile show was held, this being the effort of the Automobile Club of America, which was more or less of a loan exhibition, members in many instances

loaning their cars, and the grand total of exhibitors, including accessory manufacturers, being sixty in number.

Incidentally, it should be mentioned that Secretary James C. Young had a good deal to do with the promoting of this show; in fact, if it had not been for his successful talk with Frank W. Sanger, who died several years ago, there would not have been any beginning in the Garden at all, at least not at that time. The show of December, 1901, also had a substantial loan account, with 93 actual exhibitors and none from abroad. Next came the display of January, 1903, with the National Association of Automobile Manufacturers promoting the show in conjunction with the A. C. A. and the Garden management. The list of exhibitors totaled 150, and the first foreign exhibitor was the Paris Automobile Company, represented by Henry Fournier. In 1904 under the same management there were over 200 exhibitors.

A year later it was plainly apparent that no one building could house the industry properly for exhibition purposes. Hence the 1906 show was that of the Association of Licensed Automobile Manufacturers, while the A. C. A. held an independent show at the same time in an armory not far away. Since then each year the A. L. A. M. show has continued to demonstrate progress and prosperity, and what is designated as the "Ninth Annual" bids fair to excel all of its predecessors.

'Tis promised that the decorative features will be artistically satisfying, with exhibits placed without undue crowding, and the comfort of those who attend well considered in the general conduct of the exhibition.

This year the color scheme of the show is brown and white, with green carpet on the floor of the exhibition spaces. By the use of the decorative lamp-posts bearing the names of the exhibitors, and the manner in which the entrance way will be treated, it will be possible to get a comprehensive view of the whole main floor, the exhibits being represented panoramically. Mirrors at certain points deepen the perspective. The A. L. A. M. "Old Abe" emblem will be conspicuous—an eagle with outspread wings perched on an automobile wheel.

A triumphal arch, 87 by 48 feet, at the rear of the Garden, will be the *piece de resistance* of the decorative scheme. It is the most massive and ambitious piece of ornamentation ever undertaken for an indoor exhibition.

This year the show is one of American-built cars only—truly a national event.

In the date fixed for the ninth show there is a tacit recognition by the makers of the changed character and new commercial value of automobile shows. The previous show in the Garden was held during the first week in November, and the present exhibition marks the second time that the show date has been moved along from the Fall to January. It is now accepted that the show is for the public, the individual enthusiast, the buyer and user, although it is still conducted by the manufacturers and

not by the retailers. "This is the essential difference," states the press agent, "between the two national shows in New York and Chicago, and those of Boston, Philadelphia, and elsewhere. In former years it was considered that the show was a trade event, one arranged by the manufacturers for the dealer. Then the dealers waited till show time before making their commitments as to the exact cars they would handle during the ensuing year. At the show the manufacturer expected to book his agents and close his contracts with them for the number of cars they would handle. The business done direct with users was deemed of secondary consequence. This condition was largely a theory always. It was more or less a fact during the first two or three shows, but the January date was too late for agents. They began to close their deals with the manufacturers early in the Fall, and by show time most of the big makers had no interest in making new agents, and the show was merely a public educator and stimulus, at which a fair amount of retail orders were booked. Still, the theory held that the manufacturers ran the shows for the

benefit of agents, and its influence was noticed when, after two shows in the Fall and five in January, the eighth show was set back to the 1st of November. The result demonstrated that the show is now an exposition for the public."

In view of all that has happened since the first real exhibition in the Garden, it might be interesting to read again the list of those who participated. Here they are:

Electric Vehicle Co., Riker Vehicle Co., Locomobile Company of America, National Automobile & Electric Co., De Dion-Bouton Motorette Co., Waltham Mfg. Co., American Bicycle Co., Winton Motor Car-

riage Co., Mobile Company of America, Baker Motor Vehicle Co., Autocar Co., Foster Automobile Manufacturing Co., Automobile Company of America, Woods Motor Vehicle Co., Stanley Manufacturing Co., Canda Manufacturing Co., Buffalo Electric Carriage Co., Daimler Manufacturing Co., Holyoke Automobile Co., Knox Automobile Co., Overman Automobile Co., International Motor Carriage Co., Trinity Cycle Manufacturing Co., John T. Robinson & Co., Peerless Manufacturing Co., Springfield Cornice Works, St. Louis Motor Carriage Co., Haynes-Apperson Co., Strong & Rogers, Duryea Motor Co., Upton Machine Co., Automobile Club of America, Edmond Motor Cycle Co., New York Motor Vehicle Co., Munger Vehicle Tire Co., Steam Vehicle Co., Badger Brass Manufacturing Co., Bevin Brothers Manufacturing Co., E. A. Brecher & Co., Consolidated Rubber Tire Co., Crest Manufacturing Co., Diamond Rubber Co., Dixon Crucible Co., Downing & Co., Dow Portable Electric Assistant Co., Gleason Peters Air Pump Co., B. F. Goodrich & Co., Goodyear Tire & Rubber Co., Gray & Davis, Hartford Rubber Works Co., Janney, Steinmetz & Co., Metallic Rubber Tire Co., Charles E. Miller, New Process Rawhide Co., New York Belting & Packing Co., Pennsylvania Automobile & Gear Co., C. F. Splitdorf, Veeder Manufacturing Co., and Ware Brothers.



The Famous Firm of George B. Selden and Son.



Charles Clifton - President ALAM.

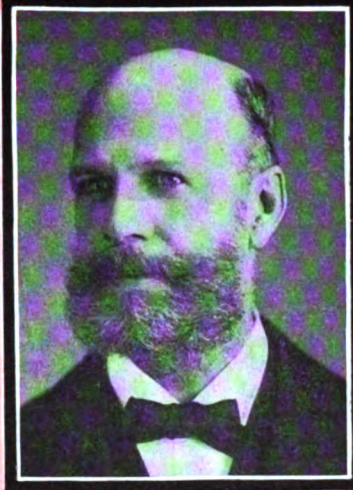

Col. George Pope - Chairman Show Committee



E. P. Chalfant - General Manager ALAM

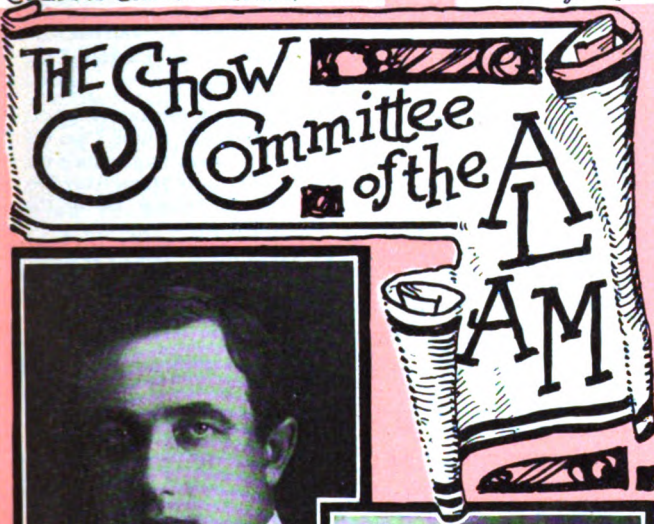

M. L. Downs - Secretary



Coker F. Clarkson
A. L. A. M. Publicity.

NATURALLY the first thing to do in order to conduct successfully an automobile exhibition is to get a show committee. Experience counts for much in affairs of this kind where innumerable details require prompt and skilful attention, or otherwise an avalanche of little things accumulates and sadly interferes with the perfect lubrication so essential in satisfying first the exhibitors and ultimately the public itself.

In the contingent which has direct charge of the "Ninth National Automobile Show" in Madison Square Garden are men well qualified for the work and who have demonstrated the fact on previous occasions. The A. L. A. M. only requires four members for its committee, including President Charles Clifton, ex-officio. There is one new

face on the committee this year and a second new one prominent in connection with the show work. The new member of the committee is E. P. Chalfant, the new general manager of the Association of Licensed Automobile Manufacturers, and the new man associated with the committee work is Coker F. Clarkson, the new head of the A. L. A. M. publicity department. The others of the committee are the same as last year: Col. George Pope, chairman; Charles Clifton, and M. L. Downs, secretary.

To the ability of these men is due the success and magnificence of the "Garden" show. Charles Clifton is as prominent a figure as any in the industry, he being treasurer of the George N. Pierce Company and president of the Association of Licensed Automobile Manufacturers, with all the affiliations and activities those positions imply.

Col. George Pope is a landmark in the industry, having been for years the treasurer of the Pope Manufacturing Company. He has been chairman of the A. L. A. M. show committee for three successive years.

Edward P. Chalfant has been identified with the automobile industry since January 1, 1905, although he was previously in the tire business. He was sales manager and a director of the Waltham Manufacturing Company until he was called to the post of general manager of the A. L. A. M.

M. L. Downs, secretary of the committee, has been identified with the automobile industry since its inception and has been in every branch of it, even to managing some big runs. For the last five years he has been with the A. L. A. M. and has attended to the detail work in connection with all the licensed shows.

Coker F. Clarkson, the new head of the A. L. A. M. publicity department, is a lawyer who found a greater interest in engineering matters, and from electrical experimenting he stepped into the A. L. A. M. as secretary of its mechanical branch, which post he retains with his new one. Mr. Clarkson in his younger days did newspaper work. He is a former president of the Y. M. C. A. Motor Club, being a graduate of the first Y. M. C. A. motor class. He is the compiler of the A. L. A. M. mechanical digests and handbooks, and the general statistician of the association.

In speaking of the preparations for the show, Col. George Pope, chairman, tells of the work in these words:

"In the preliminary stages of the show preparation, engineers measure up the building to make use of all available area for exhibition purposes, considering the comfort and safety of the public as to passageways and regular and emergency exits.

"Then the architect studies the building, to get from artistic standpoints an harmonious decorative scheme, in keeping with the floor plans of the engineers; lending itself to the practical side of a trade exhibition.

"Then follow the constructing builders, to overhaul the building, to bring about the required result. Then the work of preparation divides itself into two great divisions, one of which involves almost endless communications with the trade regarding space, the preparation of thoroughly indexed rules for the conduct of the show, just to the large and small exhibitors and the management.

"Above all, a high standard is maintained. Exhibits which could reasonably be considered freakish or of negligible interest, or irrelevant to the needs of the motorist, are prohibited."

M. L. Downs, secretary of the show committee, calls attention to the pessimism which existed in the early days of the automobile and how many people regarded the first exhibition which took place in the Garden. While they looked at the meager supply of cars they expressed the belief that the "fad" would not last as long as the bicycle, but they could not foresee the marvelous advances in manufacturing methods. Here is what Mr. Downs says:

"In the early days when automobiles were first struggling for recognition in this country, one of the pioneer companies took a small space in a corner of a bicycle exhibition and showed two cars therein. They excited a great deal of curiosity, yet at the same time were laughed at by the majority of the public as being impractical and simply a dream and toy of the rich that never would be of any use for ordinary purposes.

"Not many years have rolled by since that day, and many of the scoffers of that period are now enthusiastic automobilists.

"Instead of the man dressed in sweater and knee-breeches, bending low over the handle-bar of his bicycle, working hard for every foot of ground that he covers, we now find him taking his ease, sitting in a luxuriously upholstered car, going here and there at will, covering long distances that in bicycle days were looked upon as impossible. The automobile has made possible the pleasures of a country home, with all that it means, and yet allows a man to conduct his business in the city."

In the running of a show it is always a mighty good plan to have a good press agent, and here's a sample of what A. N. Jervis recently supplied in the way of word painting:

"The hoisting of the circus tent and installation of the animals, to watch which the small boy plays hookey from school, is no more interesting to him than would be to an adult a similar exhibition of complicated activity in the work of preparation that is now in progress at Madison Square Garden. The annual automobile show, which opens at the Garden next Saturday night, has come to be the particular event for which the big amphitheater is most elaborately decorated and generally transformed. The show managers of the Association of Licensed Automobile Manufacturers are now in possession of the Garden, and the carpenters, decorators, electricians and painters, with their assistants, to the number of ten score, are over-running the place from cellar to rafters, all as busy as sailors getting a ship under way. At first glance it looks like a terribly confused activity, but a little observation shows organization in half a dozen different directions and orderly coherent co-operation that will quickly bring the scheme to completeness and beauty. The show is to have more exhibitors than ever this time, about 325, and the wits of the planners have been taxed to provide for them, but it will all seem to have been easily done when the big crowd surges in on the opening night."

ROSTER OF THE A. L. A. M. FOR 1909.

Herewith is given the latest complete list of officers, committeemen and others officially connected with the Association of Licensed Automobile Manufacturers. The list is a formidable one and contains many men who are pioneers of the automobile industry:

OFFICERS

Charles Clifton, President.....The George N. Pierce Co.
Thomas Henderson, Vice-Pres...Winton Motor Carriage Co.
L. H. Kittredge, Secretary.....Peerless Motor Car Co.
George Pope, Treasurer.....Pope Manufacturing Co.

EXECUTIVE COMMITTEE

Charles Clifton.....The George N. Pierce Co.
S. T. Davis, Jr.....Locomobile Company of America
Thomas Henderson.....Winton Motor Carriage Co.
G. H. Stillwell.....H. H. Franklin Manufacturing Co.
Herbert Lloyd.....Electric Vehicle Co.

TRADES COMMITTEE

W. E. Metzger.....Everitt-Metzger-Flanders Co.
George Pope.....Pope Manufacturing Co.
H. H. Franklin.....H. H. Franklin Manufacturing Co.
C. C. Hildebrand.....Stevens-Duryea Co.
Thomas Henderson.....Winton Motor Carriage Co.

COMMITTEE ON FIRES

Albert L. Pope.....Pope Manufacturing Co.
L. H. Kittredge.....Peerless Motor Car Co.
S. D. Waldon.....Packard Motor Car Co.
M. J. Budlong.....Packard Motor Car Co.
R. D. Chapin.....Chalmers-Detroit Motor Co.

HAND BOOK COMMITTEE

L. H. Kittredge.....Peerless Motor Car Co.
W. E. Metzger.....Everitt-Metzger-Flanders Co.
Thomas Henderson.....Winton Motor Carriage Co.

SHOW COMMITTEE

George Pope.....Pope Manufacturing Co.
Charles Clifton.....The George N. Pierce Co.
E. P. Chalfant.....A. L. A. M.
M. L. Downs, Secretary.....A. L. A. M.

ADVERTISING AND PUBLICITY COMMITTEE

E. R. Thomas.....E. R. Thomas Motor Co.
Charles B. Shanks.....F. B. Stearns Co.
J. A. Kingman.....Locomobile Company of America

NEW YORK OFFICE

E. P. Chalfant.....General Manager

PATENT DEPARTMENT

Hermann F. Cuntz.....Manager

ADVERTISING AND PUBLICITY DEPARTMENT

Coker F. Clarkson.....Manager

ASSOCIATION PATENTS COMPANY

Charles Clifton, President.....The George N. Pierce Co.
Thomas Henderson, Vice-Pres...Winton Motor Carriage Co.
J. H. Becker.....Elmore Manufacturing Co.
George Pope.....Pope Manufacturing Co.
I. H. Page.....Stevens-Duryea Co.
W. C. Leland.....Cadillac Motor Car Co.
M. S. Hart.....Corbin Motor Vehicle Corporation
E. P. Chalfant, Secretary and Treasurer.....A. L. A. M.

COMMITTEE ON TESTS

H. E. Coffin, Chairman.....Chalmers-Detroit Motor Co.
A. L. Riker.....Locomobile Company of America
H. P. Maxim.....Electric Vehicle Co.
John Wilkinson.....H. H. Franklin Manufacturing Co.
Russell Huff.....Packard Motor Car Co.
F. B. Stearns.....F. B. Stearns Co.
Charles Schmidt.....Peerless Motor Car Co.
David Fergusson.....The George N. Pierce Co.
Henry Souther.....Metallurgist
Coker F. Clarkson, Secretary.....A. L. A. M.

The A. L. A. M. has headquarters at No. 7 East Forty-second street, where the regular monthly meetings of the association are always held. Messrs. Chalfant, Downs, Clarkson and Cuntz are invariably in attendance at the New York offices.

WHERE THE EXHIBITORS ARE LOCATED

VISITORS to the Garden show will be most agreeably surprised at the neat, clean layout and distribution of exhibitors, which is in marked contrast with some previous exhibitions. The distribution is such as to give the impression of a vast space not uncomfortably filled with cars, thus allowing plenty of room for visitors. This is so cleverly done that in reality the effective floor space is very little less than last year. The tables below will show

where the exhibits may be found in which the following key will be found useful. The letters in every case are an abbreviation of the words: M.F., Main Floor; E.P., Elevated Platform; E.H., Exhibition Hall; B., Basement; Bal., Balcony; S.T.B., Second Tier Boxes; T.T.B., Third Tier Boxes. The very small number of exhibitors upon the main floor, namely, twenty-three, will be noted as bearing out the idea of plenty of floor space.

GASOLINE PLEASURE CARS.

APPERSON: Apperson Bros. Auto Co., Kokomo, Ind.	E.P.	32
AUTOCAR: Autocar Company, Ardmore, Pa.	M.F.	7
CADILLAC: Cadillac Motor Car Co., Detroit	M.F.	4
CHALMERS-DETROIT: Chal.-Det. M. Co., Detroit	M.F.	17
COLUMBIA: Electric Vehicle Co., Hartford, Conn.	M.F.	12
CORBIN: Corbin Motor Veh. Corp., New Britain, Ct.	M.F.	9
ELMORE: Elmore Manufacturing Co., Clyde, O.	M.F.	3
E-M-F: Everitt-Metzger-Flanders Co., Detroit	M.F.	8
FRANKLIN: H. H. Franklin Mfg. Co., Syracuse, N. Y.	M.F.	18
HAYNES: Haynes Automobile Co., Kokomo, Ind.	E.P.	25
HEWITT: Hewitt Motor Co., New York City	E.P.	27
KNOX: Knox Automobile Co., Springfield, Mass.	M.F.	1
LOCOMOBILE: Loco. Co. of America, Bridgeport, Ct.	M.F.	19
LOZIER: Lozier Motor Co., Plattsburg, N. Y.	M.F.	11
MATHESON: Matheson Motor Car Co., Wilkes-Barre, Pa.	M.F.	2
PACKARD: Packard Motor Car Co., Detroit	M.F.	14
PEERLESS: Peerless Motor Car Co., Cleveland	M.F.	23
PIERCE: George N. Pierce Co., Buffalo, N. Y.	M.F.	15
POPE-HARTFORD: Pope Mfg. Co., Hartford, Conn.	M.F.	20
POPE-TOLEDO: Pope Motor Car Co., Hartford, Conn.	M.F.	5
P. & S.: Palmer & Singer Mfg. Co., New York City	E.P.	27
ROYAL TOURIST: Royal Tourist Car Co., Cleveland	M.F.	6
SELDEN: Selden Motor Veh. Co., Rochester, N. Y.	E.P.	24
SIMPLEX: Simplex Auto Co., New York City	E.P.	26
STEARNS: F. B. Stearns Co., Cleveland	M.F.	13
STEVENS-DURYEA: S.-D. Co., Chicopee Falls, Mass.	M.F.	22
STUDEBAKER: Studebaker Auto Co., South Bend	M.F.	10
THOMAS: E. R. Thomas Motor Co., Buffalo, N. Y.	M.F.	16
WALTER: Walter Automobile Co., Trenton, N. J.	E.P.	28
WINTON: Winton Motor Carriage Co., Cleveland	M.F.	21

ELECTRIC PLEASURE CARS

BABCOCK: Babcock Electric Co., Buffalo, N. Y.	E.H.	55
BAILEY: S. R. Bailey & Co., Amesbury, Mass.	E.H.	53
BAKER: Baker Motor Vehicle Co., Cleveland	E.H.	57
COLUMBIA: Electric Vehicle Co., Hartford, Conn.	E.H.	51
DETROIT: Anderson Carriage Co., Detroit	E.H.	54
RAUCH & LANG: R. & L. Car'ge Co., Cleveland	E.H.	52
STUDEBAKER: Studebaker Auto Co., South Bend	E.H.	56
WAVERLEY: The Waverley Co., Indianapolis, Ind.	E.H.	50
WOODS: Woods Motor Vehicle Co., Chicago	E.P.	29

MAGNETS AND TIMERS.

Atwater-Kent Mfg. Works, Philadelphia	E.P.	117
Apple Electric Co., Dayton, O.	Bal.	217
Auto Improvement Co., New York City	E.P.	109
Bosch Magneto Co., New York City	S.T.B.	400-403
J. S. Bretz Co., Times Bldg., New York City	Bal.	214
Champion Ignition Co., Flint, Mich.	Bal.	240
Albert Champion Co., Boston	B.	507
Heinze Electric Co., Lowell, Mass.	E.P.	176
Hess-Bright Mfg. Co., Philadelphia	C.H.	304
Herz & Company, 235 Lafayette St., New York City	E.P.	112
K-W Ignition Co., 1686 Broadway, New York City	Bal.	223
Lavalette & Company, 112 W. 42d St., New York City	B.	517
Motzinger Device Mfg. Co., Pendleton, Ind.	E.P.	155
Philadelphia Timer & Mach. Co., Philadelphia	Bal.	236
Remy Electric Co., Anderson, Ind.	E.P.	125
C. F. Splittdorf, 261 Walton Ave., New York City	E.P.	102
F. H. Wheeler, Indianapolis	E.P.	137
Witherbee Igniter Co., 1876 Broadway, N. Y. City	E.P.	138

TIRE ACCESSORIES.

Allen Auto Specialty Co., New York City	Bal.	207
Atlas Rubber Co., Buffalo, N. Y.	Bal.	239
Auto Tire Inflator Co., Brooklyn, N. Y.	T.T.B.	430
E. T. Burrows Co., Portland, Me.	B.	508
Dow Demountable Rim, New York City	B.	569
Faultless Auto Tube Co., New York City	B.	566
Gilbert Mfg. Co., New Haven, Conn.	E.P.	108
Hopewell Bros., Cambridge, Mass.	Bal.	213
Long & Mann Co., New York City	Bal.	234
Nadall Mfg. Co., Chicago	T.T.B.	428
J. H. Sager Co., Rochester, N. Y.	E.P.	132
Seamless Rubber Co., New Haven, Conn.	S.T.B.	408
C. A. Snaier, Waupun, Wis.	Bal.	202
Standard Leather Washer Mfg. Co., Newark	T.T.B.	441
Travers Blowout Patch Co., New York City	S.T.B.	406
Trenton Rubber Mfg. Co., Trenton, N. J.	Bal.	244
U. S. Spare Wheel Co., Detroit	B.	556
Weed Chain Tire Grip Co., New York City	E.P.	135

STEAM PLEASURE CARS.

WHITE: The White Co., Cleveland	E.P.	30
---------------------------------	------	----

COMMERCIAL VEHICLES.

CHAMPION: Champion Wagon Co., Owego, N. Y.	B.	77
FRANKLIN: H. H. Franklin Mfg. Co., Syracuse, N. Y.	B.	78
GENERAL: General Vehicle Co., New York City	B.	76
HEWITT: Hewitt Motor Truck Co., New York City	B.	85
KNOX: Knox Automobile Co., Springfield, Mass.	B.	75
SAMPSON: Aiden Sampson Co., Pittsfield, Mass.	B.	84
STUDEBAKER: Studebaker Auto Co., South Bend, Ind.	B.	81
THOMAS: E. R. Thomas Motor Co., Buffalo, N. Y.	B.	82

MOTORCYCLES.

American Motor Co., Brockton, Mass.	B.	535
Aurora Automatic Machine Co., Aurora, Ill.	B.	542
Auto-Bi Company, Buffalo, N. Y.	B.	545
F. A. Baker & Co., New York City	B.	537
Bicycling World Co., New York City	B.	539
Consolidated Mfg. Co., Toledo, O.	B.	531
Crouch Motor Co., Stoneham, Mass.	B.	554
G. H. Curtis Mfg. Co., Hammondspont, N. Y.	B.	550
Eclipse Machine Co., Elmira, N. Y.	B.	551
Excelsior Supply Co., Chicago	B.	532
Harley-Davidson Motor Company, Milwaukee	B.	544
Hendee Mfg. Co., Springfield, Mass.	B.	536
Merkel Light Motor Co., Pottstown, Pa.	B.	529
H. & F. Meisinger Mfg. Co., New York City	B.	547
Motor Car Equipment Co., New York City	B.	547
Motorcycle Pub. Co., New York City	B.	534
New Era Gas Engine Co., Dayton, O.	B.	552
N. S. U. Motor Co., New York City	B.	533
Ovington Motor Co., New York City	B.	540
Persons Mfg. Co., Worcester, Mass.	B.	555
Pierce Cycle Co., Buffalo, N. Y.	B.	538
Reading Standard Co., Reading, Pa.	B.	541
Reliance Motor Cycle Co., Owego, N. Y.	B.	553
Royal Motor Works (Inc.), Worcester, Mass.	B.	543
Thiem Mfg. Co., Minneapolis, Minn.	B.	546
Walton Motor Co. (Inc.), Lynbrook, L. I., N. Y.	B.	548

TIRES.

Ajax-Greif Rubber Co., Trenton, N. J.	E.P.	134
Diamond Rubber Co., Akron, O.	E.P.	101
Consolidated Rubber Tire Co., Springfield, O.	E.P.	136
Continental Caoutchouc Co., New York City	E.P.	130
Dow Tire Company, New York City	E.P.	126
G & J Tire Co., Indianapolis, Ind.	E.P.	106
Empire Auto Tire Co., Trenton, N. J.	E.P.	122
Firestone Tire & Rubber Co., Akron, O.	E.P.	149
B. F. Goodrich Co., Akron, O.	E.P.	100
Goodyear Tire & Rubber Co., Akron, O.	E.P.	103
Fisk Rubber Co., Chicopee Falls, Mass.	E.P.	166
Hartford Rubber Works Co., Hartford Conn.	E.P.	171
Healy Leather Tire Co., New York City	B.	501
Leather Tire Goods Co., Newton Upper Falls, Mass.	E.P.	143
Michelin Tire Co., Milltown, N. J.	E.P.	142
Morgan & Wright, Detroit, Mich.	E.P.	129
Motz Clincher Tire & Rubber Co., Akron, O.	B.	525
Pennsylvania Rubber Co., Jeannette, Pa.	E.P.	153
Republic Rubber Co., Youngstown, O.	E.P.	139
Samson Leather Tire Co., New York City	S.T.B.	409-10
Swinehart Clincher Tire & Rubber Co., Akron, O.	E.P.	124
Voorhees Rubber Mfg. Co., Jersey City, N. J.	B.	227

BATTERIES.

Electric Storage Battery Co., Philadelphia	C.H.	315
Geisler Bros., 514 W. 57th St., New York City	Bal.	248
Kitsee Storage Battery Co., Scranton, Pa.	B.	503
Marko Storage Battery Co., Brooklyn, N. Y.	T.T.B.	444
National Battery Co., Buffalo, N. Y.	C.H.	307
National Carbon Co., Cleveland	C.H.	305
Philadelphia Storage Battery Co., Philadelphia	B.	563
Stanley & Patterson, 23 Murray St., New York	B.	522
Union Battery Co., Belleville, N. J.	S.T.B.	419
Vesta Accumulator Co., 1781 B'way, N. Y.	T.T.B.	425
Westchester Appliance Co., Yonkers, N. Y.	C.H.	309
Witherbee Igniter Co., 1876 B'way New York	E.P.	138

COILS.

American Electric Fuse Co., New York City.....	T.T.B.	431
Atwater-Kent Mfg. Co., Philadelphia.....	E.P.	117
Auto Coil Company, Jersey City, N. J.....	E.P.	123
Connecticut Tel. & Elec. Co., Meriden, Conn.....	E.P.	128
Pittsfield Spark Coil Co., Dalton, Mass.....	E.P.	168
Remy Electric Co., Anderson, Ind.....	E.P.	125
C. F. Splittorf, 261 Walton Ave., New York City.....	E.P.	102

PLUGS, SWITCHES, AND GENERAL IGNITION.

American Elec. Novelty & Mfg. Co., New York City.....	E.P.	110
E. M. Benford, Mount Vernon, N. Y.....	Bal.	222
Eastern Carbon Works, Jersey City, N. J.....	Bal.	206
R. E. Hardy Co., 25 W. 42d St., New York City.....	E.P.	133
High Frequency Ignition Coil Co., Los Angeles, Cal.....	Bal.	231
Jeffery Dewitt Company, Newark, N. J.....	Bal.	208
Mica Core Mfg. Co., New York City.....	T.T.B.	427
A. R. Mosler & Co., 163 W. 29th St., New York City.....	E.P.	172
Never-Miss Spark Plug Co., Lansing, Mich.....	C.H.	321
N. Y. Coil Company, 338 Pearl St., New York City.....	Bal.	226
Pittsfield Spark Coil Co., Dalton, Mass.....	E.P.	168

AXLES AND BEARINGS.

American Ball Bearing Co., Cleveland.....	E.P.	164
J. S. Bretz Co., Times Bldg., New York City.....	Bal.	214
Hess-Bright Mfg. Co., Philadelphia.....	C.H.	304
Hyatt Roller Bearing Co., Newark, N. J.....	E.P.	178
Merchant & Evans Co., Philadelphia.....	B.	524
New Departure Mfg. Co., Bristol, Conn.....	B.	556b
R. I. V. Company, 1771 Broadway, New York City.....	Bal.	238
Standard Roller Bearing Co., Philadelphia.....	C.H.	311
Timken Roller Bearing Co., Canton, O.....	E.P.	181

RADIATORS, PUMPS, MUFFLERS, AND HORNS

Auto Pump Co., Springville, N. Y.....	Bal.	219
Auto Supply & Mfg. Co., Brooklyn, N. Y.....	B.	516
A-Z Company, 527 W. 56th St., New York City.....	Bal.	230
Briscoe Mfg. Co., Newark, N. J.....	E.P.	107
Comptoir D'Innovations Pour Automobiles, N. Y. City.....	B.	567
Gabriel Horn Mfg. Co., Cleveland.....	E.P.	173
Livingston Radiator Co., 6 E. 31st St., New York City.....	B.	511
McCord Mfg. Co., Detroit.....	Bal.	200
Metal Stamping Co., 3050 Hubert St., New York City.....	Bal.	211
Randall-Falchney Co., Boston.....	C.H.	312
Sireno Company, 39 Cortlandt St., New York City.....	S.T.B.	416

LAMPS.

Atwood-Castle Co., Amesbury, Mass.....	E.P.	156
Badger Brass Mfg. Co., Kenosha, Wis.....	E.P.	165
R. E. Dietz Co., 60 Laight St., New York City.....	E.P.	116
Edmunds & Jones Mfg. Co., Detroit.....	C.H.	313
Gray & Davis, Amesbury, Mass.....	E.P.	114
C. T. Ham Mfg. Co., Rochester, N. Y.....	E.P.	176
Lux Auto Lamp Mfg. Co., New York City.....	T.T.B.	442
Manhattan Screw & Stamping Wks., New York City.....	C.H.	316
Rose Mfg. Co., Philadelphia.....	E.P.	169
Rushmore Dynamo Works, Plainfield N. J.....	Bal.	220

LUBRICANTS AND LUBRICATORS.

Adam Cook Sons, 313 West St., New York City.....	E.P.	144
Columbia Lubricants Co., 116 Broad St., New York.....	C.H.	303
Duffy Grease Co., 520 W. 40th St., New York City.....	S.T.B.	417
A. W. Harris Oil Co., Providence, R. I.....	E.P.	159
Havoline Oil Co., 80 Broad St., New York City.....	Bal.	216
Geo. A. Haws, 73 Pine St., New York City.....	Bal.	201
Joseph Dixon Crucible Co., Jersey City, N. J.....	E.P.	174
Keystone Lubricating Co., Philadelphia.....	Bal.	233
Lunkenheimer Co., Cincinnati, O.....	C.H.	306
W. P. Miller Sons, Long Island City, N. Y.....	Bal.	249
McCord Mfg. Co., Detroit, Mich.....	Bal.	200
New York & New Jersey Lub. Co., New York City.....	E.P.	119
Noera Mfg. Co., Waterbury, Conn.....	C.H.	302
W. C. Robinson & Sons Co., Baltimore.....	Bal.	203
Vacuum Oil Co., 29 Broadway, New York City.....	E.P.	111
White & Bagley Co., Worcester, Mass.....	B.	512
W. R. Winn, 143 Maiden Lane, New York City.....	Bal.	225
O. W. Young, Newark, N. J.....	Bal.	245

MATERIALS.

Anderson Forge & Machine Co., Detroit.....	Bal.	246
Wm. Cramp & Sons, Philadelphia.....	E.P.	158
Davis Bournonville Co., 90 West St., New York.....	S.T.B.	411-12
Erie Foundry Co., Erie, Pa.....	S.T.B.	414
H. H. Franklin Mfg. Co., Syracuse, N. Y.....	Bal.	232
Globe Mach. & Stamping Co., Cleveland.....	E.P.	147
I. G. Johnson & Co., Spuyten Duyvil, N. Y.....	Bal.	218
Light Mfg. & Foundry Co., Pottstown, Pa.....	E.P.	121
Manufacturers Foundry Co., Waterbury, Conn.....	E.P.	154
Thos. Prosser & Son, 15 Gold St., New York City.....	E.P.	146
Paul S. Reeves & Son, Philadelphia.....	S.T.B.	407
Shelby Steel Tube Co., Pittsburg.....	E.P.	104
A. O. Smith Co., Milwaukee, Wis.....	Bal.	205
U. S. McAdamite Metal Co., Brooklyn, N. Y.....	B.	528

CARBURETERS.

Byrne-Kingston & Co., Kokomo, Ind.....	E.P.	157
G. L. Economizer Co., Times Bldg., New York.....	B.	556a
Stromberg Motor Devices Co., New York City.....	B.	509
F. H. Wheeler, Indianapolis, Ind.....	E.P.	137

ENGINES, TRANSMISSIONS, AND STEERING.

American & British Mfg. Co., Bridgeport, Conn.....	C.H.	324
Brennen Mfg. Co., Syracuse, N. Y.....	E.P.	160
Brown-Lipe Gear Co., Syracuse, N. Y.....	E.P.	105
Gemmer Mfg. Co., Detroit.....	C.H.	318
Merchant & Evans Co., Philadelphia.....	B.	524
Spicer Universal Joint Mfg. Co., Plainfield, N. J.....	E.P.	131
Warner Gear Co., Muncie, Ind.....	E.P.	161

GASOLINE AND OTHER TANKS.

Avery Portable Lighting Co., Milwaukee, Wis.....	E.P.	145
S. F. Bowser & Co., Fort Wayne, Ind.....	E.P.	113
Hydraulic Oil Storage Co., New York City.....	Bal.	212
Janney Steinmetz Co., Philadelphia.....	E.P.	148

SHOCK ABSORBERS AND SPRINGS.

Burnett Compound Spring (Inc.), Newark, N. J.....	Bal.	241
Ernest Flentje, Cambridge, Mass.....	S.T.B.	415
Gabriel Horn Mfg. Co., Cleveland.....	E.P.	173
Hartford Suspension Co., Jersey City, N. J.....	E.P.	162
Perfection Spring Co., Cleveland.....	B.	518
J. H. Sager Company, Rochester, N. Y.....	E.P.	132

SHIELDS, TOPS, AND BODY MOUNTINGS.

Blue Ribbon Auto & Carriage Co., Bridgeport, Conn.....	B.	568
L. C. Chase & Co., Boston, Mass.....	C.H.	301
Chicago Windshield Co., Chicago.....	S.T.B.	420
C. Cowles & Co., New Haven, Conn.....	C.H.	319
Englich & Mersick Co., New Haven, Conn.....	Bal.	221
L. J. Muttly Co., Boston.....	Bal.	229
C. A. Mezger (Inc.), 1629 B'way, New York City.....	C.H.	323
Pantasote Company, 11 Broadway, New York City.....	C.H.	314
Randa Mfg. Co., Detroit.....	C.H.	325
Sprague Umbrella Co., Norwalk, O.....	C.H.	300
Springfield Metal Body Co., Springfield, Mass.....	C.H.	317
Geo. Stengel (Inc.), Newark, N. J.....	B.	567
Troy Carriage Sunshade Co., Troy, O.....	B.	564
Vanguard Mfg. Co., Joliet, Ill.....	B.	523
Vehicle Apron & Hood Co., Columbus, O.....	B.	513

SPEEDOMETERS.

Auto Improvement Co., Hudson St., New York City.....	E.P.	109
Hoffecker Company, Boston.....	C.H.	308
Joseph F. Jones, B'way & 76th St., New York City.....	E.P.	127
Stewart & Clark Mfg. Co., Chicago.....	C.H.	322
Veeder Mfg. Co., Hartford, Conn.....	E.P.	115
Warner Instrument Co., Beloit, Wis.....	E.P.	120

WHEELS AND CHAINS.

Baldwin Chain Mfg. Co., Worcester, Mass.....	E.P.	118
Diamond Chain Mfg. Co., Indianapolis, Ind.....	E.P.	167
Phineas Jones & Co., Newark, N. J.....	E.P.	162
Chas. E. Miller, 97 Reade St., New York City.....	Bal.	243
Whitney Mfg. Co., Hartford, Conn.....	E.P.	170

WRENCHES AND OTHER TOOLS.

Buda Foundry & Mfg. Co., New York City.....	Bal.	242
Goes Wrench Co., Worcester, Mass.....	C.H.	320
Cook's Standard Tool Co., Kalamazoo, Mich.....	Bal.	204
Duff Mfg. Co., Pittsburg, Pa.....	E.P.	140
Elite Mfg. Co., Ashland, O.....	T.T.B.	429
Garvin Machine Co., New York City.....	B.	568
Noonan Tool & Mach. Works, Rome, N. Y.....	B.	560
Oliver Mfg. Co., Chicago.....	E.P.	150
Patterson, Gottfried & Hunter, New York City.....	B.	500
Perfection Wrench Co., Port Chester, N. Y.....	S.T.B.	413
Pratt & Whitney Co., 111 B'way, New York City.....	B.	561
Quincy, Manchester, Sargent Co., Plainfield, N. J.....	T.T.B.	443

IN GENERAL.

H. A. Ailers & Co., 136 Liberty St., New York City.....	S.T.B.	406
American Thermo Bottle Co., Brooklyn, N. Y.....	Bal.	228
American Thermo Ware Co., New York City.....	B.	514
Austro-American Separator Co., Cleveland.....	Bal.	224
A. O. Brictson, Brookings, S. D.....	T.T.B.	440
Caloria Mfg. Co., Philadelphia.....	S.T.B.	418
Class Journal Co. ("Motor Age"), Chicago.....	B.	504
Class Journal Co. ("Automobile"), New York City.....	B.	505
Chandler Co. (Inc.), Pittsburg, Pa.....	E.P.	141
Chilton Printing Co., Philadelphia.....	B.	515
Columbia Nut & Bolt Co. (Inc.), Bridgeport, Conn.....	S.T.B.	404
M. H. Cormack & Co., 1876 B'way, New York City.....	Bal.	247
Commercial Acetylene Co., 80 B'way, New York City.....	B.	521
C. J. Downing, 54 Warren St., New York City.....	B.	502
Hill Dryer Co., Worcester, Mass.....	B.	513a
H & C Bottle Mfg. Co., 652 B'way, New York City.....	T.T.B.	439
Jarman & Baker, 1779 B'way, New York City.....	Bal.	237
Julius Lucas & Co., Lane, New York City.....	T.T.B.	438
Julius King Optical Co., 10 Maiden Lane, New York.....	B.	510
John Lucas & Co., 89 Maiden Lane, New York City.....	T.T.B.	438
Morrison Ricker Mfg. Co., Grinnell, Ia.....	Bal.	209
N. Y. Sporting Goods Co., 17 Warren St., New York.....	Bal.	210
Nathan Novelty Mfg. Co., 84 Reade St., New York.....	B.	569
Post & Lester Co., Hartford, Conn.....	B.	526
Pleerson Motor Supply Co., New York City.....	Bal.	215
P. Rielly & Son, Newark, N. J.....	Bal.	285
Standard Welding Co., Cleveland.....	E.P.	163
Valentine & Co., 257 Broadway, New York City.....	E.P.	177

ACTUAL CARS ON EXHIBITION AT THE GARDEN

STANDARDIZED automobiles, in so far as the word can be made to apply to any industry that expects to keep step with time, is the proper phraseology to apply to the cars for the Garden. Even a cursory examination of the tabulation given in conjunction with this discussion will be enough to convince anyone who may have been at all familiar with the situation that the A. L. A. M. has gone into the matter on a basis which has for its underlying strata the standardization of the parts, and, to the extent possible, the standardization of the types of cars.

In some respects it is quite out of the question to gain headway in the matter of fixing upon standards, especially if reference is had to certain special applications along lines in which deviations have to be made to suit local conditions. On the other hand, it is better to try to crystallize the cars than to go on making things different year after year, with the full assurance that all the changes cannot possibly be right, any more than it is a fact that every man who goes into business will make a go of it.

In car building it has long been the custom to follow standards, and the M. C. B. (Master Car Builders) rule is followed in the design of all the devices that can with safety be reduced to a standard, without throttling the progress that is so important in any industry. The argument has been advanced to the effect that standardizing will tie the hands of designers and throttle genius. In this connection it would not be out of order to say that the designer who could be so easily flagged would scarcely be capable of evolving anything that an autoist would want to pay money for. Then, there is the success of the M. C. B. to be noted. Certainly, railroad cars were not reduced to anything but quality as the result of standardizing, and it is not easy to show anything but advantage from the process. Indeed, not only the quality of the work and the cost, but the progress made can be directly traced to the fact that the M. C. B. did regulate in so far as standards can be fixed and up to the limit of the ability of a body of representative men to agree.

The Garden cars will show the result of the several years of careful consideration that they have received at the hands of the engineers, who met on occasions, and in converse exchanged ideas and arrived at conclusions. It is not to be supposed that they agreed on every point, nor can it be said that they used all the ideas that went the rounds. What they did do was to talk it over, and in doing so it is assured that each was the better able to cope with his own problem after he listened to the objections as they were put before him at the hands of able critics of no mean ability.

Garden Show Cars Tried Out.

Of course there are the builders of devices, even automobiles, who prefer to try their product out in public, and even on the public. One might ask, Does it pay? On the other hand, it is rather an advantage of the cars at the Garden that they are tried out. The public does not have to consider this phase of the problem; the same public is in possession of much definite information in relation to the performance of the cars. There is one other phase of the subject that will stand mention in this connection. Take, for illustration, the companies that do bring out new models for the first time; they should be able to avoid mistakes if they have a source of reliable information such as is the case with the companies at the Garden.

On the whole, then, the cars as they will follow do represent the accumulated knowledge of half a decade, pyramided and placed at the disposal of the men behind the automobiles on exhibition. This may be the reason why they look more or less alike. In a word, they are alike in all the standard features on which the engineers could agree in every case in which the cars are for a given class of service. This is not to say that the touring cars, for illustration, are prototypes of each other, though they all have chassis frames of the channel section, with one or two notable exceptions, as Franklin, using the laminated wood frame. All use ball or roller bearings in the hubs of the road wheels, and all follow out certain safe practices in this regard.

Likewise, crankshaft work is on a basis which differs but little between the cars, even if all the cars do not have motors with crankshafts of the same dimensions, although it is possible that all may have limiting values of the extreme fiber strain and all may have kinetic ability parallel to the kinetic work. These are the matters which make the differences in the long run, and unfortunately they are the questions that will be the hardest to put before the buyers of cars in a manner to be convincing.

It will be quite easy to lay bare the body work of the cars of the year, since in this important part of the cars good common sense has taken charge, and the straight line effect in the body work is but a fitting indication of the straightforward work that will be found in about every case under the handsome finish. As a general rule the wheelbase in the 1909 cars is longer than formerly, and this is turn indicates more room in the cars. The lengthening has been in all the types of cars, from the little runabout to the big touring car, with the exception of the town car and taxicab types, where they have been kept short, to give a good turning radius in the congested streets of the cities.

Good Representation of "Sixes."

The power plants in the 1909 cars are well divided, in that there is a fair sprinkling of the "sixes," and the "fours" are in profusion, with the usual number of the "double opposed" and just as many single-cylinder motors as last year. As to the power of the motors, some say the big power plants are on the wane; but it is a case of more of the small-power plants than formerly, not less of the plants of the larger rating. In other words, it may be true that there is a big demand for cars of medium power, to some extent taking the place of the demand for runabout types of cars, but it is also a fact that the users of the cars with the large power plants are in great presence, and they are demanding more, not less, power.

As respects transmissions, the selective type seems to be in the majority, and direct high is the most used combination. Some hold to the progressive; there is at least one semi-progressive; and planetary gears are as before used in certain classes of work. The workmanship is on a high plane, using alloy steel or special grades of steel in about every case. The levers and linkages are well designed, and the materials are good. There are examples of the "left-hand steer" to be seen, and it may be the plan will grow to very wide proportions.

There is a decided tendency to use better wheels, and the rims are largely of the "demountable" or other "quick detach" plan. Spare wheels are used, some with rims only. In other cases the entire wheel is furnished.

GASOLINE PLEASURE VEHICLES

MAKE AND MODEL	Price	A. I. A. M. H. P. Rating	CYLINDERS				IGNITION			TRANSMIS'N			TIRES		BODY				
			Bore	Stroke	No.	Wheelbase	Radiator	Magneto	Battery	Clutch	Type	Speeds	Drive	Brakes	Front	Rear	Type	Seats	
WALTHAM-17	\$350	4	3 1/4	4 1/4	1	84	Air		Drv.		Disc.	Fric. Plan.	5	Ch'ns	2	26x2 1/2	26x2 1/2	B'kb'rd	1
CADILLAC-T	\$950	10	5	5	1	82	Tubular		Dry.		Disc.		2	Chain	2	30x3	30x3	Tour.g.	4

CARS COSTING \$1000 OR LESS

WALTHAM-17	\$350	4	3 1/4	4 1/4	1	84	Air		Drv.		Disc.	Fric. Plan.	5	Ch'ns	2	26x2 1/2	26x2 1/2	B'kb'rd	1
CADILLAC-T	\$950	10	5	5	1	82	Tubular		Dry.		Disc.		2	Chain	2	30x3	30x3	Tour.g.	4

CARS COSTING BETWEEN \$1000 AND \$2000

E-M-F-30	\$1,250	25	4	4 1/4	4	106	Tubular	H. T.	Dry.		Ex. Ring	Sel.	3	Shaft	4	32x3 1/2	32x3 1/2	R'dster.	3
E-M-F-30	\$1,250	25	4	4 1/4	4	106	Tubular	H. T.	Dry.		Ex. Ring	Sel.	3	Shaft	4	32x3 1/2	32x3 1/2	Tour'bt	4
E-M-F-30	\$1,250	25	4	4 1/4	4	106	Tubular	H. T.	Dry.		Ex. Ring	Sel.	3	Shaft	4	32x3 1/2	32x3 1/2	S. Ton.	4
E-M-F-30	\$1,250	25	4	4 1/4	4	106	Tubular	H. T.	Dry.		Ex. Ring	Sel.	3	Shaft	4	32x3 1/2	32x3 1/2	Tour.g.	5
CADILLAC-30	\$1,400	25	4	4 1/4	4	106	Tubular		D. & St'ge		Cone.	Sel.	3	Shaft	4	32x3 1/2	32x3 1/2	R'dster.	3
CADILLAC-30	\$1,400	25	4	4 1/4	4	106	Tubular		D. & St'ge		Cone.	Sel.	3	Shaft	4	32x3 1/2	32x3 1/2	S. Ton.	4
CADILLAC-30	\$1,400	25	4	4 1/4	4	106	Tubular		D. & St'ge		Cone.	Sel.	3	Shaft	4	32x3 1/2	32x3 1/2	Tour.g.	5
CHALMERS-DETROIT-30	\$1,500	24	3 3/4	4 1/4	4	110	Tubular		Storage.	Mul. Disc.	Sel.	3	Shaft	3	32x3 1/2	32x3 1/2	R'bout.	3 or 4	
CHALMERS-DETROIT-30	\$1,500	24	3 3/4	4 1/4	4	110	Tubular		Storage.	Mul. Disc.	Sel.	3	Shaft	3	32x3 1/2	32x3 1/2	Tour.g.	5	
ELMORE-33	\$1,750	2-cylinder	4 1/2	4 1/2	4	104	H'comb.	A. K. G.	Dry.		Ex. Ring	Sel.	3	Shaft	4	32x4	32x4	R'dster.	3 or 4
ELMORE-33	\$1,750	2-cylinder	4 1/2	4 1/2	4	104	H'comb.	A. K. G.	Dry.		Ex. Ring	Sel.	3	Shaft	4	32x4	32x4	Tour.g.	5
FRANKLIN-G	\$1,850	18	3 3/4	4 1/4	4	91 1/2	Air	H. T.			Mul. Disc.	Prog.	3	Shaft	3	32x3 1/2	32x3 1/2	Tour.g.	4
SELDEN-29	\$2,000	29	4 1/4	4 1/4	4	114	Tubular				Cone.	Sel.	3	Shaft	4	34x3 1/2	34x3 1/2	R'dster.	3 or 4
SELDEN-29	\$2,000	29	4 1/4	4 1/4	4	114	Tubular				Cone.	Sel.	3	Shaft	4	34x3 1/2	34x4	Tour.g.	5

CARS COSTING BETWEEN \$2000 AND \$3000

PALMER-SINGER-32	\$2,250	28	4 1/4	4 3/4	4	107	H'comb.	H. T.			Mul. Disc.	Sel.	4	Shaft	4	34x4	34x4	R'bout.	2
ELMORE-33	\$2,250	2-cylinder	4 1/2	4 1/2	4	104	H'comb.	A. K. G.	Dry.		Ex. Ring	Sel.	3	Shaft	4	32x4	32x4	Land'l't	7
APPERSON-O	\$2,450	30	4 3/8	5	4	119	Tubular	H. T.			Con. B'd	Sel.	3	Shaft	4	34x4	34x4	Tour.g.	5
CHALMERS-DETROIT-30	\$2,500	24	3 3/4	4 1/4	4	110	Tubular				Mul. Disc.	Sel.	3	Shaft	3	32x3 1/2	32x3 1/2	Lim'sne	7
CORBIN-O2 or S2	\$2,500	32	4 1/2	4 1/4	4	108	H'comb.		D. & St'ge		Cone.	Sel.	3	Shaft	4	32x3 1/2	32x4	Tour.g.	3 or 4
CORBIN-K2 or R2	\$2,500	32	4 1/2	4 1/4	4	108	H'comb.		D. & St'ge		Cone.	Sel.	3	Shaft	4	34x3 1/2	34x4	Tour.g.	5
ELMORE-44	\$2,500	2-cylinder	4 1/2	4 1/2	4	110	H'comb.	A. K. G.	Dry.		Ex. Ring	Sel.	3	Shaft	4	34x4	34x4	Tour.g.	5
CORBIN-O2 or S2	\$2,650	32	4 1/2	4 1/4	4	108	H'comb.		D. & St'ge		Cone.	Sel.	3	Shaft	4	32x3 1/2	32x4	S. Ton.	4
COLUMBIA-48	\$2,750	29	4 1/4	4 1/2	4	115	Cellular.	L. T.			Cone.	Sel.	3	Shaft	4	34x3 1/2	34x4	Tour.g.	5
CHALMERS-DETROIT-40	\$2,750	40	5	4 3/4	4	112	Tubular				Cone.	Sel.	3	Shaft	3	34x4	34x4	R'bout.	3 or 4
CHALMERS-DETROIT-40	\$2,750	40	5	4 3/4	4	112	Tubular				Cone.	Sel.	3	Shaft	3	34x4	34x4	Tour.g.	5
POPE-HARTFORD-S	\$2,750	30	4 5/8	5 1/8	4	114	Planetic		D. & St'ge		Cone.	Sel.	3	Shaft	3	34x4	34x4	S. Ton.	4
POPE-HARTFORD-S	\$2,750	30	4 5/8	5 1/8	4	114	Planetic		D. & St'ge		Cone.	Sel.	3	Shaft	3	34x4	34x4	Tour.g.	5
STEVENS-DURYEA-X	\$2,750	36	4 3/4	4 1/2	4	124	Cellular.				Mul. Disc.	Prog.	3	Shaft	4	34x4	34x4	Tour.g.	5
FRANKLIN-D	\$2,800	28	4 1/4	4	4	106	Air	H. T.			Mul. Disc.	Sel.	3	Shaft	3	36x3 1/2	36x4	Tour.g.	5
STEVENS-DURYEA-XXX	\$2,850	36	4 3/4	4 1/2	4	109	Cellular.	H. T.	Dry.		Mul. Disc.	Prog.	3	Shaft	4	36x3 1/2	36x4	R'bout.	3
POPE-HARTFORD-S	\$2,815	30	4 5/8	5 1/8	4	114	Planetic		D. & St'ge		Cone.	Sel.	3	Shaft	3	34x4	34x4	R'dster.	5
HAYNES-XI	\$2,900	36	4 3/4	5	4	112	Cellular.	H. T.	Dry.		Con. B'd	Sel.	3	Shaft	4	36x4	36x4	R'bout.	3
KNOX-O	\$2,900	38	4 3/4	4 3/4	4	102	Cellular.	H. T.	Dry.		3-Plate.	Sel.	3	Shaft	4	34x4	34x4	R'bout.	4
KNOX-O	\$2,950	38	4 3/4	4 3/4	4	114	Cellular.	H. T.	Dry.		3-Plate.	Sel.	3	Shaft	4	34x4	34x4	S. Ton.	4
APPERSON-M	\$3,000	36	4 3/4	5	4	106	Tubular	H. T.			Con. B'd	Sel.	3	Shaft	4	34x4	34x4	R'bout.	4
KNOX-O	\$3,000	38	4 3/4	4 3/4	4	114	Cellular.	H. T.	Dry.		3-Plate.	Sel.	3	Shaft	4	34x4	34x4	Tour.g.	5
HAYNES-X	\$3,000	36	4 3/4	5	4	112	Cellular.	H. T.	Dry.		Con. B'd	Sel.	3	Shaft	4	36x4	36x4	Tour.g.	7
POPE-HARTFORD-S	\$3,000	30	4 5/8	5 1/8	4	114	Planetic		D. & St'ge		Cone.	Sel.	3	Shaft	3	34x4	34x4	Tour.g.	6
SELDEN-29	\$3,000	29	4 1/4	4 1/4	4	114	Tubular				Cone.	Sel.	3	Shaft	4	34x3 1/2	34x4	Lim'se.	7
THOMAS FLYER-4-16	\$3,000	18	3 3/4	4 5/8	4	103	Tubular	H. T.			3-Disc.	Sel.	3	Shaft	4	32x4	32x4	Br'g'm.	6
THOMAS FLYER-6-40	\$3,000	31	3 3/4	4 5/8	6	122	H'comb.	H. T.	A. K. Gen'r		3-Disc.	Sel.	3	Shaft	4	36x3 1/2	36x4	Flyab't.	4
THOMAS FLYER-6-40	\$3,000	31	3 3/4	4 5/8	6	122	H'comb.	H. T.	A. K. Gen'r		3-Disc.	Sel.	3	Shaft	4	36x3 1/2	36x4	Tour.g.	6
WINTON-6-17	\$3,000	48	4 1/2	5	6	120	Tubular	H. T.	Dry.		Mul. Disc.	Sel.	3	Shaft	4	34x4	34x4 1/2	R'bout.	4
WINTON-6-17	\$3,000	48	4 1/2	5	6	120	Tubular	H. T.	Dry.		Mul. Disc.	Sel.	3	Shaft	4	34x4	34x4 1/2	Tour.g.	5

CARS COSTING BETWEEN \$3000 AND \$4000

PIERCE-ARROW-24	\$3,100	24	3 1/4	4 3/4	4	111 1/2	Cellular.	H. T.		Storage.	Cone.	Sel.	4	Shaft	4	34x3 1/2	34x4	R'bout.	3
STEARNS-15-30	\$3,200	32	4 1/4	4 3/4	4	116	Cellular.	Bosch.	Dry.		Ex. B'd.	Sel.	3	Shaft	4	34x4	34x4	R'bout.	3
STEARNS-15-30	\$3,200	32	4 1/4	4 3/4	4	116	Cellular.	Bosch.	Dry.		Ex. B'd.	Sel.	3	Shaft	4	34x4	34x4	Tour.g.	5
PACKARD-18	\$3,200	26	4 1/4	5 1/8	4	102	Cellular.	L. T.		Storage.	Ex. B'd.	Prog.	3	Shaft	4	34x3 1/2	34x4	R'bout.	3
PACKARD-18	\$3,200	26	4 1/4	5 1/8	4	112	Cellular.	L. T.		Storage.	Ex. B'd.	Prog.	3	Shaft	4	34x4	34x4	Tour.g.	5
PALMER-SINGER-LXII	\$3,250	57	4 1/4	5 1/4	6	126	H'comb.	H. T.			Mul. Disc.	Sel.	4	Shaft	4	36x4	36x4 1/2	R'bout.	3
APPERSON-M	\$3,350	36	4 3/4	5	4	119	Tubular	H. T.			Con. B'd	Sel.	3	Shaft	4	34x4	34x4	Tour.g.	5
CORBIN-14	\$3,500	32	4 1/4	4 1/4	4	114	H'comb.			D. & St'ge	Cone.	Sel.	3	Shaft	4	34x4	34x4 1/2	Limous.	5 or 7
PALMER-SINGER-LXII	\$3,500	57	4 1/4	5 1/4	6	126	H'comb.	H. T.			Mul. Disc.	Sel.	4	Shaft	4	36x4	36x4 1/2	S. Ton.	4
PALMER-SINGER-XXXII	\$3,500	28	4 1/4	4 1/4	4	112	H'comb.	H. T.			Mul. Disc.	Sel.	4	Shaft	4	34x4	34x4	Land'l't.	6
LOCOMOBILE-30	\$3,500	32	4 1/4	4 1/4	4	120	Cellular.	L. T.			Cone.	Sel.	4	Shaft	4	34x4	34x4 1/2	R'bout.	4
LOCOMOBILE-30	\$3,500	32	4 1/4	4 1/4	4	120	Cellular.	L. T.			Cone.	Sel.	4	Shaft	4	34x4	34x4 1/2	Tour.g.	5
ROYAL TOURIST-Y	\$3,500	42	5 1/4	5 1/4	4	118	H'comb.	H. T.		Storage.	Cone.	Prog.	3	Shaft	3	34x4 1/2	34x4 1/2	Cl. C. pd	4
ROYAL TOURIST-X	\$3,500	42	5 1/4	5 1/4	4	114	H'comb.	H. T.		Storage.	Cone.	Prog.	3	Shaft	3	36x4 1/2	36x4 1/2	Tour.g.	7
STEVENS-DURYEA-U	\$3,500	36	3 3/4	4 3/4	6	114	Cellular.			D. & St'ge	Mul. Disc.	Prog.	3	Shaft	4	34x4	34x4	Tour.g.	5
STUDEBAKER-A	\$3,500	27	4 1/4	5 1/4	4	104	Cellular.	L. T.			Cone.	Prog.	3	Shaft	3	34x4	34x4	Sub'b'n	4
LOZIER-Little Six	\$3,500	33	3 1/2	4 1/2	6	116	H'comb.	H. T.		Storage.	Mul. Disc.	Sel.	3	Shaft	4	36x3			

GASOLINE PLEASURE VEHICLES (Cont.)

MAKE AND MODEL	Price	A. L. A. M. H. P. Rating	CYLINDERS			Wheelbase	Radiator	IGNITION		Clutch	TRANSMIS'N			TIRES		BODY		
			Bore	Stroke	No.			Magneto	Battery		Type	Speeds	Drive	Brakes	Front	Rear	Type	Seats
CARS COSTING BETWEEN \$4000 AND \$5000																		
PACKARD—30	\$4,200	40	5	5 1/4	4	108	Cellular	L. T.	Storage	Ex. B'd.	Prog.	4	Sh'ft.	4	36x3 1/2	36x4 1/2	R'bout.	3
PACKARD—30	\$4,200	40	5	5 1/4	4	123	Cellular	L. T.	Storage	Ex. B'd.	Prog.	4	Sh'ft.	4	36x4	36x4 1/2	Cl. C'pd	5
PACKARD—30	\$4,200	40	5	5 1/4	4	123	Cellular	L. T.	Storage	Ex. B'd.	Prog.	4	Sh'ft.	4	36x4	36x4 1/2	Tour.g.	7
WINTON—6-17	\$4,250	48	4 1/2	5 1/4	6	120	Tubular	H. T.	Dry	Mul. Disc	Sel.	3	Sh'ft.	4	34x4	34x4 1/2	Lim's.e.	5
PEERLESS—19	\$4,300	38	4 1/2	5 1/4	4	118 1/2	Tubular	L. T.	Storage	Ex. B'd.	Sel.	4	Sh'ft.	4	36x4	36x4 1/2	R'dster.	3
PEERLESS—19	\$4,300	38	4 1/2	5 1/4	4	122	Tubular	L. T.	Storage	Ex. B'd.	Sel.	4	Sh'ft.	4	36x4	36x4 1/2	Cl. C'pd	5
PEERLESS—19	\$4,300	38	4 1/2	5 1/4	4	122	Tubular	L. T.	Storage	Ex. B'd.	Sel.	4	Sh'ft.	4	36x4	36x4 1/2	Tour.g.	7
PACKARD—18	\$4,300	26	4 1/4	5 1/4	4	112	Cellular	L. T.	Storage	Ex. B'd.	Prog.	3	Sh'ft.	4	34x4	34x4 1/2	Lim's.e.	7
PACKARD—18	\$4,400	26	4 1/4	5 1/4	4	112	Cellular	L. T.	Storage	Ex. B'd.	Prog.	3	Sh'ft.	4	34x4	34x4 1/2	Land't.	7
WINTON—6-18	\$4,500	60	5	5 1/4	6	130	Tubular	H. T.	Dry	Mul. Disc	Sel.	4	Sh'ft.	4	36x4	36x4 1/2	Tour.g.	7
LOCOMOBILE—40	\$4,500	40	5	6	4	123	Cellular	L. T.	Cone	Sel.	4	Ch'ns	3	36x4	36x4 1/2	S. Ton.	4	
LOCOMOBILE—40	\$4,500	40	5	6	4	123	Cellular	L. T.	Cone	Sel.	4	Ch'ns	3	36x4	36x4 1/2	Tour.g.	7	
MATHESON—E	\$4,500	40	5	6	4	128	H'comb.	L. T.	Mul. Disc	Sel.	4	Ch'ns	4	36x4	36x5	Tour.g.	7	
POPE-TOLEDO—X XI	\$4,500	38	4 3/4	5 3/4	4	115	Planetic	H. T.	Storage	Mul. Disc	Sel.	4	Ch'ns	3	36x4	36x4 1/2	R'bout.	4
POPE-TOLEDO—X XII	\$4,500	38	4 3/4	5 3/4	4	126	Planetic	H. T.	Storage	Mul. Disc	Sel.	4	Ch'ns	3	36x4	36x4 1/2	Tour.g.	7
ROYAL TOURIST—M	\$4,500	48	5 1/2	6	4	126	H'comb.	H. T.	Storage	Cone	Sel.	4	Sh'ft.	3	36x4 1/2	36x5	Tour.g.	7
THOMAS FLYER—6-40	\$4,500	31	3 3/8	4 3/8	6	122	H'comb.	H. T.	A.K.G'r	3-Disc.	Sel.	3	Sh'ft.	4	36x3 1/2	36x4	Lim's.e.	6
THOMAS FLYER—4-60	\$4,500	53	5 1/4	5 1/4	4	127	H'comb.	H. T.	3-Disc.	Sel.	4	Ch'ns	4	36x4	36x5	Tour.g.	7	
STEARNS—30-60	\$4,600	46	5 1/4	5 1/4	4	121	Cellular	H. T.	Dry	Ex. B'd.	Sel.	4	Ch'ns	3	36x4	36x4 1/2	S. Ton.	4
STEARNS—30-60	\$4,600	46	5 1/4	5 1/4	4	124	Cellular	H. T.	Dry	Ex. B'd.	Sel.	4	Sh'ft.	4	36x4	36x4 1/2	Tour.g.	7
PIERCE-ARROW—36	\$4,650	36	3 1/4	4 3/4	6	119	Cellular	H. T.	Storage	Cone	Sel.	4	Sh'ft.	4	34x4	34x4 1/2	B'gh'm	5
APPERSON—K	\$4,700	48	5 1/2	5 1/2	4	122	Cellular	H. T.	Storage	Con. B'd	Sel.	4	Op't'l	3	34x4	34x4 1/2	Tour.g.	7
STEARNS—30-60	\$4,750	46	5 1/4	5 1/4	4	121	Cellular	H. T.	Dry	Ex. B'd.	Sel.	4	Ch'ns	3	36x4	36x5	Pull'm'n	7
PIERCE-ARROW—48	\$4,800	48	4 1/2	4 3/4	6	130	Cellular	H. T.	Storage	Cone	Sel.	4	Sh'ft.	4	36x4	36x4 1/2	Tour.g.	4
KNOX—M	\$5,000	48	5 1/4	5 1/4	4	127	Cellular	H. T.	Dry	3-Disc.	Sel.	4	Ch'ns	3	36x4 1/2	36x5	Tour.g.	7
LOZIER—H	\$5,000	44	5 1/4	5 1/4	4	124	H'comb.	H. T.	Storage	Mul. Disc	Sel.	4	Sh'ft.	4	36x4	36x4 1/2	Br'cliff.	5
LOZIER—H	\$5,000	44	5 1/4	5 1/4	4	124	H'comb.	H. T.	Storage	Mul. Disc	Sel.	4	Sh'ft.	4	36x4	36x5	Tour.g.	7
STUDEBAKER—D	\$5,000	36	4 1/4	5 1/4	4	117	Cellular	L. T.	Storage	Cone	Sel.	4	Sh'ft.	4	36x4 1/2	36x4 1/2	Lim's.e.	7
WALTER—M	\$5,000	48	5 1/4	5 1/4	4	122	H'comb.	H. T.	Storage	Cone	Sel.	4	Sh'ft.	4	36x4	36x5	Tour.g.	7

CARS COSTING ABOVE \$5000

STUDEBAKER—B	\$5,100	36	4 3/4	5 1/4	4	114	Cellular	L. T.	Cone	Sel.	4	Sh'ft.	4	34x4 1/2	34x4 1/2	Land't	7	
PIERCE-ARROW—40	\$5,400	40	5	5 1/2	4	124	Cellular	L. T.	Storage	Cone	Sel.	4	Sh'ft.	4	36x4 1/2	36x5	Lim's.e.	7
PEERLESS—19	\$5,500	38	4 3/4	5 1/2	4	122	Tubular	L. T.	Storage	Ex. B'd.	Sel.	4	Sh'ft.	4	36x4	36x5	Lim's.e.	7
PACKARD—30	\$5,550	40	5	5 1/2	4	123 1/2	Cellular	L. T.	Storage	Ex. B'd.	Prog.	3	Sh'ft.	4	36x4	36x4 1/2	Lim's.e.	7
PACKARD—30	\$5,650	40	5	5 1/2	4	123 1/2	Cellular	L. T.	Storage	Ex. B'd.	Prog.	3	Sh'ft.	4	36x4	36x4 1/2	Land't	7
ROYAL TOURIST—M	\$5,700	48	5 1/2	6	4	126	H'comb.	H. T.	Cone	Sel.	4	Sh'ft.	3	36x4 1/2	36x5	Lim's.e.	7	
SIMPLEX	\$5,750	53	5 1/4	5 1/4	4	124	H'comb.	H. T.	Mul. Disc	Sel.	4	Ch'ns	4	36x4	36x5	Sp'd C'r	2	
SIMPLEX	\$5,750	53	5 1/4	5 1/4	4	127	H'comb.	H. T.	Mul. Disc	Sel.	4	Ch'ns	4	36x4	36x5	S. Car.	5	
SIMPLEX	\$5,750	53	5 1/4	5 1/4	4	127	H'comb.	H. T.	Mul. Disc	Sel.	4	Ch'ns	4	36x4	36x5	Tour.g.	7	
STEARNS—30-60	\$5,750	46	5 1/4	5 1/4	4	121	Cellular	H. T.	Dry	Ex. B'd.	Sel.	4	Ch'ns	3	36x4	36x5	Lim's.e.	5
PEERLESS—19	\$5,800	38	4 3/4	5 1/4	4	122	Tubular	L. T.	Storage	Ex. B'd.	Sel.	4	Sh'ft.	4	36x4	36x5	Land't	7
LOCOMOBILE—40	\$5,900	40	5	6	4	123	Cellular	L. T.	Cone	Sel.	4	Ch'ns	3	36x4	36x5	Lim's.e.	7	
LOZIER—H	\$6,000	44	5 1/4	5 1/4	4	124	H'comb.	H. T.	Storage	Mul. Disc	Sel.	4	Sh'ft.	4	36x4	36x5	Lim's.e.	7
LOZIER—I	\$6,000	51	4 3/4	5 1/2	6	131	H'comb.	H. T.	Storage	Mul. Disc	Sel.	4	Sh'ft.	4	36x4	36x5	Tour.g.	7
PEERLESS—26	\$6,000	57	4 3/4	5 1/2	6	136	Tubular	L. T.	Storage	Ex. B'd.	Sel.	4	Sh'ft.	4	36x4	36x5	Tour.g.	7
PIERCE-ARROW—60	\$6,000	60	5	5 1/2	6	135	Cellular	H. T.	Storage	Cone	Sel.	4	Sh'ft.	4	36x4 1/2	36x5	Tour.g.	7
THOMAS FLYER—4-60	\$6,000	53	5 1/4	5 1/4	4	127	H'comb.	H. T.	A.K. Gen	3-Disc.	Sel.	4	Ch'ns	4	36x4	36x5	Tour.g.	7
THOMAS FLYER—6-70	\$6,000	72	5 1/2	5 1/2	6	140	H'comb.	H. T.	A.K. Gen	3-Disc.	Sel.	4	Ch'ns	4	36x4 1/2	36x5	Lim's.e.	7
PIERCE—48	\$6,200	48	4 1/2	4 3/4	6	130	Cellular	H. T.	Storage	Cone	Sel.	4	Sh'ft.	4	36x4	36x5	Land't	7
SIMPLEX	\$6,750	53	5 1/4	5 1/4	4	127	H'comb.	H. T.	Storage	Mul. Disc	Sel.	4	Ch'ns	4	36x4	36x5	Land't	7
PEERLESS—26	\$7,000	57	4 3/4	5 1/2	6	136	Tubular	L. T.	Storage	Ex. B'd.	Sel.	4	Sh'ft.	4	36x4	36x5	Lim's.e.	7
PEERLESS—26	\$7,200	57	4 3/4	5 1/2	6	136	Tubular	L. T.	Storage	Ex. B'd.	Sel.	4	Sh'ft.	4	36x4	36x5	Land't	7

ELECTRIC PLEASURE VEHICLES

MAKE AND MODEL	Price	BODY		Wheelbase	No. Motors	BATTERY		Drive	Brakes	Steering	TIRES	
		Type	Seats			No. Cells	Type				Front	Rear
COLUMBIA	\$1,600	Phaeton	2	70	1	32	Exide	Chain	2	Wheel	30x3 1/2	30x3 1/2
BABCOCK	\$2,000	Roadster	3	92	1	42	Babcock	Chains	2	Wheel	32x3	32x3 1/2
BABCOCK	\$2,500	Town Car	4	92	1	42	Babcock	Chains	2	Wheel	32x4	32x4 1/2
BABCOCK—6	\$1,700	Phaeton	2	78	1	36	Babcock	Chains	3	Wheel	32x3	32x3 1/2
BABCOCK—1	\$1,800	Special	2	66	1	40	Babcock	Chains	3	Wheel	32x3	36x3 1/2
BABCOCK—10	\$2,100	Coupe	2	78	1	36	Babcock	Chains	3	Wheel	32x3 1/2	32x3 1/2
BABCOCK—7	\$4,000	Brougham	7	92	2	40	Babcock	Gear	3	Wheel	32x3 1/2	36x4
BAKER—R	\$1,850	Runabout	2	70	1	30	Exide	Chain	4	Wheel	32x3	32x3 1/2
BAKER	\$2,500	Coupe	2	70	1	28	Exide	Chain	4	Lever	32x3	32x3 1/2
BAKER—L	\$1,850	Victoria	2	70	1	24	Exide	Chain	4	Lever	30x3	30x3 1/2
BAKER—M	\$2,500	Roadster	3	95	1	40	Exide	Shaft	3	Wheel	34x4	34x4 1/2
BAKER—I	\$4,000	Brougham	6	87	1	40	Exide	Shaft	4	Wheel	34x4	34x4 1/2
STUDEBAKER	Coupe	2	67	1	24	Chain	2	Lever	30x3	30x3 1/2
STUDEBAKER	Stanhope	2	73	1	36	Chain	2	Lever	30x4	30x4

ELECTRIC PLEASURE VEHICLES (Cont.)

MAKE AND MODEL	Price	BODY		Wheelbase	No. Motors	BATTERY		Drive	Brakes	Steering	TIRES	
		Type	Seats			No. Cells	Type				Front	Rear
WAVERLY-74	\$1,500	Stanhope	2	70	1	30	Exide	Ch. & Gr	3	Lever	30x3	30x4
WAVERLY-75C	2,150	Victoria	4	65	1	30	Exide	Ch. & Gr	3	Lever	30x4	30x4
WOODS-214	2,100	Victoria	4	73 1/2	1	40	Exide	Chain	3	Lever	30x3 1/2	34x3 1/2
WOODS-214A	2,700	Combination	4	73 1/2	1	40	Exide	Chain	3	Lever	30x3 1/2	34x3 1/2
DETROIT-L	1,350	Roadster	2	87	1	16	Optional	Gears	2	Optional	32x3 1/2	32x3 1/2
DETROIT-A	1,850	Victoria	2	74	1	24	Optional	Chain	2	Lever	32x3 1/2	32x4
DETROIT-B	1,900	Victoria	2	74	1	24	Optional	Chain	2	Lever	32x3 1/2	32x4
DETROIT-C	2,250	Coupe	2	74	1	24	Optional	Chain	2	Lever	32x3 1/2	32x4
DETROIT-D	2,400	Brougham	4	74	1	24	Optional	Chain	2	Lever	32x3 1/2	32x4
RAUCH & LANG-10	1,900	Stanhope	2	74	1	24	Exide	Chain	2	Lever	32x3 1/2	32x3 1/2
RAUCH & LANG-12	2,050	Stanhope	2	74	1	24	Exide	Chain	2	Lever	34x3 1/2	34x3 1/2
RAUCH & LANG-13	2,200	Victoria	4	82	1	24	Exide	Chain	2	Lever	32x3 1/2	34x3 1/2
RAUCH & LANG-144S	2,700	Coupe	4	82	1	40	Exide	Chain	2	Lever	34x4	34x4
RAUCH & LANG-144	2,800	Coupe	4	82	1	40	Exide	Chain	2	Lever	34x4	34x4

STEAM PLEASURE VEHICLES.

MODEL	Price	H. P.	ENGINE		Stroke	Wheelbase	Brakes	TIRES		BODY	
			No. Cyl-inders	BORE				Front	Rear	Type	Seats
			H. P.	L. P.							
WHITE-O	\$2,000	20	2	4 1/2	3	104	4	32x3 1/2	32x3 1/2	Touring...	5
WHITE-M	\$4,000	40	2	3 1/2	4 1/2	122	4	36x4	36x5	Touring...	5

COMMERCIAL VEHICLES

MAKE AND MODEL	Price	A. I. A. M. Rating H.P.	CYLIND'RS			Wheelbase	Radiator	IGNITION		Clutch	TRANSMISS'N			TIRES		BODY		
			Bore	Stroke	No.			Magn'o	Battery		Type	Speeds	Drive	Brakes	Front	Rear	Type	Capacity
KNOX-20	\$1,400	12	5	8	1	85	Air				Plan	2	Ch's	4	32x3	36x3	Chassis	4 Ton
AUTOCAR-18	\$2,225	18	4 3/4	4 1/2	2	85-97	Tubular	H. M.	Dry	Ring	3	Sh'ft	3	32x3 1/2	32x3 1/2	Utility	1 Ton	
STUDEBAKER-2007	\$2,300	2 M'trs	Elec	tric		92								36x3	42x3	Delivery	1500 lbs	
STUDEBAKER	\$2,500	2 M'trs	Elec	tric		92								36x3	42x3	Amb'l'ce		
STUDEBAKER-2008	\$2,700	2 Mot'rs	Elec	tric		111								36x4	42x4	Truck	1 1/2 Tons	
HEWITT	\$3,000	24	5 1/2	5	2	109	Cellular	H. T.		Cone	Plan	2	Ch's	3	34x4	34x3 1/2 D'1	Truck	2 Tons
PACKARD	\$3,850	32	4 1/2	5 1/2	4	144	Tubular	L. T.	Storage	Ex. B'd	Prog	3	Ch's	4	4	4 D'1	Truck	3 Tons
KNOX-18	\$4,300	50	5 1/2	5 1/2	4	154	Cellular	H. T.	Dry	Mul. Disc	3	Ch's	4	36x5	36x4 D'1	Chassis	5 Tons	
SAMPSON-49a	\$4,500	40	5	5	4	134	Tubular	H. T.	Dry	Cone	Sel.	4	Ch's	3	36x4 D'1	36x4 D'1	Truck	4 Tons
STUDEBAKER-2012	\$4,500	2 Mot'rs	Elec	tric		126								36x7	36x4 D'1	Truck	5 Tons	
HEWITT	\$5,000	28	4 1/4	4	4	138	Cellular	H. T.		Cone	Plan	2	Ch's	3	36x4 D'1	36x5 D'1	Truck	5 Tons
POPE-HARTFORD		30	4 1/2	5 1/4	4	130		H. T.	Storage	Cone	Sel.	3	Sh'ft	4	34x5	34x5	Amb'l'ce	
POPE-HARTFORD		30	4 1/2	5 1/4	4	130		H. T.	Storage	Cone	Sel.	3	Sh'ft	4	34x5	34x5	P. or Fire	
GENERAL VEH. CO.		1 Motor	Elec	tric													Delivery	350 lbs.
GENERAL VEH. CO.		1 Motor	Elec	tric													Delivery	1 Ton
GENERAL VEH. CO.		1 Motor	Elec	tric													Delivery	1 Ton
GENERAL VEH. CO.		1 Motor	Elec	tric													Truck	2 Tons
GENERAL VEH. CO.		1 Motor	Elec	tric													Truck	3 1/2 Tons
GENERAL VEH. CO.		1 Motor	Elec	tric													Truck	5 Tons
CHAMPION		1 Motor	Elec	tric		80								36x3	36x3		Delivery	1/2 Ton

THE GENERAL SITUATION IN RELATION TO COMMERCIAL VEHICLES.

A cursory examination of the commercial vehicles at the Garden may lead to the hasty conclusion that the commercial situation is a relatively small compass. Let account be taken of the circumstances under which the commercials are compelled to labor, consider the fact that the exhibition is primarily one for the purpose of displaying pleasure vehicles, and the fact will dawn upon the mind of the observer that the commercials in this instance are merely as a tail to a kite. But if any one thinks the tail is lacking in length, then let it be understood that an indoor show of commercials is rather restricting, and also take heed of the fact that the display of commercials at the Garden is incidental to the "big show."

The commercial situation is vast in its spread and it covers a car for every purpose under the sun. The cars as above listed merely serve as an index of the situation in a general way. If a car is desired for any given purpose it is only necessary to make the want known, and a dozen companies will be able to show vehicles in actual service, doing the work in a manner to leave nothing to be desired. Nor does it matter if the service is something special, something to be considered for the first time; the same companies will give the details of the proposed service the benefit of their experience, and if it presents anything of practical value cars will be fitted out for the work, and the results will be all that reason will demand. Under the circumstances it will not be fair to judge of the extent of the commercial situation based upon the cars in the Garden show, or from the number of commercials as shown in the data sheet here afforded.

The reports emanating from responsible sources in relation to the performance of commercial cars has been very encouraging of late; the extent to which the business is expanding is far more comprehensive than most merchants realize and the old line of strictures will find no resting place in the literature of the day.

MECHANICAL ADVANCE OF THE INDUSTRY

By THOS. J. FAY.

SPACIOUS as the Garden is, and broad, the room is insufficient. The A. L. A. M. comes to town, heralded only by confidence in its ability to display automobiles the qualities of which are not to be spoken of in aught but glowing terms. Not that the cars look any better than the superior types of a time ago, dressed as they were in body work of a quality—if color counts—too good even to last; and there were those who were willing to proclaim a short life for some of them at any rate. If this is the year of the moderate price—and the evidence is at hand to make out a fairly good case—it is also the year of accentuated quality.

In other words, this is the year when all the cars have moved up to a higher level, although there probably is a relation between the respective cars that has not changed so much as one would like. The medium-priced cars as they will be seen at the Garden will represent good value indeed.

The time was, and it was not a long time ago, when all attention was paid to the body work, because the purchasers did not know how to judge of the quality of the machinery, and they thought they could tell a good looking body. The body work certainly did cover a multitude of very grievous sins in many cases, and it would not be wide of the mark to predict that the makers of some of the automobiles knew not so very much more, or they would not have had the nerve to show the cars, even if they were covered up by the bodies, which hid the machinery from the eye of any over-critical purchaser. In these little diversions there was little or no attempt at actual deception, since the builders of cars were doing quite well for the time; nor had the patrons, who stood the brunt of it, any great cause to complain.

It is always the privilege of the public at large to take the experiments of an industry, or an art, and by trying the plans out lend the product of their keen observation to the industry. On occasions, when the public is thus put to work—and made to pay the bill besides—they grumble, and it is not uncommon to hear them say that they are being imposed upon, and some of them go so far as to say they are being robbed. This is all nonsense, since it is necessary to experiment to be able to do things right, in time, and no matter how it is done, it is assured that the public must pay the score in the long run. This same public would have a right to complain were it not allowed to work besides. Of course it is nothing but work to try to make a car run, when, as a matter of fact, there is no run in it. Certainly the men who struggled with some of the automobiles of the past will not deny that the cars at the Garden are positively good!

What the Pioneer Buyer Can Observe.

Is it not now a great honor for any man to be able to say: "I paid good money for a car, and it was one of the first, the quality of which was so stubborn that it would not run, despite the price and the labor I lavished upon it"?

A pioneer who can say this can now go to the Garden, and he will get his money's worth in just a look at the automobiles that will run with the same steadiness as the reverse was true of the cars of not-so-long-ago. A pioneer, in such a position, has something to live for, and he can rest assured that the

cars of to-day are the direct result of his bravery, and his blood and money.

It is a wide difference between an automobile in which the respective parts are related to each other in such a way that each will perform its respective part, and an automobile in which it is assured that fully five score of the parts are weak, and that the balance of the members have to struggle with the overload. There is all the difference possible between a car in which each one of the 2,400 parts is stressed in exact accord with its kinetic ability in such a way that they will all fag out at the same day and hour. It will be many a long day ere this will be so. The fact that automobiles look very much alike and have wheels that go around in very much the same way is small indication of the competence of them severally or collectively. There probably is not one absolutely right automobile in the world, and it will be no crime if the next century slips into oblivion without feasting its eyes on perfection by way of an automobile.

This search after kinetic perfection will be a long hunt; it will be up and down the highways and the byways of knowledge, and it will be a "still hunt." In the meantime it is pleasing to note that a certain practical perfection is present in the cars at the Garden, and the men who made the show a possibility should think kindly of the earlier patrons of the industry who paid the bill and kicked so hard about the shame of it. It was the kicks that did so much to advance the industry, and it was the men who paid attention to the kicks that are to be at the Garden with the finest display of cars that the A. L. A. M. ever mustered to the call of the patrons. The call is certain to be answered, too; the patrons are fearing a shortage in number of the cars which command respect.

It would be a fine thing if it were possible so to paint a picture of the situation that all would understand, and it would be possible were the painter of sufficient competence. It is not that the audience is obtuse; it is that the painter has not the skill. Depending, then, upon desire rather than upon skill, it will be to point out a few of the aims for perfection, and the inroads made, in so far as it will be possible to discern them.

The Relation of Materials to Design.

It was long known that steel, and, in fine, all materials had life; that the life is long or short, depending upon the manner in which they are used. When automobiles first came into vogue it was soon learned that the service was of such a character as to "kill" the steel quickly, if the same was of the ordinary grades to be had for the asking in the marts of commerce. It was learned that materials would survive in service, long or short, depending upon the manner in which they were fashioned, and if the extreme fiber strain was maintained within certain relations.

As the industry advanced it was a hunt for materials of a suitable quality on the one hand and a hunt after knowledge of their proper use on the other. Each increment of gain in the direction of better materials was met by an increment of gain of knowledge of their proper use. The result was a gain as the square, or, in accordance with the square law. Each combination of the increments of gain in quality of material, and of knowledge of the proper use of the same, was in

turn put through the same evolution, and the result is a "pyramid" made up of increments of knowledge of the use of materials and of gains in point of quality of same.

Simultaneously there was the elimination of the fallacies—of which there were carloads to spare in the earlier

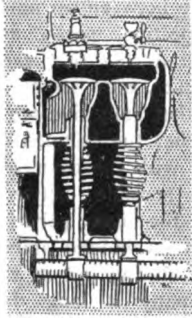

E.M.F. Valves.

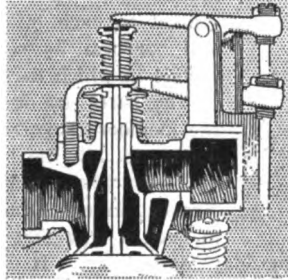

Franklin Valves.

days—and there are a few left. At all events, of fallacies the most bold have been set aside for use by some new industry; nor do they seem to be perishable property. Most of the fallacies came in as a result of the application of "the logic of events." Logic is said to be the chairman of the Ananias Club. Anyway, it is plain that a certain class of logic failed in the automobile business, just as it failed when Col. Sellers tried it on the "Orientals"; there were millions of them, but they were all of precisely the same density, and they all failed to see the point.

The A. L. A. M. Mechanical Branch.

It is just so with the materials; they failed to work on many occasions, possibly for the very reason that they were the logical conclusions. Equally there were a crop of designs that for result did but fittingly illustrate the application of what is sometimes called a zero equation. The A. L. A. M. must have foreseen much of this when the mechanical branch was organized, for in that act is to be seen an attempt to pyramid knowledge, to be accomplished by the discussion of current events, and the concise compilation of the facts resultant from the combined knowledge of the engineers of the several associated companies. The natural result was that materials were improved, and the proper use of the same followed.

In the cars at the show will be found the product of thus pyramiding the knowledge of men, and the materials

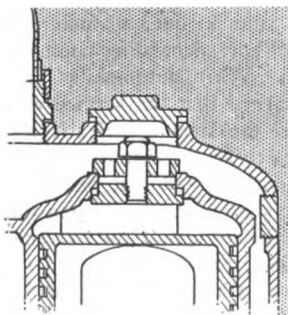

Pierce Cylinder.



Haynes Fan Belt.

are far more capable than ever before. Even without the great improvements in materials it would be possible to foresee that great gains would be the result of thus combining effort, for then harmony in design is bound to follow, and this is a matter of far more importance than the improvements in the qualities that do, in materials,

reside. It is possible to conclude that an harmonious design, even if the materials are bad, will result in a prolonged life, since, if harmony is a phenomenon, each part will bear its own burden and none will be destroyed in the process of doing its neighbor's work.

In a sense it is a great misfortune that materials cannot talk in a language that can be readily understood by men of ordinary skill and understanding. On the other hand, these same materials have a language of their own, and it is the business of the engineer to understand that language. It was one of the ideas of the Mechanical Branch of the A. L. A. M. to interpret the language of the materials used in automobiles, in order that, when the materials would complain of a killing burden, something would be done to relieve the situation.

The Language that Materials Speak.

In this way the situation has been relieved to a vast extent and the cars so treated have advanced until it is a moral certainty that ten years of cut and try would not have done a quarter of the good, that is but the finished task of less than five years of pyramiding on the part of the designers of the cars as they are to be seen at the Garden. As it is to-day, the complaints of materials are comparatively few, and it happens to be the case that users of cars are stilled by the very process that rendered the burden fair.

Formerly it was the practice to consider that materials could be sized up on a basis of certain conventional physical

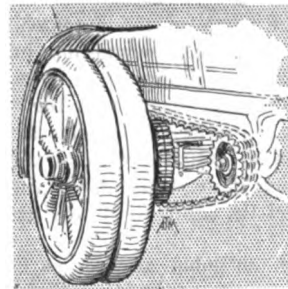

Silent Chain.

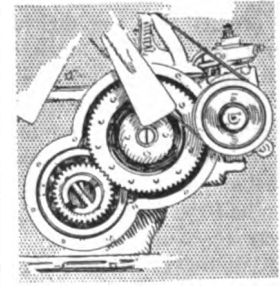

Chalmers Time Gears.

properties, as tensile strength, elastic limit, elongation and reduction of area. True, it was the practice to take into account the compressibility and one or two other phenomena under certain conditions, but the point to be made is, that it was a static basis of fact that received the most, if not all, the consideration, in nearly every case, to the entire neglect, one might say, of the life of the steel, or such other material as may be used on a basis of kinetic loading.

When the Mechanical Branch took hold of the matter it was at a time, just after independent investigators had conclusively shown that the American makers of automobiles were under a handicap, due to the use of inferior materials. It was slowly brought to the notice of the builders of cars that the foreigners had it largely their own way, due to the fact that the foreign steel makers were in the habit of co-operating with the users, on a basis to bring about the best result, while in America it was the practice of the steel makers to "hoot" for quantity and let the quality follow as best it might.

When the A. L. A. M. began to look into the matter it was quickly found that a laboratory was as necessary as the materials, and the diversity of thought that found expression had to be classified even to the extent of culling out much that may have been of abstract value, which could not, for certain reasons, be taken into account in

connection with automobile work. The laboratory was established, and that it was fairly well fitted out is apparent from the results attained in being able to talk to the materials, as it were, thereby to ascertain their wishes (ability), with a view of locating them in the places they might serve to the greatest advantage.

It was soon found that materials could not be used to advantage on a basis of the static tests, nor was it determined that the steel makers were so much interested in the quality of the material as they were in the price and in the quantity that they could get on order. It was a case of quantity taking precedence with them, and quality was at a low ebb. Having fitted out to be able to fix upon the qualities of the materials from the point of view of their kinetic ability, the next step was by way of culling out the materials that were so very inferior as not to be given consideration at all. From this point to the time when the laboratory was enabled to state with fair certainty what could be used in automobile work was at the expense of a long series of tests, and of uncertainties there were many, to be reduced only as the product of repeated tests.

When the materials that would serve the purpose were arrived at, then came the question of finding the mills that would furnish them. This may look like a simple matter, but it can scarcely be regarded as such in view of the experiences that followed attempts. That the mills

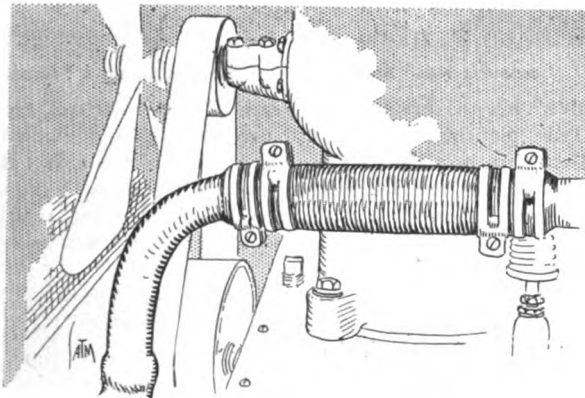

Haynes Flexible Water Hose Joint.

regarded themselves as the sole judge of quality is assured, and in a sense they were right, for in many cases the materials were so inferior that none but the fabricators could unravel the tangle.

Sending orders abroad was the only expedient for a time, and this was the process to bring the mills to a sense of the uselessness of trying to dam up the situation with materials not stout enough to accomplish the purpose. Once the makers of materials found that the foreigners were hungry for business, it was as an appetizer for them, and they did respond in a manner that prevented the whole business of furnishing automobile materials from falling into the hands of the mills in France, Germany, and England.

The Standardization of Parts.

With the question of the materials in a fair way to be disposed of—in time, at any rate—the next question was one in which an attempt was made to arrive at standards, more particularly in relation to parts, hoping that in time standards of units might be fixed upon as well. Certain of the drop forgings, and bolts and nuts were handled in this way, and the industry was benefited marvelously by the results of efforts along these lines. In relation to the standardization of units, it is enough to say the problem is formidable, and it may take even years to bring about anything like a standard. On the other hand, it was possible to establish a horsepower formula that did serve

the purpose, in that it put all the motors of the same general type on a common footing, and enabled the makers of cars as well as the patrons of the industry to decide with more or less certainty as to the fairness of the ratings of motors and the power for weight of cars.

Then it will not be too much to say that the cars at the

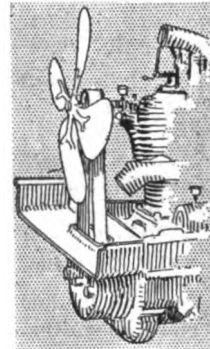

Extended Pan.

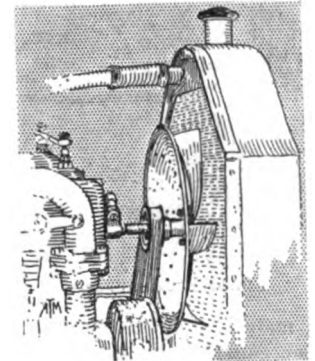

Fan-Blades on Shield..

show do represent, in a most substantial manner, all that has gone before, including the work of the mechanical branch, in the endeavor to arrive at a fitting standard of the materials used in the cars, and the way the parts should be whittled out for the work to be done. Purchasers will be enabled to see in the cars at the show all the concentrated effort of the designers, not only as individuals but collectively. As individuals, the designers were enabled to show the individuality which is never destroyed, even when it is lashed down to conventional standards born of experience.

The elimination of traces of the old buggy idea and the overhang in front was in process last year. There were evidences of short wheelbase to be disposed of, which in the earlier days indicated a desire to make the most of it, resulting in a cramped design, while the saving in cost was small, if such there was. In other words, it was difficult to cut loose from environs of the past, and it was not until the 1909 cars were put out that the up-to-date automobile was an assured fact.

As it is, the radiator starts at the front axle, and the body relates to the chassis in a manner to accord with the most approved ideas on the subject in all lands. In former times one could not be sure that the hood covered a motor at all, and even in cases in which the motor was under the hood it was frequently that the hood was far in excess of the needs. In a word, there was not the fine regard

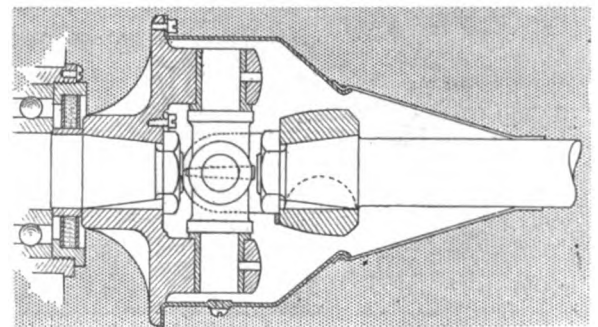

Grease Tight Pierce Universal Joint.

for truth and simplicity such as will be found in the cars at the Garden at the present time.

As respects the motors of the year, it is to note a grade of workmanship the quality of which is head and neck over the efforts of former times. Take the cylinders, for illustration; it matters not what may be the type, the

design is free from the minor errors which were once regarded as too trifling to be eliminated at the expense of a set of patterns, the cost of which is so great as to make short work of a five hundred dollar bill.

In the crankshafts will be not only the finest selections

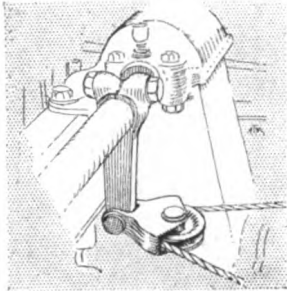

Simplex Equalizer.

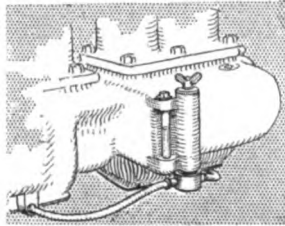

E.M.F. Oil Well.

of materials, but designs quite in keeping with the knowledge gained at the cost of much skill and through the use of a well-equipped laboratory. Then, again, it is a fact that the fashioners of the forgings arose to the occasion, and the forgings were properly made for the service to be rendered, despite the fact that it cost thousands of dollars to fit out in a manner to be able to do the work.

In aluminum castings will be found a vast improvement over the work of even a year ago. To-day the castings are not only more in keeping with the shapes that lend strength, but the material is of far greater strength, which is not so important as the fact that the average strength is very much higher and the "wasters" are but few. It is never so much a question of the maximum possible strength of parts as it is the chances of some of them being below the safe limit. Aluminum was most uncertain in this respect, and it is in this direction that the greatest advances were made.

In the matter of noise, the improvements wrought represent a most noticeable difference, due to fine discriminations in design and the more perfect proportions of the valves, valve motion and relations, thus assuring the proper performance of the valves for the purpose, which is the matter of first importance. Fortunately, with the perfection of the valves, the noise disappeared.

Utilization of the Power.

If it is true that the motor work is on a basis of great stability, it is a fact as well that the clutch work is on a higher plane. The time was when it did look as if the clutch situation would fail to respond to the wiles of designers. Persistence and experience lent the necessary

Cardan shafts are now not only of the right kind of material, but they are designed in a manner to abort all tendencies to deform under the most severe conditions. If universal joints are used, they are on a fitting plane, and the means for attending to the lubrication is as adequate as the manner in which the "grit" is kept out of the joints. In the cases in which the power plant is on a basis of separate units, means are provided for the quick removal of any of the units, as the clutch or the gearset. It is also true that the motor can be lifted out of the chassis without having to remove the other parts. In many cases this is brought about by means of a suitable slip-joint, and in other cases it is a feature of the clutch. At all events, it is true that the units can be removed in the designs using separate units, while in the self-contained plants it is not necessary to consider the point.

Transmission gearsets are on a high plane, some of which are of the "progressive" and one is "semi-progres-

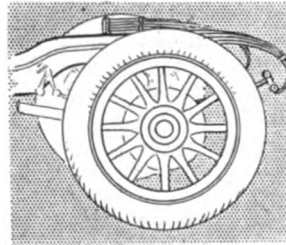

Chalmers Rear Spring.

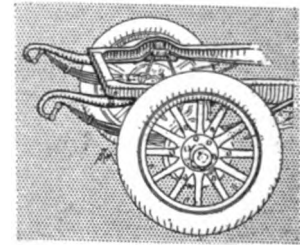

Curved Chassis Frame.

sive," but the great majority are of the "selective" types. True, planetary gearsets are used in numerous examples. Gears are of alloy steel in most cases, but it is a fact that good results are due in some notable instances to the use of "special steel" put through a suitable heat treating process. The linkages and the lever control systems are

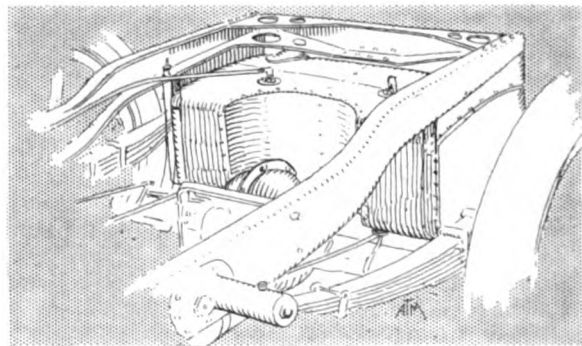

Showing How Differential Clears Lozler Tank.

in a high state of development, using special steel, of marked rigidity and die-forged. Left-hand control, by the way, is here in some force.

Brakes are of the kind that work, nor do they reduce to decrepitude as the result of sliding down a hill, as once they did. In many cases the brakes are all on the (rear) road wheels; the drums are of large diameter, the face is wide and the shoes are devised in a manner to assure long life, as well as the requisite ability. Facings for brakes are divers, as usual; some are metal to metal, more are "cork insert," and the new idea, using "asbestos" fabrics, is well represented. In brakes, too, the means for applying pressure are better, and the bearings are not now unduly pressed in the process of applying the brakes.

Springs, once the bane of the autoist, due in a large measure to lack of good design, together with the fact that the materials were good for certain purposes, among which automobiles cannot claim an assured relation. As

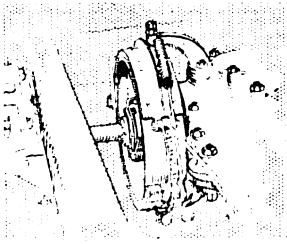

Simplex Brakes.

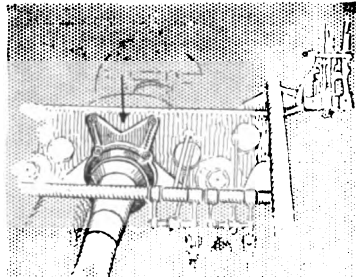

Lozler Tube Anchor.

charms, and it is now assured that clutches will do the work in a manner to leave nothing to be taken for granted. In the earlier struggles it was thought that the types of clutches were most at fault, and changes were frequent. To-day it is recognized that all the types of clutches will work if they are properly designed. Some will take of skill more than others, but the skill is on tap.

it is to-day, in view of advances in materials, and in the mode of heat treating, as well as the perfection of design, the spring situation is far advanced.

The Several Types of Motors Extant.

All but the "turbine" will be found at the show, displaying their respective advantages, under conditions to bring about a lucid exposé, in order to tell interested patrons just what the year has done by way of improvements. Any attempt at predicting the supremacy of the one over the other in the types of motors is as a waste of time, on the ground that all serve the purpose for which they were designed in a manner up to the needs of the occasion, and to the entire satisfaction of the adherents—nay, advocates of the generic types of motors.

The Air-Cooled Motor.—Air-cooling looked so reasonable and logical in the early days that the idea took root and prospered, despite the difficulties that beset the plan. It was known long before the automobile was taken seriously that air cooling could be maintained in connection with the motors if the bore of the cylinders was limited. On the other hand, it was then supposed that excess heat would beset the plan in any attempt to increase the bore, or gain in power in any other way if displacement was to be the basis. When the

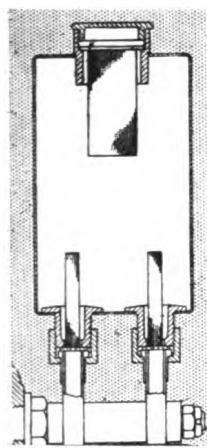

Pierce Oil Strainer.

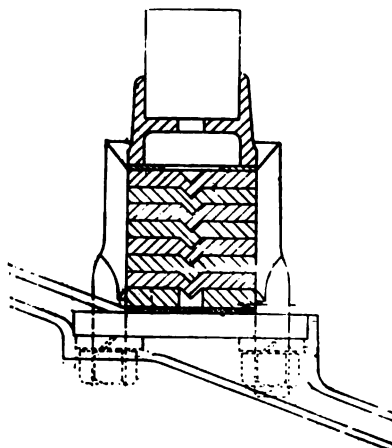

Section of Springs.

Franklin first came out the size of the motor was commented upon, in many cases unfavorably, since it was not quite in accord with the "untried" theories of the day. But the Franklin went about its business in a way to surprise the "natives," and despite the croaking of the theorists (?) it has been going ever since. As it is to-day, the Franklin company has a "six," and it ranks with the cars of the class, with never a thought of air cooling unless to point out that it works quite well enough to satisfy the school of autoists who deem an air-cooled motor suitable for their needs and who will take the ground that they do know what they want and act for themselves.

Certainly the autoist who does not take kindly to "plumbing" favors the air-cooled motor, and in the Winter time it is quite up to a fitting standard, while in the hottest Summer weather it does work so well that the builders of this class of cars depend largely for their business upon the very customers they dealt with from the start. In other words, the air-cooled motor has maintained itself under more or less hostile conditions, maligned for the most part by the men who always maintain that they would not be found dead in a car with a motor of the class. The question is, What do they know about it, if they decline to benefit by experience?

In recent times the air-cooled situation has gained in

converts to a considerable extent, and in taxicab work in particular it has made a notable advance. Several companies now handle the air-cooled situation, and the industry has taken on an impetus that is a fair measure of

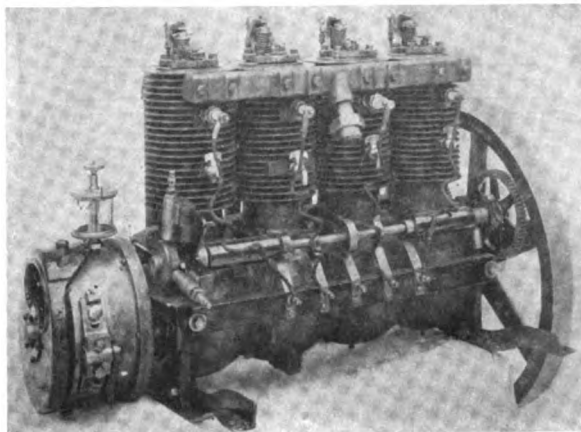

First Franklin Motor, without Auxillary Valves.

the fact that it is here to stay. If the air-cooled motor has anything against it in its own sphere of activity, certainly the industry is slow to find it out. On the other hand, failures due to the lack of knowledge of the application of the principle cannot be charged to the successes that may now be seen at every hand. In recent times it may be said that a better appreciation of the fine points in design had much to do with the success of the motors of the type, and it has been admitted that the air-cooled motor requires skill to a degree not present in motor work in general.

Stability of the Steam Car.—Flexibility is a word which when applied to the steam car situation loses none of its potency. Adaptability, therefore, is a natural sequence, and desirability is portrayed in the very strength that enables the steam car makers to maintain a certain supremacy, despite environment. Force of numbers is oft-times the main strength that beats against a more or less righteous minority, and as water will wear away the hardest stone, so will quality be swallowed up in the meshes that surround it. Taking all the circumstances into account, it is to reach the conclusion that the steam car situation is one of masterly strength despite the limits imposed.

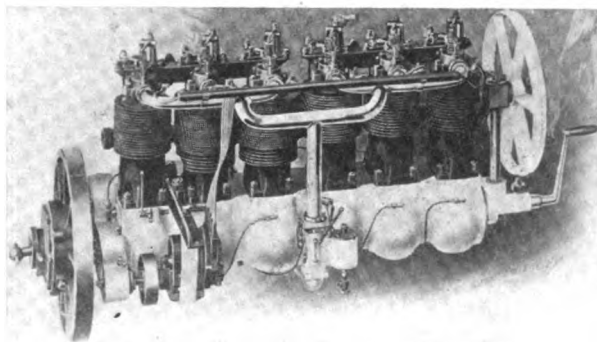

Late Type Franklin Motor, with Concentric Valves.

To begin with, a steam car is nothing if the steam generator is not of the greatest efficiency and of a character so stable as to leave absolutely no problem unsolved, if the same is in relation to safety. The White generator is illustrated, and to more clearly depict the points of

merit a diagram of the generator is also given. The generator is made up of a series of coils of steel tubing, superimposed and connected in succession. In other words, were the coils to be straightened out the whole would be as a long length of steel tubing. In operation, water is pumped into the upper coil, and steam issues from the

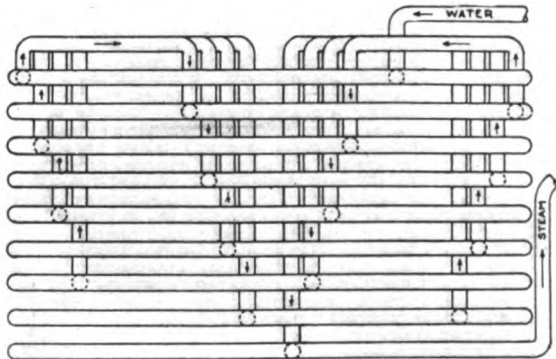

Section White Generator, Showing Water Circulation.

lower coil. In a word, the water does not hold as such throughout the length of the coil, and the amount of water in the coils at any one time is less than the amount, which, if all were elevated to the steam state of aggregation, and raised to the highest possible pressure consistent with the means afforded, there would not be enough water in the system to generate the requisite pressure to damage the generator, much less to cause the slightest departure from feather bed safety. The White system, then, does not take into account a large amount of water in a boiler, under pressure, and prone to flash into steam, thus chancing an explosion. The long length of steel tubing, about 1-2 inch in diameter, is there for the purpose of making steam as the same is wanted, and the means afforded for the proper regulation of the influx of water represents, in all truth, the mode of control.

The Two-Stroke-Cycle Motor.—This type of motor can be either air or water cooled, allowing that the designer is capable of coping with the several problems at the one time. However, it is not usually the case that two-stroke-cycle motors are air cooled as well. As a rule, it is the idea to favor the two-stroke-cycle motor to the greatest possible extent along lines in which the question of scavenging is considered to be the matter of the first importance. Taking the 1909 automobiles for it, there is ample evidence



White Generator, Showing Coil Connections.

of the fact that the two-stroke-cycle motor is gaining converts among the autoists who do not care for valves, the requisite motions, and the chances that go with them by way of leakage. In the earlier attempts to build motors of this class it was made apparent that flexibility would be a little difficult of attainment, for reasons that were variously

stated at the time. It may come as a surprise to many, then, to learn that in the motors of the class the question of flexibility is settled in favor of what may be well termed a fine performance in this respect.

The motors of this class promise much in commercial work in which the class of labor is not of the mechanical turn of mind, and of mechanical things complication is the least to be desired. In any zone of activity the least of two evils is the one to choose, and simplicity is the first requisite in commercial work. As yet the motor of this class has not been used to any great extent in buggy service, but it should have a demand in this direction if it is a fact that this is the service in which there is the greatest need of simple devices. Certainly it is true that the two-stroke-cycle motor is simple. Of this class of motors it is too soon to say which of its subdivisions will ultimately prove to be of the greatest advantage. As is well understood, the three-port motor is even free from the complication which comes from having to use a valve in the crankcase, and in this way the motor becomes truly "valveless." In the two-port type the valve is an "automatic," and its function is to entrap the mixture after it is sucked into the crankcase. On the whole, taking all things into account, the Elmore has maintained a standard of excel-

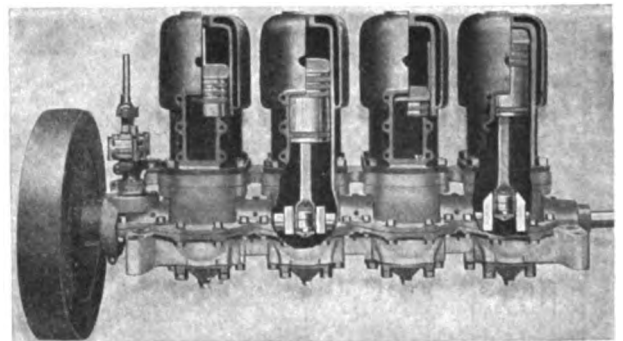

Elmore Two-Stroke Cycle Motor, Shown In Section.

lence, using the well-known Elmore two-cycle motor, and the only complaint ever made was that the company failed to turn out enough cars to fill the demand. This is in the face of the fact that the Elmore plant is pretentious.

Trend of the Water-Cooled Motor.—This is mostly a question of the location of the valves. The T shape was regarded as standard until very recently, but it is now a question if the T shape has maintained the supremacy which it promised. In many cases there are splendid types of the L shape, in which the advantage of a single camshaft is displayed; then there are motors in which the valves are in the head, using a superimposed camshaft. The Knight motor was of America, but it emigrated, and is now to be exploited in this country by the British Daimler Co., and in it will be found a variation of the water-cooled type of motor in which valves are used, although it is true that the Knight motor was once regarded as valveless. In this connection, it may as well be said that the valves are there, by way of sleeves, instead of the conventional "poppets," and the future will tell if the plan is superior.

What of the Gas Turbine for Automobiles?—Completeness demands mention of the gas turbine, even if it is true that the Garden will have none of the type. That the turbine is possible is now becoming more apparent, and, just to be up to date, it will be the idea to call attention to the fact that experimenters are figuring upon the introduction of the type. But it cannot be stated that the "turbine" will be in much evidence for many years to come.

ILLUSTRATED WORD PICTURE OF THE CARS

AUTOCAR: The Autocar Co., Ardmore, Pa.—By way of pleasure cars this well known company will exhibit at the Garden its model known as Type XX, which is a four-cylinder car of the latest and most approved design, in which the ignition is with a Bosch magneto, and the transmission is of the progressive three-speed type. The wheelbase is 102 inches, and the wheels, of a very comprehensive design, are fitted with 34x3 1-2-inch pneumatics. The baby tonneau on the model at the show is well inclined toward the zone most fittingly referred to as "finality," and on the whole it is easy to account for the interest that will center around the exhibition of the Autocar. In addition to the chassis as above described, the exhibition is most complete in other ways, and it includes bodywork as follows: A landaulet which will be found of splendid proportions and artistic in the extreme; a town car design, and a taxicab, as well as a victoria. Especial mention will be made of the fine appearance of the last-named body, in view of the high art depicted in its graceful lines. The whole exhibition of the Autocar, taking it collectively, renders it easy to reach the conclusion that the company is alive to the 1909 needs from the autoist's point of view, and to meet them

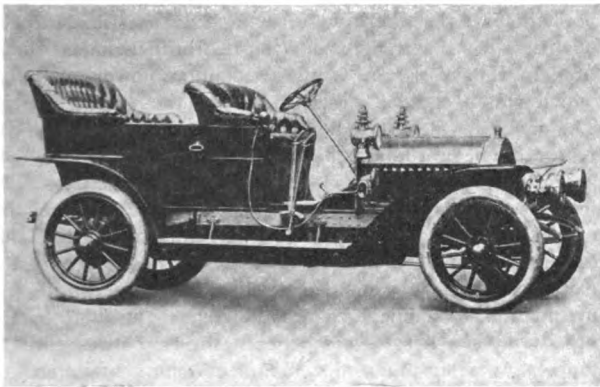

Autocar, 18-20-Horsepower, with Touring Body.

constitutes the sole ambition of the company. The mechanical work on the chassis and all its parts is well up to the high standard of workmanship which has always characterized the output from Ardmore.

APPERSON: Apperson Bros., Kokomo, Ind.—The "Jack Rabbit," good for 75 miles per hour, from the Apperson borough, is a four-cylinder car rated at 50 horsepower. "Big Dick" belongs to the same family and is intended for the autoist who wants to go 90 miles per hour. This car also has a four-cylinder motor and is fitted with a runabout body. As a general proposition, it is likely that the Model O Apperson is the car which the average autoist will be the most interested in. The Model O is a 30-horsepower touring car, of the latest and most approved make, fitted out in a manner consistent with the advances in the art. This car is of the four-cylinder class, and among other special features are I-section vanadium steel front axles and a floating type of rear axle, so designed as to allow of the utilization of "plumb spoke" rear road wheels. The transmission gearset has special features, among which attention will be called to the absence of joints. The case is of aluminium and in one piece. The bearings are of the "two row" ball type, and it is interesting to note that the camshaft

can be withdrawn from its nest in the motor case. Noiseless performance is one of the claims of the Apperson.

CADILLAC: Cadillac Motor Car Co., Detroit.—From the single-cylinder Cadillac to the four-cylinder proposition for 1909 is a great distance, and yet the single-cylinder car has a wide field of usefulness and is the favorite of very many autoists. The new "Thirty," however, represents automobile value as it will probably remain for some time to come, on the ground that the price, \$1,400, for the car is a proposition in which

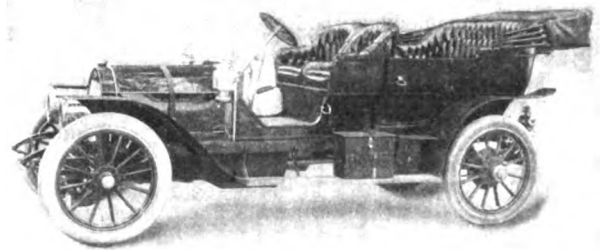

Apperson, Model O, 30-Horsepower Touring Car.

merit has a permanent residence. The four-cylinder "Thirty," like all Cadillac motors, is with certain special features such as have long been regarded as Cadillac earmarks. The cylinders are "individual," and the water jackets are copper, so securely put into place as to defeat any trouble from this source. The method is a guarantee of even walls of the cast gray iron cylinders proper, and, as would be natural to the method, the cylinders may be critically inspected all over. The Cadillac "Thirty" is a great big, full-fledged automobile, of fine appearance, but this is a fact that a mere inspection at the show will ade-

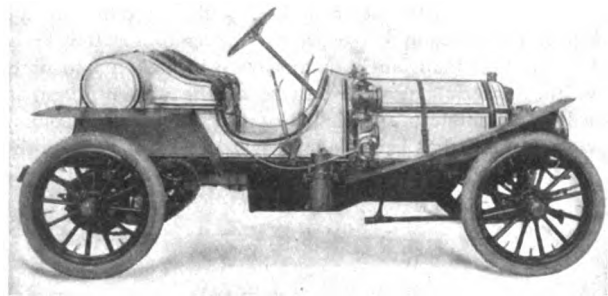

Apperson "Jack Rabbit" 50-55-Horsepower.

quately settle. The power is there, and the parts are accurately made. The castings and all the work, as well as all the other parts, even including the radiator, carbureter, etc., are made in the Cadillac plant under the supervision of the company.

CHALMERS - DETROIT: Chalmers - Detroit Motor Co., Detroit.—The 40-horsepower car of this make is so well known as not to require further mention, but it will be well to especially call attention

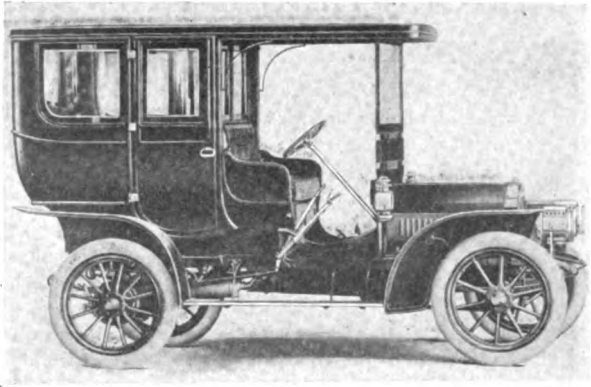

Cadillac Model G, Limousine Body.

to the "Thirty" for 1909. The car in touring form is with a commodious body of artistic design, with the wheelbase 110 inches, so that the space afforded is adequate, especially in view of the fact that the motor is with cylinders cast "en bloc," thus making the motor very short and in this way adding to the available space. The crankshaft is of the ball-bearing type, using two bearings, and the section is accordingly increased to handle the strains, not without using the finest materials for the purpose. Since the distance between bearings is no more than would obtain with three bearing crankshafts as they are generally to be found, it is plain that the elimination of the extra bearing is to no disadvantage, if indeed, it may not react in favor under the conditions in which the car of the subject was brought to a successful issue. In this car the transmission system is of the selective, three-speed type, with a position finder that does the work without any chance of fumbling. The oiling system is very nicely worked out, and a "tell-tale" affords all the information required to enable the operator to feel sure that all the bearings are profusely lubricated. The car is a shaft drive, and the workmanship throughout is up to a high standard.

COLUMBIA: Electric Vehicle Co., Hartford, Conn.—The 1909 offering of this well-known company includes a gasoline automobile, known as Mark LXVII. This car is of the four-cylinder, water-cooled type, as is usual with Columbia work, and in a general way it will be proper to say this car conforms quite closely to the various Columbia features in its gasoline work, as will be found in the product for probably three or more years back. It is true, however, that many little details were brought up to date, and the materials used are those of the present time, in the light of modern knowledge of the subject. In Columbia work much has been done by way of standardizing the

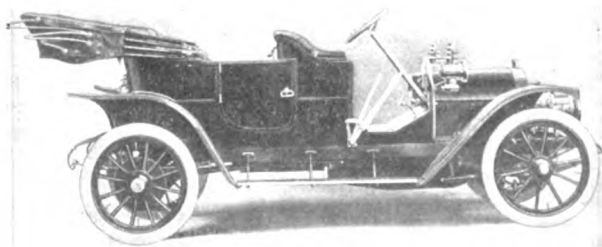

Chalmers-Detroit "30" Touring Car.

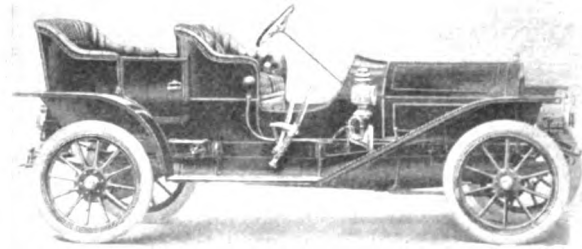

Cadillac "Thirty" Demi-Tonneau.

units of construction, and the chassis, for illustration, is of uniform dimensions in all the cars as turned out. All the types of bodies are therefore alike in the essential dimensions, and in all particulars the parts conform closely to a fixed standard. The motor is equipped with Bosch magneto; Hess-Bright ball bearings are used in every place requiring ball or roller bearings, and all along the line the same high quality of materials will be found.

CORBIN: Corbin Motor Vehicle Corp., New Britain, Conn.—Departure from previous design is by way of such refinements as experience dictates, coupled with the fact that there were certain advances made in the qualities of materials, and the Corbin includes them. Models K and R are with a common power plant, in which water cooling is used, as was the case formerly. The motor is rated at 32 horsepower, and among the special features will be found a nice arrangement of the camshaft gears, and the housing is complete and effective. The interior of the crankcase is accessible, and the valves are nested in a very simple and desirable way on the left side of the motor, where are also the auxiliaries. Among the Corbin features that identify the line from the "flock" will be mentioned the silent valve motion, brought about by the use of intermediate levers between the cam-faces and the tappets; wear is thus reduced to a minimum. The chassis frame is reinforced to assure entire freedom from deflections, and the flywheel is housed in by a suitable contour of the crankcase. The front axle is of the design in which a pivot bearing is used on the knuckles and the front connection of the steering linkage is to the back of the axle. One more point lies in the fact that the propeller-shaft is fully enclosed, joints suitably lubricated.

ELMORE: Elmore Mfg. Co., Clyde, O.—The two models for 1909 are known in the trade as Model 33 and Model 44. Model 33 is with three cylinders, while Model

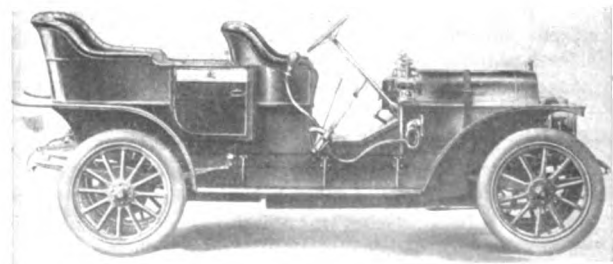

Chalmers-Detroit "40" Touring Car.

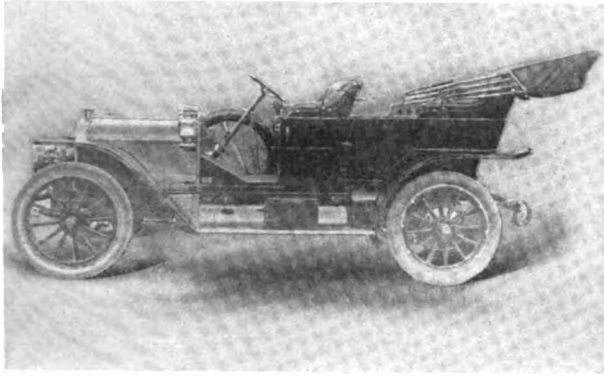

Corbin Model R, 32-Horsepower.

44 has four cylinders, and the motors of both are of the two-stroke-cycle genera. This is an Elmore feature, and great stress is laid on the fact that with the two-stroke-cycle valves are eliminated and a noiseless performance is assured. Then, again, there is the absence of valve grinding to be taken into account; moreover, the Elmore designers point out that leaky valves do more to reduce compression and, in consequence, power than any other feature in any type of motor. In these cars the crankshaft is offset, and in many ways the line has been amplified. The Atwater-Kent ignition system is used, and this is brought about through the use of a countershaft just back of the flywheel, instead of at the side, as in the 1908 models. The tonneau on both models has been lengthened, and the quality of the work in the body conforms to the high character of the workmanship in the chassis.

E.-M.-F.: **Everett-Metzer-Flanders Co., Detroit.**—The valves in the motor of the "Thirty" are 2 1/8 inches in diameter and the cylinders are 4 inches, so that the valves are over half the diameter of the cylinders, and thus will it be known that in the motors of this make the valves are very large indeed. At \$1,250 this "Thirty" is one of the surprises of the year, particularly if account is taken of the fact that it is in every way a standard tour-car, both in point of size and in utility, fitted with every device known to the art, even including a magneto in the ignition system. The rear axle is of the type in which an expanded tube is used instead of castings and drawn steel tubing, and the ground clearance is adequate, in view of the fact that the bulge is not so great as was formerly the case in older types of live rear axles using ponderous castings for the purpose. The front axle is of the I-section of a fine grade of steel, die forged in one piece, and the turning radius is adequate, notwithstanding the fact that the designers were enabled to eliminate the "narrowing" of the chassis frame. The rear springs are of the elliptical

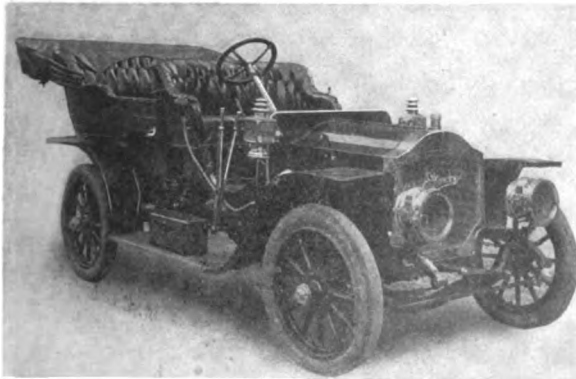

Elmore Model 33 Touring Car.

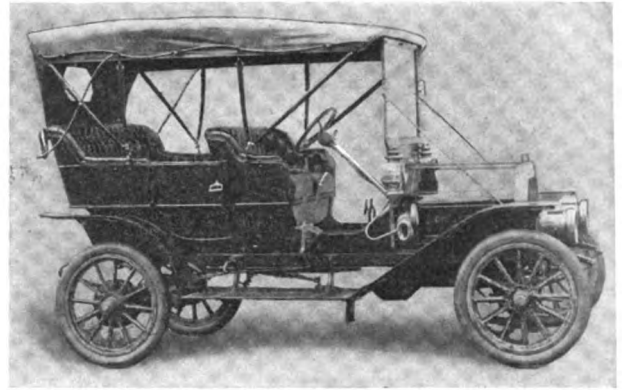

E-M-F Model 30 Touring Car.

(scroll) type, and the easy riding qualities resulting are as good as the fact that the springs are free from breakage, even under conditions involving considerable road inequalities. The cars will be well examined at the show, for the public has pricked up its ears.

FRANKLIN: **H. H. Franklin Co., Syracuse, N. Y.**—It was in 1892 that the Franklin company made its first venture, placing upon the market a 7-horsepower air-cooled car. From that day to this the Franklin has been at it hammer and tongs, so to speak, with never a thought of departing from the air-cooled proposition. For 1909 the company will be mostly confined to the delivery of three models, as follows: G-4, D-4, and H-6. In the "six," which is Model H-6, will be found all the concentrated experience of the Franklin staff, and among other details of note is the fact that the car is very light, yet withal it is strong. The 42-horsepower motor is therefore not overworked, and the power for speed is in that relation which counts for hill climbing ability or speed, at the dictates of the owner. This year the engine governor will not be used on Franklin models, but the ignition system includes the "Bosch" magneto. The crankshaft work in this make of cars is along lines far more secure than formerly did obtain in cars in general, due to the advances made in the art and the fact that the company is now in a position to command particularly good material, which, coupled with the Franklin process, aided by suitable dimensions, lends enormously to the stiffness of the product. To show something of the extent to which Franklin cars are looked after in point of detail, it is only necessary to say the valve springs are made of vanadium steel. The concentric valve motion has proven to be quite as competent as the designer predicted.

HAYNES: **Haynes Auto Co., Kokomo, Ind.**—Model X-4 is a 36-horsepower car, and it is a good representative of Haynes activities. Illustrative of the characteristics in

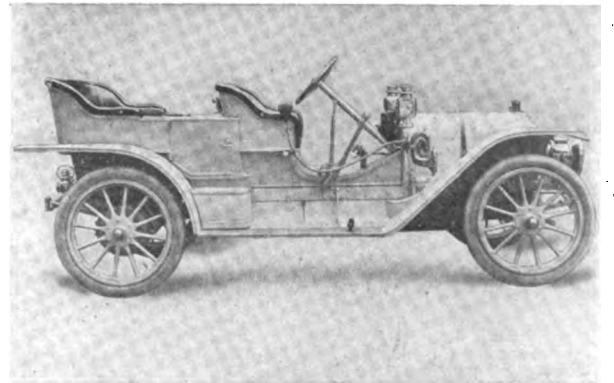

Haynes Model X, 36-Horsepower.

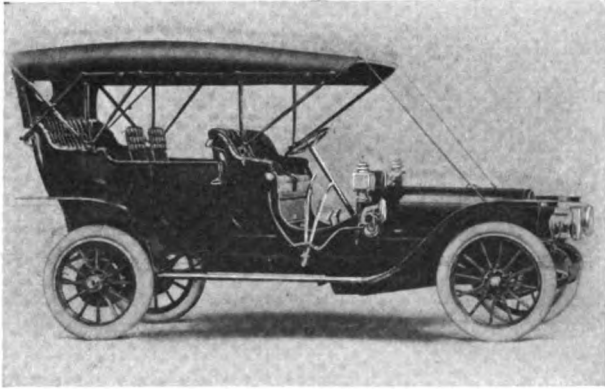

Franklin Model H, 43-Horsepower.

the products of this make is the crankshaft, the ends of which are carried on double sets of conical roller bearings, thus allowing for adjustment. The valves of the motor are located on one side, and all valves are of the same size, namely, 2.5-8 inches in diameter. In the wrist pins of the motor the bronze bushings are adjustable, and the general plan of the design takes into account the need for means by which adjustments can be readily made by one of no great skill. The clutch in the Haynes is of the contracting-band type, and in action is not unlike a conventional brake. The chassis frame is of more than the usual merit, owing to the use of a channel section reinforced by a special heat-treated vanadium steel member at the point of greatest strain. In the transmission gearset there is one principle that counts for safety and long life. This is by way of a ratchet drive on the master gear of the second shaft, so arranged as to prevent the operator from throwing the momentum of the car on the same in the act of starting or in the acceleration of the car. In divers ways the Haynes is a car of the most advanced construction.

KNOX: Knox Automobile Co., Springfield, Mass.—Model O is rated at 38-horsepower, and as a touring car sells at \$3,000, which in all respects looks like a whole lot of car for the money. In this car it will be remembered that the cylinder heads are cast separate, and in this way it becomes possible to finish the cylinders with a precision difficult to duplicate. In several ways the idea indicates advancement over the former Knox models, and on the whole the cars of this make for 1909 should attract much attention. In the motor the valves are actuated by means of a single camshaft, and the valve motion is one of the advances of the year. This year the clutch is of the three-plate variety and is enclosed within the flywheel. In the sliding gear of the selective genera, two sliding trains are used, one of which affords direct on the high, then inter-

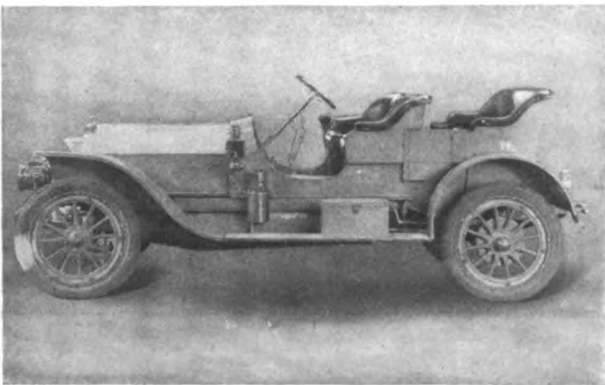

Knox Model O With Small Tonneau.

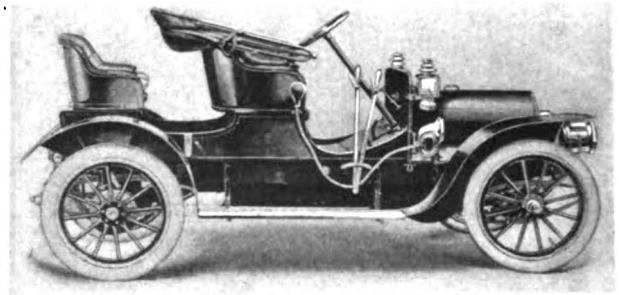

Franklin Model G, 18-Horsepower.

mediate, and the second is for low speed and reverse. As respects materials used in this make of cars, they are well indicated in the use of chrome nickel steel in the gears.

LOCOMOBILE: Locomobile Co. of America, Bridgeport, Conn.—The new shaft drive car of this company's make is the offering by way of the greatest advance in the line of cars the company produces. In this car the distance rods are situated as they are in the Locomobile side-chain drives and parallelism is thus main-

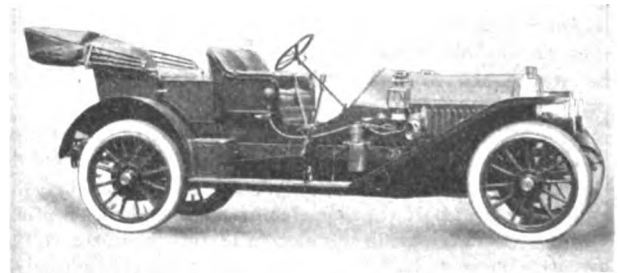

Locomobile Model 30 With Shaft Drive.

tained; these distance rods carry the brakes, and their rear ends are free to turn on the axle tube. The spring perches are also free to rotate within limits, and in these and several other ways flexibility is gained and road inequalities are not so prone to deteriorate the elements in the makeup of the car, which is a matter of the greatest importance, and, in fact, the great main reason why the shaft drive car was formerly regarded as more suitable for slow speed and low power. As it is, the 30-horsepower

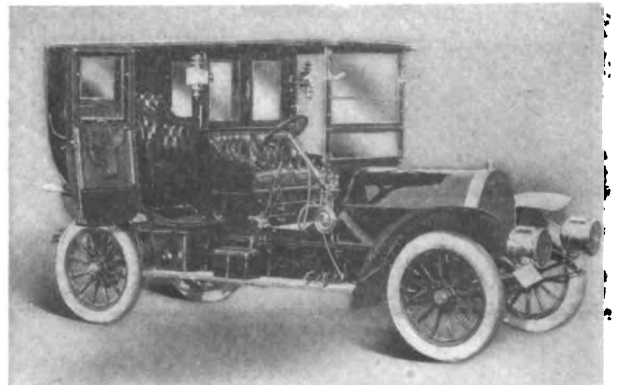

Knox Limousine, 38-Horsepower.

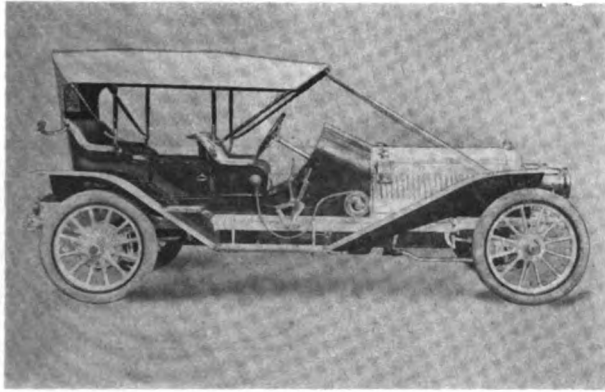

Lozier Briarcliff, 45-Horsepower.

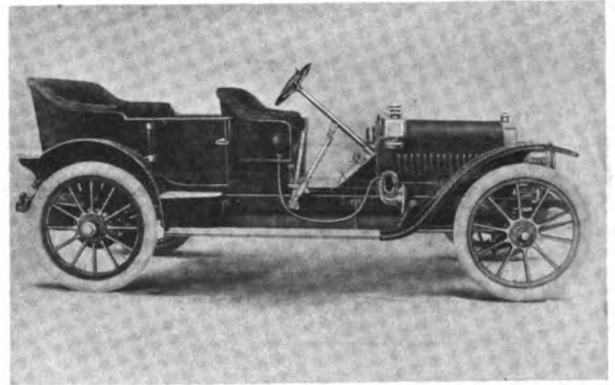

Lozier Little Six, 33-Horsepower.

shaft drive Locomobile represents a very modern and up-to-date shaft drive automobile.

LOZIER: Lozier Motor Co., New York City.—Chain-driven cars will not be in the Lozier line during the year 1909, and by way of shaft-driven cars the Model H will be a good proposition to look at. Then, there is the Model I, which is a 50-horsepower four-cylinder car; nor should the "big six" be overlooked. In the Lozier line it is the claim that the gears and other important parts are

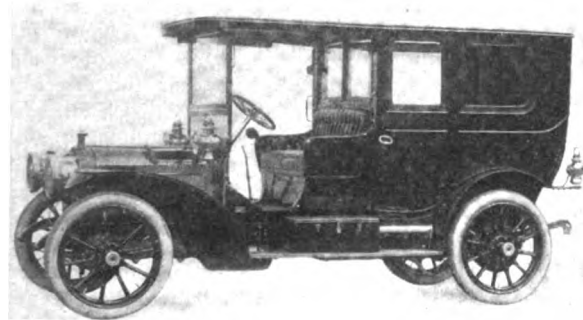

Packard Model 30 With Limousine Body.

made of a fine line of alloy steel, and the cars are very simple in all respects, due in a large measure to the elimination of parts such as torsion rods, universal joints, etc. The front steering knuckles are now fitted with ball-bearings, and in this way the effort for steering is reduced to the nominal. The cylinders of the "six" are 4.5-8 by 5.1-2, and the rating is 51 horsepower, which is of course conservative. In body work the "Briarcliff" is with very low seats, and the effect is as handsome as the result is

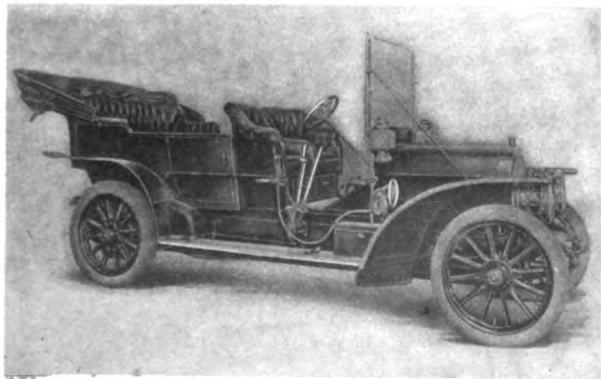

Matheson Model E, 40-Horsepower.

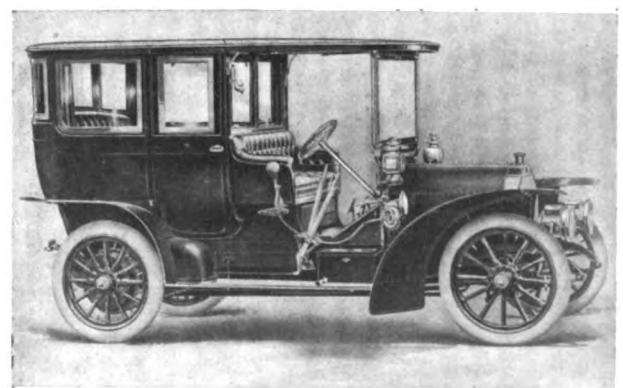

Matheson Model E With Limousine Body.

good. In endurance tests on many occasions the Lozier cars demonstrated their worth.

MATHESON: Matheson Motor Car Co., Wilkes-Barre, Pa.—Near "Giant's Despair," the hill that has proven the downfall of many a car of pretensions, the company naturally has the finest testing road in the country on which to try out the cars as they come from the works. Model E of the line is a 40-horsepower car, and in touring work it is regarded as quite up to a fitting standard. In this car the valves are in the head, all of the same size, and mechanically operated. The upper half of the crankcase is cast with a solid web between the supporting arms, thus lending adequate support to the motor; the lower half holds the oil used in the auxiliary splash, which does not prevent the "wick" system from working. The company lays stress on the fact that the gasoline in the tank is at no time under pressure; the arrangement is of such a character that the supply is regulated by the motor. When the motor stops, so does the gasoline. The car is fitted with hill-pawls and suitable means for controlling. As respects brakes, the cars are well provided; two of the brakes are constriction asbestos-lined bands on drums attached to the differential, and two are internal expanding on the rear road wheels, which brakes have shoes made of Parsons manganese bronze.

PACKARD: Packard Motor Car Co., Detroit.—The interesting car of the year from this well and favorably known plant is the four-cylinder 18-horsepower touring car. The price of this car is \$3,200, and it is also used in connection with "town car" service. In general, the car is like the well-known "Thirty," but just enough smaller to make a desirable proposition in cases in which a big car may not quite suit the work. The chassis is standardized, and body work can be in many of the well-known designs. The mechanical features are of the most approved

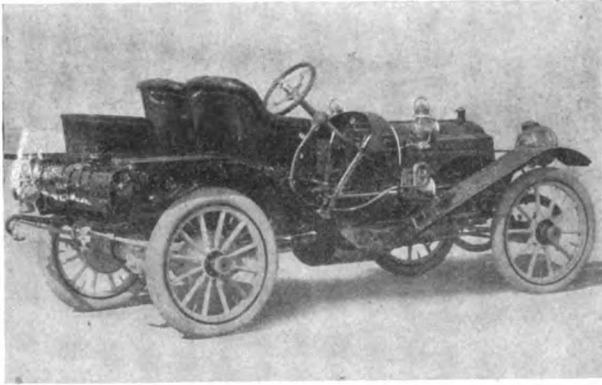

Packard Model 18 With Runabout Body.

"Packard" practices, among which may be mentioned the motor speed regulation, which is brought about by a governor in conjunction with the water circulation system. The speed changing gears and the bevel drive in conjunction with the differential are contained within a suitable aluminum housing, forming a rear axle unit. The gearset is of the "progressive" order, and the manner in which the changes are made is that usual to Packard practice. In connection with water pump there is a hydraulic pressure arrangement, by means of which the thrust bearing is lubricated, and in many ways the mechanical work is of an advanced order. In addition to the "Eighteen" there are the usual Packard choices besides.

PEERLESS: Peerless Motor Car Co., Cleveland, O.—Model 19 is a 30-horsepower car, with four cylinders, and, as the price indicates, it is a thoroughly up-to-date automobile, with every modern improvement of any value in this service. The car sells for \$4,300, equipped for touring, and few indeed are the cars that have made a better showing of friends. In general, this car is not unlike the Peerless for last year, yet at the same time such refinements as the year afforded were incorporated into the model. In the refining process there is a point beyond which it is extremely difficult to go, and it would seem as if the Peerless has about arrived at that point in this car. By way of meeting the few differences to be considered, the wheelbase has been lengthened, and the weight distribution has been brought into a more harmonious relation. The shaft drive is on a basis to abort shock tendencies, and improvements in the universal joints have been effected. The new water pump on the motor is of the herring-bone type, and its noiseless performance is an added feature. The oiling system includes a compartment in the crankcase, the capacity of which is over a gallon of oil, and the means of distributing the oil are effective.



Pierce-Arrow 36-Horsepower Runabout.

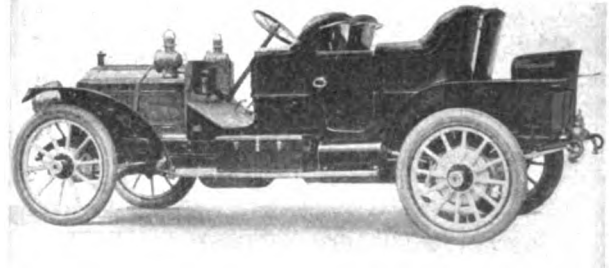

Packard 30 With Close Coupled Body.

PIERCE ARROW: Geo. N. Pierce Co., Buffalo, N. Y.—With one model of the four-cylinder type and three models using six-cylinder motors, the Pierce line for 1909 is well diversified. The four-cylinder car is rated at 24-horsepower, and sells at \$3,500, while the six of the line is rated at 60 horsepower and sells at \$6,000. In body work there is the usual diversion, and it is possible to get an "Arrow" in any of the usual selections of body work along lines consistent with the most modern practice, involving artistic work. In cylinder work the "twin" idea is used, and a bearing is used between each cylinder, which is a new idea in motor work; the castings are fashioned in a manner to suit the ends. The selective type of change speed gear is used, involving four speeds and direct on the high. The clutch is of the cone type in each case, and universal joints are used where they will do the most good. Engine valves are a little larger than formerly, and on the whole the models represent the refinements that the year fell heir to without a loss of former value. The Pierce line well deserves its great popularity.

POPE-HARTFORD: Pope Mfg. Car Co., Hartford, Conn.—Model S is a touring car made to sell at \$2,750, and the aim is to eliminate every chance of considering a car at any price more of an automobile than the Pope-Hartford at the price named. To be able to make good, the company has gone over the whole proposition in the most careful and systematic manner, with the result that the units in the car were revised in such way as experience dictated, in view of previous practice. As a result, the clutch has a little wider face, the rear axle has been somewhat redesigned, the brakes have been increased in size, the chassis frame has been redesigned to include a better distribution of the load, and a goose-neck rear spring hanger is included. The new body, with its straight line effect, is well worth a trip to the Garden to have a look

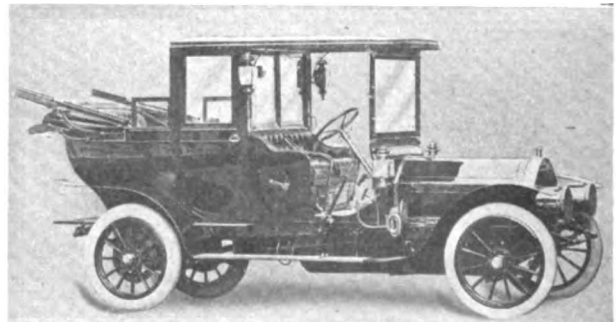

Pierce-Arrow Six-Cylinder Landaulet.

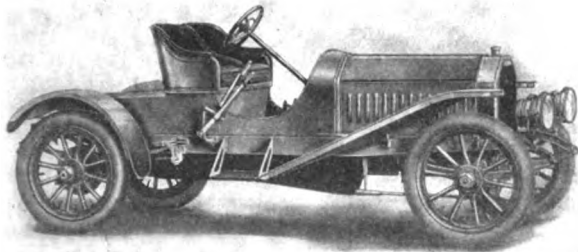

Peerless Roadster, 30-Horsepower.

at, and the wheelbase of 114 inches enables the designer to arrange the body to afford plenty of room.

POPE-TOLEDO: Pope Motor Car Co., Hartford, Conn.—For 1909 the company offers Model XXII, which is a 50-horsepower touring car of no mean proportions, the price of which is \$4,500, and in view of the manner in which the details were brought up to date it will not be too much to say that the interest the patrons pay the product will be extended throughout the year, much to the advantage of the company and the patrons as well. In the motor as used in this car the valves are in the head, and each set is controlled by one double-acting walking-beam. The crankshaft runs on ball bearings of a large size, and in this respect the Pope-Toledo is looked upon as distinctive, not only because of the use of ball bearings, but for the reason that the application is along lines indicating good sense and an assurance of the fact that a famine of oil will not result in a crop of melted-out bearings. This is no license to go without oil, but is a fact that oiling systems can go wrong, for a time at least. The double U chassis frame of chrome nickel steel is a feature of this car which is attracting a good deal of notice, and for rigidity it is looked upon as all to be desired. In divers ways the car is a fine representative of 1909 work in the automobile zone of activity, and reflects credit upon its producers.

PALMER-SINGER: Palmer & Singer Mfg. Co., New York City.—The "6-60" of this line is one of the cars of the year, in relation to which there is quite some room for discussion involving late advances. On the other hand, the "4-40," known as the "Skimabout," is in brisk demand, and the spectators at the show are certain to regard it as a good sight. This car is fitted with a four-speed selective transmission and a multiple disc clutch. A

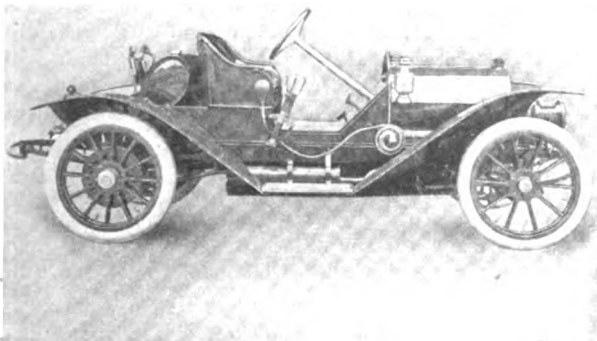

Palmer-Singer Skimabout, 28-Horsepower.

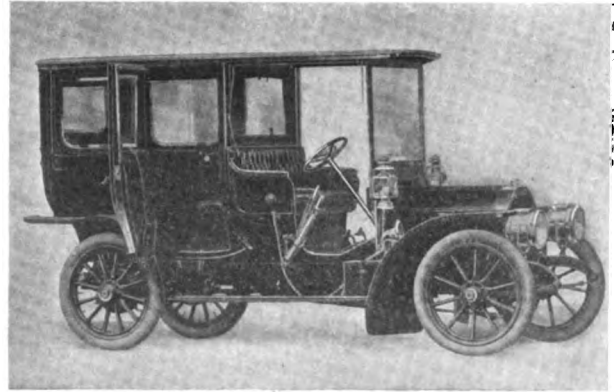

Peerless Limousine, 57-Horsepower.

"hill-pawl" is fitted to the driving shaft, and in divers ways the car is a most up-to-date proposition. In this car it will be remembered that the power plant is upon a sub-frame, and the accessories to the same are in positions to be reached at will without any trouble at all. The chassis frame is trussed through the waist; strength is thus added to an enormous degree, to the side members.

SIMPLEX: Simplex Automobile Co., New York City.—Rated at 53-horsepower, the Simplex four-cylinder model as it is shown at the Garden is a continuation of the last year's proposition, with such additions and improvements as the year's experience has influenced. Simplex cars were brought out originally to compete with the better grade of foreign automobiles, and imported materials abound in them. The wheelbase of the car is 129 inches, and the body work is always on a high plane. The details that were refined in the more recent of the models, which details are represented in the 1909 cars, include the elevation of the magneto, thus rendering it a little more easy to get at. Bosch high-tension jump spark magneto service is available in conjunction with a coil, thus affording the reliability to be expected in a car at a cost of \$5,750.

SELDEN: Selden Motor Vehicle Co., Rochester, N. Y.—One of the first of the full-fledged automobiles to come out with a low-price tag, and now in its second year, with a fine record of noiseless performance, the Selden "29," is to be at the show, there to add to its host of staunch friends. The Selden is a four-cylinder touring car along lines consistent with absolutely standard practice, with no sign of untried innovations of any kind. The motor is conservatively rated, with the accessories in a convenient place, and among other things of more than the usual note is the I-section front axle of one piece in a drop forging. As a matter of fact, every

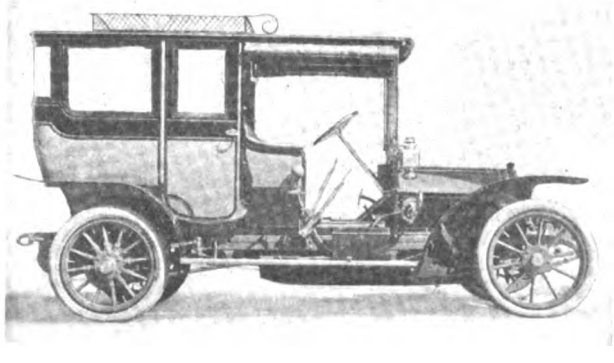

Palmer-Singer Limousine, 40-Horsepower.

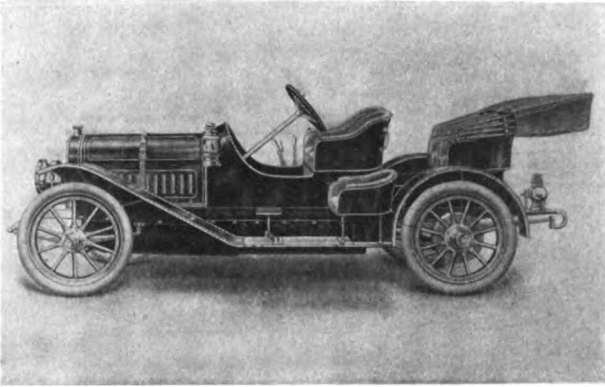

Pope-Hartford Roadster, 30-Horsepower.

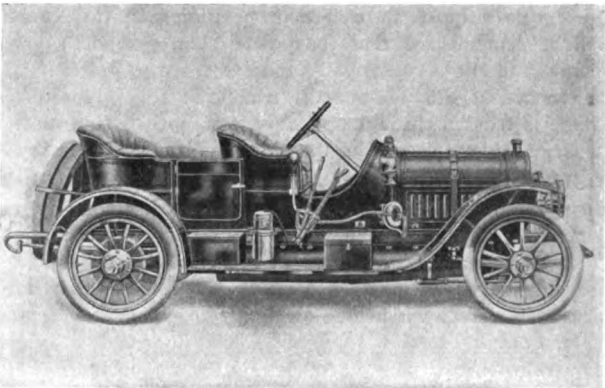

Pope-Hartford With Small Tonneau.

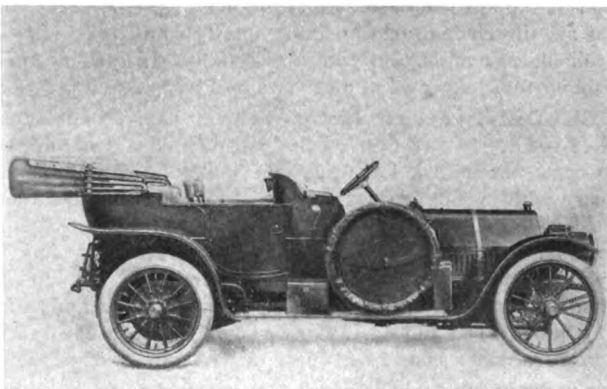

Pope-Toledo Model XXII, 50-Horsepower.

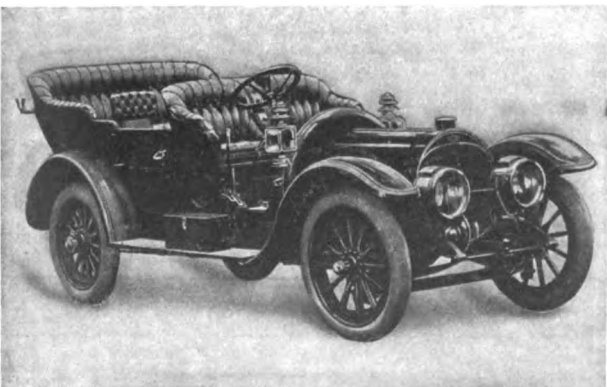

Royal Tourist Model X, 42-Horsepower.

part in the car that can be a die forging is so made, so that weight is low for the power, and the speed or hill-climbing ability is there. The touring body is of the straight-line effect, and at the option of the purchaser a roadster body will be furnished. Magneto ignition is an extra, but all provision is made, so that the cost of the addition is moderate, and the time required to fit the magneto is but short; it can be added at any time.

ROYAL TOURIST: Royal Motor Car Co., Cleveland, O.—A four-cylinder car, in which a 48-horsepower motor has demonstrated its ability to cope with the situation in a manner as befits the occasion is the car known as Model M, and it sells for \$4,500. The motor has cylinders, with a bore of 5 1-2 inches, thus showing that the motor is well up to its rating. The water-cooling system is of the usual Royal design, and the car is provided with a four-speed selective change speed gear that goes for good performance. In other respects the Royal is on a good basis, as, for illustration, the wheelbase is lengthened, the brakes are in good presence, and a self-starting device will be furnished as an extra. In addition to this car, the Royal offers the usual number of models, and much interest is certain to be taken in what is an assured good display.

STUDEBAKER: Studebaker Automobile Co., South Bend, Ind.—On the Studebaker for 1909 the ignition will be featured. This consists of the make-and-break system, which has been used for four years with a low-tension magneto as a source of current, but with the new Bosch magneto plug. This simplifies the wiring to such an extent that there is but one wire from the magneto to the bus-bar and four short wires with vulcanite grips which are pressed on the stems of the igniters. Model D, a four-cylinder 40-horsepower touring car, listing at \$4,000, will be the principal car shown, this being fitted with all of the various bodies now extant and some original creations by this company. This car has a four-speed change-gear mechanism, with direct drive on the third speed. The case is a three-part one, bolted to a sub-frame, the countershaft being above the mainshaft. Ball bearings are used freely throughout the car, with the exception of the crankshaft bearings, which are plain, of Parsons white bronze. The workmanship on these cars is of a superior grade as befits a superior machine. In the line of materials, too, a very high grade of materials is used, although the company says nothing about this, believing that these are more in the nature of a necessity on a superfine car than of a luxury. The specifications show that all up-to-date refinements in design and construction have been incorporated in these cars.

STEVENS-DURYEA: Stevens-Duryea Co., Chicopee Falls, Mass.—These very prominent advocates of the three-point suspension, coupled with the unit power plant and the forward location of the flywheel, will retain for the coming season all of these features. The disc clutch used on this car has one salient feature that attention will be called to, and that is the clutch will let go instantly, with no tendency to stick. This is due to the use of polished steel against leather on adjacent faces and is not always true of either cone clutches or metal to metal discs. The new Model X 24-horsepower car will be shown for the first time. This represents the desire of the company to cater to that class of ardent admirers who wish a car, but cannot afford a "six." It presents all the latest practice in design and materials, and, aside from the use of a four-cylinder motor, is a smaller-sized duplicate of the little "six." One new point that will be featured is an automatic position finder for the change speed lever, which insures accurate and instant gear changing. Using this it is unnecessary to look down or feel the way, for the gear

lever will stop automatically. By the use of the flywheel in front the clearance is so influenced as to depend only upon the rear axle casing, the height of this above the ground on Model X being 10 inches. This means that the flywheel cannot be injured on high crossings and similar spots in the road.

STEARNS: F. B. Stearns Company, Cleveland, O.—Characterized by the "white line around the radiator" feature of the older models, the baby Stearns makes its initial appearance at the Garden show. This is of 15-30 horsepower, with cylinders *en bloc*, following the latest small car practice, all other features following along the lines of the larger models previously built. These lines as relating to materials and workmanship are drawn very closely so as to include nothing but the best. The larger model is of 30-60 horsepower, the hyphenated rating in both cases being due to the use of a double-nozzle carbureter, an exclusive Stearns feature. The little car, it must be said, is of the more general shaft-drive type, while in higher powers the double side chains are retained, the sprockets and chains being of a special design which reduces the noise to a minimum. The crankshaft on all models is provided with annular type ball bearings. An innovation for this firm is seen in the incorporation of the transmission with the rear axle and differential housing. This is made of aluminum, which is not trusted to stand the severe road strains, however, a machined loop of forged steel which surrounds it forming the weight-carrying member of the rear axle.

THOMAS: E. R. Thomas Motor Co., Buffalo, N. Y.—The builders of the New York-Paris race winner have dropped for the coming year the old idea of being manufacturers of big cars only, and while the large models will be continued, their leader for the coming year will be a moderate-powered medium-priced car rated at 40 horsepower. This will be augmented by the continuation of the town car with a variety of bodies, this being rated at 16 horsepower. The medium-priced car, for \$3,000 is a medium price for a good car, has a six-cylinder motor, with the cylinders cast *en bloc*—that is, in blocks of three, two of these being used. The crankcase, following a well-defined modern tendency, is cast in one piece, the shaft being inserted from the ends. This is of alloy steel, carried on three annular ball bearings, the use of these being a continuation of the practice inaugurated with the "16" town car, which has an exceedingly short stiff shaft or two ball bearings. The "4-60" at \$4,500 is a continuation of the model which was so successful in the race around the world, the principal changes from last year, aside from the boring out of the cylinders to 5 3/4 inches, being but minor details making for refinement. The big "six," rated at 70 horsepower and capable of doing much better, is essentially a large car for heavy loads over all sorts of hard touring conditions. This car lists at \$6,000 in a multiplicity of bodies, including all the standard types.

WALTER: Walter Motor Car Co., Trenton, N. J.—This is essentially an exclusive car for exclusive people, the factory output being a small, "personally conducted" one. Yet the price of the product is not exclusive, but is set at a very reasonable figure, considering the exceeding painstaking attention to details and the excellent grade of material used. The motor, a four-cylinder 48-horsepower unit, is hung in the frame at three points, this being one of the 1909 improvements—viz., the three-point suspension. Others are an increase in the diameter of the steering wheel by two inches, the substitution of platform springs at the rear in place of the semi-elliptics previously used, and the attachment of a ratchet stop to prevent the car

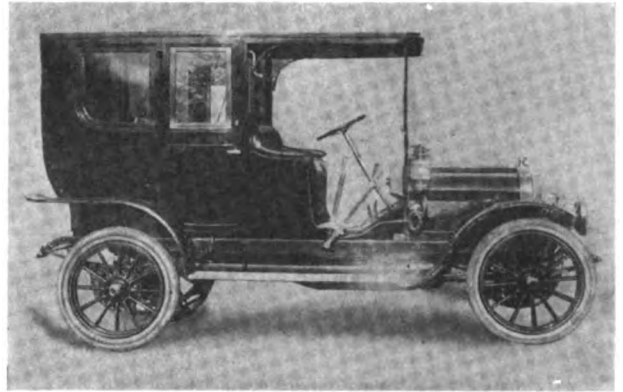

Selden Limousine, 29-Horsepower.

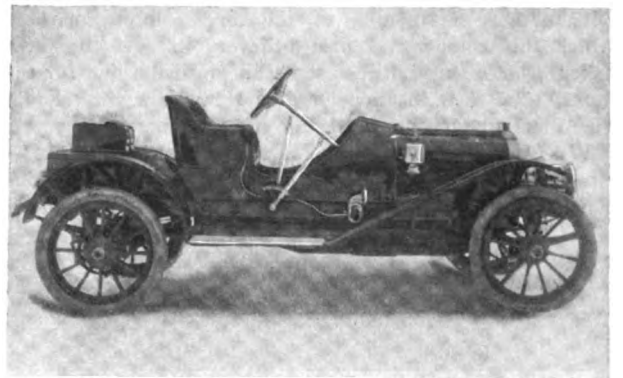

Selden Roadster, 29-Horsepower.

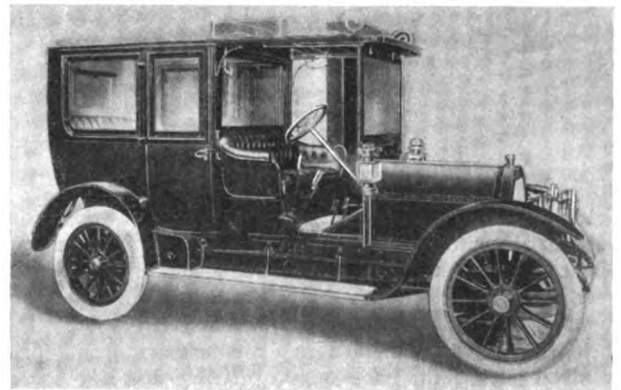

Simplex Limousine, 53-Horsepower.



Palmer-Singer Town Car, 28-Horsepower.

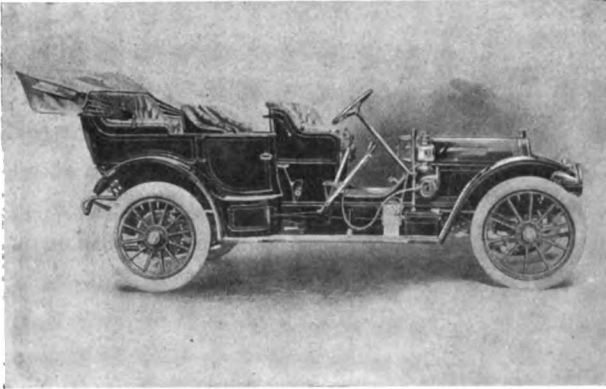

Stearns 30-60-Horsepower Touring Car.

from backing down hill. The use of platform springs is but another outcropping of the three-point suspension, which this company is firm believers in. At the price asked, \$5,000, this car represents an unusual value for the money, and their location close to New York City should give them an excellent outlet for the superfine product.

WALTHAM: Waltham Mfg. Co., Waltham, Mass.— Among the lifelong advocates of the air-cooled motor this company stands out clearly and distinctly. Featured among

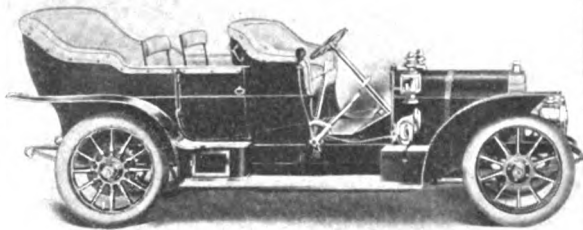

Thomas Flyer 4-60-Horsepower Touring Car.

the larger and more commodious cars will be the little buckboard, with single-cylinder motor, 3 1/4 inches in diameter by 4 1/4 inches stroke, air cooled, and mounted over the rear axle. This drives the car through the medium of a friction transmission, which consists of a 15-inch friction wheel mounted on a countershaft, upon which it slides across the face of the driving disc for speed variations. From the countershaft to the wheels the drive is by double nickel steel chains. These cars are equipped with a variety of different carrying spaces, which suit well

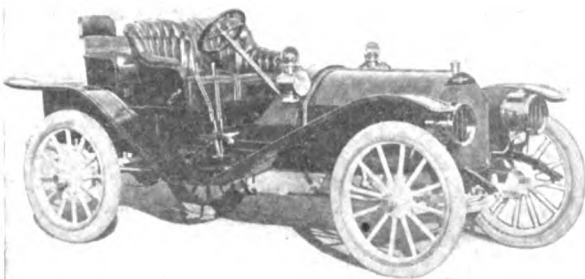

Stevens-Duryea Model XXX Runabout.

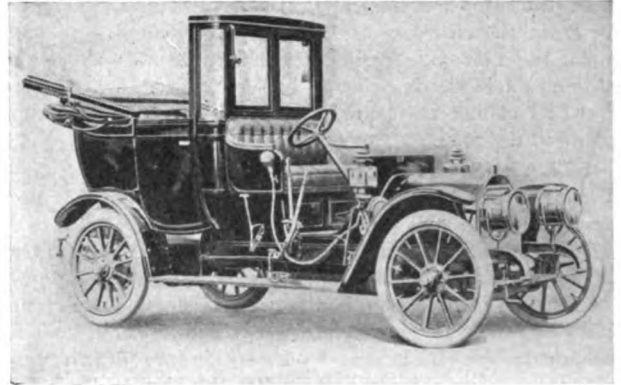

Stearns Landalet, 32-Horsepower.

a multitude of light delivery systems. Coupled with the very low price of \$350, this should have a very wide sale in the particular field to which it is adapted.

WHITE: The White Company, Cleveland, O.— Passing through the Garden it will take little time to ferret out the "steamer" of the show; there is but one. The one steam car will be found to make up in quality and the wide range of the uses to which it is put for lack of numbers, and the patrons of the industry evidently regard

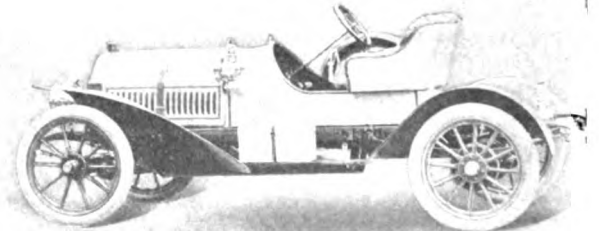

Thomas Six-Cylinder 40-Horsepower Runabout.

it as the *ultima mathule* of steam engineering, coupled with a display of automobile fineness that is not exceeded. Any description of steam cars, then, will reduce to a concrete statement of fact matching up perfectly with the "White Steamer." For the year the company will be content to supply two cars, the larger of which is known as Model M, and the other is known as Model O. The illustrations of the White car will clearly depict the character of the body work. The White engine as it is used in the 1909 cars is far and away superior in point of merit from anything

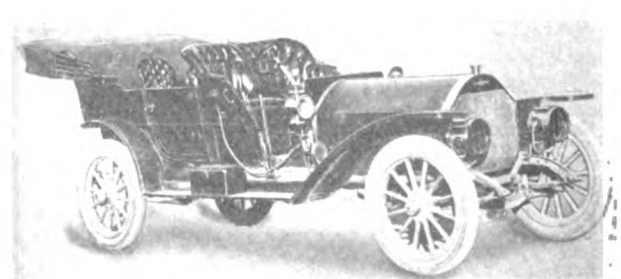

Stevens-Duryea Large Six 54-Horsepower.

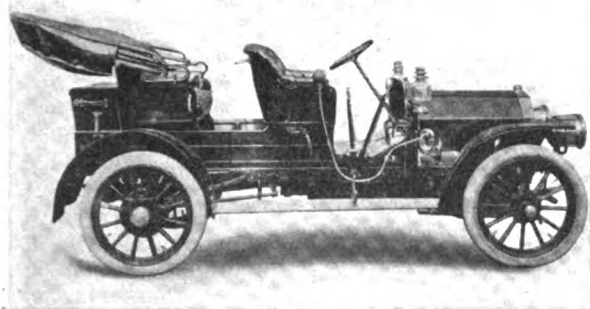

Studebaker Suburban, 30-Horsepower.

previously turned out for the purpose. In the earlier products, using the Stephenson valve motion, which was actuated by eccentrics on the crankshaft, there was recognized chances for improvement, for reasons that were as common knowledge for years before the advent of the automobile. In the new White cars the "joy" valve motion is used, and the results are so far ahead of the Stephenson performance, and in so many directions, as to leave no ground for comparison. The joy valve motion is

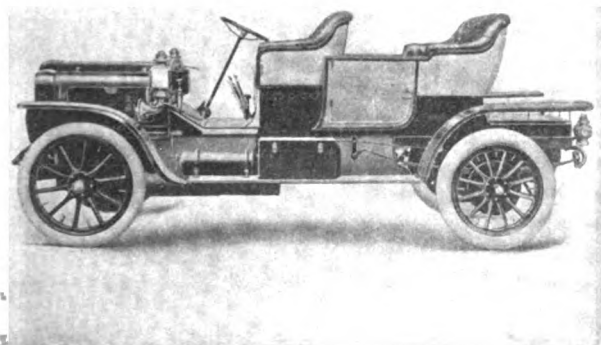

White Steamer Runabout, 40-Horsepower, Model M.

more compact, which would be as a small detail were it not for the gains by way of flexibility, and in the steam consumption per horsepower hour. The joy valve motion is actuated directly from the connecting rod, and, aside from the good that comes from the same, there is also the fact that the crankshaft is simplified, of tool steel, and ball bearings are used, of the annular type, using the crankshaft itself as the inner raceway; for which purpose the crankshaft is suitably fashioned, the materials being of the right grade for the purpose. In a hundred ways the cars

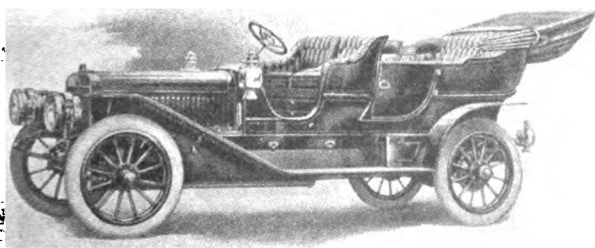

Winton Six Touring Car, 60-Horsepower.

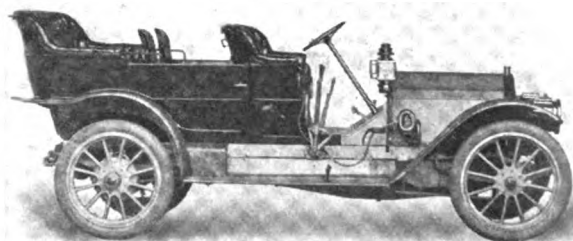

Studebaker Model D, 40-Horsepower.

is advanced along lines consistent with the highest possible development of the automobile and the steam power plan as used in the White.

Take, for illustration, the water in the generator; it is not allowed to merely segregate at its own sweet will, depending merely upon a difference in weight as between hot and cold water. As the diagram of the generator will adequately show, the water (or the resultant steam), in order to pass from one coil to the next below, must

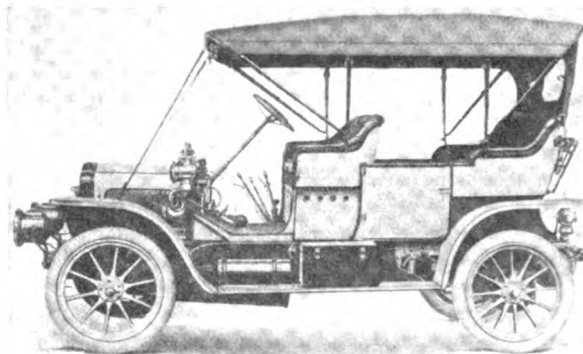

White Steamer Model O, 20-Horsepower.

traverse upwards to a level above the topmost coil, thence to the new level. It will be proper to say that the two models are alike in all particulars, as respects the power plant, excepting that one is of greater power than the other. In body work there are several options, as the custom in general.

WINTON: Winton Motor Carriage Co., Cleveland.—This is the low upkeep six-cylinder car. The makers say that the former is an inherent attribute of the latter, and as a consequence they will produce nothing but

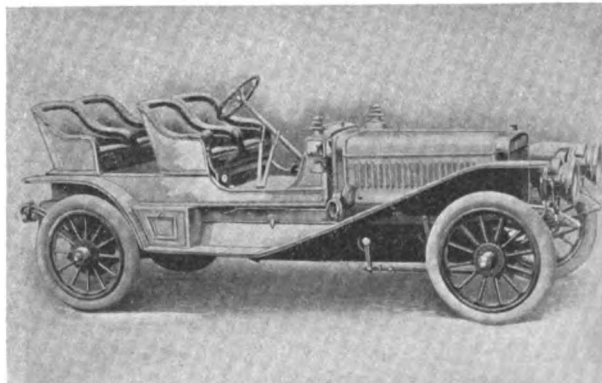

Winton Six Runabout, 48-Horsepower.

six-cylinder cars the coming year. This policy as pursued the past year must have been a successful one, else it would not be continued. Two "sixes" will be produced, each with a host of different bodies to choose from, the principal differences; in fact, the only differences being in the matter of sizes. The smaller, with a six-cylinder 4 1-2 by 5 motor, is rated at 48 horsepower, while the 5 by 5 is called a "Sixty." Both of these will be equipped with the self-starter, which has been so successful in the season just closed. This, as is well known, is an air-pressure device, the air under pressure being compressed mixture taken off from cylinders one and six. This is stored in a pressure tank and is supplied to the motor by means of a special starting cock, which when opened allows the fluid under pressure to pass through a distributor to the proper cylinder. The carbureter will be continued from last year. This is of the two-nozzle type, with a throttle for each nozzle, these operating progressively. The multiple disc-clutch is also retained. This consists of 67 very small diameter discs, the size being kept down to reduce the inertia effect, while the loss in surface is compensated for by using a larger number of discs.

WHAT PATRONS FIRST SEE IN THE CARS.

In view of the fact that it is not so easy to "spin" a motor, it is a moral certainty that the average purchaser will think of the means by which motors may be started with ease. If a car is large, and if the motor is also of much power, then it is a good thing to think about, and purchasers will find that makers, too, have thoughts along the same lines, some of which thoughts are expressed in a most substantial manner.

As a second consideration, purchasers are prone to think of the lubrication, since it is true that much trouble can be the result of inferior methods of landing the requisite amount of oil on the right spot at the propitious instant. The several available ideas are intended to do the work, each in its own way, all so effectively as to leave no question, and it is in such matters that the purchasers have the pleasure of picking the method that pleases them.

Ignition in a motor is about as essential as the motor, and in this respect the cars at the show allow of the widest latitude, since the purchasers will find all the good methods on the various cars, and they can take their choice. Magnetos are regarded as the most likely; transformers are used; they are of the "step-up" kind, and the Atwater-Kent idea is there. Then there is the magnetic plug, as put on the Studebaker cars, in which the Bosch magneto plug takes the place of other methods. Coils are used in all the different designs, among which the "master vibrator" makes for simplicity of the brand

autoists will appreciate. Batteries are "storage" in many cases, if the magneto is not used as the main means; dry cells take the place of storage batteries if the battery is as an auxiliary. It is also a fact that in the Atwater-Kent plan the dry cells will do, since the system indicates economy in the use of current.

Lamps, lighting and the means embrace a subject which the average autoist allows to roam through his mind as a vagrant thought, sometimes until he has purchased a car. The plan is not one to be recommended as a rule, although it is a fact that the cars at the Garden are well fitted out with good lamps, with but few exceptions. This year there is a "black nickel finish" which should appeal to the average autoist. This finish is not so likely to tarnish, and it should be very permanent. It is a true nickel finish, and for that matter it is more permanent than bright nickel. Generators are in a fine state of development, most of them so nicely designed as not to "clog." They are of good capacity, do not use "carbide" on an extravagant basis, and the "flame" is steady, bright and in ample presence. Those who do not like generators can choose gas tanks; they are in the several desirable sizes, and they do the work in a manner to leave nothing to be desired. Of the piping there is little to be said unless it is to point out that it is up to a fair standard as a rule, and some of the companies take great pains to have the piping on a very certain basis.

Tops, windshields and fittings are for comfort. As a rule these items are as extras, and autoists will be at liberty to settle the questions for themselves in conjunction with the cars they may select. Tops are in far more substantial presence than formerly and windshields are of the kind which serve the purpose in a manner quite in keeping with the needs. The designs are of the "adjustable" genera, while the location and the slant are such as to keep the glass clear. This is a very important detail and the windshields at the show are in full accord with the latest ideas along these lines.

In equipment by way of extra tires the spare-wheel idea is uppermost, and the manner in which it is carried out by the various companies is in keeping with the rest of the automobile. There is one point, however, which does not seem to take root with that vividness which characterizes the situation in general. It is an assured fact that tires if they are kept free from wounds will last far longer than is the case under ordinary conditions. It would seem, then, as if autoists would take to the idea of vulcanizers and regard them as a regular part of the car equipment. There is no denying the fact that this and other details should reduce the cost of upkeep of cars to a marvelous extent, and it is believed that it is right to consider the several phases of the question.

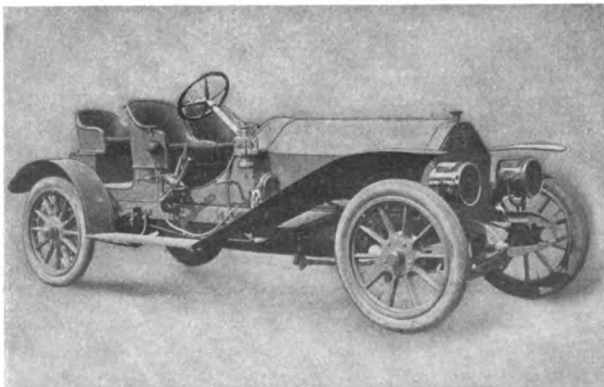

Palmer-Singer Six-Cylinder Runabout.

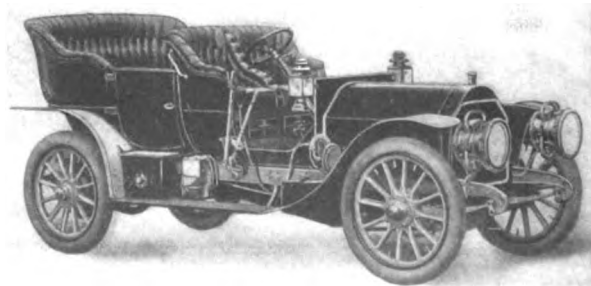

Stearns 30-60 Standard Touring Car.

GROWING POPULARITY OF ELECTRIC VEHICLES

ACTIVITY seems to center around the battery to a considerable extent, although it is true as well that the uses to which the electrics are put is gradually extending. In the first place it will be understood that there never was any question of the splendid value of electric methods of goods transportation involving "short hauls." The long haul, on the other hand, is a matter depending upon the competence of the battery, as respects the radius of action, on a single charge. Even this is a matter that daily is becoming of diminished importance because it is a fact that the number of "charging stations" is multiplying, and as charging becomes more easy to manage the radius of travel on a single charge becomes a matter of less importance.

Town cars, taxicabs, runabouts and surrey types are increasing rapidly, and there are many indications of advances in other directions.

The question of tires was ever a matter of the greatest importance in connection with electric vehicles, owing to the weight, which on account of the battery makes for more than is customary in conjunction with gasoline cars. Knowledge of the true capabilities of tires has enabled the makers to meet the situation, until now the tire situation is much improved, as would be the natural expectation. All along the line it is to be noted that the wide use of electrics for many purposes is extending beyond the limits once predicted by the most optimistic.

Having thus generalized in relation to electric vehicles, it will still be possible to detail out important features and after a fashion show something of the progress made.

In the early days motors were wont to give more or less trouble, for the reason that, if they were not enclosed, they would be damaged by dampness, dirt, and mechanically. On the other hand, to enclose them was to have them burn out, since it was not then known how to afford the means for the escape of the heat, which is ever present and which must be tapped away. In the motors as they are to be found at the show this phase of the question will be found in shape, indicating that the designers of the motors had at hand all the latest information of an authentic nature bearing upon the subject, and they used it—at whatever cost.

The "drum" controller is used to the exclusion of the other forms in about every case, just as in railway work, in which this type of controller has well served the exacting purpose for a number of years. There are deviations in point of detail, to be sure, and of them knowledge will best emanate through the good office of the literature to be had from the respective companies.

ANDERSON: Anderson Carriage Co., Detroit, Mich.—Of the products of the Anderson plant special mention will be made of the runabout type of electric, which is a car of high development, and time has been spent to bring it up to a fitting standard. There is a wide range of uses for the moderate weight electrics that will not lay down, even if the distance traveled on a single charge of the battery be very great. With a well-designed chassis and bearings of the anti-friction type in every place in which much power could be wasted, it is then but a question of battery and a motor equipment of the class which will show a high efficiency, both in

Few indeed are the autoists having had to do with the "electric" who will not fully understand the importance of wiring in a manner to protect the wiring from the fumes of the acid which rise like a "fog" from the battery during the charging process, or if the battery is in a condition of "mud," even during a heavy discharge. They will be glad to know that the question has been adequately cared for in a manner to leave no doubt of the result. Then the losses in the wiring have been reduced in that the sizes of the wire used are of greater section, and the joints have either been eliminated, or they come in places of the least damage; moreover, they are soldered.

There are divers ways of effecting speed changes in electrics. In some cases the motors and the battery, the latter in sections, are worked in series parallel, and all changes are made without inserting resistance. In other cases the battery is in series, and the motors work in parallel or in series. Then, there are the cases in which a resistance is inserted under certain conditions. As a rule, it is not desirable to employ a resistance in the circuit, since it is not economical in the main. On the other hand, there are conditions which warrant the use of the resistance, and in such cases it will be found.

The question of the number of battery cells to use is one depending upon the type of car, the mechanical efficiency of the same, and the size of the motor, which in turn takes into account the speed of the vehicle as well as the roads. For the little runabout types of cars it is customary to use as few cells as possible, and oftentimes as few as 11 cells are used. But if the cars are larger it is then customary to use 22 cells instead of 11, but in the standard examples of vehicles 44 cells of battery are used. As to the number of plates per cell, this is a question which takes into account the load on the batteries, the radius of travel and such matters. The present practice is to employ an adequate battery, and to select the types of battery best suited to the work. In special cases it is the custom to select "thin plate" batteries, in which the ampere rate is high, and in which weight efficiency is of greater importance than long life. Makers of cars do not recommend short life batteries, excepting under certain conditions, and as a rule the heavier (low rate) batteries are used for the purpose. Of course, if a vehicle must make long distances on a single charge, it at once becomes necessary to use the light plate with the high rate and the shorter life. On the whole, it is up to users to be sensible about this matter and select the best all-around battery for the purpose. They are all to be had in the electric vehicles at the Garden.

point of weight and for power. The Anderson electrics are designed with an eye to the main chance.

BABCOCK: Babcock Electric Carriage Co., Buffalo, N. Y.—"If you are going to imitate the gasoline car, why not go the whole thing and make a complete job of it." So says the Babcock Company, and in the 1909 Babcock electrics the company has made good. The new Babcock electric town car, also used as a taxicab, is in line with the idea as above expressed, and it is generally conceded that the car is of the greatest utility and "dressy." Then, there is the "gentleman's roadster" of the Babcock series. In this car will be found

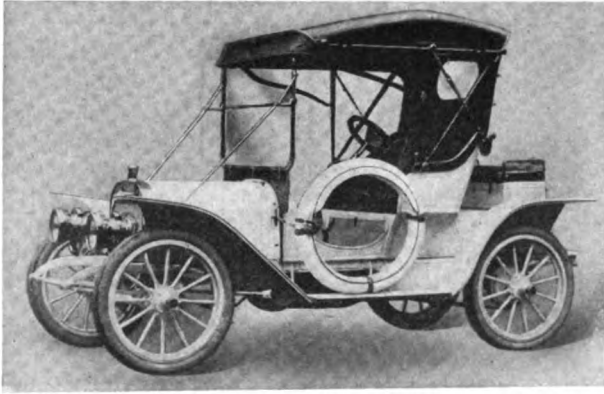

Babcock Resembling Typical Runabout.

all the requisites for an enjoyable "spin" on the boulevard, with never a fear of extending the trip beyond the safe radius of travel of the battery. The car looks fine, the road performance is notable, and the cost of maintenance is very low indeed. In this connection it may not be out of place to point out that the Babcock is so simple as not to be a problem to a boy, let alone a man. The control is worked out in a manner to assure the best results, and any semblance of complication is lacking in presence.

BAILEY: S. R. Bailey Co., Amesbury, Mass.—This company will be found at the exhibition in the Garden with its usual fine display of electric vehicles, and it is assured that the cars will create the widest interest. The line turned out by Bailey includes everything of value along lines consistent with the best practices of the day in the light of the most advanced advices from authoritative sources.

BAKER: Baker Motor Vehicle Co., Cleveland, O.—When the Baker electric was first presented to the market it was regarded in the light of a new departure, for the reason that instead of using 40 to 44 cells of battery but 11 cells were used, and the result was most gratifying. To digress a pace, it may be well to say that the Baker "Torpedo" raced on Staten Island in the early part of 1903, making the enormous speed of 80 miles per hour, although the misfortune of the occasion was by way of the car leaving the road. From that day to this there have been Baker "stunts," and the growth of the company has been rapid until to-day the Baker is a great industry. The Baker plant at Cleveland, in the vicinity of Edgewater Park, is a model to go by, both in point of hygienic arrangements and in the accuracy of the work turned out. Baker electrics show the result of an up-to-date plant in which the artisans are afforded adequate light, good ven-

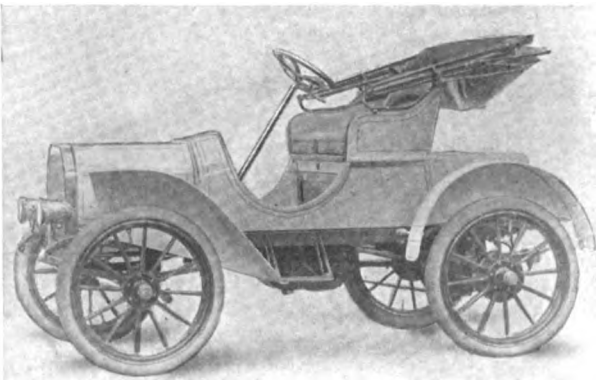

One of Baker Family of Runabouts.

tilation and an even temperature. The Baker electrics at the show will be a feature well worth viewing, and it will compensate visitors interested in this class of vehicles if they pause a moment. The little "piano box" Baker is one of the sights of New York City on any fine day, driven as it is more often than not by ladies.

COLUMBIA: Electric Vehicle Co., Hartford, Conn.—One of the oldest builders of electrics, and with a wide range of sizes and types of electric vehicles, this company always creates much interest on show occasions. The yellow surrey of the Columbia series is probably one of

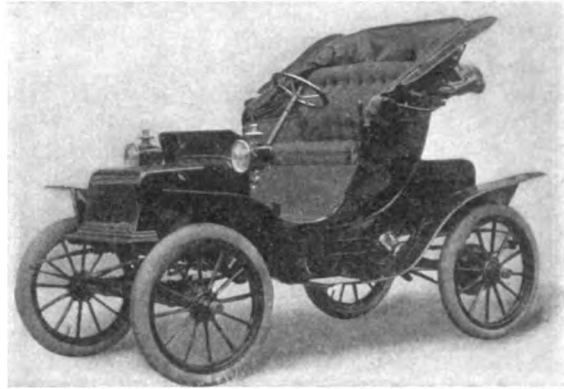

Fine Lines Evident In Babcock Brougham.

the cars of the genus which has gained more by way of popularity for electric vehicles than any other one car out of the well-equipped plant of the Columbia company. Many of the surrey type are to be seen in the congested centers, in mixed service, and the electric equipment is so very reliable as to be especially commendable. A descrip-



Lightweight Enclosed Baker.

tion of all the types of Columbia would fill a book, but to dismiss the subject without mentioning the town car would be to fail to take note of luxury on wheels, the scope of which has never been exceeded.

RAUCH & LANG: Rauch & Lang Carriage Co., Cleveland, O.—Along standard lines this company turns out a line of electrics which for style and finish are most appropriate. The coupé is a car of interest for many purposes, and is much in demand for doctors as well as for the family. Then there is the runabout and the Stanhope types to look at, as well as the special body work for any fitting purpose. The electric work on the cars of this line is of such a high character as to command the attention of the trade, while the harmony of the battery as it relates to the work is such as to assure a wide radius of travel on a single charge.

STUDEBAKER: Studebaker Automobile Co., South Bend, Ind.—The Model 13-A of the Studebaker is of the Stanhope type, and a car to be examined because of its lines and the general good that will be found in it. The speed of the Stanhope is better than 18 miles per hour, and the radius of travel is exceeding. The car weighs some 2,300 pounds, the tires are 30 x 4-inch (pneumatic) front and rear. The wheelbase is 73 inches. The coupé of the Studebaker line is another car that should be as popular as would seem to be the case. In this car the speed is 13 miles per hour, which is right for town

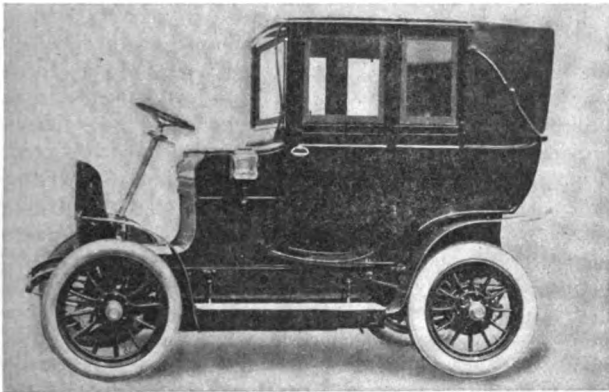

Columbia Will Continue Mark LXVIII.

service, and the range of travel is that due to the use of 24 cells of 11 plate battery. The wheelbase of the car is 67 inches, and 30 x 3-inch (pneumatic) tires are used in front, while the rear tire equipment is 30 x 3 1-2 inches. There is one other point in relation to the coupé that is worthy of notice; the top is removable and a regular

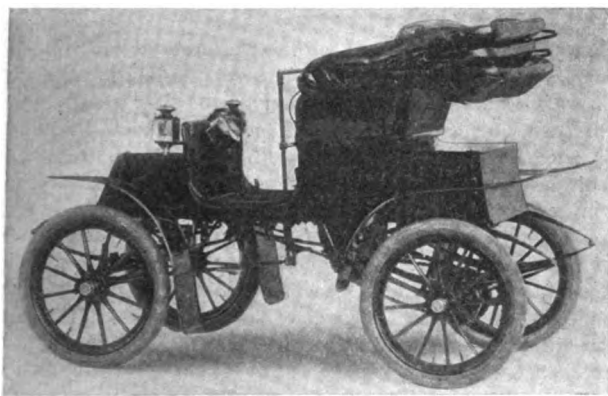

Studebaker-Stanhope Has Lever Steer.

victoria or a gypsy quarter top can be substituted. The workmanship is up to the usual Studebaker standard.

WAVERLEY ELECTRIC: The Waverley Company, Indianapolis, Ind.—Among the interesting features of the display of electrics that by the Waverley Company will deserve something more than the passing attention of visitors. Four types of carriages are to be shown, two of the models that have not been seen before in any automobile exhibition. The distinguishing mark of the new Waverley is the patented drop sill, a feature which, by lowering the seat and floor of the car, adds greatly to its convenience in use and accounts for the peculiar compactness of build and trimness of design that mark the Waverley. The use of removable coupé tops, permitting an all-the-year-round service with a single car, is another point on which the Waverley people wax eloquent.



First Product of New Waverley Company.

A unique feature of the exhibit will be the special display of the new rear system of noiseless double reduction driving mechanism which distinguishes the latest type of Waverleys. This mechanism is attached to the body and its weight is therefore cushioned by the springs instead of falling directly upon the pneumatic tires. So effective is this cushioning of the principal weights that solid tires may be used with comfort. One of the latest models, No. 74, will be shown equipped in this way. A further advantage claimed for the driving gear is its noiselessness. This is due to a new system of lubrication that keeps the principal bearings in a constant oil bath and to the use of the herringbone type of gear already well known to Waverley users. Another mechanical feature about which the Indianapolis people are quite enthusiastic is the new controller that goes with this year's models. "The position of the reverse lever in the seat immediately back of the speed lever is a special convenience; the automatic locking device prevents accident, and the controller is practically trouble-proof if not fool-proof," said one Waverley enthusiast—but we will not spoil the story for our readers. They should get it from original sources at the show.

WOODS: Woods Motor Vehicle Co., Chicago.—A wide range of electric vehicles and one of the pioneers in this phase of the industry. It was in a Woods that some of the members of the Society of Automobile Engineers, while at the Summer meeting, held at Detroit last year, trailed along after a long string of gasolines, mile after mile, all day, and made every engagement on time. The coupé of the Woods line is a very desirable doctor's rig, protecting the occupant from the weather, and the control is all inside, including well-devised "magnetic" brakes as well as the usual set. For radius of action and low cost of upkeep the Woods vehicles have a very consistent record.



Woods Line Includes Popular Coupé.

FEASIBILITY OF MOTORCYCLE DEMONSTRATED

MAKERS are preparing for a brisk trade in this line, and as a prominent one put it: "There is no doubt that the motorcycle is coming rapidly to the fore." Indications are that the days of the cheap imitation of the motorcycle are inclining to oblivion; due in no small measure to the fact that the patrons of the motorcycle trade are wont to eliminate the troubles that such machines are naturally heir to. To again quote the same maker: "The only thing to be feared is the flooding of the trade with cheap motorcycles, the quality of which is cheaper than the price. A motorcycle that is poorly constructed is really more expensive than the average mind conceives." While it is true that such methods are much to be feared, the fact remains that the "cyclists" are not now likely to support such a venture to any great extent. At all events, it would seem from the motorcycles on exhibition this year that the old line of strictures are "stale." The motorcycles to be seen certainly do look to be in full accord with the spirit of the age, a spirit which indicates a desire to pay the price but to insist upon the fullest measure of quality. How any adventurer can swim against the strong tide set up in this direction is a question which will have to be answered in the light of further experience.

This is the year of the greatest advances, and while it is not new to see motorcycles with four cylinders, it is a fact that there were none "on show" formerly as they will be at the Garden. Then there is the question of the shaft drive; cyclists are now in a position to look them over (with the shaft drive) and judge for themselves the extent to which they will care to indulge. The motors with two and single-cylinder power plants are in the greatest

NEW ERA: New Era Gas Engine Co., Dayton, O.—Of the motorcycles that will be seen at the Garden the New Era will attract a full share of attention. The product of this make shows the earmarks of that quality which comes from careful work in a shop noted for the quality of its work, and among the new features to be found on the New Era will be mentioned the absence of vibration, due to the 60-inch wheelbase and the right disposition of the weight, as well as the fact that the kinetic balance of the reciprocating parts is what is termed a satisfied couple. In the New Era there are no pedals, and a footboard is placed instead. Then the motor is started by a crank. The motor is "free" and two speeds are provided.

N. S. U.: N. S. U. Motorcycle Co., New York City.—The model De Luxe of the N. S. U. is rated at 6 horsepower, and is in every way a motorcycle to suit the buyer of more than the usual acumen. The details of design are modern and numerous of the features are novel. This type of the N. S. U. will attract the notice of cyclists at the show, and while the company has a wide range to select from, the fact remains that the De Luxe has the snap and the go so much to be desired. The company says, "N. S. U. means quality." The product seems to back up the statement.

PIERCE: The Pierce Cycle Co., Buffalo, N. Y.—That the motorcycle industry is limited in any way is far from a fact, as will be adequately illustrated by visiting the Pierce exhibit at the Garden. The Pierce four-cylinder model is something to look at; it is a

profusion, and chain and belt drives look more practical than ever before. The frames are of the "diamond" and "loop" designs so well distributed as to render any attempt at fixing upon the trend quite out of the question. As respects the materials, it is to note the profuse use of alloy steel tubing, and an increase in the use of the large sizes of the same. There is evidence of the effect of the automobile in the motorcycle, in that there is a type of motorcycle in which a crank is used in starting, and in this case no pedals are used. Magnetos are included in the finest examples in the ignition systems, and in divers ways the accessories are on a basis no less permeated with utility than is the case in the automobile. The difficult problems were solved in a manner which indicates a fine display of ingenuity on the part of the designers of motorcycles, and the price is as low as can be expected, quality considered.

In the past some of the failures, of which there have been a surprisingly small number, were directly due to the desire of the users to improve upon the machines. The desire seems to be an American habit, and it is admitted that Americans have succeeded in improving upon about everything under the sun. The fact remains that it is at the expense of the machine, in any given case, that tinkering is done. When a motorcycle is finished it pays to let it alone, and when the desire comes on, then it is good time to tinker with something that is not in a state of completion. This year the incentive for changes will be at a low ebb, and this may be the solution of the problem. In other words, the motorcycles of the year are in a state of very satisfactory completeness.

shaft drive. The frame is with extra large tubing, and the four-cylinder motor has a magneto for the ignition and all the contrivances of a power plant of the first order. The Pierce is intended to be a permanent motorcycle to stand up against all possible road conditions and to be repaired with ease when after long service it becomes necessary to consider the matter of repairs. The appearance of the four-cylinder Pierce is graceful, and the obvious strength of the frame is in keeping with the undoubted power of the motor. Then, it is pleasing to note the shaft drive, under the circumstances, and to observe that all along the line the Pierce is quite up to the most fitting standard of excellence.

R-S: Reading Standard Co., Reading, Pa.—"Built and tested in the mountains." It is thus that the maker infers that his type of motorcycles can be taken seriously. That it is so taken is rendered apparent if only one will look about and note the many users who swear by the machines they use. For 1909 the company is showing models as follows, (a) loop frame; (b) diamond frame; (c) delivery van; (e) tandem, tricycle and chair models. The motors used in the R-S machines range from 3 to 7 1-2 horsepower, with single and twin cylinders, depending upon the power. The drive is with belt or chain, depending upon the demands of the patrons, and the ignition is with battery or magneto, as may be selected, the price changing accordingly. All loop frame models are fitted with 26 x 2 1-2-inch tires; all diamond frame models have 28-inch tires. In every case the accessories are most complete, and of a grade to leave nothing to be desired. The tire pump is large, and of good advantage.

THE PROGRESS OF THE COMMERCIAL VEHICLE

By MORRIS A. HALL.

AN industry that has progressed by leaps and bounds, with the prospect of future "leaps and bounds," is that of the power wagon. This has been held back, perhaps, by ignorance on the part of the employer of the time economy, which has been truly said to be money and which took the form of passive or stolid indifference. On the other hand, this same ignorance, present in the employee, took the form of opposition, strong and virile.

It is a fact that the latter are becoming more versed in the intricacies of the work vehicle as a result of the involuntary missionary work carried on by the pleasure car, which is working out in the form of a lessened opposition to the commercial end. This is manifested best by such little items as the readiness with which the cab drivers are taking up taxicabs. Similarly the farmers have gradually reversed their position, and many are to-day to be numbered among the advocates of commercial cars.

The employer, on the contrary, and with superior intelligence, has shown also superior stubbornness. A fact which has contributed somewhat to this is that the average, or, better, the great majority, of users of horses for trucking purposes do not keep any separate record of their trucking costs, so that they have absolutely no idea of the expense per ton per mile of moving their freight. Consequently, figures mean nothing to them, and it is impossible to show a direct money saving by the self-propelled vehicles.

This same lack of a record of horse performance also carries into the item of time. By this is meant that as no accurate record is kept of the time necessary to make a certain run with horses, it is not possible to make an intelligent comparison which would show the vast saving of time due to motor service.

Opposition Overcome as Supply Is Provided.

This is, however, being overcome in about the inverse speed of the industry to care for additional expansion, or, stated otherwise, the opposition is being overcome as fast as the commercial car manufacturers get into a position to turn out more cars and thus care for additional users. At present the production is small, but is growing each year. About every other week an addition to some vehicle plant is reported, and no less than once a month the announcement of some additional pleasure car manufacturer falling into line is made, the past month of December having produced two.

It is well known that the truck bearing any similarity whatever to the pleasure car, that is, in running gear (four wheels, the two fronts steering) and in power equipment, reaches its limit at about five tons. For loads above this, the power requirements are abnormal, the load and the power together require a different distribution, the limit for rubber tires is reached calling for something very different, etc.

Points Towards the Tractor.

All this points toward the tractor with a trailer or road train. In this much interest has been shown, and, although by far the greater portion of the work done along these lines has been done abroad, it will interest visitors to the Garden show to see

one American example of a road train. This has a total capacity of 15 tons of live load, weighs about 12 tons, and is capable of a speed of six miles per hour. The vehicles are all of the six wheel type, the body being suspended upon four inverted leaf springs. The center wheels are the drivers, while the front and rear pairs steer. This multiple steering arrangement allows of the three vehicles, whose aggregate length is no less than 60 feet, turning in a 40-foot circle.

While the applications of vehicles of this capacity are necessarily limited, there is no doubt of the fact that in their own particular field they represent a vast advance over the previous arrangement which called for three or four trucks with as many drivers. In cases like mines segregated in a small place some distance from the railroad, a very promising field is opened up, but it is doubtful if they will find many opportunities in urban or suburban traffic.

Other independent commercial car problems include the six-wheeled truck, the lightweight low-priced delivery wagon, and the now omnipresent taxicab or town car. The first named has made little progress in the past year; in fact, it never has made any appreciable progress in this country. The delivery wagon, on the other hand, might be fairly taken as representative of the whole industry, such has been its progress. From the first delivery wagons, which were merely pleasure cars with a box or other commercial body, to the present form of car built expressly for and devoted entirely to the delivery service, has been a big step and one not unattended by danger to those who attempted to press the former type upon an unwilling public.

Delivery Wagons at Reasonable Prices.

To-day, however, we have upon the market at reasonable prices any number of delivery wagons, any one of which used with intelligence will give good results, so good, in fact, as to bring the vehicle into the "good investment" class.

The last named class is probably the largest, both in number of producers and numbers of cars produced. The peculiar nature of the vehicle, coming midway between the pleasure car and the work vehicle, perhaps accounts for this. In turn, this also accounts for the number of pleasure car builders, who have entered the commercial field with a car of this type. This was not a sharp break-away from pleasure chassis practice, as a heavy truck would be, but was rather an easy forward step from a large to a small car with a dainty little enclosed body.

A noticeable tendency in the heavy truck class has been the loss of advocates for the five-ton truck in favor of the three-ton and lighter machine. Although gradual in its growth from inception up to date, this idea has, however, gained so much ground that no less than two of our principal builders devoting their attention exclusively to commercial cars have, to all intents and purposes, abandoned this size. The argument from the manufacturers' side is a matter of sales. He says, for every possible prospective purchaser of a five-ton machine, there are not less than half a dozen firms who can and will use one of three-ton capacity. The same line of argument may in turn be applied to the

three and two-ton machines respectively, by saying that for every buyer of the former there will be a dozen for the latter.

On the other hand, another of our commercial builders has recently brought forth a new five-ton machine. This maker, it might be added, does not list or build a three-ton chassis, so that it may readily be seen that he pins his faith to the reverse of the above proposition, or, put into other words, that there are more five-ton buyers than three.

Proportion of Motive Power to Load.

Coming down to the details, more attention is being paid to the proportion of the motive power to the load. The first machines showed a shameful lack of this, for they were mainly under or overpowered, the former being characteristic of the delivery wagons and lighter trucks, while the latter fault was found more often in the heavier machines. To-day this matter is more equally arranged, and the three or two-ton machines with 50 or 60-horsepower motors are few and far between.

So, too, in the matter of springing. The idea that the only necessity in truck springs was enough (and often too many) leaves to carry the load is fast passing, and many of the best trucks have springs of alloy steel correctly proportioned. This is a matter of dollars in the pocket of the owner of a truck, as the high grade steels of perhaps double price will last four or five times as long as the cheaper material with a multitude of leaves, meaning excess and useless weight.

Substantial Progress in Tires.

In the matter of tires, always a bugaboo to car owners, commercial or otherwise, substantial progress has been made due to the awakening of the rubber people to the fact that the service was radically different from that of touring cars and demanded different treatment. Aside from the improvements in existing types, many new types were brought out and many more are in prospect, to judge by the large number of patents granted in this line. Wood and sectional rubber have made gains that are noteworthy, while many anti-skidding devices have been brought out and tested, among which might be mentioned the Hartridge sectional tire, an English product.

For motor bus use the combination or gasoline-electric type of drive has gained many adherents, although for

pleasure use the reverse statement would be more true.

Coming to the electric, this is found to have been more closely confined to its class, viz., the short haul proposition, although many new users in this field do not so classify. Upon inspection the latter will be found grouped in a class of their own, having adopted this power because of the fact that they were engaged in electrical work or otherwise has electric power of "juice" in their plant in excess quantities, so that the item of charging the batteries assumed less importance.

Steam has in the past year won many friends in the commercial industry, although in fairness it must be said that these have been confined mostly to fire, police, hospital and similar service, where the standard chassis could be used with a special body.

Range of Use Extending.

The wide range of users has now become wider than ever before, as was natural with a natural and healthy growth, but the greatest spread has been in or rather for fire service. This branch in which the self-propelled car advantage of speed is most advantageous has made the greatest strides forward, many of our cities after extended tests having discarded horses entirely. This has been due mostly to inherent superior ability on the part of the self-propelled apparatus, but also in part to the growing scarcity and consequent high prices of suitable horses. A single instance of this may be mentioned. A Southwestern city in need of heavy fire horses could not buy them because the appropriation allowed only \$350 per horse, whereas the prices for suitable horses ranged from \$400 apiece upwards.

The outlook for the coming year in the commercial vehicle line is more than bright; it promises to be a record year. With the economies attendant upon the recent hard times, the attention of many business houses was called to the excessive cost and growing inefficiency of horse traffic. This has resulted in a thorough investigation of the power wagon and its merits, which will result in largely increased sales the coming Spring, or as soon as the horse equipment can profitably be disposed of. Many prospective buyers of trucks put it this way: We are going to change over to motor trucks, but must dispose of our horses and wagons first. This we will do in the Spring as soon as the market for horses and horse equipment improves. Winter being the poorest time to sell.

AUTOCAR, Autocar Co., Ardmore, Pa.—Autocar characteristics include several features of note, among which mention will be made of the fact that the chassis frame is of steel, in which hickory is accurately fitted to render the frame as a whole strong and to give a certain flexibility not to be realized in any other way. In the motors of the Autocar it is the custom to use two fly-wheels, and the crankcase design enables the operator to remove covers to get at the essentials, as the camshaft, crankshaft, connecting rods, and for the purpose of making a general inspection. In the rear axle work is free from joints, and brazing is avoided. It is the idea of the Autocar designers to keep away from all the modes of procedure which, while they may work as a rule, do represent a percentage of failures on the count that workmen are not up to a high level of efficiency every day in the year, and to eliminate the chance of failure is to avoid the personal equation. As a strictly utility proposition, the Autocar should, and undoubtedly will, appeal to merchants and others with goods to transport.

CADILLAC LIGHT DELIVERY, Cadillac Motor Car Co., Detroit, Mich.—Like the product of other pleasure car manufacturers, this one-lunger does not differ in a marked degree from the single-cylinder touring car. The body, of course, must differ, and the driver's seat, too, but otherwise the differences are minor ones. This is not in itself a bad fault, for the success of these cars with drivers of mediocre ability in pleasure fields presupposes a duplication of this same success in the commercial work, where the driver is an unmechanical horse-driver. In the service of groceries, laundries, hatters, jewelers, shoe dealers, florists and similar business houses requiring a light weight but quick delivery, this car has been a big factor in the development of the industry. Its construction and method of operation, designed with a view to economical operation, has done much to favor its further use, an average of about \$15 per month for all expenses, including fuel, by a Far Western company having about a dozen of these cars, showing what this sturdy little worker can do. As upkeep and fuel bills are those

watched with anticipated horror by the small fellow, who has just ventured to buy a delivery wagon, this little car has made good.

CHAMPION, Champion Wagon Co., Owego, N. Y.—The name of this line of electric trucks is indicative of their quality, Champion, the quality that makes champions, that is the keynote of the product. The full line consists of light trucks, delivery wagons and heavy trucks from 500 pounds capacity with a radius of 35 miles on one charge of 2,500 pounds with a 30-mile radius, and still larger, heavier cars with a smaller radius. All of the product has double motor direct drive equipment. Now that the economy of the electric vehicle has been demonstrated to the satisfaction of all who have investigated the subject intelligently, particularly for short hauls within the battery radius, it may be expected that a great number of these will be put on the market, being simpler to manufacture and build than a gasoline-driven car of equal carrying capacity. The electric may be relied upon to work in all kinds of weather, regardless of heat and cold, which cannot be said of the horse.

ELMORE, Elmore Mfg. Co., Clyde, O.—The popularity of the taxicab necessarily manned by horse-drivers has been partly due to efficient operation, which was only made possible by the inherent simplicity of the mechanism.

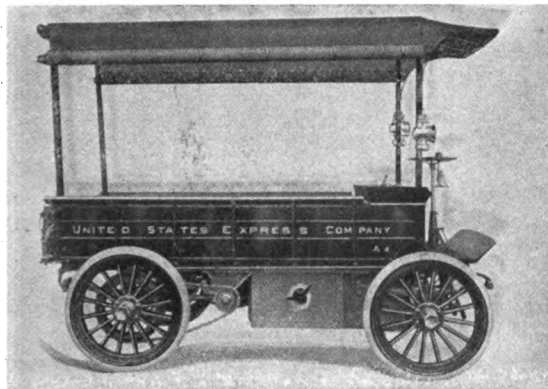

Champion Electric Express Truck.

Among the few devices which have made this simplicity possible none rank higher than the two-cycle motor. Dispensing as it does with valves and all valve operating means, not only is the great number of parts materially reduced, thus reducing in the same proportion the spare parts which must be carried, but the sources of noise are reduced and the weight is reduced. More than all this, perhaps, is the feeling of security which the innate simplicity of this prime mover gives to the operator, with which comes also a sense of confidence, the whole resulting in superior operation. For these reasons this cab has made progress continuously from its inception to date, with the prospect of this continuing indefinitely in the future. No more promising field of development has been opened up in the history of the commercial car than that offered by cab construction. This company is to be congratulated upon an early and successful entry into this field.

FRANKLIN, H. H. Franklin Mfg. Co., Syracuse, N. Y.—The air-cooled feature of the motors on Franklin touring cars will be continued on their line of commercial cars also. These include L-1, a light delivery wagon of 1,000 pounds capacity; L-2, a heavy delivery or light truck capable of carrying 2,000 pounds, and J-3, a two-ton stake truck. Not only the engine, but the frame of wood, full-elliptic springs and other essential features will be retained. All of these vehicles have the engine beneath the floor boards and front seat, which materially



Police Patrol of the Franklin Company.

shortens the front end of the car and thereby decreases the wheelbase. The latter is a valuable feature on a commercial wagon, affording, as it does, facility in turning and maneuvering in small spaces. Thirty-two-inch wheels are provided on all three types. The L-1 front wheels are 32 by 2 1-2 and the rear 32 by 3. The L-2 front wheels are 32 by 3 and the rear 32 by 3 1-2. The J-3 front wheels are 32 by 3 and at the rear 32 by 3, with twin tires. The J-3 has a stake platform with a carrying area of 62 1-2 square feet, the diameter being 5 by 10 1-2 feet. In these trucks a worm drive rear axle is used. The worm and the worm wheel are exceptionally large, and the tooth pressures are therefore at the minimum. The J-3 moves normally at the rate of about ten miles an hour and has carried a load of three tons up an 11 per cent. grade one-quarter of a mile in length and paved with brick. In all these commercial vehicles are used full elliptic springs in front and semi-elliptic and coil springs at the rear. This is productive of easy riding at the seat and increases the load capacity. The rear axle is in such position that it carries two-thirds of the weight. This also reduces the work of front springs.

GENERAL VEHICLE ELECTRIC TRUCKS, General Vehicle Co., New York City.—In the field of electric commercial vehicles there are few exhibitors; those who do show cars, however, will make up in quality for the lack of quantity. One of the most interesting sections will be that of the General Vehicle Company, of New York. This company is the successor to the Vehicle Equipment Company, the pioneer in the commercial automobile field and the builder of a large percentage of the electric power vehicles now in commercial service. Five of the seven sizes manufactured by this company will be shown, the smallest being a light electric delivery runabout with closed body, having a capacity of 350 pounds' load, a speed of 14 miles per hour, and a mileage of 50 miles'

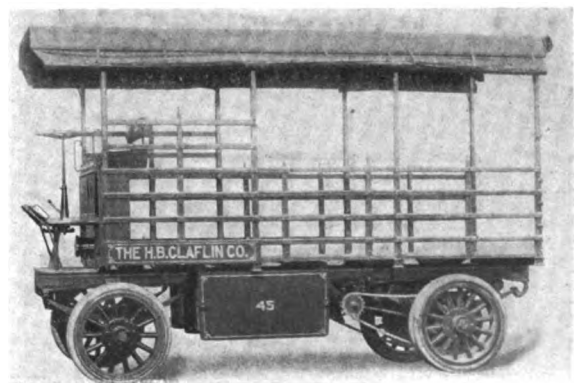

Heavy Truck of General Vehicle Company.

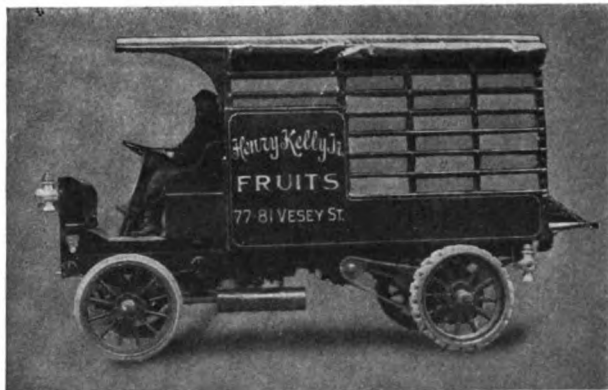

Two-Ton Truck of the Hewitt Company.

travel on one charge of the battery. Standard models of wagons having 1,000 pounds, 2,000 pounds, and 3 1-2 tons will be shown ready for work. These have a radius of action, respectively, of 40 miles, 40 miles, and 35 miles, while the speeds are 11, 10, and 7 miles per hour. A representative chassis of 2 tons' capacity also will be shown, illustrating the general design of all models of the power plant construction. The company has a modern factory in Long Island City, and is building many of the electric trucks and delivery wagons used in New York City. Its power vehicles are also in use in a majority of the large cities of the United States.

HEWITT TRUCKS, Hewitt Motor Co., New York City.—To give satisfaction a motor truck, or, in fact, any commercial car, must run continuously for a year or similar long time before overhauling. This necessitates the best of materials, workmanship and design. In the line of trucks produced by this firm the two former points have been sharply accented by the use of the best materials procurable in this country or abroad and the finest of workmanship both in the machining operations and in assembling. While in the latter, the matter of designs, opinions may differ, the fact remains that a very original and well-thought-out product has resulted. The left-hand control used by this company for several years past has now been copied by many other manufacturers, being the feature of the commercial exhibit at the recent show. In the matter of spring suspension for the radiator, planetary transmission, heavy long stroke, slow-speed engine and other advanced features, the industry has not yet copied these, good as they are, but this may be expected the coming season. The simplicity of the planetary transmission and its usefulness in the commercial vehicle industry for this reason have been appreciated and taken advantage of by several well-known makers. Hewitt has produced

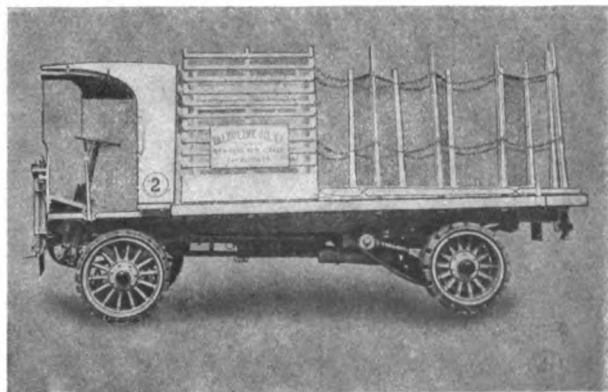

Five-Ton Truck of the Hewitt Company.

an excellent example of this form of speed change device and operates the same with pedals, which are so interlocked that each one automatically throws the others out of engagement. This is an exclusive feature.

KNOX TRUCKS, Knox Automobile Co., Springfield, Mass.—These people were pioneers in the commercial field, and the lead which they then obtained has never been relinquished. At the present time they stand in a similar position with regard to motor-propelled fire-fighting apparatus. By this is included fire chiefs' cars, auxiliary squad cars, salvage and first-air wagons, chemicals and other strictly fire-department vehicles. That these wagons are economical and successful workers is shown best by the Springfield Fire Department's experience with their auxiliary squad automobile, which cost but \$144.62 to run for a year, with \$85.14 for repairs, as against \$534 for horse service, repairs being equal. This formed a saving of \$390 per year, which in a few years would pay for the car. Not only do this firm build fire wagons, but a line of excellent trucks as well, the latest of which to be announced is the five-ton truck. This big wagon has a 50-horsepower water-cooled motor with equal bore and stroke, 5 1-2 inches. The feature of this truck's cab and driver's seat, which is situated above the engine, is the large amount of space allowed to get at the motor. This

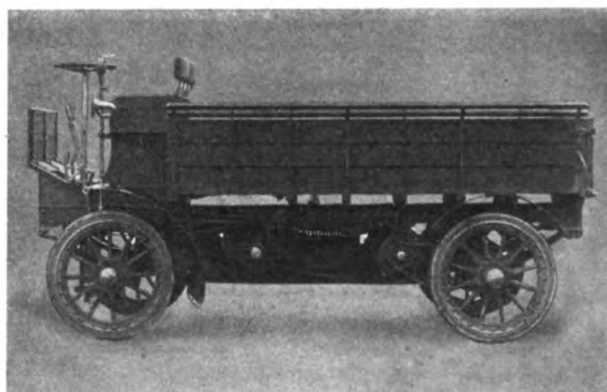

Light Truck of the Knox Company.

is also arranged so that the rear portion of it by loosening a few bolts may be turned over backwards out of the way. This feature is one that will be appreciated more by the truck driver than by the lay public, to whom it means nothing. To the former, on the other hand, this means a great deal in making repairs, as, for instance, in replacing a cylinder. When the cab is solid and low this is a bigger job than putting in a new engine transmission would be, but in this case it would be rendered comparatively simple.

PACKARD TRUCK, Packard Motor Car Co., Detroit.—Years of experience in the production of a superior touring car could not result otherwise than in the evolution of a superior truck once attention was turned to that field of endeavor. In the construction of the Packard truck the manufacturers turned to this problem the accumulated good experience of many years' producing in their three-ton power wagon, a prime mover of superior merit. It is not strange, in view of the foregoing statements, to find these trucks making good all over the country. A recent trip from Pittsburg to Wheeling, W. Va., demonstrated in a remarkable manner this fact. This distance of 67 miles, an unusually long trip for a truck of this high load capacity, was made in 6 hours 25 minutes actual running time, an average of about 10½ miles per hour. This was only meritorious when the hilly

mountainous character of the road is considered, viewed in which light it forms a remarkable performance. The figures for operation, including oil, gasoline and all supplies, are of equal interest, being but \$2.09, which represents a cost per mile of \$.0312. Now, with horses this would have been a two-day trip and two very big days at that, with a figure per mile of no less than eight or nine cents. So, without intending it as such, this long tour showed the marked superiority of the motor over the horse truck.

POPE-HARTFORD AMBULANCE AND PATROL, Pope Mfg. Co., Hartford, Conn.—In this newly opened field of hospital and police service the combined qualities of the speed and mobility of the pleasure car with the carrying capacity of the truck have served these vehicles as a starting point from which to make the greatest progress of any branch of the industry in the past year. The ambulance has an enclosed rear opening body provided with stretchers and low cots, as well as such modern equipment as an exhaustive study of ambulances and hospital appliances has enabled the manufacturers to say were necessary. The police patrol, while having an enclosed body also, has longitudinal permanent seats to accommodate ten or more policemen. The usefulness of this vehicle with its ability to take that many policemen anywhere in minimum time is self-evident. This may be had also, with the seats hinged to let down, giving room for a bed or cot and thus converting the wagon into an ambulance. By the use of this style of equipment the same car does double duty. Later construction, the details of which have not yet been given out, state that this same chassis may be fitted up for a chemical or a hose wagon.

SAMPSON TRUCK AND ROAD TRAIN, Alden-Sampson Mfg. Co., Pittsfield, Mass.—Without a doubt the most interesting exhibit in the line of heavy commercial cars will be that of the Alden-Sampson Manufacturing Company, which will exhibit its road train, and for the first time a new four-ton truck. The latter will make its initial bow to the public at that time, but the former will be a repetition of the exhibit of last year. The latter will be awaited with interest by the trade at large, as the details of this machine, which have thus far found their way into print, have been few and far between. With a four-cylinder water-cooled vertical motor of 5-inch bore and equal stroke, rated at 40 horsepower, this truck is well equipped. In the change speed gear, with four forward speeds operating on the selective principle, a new idea in truck construction is advanced, this being the first truck to have a four-speed transmission.

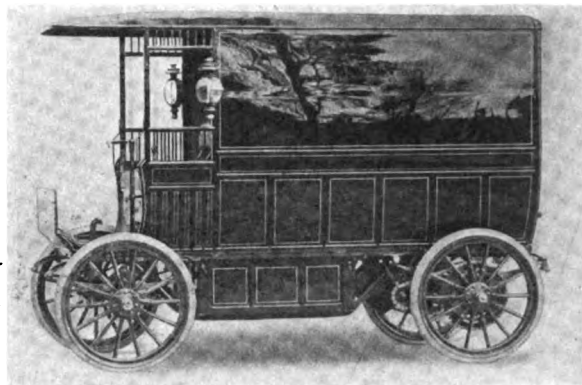

Studebaker 1500 Pounds Delivery Wagon.

The road train is probably the largest motor carrying arrangement made in this country. The ordinary four-wheel truck reaches its maximum carrying capacity at about five tons, overloads of 50 per cent. bringing this up to 7 1-2 tons. In this road train, then, we have the next largest unit. It consists of a tractor furnishing the power and arranged to carry 3-4 tons load as well. The trailers drawn by this tractor, which have six steel-lined wheels similar to it, have a capacity of 6-8 tons each. This allows of 9-12 tons with one trailer and so on with more trailers up to three, which would give a carrying capacity of 21-28 tons.

STUDEBAKER ELECTRIC TRUCK, Studebaker Automobile Co., South Bend, Ind.—The electric truck or wagon was one of the first developments of the automobile movement, and the pioneers in this include the Studebaker line. These are complete, covering the whole demand in six standard sizes, with paying load capacities from 800 pounds by natural steps up to five tons. In any one of these any type of body may be had to meet the requirements of wagon and truck users. The electric truck for all ordinary service, not including long hauls, has been shown to have many advantages, chiefly on account of the freedom from frequent adjustments and the fact of electric motors having a revolving, not a reciprocating, motion. An additional point in their favor and one that is along lines which may be strictly up to date, is the fact that the ease and simplicity of operation of electric wagons is remarkable. The reputation of the parent Studebaker house is extended to cover the commercial vehicles, as well with the result that the motto of "the automobile with a reputation behind it" may be applied with equal force to the power wagons, considering the word automobile in its broader sense to include all of the former.



The Road Train of the Alden-Sampson Manufacturing Company.

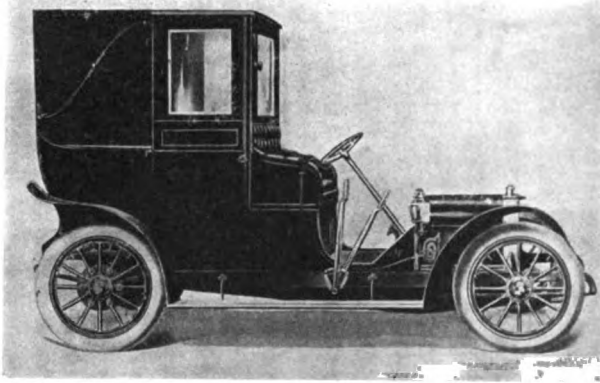

Thomas Town Car, 18-Horsepower.

THOMAS TOWN CAR, E. R. Thomas Motor Co., Buffalo, N. Y.—The recently developed field of taxicabs and town cars is one that many pleasure manufacturers have ventured into. No list of these would be complete unless it included the firm which evolved the discussion-producer when they made public the details of their cab chassis, the Thomas town car. This was one of the first American cars with a block motor and probably the first with two bearing crankshaft, these bearings being of the radial ball type. This construction allowed of a remarkably short engine. This in turn favored a short wheel-base, which, taken in conjunction with the narrow tread allowed of the short radius of turning action so necessary on these public service cars. The instant successful use of these cars in all of the large cities, Boston, New York, Washington and others, placed this manufacturer at one bound in the rank of able small car builders, his previous position having been with the large car only. These cars are elegant in their appointments and their use is not restricted to the public service by any means. In fact, town cars have become very fashionable with exclusive people for shopping, theaters, calling and all fashionable functions, and in this field are gradually supplanting the horse broughams, coupés, victorias and station wagons so generally used. Being primarily designed for this work and constructed with that end in view, they do not qualify in any sense in the same category with the ordinary small touring car adapted to this service by the application of a closed body.

WALTHAM MERCHANDISE WAGONS, Waltham Mfg. Co., Waltham, Mass.—In commercial work by far the largest field exists for the smaller lower-priced cars, which, just because they are smaller and lower powered, are within the range of usefulness and purchasing ability of the masses, the butcher, the baker and candlestick maker, as it were. The Waltham Manufacturing Company has shown discretion in confining themselves to this field exclusively, with a chassis having horizontal opposed water-cooled motor, bevel friction transmission and double-chain drive. This chassis may have any body suitable for the work it is to do. The entire power plant, consisting of motor, radiator, cooling system, friction transmission and countershaft, are mounted on a pressed steel sub-frame, which can be quickly disconnected and dropped down upon a truck and removed for convenient repairing or the substitution of a reserve power plant, in this manner keeping the car or a number of cars constantly in commission. The exchange can be made in less than an hour. This is economical and convenient for the merchant using a number of cars, for an emergency car will not be necessary. This principle of grouping parts is carried throughout the entire construction, the power plant itself being sub-

divided into smaller groups of co-acting parts, interchangeable with similar groups kept in reserve for quick repairs.

WAVERLEY ELECTRIC TRUCKS, The Waverley Co., Indianapolis, Ind.—These new people, successors to the Pope Motor Car Company, will continue that firm's unexcelled line of electric commercial cars. These have a very wide range from eight-passenger or 1,200 pounds up to five tons, the latter size being a favorite among the brewers. In considering the question of power wagons, urban and interurban service must be separately considered, the data, considerations and principles controlling the service being quite different in the two cases. It is generally considered that the latter, the interurban, offers the greatest field for the gasoline car, the inherent limitation of the storage battery precluding the operation of electric over distances close to or greater than the battery radius. The urban or city service, on the other hand, gives a field in which the electric may compete on nearly equal terms. It is in this field that the greatest competition does exist and in which the electric more than hold their own. Any one familiar with the Adams Express service in Buffalo or Macy's department store delivery service in New York City and many others will see the truth of this statement at a glance.

ADVISABILITY OF PROPER SELECTION.

With a display of vehicles in the commercial section to fill every possible want, it remains for the users to look the situation over with a display of acumen and avoid the mistake of a half-hearted selection at the cost of ultimate failure. When horses are considered, the best is counted none too good. When it comes to power wagons, the same holds true, only to a more marked degree. An appropriate selection is one in which the vehicle is not only suited to the work to be done, but it remains for the purchaser to take into account the future. If the business is one which partakes of permanence it certainly will pay to put enough money into the vehicles to make sure that upkeep will be moderate.

Style is not so much a factor in commercial work, and it is fair to assume that repairs will be made year after year until the car is as the proverbial "jack-knife"—nothing but the handle left, etc. Upkeep is tolerable in a well-designed power wagon, just as it is in any well-designed machine for any purpose. But it must be well designed, and it must take into account the fact that it is intended for continuous service. If the bearings are of the kind which can be replaced, then it is plain that when they are too loose to take up or replace them will be the proper thing to do, and the cost of the replacement should be but slight. If, on the other hand, a car is of a half-baked design, it is possible to believe that the bearings cannot be replaced unless at a cost which will serve as a ban to the process.

If the power plant is one to stand the road inequalities and the high "torque" phenomenon, then it will be possible to take into account a continuity of the service over a term of years. But should the motor and the transmission be distorted by the high torque, then it is assured that the power plant will go beyond repair within a short while and a new power wagon will be the best solution of the problem. All these matters have to be considered, and it is worth while to consider the competence of the builders of the power wagons contemplated for use in a given service, and ascertain if the wagons are truly in accord with the requirements. The cars at the Garden are wisely selected to illustrate competence.

PROMISING VALUE OF THE A. L. A. M. LABORATORY

By THOS. J. FAY.

FORESIGHT eliminates gradient and serves as a lubricant for the ways leading in a beeline to the greatest possible satisfaction all around. The "Twentieth Century Limited" starts from the "laboratory." But the laboratory in itself is of almost no value at all. The information must be appreciated, and the dictum of the laboratory must be the rule and guide of the constructor. The mere knowing makes for nothing, unless it can be said that crime, if such there be, consists in knowingly doing wrong. At all events, it is not only desirable to have a laboratory, but it is important to conduct the process with the greatest possible care, and the knowledge allowed to emanate should be from what might be termed a "high source," of undoubted competence.

When the automobile reached a certain point in its development it was the consensus of opinion that something

pocketbook. The laboratory was the place in which the proportions of the food were ultimately fixed upon in accord with the dictates of what might be called a "balanced ration," which balance showed a lacking as the situation did obtain prior to the advent of the laboratory.

At first the several makers of automobiles looked askance at the doings of the "Mechanical Branch," primarily because the cost looked out of proportion to the results, and, again, in view of the propaganda of the vendors of material, ever ready to promote a fallacy if the same would only serve as a trough or a chute, down whose slippery concave money would flow to keep the water from evaporating out of the stocks, which to the one who can read spells high price and low quality of the materials emanating from such sources.

On the other hand, automobiles were imperced from

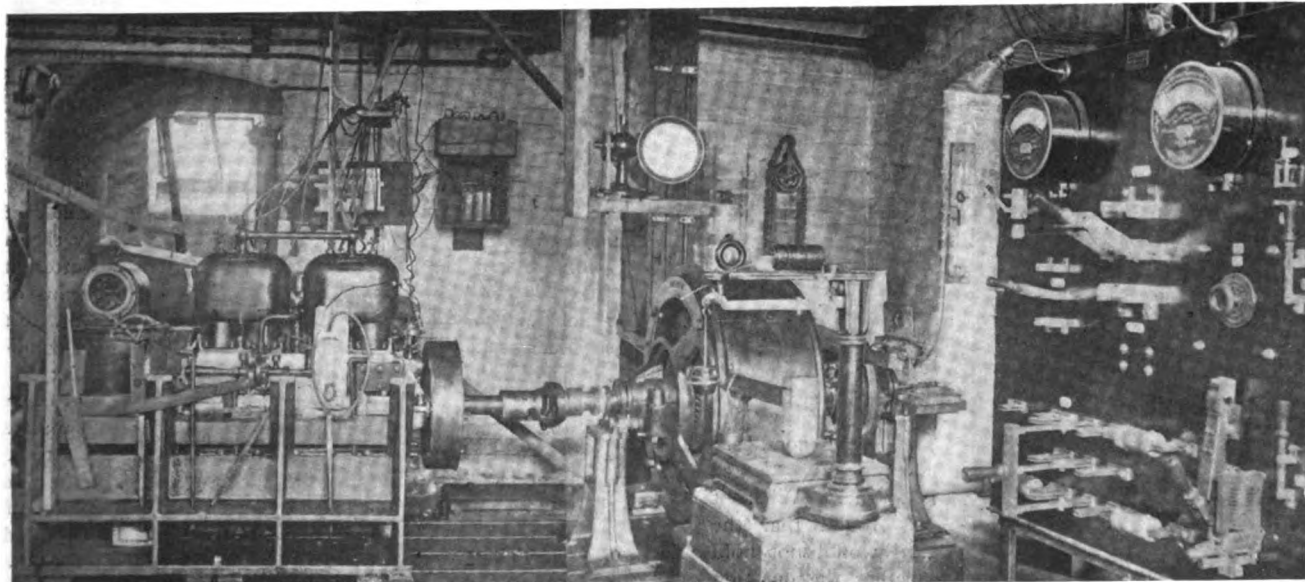

Electric Dynamometer for Use in Determining the Actual Horsepower of Automobile Motors.

was lacking, and that something was prone to manifest itself as materials or the proper utilization of the materials available for the purpose. When the question was ripe for discussion, then it was that the A. L. A. M. took time by the forelock, and in establishing the "Mechanical Branch" refrained from tying the hands of the directors of the same, while they, in turn, free to follow their own bent, made bold to pave the way to success by the road called knowledge, even at the expense of prolonged and painstaking investigation, at a cost, which, reckoned in the abstract, footed up to a pretty penny.

As a concrete proposition, the cost was a mere *brutum fulmen*; in other words, a harmless thunderbolt; harmless in the sense that the cost was slight on a pro rata basis, and a thunderbolt from the point of view of the surprises in store for the men who previously thought that the fabricators of steel had kindly imparted all of knowledge that was good to know.

It is claimed that in Russia the common people should not know too much. The users of steel were as the common people, and they were fed on a baby food that failed to impair the digestion of the feeders. On the other hand, it cannot be said that the eaters gained in weight, especially in the region of the

abroad, the reputations of which were so good as to cause wonder in the light of facts under the nose of every American builder. Why the American cars would not stand the pace, was the question, and as one French designer put it: "Copy the car if you like; make everything in exact replica; it matters not, the car will not be the same." The question was, Why?

The learned gentleman from France was telling the truth, and he knew that the "quantity makers" in America would defeat every attempt to interject quality if it was a question of the quality of the steel. Just so long as the makers of automobiles were content to depend upon the salesmen of the steel mills for the information they required, just so long was it possible for the steel makers to keep to the quality of the greatest dividends—for them, not the makers of cars. It was rather strange to see the makers of automobiles taking instructions from "salesmen" from the steel vendors, using the "Bessemer" they were so anxious to get rid of. The same makers of automobiles did not allow their own salesmen to dictate as to the designs in the engineering offices of the makers of automobiles.

The great importance of the laboratory was not, at first, quite so apparent as it is to-day; nor is it sure that every user of automobiles understands the situa-

tion with that vividness which impresses itself upon one, when he counts the money in his own "till," only to discover a material shortage. It may seem a little farfetched to thus prolong the discussion without elaborating upon the details of the laboratory itself, but it is desirable, as is adequately shown by simply relating the story of the hunter who, after a rabbit, uncovered coal, in the process of digging the rabbit out of his burrow, and so hot was he in his quest for game that the value of the coal was measured in curses because it was in the way.

It would be as a waste of time to talk about a few machines and measuring instruments, however precise they may be, without drawing a picture of sufficient clearness to establish the facts so that they will find lodgment in the "think-tank" of the reader. It is like "skimming" over a story.

In the laboratory it is the aim to get at the inner facts and to account for the successes and the failures in a way that leaves no room for doubt. A piece of steel is a very uninteresting bit of matter to the man who has no depth of knowledge; this same piece of steel is an adequate subject for the greatest mind during the interval from maturity to the grave. But if the steel is of interest, so are the wood and the oil, the gasoline and the varnish; all can

take time, and in each will be found something that will persist in defeating success in the absence of knowledge of the proper means of thwarting the ills.

The steel maker says: "You do not have to know what the composition is so long as the material will do the work." The same good Samaritan says: "Leave it to me." When it was found that the steel would not hold together the question

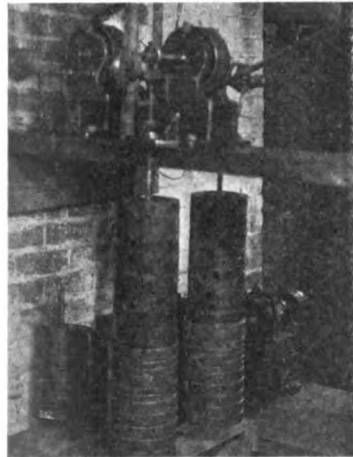

Souther Testing Machine.

was, What is the composition of the material which proves to be of no fitting value? To know is to analyze, and a chemical research demands the equipment for the purpose. The conclusion was that a chemical division in the laboratory was as necessary as the roof over the building to conserve the heat in the Winter time.

Next, it was decided that the conventional physical properties of the materials would serve as a rough guide to the facts to be elucidated in the long run, by means of more exacting tests of the materials, the qualities of which indicated value to the extent to make further research worth while. The result was a testing machine had to be provided, one with the wide range to handle iron, with its low strength, on the one hand, and nature hard alloy steel on the other; as well as all the materials within the top and the low limits.

Then it was desirable to be able to note the texture of the materials, and to just look at them with the naked eye was not to be able to see the real situation. Microscopic work was regarded as of the greatest value, and "photomicrographs" would make the records permanent. This equipment is probably quite as important as any, since it has been fully established that steel resides in several conditions, depending upon the composition and the mode of fabrication, not to mention the fact that heat treatment does alter the texture of the steel for good or for ill.

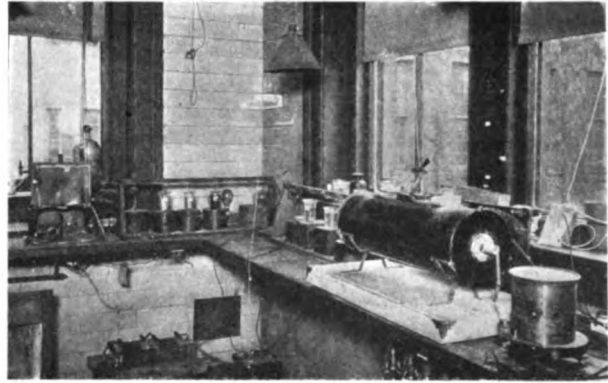

Equipment for Heat Treating Steel.

In due course it was established that the "static" ability of steel had little to do with the facts, from the point of view of life of the same, under conditions involving "kinetic" work. The older methods of fixing upon what was called the "shock ability" were not to be regarded, but it was soon found that this shock ability was not to be considered as a fair measure of dynamic ability from every point of view. There was the question of the effect of vibrations, within, let it be said, well within, the elastic limit of the materials.

It was this latter question which proved to be of the greatest importance, and the "vibratory test," though long, and even costly, did in the end pronounce the quality of the material in terms which were not to be lightly thrust aside. When Henry Souther took hold of the matter, it did not take him long to devise a machine by means of which the vibrations could be artificially induced into test specimens, and the life of the materials under such conditions could then be measured with the greatest certainty.

In the meantime the shock tests of "Fremont" and other methods were taken advantage of, in order to accumulate all the knowledge possible in relation to the materials to be used in the automobiles of the Licensed Association. In these several ways, under the guidance of the committee of the Mechanical Branch, the questions were all thrashed out, and it was in thus going at the matter which led to the American supremacy of the automobile.

In the meantime it was necessary to be able to show that actual improvement could follow, else what would be the gain in thus maintaining a costly situation? To be able to fix upon the gain it was necessary to devise testing equipment such as would allow of the cars being tested, in order to show the power developed and the manner in which the same was actually utilized, taking into account the several losses. Thus was it necessary to go into the analysis of the performance of the cars, and by so doing determine



Chemical Equipment for Analyses.

AMERICAN AUTOMOBILE STEEL

By HENRY SOUTHER, A. L. A. M.

EVERY known steel used for commercial purposes is just as available in the United States as anywhere else in the world.

Norway and Sweden have unusually pure ores, but the raw materials made from them are just as readily obtained here as elsewhere. There is no mystery about them; they are just pure and good. When our fine steel makers want good raw material they get it, whether it be from Sweden, Spain, Africa, Cuba or Lake Superior. Our steel makers are just as well trained as any and can make the best of steel.

They do not always make the highest grades of steel, because the demand does not always exist. Here, then, lies the real reason why early automobile product in the United States was not of high-grade material. It was not demanded. On the contrary, by some it was pooh-poohed; the advocate of fine steels was laughed at. "Why buy 15-cent steel when steel could be had for 2 cents?" "With our design any old steel will do," was sometimes heard. Our earliest makers (with exceptions, of course) did not have time to think about what kind of steel they might use. They were too busy making something that would go and keep on going.

Now all is different; the pendulum has swung the other way; some are buying 15-cent steel and putting it where it does no more good than 2-cent steel. Popular opinion demands it, and it is advertised. Many, however, have at all times kept pace with the art and began to use high-grade, high-priced steels, as far back as 1900, where such steels were called for.

Steels were tried and fully proven. Expert knowledge was used conservatively, and there was no violent swing of the pendulum from the worst to the finest, from one extreme to the other. No advertising was done. A trade secret could not have been guarded more closely. Good cars were built. The secret of the use of steel is to put the *right steel in the right place*.

The highest-priced imported steel suited for horseshoe nails would not do for an automobile spring as well as the lowest-priced, lowest-grade Bessemer steel made; or, for another extreme, the best chrome-tungsten tool-steel at 60 cents a pound would not make as good rivets as ordinary steel at 2 cents.

It is not always best to use the very best, the ideal steel, for a purpose. The very best is sometimes difficult to handle commercially. Better results may in some cases be obtained by using a slightly less ideally desirable steel. This brings up the importance of handling steel. Much skill has always been expended in handling tool steel; it has always been regarded as most important.

Not so with structural steel; and yet just as much is to be gained by handling it so as to produce a strong, tough material, capable of sustaining shock, vibration and the banging it gets, in an automobile.

The makers of guns, armor-plate, propeller-shafts for torpedo boats, have for many years practiced with much skill the suitable treatment of structural steel; but these people and their engineers did not, generally speaking, start the manufacture of automobiles; so this skill was not fully used by the automobile builder.

Some engineers went from the one industry to the other, carrying this valuable knowledge. These men

helped to produce the high-grade cars made in this country, which have been every bit as good as any cars in the world, so far as materials and wear are concerned.

All steels were available; and in the United States the right steel was selected for a purpose. It was properly handled and treated from start to finish, the result being a perfectly balanced car, so far as wear was concerned. No more could have been done in Europe or elsewhere. Worse has been done in Europe, as shown by the way some imported cars have disintegrated after about two years' use.

In other words, the materials are available everywhere; the knowledge of how to use them is not. That is the difficulty. Breakages are due quite as often to bad design as bad material. The worst of it is that the bad designer may be found in combination with the bad chooser of materials. He "knows it all."

In this same direction it is unfortunate that too many automobile companies are born to develop a "world-beating idea" regardless of materials, design or anything else. It is unfortunate that such concerns live long enough to put automobiles on the market, but they do because some rich victim usually gives up long enough to do just this and to find out that there are other things required in an automobile than an idea even if it be a "world beater."

The right material for such to use was at hand but was not selected, and even the "idea" was ruined perhaps by not using the right material in the right place.

Some builders of fine machinery (at the head of their kind) have started cheerfully into automobile making, using the same materials and same designing methods modified to suit the new business, only to discover at great cost that the automobile is "different." They did not call in any help; why should they if at the head of their profession?

The knowledge and materials were available but were not selected, and yet some people blame such failures to the fact that the United States cannot make the fine steel found in Europe.

Unfortunately those who know the least about steel and its treatment are continually rushing into the public press and spreading a lot of rot about steel. Such stuff is read by many who ought to know better and is followed to their harm. The good steel is there just the same, awaiting intelligent selection; and good cars are made by those who select wisely. At the same time, it must not be forgotten that it is quite possible to make a sturdy and good car with no expensive steel in it.

The design must be right, however. The product will not be light. Until very recently no steel other than simple carbon steel ever entered into the construction of the best locomotives. They did not need to be light, and long experience had produced a suitable design. Several excellent automobiles built of relatively ordinary steel, but with design and material suited to each other, exist and have done splendid work.

All this goes to show that the materials are to be had for the asking at a price. The problem is to know what to ask for and how to get best value for money spent, all things considered; what is right for one job may be wrong for another, nor is it suggested that free advice be accepted from steel makers.

OUTLOOK IN THE AMERICAN AUTOMOBILE INDUSTRY

By E. P. CHALFANT, GENERAL MANAGER A. L. A. M.

IN many fields of engineering there has been a most interesting evolution by way of improvement in materials, design and methods through the reciprocal effort of the constructor and the metallurgist. In no case, probably, has that advance gone further in recent years than in the higher grades of machinery. The combustion motor, the motor car, and by no means least, the modern tool, have stimulated investigation and led to discovery of new and most useful alloys.

In solving the problems of the automobile builders, notably in getting the requisite combination of strength with limited space and weight, important developments have been accomplished which have a bearing on general machine construction. Inventive genius was forced to overcome difficulties which had never been encountered hitherto, except, possibly, in a limited way.

In this work the Association of Licensed Automobile Manufacturers has played a most conspicuous part. The membership of this Association is as follows:

Apperson Bros. Automobile Co.	Kokomo, Ind.
The Autocar Company	Ardmore, Pa.
Buick Motor Company	Flint, Mich.
Cadillac Motor Car Company	Detroit, Mich.
Chalmers-Detroit Motor Company	Detroit, Mich.
Corbin Motor Vehicle Company	New Britain, Conn.
Electric Vehicle Company	Hartford, Conn.
Elmore Manufacturing Company	Clyde, Ohio.
Everitt-Metzger-Flanders Co.	Detroit, Mich.
H. H. Franklin Mfg. Company	Syracuse, N. Y.
The Haynes Automobile Company	Kokomo, Ind.
Hewitt Motor Company	New York City.
Knox Automobile Company	Springfield, Mass.
The Locomobile Co. of America	Bridgeport, Conn.
Lozier Motor Co. of New York	New York City.
Matheson Motor Car Company	Wilkes-Barre, Pa.
Packard Motor Car Company	Detroit, Mich.
The Peerless Motor Car Company	Cleveland, Ohio.
The George N. Pierce Company	Buffalo, N. Y.
Pope Manufacturing Company	Hartford, Conn.
Pope Motor Car Company	Toledo, Ohio.
The Royal Motor Car Company	Cleveland, Ohio.
Alden Sampson, 2nd	Pittsfield, Mass.
Selden Motor Vehicle Company	Rochester, N. Y.
The F. B. Stearns Company	Cleveland, Ohio.
Stevens-Duryea Company	Chicopee Falls, Mass.
Studebaker Automobile Company	South Bend, Ind.
E. R. Thomas Motor Company	Buffalo, N. Y.
Walter Automobile Company	Trenton, N. J.
Waltham Manufacturing Company	Waltham, Mass.
Winton Motor Carriage Company	Cleveland, Ohio.

It may be said unreservedly that through the efforts of this Association, the standard of American automobile steels which in past years have been looked upon in a secondary light has been raised to a plane even higher than that of foreign manufacture.

Standardization is what many users have longed and hoped for. The A. L. A. M. has brought this about, notably in screw threads, rod and yoke ends, spark plug shells, motor power rating, etc. During the past four years new standards for the various metals used in automobile parts have been worked out and annually compiled, with notes and instructions on the proper handling of the same, for the A. L. A. M. members.

The great development of four or five years has been the refinement of construction, aiming at absolute reliability; and the proof of the success is seen in the 150,000 automobiles now continually running in the United States. Incidentally, it may be said truthfully that the American automobile is the machine par excellence of the world for interchangeability of parts. To-day also we find the American-made automobile, not alone the product of a few, but of at least thirty manufacturers, a match for the best foreign car in world-

wide use, and for unusually severe road conditions, like those of our own country, where our machines were developed (not on the boulevards of Europe), superior in many ways.

This has been conclusively and forcefully demonstrated by the magnificent American cars and classes shown at recent exhibitions, more particularly at the stands of the members of the Association of Licensed Automobile Manufacturers, and by the eminently satisfactory service of these cars for years in the hands of private owners and in contests of nearly all kinds, in which foreign-built cars have participated, or, for some reason best known to their backers, not been entered.

As an example of the superiority of the American car in hard usage, as is well known, the Thomas, an ordinary car selected from stock, was the winner of the race around the world. The Locomobile won the recent Vanderbilt Cup Race, in which representative foreign cars were entered. The Pierce Arrows, as well as other Association cars, have for year made perfect scores in the Glidden tour. The Franklin holds the time record for trips by automobile across this continent. Recently a Packard touring car was driven from the Pacific Coast here, by a gentleman who was accompanied by several members of his family, including the women. Two women alone have crossed the United States in a Waltham buckboard. This list of accomplished marked achievements by Association cars could be much added to.

If it had nothing else to recommend it but its time-saving and health-giving attributes, the automobile would be a permanent institution. But it is as a vehicle of commerce that it is to figure more prominently in the future. The world wants labor-saving devices; the automobile is one. Manufacturing plants find hauling their product with motor cars economical from every standpoint. The automobile is becoming a part of every well-regulated municipality in the health and fire branches of the public service. We often see cases of self-propelled vehicles coming back from fires, meeting the horse-drawn vehicles of the fire department going out. The Federal Government is converted to the utility of motor vehicles.

In isolated sections of the country, far from the beaten paths, the miner and farmer use the horseless vehicle.

The United States produces annually something like 80,000 automobiles, while France produces about 40,000 and Italy 25,000. Germany is another producing nation. Taking the average price of cars produced in the United States, as low as \$1,500, it is seen that the aggregate annual output of cars in the country is well over a hundred million dollars, figures which place the automobile industry of the United States in a class by itself.

Although the twelve months ending November 1 represented a period of tremendous business depression throughout the entire country, affecting in particular all manufacturing enterprises, a comparison of the figures of the previous year showed clearly that the slightly decreased volume of good business is due to conservatism rather than a falling off in demand for cars. Furthermore, the decrease appears in total value of sales rather than quantity of cars sold; the aggregate sale of Association cars being within 500 of the total for the preceding year.

CONCERNING THE A. L. A. M. HORSEPOWER FORMULA

By G. H. GODLEY.

THE horsepower formula adopted by the Licensed Association last year met with such a favorable reception from both makers and users of automobiles that its continued use is assured. Before its appearance there had been a long-felt need for some connecting link between the size and probable capacity of various motors and the more or less imaginative ratings of their manufacturers. Between the "French rating," and the double rating, and the maximum rating, and the plain American rating, it was impossible to get a clear idea of what any motor could do, and a formula which offered an easy means of comparison was hailed with delight.

Most of the objections to the A. L. A. M. formula are based upon the idea that it is intended to determine once and for all the power which a given motor is capable of developing. Any such claim or expectation is on the face of it ridiculous. The horsepower of a gasoline motor cannot be calculated from its dimensions by any formula whatsoever, no matter how intricate and learned in appearance. As well try to calculate from a scale drawing the number of cubic inches of iron in a complicated cylinder casting, when the result could be obtained by weighing the casting itself. The way to find the actual horsepower of a motor is by brake test; but as this is hardly practicable for the average man, the next best scheme is to find some simple means of comparison based on dimensions. This is the purpose of the A. L. A. M. formula. It is essentially not a dogmatic statement, but rather a ratio. If we had two four-cylinder motors, one of 4-inch bore, the other of 5-inch, we might say that the power of the first is to the power of the second as 16 is to 25. That would be simple, but rather abstract. The A. L. A. M. formula would say that when the first develops 25.6 horsepower the second develops 40. That is almost as simple, much more intelligible, and still sufficiently accurate for every-day use.

Another cause of trouble is the rather formidable-looking decimal fraction often involved by the formula, as in the "25.6 horsepower" above. This, say the opponents, is not only cumbersome, but misleading, in that it would indicate a much higher degree of accuracy than is warranted by the facts. True enough; and most manufacturers using the formula have yielded so far as to drop the objectionable fraction altogether, or to use instead the nearest whole number. Yet it seems that the fraction has some excuse for its existence, in that it shows unmistakably that the rating is by the formula, and not the usual piece of guesswork. For this very reason the writer would even favor the addition of a cipher when the result does happen to be a whole number, as "40.0 horsepower" for "40." This, however, is unimportant, and will be decided best by usage.

After the theorists have given up the idea of absolute accuracy it is easy to see that the quality really the most desirable is simplicity. Here the A. L. A. M. formula has an unquestioned advantage. It would be impossible to simplify it any farther and still retain the least approach to a horsepower rating. There are, however, one or two short cuts which might not appear to the hurried user. For instance:

$$H.P. = \frac{D^2N}{2.5} = .4 D^2N$$

(D is the cylinder bore in inches, N the number of cylinders.) It is much easier to multiply D², N and 4 together and then mark off one decimal place than to divide by 2.5. For the metric system (D in millimeters) the formula becomes

$$H.P. = \frac{.00155 D^2N}{2.5} \text{ or simply } .00062 D^2N$$

Still further convenience may be obtained by the use of a table such as the accompanying one, especially for fractional values of the bore. The table is in the main self-explanatory, but a few features may be pointed out. The values given are so close together that intermediate values may be found by interpolation, as in trigonometric and logarithmic tables. Thus: 4 1-16 is half way between 4 and 4 1-8; and consequently the power of a four-cylinder 4 1-16-inch motor may be taken half way between the values for 4 and 4 1-8 inches, that is 26.4 horsepower. As horsepower by the formula is proportional to the square of the bore, doubling the bore multiplies the power by four, and halving it divides by four. Applying this to the table, the power of a 2-inch cylinder will be one-fourth the power of a 4-inch, or 1.6 horsepower; and the power of a four-cylinder 7-inch motor will be four times that of a 3 1-2-inch, that is, 78.4 horsepower. Again, the position of the inch and millimeter values opposite each other gives a ready means of translating millimeters into inches.

As a final criticism of the formula, and a warning against its too-confident use, it will suffice to say that it tends to overrate small motors and underrate large ones. This really makes little difference, for no one is as interested in a close comparison of a 3-inch and a 6-inch motor as he is in ones of more nearly the same size; and within the variation of an inch or so in the bores the formula is very reasonably accurate.

TABLE OF A. L. A. M. RATINGS.

BORE (Inches)	One Cyl.	Two Cyl.	Four Cyl.	Six Cyl.	BORE m.m.	One Cyl.	Two Cyl.	Four Cyl.	Six Cyl.
3	3.6	7.2	14.4	21.6	75	3.5	7.0	13.9	20.9
3 1/8	3.9	7.8	15.6	23.4	80	4.0	7.9	15.9	23.8
3 1/4	4.2	8.4	16.9	25.3	85	4.5	9.0	17.9	26.9
3 3/8	4.6	9.1	18.2	27.3	90	5.0	10.0	20.1	30.1
3 1/2	4.9	9.8	19.6	29.4	95	5.6	11.2	22.4	33.6
3 5/8	5.3	10.5	21.0	31.5	100	6.2	12.4	24.8	37.2
3 3/4	5.6	11.2	22.5	33.7	105	6.8	13.7	27.3	41.0
3 7/8	6.0	12.0	24.0	36.0	110	7.5	15.0	30.0	45.0
4	6.4	12.8	25.6	38.4	115	8.2	16.4	32.8	49.2
4 1/8	6.8	13.6	27.2	40.8	120	8.9	17.9	35.7	53.6
4 1/4	7.2	14.4	28.8	43.2	125	9.7	19.4	38.7	58.1
4 3/8	7.7	15.3	30.6	45.9	130	10.5	21.0	41.9	62.9
4 1/2	8.1	16.2	32.4	48.6	135	11.3	22.6	45.2	67.8
4 5/8	8.6	17.1	34.2	51.3	140	12.1	24.2	48.6	72.9
4 3/4	9.0	18.0	36.0	54.0	145	12.9	25.8	52.1	78.2
4 7/8	9.5	19.0	38.0	57.0	150	13.7	27.4	55.8	83.7
5	10.0	20.0	40.0	60.0					
5 1/8			42.0	63.0					
5 1/4			44.1	66.1					
5 3/8			46.2	69.3					
5 1/2			48.4	72.6					
5 5/8			50.6	75.9					
5 3/4			52.9	79.3					
5 7/8			55.2	82.8					
6			57.6	86.4					

Values are given to the nearest tenth. Interpolation is accurate between all values.

Horsepower Rating and Horse Sense.—Empirical formula will avail up to a certain point and within certain explored limits. In a motor, for illustration, the formula will work very well indeed if the bore is within the domain found to conform to the conditions which rendered the formula feasible. It is generally found that motors of a bore above six inches, and upward, render the use of the formula difficult. Bores below four inches may afford a divergence of power.

HOW ONE MAKER SUPPLIES ARTISTIC LUXURY

SOME two years ago the George N. Pierce Company established an art department whose activities were to be confined almost entirely to the interior decoration of cars and the working out of color schemes.

It was apparent that the time was coming when such a department would be necessary. When the sedan chair was first thought of as a means of transportation, the activities of the makers were concentrated first on making a chair that would be practical and comfortable.

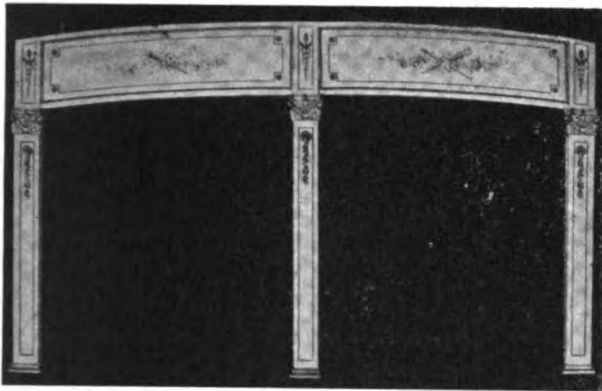

Panels of Pierce Great-Arrow Louis XVI Car.

This they accomplished, and then began the period in sedan chair history when the best artists of the time when they were in vogue were engaged to decorate them. The same was true of the great coaches that were used so generally during the latter kingly reigns in France. The

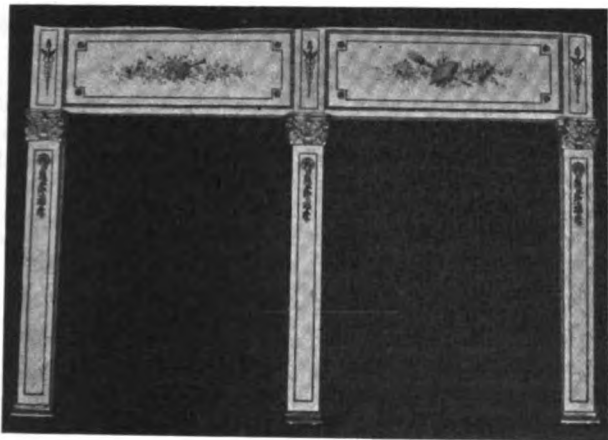

Left Side Decoration of Louis XVI Car.

first coaches were small, unwieldy and uncomfortable. Coach building progressed, however, and when the best methods of construction had been developed the taste of the users turned to their decoration. In both of these instances three epochs marked the progress of the carriages from the first rather bungled affair to the last stage. First came the utility vehicle along, and coincident with it the spread of ideas as to its users. Second came the mechanical perfection of the vehicle, and, lastly, its decoration and appeal not only to the intensely practical, but to the sense of the artistic also.

This, so far, has been the progress of the auto-

mobile. As soon as a practical machine had been made, new uses for it were found. Then came the stage when the energies of automobile men in general were centered on the mechanical perfections of the car as a whole. Comfort in the shape of bodies, the fashioning of springs and the depth and quality of upholstery has been made a study, it is true, but these matters, when compared with the possibilities of this new epoch, may also be classed as a part of the refinement of the car from a mechanical standpoint.

Last year visitors at the Garden show will remember a Pierce Arrow enclosed car, finished in Cordovan leather, hand tooled, was displayed. In view of the developments in interior decoration that will be on display at the 1909

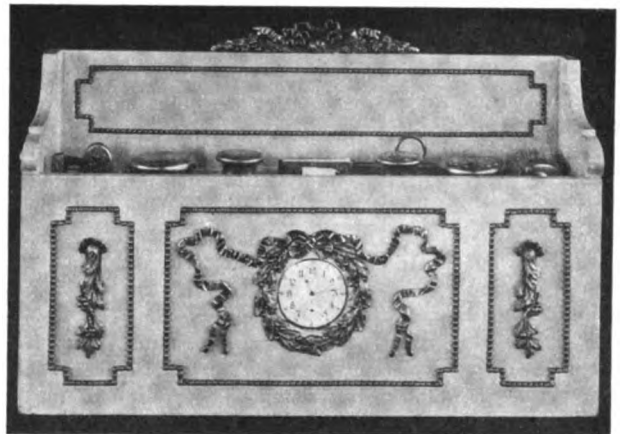

Artistic Toilet Box of Louis XVI Car.

show at the same place, it may well be judged that the designing and display of this car was meant as a test of the reception the public would give this new step in automobile construction. That the reception was one that proved satisfactory in every way is a certainty, since the

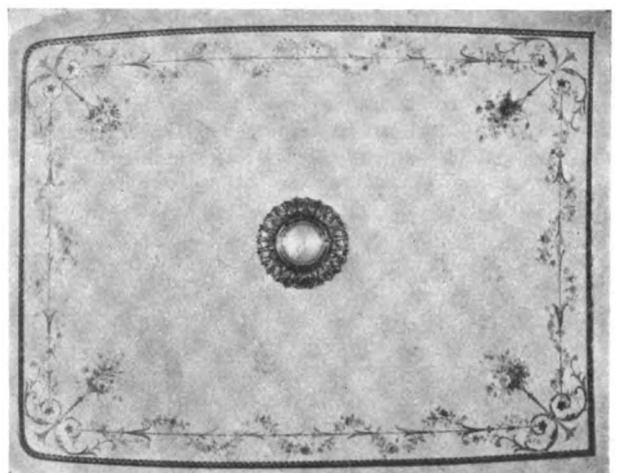

Beautiful Ceiling of the Palatial Great-Arrow.

company, this year, will show a far more pretentious product of its art department than the car of the year previous. This is nothing less than a six-cylinder 60-horsepower suburban car, the interior decoration of which is in historically correct Louis XVI style. Herewith is the description from the company:

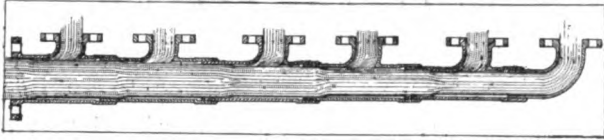

Designer Fergusson's Latest Exhaust Arrangement.

"The outside color scheme of this car is green and gold, forming a fitting encasement for the delicate interior. Satinwood, toned to a soft, golden yellow, has been used for all the exterior woodwork, including the dashboxes, steering wheel and the roof of the chauffeur's deck. The roof of this deck is said to be one of the most perfect specimens of this rare wood that has ever been found.

"Beginning with the fittings at the door, one is gradually prepared for the exquisite color plans and metal design that awaits within. The handles of the doors, the outside side lamps, the escutcheon covering the locks, and even the tiny head of the door keys are authentically Louis XVI in design and treatment. All of the metal mounts are in brass, exquisitely chased and heavily gold plated, and finished in the traditional ormolu style. From the dove-gray of the carpet the eye is led upward in a growing crescendo of color and ornament that reaches its climax in the magnificence of the ceiling, with its encircling ornament of ormolu and running design of slender acanthus entwined with garlands of flowers, all painted in the most fascinating colors on a ground of soft gray enamel. The central portion of the ceiling is enriched with an ormolu dome-lamp of the acanthus motif.

"A frieze of separate panels, each one falling just above a window form a pleasing accessory to the ceiling. The center panel of each bears a painted decoration complete in itself, yet united to its companions by the balance of mass and tone, although the motif is changed in every instance, in this manner bearing out both example and tradition of the Louis Seize period. This frieze is borne aloft by a row of slender pilasters that also serve as a separation and guide for the window frames.

"The upholstery is of a silk stripe of gray and yellow enhanced with long garlands of roses through the center of the gray stripe. It extends to the ceiling just back of the rear seat, and forms the decoration for all the lower portion of the car below the line of windows. The under portion of the front panel bears a toilet box, gracefully fashioned and containing a set of dainty toilet articles the designs of which are in keeping with those that might well have graced the boudoir of Marie Antoinette. These

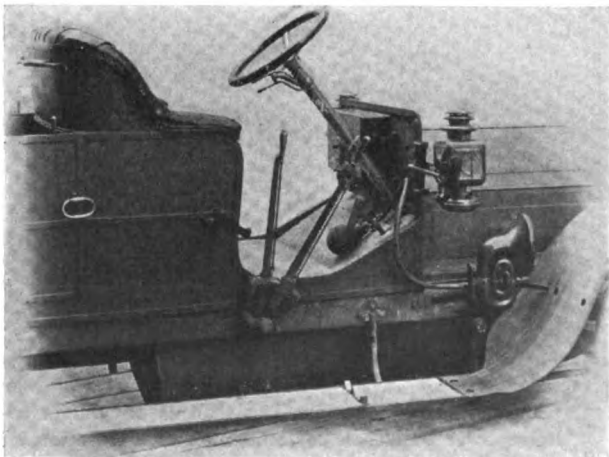

Illustrating Pierce Adoption of Side Lever Control.

also are decorated in pure Louis Seize style and add the final touch to the elaborateness of the detail which goes to make this car a logical and fitting example of the possibilities that will be developed in even the early days of this new epoch on which the automobile industry is just entering."

Owing to the fact that the space it could obtain at the Garden was necessarily restricted, another car designed by the art department of the Pierce company will be displayed at the rooms of the Harrolds Motor Car Company, in West Fifty-fourth street. This car is a striking example of the possibility of marquetry work as applied to the interior of the enclosed bodies. It is finished in Circassian walnut, with inlays of colored and stained woods. Taken together the two cars represent almost the two extremes of the possibilities of interior decorations for cars. Between them is a huge field in which the lover of things beautiful might range in his desire to suit the individual taste. In period decoration there is the widest field of all. In the possibilities of marquetry and woods it would be hard to find a limit. This is true, also, of leather. The monks of Cordova with their generations of knowledge left us the secrets of tooling and staining, while the artisans of to-day stand ready to give their Venetian velvets and brocades, full use of which has been taken advantage of in closed body work.

Two Pierce Mechanical Innovations.

Propos of the mechanical features of the Pierce, it is to note an exhaust manifold herewith illustrated which has the advantage of stability, incidental to the great main principle: the facility of scavenging the motor. This takes advantage of the vortex of an eddying spiral formation in the exhaust as it exudes from the ports and is shaped by means of the walls of the manifold, which are so designed as to set up this spiral formation in the body of the exhaust gases. It is claimed that the power of the motor is increased at least five per cent. by means of this manifold, the shape of which is responsible for the vortex rings.

A glance at the other mechanical illustration discloses the new Pierce control system, which is in full accord with the spirit of the times and takes advantage of the manner in which fine materials may now be fashioned into desirable shapes. This allows of the easy manipulation of the car. The transmission is of the selective genera, and includes four speeds, now regarded as of the greatest importance in a car of the most advanced type of construction.

A. A. A. SCHEDULE FOR SHOW WEEK.

Headquarters will be established by the American Automobile Association in Madison Square Garden during show week, its space being located in Concert Hall, near the executive offices of the show management. These are the meetings which are scheduled during the week:

Wednesday, January 20, 2:30 P. M.—Meeting of the A. A. A. Executive Committee, President William H. Hotchkiss presiding.

Thursday, January 21, 10:30 A. M.—Directors meeting New York State Automobile Association, President Oliver A. Quayle presiding.

Thursday, January 21, 2:30 P. M.—A. A. A. Touring Information Board, Chairman Powell Evans presiding.

Friday, January 22, 10:30 A. M.—A. A. A. Good Roads Board, Chairman C. Gordon Neff presiding.

Friday, January 22, 2:30 P. M.—Conference of A. A. A. Club and State Association Secretaries, National Secretary Frederick H. Elliott presiding.

Saturday, January 23, 10:30 A. M.—A. A. A. Legislative Board. Chairman Charles Thaddeus Terry presiding.

HOW THE CARS ARE LUBRICATED

SEVERAL examples of the sump or crankcase reservoir system exist in the Licensed ranks, among which can be noted Pierce, Knox, Chalmers-Detroit, Palmer & Singer, Columbia, Pope-Toledo, Stearns town car, and others. In two of these, Pierce and P. & S., splash lubrication within the crankcase is not used, the oil being fed direct to all bearing parts and no oil level maintained within the crankcase. In the other examples of sump lubrication the crankcase splash is used in conjunction with the feed to bearing parts. All agree in that the oil is circulated through the motor parts and again recirculated, being filtered once during each cycle.

In the Pierce system the leading characteristic is the oil supply being carried in the sump beneath the crankcase and the crankcase bottom sloped towards the center, so that oil falling in it is immediately drained into the sump. The gear pump driven from the camshaft elevates the oil to a large tank carried well above the cylinder heads, and from this a lead passes direct to each of the crankshaft bearings. From these bearings the oil passes through the drilled crankshaft to the lower bearings of the connecting rods, whence any overflow falls into the crankcase or is thrown into the cylinders in the form of a mist through the slot in the baffle plate, closing the lower end of the cylinder to prevent an excess of oil getting on the walls. This mist not only caresses for the cylinder walls, but also oils the wristpin bearing.

It is interesting to note that in connection with the leads from the oil tank to the bearings, that although the interior diameter of the leads are all the same, the oil does not flow through these at the full capacity of the leads, but is regulated by thimbles inserted in the upper ends of the leads where they enter the oil tank, and in each thimble is a small opening which allows only a limited amount of oil flowing. The size of the openings in the thimbles is varied in proportion to the quantity of oil needed, one bearing feeding more than another. In this system a few quarts of oil are poured into the oil tank, if the system is empty, which in tests has proven sufficient for many miles. On the small motors a wide space at the center of the piston is turned down to a slightly less diameter than the body of the piston, which prevents surplus oil reaching the combustion chamber. A paradoxical feature of the Pierce lubrication is the effort made to prevent a surplus of oil getting past the piston into the combustion chamber. First to stop it the baffle plate is used, then the broad groove in the piston and lastly the fact that a splash is not maintained, and consequently a less quantity of oil than ordinary is splashed into the cylinder.

On the Knox Motors.

On the Knox motors is a conventional sump system with the gear oil pump located outside of the sump on a vertical shaft at the right rear and driven by spiral gears from the camshaft with the timer on the top of the shaft. The pump elevates oil into a horizontal passage cored into the top part of the crankcase, and from this are oil leads to each of the three crankshaft bearings. The oil does not overflow from these into the crankcase splash, but first reaches the lower connecting rod bearings and later the wristpins

From the crankshaft bearings it is conducted to the lower connecting rods through the drilled crankshaft, which has a radial hole in the main bearing parts which registers once each revolution with the oil lead from the pump. The connecting rods have a 1-4-inch tube running the entire length to the wristpin, the bottom end of this tube registering with the hole in the crankpin, through which the oil escapes from the drilled crankshaft. No oil grooves are employed at the bottom of the piston, but a compression ring is fitted at this part of it.

An oil pressure of from two to four pounds, varying with the different models, is used, which is claimed to be sufficient to force the oil to all of the cylinder motor bearings, and the mist from the overflow of which oils the cylinders.

In conjunction with the oil pump system is an adjustable by-pass controlled by spring pressure which maintains the oil pressure at any fixed point between one and six pounds. This by-pass, as well as the leads to the connecting rods, is provided with a small screen, which guards against dirt entering, and a large, fine screen has recently been added in the crankcase base, through which the oil strains before going to the pump. The use of baffle plates in the lower ends of the cylinders prevents an excess of oil reaching the walls.

In the Chalmers-Detroits.

The Chalmers-Detroit "Forty," as well as the "Thirty," employs the sump or crankcase oiling system, the only difference between the two being that in the "Forty" the gear oil pump is driven off the lower end of the timer shaft mounted vertically at the rear end of the motor and in the "Thirty" it is driven off the rear end of the camshaft. In both models the oil is elevated from the sump or reservoir beneath the crankcase through oil leads to the crankshaft bearings, whence it overflows, maintaining a splash in the crankcase proper. In order to insure a goodly quantity of oil reaching the crankshaft bearings, pockets are provided in the case above them which are filled from the splash and from which the oil flows into and through the bearing.

Two schemes are used for oiling the lower connecting rod bearings: First, the connecting rod caps are cut away at the bottom, so that the crankshaft is exposed to oil when the caps dip into the splash; and, second, oil holes are drilled in the connecting rods at the lower ends parallel to the webs, so that the oil which is splashed against them and flows down them enters these holes and is led to the bearing. For lubricating the cylinder walls the splash is relied upon, and oil grooves on the lower ends of the pistons are used. The wristpins in the "Thirty" are lubricated from the cylinder walls, the oil on these running into the end of the hollow wristpin which is anchored to the piston. The wristpin is drilled radially to let the oil into the bearing in the connecting rod. In addition oil holes are drilled on the top of the connecting rod, which are filled from the splash. On the "Forty" the wristpin is gripped in the top of the connecting rod and has a bearing at each end in the piston boss, and to lubricate these the oil from the cylinder wall enters the hollow pin and is led by radial holes to the bearing surfaces. Baffle plates are not used

over the open ends of the cylinders. As a check on the oiling system, all of the lubricant pumped must pass in a constant stream through the sight feed on the dash, visible to the driver, and should this flow cease it is instantly detected.

The Packard system is unique because of its simplicity and individuality. In brief, it consists of two plunger pumps pumping oil by way of sight feeds on the dash to the two crankcase compartments, one to the forward compartment, the other to the rear compartment. These plunger pumps take their oil supply from a vertical cylindrical tank located on the left side of the motor in the open angle between the front and rear cylinder castings, where the oil is maintained at a uniform temperature. The two pump plungers are driven from the camshaft, and have adjustable strokes, permitting of the utmost regulation of the amount passing to each compartment, in which an independent oil level is maintained. In each compartment is a petcock for determining the oil level.

Of the many cars using a mechanical oiler with its bank of pumps, one pump for each oil lead, much diversity exists as to where the oiler should be located and where the oil leads should pass. The old method of carrying the oiler on the dash, where it was at the mercy of the weather to thicken the oil in cold days and thin it on hot days, is almost obsolete. The majority place the oiler on the exhaust side of the motor, some set it on the rear motor arms, and Haynes and Stearns continue, for the second season, their policies of incorporating it in one of the forward motor arms, where it occupies very little room. Last year the Locomobile cars carried it under the floor boards at the left, but this season it is placed under the bonnet.

The Haynes system is typical of this mechanical multi-feed oiler class. The five-feed mechanical oiler mechanism is set in a case in the right front motor arm and the left front motor arm is an additional oil well from which the oil flows through a duct cored in the crankcase to the oiler reservoir. Four oiler leads go to the cylinders and the fifth to the crankcase, the four to the cylinders delivering the oil directly against the pistons.

The mechanical oiler in the Franklin motor has separate leads to the crankcase compartments, in which are small oil pockets beneath each connecting rod, in which an oil level is maintained. The crankshaft bearings, lower connecting rod bearings and wristpin bearings, as well as the cylinder walls, are all oiled by splash. The crankshaft is not drilled, oil grooves are cut in the pistons, but baffle plates are used on the open ends of the cylinders to avoid too much oil splashing in them.

In the Peerless cars the oil reservoir is incorporated in the crankcase, at the back side. The oil is pumped from the reservoir, through four sight feeds on the dash, and thence to the four cylinders. In the four-cylinder motors the crankcase has two compartments and three in the six. In addition to this mechanical oiler, a hand pump is arranged whereby the oil can be injected direct into the crankcase compartment. The crankshafts are not drilled, but oil grooves are cut in the pistons, and by the use of hollow wristpins the oil fed to the cylinders finds its way to this pin through the piston bearings.

In the Stevens-Duryea motors the multi-feed and mechanical oiler is carried under the bonnet, and the leads run direct to the motor parts. The internal lubrication of the motor is by splash, the crankshaft not being drilled, but a compression ring is used at the bottom of the piston, whereas, the regular compression rings are located at the head of the piston above the wristpin.

In the Locomobile motors, the mechanical oiler is located under the hood, and feeds direct to the motor parts. The main bearings of the crankshaft are fed from oil

pockets filled by the splash, the ten bearings of the two camshafts are similarly oiled, and the lower connecting rod bearings get their quota of lubricant through the drilled crankshaft. Oil grooves are not cut in the piston, baffle plates are not made use of, and the wristpin is oiled through a horizontal groove cut in each cylinder near the bottom. This groove is always well filled from the splash, and when the piston reaches the bottom of the stroke, the oil in the groove enters the hollow wristpin at each end, and by the usual drilled holes reaches the bearing.

In the two-cycle Elmores the mechanical oiler forces the oil into the intake in the form of a spray, and the mixture passing through the crank chamber and thence into the combustion chamber lubricates all parts. In addition to this there is an oil lead to each of the crankshaft bearings. A compression ring is used near the bottom of the piston, and the wristpin has a cup in the forging which collects a supply of oil, which enters the bearing. There is also an accumulation of oil in the crankcase and the cap on the connecting rod, which dips into it, is provided with a scoop which gathers the oil.

In the White steam cars an oiler is located on the dashboard, which is driven by means of a ratchet from the valve mechanism on the engine. This oiler consists of two independent reservoirs, each supplied with a pump. One of them feeds into the crankcase, and the other into the steam chest. The oil entering the steam chest is carried along by the steam through the engine, being deposited not only on the walls of the two cylinders, but on the valves as well. Any excess oil is carried through into the condenser with the exhaust steam and is returned to the water tank, where it may be fluffed off when filling the tank with water. The crankshaft bearings are of the ball type, and are lubricated by the splash system, as are the crosshead pins.

The Stearns system includes a Lavigne oiler in the front motor arm, from which a separate oil pipe leads to near the base of each cylinder, whether of the four or six type. On the lower ends of the connecting rods are forged lugs which are machined out for an oil lead to force the oil to the crankpin. In addition to this is an oil hole on the top of the bearing, which is filled from splash. The wristpins are oiled solely by the splash system, there being a hole in the top of the connecting rod to collect the splashed oil and a groove along the wristpin to distribute it throughout the length of the bearing. Oil grooves are turned in the piston at the lower end and a compression ring is used near the center of the piston. The crankshafts are not drilled, and baffle plates are not used on the open ends of the cylinders.

Winton six-cylinder motors are lubricated by a double pump scheme, one pump which forces oil to all of the crankshaft bearings as well as to the crankcase compartments, and another pump which again delivers this oil back to the tank from which it was first drawn, thus permitting of the circulation and recirculation of the oil with the usual filtering between successive circuits. The main oil reservoir is located on the left side of the motor base. A double-acting plunger pump draws oil from this tank and delivers it through leads to the four bearings of the crankshaft and the three cylinder compartments. The surplus from these bearings falls into the splash, which, instead of being allowed to increase, is drained off by a collector tube to a oil well, from which it is drawn by the pump and returned to the tank. With this system the crankcase is comparatively dry, the lower connecting rod bearings are oiled by drilling the crankshaft and the cylinder walls and upper wristpins by the splash from the overflow of the connecting rods and what oil may be picked up from the crankcase.

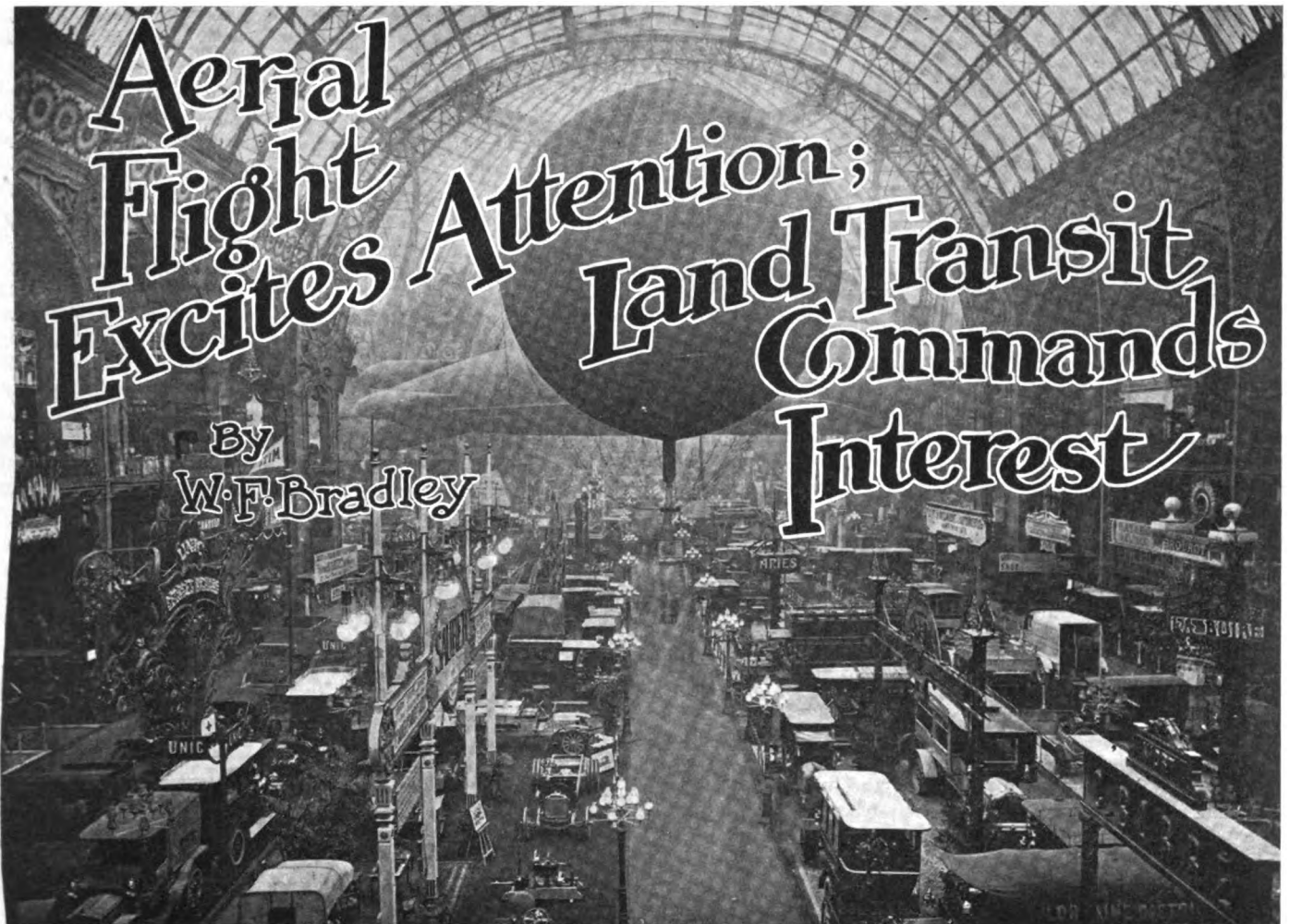

The Second Paris Salon, Wherein the Commercial Vehicles and Aeronautical Exhibits Divided Attention.

PARIS, Jan. 7.—Aeroplanes, although occupying but one-third of the Grand Palais, completely overshadowed the commercial vehicles in the second section of the Paris Salon. Talk of flying is in the air; the crowds came to see the aeroplanes, and came in such numbers that a couple of policemen were needed every day to protect the Wright machine from the mass of sightseers. Round about, where all types of utility automobiles were exposed, there was room and to spare, for trucks and taxicabs were not the subject of the hour.

Commercial vehicles have not the charm of novelty, though they are not lacking in interest to those who have taken the trouble to follow such movements. New departures are somewhat rare, and at this time of the day, indeed, it would be rather difficult to get an altogether new system on the market unless it possessed obviously superior qualities. Steam had a lesser representation than ever before, and at the show appeared to be less important than it really is, for Darracq-Serpellet and Purrey, the two most important French firms in this line, were absent from the Salon. There was one newcomer in the Johnson, a French production with British capital behind it, and another one in a steamer for the Renard Trains Company. The only other steam vehicles in the show were shown by the Chaboche Company.

A rotary air-cooled motor using

solid blocks of naphthaline as fuel was one of the few novelties at the Salon. The motor itself is not entirely new, being a Burlat which has occupied a position on the market for the last two years. The cylinders are disposed in the form of a cross, with pistons connected up to a two-throw crankshaft. For starting up it is necessary to use gasoline, and continue running on it for about ten minutes before switching over to naphthaline. During this period the exhaust gases are being led through a pipe forming a jacket round a tube passing through the naphthaline tank. At a heat of 176 degrees Fahr. the solid block of naphthaline liquefy, the liquid being led down the jacketed tube to the carbureter and treated in practically the same way as gasoline. To

carburete it, however, the liquid must be still further heated, and on this account all the intake piping is jacketed to receive the heat of the exhaust gases, naphthaline only vaporizing at 302 degrees Fahr. and boiling at about 390 degrees Fahr. When the engine has become sufficiently warmed up to vaporize the liquid, the driver switches over by merely carrying the throttle further round on the sector, one-half of which gives his full range for gasoline, and the other half for running on naphthaline. The act of opening out the naphthaline supply closes off the gasoline flow.

Lower cost of running is claimed for the naphthaline engine, the difference being said to be as great as 60 per cent. The method of converting

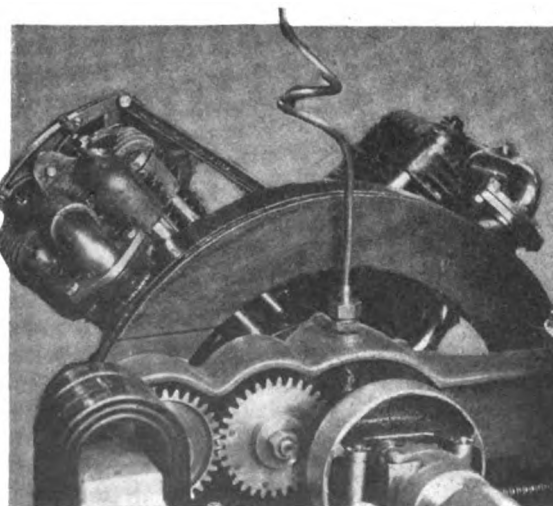

Burlat Four-Cylinder Rotary Engine.

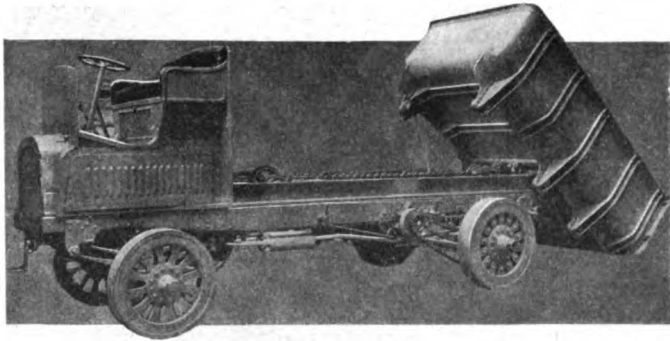

The Delahaye Type of Heavy Tip-Up Wagon.

naphthaline into a solid block is one that is kept secret by the constructors of the rotary motor. It is declared, however, that the blocks do not consist of pure naphthaline, it being possible to incorporate other hydrocarbons with it without any deposit being left. The engine and its special fuel have been produced by the Société des Camions à Moteur Rotatif, of Lyons.

An interesting feature of the truck fitted with a rotary motor was the method of suspension, all the organs, comprising engine, clutch, gearset, and countershaft, being mounted on a subframe attached above the main frame by inverted semi-elliptic springs in front and a single coil spring at the rear. The suspension of the mechanism was thus at all times independent of the main springs, whatever the load carried. Delahaye also made special provision for easy suspension of the motor and transmission on all trucks by employing two sets of springs all round, a lighter set being placed immediately above a much heavier set. When running empty the weight of the vehicle was carried entirely on the upper and lighter springs, the lower and heavier ones only being brought into operation when the vehicle was under load. Experience has shown that a five-ton truck, with sufficiently powerful springs to carry that load, is very destructive of machinery when run light at an increased speed, hence the attempt to give two sets of springs, one for light traveling and one for full load.

Distinctive Type from Switzerland.

A distinctive type of commercial vehicle was shown by the Stoller Company, of Basle, Switzerland, the motor consisting of a single cylinder horizontal with opposed pistons, connected up to the crankshaft carried below the pistons and in the horizontal plane of the vehicle. The method of connecting is by balance levers and three connecting rods. The combustion chamber is an outstanding port midway in the cylinder, with an exhaust valve in the head and an inlet valve in the base of the chamber. Engine dimensions are 7 4-5 inches diameter by 5 7-10 inches stroke for each piston, the total stroke, of course, being double this. Ignition is obtained by a low tension magneto.



Renault Bus with Michelin Twin and Triple Tires.

The two-cylinder engine being placed across the forward end of the frame, the radiator being to the rear of it, accessibility is perfect. In the forefront of the engine is a horizontal shaft carrying the cam operating mechanism, the gears for driving the lubricator and water pumps, and the governor, all laid bare by removing a single inspection plate with bayonet clasps. Further, the connecting rod ends could be got at by the removal of a plate at each end of the cylinder. From a metal to metal cone clutch the drive is taken to a six-speed gearbox, with gears always in mesh. A feature of this is that the same six forward speeds can be used for the reverse, there being a right and left crown bevel on the countershaft, forward and rear drive being given according to which bevel is slid into mesh. Final drive is taken to the rear wheels by means of side chains.

Speed being the most destructive factor in commercial vehicles, there has been a serious attempt on the part of constructors to make it impossible for drivers to travel above a certain fixed rate. Governors cutting off the gas supply when the engine has reached a determined number of revolutions were a feature of about three-quarters of the heavy vehicles in the show. On the Saurer trucks there are two engine speed limitations, a high one when the vehicle is being run on any of the low gears, and a lower one as soon as the driver slips into top direct drive. When running on the high the driver has only half the gas supply available with the engine in low gear.

Girder frames are a distinctive feature on all the heavier

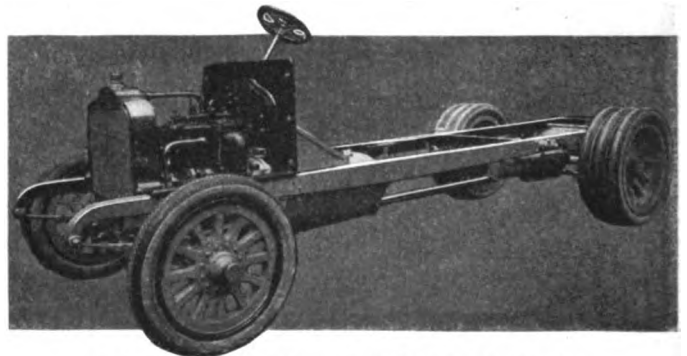

Chassis of Saurer Four-Cylinder Truck En Bloc.

trucks, this type having the advantage of lower cost compared with the pressed steel frame, and also permitting some very advantageous attachments of the different mechanical organs. There are three distinct types of final drive: by double side chains, by propeller shaft, and by transverse cardan shaft, with internal gearing, on what is generally known as the De Dion principle. Above two-ton loads the chain drive unmistakably holds premier position, experience having shown that the considerable non-suspended weight of a live axle car was not at all conducive to long service. As in the pleasure car class, there has been an abandonment of the low tension magneto for commercial vehicles in favor of the high tension magneto only; in the majority of cases no stand-by in the form of storage batteries is provided.

Two Cylinders Enough for "Taxies."

Taxicab experience is that two cylinders are sufficient, at any rate for the generally fair street conditions of European cities. There are plenty of four-cylinder cabs intended for the heavier work at railroad depots, but for the ordinary city work the only four at the Salon was one exposed by the Fiat Company, with a bore of 3.1 and a stroke of 3.9 inches. The cylinders and upper half of crankcase were produced in one casting. At every other stand the taxicabs on view had two cylinders carried under a bonnet forward, cooled by thermo-syphon circulation, and having high tension magneto for sole electric supply. Among these were Renault, Charron, Panhard, Berliet, Peugeot, Delahaye, Cottin-Desgouttes, Dietrich, and Unic. So convinced are cab companies of both London and Paris of the superiority of the two-cylinder cab that in all cases where both

models have been taken it is the two-cylinder vehicle that is being ordered in increased numbers to the neglect of the four. The principal reason for this choice is the lower fuel cost with the twin-cylinder car, and, in a smaller degree, the decreased cost of upkeep. The objection that anything short of four cylinders was not supple or silent has now been removed.

De Dion goes further and has been very successful in the introduction of single-cylinder taxicabs for London and Paris, the engine being a model with a bore and stroke of 3.9 by 5.1 inches, nominally rated at 10 horsepower. Being remarkably well balanced, there is no more vibration than on the average four, and in city traffic they are not distinguishable by traffic they are not at all noisy.

Fire Engines Are Many.

Automobile fire engines are a well-developed class, for the authorities in all large European cities have become convinced that better work can be done by the internal combustion motor than by horses. Delahaye showed two distinct types, both of which have been adopted by the City of Paris brigade, which has recently decided to abandon all horses. The smaller engine has as its power plant a four-cylinder motor of 2.9 by 4.3 inches bore and stroke, carried forward and driving to the rear wheels through a three-speed gearset and propeller shaft. This engine, known as the first aid wagon, carries with it 90 gallons of water which can be turned onto the fire immediately the vehicle comes to a standstill, and while connection is being made to the street mains. Including the driver, only five men are needed, and the engine can get away so much quicker and work its way through city streets with so much facility that frequently it extinguishes a fire before the larger outfit gets on the scene. The rule in Paris is to send out the first aid engine when a call is made and let it be followed by the large engine a few minutes later.

On the more powerful Delahaye engine a four-cylinder motor of 5.1 by 5.9 inches bore and stroke was employed, the pump being a Farcot centrifugal type with an ability to draw water from a depth of 30 feet. With 1 1-2 tons of material on board, and fifteen men, the maximum speed on the level is 31 miles an hour. Chassis features were a girder frame, with engine carried forward, four selective speeds and a safety device to prevent slipping in the pump gears accidentally, final drive by side chains. At each extremity of the countershaft, and just within the sprockets, was carried a large size brake drum fitted with radiating flanges for carrying off the heat. The brake bands were of the internal expanding type.

Fiat had a four-cylinder fire engine established to meet the requirements of the Milan brigade, the motor being a 30-40-horsepower model driving to the rear wheels through side chains, and operating the centrifugal pump by means of a single chain geared off the mainshaft. For use in large cities, where a good supply of water could be assured, an engine is constructed with two independent motors, one being used

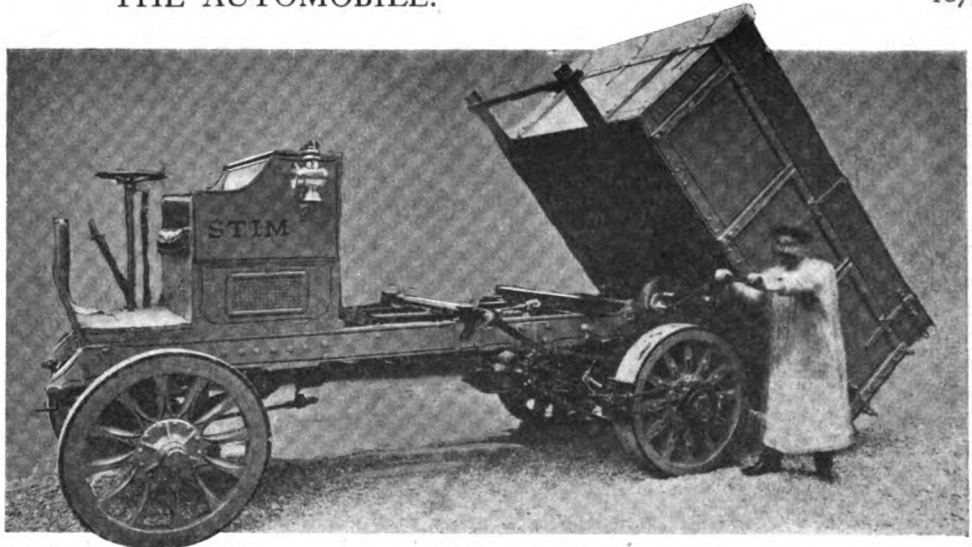

The Stilm Tip Wagon, a Powerful Type of Commercial Vehicle.

for driving the vehicle, and the second one connected up direct to the pump. Pipe, the Belgian firm, exhibited a four-cylinder engine as used in Brussels.

"Tip" Wagons Produced in Quantity.

Tip wagons, designed for use in the building trade, and for public service works, had been produced in large quantities. One of the most interesting in this class was shown by Delahaye, the metal body being mounted on small wheels running on rails, the ends of which curved downwards at the rear. By means of a low reducing gear the truck could be wheeled out to the end of the rails and necessarily tipped owing to the curve of the rail. The double reducing gear allowed one man to operate the body even when carrying its full load of five tons. The Stim Company showed a wagon of a similar type, in which the body was carried out to the extremity of the rails by means of chain and low gearing, then tipped by a separate lever with a powerful band brake, allowing the movement to be stopped at any position. Rossel showed self-tipping wagons, the body being pivoted so that the rear would always be slightly heavier than the front under load; thus on releasing a pin the load would be dropped out behind, yet the body could be raised to its primitive position by one man.

Heavy city omnibuses have always been found a difficult class

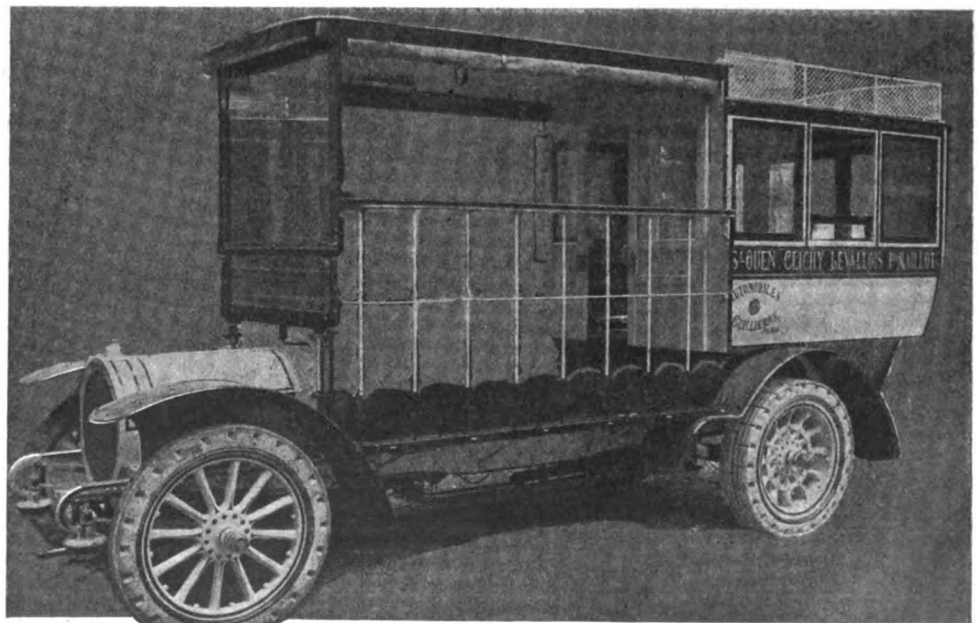

Suburban Type of Bus for Paris, with Pneumatic Shock Absorber.

to fill, the load being great, speed comparatively high, and regularity essential. Of the types suitable for service in Paris and London there were very few examples, the only one really fitted out for this work being an Aries. The Renault Freres exposed a special bus designed for the General Omnibus Company of Paris. It was one of the single deck type, only a small number of which are kept in service in Paris, and although following standard Renault design, is special construction throughout. The frame, a very deep pressed steel channel section type, is adequately strengthened by cross members and angle members at the rear. The engine, a 20-30-horsepower type, is carried forward under the usual Renault bonnet, with plain tube radiator on the dash. Clutch, gearbox and final drive by rear live axle all follow standard design, though naturally very considerably strengthened for their special work.

Instead of being at the right, the driver is placed at the left-hand side of the vehicle, his brake and change speed levers being in the centre. The exhaust carried upwards above the roof of the bus, in the usual City of Paris style, but at the base of the vertical length of piping was a by-pass, allowing the hot gases to be turned into a foot warmer running down the floor of the bus. In place of the solid block tires usually employed on the Paris buses, Michelin pneumatics were used, triples being mounted on the rear and twins on the front wheels.

Plenty of special vehicles were shown for distinctive classes of work. Thus Delahaye had a light disinfecting van employed in the Sarthe district for cases of infectious disease, the work of disinfecting linen, bedding, etc., being done at the door of the patient's house. The same firm had an automobile hearse, with a coupé body immediately behind the driver, and compartment for the coffin at the rear. Berliet showed a special meat wagon which had been used during the last army maneuvers to supply fresh meat to an entire army corps. The chassis was a standard 22-horsepower model on which changes had been made from low to high-tension ignition, and from pump to natural water circu-

lation. The body, a capacious one opening at the rear, was lined with metal, fitted with hooks for hanging meat, and supplied with a ventilator.

For carrying race horses from their stables to the course the Front Drive Latil Company showed one of their models with four-cylinder engine placed across the forward end of the frame, connecting up to the front wheels by means of universals and pinion engaging with internal gear on the road wheels. The absence of machinery at the rear made it possible to fit a low, easily entered body specially designed to accommodate two horses.

Military and city ambulances were plentiful, and although there was a considerable amount of ingenuity in fitting up the interior to the best advantage, the chasses employed in all cases were standard models. On a Gem light delivery van equipped with an engine built under Charles Y. Knight's patents, an attractive advertising scheme was shown in the form of luminous signs on the sides and rear. The body was made with double walls, between the two being electric lamps which lit up the glass signs placed in front of them. The application was easy of attachment to the Gem from the fact that although the motor ran on gasoline the drive was electric. This form of drive is on the increase, although not so much so in Paris as in London. It will be remembered that two such drives were shown at the Salon, Gem and V. A. T. E., the latter showing small cars with a single and two-cylinder engine driving a dynamo, which in turn furnished the necessary power for an electric motor.

This make of Gem was the only one to show the Knight engine, in which the similarity to the Salon was carried still further. This engine, which created such a furore in England previous to the Olympia Show, has attracted very little attention here, the French makers standing aloof from it and regarding it in a good deal the same way as the American, the man from Missouri, who said: "I am from Missouri; you have got to show me."

THE AUTOMOBILE CALENDAR

AMERICAN.

- Jan. 16-23.....New York City, Madison Square Garden, Ninth Annual National Show of the Association of Licensed Automobile Manufacturers. M. L. Downs, Secretary, 7 West 42d St., New York City.
- Jan. 19.....Adjourned Fourth Annual Meeting, Society of Automobile Engineers.
- Jan. 27-Feb. 3..Philadelphia, Second Regiment Armory, Eighth Annual Show, Philadelphia Automobile Trade Association.
- Feb. 6-13.....Chicago Coliseum and First Regiment Armory, Eighth Annual National Exhibition, National Association of Automobile Manufacturers. S. A. Miles, Manager, 7 East 42d St., New York.
- Feb. 15-20.....St. Louis, New Coliseum Building, Third Annual Show, St. Louis Automobile Manufacturers' and Dealers' Association. John J. Behan, Chairman.
- Feb. 15-20.....Detroit, Wayne Pavillon, Annual Show, Detroit Automobile Dealers' Association. E. LeRoy Pelletier, Manager.
- Feb. 15-20.....Cleveland, First Regiment Armory, Annual Show, Cleveland Automobile Dealers' Company.
- Feb. 15-20.....Bangor, Me., Auditorium, Eastern Maine Automobile Show.
- Feb. 16-18.....Denver, Colo., Auditorium, First Annual Automobile Show, Denver Motor Club.
- Feb. 18-25.....Toronto, St. Lawrence Arena, Third Annual National Automobile, Motor Boat and Sportsmen's Exhibition. Ontario Motor League. R. M. Jaffray, Manager.
- Feb. 20-27.....Newark, N. J., Essex Troop Armory, Roseville Avenue. Second Annual Show New Jersey Automobile Trade Association. H. A. Bonnell, Manager.
- Feb. 20-27.....Hartford, Conn., Second Annual Show, Hartford Automobile Dealers' Association.
- Feb. 24-27.....Omaha, Fourth Annual Automobile Show, Omaha Automobile Show Association. C. N. Powell, Sec'y.

- Mar. 1-6.....Buffalo, Convention Hall, Annual Show, Automobile Club of Buffalo. D. H. Lewis, Secretary.
- Mar. 6-13.....Boston, Mechanics Building, Seventh Annual Automobile Show, Boston Automobile Dealers' Association. C. I. Campbell, Manager, 5 Park Square.
- Mar. 8-13.....Kansas City, Kansas City Automobile Dealers' Association Show.
- Mar. 13-20.....Minneapolis, Minn., Annual Show, Minneapolis Automobile Show Association, F. E. Murphy, Sec'y.
- Mar. 27-Apr. 3..Pittsburg, Duquesne Garden, Automobile Show. Pittsburg Automobile Dealers' Association.

Races, Hill-Climbs, Etc.

- Feb. 20-22.....New Orleans, Fair Grounds Track, Mardi Gras Race Meet, New Orleans Automobile Club. Henry George, Secretary.
- March 5-12....Palm Beach, Fla., Lake Worth, Fifth Annual Regatta. Palm Beach Power Boat Association.

FOREIGN.

Shows.

- Jan. 16-25.....Belgium, Brussels Automobile Exhibition.

Races, Hill-Climbs, Etc.

- May 2.....Sicily, Targa Florio, Automobile Club of Italy.
- May 26.....Russia, Moscow—St. Petersburg Race.
- June 10-18.....Germany, Prince Henry Cup Competition.
- June 14-19.....Scotland, Scottish Reliability Trials.
- July 1-3.....France, Angers Course, Grand Prix, Automobile Club of France.
- July 13-17.....Belgium, Ostend Automobile Race Week.
- Sept. 5.....France, Mont Ventoux Hill Climb.
- Sept. 11-19.....Italy, Bologne, Florio Cup Race, Automobile Club Bologne.

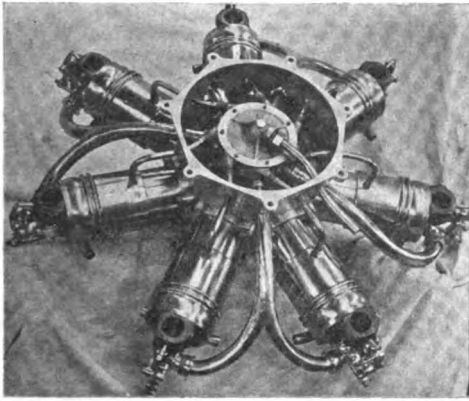

Copper Water Jackets and Pump.

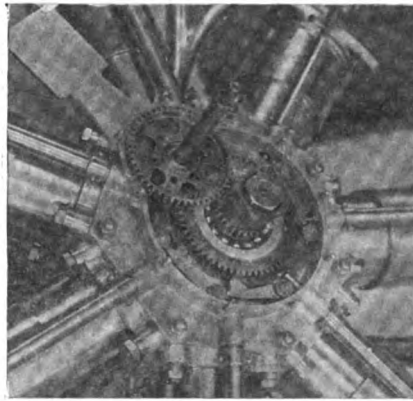

Gears and Valve Mechanism.

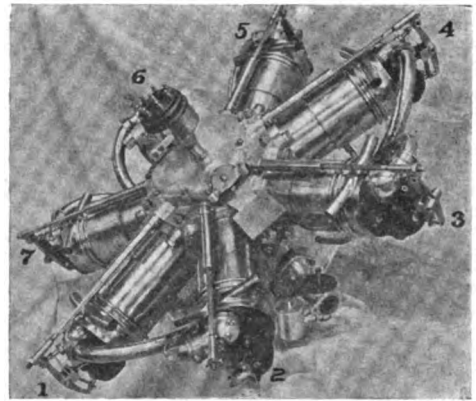

Timer and Exhaust Tappet Rods.

Bayard-Clement 50-Horsepower Seven-Cylinder Water-Cooled Rotating Engine.

WHAT THE AERONAUTICAL SECTION UNCOVERED

PARIS, Jan. 7.—Nine years ago, when commencing the construction of a man-carrying aeroplane on the lines of a large model which had made successful flights over the Potomac River, Professor Langley appealed to American engineers for a gasoline motor of light weight and low power. One firm undertook the task, but failed so lamentably that a visit had to be made to Europe in the hope of obtaining what was required from the leading automobile constructors. The American specification called for an engine of 12-horsepower weighing not more than 100 pounds complete with cooling water and all accessories. European constructors were asked to produce an engine not exceeding 10 pounds in weight per brake horsepower without fuel or water. They declared the task impossible, and in view of the inability to obtain an engine from established firms, construction was begun at the Smithsonian Institution. The result was a gasoline engine of 52 brake-horsepower, weighing approximately one kilogram per horsepower. European aeronauts met with the same difficulties. After being obliged to design a special steamer for the first flying machine the world ever knew, the Levavasseur compelled to defer his experiments with wings until he had produced an engine light enough.

Wonderful progress has been made since Professor Langley and his engineer visited Europe, there being at least half a dozen firms having engines of less than 10 pounds per horsepower, capable of running with as much regularity as the best of the motors fitted to road vehicles. Most of the work in this direction has been done during the past two years, or indeed during the past twelve months. The year 1908 having proved that the aeroplane is inevitably a means of transport for the near future, scores of constructors have devoted their efforts

to the production of a motor suitable for use in the air. It is undoubtedly a wise policy, for already there are a sufficient number of aeroplanes under construction to make the building of light weight motors profitable, and the firm to first get a really successful engine on the market is certain of a handsome reward.

At the aeronautical exhibition there were almost a dozen different makes of aero engines, some of which have been on the market for a couple of years or more, while the majority were entirely newcomers. Roughly, the engines which were presented may be divided into two classes: Eight-cylinder "V" engines, either air or water-cooled, and seven-cylinder engines with pistons of all the cylinders connected up to a one-throw crankshaft. In the former class are Renault, Antoinette, Pipe, and E. N. V., while in the latter should be placed Esnault-Pelterie, the first builder of a successful seven-cylinder aero motor, with Gnome and Bayard-Clement as newcomers.

There is no very startling departure in design in any of the eight-cylinder engines. They are invariably built in "V," with two connecting rods linked up to each throw of the crankshaft, and a single camshaft for the entire set of sixteen valves. There is undoubtedly a decrease in weight with an engine built on these lines, for the flywheel can be cut down to a minimum or dispensed with altogether, the crankshaft need be no heavier than for a four-cylinder engine, and there is a saving of one camshaft. To get down to one kilogramme per horsepower, however with a "V" engine of this type is a science of metals, and in more than one case the paring has been carried out to such an extent that reliability of running has faded away.

The Antoinette engine has been too often described to need

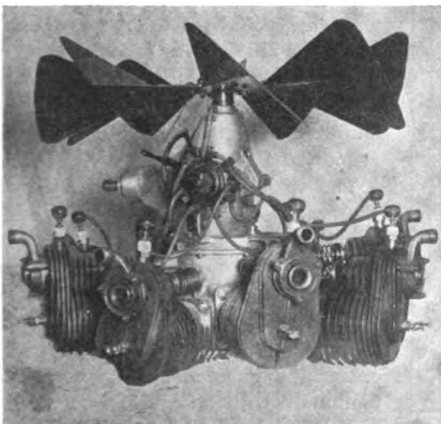

Farcot Operates Horizontally.

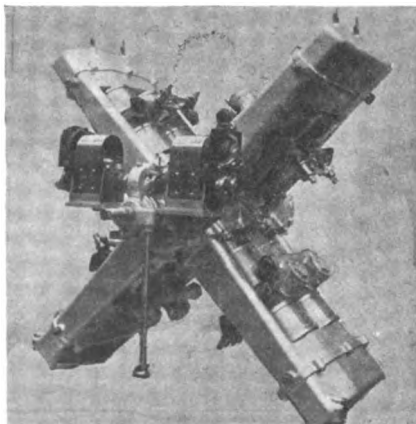

Cross-Shaped Gobron.

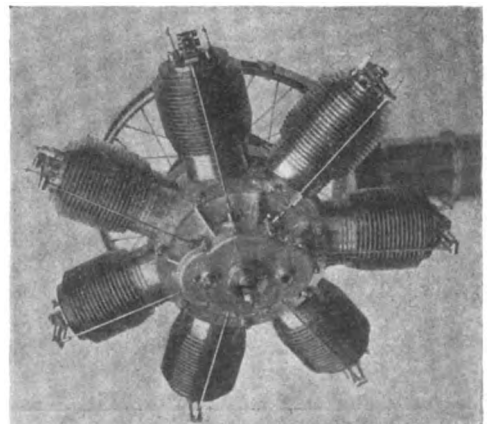

The Rotating Gnome.

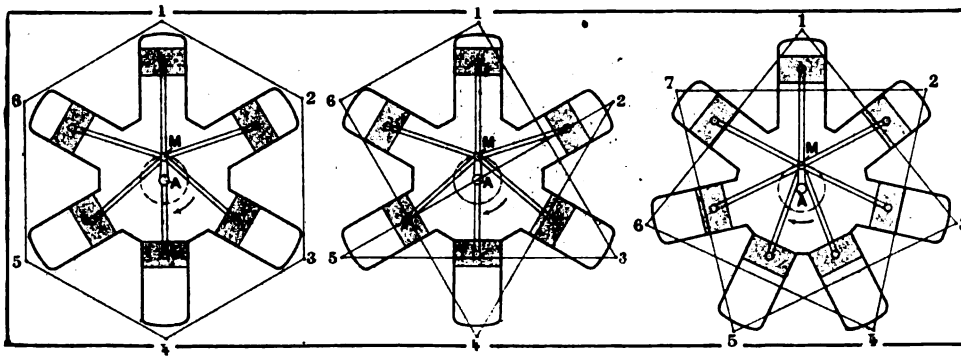

Fig. 1—Consecutive Firing Impossible. Fig. 2—Alternation also Impossible. Fig. 3—Correct Regular Spacing.
Order of Firing Six and Seven-Cylinder Rotating Motors.

repetition. Its successful use by Farman and Delagrangé has shown that it can be relied upon, though now that long flights are the order of the day these aeronauts do not put their preference on the specially lightweight model guaranteed not to exceed one kilogramme per horsepower.

Since first produced, the Renault aero engine has undergone several minor changes which have tended toward its greater efficiency. Instead of two fans, one at the front and the other at the rear of the engine, there is now but one, placed on the forward end of the mainshaft, drawing in a current and discharging it at each side of the engine, after passing over all the cylinders.

Pipe Has Ball-Bearing Crankshaft.

An eight-cylinder "V" engine has just been produced by the Pipe Company, of Brussels, the distinctive features of which are a ball-bearing crankshaft; an aluminum casing round each set of cylinders, the forced draught being aspirated at the base of the cylinders—the casings are bell-bottomed for this purpose—and discharged at the rear; a combined inlet and exhaust valve, and the use of hemispheric combustion chambers.

The valves are placed in the head of each cylinder, each valve being operated by two tappets, one operating the inlet and the other the exhaust. The principle is that of a double concentric valve, full details of which are being withheld until all patents are secured. The carbureter, of the ordinary car type, is carried between the two sets of cylinders, with a very neat arrangement of intake piping in the form of a double cross. The engine has a bore and stroke of 3.9 inches, and is declared to develop 70 horsepower, the total weight being 285 pounds.

An electrically deposited copper jacket is the feature which stands out on the E. N. V. eight-cylinder engine, another newcomer to the aeronautical world. Here the cylinders are placed

in the usual "V" form, the pistons being connected upon a four-throw, three-bearing crankshaft, there, of course, being two connecting rods to each pin. The cylinders are cast, turned inside and out to as fine a degree as possible, then receive their water jackets by a patented method of copper deposit. The claim made for the system is a perfect union of the copper jacket with the cylinder casting, the joints being absolutely non-expanding. Another feature of the engine is a longitudinal sliding of the camshaft, in order to vary the timing at the will of the driver. A force-feed circulation, by means of a pump driven off the camshaft, is somewhat distinctive of the engine, but in all other respects standard lines are followed.

Gobron Engine Is Not "Standard."

There is little that is standard about the eight-cylinder, sixteen-piston Gobron aeronautical engine which has just been pro-

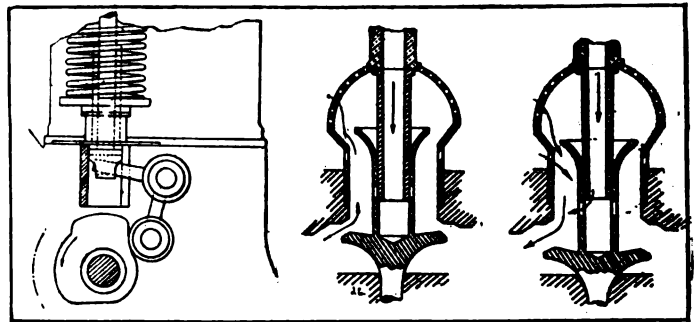

Cam Mechanism. Exhaust. Inlet.
Details of Farcot Combination Valves.

duced. As will be seen from the illustration, the cylinders form an X, and have such an unfamiliar appearance that the newcomer will be puzzled to distinguish between the heads and the base. To understand the motor it should be borne in mind that all Gobron engines have two pistons per cylinder, the heads of which approach one another on the compression stroke and leave one another on the power stroke, the combustion chamber being spaced between the two piston heads. The upper piston is connected to an overhead beam, which in both the car and the aviation motor is common to the pair of cylinders. A long connecting rod links up the overhead beam with the crankshaft, there being, of course, but two of these long connecting rods for a pair of cylinders. The design gives all the advantages of a long-stroke engine without the disadvantage of high lineal speed. The superiority is proved by the fact that for two years Europe refused to admit this type of motor in races against cars with an equal bore.

The designer of the new Gobron has really built a double "V" engine; or, to describe it in other words, two cylinders are mounted vertically on the crankcase; two more are mounted on the under face of the crank-chamber, forming a twin double-opposed engine, and two more are mounted to the left and right of these and at right angles to them, forming either a Maltese

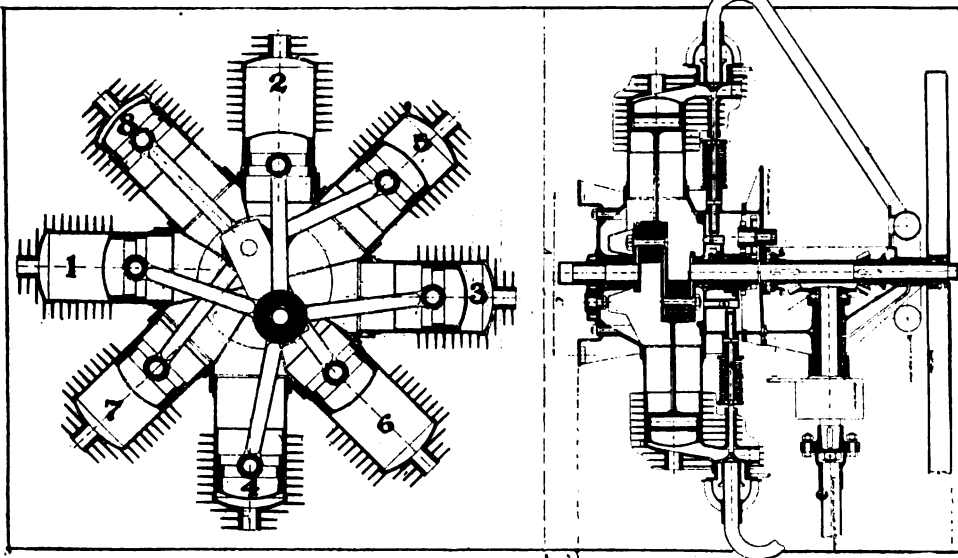

Crank Arrangement. Cross Section.
Air-Cooled Farcot Eight-Cylinder in Detail.

+ or a double "V" according to the way in which the engine is regarded. The sixteen connecting rods are all linked up to a two-throw crankshaft, practically identical with that of the ordinary two-cylinder Gobron. Thus, there is, to begin with, a saving in the weight of the main shaft and an even greater saving in the weight of the crankcase.

The cylinders have a bore of 3 1/2 inches and a total stroke of 6.2 inches, the lower pistons of each set having a slightly longer stroke than the upper ones. The normal engine speed is 1,200 revolutions a minute, at which speed the motor develops 80 horsepower. There is something original in the valve arrangement, the inlets being automatic and placed midway in the combustion chamber, and the exhaust being mechanically operated without the use of any gearing. The inlet is at one side of the cylinder and the exhaust opposite it, the exhausts in one pair of cylinders being operated by a single oscillating beam obtaining its movement from an eccentric working off the crankshaft. The cylinders are a very fine grade of casting and are fitted with copper water jackets. Though nothing has been pared down to a fine degree in the desire to save metal, some very low weights have been obtained. Thus, a complete piston, with its connecting rod and fittings, weighs 11 pounds; the total weight of the

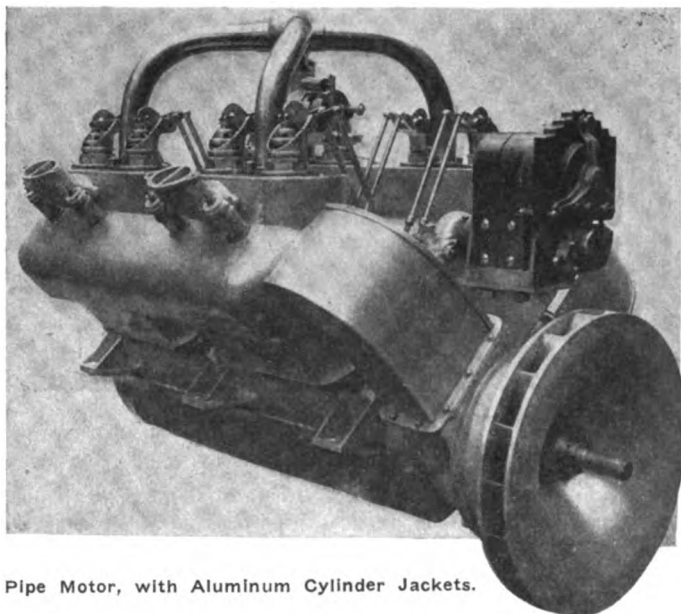

Pipe Motor, with Aluminum Cylinder Jackets.

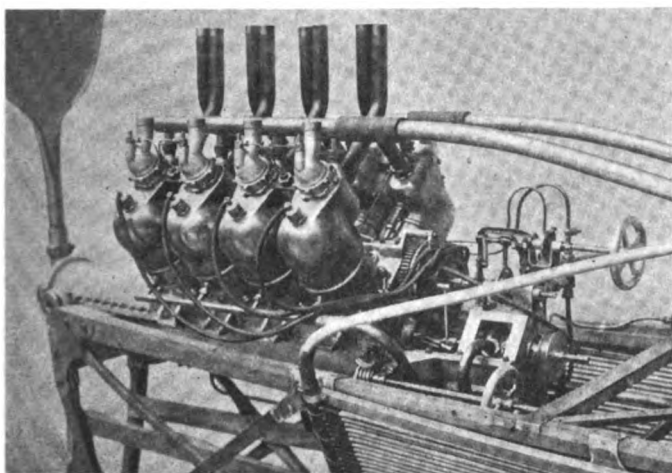

50-Horsepower Antoinette Aeronautical Motor.

crankshaft is 16 pounds. The total weight of the engine, complete with magnetos, carbureter and water, will not exceed 400 pounds, and when properly tuned up will develop 90 horsepower, which is 4 4/10 pounds per horsepower.

Two magnetos are carried on the Gobron, each one being mounted on a platform to the left and right of the crankshaft. It would have been possible to use a single magneto, as is usually done on eight-cylinder engines, but it was preferred to have two in order to have a slower speed of rotation, and in order to give greater security. Each magneto feeds four cylinders in one plane; thus, if one magneto were cut out or broke down, the other would drive the engine as a four-cylinder double opposed. This would give a certain amount of security for aeroplaning, for it would allow the apparatus to be brought back to earth on four cylinders in case of ignition trouble. The magnetos are driven by gearing off the rear extension of the crankshaft, the same gearing being employed for operating the lubricator pump, these two being the entire gears on the engine.

There is less difficulty about the lubrication than might appear at first sight. The oil naturally flows to the heads of the two sets of cylinders, carried head downward, and a pump is employed to carry it up again to the heads of the cylinders that are uppermost, and to the level of the main bearing. An ordinary type of carbureter is employed, without any special branching of the intake piping to reach the four sets of cylinders. It is merely a single length of piping passing successively to each intake. Although the distance that the gas has to travel obviously increases with the length of the piping, it is declared that there is no starving of the cylinders farthest removed from the car-

bureter. A centrifugal pump, with a capacity of 3-5 of a gallon a minute, takes care of the cooling of the engine.

Horizontal Cylinders on Farcot.

One other French aeronautical motor has been produced in which the pistons are connected up to a two-throw crankshaft, without, however, having any other similarity with the Gobron. On the Farcot engine the cylinders are horizontal, and are placed at equal distances around a circular crankcase; they are slightly staggered in order to allow of connecting up to the two pins of the crankshaft set at an angle of 180 deg. to each other. Bore and stroke of the engines is 4 by 4.7 inches, the engine speed being 1,200 revolutions a minute, and the horsepower 50. Cylinders are cast with radiating flanges and receive a current of air from a horizontal fan mounted on the vertical shaft of the engine. A peculiarity of the order of the firing is that the explosions take place first on all four cylinders attached to one pin, then on the four on the opposite pin.

Though carried in outstanding ports, and operated from below, the valves do not follow standard practice, for each one performs the function of an inlet and exhaust, according to whether it is raised by the smaller or the larger of the two cams for each valve. The exhaust is muffled by a perforated cage around each valve, the passing of flame being prevented by the

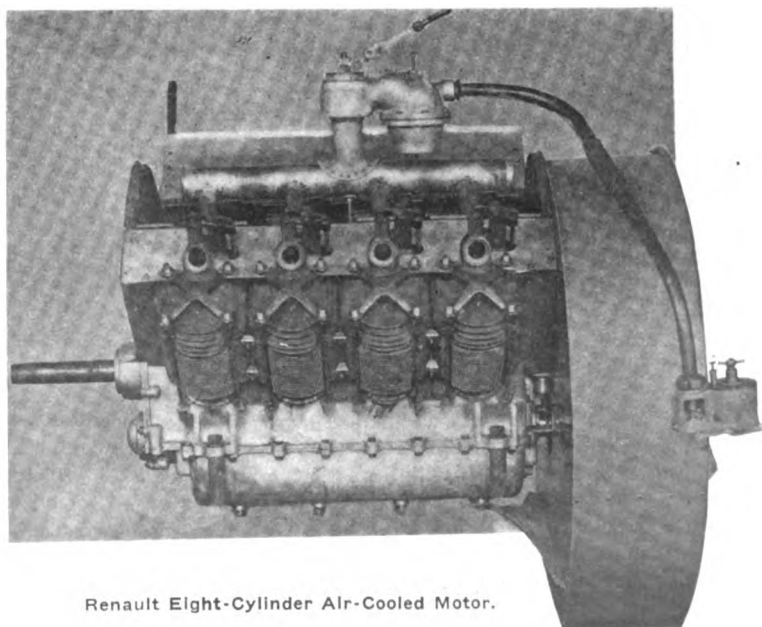

Renault Eight-Cylinder Air-Cooled Motor.



The Ader Aeroplane that Resembles a Bat.

use of a fine wire gauze screen. Except for use on a helicoptere it is necessary to employ bevel gear to transmit the power from the vertical shaft to the vertical propellers. The gearing is housed within the crankchamber and advantage is taken of its presence to obtain a reduction in the drive.

Clement Also Has an Aeroplane.

Adolphe Clement, the chief proprietor of the Bayard-Clement factory, and one of the most important constructors in France, has already shown his interest in aerial navigation by the construction of a large dirigible balloon equipped with a powerful racing engine, and now about to be supplied with a huge six-cylinder engine developing 200 horsepower. The same factory has also been studying the aeroplane question for the past twelve months and has just produced both an aeroplane of original design and a special lightweight engine of a very interesting nature. It was estimated that 50 horsepower was required for the ordinary type of aeroplane, and it was this power that M. Clerget, one of the company's engineers, sought to obtain with the lowest possible weight. A seven-cylinder engine was decided upon, all cylinders being connected up to the same pin of the crankshaft, the cylinders were to be water cooled, for it was believed that the slight extra weight of cooling water and pump, etc., would be more than regained by increased efficiency, the main shaft to be vertical, with a bevel gear giving a reduction to the horizontal shaft on which the propeller was mounted.

It is only with a large number of cylinders, six or more, that a sufficiently even torque can be obtained to allow of the abolition of the heavy flywheel. Further, it is only by placing the cylinders around a circular crankcase that it is possible to connect them all up to one point and reduce the length of the crankshaft to the minimum necessary for a single throw. But it is not sufficient to multiply the cylinders, putting six, eight, twelve, etc., in one crankcase, for even this will not always give equally spaced explosions. In the diagram are shown two six-cylinder circular engines, in the first of which the explosions take place in the order 1, 2, 3, 4, 5, 6. At first sight it appears to be an ideal arrangement, for while cylinder 1 is firing, cylinder 2 has completed its compression, cylinder 3 has begun its upward stroke, and cylinder 4 has just begun to discharge the spent gases of the previous explosion. But a second revolution of the crankshaft shows that the arrangement is impossible, for when the cylinders come round to the firing point again each one is empty.

Another arrangement suggests itself: firing the cylinders in pairs, the odd cylinders first and the even numbers afterward. As will be seen from the lines uniting the cylinders in Fig. 2, this would give 1, 3, 5, with equally spaced explosions, then an interval before 2 could take up the firing, followed by 4 and 6 equally spaced, and a quick jump to cylinder 1 again. In either case it would be necessary to use a heavy flywheel to overcome the inertia caused by every second revolution being performed without an explosion, or to overcome the unequal spacing when firing on alternate cylinders.

The only solution is an odd number of cylinders, preferably

seven, fired alternately in the order 1, 3, 5, 7, 2, 4, 6, when, as will be seen from the lines on Fig. 3, the explosions are always equidistant, thus giving an evenness of running which makes it possible to dispense with a flywheel. The magneto or storage battery supplying the current is naturally called upon to furnish 31-2 sparks per revolution, or seven per two revolutions, of the crankshaft. It is this arrangement which has been adopted on the Bayard-Clement, as well as on the Gnome and Esnault-Pelterie, the only other seven-cylinder engines which have proved a success.

Steel cylinders are employed on the Bayard-Clement, the cylinder walls being 2 1-2 millimeters in thickness and tested to a pressure of 132 pounds per square centimeter, in the hydraulic press, without any deformation taking place. The bore is 3.9 inches and stroke 4.4 The cylinder heads, which are dome-shaped to give a hemispheric combustion chamber, are screwed into the cylinder, then brazed. Valves are in the head, the exhaust housing being integral with the head, the valve being fitted through the port for the inlet before this latter is placed in position. The spark plug is placed between the two valves. Copper jackets, brought up as high as possible to allow of cooling the valves, surround each cylinder.

It had been intended at first to use a pressed steel piston in conjunction with a steel cylinder; but, although no defects were revealed after several months on the testing block, it was feared that a slight inattention or failure of the lubricating system might cause the engine to seize, and the rather heavier cast piston was substituted. Cylinders are attached to the base in the usual manner by bolts and nuts, but the method of connecting the rods is quite distinctive. It is impossible to link up all the connecting rods direct to one pin of the crankshaft, and thus there is provided one main connecting rod attached to the pin, and two auxiliary rods attached to the bearing of the main one; two other pistons have secondary connecting rods, each one of which receives an auxiliary, thus making seven in all.

The crankshaft is in two parts, mounted together, and is carried on ball bearings. No flywheel is used, but within the crankcase are very carefully adjusted balance weights to equalize the mass of material attached to the single pin of the crankshaft. Very great pains have been taken to obtain a perfect balance, two months having been spent by the testing department on this portion of the engine only.

All valve-operating mechanism and timing gears are mounted in the upper portion of the crankcase. The single cam, bearing eight raised surfaces, four of them being for the inlet and four for the exhaust, revolves around the crankshaft, in the same direction as it, but eight times slower. Also on the crankshaft extension is mounted the pinion which drives the vertical spindle carrying the commutator. Within the face of the commutator pinion is a bevel gear driving by means of a short horizontal shaft the high-tension magneto, mounted on a platform cast with the crankcase. In the illustration the commutator spindle and gearing are shown, but the bevel gears for the magneto are not in position.

In the base of the crankshaft is the centrifugal pump, also mounted direct on the crankshaft. A peculiarity of this is the use of seven outlets each one of which is connected up by a short length of rubber hose with the water intake of one of the cylinders. The carbureter, a delicate looking little instrument made entirely of aluminum and weighing complete with float chamber and all fittings, just a fraction over one pound, is carried at the base, but on the outside of the crankchamber. Though having more the appearance of a motorcycle than a high-powered engine carbureter, this one has been tested on standard 50-horsepower cars with excellent results before being fitted to the aero engine. Within the crankcase is a gas receiver from which each cylinder takes its supply of explosive mixture. There are four inlet pipes, three of them supplying a pair of cylinders and one linked up direct to a single cylinder.

With the cylinders carried horizontally lubrication resolves itself into the simple task of supplying a regular flow of fresh oil entering the upper portion of the crankcase. In order to find

its own level it necessarily flows over all the main bearings, and from the crankcase lubricates the cylinder walls and wrist pins by splash. There is no reason to fear an excess of lubricating oil, for the exhaust valves being flush with the cylinder walls, and at the lowest point of the cylinder, any excess which may work itself up to the combustion chamber is swept out unburned. During the six months that the engine has been running on the testing block it has been found that every satisfaction could be obtained from drip-feed lubrication.

The motor illustrated is intended for a special type of aeroplane, and is somewhat distinctive in its reducing gear. Ordinarily, however, the transmission is by means of a bevel pinion mounted on the upper extremity of the engine shaft and attacking a horizontal shaft which is machined out of the solid with its bevel gear. Two-thirds reduction is obtained; and it is worth noting that while all French aeronauts were mounting their propellers direct to the mainshaft, the Clement engineers had decided on a reduction which Wright has since shown to be a valuable factor in the driving of aeroplanes.

Gnome and Clement Engines Similar.

In the number of cylinders, their arrangement around a circular crankcase, the method of attachment to a one-throw ball-bearing crankshaft, and the order of firing, there is a similarity between the Bayard-Clement and the Gnome engine. Instead of the explosion driving down the piston, which in turn causes the crankshaft to revolve, on the Gnome engine the shaft is fixed with the result that it is the cylinders which are obliged to revolve around the shaft.

The entire engine is constructed of the highest grade chrome nickel steel, even the cylinders, with their radiating fins, being machined out of a solid bar of steel. Both front and rear faces of the crankcase are separate, being bolted to the deep ring forming the crankcase proper. Instead of being bolted to their base, each cylinder is forced into the crankcase and held there by a split ring fitting into a groove on the portion of the cylinder passing within the case. The engine has a bore of 110 millimeters and stroke of 120 millimeters, hemispheric combustion chambers with valves in the heads, high compression, and delivers 50 horsepower at a speed of 1,200 revolutions a minute.

Pistons are cast, in order to avoid the use of steel against steel, and although all are connected up to the single-throw crankshaft, there is only one main connecting rod. This is machined out of a solid bar of steel, its lower end being a complete broad face ring bored through at intervals around its face to receive the six other connecting rods, which are attached to the main one by gudgeon pins in much the same way as they are secured to the pistons. Each face of the big bearing is deeply recessed to receive a ball bearing, the connecting rod itself not fitting directly onto the crankpin.

The exhaust valve, as already explained, is in the head and is operated by overhead balanced mechanism. The inlets are automatic and are carried in the piston head, the supply of gas being obtained from an ordinary carbureter, carried in any position, with the intake pipe passing along the hollow crankshaft to the interior of the crankchamber. All valve-operating mechanism and timing gears are contained within the forward end of the crankcase; a collar with an external gear is keyed to the crankcase and drives a sleeve free to revolve on the crankshaft. The ring cams are fitted onto this sleeve, being attached by means of a keyway. The cylinders all being in one plane, it has been necessary to slightly stagger the valve guides and tappets in order that they may be opposite their respective valves mounted one behind the other on a single sleeve.

Double Ignition Is Provided.

Double ignition is provided by storage batteries and high-tension magneto, both plugs being carried in the cylinder head. Lubricating oil arrives to the engine by means of a pipe passing through the hollow crankshaft, the distribution of the oil to all bearings being assured by centrifugal force. Without any excessive paring down of shafts, gears and other material it has

been possible to reduce the weight of the engine to 165 pounds complete with carbureter and magneto. Long tests on the block have shown also that the engine can be relied on to maintain the 50 horsepower at which it is nominally rated.

Sixteen Actual Performers Exhibited.

Altogether there were sixteen full-sized aeroplanes exhibited, nearly all of which are machines which have flown or are duplicates of successful machines. In addition to these were a mass of models, doubtless not less than fifty in number, comprising all types of heavier-than-air machines. The point that was necessarily forced upon the visitor was that the aeroplane has already created an industry. The majority of those brought to the show were drawn with the idea of seeing a flying machine and expected to see something freakish that was distinctly in the experimental stage. Instead, they found at least six firms prepared to build machines that will fly, and willing to take payment only when a flight has been made. It is true that at present there are more flying machines than aerial pilots, for there must be at least, in the neighborhood of Paris, three hundred machines fully built or under construction, while those who can fly with them at ease might be counted on the fingers of one hand. Before the second aeronautical show is held, however, all this will be changed.

A number of special motors were shown for aerial work only, the most important of the series being Renault eight-cylinder, air-cooled, Pipe eight-cylinder, air-cooled, E.N.V. and Gordon eight-cylinder, water-cooled, Farcot eight-cylinder, horizontal air-cooled, Rep air-cooled, five and seven-cylinder engines, Antoinette eight and sixteen-cylinder, water-cooled engines, Buchet six-cylinder, air-cooled, and Bayard-Clement seven-cylinder, water-cooled horizontal engine.

I. A. A. CALLS FOR LARGE PRIZE FUND.

LONDON, Jan. 12.—At the meeting of the International Association of Aeronauts here to-day a resolution was presented by President Jacobs, of the Aero Club of Belgium, to the effect that the association should offer prizes to the amount of \$240,000 for aeroplanes and dirigible balloons. This amount is to be divided into a number of prizes, providing for a \$10,000 gold cup as a special prize for flying machines, and ten prizes of \$20,000 each, half of which shall be for dirigible balloons and half for flying machines, besides a \$10,000 cup in each department. It is proposed that these ten prizes shall be competed for in ten separate competitions, one to be held every five years. To raise this fund, it is suggested that the United States, Great Britain, Germany and France each contribute \$40,000, and Belgium, Spain, Italy and Austria \$20,000 each. Of the total, the sum of \$20,000 is to be devoted to the construction of portable sheds to house the competing machines.

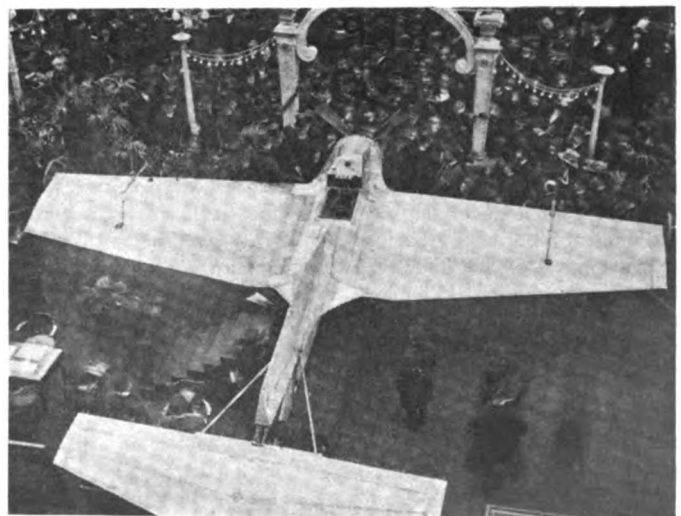

President Faillères Examining Pelterle Aeroplane.

HOW WILBUR WRIGHT WON THE MICHELIN PRIZE

L E MANS, France, Jan. 1.—The Michelin prize is won, and when Wilbur and Orville Wright sail for America next March they will have in their possession the work of art donated by the French tire king and \$4,000 in cash from the same source. It was on the last day of the year that the attempt was made and a new world's flying record put up with 2 hours 18 minutes 33 3-5 seconds, official distance covered 77 miles 760 yards; actual distance about 95 miles.

Early on the morning of December 31 the machine was brought out of its wooden shed to the now dreary plain with its background of fir trees hidden under a thick layer of snow. It was cold, but not so cold as two days before, when Wright had tried to put up a new record and had to give in after 1 hour 52 minutes 40 seconds in the biting air. Some changes had been made to fit the machine for its aerial voyage; an additional gasoline tank had been added; the supply of oil had been increased; the two propeller shafts had been united by a transverse chain in order to keep both propellers running if one of the driving chains broke; finally the machine had been carefully examined to see that all was in good order.

At 11 o'clock a start was made, but after 45 minutes in the air it was discovered that the cock of the new gasoline tank was leaking badly, and a return had to be made to earth. An adjournment was made for lunch. In the meantime, Minister of Public Works Barthou, who had traveled down specially from Paris, arrived on the scene and closely examined the homely-looking but wonderful flyer.

Beginning of the Record-Breaking Flight.

Exactly at 2 o'clock the machine was on its rail again; Wilbur Wright, closely enveloped to protect him against the cold, was on the outside seat, the catch was released, the aeroplane jumped ahead, and in a fraction of a second was in the air making for the triangular course marked out according to the rules of the Michelin competition. The triangle was one having two sides measuring 1,093.6 yards and the third side of 218.7 yards, giving a total distance round of 2,405.9 yards. Each of the angles was marked by a flag, and at each turning point a committeeman was stationed to see that the machine kept fully to the outside.

In a second the white bird had reached the first flagpole, and with that peculiar sliding motion that is one of its characteristics, had slipped round with a considerable heel, and was again on an even keel. A straight run of over one thousand yards, then another sharp turn, another straightaway of the same length, then a turn and the short leg of the triangle was entered upon. The aeroplane, indeed, had hardly straightened out before it was in the turn again. All of them were taken with admirable skill, the machine naturally losing ground at each turn, but nevertheless swinging round in a manner that no other aeronaut has been able to imitate.

After a quarter of an hour it became monotonous, for these triangles in the air were performed with so much regularity that one ceased to wonder, and it needed an effort to recall that this man was doing with the utmost naturalness what centuries had dreamed of but never dared to hope for. Half an hour passed, an hour, an hour and a half, and still there was the rattle of the exhaust up aloft and the steady gliding movement of the aeroplane. One hundred kilometers were covered, and the time was noted: 1 hour 52 minutes 15 seconds. Two hours passed and the light began to grow dim, but still he flew on.

"Sunset!" Concluded the Great Triumph.

"Sunset," yelled the timekeeper at 19 minutes past four. Still the artificial bird flew on. But not for long; a few hundred yards more and the engine was stopped, the machine settled down to the earth, and the Michelin prize was won. Fifty-six rounds of the triangle had been made, which at the rate of 2,405.9 yards per round, gave a distance of 76 1-2 miles. To this had to

be added 1,203 yards covered after the last passage of the counting point, and the initial 437 yards from the end of the starting rail to the commencement of the triangle, making a total of 77 miles, 760 yards. Making a reasonable allowance for the space lost in three turns per round, and an actual distance of about 95 miles is obtained—the longest flight ever made by any aerial machine of the heavier-than-air type.

Minister of Public Works Barthou rushed forward, and was the first to congratulate the American aeronaut on his splendid performance and the winning of the greatest prize of the year. But there was other work to be done, and hurriedly the apparatus was mounted on the rails, the weights hoisted, the Frenchman invited to take a seat beside the pilot, and they were off in the semi-darkness. The preparations had been too hurried, however, for no sooner had the end of the rail been reached than the big apparatus dropped to the ground. Again it was mounted, again the weights were hoisted, an extra one being added to give a quicker start, and at 5.20 P. M., in complete darkness, the aeroplane and its two passengers rushed off into space. There were a score of automobiles on the edge of the ground, all with their headlights lit, and it was under their glare that the last flight of the old year was made. It only lasted four minutes, but it was evidently enough for the Minister, for on descending he felicitated the American pilot more heartily than before.

"It is superhuman how you can remain on the machine for over two hours. I was only up for four minutes and already I am almost frozen. And what a sense of security there is; absolute security."

"Yes," replied Wilbur Wright. "You are safer on my aeroplane than on your railroads."

The health and continued success of the aeronaut were drunk at a gathering at the Aero Club immediately after the afternoon's performance. Minister Barthou was elected an honorary member of the Aero Club of the Sarthe, and, all over, the officials took the train for Paris, while Wilbur Wright made his way to the plain wooden shed on the wild plane, and slept on the rafters with his invention and companion below him.

Both Henry Farman and Moore Brabazon had entered for the Michelin prize on the last day of the year, but neither was able to do anything worth recording. Farman, on the plains near Chalons, flew 1,000 to 1,500 yards on several occasions during the afternoon, but his motor was not properly tuned up and was unable to run steadily for more than a few minutes at a time. Moore Brabazon, on the same ground, endeavored to get into the air, but without success. Finally the attempt was brought to an end by the explosion of the gasoline tank.

Conditions Will Be More Severe for 1909.

In a few days the conditions will be announced for the 1909 Michelin prize, the regulations for which must be drawn up by the Aero Club of France. The conditions for the first year were that the distance should not be less than 20 kilometers, and that the test should be made round a closed circuit in order to facilitate the control. With almost 100 miles having been covered the first year, it looks as if the regulations would have to be entirely modified for the next cup. Although Wright stopped after about two and a half hours aloft, he could have continued for five hours if he had wished to fly until using the last drop of fuel.

The Paris to Clermont-Ferrand trip, which a year ago appeared a chimera, is now thoroughly practical. Had Wright started in a straight line from Paris instead of turning over a drill ground, his record distance would have taken him to Chalons, where his rival Henry Farman was vainly endeavoring to get into the air. Had he gone south, he would have covered half the distance to Clermont-Ferrand. It would not be at all extraordinary, therefore, if next year an attempt were to be made to win the \$20,000 for uniting Paris with the Auvergne city 230 miles away.

FOR AMERICAN MAKERS SEEKING FOREIGN MARKETS

By RENE PETARD.

THE present writing has for object to take avail of the activity created by the "show period" to point out the possibilities of the export business to American manufacturers and to review a few considerations to be kept in mind in its creation.

Although America, generally speaking, is one of the world's foremost exporters, its position as an exporter of automobiles is far from being in keeping with its rank of largest producer of these. Complete figures for the year just passed are not yet available; it, however, is easy to surmise that, except as regards trade with other American nations, the 1908 figures will not show over the preceding ones an advance commensurate with the magnitude of the industry. At the close of 1907 the capital invested in the automobile trade was given by the Department of Commerce and Labor as \$188,400.00. This investment only resulted in exports outside the American continent amounting to \$3,415,459. The enormous discrepancy between these two figures emphasizes the need for action on the part of American makers if they want eventually to avail themselves of all the benefits to be accrued from a prosperous foreign trade.

A few firms which could be counted on less than the fingers of one hand have recognized the inconvenience of this situation. Their efforts, however, were not always equally successful, due in part to lack of sufficient knowledge of the requirements of the markets to be exploited or to the absence of a proper organization. It should also be remembered that the production of such a large country as the United States necessarily is of the most varied order, and that among all the vehicles made it is impossible for every one to be equally suited to the requirements of every market in the world.

The value of the export business is obvious. Besides being a direct source of profits, it is an insurance against over-production, and if properly handled supplies an almost unlimited market (not a dumping ground) for the output which in dull times may exceed the home demand. At any rate, by increasing the quantity of product turned out it cheapens production, a point by no means small in these days of keen competition.

Many makers apparently consider that the remarkably prosperous outlook for 1909 in home sales precludes the necessity of outside efforts for the time being. If it is looked back to the bicycle days, which taught so many lessons to the export trade, it will be at once impressively seen that prosperous days essentially are those during which an outlet must be prepared for the days when the home demand will decrease. Foreign markets will only be ready in dull times in proportion to the work previously expended on them, and the early comers will get the lion's share.

In most centers the situation is highly favorable to the American maker, who, with the trend of improvement, has learned how to produce satisfactory vehicles at a lower price than the foreigner. Nevertheless, a handicap has been created in certain countries by the shipment of machines which, through some defect in workmanship or material, would have been unfit for the home trade. In fact, there now are makes on the American market which have been so widely and so unfavorably advertised abroad in this respect that any amount of expense to reintroduce them would be a dead loss. It is by making it a point to only send out goods rather better than what they supplied to home consumption that English merchants have held their leading rank in the general international trade of the world, and their policy should be universally followed as the only one productive of good results.

To offset the prejudice caused in certain quarters, the American maker will have to supply his product through an active organization prepared to do the missionary work required to restore confidence. Once this result obtained, and it will be easy for a really good machine. The amount of business which will be possible can hardly be realized by one not posted on the buying.

The need for a special organization is further increased by the fact that sales in most markets cannot be made direct from America. The flow of automobile buying goes to Europe and mostly to Paris, which accounts for the recent installation of distributing branches in that city by several prominent English and German houses.

One of the great mistakes of American makers in all lines of export has been the useless mailing of never-read printed matter in the English language. If printed matter is at all sent it should always be written in a language commonly understood in the countries where it is sent; French or German will generally better cover continental Europe than would English. In preparing these catalogues close adherence to the American text is not desirable; account has to be taken of the people's habits and ideas, and, often, claims which will very forcibly appeal to the American public will have an entirely opposite effect on the foreign. One instance came to the writer's notice lately in France. The catalogue of a new and remarkable American car was being shown to parties in the trade and independent; in all cases was most favorable comment attracted by the machine, but in all cases also was a part of the catalogue most useful to the American buyer condemned; it was a relation of the foreign machines embodying the same features of design as the machine considered. This was an example of a thing perfect for America, working to an entirely opposed end in another country. Writing a proper catalogue for export can only be done by a man having had actual experience in the lands for which it is intended.

Better than printed matter are traveling salesmen. Sending them from America would be prohibitive, on account of cost, but from a foreign branch they could be sent at a much less expense, both as to salary and traveling cost. The importance of proper representatives in far-away countries is still greater than in the home trade, and incompetent men were often the source of considerable loss in both money and opportunities.

In replying to foreign inquiries, the American maker often boasts of enormous factory outputs. It is right to say that these are in most cases justified, but, however great may the opinion of foreigners be of the activity of this country, they generally lack a basis of comparison to actually realize it, with the result that the inquirer thinks that he is imposed upon, or else, not being educated to the possibilities of quantity production, he concludes that the product made in such large quantities can only be poorly made and badly conditioned. The writer often confronted very deeply rooted opinions to that effect.

In some cases the opportunities for a good trade have been utterly spoiled by the pretensions of some exclusive agent abnormally swelling the prices to increase his profit. This is especially frequent in the Orient. It, then, is well for the manufacturer to provide a fair limit in the selling price, and if necessary to advertise it to a certain extent.

The amount of loyalism to one make which proper treatment can develop in certain buyers is remarkable, and this is very cleverly exploited by German manufacturers, from whom it generally is very difficult to take a customer. This could be turned to advantage by the American manufacturer if he came first to take possession of a trade, distancing his less enterprising competitors.

One feature which greatly hurt the American bicycle export trade was that of the spare parts. If a successful and lasting automobile trade is to be built up it will be necessary to establish at least one depot in the central selling branch. This will be found of considerable assistance in sales.

Advertising in foreign magazines and trade papers outside of the English is of very little use, for, although it is very cheap, it is still too expensive, the Anglo-Saxon being the only European who reads advertisements.

BAY STATE'S GOVERNOR ON ROADS AND AUTO LAWS

BOSTON, Jan. 11.—In his inaugural address Governor Draper devotes much attention to the question of improved State highways and the regulation of automobile traffic. The Governor cites the maintenance of the roads as a serious problem and says that last year it cost \$295,000. Referring to the use of the State roads by automobiles, Governor Draper says:

"I believe that their number will increase, and, while this may be a good thing in many directions, they certainly make it much harder to keep the roads in condition, and therefore the annual amount to be expended for keeping the roads good must be materially increased. The Highway Commission estimates that it will require at least \$300 per mile per year to maintain the State highways in proper repair. There can be no doubt of the wisdom of maintaining in good condition the splendid property which we have, rather than increasing our mileage rapidly by borrowing money for new construction and allowing the roads to run down because of insufficient expenditures."

Discussing automobile traffic, the Governor says:

"It seems to me obvious that a change ought to be made in the registration fee for automobiles, and that a graded fee should be established, by means of which the people using machines which destroy the roads would be compelled to pay to the commonwealth a proper amount for repairs. I therefore believe and urge that legislation should be enacted which would

require the owners of high-powered, heavy and fast running automobiles to pay a greater license fee than is charged to citizens owning lighter and less destructive motor vehicles. Such laws have been enacted in other States, and, in my opinion, are practical and comparatively easy of application. I think, further, that the money raised from such registration fees should be used for the maintenance of State roads."

The Governor favors the construction of State roads so as to connect with the main roads of adjoining States, forming trunk lines. He says that the laws should be amended so as better to regulate the conditions under which automobiles are run, the object to be attained being the prevention of reckless operation. "Speed limits," he says, "may have their advantages, but they oftentimes work a hardship on careful operators. The laws should be so framed that any reckless operation of a motor vehicle, at any speed, should be the test for fine or other punishment, as the case may be. The object to be attained is to frame laws which will prevent reckless and dangerous operation of such vehicles. Where any particular person is convicted, the penalty should be severe; and if glaring cases of recklessness are found, the guilty operator should be prohibited from further opportunity for such action. I would further suggest that some law might be passed which would make it a criminal offense to use an automobile without the owner's permission."

CONNECTICUT'S LAW NOT OUT OF DANGER

HARTFORD, CONN., Jan. 11.—Now that the Connecticut Legislature is about ready to get down to business, autoists in the State are anxiously watching out to see what is going to happen to the present law. One bright lawyer, a member of the Legislature, is credited with being the author of a fool measure to limit the power capability of all gas cars.

The Connecticut Automobile Association and the Automobile Club of Hartford will always be represented at the Capitol, not so much as a precautionary measure, but rather that desirable assistance be rendered. It is the consensus of opinion among the legal talent that the present law is adequate, but it should be more strictly enforced. A fixed speed limit is unde-

sirable for many reasons, and to express the matter as set forth by a well-known member of the bar: "A fixed speed limit invites the best of us to violate the law upon opportunity."

Unfortunately, during the past six months there have been several fatal accidents, two of which have happened in this city. For each offense the guilty parties were and are now serving sentence. It is the opinion of one faction that once the adequacy of the present law is made tangible to the Legislature, that its perpetuation will no longer be a matter of question. There are at least a good many supporters of the present law in the Legislature, and of the State officials there is no more hearty supporter than Highway Commissioner MacDonald.

MARYLAND MAY HAVE NEW LAW AND BETTER ROADS

BALTIMORE, Jan. 11.—A bill drafted by Col. Sherlock Swann, of the State Automobile Commission, has been approved by that commission and will be introduced in the next Legislature. The bill will revolutionize the status and standing of automobiles in this State, and will give Maryland, so the commission thinks, one of the best auto laws in the country. The bill is made up of the best features of the laws of twenty other States and also contains many of Col. Swann's ideas. The bill as approved by the commission provides for the annual license of automobiles according to horsepower. At present a license tax of \$3 is paid by the owner of an automobile, and that license is good as long as the automobile lasts.

The new law will provide for an annual tax of from \$6 to \$24, according to the horsepower of the car. These licenses will have to be renewed this year. The bill further provides for the appointment of a special State official to take charge of the automobile law and its execution. A liberal speed limit is to be allowed, and is to be arranged according to cities, towns, suburbs and upon crowded thoroughfares. Streets or roads are divided into three sections—cities, thickly settled and sparsely settled.

Speed will be regulated for each of these sections. Heavy penalties are provided for violations of the speed limit. In addition to fines and imprisonment, the licenses may be revoked. The idea is to turn the revenues from the annual licenses, with all automobile fines, over to the Good Roads Commission, and will be expended in repairing and constructing good roads.

Governor Crothers says that these licenses and fines will produce for the State a revenue of from \$75,000 to \$100,000 annually, and that in ten years this revenue will reach \$400,000, basing this calculation upon the rapid rate at which autos are increasing.

Governor Crothers has announced that he favors a second bond issue of \$6,000,000 for improved roads in this State, with \$2,000,000 of the amount to be used in improving the streets of Baltimore. The Governor figures that this loan, as well as the \$5,000,000 granted by the last General Assembly, will not cost the people a cent more of direct taxes. He figures that the proposed increase in automobile taxes and other taxes special taxes will pay for the interest on these bonds.

The Automobile Club of Maryland, through President H. M. Rowe, has announced that it favors the new bill.

AUTOMOBILE ENGINEERS TO HAVE SESSION DURING SHOW

ALTHOUGH a surprisingly large number of the engineers of firms who will only exhibit at Madison Square Garden attended the first session of the fourth annual meeting of the Society of Automobile Engineers, which was held at the Automobile Club of America last Tuesday, the plan of the meeting as originally determined upon last October was to hold a one-day session during the course of each of the shows in New York. The second session will accordingly be held Tuesday, January 19, or on the third day of the show at the Garden. As was the case at the opening session, members will convene at the Automobile Club of America at 10 A. M., where a series of tests of the club's recording dynamometer will be run off by Henry Souther, a member of the society and the chairman of the technical committee of the club. After explaining the workings of the apparatus and the various recording instruments, Mr. Souther will try to run a regular series of tests on the dynamometer, following which the members will adjourn for a discussion of the records thus made. Luncheon will be served at the Automobile Club.

The members will then adjourn to the Engineering Societies Building, in West Thirty-ninth street, near Fifth Avenue, where the technical sessions will be held during the afternoon, convening promptly at 2 P. M. The papers to be read are: "The Economics of Weight Reduction," by F. D. Howe; "An Improved Type of Compression Coupling," by W. S. Noyes; "Standardizing Motor Bearings," by S. P. Wetherill, Jr.; "Some Practical Considerations in Autogenous Welding," by Henry Cave, the author giving a demonstration of the various operations of welding and cutting by means of the oxyacetylene flame, in connection with the presentation of his paper, and "An Indicator with Continuously Rotating Drum," by S. W. Rushmore and H. L. Towle. A general discussion of the points brought out by the author will take place after the reading of each one of the papers.

As autogenous welding, which has already been developed to a considerable extent abroad, is destined to occupy a very important place in automobile construction in the future, and has already made itself invaluable for general automobile repair work, the demonstration to be given by Mr. Cave will be of unusual interest.

Mr. Howe's paper on the "Economics of Weight Reduction" embodies a suggestion that comes as a matter of interest to automobile user and manufacturer alike, and not in the lesser

degree to the former by any means. The time has come when the average owner of a car has become tired of transporting useless weight, which simply means that he is burning that much more fuel and oil and wearing out tires that much faster because he has to carry it, and he is going to show the manufacturer sooner or later that it will pay to reduce weights even further than the use of costly materials has already brought them. The improved type of coupling referred to in the paper by W. S. Noyes is known as the Imperial compression coupling, and while it forms a very small part of the construction of an automobile, relatively speaking, the importance of having a coupling that cannot only be depended upon to hold, but that can be taken down readily, is frequently paramount.

The expense of manufacturing the motor would be greatly reduced and the cost of bearing replacements likewise brought down, where the user is concerned, if the practice of using a standard type of bearing for this essential of the car were to be adopted, as advocated by S. P. Wetherill, Jr., in his paper. Motor dimensions have already reached a point where they may be said to closely approach standards in many respects, and in none more than in that of bearings, the differences frequently being very small indeed. One of the most interesting papers to be presented at the meeting is that by S. W. Rushmore and H. L. Towle, on "An Indicator with a Continuously Rotating Drum." The usual method of testing engines has never been entirely satisfactory where the automobile motor was concerned, and while the manograph has represented an important step in this direction, still it is not all that can be desired. Some means of learning what is going on in the motor while it is actually in service on the car, and not merely mounted on a block under test conditions, has always been wanted. Mr. Rushmore has invented an indicator for this purpose, and a large number of its records are shown in connection with the paper, some of them having been taken at speeds ranging from 40 to 50 miles an hour.

Following the reading of the papers and the subsequent discussion, the members will adjourn to the Engineers' Club in West Fortieth street, where the annual dinner of the society is to be held. Visiting automobile engineers who are not members of the society are invited to attend the session. They will be welcomed, and it is hoped they will find the session of interest.

PENNSYLVANIA'S TRANS-STATE HIGHWAY HOPES ARE HIGH

PHILADELPHIA, Jan. 11.—Automobilists here are delighted over the strong indorsement of the trans-State highway given by Governor Stuart in his message to the Legislature at its convening last week. After showing that the Highway Department, since its creation in 1903, had completed 542 miles of roads, with 223 miles under contract—and incidentally strongly disapproving of the present piecemeal system through which "much of the money expended by the State for road improvement will be wasted"—the Governor urged the necessity of a "State system of main highways connecting the several county seats; the county should construct roads connecting important points in the country, and the township system of byroads, leading to the main ones, should be constructed by the township, or by the township and county jointly."

As a beginning of such a system as he outlines, the Governor recommends "the building and maintenance, entirely by the State, of a road to extend from the seaboard to the Ohio valley, between the cities of Philadelphia and Pittsburg, via Harrisburg, the capital. This highway should be in the interest of the greatest number. The route is sufficiently precise as to location to be a decisive and fair plan. The line may be subject to local changes, without avoiding the cardinal objective points. Thus populous centers will be traversed, and important cities and

county seats will be connected, representing a county population of more than 50 per cent. of the entire population of the commonwealth. No other line for a main road can be found which would reach so large a proportion of the State's population, or which would serve so many useful purposes. I recommend that the determination of the exact route be placed in the hands of the Highway Commissioner, Attorney-General and Governor."

The advocates of the Juniata Valley route are taking much comfort from the Governor's inclusion of Harrisburg, the State capital, as one of the "cardinal objective points" on the route. If the capital is included it will be much easier, they claim, to continue on through Juniata Valley, via Mifflintown, Lewistown, Huntingdon and Tyrone to Altoona, than to make a long detour to the southwest in order to reach the old post road at Gettysburg or Chambersburg. They also point out that that portion of the Governor's screed which says that "important cities and county-seats will be connected, representing a county population of more than 50 per cent. of the entire population of the commonwealth" cannot possibly refer to the southern route, for not only are there fewer county-seat towns on that route, but the towns, with but few exceptions, are smaller. Besides, by including Harrisburg as one of the "cardinal objective points," the route to the capital via Reading can be selected.

LETTERS INTERESTING AND INSTRUCTIVE

CONSIDERING DIFFERENT BEARINGS.

Editor THE AUTOMOBILE:

[1701.]—I notice that on some of the "big cars" the hubs of the road wheels are quite small, and with some of the runabout types the reverse is true. Does not this indicate a lack of uniformity, or, worse, is it not a fact that some of the cars are without adequate bearings in the road wheels?

HARMONY.

New York City.

It is well to observe, it is even better to think, but is best to think twice. The weight of a car does not serve as the sole criterion in determining as to the proper sizes of bearings to use in the wheel hubs. The weight of a car does serve to fix upon the static responsibility. In a kinetic sense the question is one involving the speed of the car, on the one hand, and the ability of the tires, on the other. For a given speed, the car with the largest pneumatic tires is the car that will allow of the use of the smallest bearings, in point of actual ability. Considering the same (given) speed, it is even permissible to use smaller bearings on a big car, so called (if large tires are used) than might be used on a runabout, with smaller sized tires. It is the shock that is to be feared, and it is the large tires that abort shock. By large tires is meant tires large in proportion to the load. Then there is the relative value of the several types of bearings to be considered. For a given rating, all the bearings do not occupy the same amount of space. This in itself will make a difference in the external appearance. Finally, there is no better illustration of the point to be made than to repeat the statements of Henry Hess in relation to the effect of different tires on the sizes of bearings to use, referring specifically to "H-B" bearings. The relations were put as follows:

- (a) With pneumatic tires..... 100
- (b) With solid tires..... 75
- (c) With steel tires..... 60

In other words, it is to say the ball bearings that would do for a case involving pneumatic tires, under suitably regulated conditions, would be 25 per cent. below the requirements with solid rubber tires and 40 per cent. short in the cases in which steel tires are considered. In this statement no account is taken of what would be the case were it possible to maintain the same speed with the several tires. As a matter of fact, the speed would be lower for the solid tires than would be the allowable speed with the pneumatic tires, and, again, the speed with the steel tires would be still lower.

NOTHING THAT SHOULD GO IN AN AUTOMOBILE.

Editor THE AUTOMOBILE:

[1702.]—Please decide a dispute in your "Letters Interesting and Instructive" regarding a brake system, which I have designed, by stating whether or not the 4-inch levers of the equalizer are to be considered as intermediaries and therefore do not either increase or decrease the pull of 96 pounds from each wheel on the 6-inch bellcrank lever. Also kindly state the pressure on the in-pounds required on the foot pedal.

MISSOURI.

The pull of 90 pounds exerted on the brakerod and transmitted to the equalizer bar will still be 90 pounds, if it is true that two 4-inch levers are placed 180 degrees apart on the shaft. There would be no difference in time or pressure at the end of two levers so placed. No amount of pressure on the foot pedal would give you any result at all, because the mechanical motions do not seem to be true. The lever on the pedal shaft will rotate away from the bellcrank on the second shaft, and you do not show a means of taking care of the difference.

Your drawing does not express your idea clear as it should be expressed, in order to have it understood by others, and it is possible that you do not contemplate the use of a lever system such as this. At all events, it does seem as if the scheme is half baked and far too crude to be discussed as a brake system in work of the character involving automobiles.

TWISTING MOMENT IN LIVE REAR AXLES.

Editor THE AUTOMOBILE:

[1703.]—Every time I take off the hub cap of my car I am impressed with the smallness of the "jack-shaft," if such it may be called, and the largeness of the load. Instead of worrying about it for a year and a day, it is my purpose to have you tell me if the present practice is safe; if, in fine, a 1 1/4-inch shaft is suitable for the purpose. My car weighs about 3,000 pounds, will do about 45 miles per hour, and I would think about 60 per cent. of the load is on the rear axle. The wheels are fitted with 36-inch tires. Of the material in the jackshaft, I know little or nothing; the power, on the whole, it is very satisfactory, and this should indicate the use of fair material in the shaft.

P. B. P.

Ogdensburg, N. Y.

Let,

d = diameter of the shaft in inches;

R = radius of the road wheel in inches;

f = coefficient of friction between tire and roadbed;

w = weight in pounds on one wheel;

S = allowable extreme fiber strain in the material;

when,

$$d = \left\{ \frac{R f w}{S} \right\}^{\frac{1}{3}}$$

For the case in point it is to say,

$$d = \left\{ \frac{18 \times 0.60 \times 900}{16,000} \right\}^{\frac{1}{3}}$$

= 7-8 inch, nearly; taking the next above fraction of convenience.

This is on a basis of 16,000 pounds per square inch of fiber strain, which is not excessive, considering good steel. As will be seen, then, the shaft is not too small, from the torsional point of view.

You failed to give information in relation to the bending moments. In other words, if the shaft overhangs the bearings the result will be by way of bending moments that will have to be taken into account ere it will be possible to say to what extent a factor of safety resides in the shaft in question. It is not uncommon to find an overhang of 2 inches, and on this basis it will be possible to ascertain what the effect will be; proceeding as follows,

Twisting moment in inch pounds = 18 × 0.60 × 900 = 9,720;

Bending moment in inch pounds = 2 × 900 = 1,800;

combining,

$$1,800 + (1,800^2 + 9,700^2)^{\frac{1}{2}} = 11,666, \text{ nearly;}$$

and,
$$D = \left\{ \frac{11,666}{16,000} \right\}^{\frac{1}{3}}$$

= 15-16 inch, approximately; taking the next up 1-16 inch as a desirable figure;

in which,

D = the diameter of the required shaft, on a basis of bending and torsional moments combined.

The required size of the shaft is still less than the size actually used in the car. The reason for this lies in the fact that "keying" reduces the strength of the shaft and, as a result, must be taken into account. Since the depth of the key is no more than the difference, it is reasonable to assume that the diameter of the shaft was made as much more than the size as dictated by theory, as is represented by the depth of the key in the shaft. This investigation is a little at odds, due to lack of data. The overhang may not be quite 2 inches; the weight may not be exactly as assumed; the shaft may be alloy steel, in which event the fiber strain taken is low; in fine, it is necessary in practice to consider all the influences.

In any case it will be well to guard against too much accuracy in a situation such as this, on the ground that the material to use must depend upon experience rather than some preconceived notion of the mission that "jewelry steel" may have to perform

in this world of much uncertainty. If experience in your case is such as to lend confidence, you will be justified in accepting the figures as above given, rather with the hope that they reflect the state of the case with fair accuracy. On the other hand, it is right to say the designer of the car, at the time of designing the jack-shaft, had far more chance of fixing upon suitable dimensions of the shaft than can one, at a distance, in the absence of exact data.

WHAT TO DO WITH A WHITE ELEPHANT.

Editor THE AUTOMOBILE:

[1704.]—I have a single-cylinder car of a well-known make, four years old. I have lengthened out wheelbase, made body side entrance, and practically everything is up to date but the power, this being the only next thing human nature rebels against now. Getting a new car and trading this one is out of the question—first, because one gets nothing for the old one, and, second, because I can't afford it. How would it do to put on, say, half-inch bigger bore cylinder? The present one is 5 by 5 inches. Would you advise using the same size intake and exhaust valves and carbureter? How much more power in your estimation would I gain by such a move?

HARRY J. SWOLE.

Ansonia, Conn.

The only best way to increase the effectiveness of your motor lies in the direction of the alteration of the gear ratio in favor of the motor. The next best scheme is to use a flywheel of greater effectiveness; in addition to these expedients, you can very well afford to see to the carbureter, improve the ignition and look out for the compression. Nothing is to be gained by altering the sizes of the valves if they are of a fair size now. The fact that they may or may not be of the same size is of small concern.

THE VENTURI PRINCIPLE IN CARBURETERS.

Editor THE AUTOMOBILE:

[1705.]—The Venturi tube must have some especial value in carbureters because it is used; that is to say, the principle, in quite a number of them, and it is not far from right to say that it is in "good" carbureters that the method is exploited. Without going into mathematical detail, will you please state the real reason why the shape conforming to the Venturi principle is of value in this class of work?

1-80,000,000.

New York City.

The "Venturi" tube will be approximated if two hollow truncated cones are brought into such relation that the small ends will meet. When this principle is properly incorporated into a carbureter the suction pressure on the gasoline through the nozzle is constant, or more nearly so than will be possible in any other way as yet tried out, in so far as is generally known. Considering the Venturi tube, there is a point in the progress of the suction when the pressure ceases to increase, and as a result the flow of gasoline is in proportion to the requirements rather than in excess at high speeds.

WOULD MAKE A TWO-PLY CRANK OUT OF YOU.

Editor THE AUTOMOBILE:

[1706.]—What would be the effect if a spray of water was forced into a gas engine cylinder before the explosion or combustion of the gas?

A CRANK.

Buffalo, N. Y.

Water in the cylinder would upset the mixture, which is never so good as to stand the change and leave the motor in a state fit to talk about. It is a fact, however, that the right amount of water under well regulated conditions would "tend" to fatten the curve of expansion, and theorists dream about it. On the other hand, when the "octopus" delivers gasoline with even a little water in it, the water is not carefully separated out, trouble is spelled with a capital T.

WANTS REPAIR PARTS FOR THE DRAGON CAR.

Editor THE AUTOMOBILE:

[1707.]—I have written several letters to the Dragon Automobile Company, at Philadelphia, but have failed to receive any reply from them, neither have my letters returned. Do you know if any

one is to continue the manufacture of the Dragon cars? Can you tell me where to secure repairs for the different parts of this car, such as the engine, transmission, rear axle, etc.? I would like to secure some repairs for this machine when I overhaul it this Winter. My car has run 12,000 miles, with absolutely no repairs, no adjustment ever taken up on the engine, and no trouble except tire troubles. It is certainly the best car for the money I ever saw. And it is a pity that the company does not continue to build them.

Lafayette, O.

H. P. M.

It is understood that the manufacture of this car has been discontinued. However, if you will write to Yardsley, Levene & Co., Philadelphia, you can doubtless obtain a supply of repair parts such as you desire.

ABOUT THE RESILVERING OF LENS MIRRORS.

Editor THE AUTOMOBILE:

[1708.]—Will you please tell in "Letters Interesting and Instructive" how to resilver lens mirrors, as the silver backing of the lenses of my headlights has all disappeared, due to their getting too hot?

R. H. COOLEY.

Oakland, Cal.

We think the best advice to give you is to recommend returning the lenses to the maker of the headlights, or to some local firm which has facilities for doing this work, as the usual amateur job of this kind calls for an investment in materials and time that is seldom compensated for by the results.

CAN TIRES BE RUN SAFELY WITHOUT CLIPS?

Editor THE AUTOMOBILE:

[1709.]—I find that my tires give much trouble, possibly on account of the weight of my car, and in changing time is taken because the "clips" have to be undone, and the threads of the same become more imperfect every day. Would it be safe to dispense with them?

OWNER.

Brooklyn, N. Y.

Some owners of cars do eliminate the tire clips of the front tires, and once in a while the rear tires are so treated. It cannot be said that the idea is a good one, since it is possible for the tires to come off, and in the act do much damage. Tiremakers are competent to decide as to the requirements as a rule, and to comply with their ideas is usually well within the bounds of good practice. If the tires on your car are small for the weight, it is within the bounds of reason to consider an increase.

ANTICIPATING THE SUCCESSFUL AEROPLANE.

Editor THE AUTOMOBILE:

[1710.]—Some time ago while reading "When the Sleeper Wakes," by H. E. Wells, I was struck with the description of the flying machines used by the people of his imagination. For example, he says (Chapter XVI):

"The aeroplanes flew safely only in a calm and moderate wind. . . . The starting of the mechanism was only possible from a gigantic car on the rail of a specially constructed stage."

These aeroplanes were very large and went from London to Paris in 45 minutes. They required similar stages for landing. The aeroplanes were smaller, carrying two persons. Note the description, written about 1895:

"Their sails (planes), which were brilliantly colored, consisted only of two pairs of lateral air floats (planes), in the same plane and of a screw behind. Their small size rendered a descent in any open space neither difficult nor disagreeable, and it was possible to attach pneumatic wheels or even the ordinary motors for terrestrial traffic to them, and so carry them to a convenient starting place. They required a special sort of swift car to throw them into the air. Its lateral supporting sails were braced and stayed with metal nerves, almost like the nerves of a bee's wing, and were made of some glassy artificial membrane. The engine was very simple in appearance . . . ; it was of the explosive type, burning a small drop of a substance called 'fomile' at each stroke."

Evidently injection feed. His first sensation was of fear, but this soon changed to desire to stay up indefinitely. Further:

"Steering was accomplished by the opening or closing of one or two thin strips in one or the other of the otherwise rigid wings During these downward glides the propeller was inactive altogether."

In the arrangement of the planes, the starting mechanism and the pneumatically tired landing wheels he seems to have anticipated some of the latest successful machines. E. T. BIRDSALL.

Rochester, N. Y.



Vol. XXX Thursday, January 14, 1909 No. 2

THE CLASS JOURNAL COMPANY

Thirty-ninth Street Building, 231-241 West 39th St. New York City

H. M. SWETLAND, President

EDITORIAL DEPARTMENT

A. G. BATCHELDER, Managing Editor; R. F. KELSEY, Associate Editor; C. B. HAYWARD, Engineering Editor; W. F. BRADLEY, Foreign Representative

BUSINESS DEPARTMENT

A. B. SWETLAND, Business Manager; LOUIS R. SMITH, FRANK B. BARNETT; W. I. RALPH, 1035 Old South Building, Boston, Mass.; C. H. GURNETT; F. W. VAN SICKLEN, 1200 Michigan Ave., Chicago, Ill.; H. H. GILL, Detroit, Mich.; T. B. VAN ALSTYNE, Philadelphia, Pa.

Cable Address - Autoland, New York; Long Distance Telephone - 2046 Bryant, New York

SUBSCRIPTION RATES:

United States and Mexico - One Year, \$3.00; Other Countries in Postal Union, including Canada - One Year, 5.00; To Subscribers—Do not send money by ordinary mail. Remit by Draft, Post-Office or Express Money Order, or Register your letter.

FOREIGN SUBSCRIPTION AGENTS:

ENGLAND:—W. H. Smith & Sons, Ltd., 186 Strand, London, W. C., and all their railroad bookstalls and agencies throughout Great Britain; also in Paris at 248 Rue de Rivoli. FRANCE:—L. Baudry de Saunier, offices of "Omnia," 20 Rue Duret, Avenue de la Grande Armes, Paris. GERMANY:—A. Seydel, Mohrenstrasse 9, Berlin.

Entered at New York, N. Y., as second-class matter. The Automobile is a consolidation of The Automobile (monthly) and the Motor Review (weekly), May, 1902, Dealer and Repairman (monthly), October, 1903 and the Automobile Magazine (monthly), July, 1907.

TRUTH EMANATES FROM THE LABORATORY

Appearances do not tell the tale of the qualities residing in materials, and the conventional methods of arriving at the approximate situation are so misleading, in many cases, as to demand that they be used but sparingly. On the other hand, it is rarely that the vendors of materials, especially steel, condescend to enlighten the users sufficiently for the purpose on a basis of safety. It is not to be supposed that the fabricators of steel do not know just about what the materials are good for, nor will it be beneficial to set up the contention that they deem it inexpedient to lay bare the situation.

Whatever may be the situation from the fabricators' point of view, the fact still remains that the users of materials should look out for themselves; for the law says, "the purchaser must look out for himself." Under the circumstances, it is not unbecoming in any user of steel to take up the burden, and, even if the process is of a length and to a depth, give it the benefit of most careful consideration. Because there are phases of the problem that do assume a mysterious form, there is all the more reason why the user of materials should take hold and by a systematic method of procedure arrive at the bottom facts, instead of groping in the dark.

To approach the subject in due form is the only way by which knowledge of the facts will come to light. Due form, in this case, demands that the user of materials shall step out for himself, taking into account

pyramided knowledge, the requisite facilities, and a firm resolve to unswervingly advance in the face of every delinquency. That difficulty will beset the onward march, is assured, but the password will be given to all who are worthy, if they persist.

The password, if the maker of automobiles is to be considered, is bound up in a laboratory. It is in the laboratory that the qualities of the materials can be arrived at, and as a result of the investigations there to be conducted the dross will float to the top, ready to be skimmed off. So far, much of the dross has been floated, many things were rendered clear, and the potency of the process is now so self-evident as to be declared a "naked truth."



THE SOCIETY OF AUTOMOBILE ENGINEERS

When an organization springs into being—spontaneously as it were—and in the course of a few years grows to an extent where it begins to make its influence felt, it may be said with reason that its existence is the outcome of a natural demand. This has been the case with the Society of Automobile Engineers, which is now entering upon its fourth year. Trade associations were quick to realize the great value of cooperation and a mutual interchange of ideas upon subjects of common interest to a number of engineers, but what the industry at large needed was a body whose deliberations were open to all, and the benefits of which could be equally shared by every maker of automobiles.

Experience in other fields of engineering endeavor has shown the necessity for independent investigation, unhampered by trade affiliations, and the great success of the independent engineering organizations that are the outgrowth of more than a quarter century of development, shows that they have met a demand not to be answered in any other way. Exactly the same conditions apply in the automobile field, and it was this need that prompted half a dozen well-known engineers to broach the matter of forming an organization. The result is the Society of Automobile Engineers. Starting with a few charter members in 1905 it now numbers close to 300, and includes in its ranks engineers drawn from every branch of the industry. Its increasing strength tells a story complete in itself. At the end of another year it will be interesting to note the progress made.



THE NEXT PHASE IS CLOSE AT HAND

Judging from the news that comes from Paris the next phase is near at hand. While it is a certainty that aerial travel will never have any substantial effect upon automobiling in general, it is pretty good guessing that many automobilists will also add aerial skill to their accomplishments.

It was in France that the automobile had its earliest and most rapid progress, and though an American has shown the Frenchmen how to fly, he did so because there was more encouragement offered to him on the other side of the ocean than in his own country. Furthermore, the Frenchmen are taking to aeronautics as readily as a duck does to water, and the first aeronautical exhibition makes apparent the fact that there is going to be no small amount of attention devoted to the aerial problem until it becomes as common as automobiling is to-day.

GIST OF MAKERS' TARIFF BRIEF TO CONGRESS

SIGNED jointly by Henry B. Joy, as chairman of the tariff committee of the Association of Licensed Automobile Manufacturers, and Benjamin Briscoe, as chairman of the committee of management of the American Motor Car Manufacturers' Association, the supplemental brief of the American manufacturers of automobiles expressing them in favor of a protective duty, has been filed with Congressman Sereno E. Payne, chairman of the House Committee on Ways and Means at Washington, and has also been generously distributed throughout the entire country. Pertinent extracts from the brief are herewith given:

The number of people directly employed in motor-car factories is upward of 100,000, and the number of others employed in the allied industries is being compiled for your committee.

The number of establishments allied with this industry and more or less dependent upon their success is approximately 4,000.

Foreign manufacturers are protected in their patent rights in America, while American manufacturers must manufacture abroad in order to retain their foreign patent rights.

The price of labor in America is two and one-half times as much as it is in Europe, and the cost of selling in America is one and one-half times as much as it is in Europe, while the cost of technical employees is twice as much here as in Europe. We do not at this time enumerate the difference in the cost of material, advertising, rents, insurance, or all overhead charges.

If the tariff is to be primarily adjusted at the difference between wages paid here and abroad, then the tariff should be 60 per cent. instead of 45 per cent. This is not the desire of your petitioners. We seek to have automobiles specified as such in the tariff bill itself, and not governed as now by a tentative ruling of the Treasury Department. While the present duty of 45 per cent. may not be a sufficient protection as time goes on and trade conditions change, still the industry itself should by its own strength be able to meet these emergencies. As a matter of fact, the industry is still in such a condition of early growth that final figures can not be made absolute on an exact rate of full protection in the tariff.

The fact of overproduction and the alarming commercial conditions prevailing at present in this industry abroad is shown in the reports from the automobile shows in London and Paris in the various foreign trade publications.

Individuals are allowed to import a single machine purchased abroad and to bring it in under section 19, when the law is clearly defined on actual purchases under sections 3 and 4. This alone has made a difference in revenue to the Government of over \$200,000, and given to the foreign manufacturer an unfair advantage over the American manufacturer and dealer.

What the Treasury Ruling Now Permits.

The report then goes on to say that a treasury ruling permits an examiner to place a value upon machines used for a period of less than a year abroad, and it is suggested that some arbitrary rule be adopted, governed by the length of ownership, number of miles traveled, condition of the vehicle, or all three.

Special attention is called to the evasions of regulations T. D., 23,743 and 26,162, by false representation of alleged racing and touring cars. Cars are claimed to be regularly imported, exposed for show purposes, and sold. Under these regulations an importer is enabled to expose for sale imported racing or touring cars for three months after importation without the payment of duty. The only penalty provided is the payment of the duty or the exportation of cars.

A 40-horsepower Fiat car, made in Turin, Italy, is now entered at the port of New York at 8,000 francs net, and 150 cars of this make have been imported, consigned to an Italian banker. The close alliance existing between this banker and the Fiat Automobile Company of New York is deducible from a letter from the latter to the Mayor of Detroit, dated December 21, 1908, in which it is said that a large factory may be established in this country.

"The foregoing automobile is offered for sale in this country at \$6,000, with body and equipment, and \$5,000 for the chassis alone," states the brief. "Agents receive a discount of 20 per cent. from the last price, leaving a net selling figure of \$4,000 and a profit of \$1,600, less a trifling cost of mudguards and run-

ning boards. The importer has this margin with which to undersell American competitors.

"Similarly the Lancia car, made in Italy, is offered for sale in France, England and Italy for \$2,000, and after adding 45 per cent. duty and 5 per cent. import charges, is offered in this country, similarly equipped, for \$1,800—or \$200 less than its parallel selling price abroad."

Aggregate Value of Imported Vehicles Reduced.

Following is quoted entire from the brief:

In view of the fact that the aggregate value of imported vehicles between 1906 and 1908 has been reduced almost 50 per cent., and between 1907 and 1908, 26 per cent., and the average value per vehicle for a corresponding period shows a respective reduction of 40 per cent. and 30 per cent., we urge upon your committee the imperative necessity of such provisions in the interpretation of the words "market value" as will entail the requirement of certain specific rulings under certain conditions without permitting the exercise of discretion by the administrative officers of our ports. There has been a constant growth in importations, increasing yearly in volume, decreasing yearly in average value. We refer you also to the statistics of imports compiled by the Department of Commerce and Labor.

The retail value of foreign cars sold in America during a period of six years, with additional parts, is approximately \$52,677,046. The value of American cars sold in America for a corresponding period is approximately \$250,000,000.

A motor vehicle of any kind can be made in Europe certainly for 60 per cent. of the cost thereof in America, including the manufacturer's profit, as shown in the Fiat case, and by the figures on cost of materials and labor.

We particularly point out that Charles H. Sherrill, representing the importers, and especially the Fiat Company, of Italy and America, stated to your committee that the tariff ought to be reduced to 33 per cent. In other words, such a rate of tariff would be satisfactory to the Italian company as giving it free access to the American market.

It is further of the utmost importance to note that Mr. Sherrill also admitted that the 40-horsepower Fiat chassis, which we referred to in our preliminary brief and which we refer to again in this brief as being imported at a customs value of \$1,800, was actually imported at a customs value of \$1,600, and he further stated that this sum of \$1,600 was the full and total sum which went abroad in full payment of the 40-horsepower chassis referred to. We direct your attention especially to a complete and detailed refutation of erroneous statements made by Mr. Sherrill in his hearing before your committee, in the attached appendix and exhibits referred to therein.

We wish most urgently to impress upon your committee that with 60 per cent. of American cost a tariff of 65 per cent., plus 5 per cent. freight and import charges, would still permit a European manufacturer to place his product on the American market at 102 per cent. of the American cost—only a margin of protection of 2 per cent. If, however, you assume that average European costs are 65 per cent. of American costs (though American workmen are entitled to protection against the cheapest labor and not the average labor), then a tariff of 45 per cent., plus 5 per cent. for freight and import charges, would put foreign cars on the American market at 97 1-2 per cent. of the American cost.

In Reference to the Commercial Vehicle Industry.

Next, the commercial vehicle industry is taken up, this including trucks and the very freely imported taxicabs. It is insisted that this infant industry requires the same protection accorded the pleasure cars; viz., 45 per cent. duty, for the reason that the industry is still in a state of evolution, involving much present and future experimentation before arriving at a marketable product.

In support of this, it is stated that the Packard Motor Car Company, while asking \$3,700 for its three-ton truck, will be obliged to sell hundreds of them in order to make a profit, due in part to the cost of equipment. At this price, an agent's discount of 10 per cent. must be deducted.

On the other hand, the De Dion-Bouton Company, of Paris, is marketing a three-ton truck here valued at \$2,500, which, with duty and import charges, is placed on the New York market at \$3,700, including both manufacturer's and selling agent's profits.

Then the brief goes on to say:

That note be taken of the fact that our rate is only 10 per cent. higher than the Canadian tariff rate. Even considering Canada's cheaper labor and lower manufacturing cost, they find it necessary to impose a tariff rate nearly equal to our own, and further safeguard their interests by "dumping duty," which is graduated to protect against overproduction and special export prices abroad.

Automobiles are subject to a duty of 45 per cent., and section 19 provides, whenever imported merchandise is subject to an ad valorem duty based upon the value thereof, the duty shall be assessed upon the actual market value.

Concerning the German Trade Agreement.

The German trade agreement, April 22, 1907, provides: "Market value shall be construed to mean the export price whenever merchandise is sold wholly for export, by reason of which facts there cannot be established a market value based upon the sale of such merchandise in wholesale quantities, packed ready for shipment to the United States."

Thus foreign trade agreement is absolutely contrary to the provisions laid down by Congress.

We protest against reciprocal trade relations as advocated by agricultural implement manufacturers. It seems unjust and unrighteous to remove an adequate protective tariff from one industry in order to induce some foreign government to reduce its rate of tariff on some other American product. The slaughter of one industry for the benefit of another is not in accordance with wise protection.

Again, section 11 provides how customs officers may arrive at market value, but the German trade agreement provides: "The certificates as to value issued by German chambers of commerce shall be accepted by appraisers as competent evidence."

This abolishes the legal requirement of both sections 19 and 11. It is thus possible to make the value of a foreign motor car for import purposes any price which a foreign chamber of commerce will certify to. This mode of undervaluation is being used to-day, thus defeating the entire intent of the American protective tariff.

Statistics of the American Industry.

The National Association of Automobile Manufacturers is described in the brief as composed of the members of both the other organizations and of a number of other manufacturers not affiliated with either organization. The American Motor Car Manufacturers' Association is composed of 44 manufacturers who do not recognize the validity of the Selden patent. The Association of Licensed Automobile Manufacturers is composed of a group of 30 automobile manufacturers of America who recognize the validity of the Selden patent and pay royalties thereunder.

Next follows this general summary of the condition of the industry, accompanied by statistics of its expansion:

About 80 of the American firms engaged are marketing a product that is of some importance to the trade. About 10 per cent. of the whole number (25) have so far, possibly, made a commercial name, but we doubt if even 20 manufacturers can show a fair profit.

Notwithstanding the great number of machines sold and the amount of money invested. It is a fallacy in the public mind that the manufacture of automobiles represents a very large profit. At least 90 per cent. of the manufacturers of automobiles in this

country are not to-day making manufacturing profits, and but few concerns engaged in the business have been in any sense successful. This is not because of poor business management, but on account of the large amount of capital required in the experimental and development stages to bring the industry to its present condition and the many unusual risks incident to the conduct of a business of this character. The industry is profitable only in the event of there being an especially desirable product combined with ample capital, skill, and foresight, and a selling ability properly proportioned to market a large product. A record of the development of the industry is submitted herewith:

In 1902:	Concerns in business.....	51	
	Discontinued that year.....	18	
	Concerns carried over into 1903.....	33	
	Increase during year.....		38
In 1903:	Concerns started up.....	71	
	Discontinued the same year.....	30	
	Concerns carried over into 1904.....	74	
	Increase during year.....		41
In 1904:	New concerns started.....	54	
	Discontinued.....	40	
	Concerns carried over into 1905.....	88	
	Increase during year.....		14
In 1905:	New concerns.....	51	
	Discontinued that year.....	38	
	Carried over into 1906.....	101	
	Increase during year.....		13
In 1906:	New concerns.....	43	
	Discontinued.....	29	
	Carried over into 1907.....	115	
	Increase during year.....		14
In 1907, new concerns.....			51
			166

Note.—Of the 51 concerns in business in 1902 only 21 survive and are in business to-day.

And, Finally, the Conclusion of the Brief.

In closing our appeal for an adequate protective tariff and adequate means for enforcing the intent of same we respectfully submit that it is our desire to ask only a sufficient and adequate rate of tariff and such a wise and proper classification as will promote the best interests of the motor-vehicle industry and those industries allied with it. We believe our statements and allegations are correct and founded on facts. We believe in the sound wisdom of the tariff protective policy of our country. We believe that tariff revision means exactly what it says, namely, that it is the intent of the people of the United States, of the Congress, and of the President-elect Taft, to have the tariff so revised as to justify the continued upbuilding of, and investment of money in, American industries under American wage conditions as they exist to-day, whether it may require increases or decreases of rates, or the maintenance of existing rates.

Respectfully submitted,

HENRY B. JOY,

President Packard Motor Car Company and Chairman Tariff Committee of Association of Licensed Automobile Manufacturers.

BENJAMIN BRISCOE,

President Maxwell-Briscoe Motor Company and Chairman of Committee of Management of American Motor Car Manufacturers' Association.

WHAT NEW JERSEY'S GOVERNOR NOW SUGGESTS

TRENTON, N. J., Jan. 12.—Gov. Fort in his message to the Legislature suggested that special regulations in the open country should be liberal, and that 30 miles an hour could safely be permitted instead of the present maximum of 20 miles.

The disappointing feature of his recommendations is that he cannot yet see his way clear to suggesting a reciprocity in registrations with other States which now can be entered by New Jersey automobilists because of their home registrations. The Governor recommends, however, that a more simple and easy method of procuring a license be especially provided for non-residents. Among other things he says:

"The automobile is with us and it has come to stay. It must be given all highway rights, under proper restrictions to protect the public and the occupants of the machine. Railroad regulations as to the running of trains, safety appliances and the like are intended for the protection of the passenger more, if any-

thing, than the traveler crossing the track. All vehicles upon the public highway should be required to carry lights. Arrest and trial should not be summary, but the right to stop should only exist to inquire as to the possession by the driver of the machine of the requisite authority or to obtain its number if violation of law be claimed.

"Suit should only be instituted by direction of the department in proper courts near the residence of the alleged offender or at convenient points within the State for the non-resident. Wilful injury to person or property by the driver of a car, or such injury by an intoxicated driver, should be a misdemeanor and punishable accordingly, without of course the loss of right to maintain a civil suit by the injured party or the owner of the damaged property. The present license fees are not excessive and should not be modified by any reduction unless it be through some system of uniform legislation between the States."

REVISED RESULT OF QUAKER CITY ENDURANCE RUN

PHILADELPHIA, Jan. 11.—As a result of successful protests by several of the contestants in the New Year's endurance run of the Quaker City Motor Club, there have been not a few changes in the final standing, and even this may not be final, for at least one of the contestants has carried his case to the A. A. A. and others may do likewise.

When the first finish results were posted, the Oldsmobile people got busy on Monday and proved that Folberth and Berger, drivers respectively of Nos. 12 and 23, had been held up on Giant's Despair through being blocked by the Acme (No. 4). They were consequently relieved of demerits, which place them in second and third places, respectively. Folberth got rid of 220 bad marks and Berger 371. Laurent Grosso's Stearns, No. 24, moved up from ninth to fourth place when the committee relieved him of 219 road demerits. These successful protests pushed the Dietrich-Matheson, with a total of 37 penalties—all technical—down to fifth place.

The revised order of finish brought forth another cloud of protests, and on Wednesday afternoon a special meeting of the contest committee was held to thresh out the whole matter. As a result of the testimony adduced there four Class A cars were



Matheson No. 7, Winner of the Quaker City Endurance Run.

This photograph was taken on the return of the car to Wilkes-Barre after the race. Reading from left to right, those in the tonneau are: W. Miller, driver; Harry Sidel, timekeeper; A. T. Stewart, representing MacDonald & Campbell, donors of the Quaker City cup; F. M. Kirby, owner and entrant; F. F. Matheson, general manager of the Matheson Company; Jack DeWitt, mechanic, and C. W. Matheson, president of the Matheson Company.

disqualified entirely—Tuttle's Stoddard-Dayton, No. 13; Carris' Franklin, No. 10, which had been originally placed No. 2 at the finish; Darnstaedt's Rambler, No. 19; Ray McNamara's Premier, No. 21—either for receiving outside assistance in climbing Giant's Despair, for getting up the mountains sans passengers, or both.

The Premier people were represented by an attorney, John Handy Hall, and he and the Quaker City Motor Club's legal sharp, G. Douglass Bartlett, had a lengthy battle. The Premierite's testimony showed that while the car had run a short distance—probably 50 yards—without its passengers, the driver had done so with a clear understanding that such a proceeding was justifiable, in the event that it was found impossible to secure traction otherwise; that, in response to a query the night before, Dr. J. R. Overpeck, a member of the committee, had declared that the unloading of passengers under such conditions on a slippery hill would not be punishable. On the ground that the Premier had gone passengerless farther than was necessary to secure traction, the committee voted to disqualify the car. Attorney Hall immediately gave notice that an appeal would be carried to the A. A. A. in order to secure the Premier's rights.

On the face of the reports the 18-points penalty accumulated by the Premier from the checker's cards would give that car fourth place if the appeal to the national body is successful.

The overwhelming Matheson success, which the first decision of the contest showed and which was somewhat dimmed by the success of the Oldsmobile and Stearns appeals, was still further marred by the imposition of additional checkers' penalties on the Anderson-Matheson, No. 15, which the cards showed had checked in ahead of time at one or two controls. The additional demerits, with the "butting in" of the Oldsmobiles and Stearns, put Anderson in sixth place and the last of the Matheson trio instead of second.

As finally reckoned out, the final standing (barring the result of the Premier appeal) is as follows:

CLASS A.							
No.	Car.	Driver	Ch's.	Obs'rs.	Tech'l	Total	
7.	Matheson	Miller	0	1	10	11	
12.	Oldsmobile	Folberth	0	4	9	13	
23.	Oldsmobile	Berger	5	0	10	15	
24.	Stearns	Grosso	0	1	29	30	
6.	Matheson	Dietrich	0	0	37	37	
15.	Matheson	Anderson	44	3	23	70	
3.	Cadillac	Burnshaw	43	1	37	81	
10.	Mitchell	Freltag	110	2	15	127	
2.	Cadillac	Crawford	112	0	23	135	
8.	Stoddard-Dayton	Shirk	37	77	26	140	
14.	Studebaker	Yerger	189	2	4	195	
4.	Acme	McCormick	236	2	31	269	
20.	Maxwell	Bltner	441	34	265	738	
5.	Elmore	Hardart	Out.				
9.	Mitchell	Cram	No observer's cards.				
11.	Winton	Depew	Out.				
13.	Stoddard-Dayton	Tuttle	Disqualified.				
16.	Franklin	Luckenbach	Out.				
17.	Winton	Schenck	Out.				
18.	Franklin	Carris	Disqualified.				
19.	Rambler	Darnstaedt	Disqualified.				
21.	Premier	McNamara	Disqualified.				

CLASS B.							
No.	Car.	Driver	Ch's.	Obs'rs.	Tech'l	Total	
5.	Peerless	Brooks	26	2	22	50	
4.	Maxwell	Longstreth	163	1	75	239	
1.	Stoddard-Dayton	Harkins	No observer's cards.				
2.	Mitchell	Borle	Out.				
3.	Oldsmobile	Webster	Out.				
6.	Knox	Bourque	Out.				
7.	Rambler	Brown	Out.				
8.	Buick	Wilkie	Out.				

THE NEWS FROM TIRETOWN.

AKRON, O., Jan. 10.—Tire manufacturers are estimating that the total value of their product here this year will almost equal \$15,000,000. Notwithstanding the depression of the past two years, the season of 1908 was a record-breaker for tires, and a bright outlook for this class of rubber products is looked for. Manufacturers returning from the Palace show estimate that the number of cars to be sold this year will equal 75,000, which will tax the tire plants. The manufacturers will not only be called upon to furnish tires for the new cars, but the cars now in use, believed to number 150,000, will require many tires.

The Akron Automobile Dealers' Association has been organized by the election of E. T. Jones, president; Fred Feckley, vice-president; L. J. Fritsch, secretary; J. M. Sauder, treasurer. The association will have an automobile and motor boat show in the East Market street rink, January 28, 29 and 30. Motorcycles will also be shown.

The Firestone Relief Association has perfected its organization by electing the following officers: President, J. S. Hill; vice-president, Daniel Goodenberger; recording secretary, James R. Neely; treasurer, George Kelly; financial secretary, Lee Clough; captain, Cyrus Reading; trustees, William MacAllister, Charles H. Gardner and William Heller. During the course of the exercises, President H. S. Firestone addressed the members, which is composed of employees, and presented the association with the company's check for \$500. Mr. Firestone recommended that when members leave the employ of the company their membership shall lapse after a certain time in order to make the association restrictive as much as possible.



A STOP AT AJAX-GRUB
FACTORY - TRENTON



MRS. BUCKMAN
-RENAULT-



COL. R. C. PARDEE AND
MAXWELL GUESTS -



MRS. CONEO
-LANCIA-

When Women Go Autoing



MISS RITTWETZEN
-MAXWELL-



MRS. A. W. SEAMAN
-FRANKLIN-



MISS HEYES
-CADILLAC-



MRS. RAMSEY
-MAXWELL-

WOMEN HAVE A NEW YORK-PHILADELPHIA ENDURANCE RUN

ONCE upon a time, not so very many years ago, a score or more of so-called automobiles, driven by would-be automobilists, attempted to make a journey from New York to Philadelphia in one day. It was a hard struggle, and the derelicts were strung along the road between the metropolis and Quakertown, the conclusion having comparatively few survivors. That was the first real long run ever undertaken in this country, the event having been the initiatory of the industry as well as the first effort of the Automobile Club of America.

On Monday morning of this week there started for Philadelphia ten automobiles with drivers of the fair sex at the wheels, and the whole ten comfortably reached Philadelphia in the shank of the evening, despite the rough roads and weather that was a close approach to Winter. As things are rated nowadays in automobiling, it was not such a much of a run, but at the same time the "Women's Motoring Club" demonstrated that the driving of an automobile is a task which is not beyond the capabilities of the so-called weaker sex.

The "stunt" may have looked considerably like an advertising proposition, but even so it was cleverly accomplished, and the two-day run must be looked upon as a happening which adds to the evidence of the universality of motor-driven transportation as advancing with bounds. "Alex" Schwalbach was most of the "committee," with "Senator" Morgan interested.

Officially started by E. L. Ferguson, who "checks out on the Glidden tour," and supplied with real route books, these ten started Monday morning with other escorting cars from the Plaza Hotel bound for the Hotel Walton in Philadelphia.

1. Maxwell runabout—Mrs. J. R. Ramsey, Hackensack, N. J.
2. Lancia "Lampo" runabout—Mrs. J. N. Cuneo, Jamaica, L. I.
3. Maxwell runabout—Mrs. L. Gillespie, Poughkeepsie, N. Y.
4. Franklin four-cylinder—Mrs. A. W. Seaman, Brooklyn, N. Y.
5. Renault "23" touring car—Mrs. E. M. Beeckman, New York.
6. Maxwell runabout—Miss B. M. Rittwetzen, Huntington, L. I.
7. Cadillac four-cylinder—Miss Alice D. Heyes, New York City.
9. Maxwell runabout—Mrs. J. G. Kirkman, Brooklyn, N. Y.
11. Maxwell—Mrs. P. Bach, Newark, N. J.
12. Maxwell four-cylinder—Mrs. E. G. Gresh, Norristown, Pa.

In the run to Philadelphia on Monday the weather was quite comfortable. En route the party was entertained at the Ajax-Grieb Rubber Company plant in Trenton, President Horace De Lisser being the host of the occasion. The first to arrive at the Philadelphia city line was Mrs. Cuneo, who was one hour ahead of the schedule. Dr. J. R. Overpeck, of the Quaker City Motor Club, escorted the participants to the Hotel Walton, where in the evening Mayor Reyburn contributed an address of welcome.

The return journey of Tuesday was not quite as enjoyable as the outward trip. At New Brunswick a light but cold rain was encountered, and these conditions continued to the conclusion. At Trenton Governor Fort had socially said, "How do you do?" and at Grant City on Staten Island the Richmond County Automobile Club supplied a luncheon.

The first one to arrive at the Plaza Hotel was Mrs. Cuneo, whose clever handling of the Lancia "Lampo" was a feature of the run. In connection with her driving of this car, attention might be called to the fact that this winner of the light car race at Savannah is "stock," for Lancia only supplies one type of engine as to bore and stroke, viz., 90 mm. bore and 100 mm. stroke. This is the size of the four-cylinder "Lampo" type roadster, and even the cylinders of the "six" are all the same. The only actual difference in the "Lampo" engine from the others, to be exact, is asserted to be the method of timing and slightly increased valve area, which is a combination that permits the motor to run at considerably higher speed. In this manner Lancia claims to secure his greater speed results, for no devices are utilized to increase the compression.

After the participants had been "checked in," it was announced that the selection of the prize winners might not be determined for several days.

The Maxwell-Briscoe Motor Company offered a bronze trophy to the driver of the Maxwell car making the best showing, and the Hol-Tan Company offered a silver cup, though Mrs. Cuneo was barred from competing for it. No matter who wins the prizes, all the survivors made a most excellent showing and demonstrated that the driving of an automobile has become a task well within the ability of the average woman.

INDIANA MAY HAVE AN AUTOWAY.

INDIANAPOLIS, Ind., Jan. 11.—With the purchase of a large tract of ground northwest of the city by a number of automobile men, plans for an automobile race course that may attain a national reputation have become known. A company is to be formed at once, the proposed capital stock having all been subscribed and work on a twenty-six mile course will be started.

As planned, the tract of ground will provide an oblong track, two miles around the outer edge. It will wind towards the center, making a course twenty-six miles long. An amphitheatre will be built, from which it will be possible to watch the contesting cars at all parts of the course.

Improvements are to be made that will cost \$250,000 on the course, which is one mile long and one-half mile wide. The plans include a union station, as the course touches a steam railroad and an electric interurban line.

Carl G. Fisher, a local automobile dealer, is father of the project. With George M. Schebler and James A. Allison he has carried out the preliminaries, each investing \$15,000. Other automobile men are also interested in the project.

The course will be located near Riverside Park, just northwest of the city. The promoters estimate that cars can attain a speed of 120 miles an hour on the outer portion of the course and sixty miles an hour on the inside track, and there will be practically no danger of accidents to spectators because of the peculiar arrangement of the track. Work on the course is to be started at once.

WASHINGTONIANS ELECT OFFICERS.

WASHINGTON, D. C., Jan. 10.—The annual meeting of the Automobile Club of Washington resulted in the following officers for the ensuing year: President, W. D. West; vice-president, O. J. DeMoll; secretary, John K. Heyl; treasurer, H. C. Chandlee; captain, J. A. Muehleisen; lieutenant, Lester D. Moore, Jr.; governors, R. B. Caverly, W. W. Chiswell, Fulton R. Gordon and J. M. Stoddard. The reports of the retiring officers indicated that the club was in a flourishing condition, the membership having increased from 69 to 130 during the year. Plans are on foot for increasing interest in the club and the new officers have promised they will leave no stone unturned.

BALTIMOREANS WANT A SHOW.

BALTIMORE, Jan. 11.—At the regular fortnightly meeting of the Automobile Club of Maryland the past week, D. C. Walker was appointed chairman of a committee to work up plans for an automobile show to be given under the auspices of the club. The main obstacle in the club's way at present is the securing of ample quarters for holding the affair. The committee is now looking around for a place large enough for a show. Should they be successful it is the idea of the club members to have the exhibition take place about February 24.

The club appointed a committee to co-operate with the national roads committee of the American Automobile Association, with Benjamin Friedenwald, of Baltimore, as chairman.

C. H. METZ ACQUIRES WALTHAM PLANT.

WALTHAM, MASS., Jan. 11.—By his acquisition of the Waltham Manufacturing Company's plant, C. H. Metz returns to the control of a plant that he was largely instrumental in developing in its early days, and will be the largest individual operator of an automobile plant in this country, as he is planning to turn out 5,000 cars. The Waltham Manufacturing Company was organized by Mr. Metz in 1893, and he then started the bicycle riding fraternity by bringing out a 21-pound machine that was guaranteed to stand up under any condition of road, load or speed. The novel features first brought out in the Orient bicycle of that day are still said to be standard in bicycle construction at the present time. Thousands of the machines were sold, and four years later Mr. Metz parted with his controlling interest in the company.

The Waltham Manufacturing Company was the first in this country to take up the manufacture of automobiles using the Daimler motor. One of Mr. Metz's hobbies was the Orient bicycle, which used the Daimler type of motor, and in order to develop it according to his own liking, he severed his connection with the company altogether in 1901 and began building motorcycles on his own account. Subsequently he became affiliated with the American Motor Company, manufacturing the Marsh-Metz motorcycles. It is said that the car Mr. Metz is planning to produce in the Waltham factory will embody many features of light weight and strong construction.

The chronology of Mr. Metz's experience in the bicycle and automobile industry is interesting and is accordingly given below:

- 1883 Local sales agent for Columbia machines.
- 1885 Champion bicyclist of Central New York—home in Utica.
- 1886 Manufacturer of bicycle attachments.
- 1889 Joined Union Cycle Company at Highlandville, Mass.
- 1890 Led crusade for lighter bicycle construction.
- 1891 Invented Dunlop detachable tire principle.
- 1892 Joint interest in Dunlop tire patent sold for \$100,000.
- 1893 Organized Waltham Manufacturing Company.
- 1894 Produced lightest practical roadster bicycle.
- 1895 Output increased to 1,500 machines.
- 1896 Output increased to 4,500 machines. Made 4, 5 and 6-seated bicycles. Famous through their use in pacing world's champion riders.
- 1897 Output reaches 15,000 machines. Made 10-seated bicycle—the Oriten—the largest bicycle ever built.
- 1898 Made automobiles. Produced the first motorcycle in America.
- 1901 Severed connection with Waltham Manufacturing Company. Became technical editor on staff of "C & A Trade Journal."
- 1902 Built Metz motorcycles. Made American record for one mile on Staten Island—time, 1-10 2-5.
- 1903 Introduced grip control and other original motorcycle features.
- 1905 Affiliated with American Motor Company.
- 1906 Developed Marsh-Metz motorcycle.
- 1907 Introduced new features in Marsh-Metz construction.
- 1908 Developed Metz plan car.
- 1909 Acquired plant of Waltham Manufacturing Company.

Thus it would appear that Mr. Metz has qualified for a still greater success by his long and varied experience.

GOODYEAR SEEKS TO PREVENT PRICE CUTTING.

AKRON, O., Jan. 11.—As a result of the more or less recent formation of several organizations, the chief object in life of which has been the supplying of accessories at cut prices, and particularly tires, the Goodyear Tire & Rubber Company is taking steps to protect its dealers against competition from this source. In a circular letter it calls attention to the "International Automobile League," Buffalo, N. Y.; "Co-operative Auto Association of America," New York, and the "Bureau of Automobile Auditors," also of New York. These organizations advertise that they are able to supply tires and other supplies to the consumer at dealers' prices, and to do this it is necessary that they should be able to obtain trade discounts through certain dealers.

In order to put a stop to this practice the Goodyear company is requesting its dealers to inform it of the serial numbers of tires thus purchased that have come under their notice. By this means it will be possible to trace the original purchaser of the tire and thus determine the channel through which it reached the price cutting association. Trade prices will be immediately withdrawn from any dealer who is found to be selling Goodyear tires in this manner, and he will be placed upon the same basis as the consumer.

KISSELKAR "CLIMBS" A 14-STORY HOUSE.

As a result of a wager, a 30-horsepower KisselKar "climbed" to the upper levels of the new Fifth avenue building, now in course of construction on the site of the old Fifth Avenue Hotel at Twenty-third street and Broadway, one day last week. But the car did so at the end of four stout steel hooks attached to it, and forming parts of a four-piece bridle at the end of a steel cable and hoisting engine, and thereby hangs the tale.

It seems that F. S. Dickinson, manager of the New York branch of the KisselKar company, of Hartford, Wis., and F. J. Wagner, the well-known race starter, had slightly different opinions on the subject of climbing. Mr. Dickinson was quite certain that the Model LD-9 30-horsepower KisselKar, which is the \$1,500 offering of that company for 1909, was the greatest hill-climber ever, and that there were few things it could not romp up "on the high." "Wag" dissented, which statement led to the wager aforesaid. A 30-horsepower KisselKar runabout

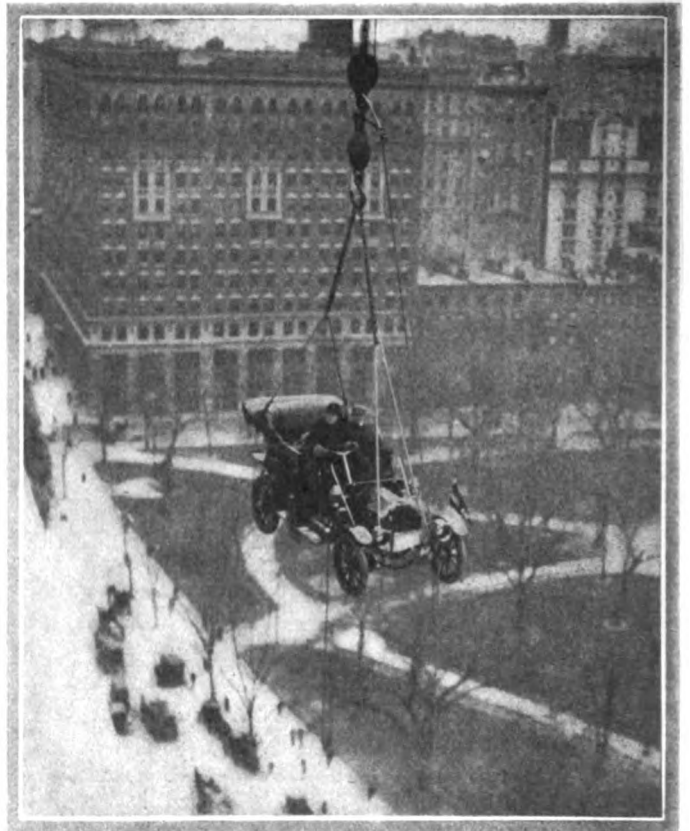

F. S. Dickinson's KisselKar Aloft in Madison Square.

of the type in question was driven down to the new Metropolitan tower, for Wagner had ambitions to climb the highest building he could find. The hoisting lines were attached and everything was about ready to take the car and its passengers aloft, when the officials of the Metropolitan happened along for the purpose of inspecting the new chimes that are to hang in the tower. They immediately put a stop to the "stunt," in view of the hazardous nature of the undertaking being contrary to their principles, and an adjournment was taken to the new Fifth avenue building on the other side of Madison Square, with better success, as the photograph demonstrates.

GRAY & DAVIS SECURE WRIDGWAY LICENSE.

Gray & Davis, the well-known automobile and carriage lamp makers, of Amesbury, Mass., have secured the license to make the Wridgway Non-Glare Shade, and the firm is the only lamp manufacturer to receive such a license. Recently an ordinance was passed in New York City prohibiting the use of searchlights in city limits, unless properly subdued in such manner as not to interfere with other users of the road.

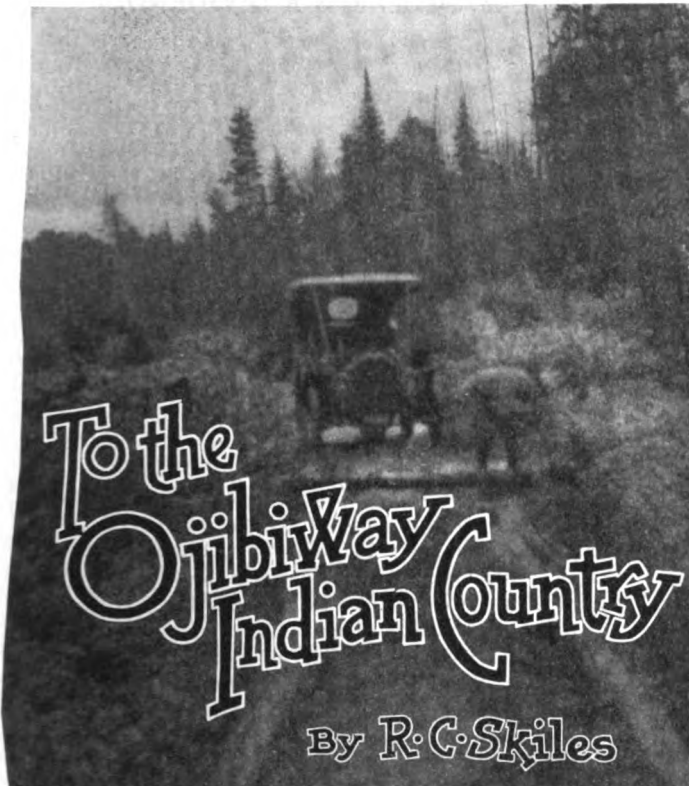

To Reach this Beautiful Country Requires Work.

I was in company with my wife that on a pleasant morning of August—the 13th, to be exact, for we were not superstitious—that I began a drive from Shelby, O., to the north of the Ojibiway Indian and the historic Hudson Bay country. From Shelby to Cleveland to Buffalo, the miles were traversed by our four-cylinder Buick without an accident worth the mention. Then we visited the cataract of Niagara and crossed into Canada, first going to Hamilton and then to Toronto, where we were told it would be folly to drive any farther north than Gravenhurst, at the foot of the Muskoka lakes and in the heart of the game-fishing region.

Gravenhurst is a long way from North Bay, Ontario—which is on Lake Nipissing, the supply station for the Cobalt, the destination we had in mind—and we determined to get as near there as possible. So with thorn and waterproof clothing, plenty of oil and gas, and a good toolcase, including an ax, which I purchased in Toronto, we left Gravenhurst, the end of good roads behind us. As far as Bracebridge, some 10 or 12 miles farther north, we followed the Ontario Motor League guide book over a very stony road, which was a constant climb of the Ontario highlands toward the height of land. The guide book gave a very attractive route through to North Bay, with an encouraging footnote, "Good roads the whole way," and believing this authority to be reliable, we left Bracebridge confident of an easy trip. At the first stop for water a Hebrew peddler was encountered who had traveled the country by wagon to within 60 miles of North Bay, and he advised me to take a different road from the one given in the guide book, so his route over the old Parry Sound road was very fortunately taken. This peddler was of service to us, and we thanked him, but we fear that another road peddler whom we met did not thank us. His horse was frightened and bolted. As the horse running away passed us, we heard the peddler say to him, "Wait a minute, Jack"! Rather a peculiar request to make of a horse that was running away!

Through country that would seem impassable to the average autoist, the road climbed up to the highlands in the beautiful Lake of Bays district, where out from behind every hill a clear little lake lay shimmering in the sunlight. Even this far along

an automobile was a curiosity, but the people could call it by name, which was more than the more northern settlers could do. After a hard drive from Gravenhurst for seven hours, we reached Huntsville. We had covered only 33 miles. The next day, between 9 A. M. and 4 P. M., the car climbed over rocks and up hills, occasionally passing through a lumber camp, to South River, 60 miles nearer the cherished destination, but where we were told that we could go no farther. Two cars made the attempt last year, but failing to climb the noted South River hill, turned back. This was cheering information, but after sleeping over the prospect of taking the hill and getting over the roads beyond, I decided to make the effort, and in case of failure, store the machine at South River, and go on by the Grand Trunk Railroad to North Bay.

Leaving South River at 8 A. M. in a pouring rain, we started for the big hill, four miles out of town. The approach to it was over stones and loose corduroy, with no opportunity to get up speed. The hill itself was of wet, slippery yellow clay covered with loose stones, and two abrupt turns had to be made before the summit was reached. The car made a brave fight with the rocks and mud until the first turn was reached, and there the danger of skidding down the abrupt mountain side was so great that we backed the machine down and cut by hand a space large enough to turn around in. Sorely disappointed, we drove back to South River, not to store the car, however, but to wait for a dry day, when I was confident the climb could be made. Upon reaching the town a bystander suggested that we try the "winter road," and thus avoid the hill. Eager to make North Bay and blissfully ignorant of the character of a "winter road," we made a second start. The first few miles was over the usual hills, stones and corduroy into a forest that gradually grew more and more dense. Suddenly the beaten track seemed to end and the forest closed in upon us, but since there was no place to turn aside, we kept on, sometimes plunging down the rocks into a bed of spongy moss, sometimes climbing up the rocks into the low hanging clouds, but scarcely ever going more than five feet without stopping to figure out the best way to drive the next five. Stumps and fallen timber soon came to be trifling obstacles, for they would yield to the ax, but the boulders were a very different problem. They were so many and so high that in places where the car would not clear them or where it was not possible to chop a way around them, the wheels would have to be jacked up, filled under with brush and then driven over. After fifteen miles of such driving we came out into the light of a small clearing, where a wood cutter with his wife and eight small children lived in a little cabin. Having never seen an automobile before they were almost speechless with fright, and unable for a time to respond to a request for water, which the engine was thirsting for. It seems no one had tried to get over the road since winter, when, as was learned later, the cleared path is filled in with brush after the first snowfall, then sprinkled with water, which, freezing, forms an ice road for the lumbermen's sleds. This lone inhabitant had made



Farthest North—Note Other Horseless Carriage.

a slightly better clearing, for his own use, to Tout Creek, some seven miles further, where the South River hill road was met. From there on the track was clearer and easier to distinguish, having been surveyed by the Bell Telephone Company, which is putting a line through to the Cobalt.

At six o'clock that night the faithful old car climbed over the last hill and down the rocks into North Bay, where no automobile had ever come or ever been expected to come by its own power. The picture shows a part of this town, with its galvanized iron covered buildings, and one of the local means of conveyance, an ox team.

By the time a hotel was reached, men, women and children had surged around the car until it was almost impossible for Mrs. Skiles and myself to get out. The children begged to sit in it, the men and women alike pulled at the lamps, the horn, or anything that looked detachable, and one curiously inclined fellow stuck his knife through a tire to see if it were solid—and that, after all those 850 miles without a puncture!

With the aid of the police a safe storage room was found where the car was left until we were ready for the return trip, three weeks later. By that time the country was so dry that the South River hill was climbed without difficulty, and with the exception of an exciting night ride through a bush fire our experiences were very much the same as in the drive north. The time, however, was shortened, requiring only four days for the return trip. The indistinctness of the picture in the heading was caused by the intense smoke from the forest fires which pervaded the whole of Northern Canada during August and September.

The courtesy with which the Canadian people treat the motorist makes traveling in their country especially delightful. Indeed, the price of gasoline, ranging from 25 to 30 cents, and the poor hotel accommodations are all one could possibly find fault with, but the latter difficulty can be overcome by carrying a cooking outfit, and preparing one's own meals.

This may not appeal to the reader as a pleasure trip, but it was to us, and certainly one full of rich experiences, besides being a genuine test for the car. Among the humorous experiences was one we had near Bracebridge, Ont., where we came very near breaking up a funeral. In fact, we came close to causing another, as one man, attempting to pass our machine, was thrown from no less than three different buggies in which he tried to ride by.

PANHARD OIL MADE AND SOLD BY G. A. HAWS.

Panhard Oil has become familiar to all automobilists through its American manufacture and marketing by George A. Haws, 73 Pine street, New York City. This manufacturer of lubricating oils and greases will have an exhibit in the Madison Square Garden show, where will be shown the various grades of Panhard oil, light, medium and heavy, and also Panhard greases for various uses.

Through an unfortunate error in the January 7 story of the Grand Central Palace show another concern was mistakenly given credit for Panhard oil success in America. A suit is now pending against a New York concern for placing an oil on the market called Panhard. All the evidence is in and a decision will probably follow in the next fortnight or so.

PLANS FOR THE SHOW OF THE SOUTHWEST.

St. Louis, Jan. 11.—The best and largest automobile show ever given in St. Louis will be held February 15 to 20 in the new Coliseum, under the direction of the St. Louis Automobile Manufacturers' and Dealers' Association. The building, which is very large, could not be better arranged for this purpose. It will permit of an artistic and convenient placing of exhibits, and in a manner which will make all spaces very desirable.

The manufacturers will do well to bear in mind that this show will mean much to them, for the reason that St. Louis and the Southwest offer an excellent market at present.

A. L. A. M. DECLARES A DIVIDEND.

At the A.L.A.M. meeting, held January 7 at the New York City offices, it was decided to pay a dividend of \$50,000 from the reserve fund of the association.

The last formality finally affecting the severance of the membership relations of the Olds Motor Works was carried out.

Col. Charles Clifton, the presiding officer, gave a talk on affairs on the other side, making it apparent that the foreign makers are feeling the effects of their inability to compete in the American market as in the past.

L. H. Kittredge, another recent foreign visitor, told of the wearing out of the French roads owing to the heavy automobile traffic. He also said that high-powered cars predominate in England, whereas in France low-powered machines are now the more numerous.

H. B. Joy, chairman of the Automobile Manufacturers' Tariff Committee, reported on the brief recently submitted to the Ways and Means Committee of the lower house of Congress. The document will be generously distributed throughout the country, for the facts therein contained are of general interest.

Present at the session were the following: Elmer Apperson, Apperson Bros. Auto Co.; John S. Clarke, Autocar Co.; W. C. Durant, Buick Motor Co.; W. C. Leland, Cadillac Motor Car Co.; H. Chalmers and R. D. Chapin, Chalmers-Detroit Motor Co.; M. S. Hart, Corbin Motor Vehicle Corp.; J. H. Becker, Elmore Mfg. Co.; W. E. Metzger, Everitt-Metzger-Flanders Co.; H. H. Franklin and G. H. Stilwell, H. H. Franklin Mfg. Co.; E. W. Headington, Haynes Auto Co.; A. N. Mayor, Knox Auto Co.; S. T. Davis, Jr., Locomobile Co. of America; H. A. Lozier, Lozier Motor Co.; H. B. Joy and M. J. Budlong, Packard Motor Car Co.; L. H. Kittredge, Peerless Motor Car Co.; Charles Clifton, The George N. Pierce Co.; George Pope, Pope Motor Car Co.; George J. Dunham, Royal Tourist Car Co.; G. E. Mitchell, Alden Sampson Mfg. Co.; R. H. Salmons, Selden Motor Vehicle Co.; Roy F. York, F. B. Stearns Co.; I. H. Page and C. C. Hildebrand, Stevens-Duryea Co.; L. J. Hart, Waltham Mfg. Co.; Thos. Henderson, Winton Motor Carriage Co.

COIL MAKERS COMBINE TO FIGHT PATENT.

The Allied Coil Manufacturers' Association is the title of a new organization that came into being as the result of a meeting held at the Prince George Hotel, New York City, by a number of representative coil manufacturers who were exhibiting at the recent Palace show. The officers are:

President, Frank Brandow, of the Jacobson-Brandow Company, Pittsfield, Mass.; vice-president, C. P. Byrne, of the Kokomo Electric Company, Kokomo, Ind.; treasurer and secretary, John O. Heinze, Heinze Electric Company, Lowell, Mass. The executive committee of the association is composed of the foregoing officers in addition to the following: Charles F. Splitdorf, Splitdorf Laboratory; F. A. Wood, National Coil Company, Lansing, Mich., and W. P. Wood, Pittsfield Spark Coil Company, Dalton, Mass.

The object of the organization is to defend the rights of its various members to manufacture, use and sell interchangeable unit spark coils, combining in order to reduce the burden of legal expense. The interchangeable unit coil as now generally used is covered by a number of patents, that involving the basis of unit construction being claimed as basic by its owners. It is this point in particular that American coil manufacturers dispute, their claim being that such patents only cover specific details and are not in any sense basic.

Those present at the meeting and the companies they represent follow: A. H. Stroud, Chicago Coil Company, Chicago, Ill.; C. P. L. Noxon, Syracuse, N. Y.; C. P. Byrne, Kokomo Electric Company, Kokomo, Ind.; C. F. Splitdorf, Walton avenue, New York; F. A. Wood, National Coil Company, Lansing, Mich.; W. P. Wood, Pittsfield Spark Coil Company, Dalton, Mass.; George Parker, American Coil Company, Foxboro, Mass.; H. G. Mears, New York Coil Company, 338 Pearl street, New York, and E. J. Huber, Duplex Coil Company, Fond du Lac, Wis.

GIVE YOUR CAR THE CARE IT NEEDS

By CHARLES D. SMITH.

WHO is to blame—is it you, Mr. Manufacturer, or is it you, Mr. Owner? To blame for what, Mr. Owner? For “knocking,” refusal to pay repair bills, incessant fault-finding with the man who looks after your best interests (whether he be a brass polisher, floor man, garage or repair shop foreman or superintendent), for literally tearing to pieces Mr. Manufacturer’s advertising, selling, repairing and manufacturing policies? If you do any of these things, Mr. Owner, you are to blame. You immediately cry, “Why! Am I not the aggrieved party?” Let us see if you are.

Incompetent Owners.

First, are you a “knocker”? You have always been a broker, baker or candlestick-maker—anything but a mechanical man. You buy a car, have a few minutes’ or a few hours’ instruction in the method of operating it and the adjustment of a few of the most important parts. But it is safe to say that, with your limited knowledge of anything mechanical, and the hundred and one new features coming to you suddenly, you have forgotten nine out of ten of the things you were told, even before you have driven your car one mile. Then some little thing (very trivial to the expert) goes wrong. You say, “It’s the machine.” Sure, it was the machine; perhaps the fault of the manufacturer, and perhaps the way you have cared for the machine. But you, Mr. Owner, ninety-nine times out of a hundred, will go back to the repair man and swear by blue streaks (and sometimes blue cuss words) that the machine has never been right since you had it and that you are entitled to a new one.

Mr. Dealer or Mr. Repairman listens to these kicks, but does he swear back? Seldom (audibly). He has expected this from you; he has had it from 95 per cent. of his customers before you, during their first few weeks’ experience with their first car. You are so mad you will hardly let him explain to you that he had already cautioned you, for example, against the coming of cold weather; that your carburetor might need slight change in its adjustment; that you should use some kind of anti-freeze solution in your water circulating system a little before you expected freezing weather. You have forgotten he told you to oil certain joints or connections in this or that place; and that you should always keep your tires pumped up.

Have you, Mr. Owner, ever neglected any of these different things, or maybe all of them, and taken it out of some one’s hide for your indiscretions? Be frank with yourselves, you owners of automobiles—’fess up; most of you have.

Have you been fair to the manufacturer? No, you have taken out your hammers and pounded him to a mass of jelly. Why? Because you are not fair with him or with yourselves. You, perchance, did not want it known that you were not proficient in taking care of your machine.

Results of Unfair “Knocking.”

What have you done? Gone to your club, to your business, among friends and acquaintances, and told them what a bum car you have. The result is that the dealers and manufacturers, who are really your good friends, lose not only your business, but that of whomever you may have influenced against your particular make of car.

But suppose now, Mr. Owner, you are a man who can be convinced; that you have brought your car in, and Mr. Dealer or Repairman has convinced you that the trouble you have is your fault, what then? This may be the tenth time you have had this same trouble, and the dealer may feel it is time he began to make charges for time or parts. You refuse to pay the bill; say the trouble should not have happened; that: “My car has been run only one month, two or three months” (as the case may be), “and is practically, if not quite, a new car. Why should I pay? I am being ‘done.’” But you do not stop to consider that you are

presented with such bills because you have forgotten, or because you did not know. If so, why should Mr. Dealer or Mr. Repairman be held up for bills you justly owe?

Think this over, Mr. Owner. You may have had this charge made against you the fifth or tenth time you came in for your repairs (true, only slight, but they cost Mr. Dealer and Mr. Manufacturer something). But, Mr. Owner, did they charge you the first four times in one case, or the first nine times in another? Be honest now—have they not been very good to you—and in all justice should you not walk up to the desk and pay your bills? You owe it honestly; so be fair with the other fellow, and do not get out your hammer and start an anvil chorus, telling Mr. Dealer or Mr. Manufacturer that if he wants his money he can sue for it. Pay up, old man; they can’t keep your car in shape indefinitely, with no charges being made against you.

Abuse of Machines.

By this time, Mr. Owner, you are thinking: “This does not mean me. My trouble was that I had a spring break while I was driving along a smooth boulevard.” Of course, you did; but do you remember that, several days before, you drove over some very rough country roads, or ran your front wheel into a bad hole in the street? That was when your spring started to go; the weight of the car was too great for the remaining uninjured spring leaves, and the spring finally let go while you were driving on a good road. You may have your car overloaded to-day, or have had since the trouble started, but now is the time Mr. Manufacturer “gets his,” because the spring gave out on a smooth street. You did not think of your overloaded car, or the bad roads, or the ride of the other day, did you, Mr. Owner? No. Well, don’t lay it up against any one but yourself.

Tests by Manufacturers.

You say it was not a spring. It was a front axle. The same ride that broke the other fellow’s spring may have been the cause of your broken axle. Don’t kick too hard, Mr. Owner. The manufacturer has driven the first one, two and often three cars made, of this same model, many thousand miles, under conditions that at times were beyond reason. The axles on these cars did not bend. They had also been well tested.

Tinkeritis.

So I might go on down the line, and let me tell you right here, Mr. Owner, ninety-nine times out of a hundred, you are to blame. You have come back with the statement that you are a mechanical man; that you have had several cars and are experienced. Quite right. But do you have trouble? Yes? Well, perhaps you are troubled with “tinkeritis.” It happens in nearly as many cases that an owner is troubled with this disease as that he does not know. A great many people are overzealous in attention to their machine. Let me tell you that the man with the “tinkeritis” habit is the hardest to deal with the auto man comes in contact with. Usually he *knows*. He does not give the repairman or the manufacturer or any of his experts the credit of being as well acquainted with machines as he himself.

What the American Maker Has Done.

Did you ever stop to think that the first American automobile was sold in 1898—less than eleven years ago? Do you remember what a crude looking machine it was? Not much like the present-day luxurious car. Was it you, Mr. Faultfinder, Mr. Knocker, or Mr. Tinkeritis, who brought about this wonderful change? No, it was the manufacturer and the men whom you have kicked against.

Let me tell you there are not twenty automobile manufacturers who have made a large amount of money, and they only from the fact of having done an enormous business. The successful manufacturer’s profits have been no more per piece than the

manufacturer who has barely kept his nose above water, but the former had the advantage of a large business. Why, then, should he charge less for his parts, if this is so. The amount of money lost by special machine tools, jigs and fixtures becoming obsolete is almost unbelievable.

Extensive Experimentation by Manufacturers.

Is the disgruntled man who is always saying that this or that manufacturer does not know his business, does not know how to build an automobile because he did not put such and such a mechanism on his latest model, and who always the the proper solution for making such models better, aware that the manufacturer against whom he is kicking, for not having these certain devices, was in the majority of cases the first maker to use the device he is howling about; that the manufacturer tried it long ago and found it inferior, a detriment rather than the valuable asset you believe it? Are you aware that the older and larger manufacturers have expensive experimental rooms and laboratories to keep up, and that they are continually building motors and cars that are never put on the market; that they are building new devices of all descriptions, hoping to get some strong feature that will be of immense service to you in your pleasure? In these laboratories dozens of coils, magnetos, timers, carbureters and other accessories are tried, not for an hour or a day, but for months. All this is done, Mr. Owner, that you may have the enjoyment that comes of a first-class car; and the manufacturer is giving you just what you are looking for—a first-class car. In fact, he is giving you a mechanical production that is far superior to anything that is a means of locomotion.

Mechanical Status and Burden of the Automobile.

Remember that your automobile travels under the vilest conditions, is handled brutally at times, yet gives you continually dollar for dollar in value, if it is handled and cared for with a reasonable amount of intelligence. The manufacturer is entitled to the credit of giving you a good, high-class automobile; and he has done it in less than eleven years.

Take the next best in locomotion—the locomotive. Have we built up in seventy-five years a locomotive that can compare with this eleven-year old child? No. How many of you have boasted that you have taken your beloved wives, children and friends on trips from one to four thousand miles and never touched a wrench to your car from the time you started until you returned? Could you ride behind a locomotive, of which most of us are proud, without a wrench being used on it in a like number of miles? I guess not.

Incompetent Chauffeurs.

Let me caution the man who hires a low-salaried chauffeur. The cheap man is the curse of the industry. The manufacturer pays big wages to turn out a high-class finished product. Why, then (if you must have a driver), do you hire a cheap man to destroy the machine of excellence? You may rest assured that if this man whom you are paying low wages is a valuable man he would be getting the top-notch wage. He would go after it, as any other man would reach out for the best. You may believe you are saving money with your cheap man. But let me tell you he is taking the life out of your car very rapidly, and the money from your coffers more rapidly still. Stop going around to your dealer or manufacturer, telling them your troubles; that they should make good this or that thing on your car. It is not their fault; you are to blame; you have a cheap man on your car.

The Local Expert and Factory Work.

We know the man who writes to the factory: "Your repairs were received and were not right. We have the best automobile expert in the State in our town, and he says this and that part is wrong," etc." Ought he to be the arbiter, Mr. Owner? He may look after or be familiar with from five to twenty-five different makes of cars. Can he be proficient on all of them? Well, hardly; maybe on none of them. The manufacturer, on the other hand, has his men trained for one make of machine, of his manufacture. You may be very sure that when your repairs

come back to you they are about right. The men in the factory repair department are not men who are here to-day and somewhere else to-morrow. They are usually men of some years' standing with their company; not only that, but they usually know their business.

Who's to Blame.

Now, Mr. Manufacturer, are you to blame? I really believe that you seldom are. You know that Mr. Knocker is wrong, because you have the names of hundreds of customers who are driving with the best results the same type machine that is complained of. Perhaps the satisfied users have had more trouble than Mr. Knocker, only they know what a machine should do.

Garage and Factory Complaints.

You, too, Mr. Faultfinder, when you go to a garage, do not try to have the men get your car out ahead of the four or five other customers waiting for theirs. They are just as important as you. Do not stamp around and make every one feel unpleasant, as no one is to blame because you came in a little later than some one else and have a wait a few minutes.

Let me say that when you, Mr. Owner (who may be the big noise in your locality), write to the manufacturer and ask him to send you a bill of goods, don't kick if they come to you C. O. D. The manufacturer has probably never heard of you.

An Ordinary Business Proposition.

Now, Mr. Owner, look the situation squarely in the face, size it up like any other business proposition, take into consideration that the automobile industry to date has produced less than twenty money-makers; that you have the best means of locomotion in the world, and you will see that the automobile manufacturer is not a grafter, all all, but a business man who is using every means at his command, from the smallest item up, whether it be his garage, manufacturing, repairing or selling departments, for your pleasure, as your pleasure means his business. You are the gainer, Mr. Owner, so why not be fair with the manufacturer? The manufacturer is not working a ten-cent game with a dollar come-back; he is giving value for every dollar received—a dollar value for every dollar you spend. So be fair with him. Learn to care for your car properly and it will then give you satisfaction.

TOLEDO DEALERS HAVE ORGANIZED.

TOLEDO, O., Jan. 4.—Toledo automobile dealers are desirous of closer co-operation, and with this in view the Toledo Automobile Dealers' Association will shortly be incorporated, formal application having already been made. Sixteen local dealers have already subscribed the corporate stock, and practically every dealer has signified his willingness to unite in the organization.

Incorporators are: A. A. Atwood, W. H. McIntyre, E. A. Kirk, S. C. Fisk, J. G. Swindeman, A. W. Morris and B. O. Gamble. While the officers have not been chosen as yet, they will probably be: President, A. A. Atwood; vice-president, W. H. McIntyre; secretary, S. C. Fisk, and treasurer, E. A. Kirk, as this selection has been endorsed by the majority.

The organization of this association insures Toledo the largest and best automobile show she has ever had.

JAIL SENTENCE FOR GRAFTING JUSTICE.

CAMDEN, N. J., Jan. 11.—Conrad Waldvogel, justice of the peace of Ancora, a small place near here, was sentenced to three months' imprisonment by Judge Joline to-day, on the charge of retaining for his personal use about \$120 which he had collected from automobile owners for alleged violations of the speed laws. Waldvogel was arrested about a month ago, when it was discovered that fines amounting to \$30 had not been turned over to the State, but because of his age and the fact that he is a Civil War veteran sentence was suspended. Later it became known that the amount involved was much greater than at first supposed, and he was rearrested, the case coming up for trial to-day.

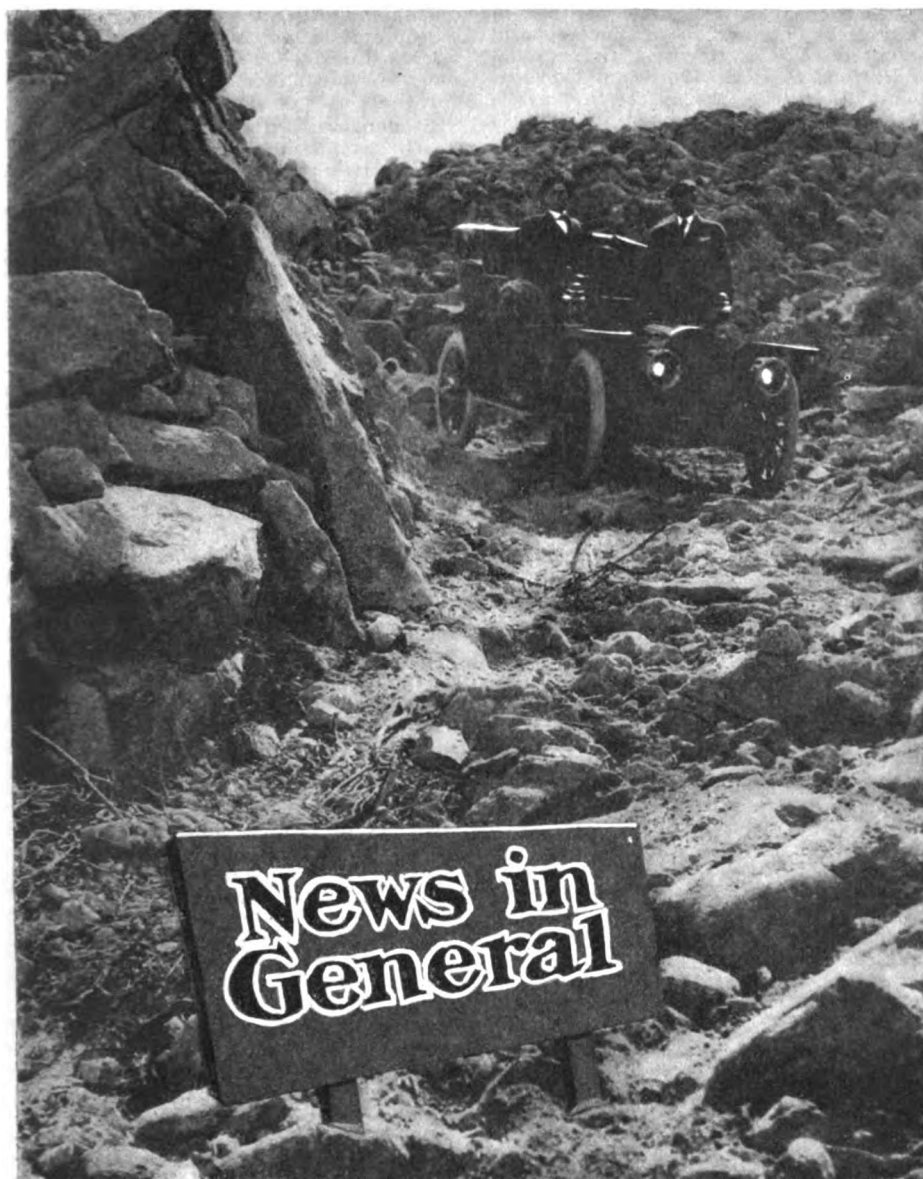

A Typical Southern California Tour.

Franklin touring car going through Devil's Canyon in the southern part of California. Never before had a car on its own power taken this trip from San Diego, through the canyon, across a desert waste, and into the Imperial Valley and back again. The trip was taken by H. M. Willard, T. E. Patterson, and Wilson S. Smith, two of whom appear in the picture. The other is handling the camera.

Adirondacks Livery Service for Lozier.—The field of the automobile is being extended every day and in every direction. Some of these up-to-date extensions are surprising and some are more—startling, in fact. Very few visitors to Lake Placid in the Adirondacks ever expected to see the passing of the well-known buckboards, yet this is almost an established fact. Three years ago, when E. R. Lozier took a touring car up in the Adirondacks, the Summer visitors and residents of that locality considered the matter in the nature of a joke, as it was thought impossible to use an automobile in that section. In order to settle all doubts on this question, one of the first stunts undertaken was an excursion over one of the worst roads with eighteen of the youngsters from the Stevens House for a fifty-mile trip through the mountains. George Stevens, of the Stevens House, was so impressed that he ordered a duplicate car for his own use, and since that time the guests of the hotel have insisted upon renting this car for trips to the various points of interest, so that he has been

unable to use the car for his own purpose. Now he will establish a rental agency and has just purchased two large seven-passenger Lozier cars for use the coming season.

Another European Invasion.—Negotiations for the purchase of three Mitchell cars, recently concluded, brought to light the fact that these were intended for a new and unique tour of Europe the coming Summer. This deal was put through by Victor Moore on the basis of a special delivery date. As planned by Mr. Moore, the touring party will include Mrs. Moore, Mr. and Mrs. George M. Cohan, Mr. and Mrs. Sam H. Harris, Mr. and Mrs. George W. Lederer and William Pinkerton. The automobiles will be shipped directly from the Racine factory to Paris, where a complement of expert chauffeurs who know all the prominent touring routes in France, Germany, Italy and other portions of the continent will be engaged. The Moore party will leave New York on the Lusitania about the middle of May and the continental start will be made from Paris about June 10. The limousine will be

included in the appointments of this unique automobile train as a precaution against emergencies in districts that lack café accommodations, Shero, the Japanese servant of Mr. Moore, having signed to do the cooking.

Gabriel Will Invade Europe.—Owing to the fact that exhibitors of sundries will not make exhibits throughout the various shows in the United States after the National shows, it will be impossible for the Gabriel Horn Manufacturing Company of Cleveland to exhibit its immense instrument, containing 37 horns, and playing a full $3\frac{1}{2}$ octaves. For this reason Mr. Foster has been deluged with offers from various promoters for the use of the horn with M. Lusk, the musical expert, as the operator. He has already made arrangements with Rochester, Kansas City and several other cities, and this big horn will be steadily employed from now until the close of the show season. At the conclusion of the season it is the intention of Mr. Foster to take the big horn to Europe, there to tour through England, France, Germany, Switzerland and Italy, in all of which countries the horn is very popular. Mr. Foster received from the Paris show alone orders for 550 horns, and recently filled an order for several thousand in London.

Says R. E. Olds: "Rarely does an automobilist realize the tremendous amount of painstaking detail that enters into the average automobile. I venture to say that very few owners of automobiles could guess within a thousand pieces that enter into their cars. By our systematic division of building and assembling the multitude of parts in every Reo we can instantly trace any defective part to the man at fault. Knowledge of this fact on the part of every mechanic whom we employ places him on his individual responsibility. This is true with every man from the foundry to the assembling department; to the testing tracks and trestles and finally to the experienced shipping crew whose duty it is to see that every car is properly blocked and crated before delivery is made to the transportation companies. This, in a measure, explains why every Reo car unloaded at its destination can be started with a half turn of the crankshaft and immediately run under its own power."

Body Builders Prosperous.—The Bridgeport Vehicle Company, one of the largest of the fine coach builders, which made Bridgeport, Conn., famous for this kind of work, has recently turned its attention to the construction of automobile bodies. So successful has it been in this line that the plant at Water street and South avenue has been outgrown. To provide for present and future needs ground has been broken at Fairfield and Holland avenues for a three-story brick building 88 by 160. This handsome structure is expected to be completed, ready for occupancy, July 1, when it is expected that the present force of seventy men will be doubled. The officers of the company, with a showroom for the displaying of six cars, will be in the Fairfield avenue side of the building. The concern will install its own power plant and an elevator. The officers of the company are: President and treasurer, Harry D. Miller; vice-president, H. F. Brandes; secretary, George C. Miller.

Growth of the Jackson.—President G. A. Matthews, of the Jackson Automobile Company, in speaking of the coming year, said: "During the last year we have erected and moved into one of the finest plants in the West. The new fac-

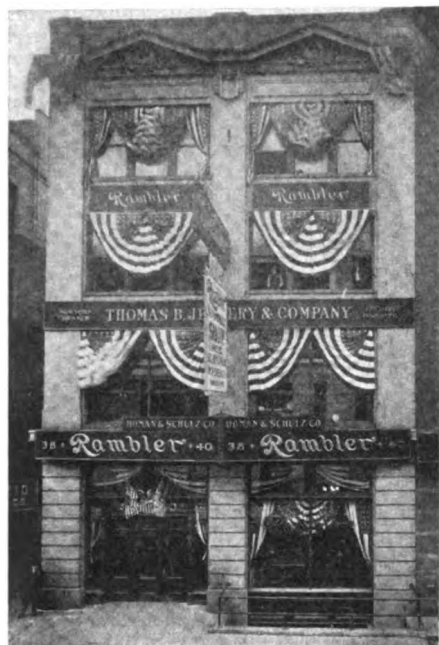

Rambler New York Branch.

The New York branch of Thomas B. Jeffery & Co. is located at 38-40 West Sixty-Second street, where the entire line of 1909 Ramblers are on exhibition and serve as a special attraction during the Garden show, the same as was the case during the Palace show. This company believes in having an exclusive show, and it would appear from the results claimed that it is a most satisfactory plan.

tory is located at Jackson, Mich. It utilizes 210,000 square feet of floor space, made up of a four-story building, 600x50 feet; a two-story building, 300x100 feet, and a drop forge shop of 30,000 square feet. The Jackson output this season will be 3,500 cars. The first of the 1909 cars appeared in September and 400 of them have already been shipped to agents. Present production is eighty-five per day, which early in the new year will be raised to 100. In the neighborhood of 1,500 men are employed, who work also four nights a week. We make practically the entire car, forgings, engine, bodies and wheels being manufactured at our big plant in Jackson."

A Continental Luncheon.—During the Grand Central Palace show one of the family trade luncheons was that of the Continental Caoutchouc Company, held in the Indian room at the Hotel Astor. Of course, there was a good deal of discussion of Continental tires and demountable rims, and the representatives and sales force expressed themselves interestingly and thoroughly, the summing up being of general all-around good. Joe M. Gilbert, the general manager, was the toastmaster of the occasion, the others present being the following: P. O. Eckhardt, J. H. Sheldon, S. S. Poor, J. B. Cothran, B. D. Hart, James L. Gibney, John Gibney, A. L. Risley, E. E. McMaster, James Patterson, E. L. Thompson, W. A. Wattenschedit, F. C. Robie, H. W. Lester and Messrs. Gray and Eccleston.

Motor 'Bus for Arctic Circle.—When a motor truck company can sell its goods on the same day to representatives of two different countries, where climatic conditions and the roads are radically different, it is a good demonstration of the fact that the general utility of the commercial vehicle has been proven beyond a doubt," said Morris Grabowsky, of the Rapid Motor Vehicle Company, of Pontiac, Mich. "On the same

day that I sold five Rapids for use in Helsingfors, Finland, ninety miles from the Arctic Circle, I sold a sixteen-passenger 'bus to Rietz Horns, of Corona, Spain. This 'bus goes by the first available boat and will be used in the extremely mountainous sections of the country."

Champion Cyclist Becomes an Autoist.—Frank L. Kramer, of East Orange, for the past eight years the champion cyclist of America, has become an autoist. During the recent Palace show he bought for immediate delivery a 1909 \$2,000 40-horsepower Jackson runabout. The car will be Jackson green, upholstered in pigskin leather, and it is possible that the cycle champion may want to try his hand in various automobile contests.

Used the 1908 Maxwell-Briscoe.—In the advertisement of the Maxwell-Briscoe Motor Company which appeared in THE AUTOMOBILE of January 7 an illustration of a 1908 Maxwell model car was used in error in place of the model of the present year. The 1909 Model DA is fitted with a magneto, gas headlights and a generator as part of its regular equipment, which means a very substantial difference to the purchaser of a car.

A Continental Announcement.—The Continental Caoutchouc Co., 1788-90 Broadway, New York City, announces that all Honover interests formerly held in their company have been purchases, and hereafter Continental material will be marketed by American interests only.

Correction in Cameron Advertising.—On page 98 of the advertising section, December 24 issue, a typographical error gave the price of the Model 16 Cameron touring car as \$1,000, when in reality at the correct price of \$1,100 the makers are giving unusual value for the money.

IN AND ABOUT THE AGENCIES.

Franklin.—The H. H. Franklin Mfg. Company has appointed the following agents for the coming season: Trenton, N. J., Munro & Engle; Sharon, Pa., Fruit-Ohl Company; York, Pa., J. W. Richley; Charleston, W. Va., Charles E. Ward; Youngstown, O., Standard Auto Garage Company; South Bend, Ind., Otis Motor Car Company; Seattle, Wash., Seattle Automobile Company; San Antonio, Texas, Mark V. Haley; Beeville, Texas, Beeville Automobile Company; Shawnee, Okla., T. F. Bruber & Company; Shreveport, La., L. W. Huckins; Savannah, Ga., T. A. Bryson; Cocoa, Fla., S. F. Travis & Company.

San Francisco.—A number of automobile agencies have leased the property on Van Ness avenue, between Birch avenue and Fulton street, and will erect a one-story brick building to be used as a garage. Among the companies interested in the scheme are the Maxwell agency, the Mobile Carriage Company, the Pierce-Arrow agency, the Pacific Taxicab Company and the Continental Tire Company. The building is to be ready for occupancy early in March.

Western Agents Expand.—J. W. Leavitt & Company has leased for a term of years the large lot at Golden Gate avenue and Hyde street, San Francisco, and will erect a new building. This company is the agent for the Reo, Stoddard-Dayton and other well-known cars.

Rambler, Cleveland.—Thomas B. Jeffery & Company have opened a branch in Cleveland at 2558 East Ninth street in the quarters formerly occupied by the T. C. Whitcomb Automobile Company.

Oakland, Allentown, Pa.—The Lawler Automobile Company has secured the agency for the Oakland car. This company was also recently appointed agent for the Chalmers-Detroit.

Studebaker, Pittsburg.—B. F. Benson has been appointed agent for the Studebaker car in Western Pennsylvania and will erect a garage on Craig street, near Luna Park.

Pope-Hartford, Kansas City, Mo.—H. Holzhauser has been appointed agent for the Pope car and will open headquarters on Grand avenue.

Knox, Philadelphia.—The North Philadelphia Auto Station at 3425 North Broad street has taken the agency for the Knox.

American Locomotive, Des Moines, Ia.—The agency for the American Locomotive has been taken by Grover Hubbell.

Jewell, Kansas City, Mo.—The Rhodes Implement Company has taken the agency for the Jewell line.

PERSONAL TRADE MENTION.

Carlton R. Mabley, one of the pioneers in the automobile industry, long and prominently identified with the importation of Panhard, Renault, Mercedes and other automobiles of note, during the palmy days when the firm of Smith & Mabley was a power in the trade, and the instigator in the organization of the Smith & Mabley Mfg. Company, now the Simplex Automobile Company, will take the general management of the Post Motor Company, 1620 Broadway, New York City, which will have the New York agency of the Hart-Kraft delivery wagons. Mr. Mabley was prominent in the exhibition at the Grand Central Palace, just brought to a successful termination.

Henry Souther.—Announcement is made that Henry Souther, the well-known engineer, has been secured by the Standard Roller Bearing Company, Philadelphia, to devote a large part of his time to its interests as consulting engineer. Mr. Souther's services have recently been employed to some extent by this company in this direction, and the above arrangement is the outcome of the results obtained in the betterment of its product.

Charles Schmidt, when interviewed recently regarding the report that he was to sever his connection with the Peerless Motor Car Company, said: "The last contract has several years still to run, and I feel no differently in the matter than at the time of signing it. My relations with this firm have always been of a very satisfactory nature, and I have no present or future intention of terminating this connection."

E. R. Thomas, of the E. R. Thomas Motor Company, Buffalo, accompanied by Mrs. Thomas and their daughter, last week sailed for an extended European trip. Mr. Thomas said before sailing that it was the first vacation he had had in many years, but he went away with the comfortable feeling that the industry was assured of the most satisfactory season since its beginning.

Alfred Reeves, general manager of the A. M. C. M. A., this week is enjoying a well-earned rest at Atlantic City, whither he and F. J. Wagner went on Saturday last accompanied by their families. L. M. Bradley, the general manager's assistant, is visiting his old home in Worcester, Mass.

William F. Legg, a graduate of Cornell University and formerly with the E. R. Thomas Motor Car Company, Thomas B. Jeffery Company and the St. Louis Car Company, has taken charge of the factory of the Carter Motor Car Corporation at Hyattsville, Ind., as superintendent.

Added to the E-M-F.—Two more "leads" and one understudy have been added to the E-M-F organization. These are James Heaslet, whose title is chief engineer, and Harry L. Cunningham, who has assumed management of the E-M-F company's Detroit retail branch

Archie McLachlan, who has been in charge of the Chicago branch of the Royal Tourist Company for the past six months, is to return to Cleveland, where he will take up his former duties as sales manager of the Royal Tourist Company.

W. W. Partridge, formerly at the Stearns factory, has joined the sales force of the Tebean Motor Car Company, which has the Kansas City agency for the Stearns car.

SOME BUSINESS CHANGES.

Powell Supply Company, Omaha, Neb.—This is the new name since January 1 of the former Powell Automobile Company of Omaha, Neb. On that date, also, they removed from 2010 Farnam street to 2020-2022 Farnam street, where they will have about three times the floor space previously available. The change in name was made because it was a misnomer, the company never having handled cars, but devoted itself to supplies exclusively.

Utility Company, New York City.—The Utility Company, 636 West Forty-fourth street, New York City, manufacturers of the "U K O" mica spark plug, have taken over the business and goodwill of the spark plug department of the Richardson Engineering Co., Hartford. Its plug was called the "Rich-Spark" and followed the "U K O" closely in general design.

Cameron Sales Company, Beverly, Mass.—The general sales offices of the

Cameron Car Company of Beverly, Mass., manufacturers of the well-known air-cooled cars, have been taken over by the recently organized selling agents, the Cameron Motor Company, of New York. All correspondence relative to sales should be addressed to the offices at 231 West Fifty-fourth street, New York City.

Top Companies Consolidate.—The L. L. Lamien Auto Top Company and the Iroquois Auto Top Company, of Utica, N. Y., have consolidated and in the future will do business under the latter name.

BUSINESS TROUBLES.

New York City.—A petition in bankruptcy has been filed against the Automobile Coaching Company, of 147 Spring street, in which it was alleged that they made an assignment on December 1 and transferred \$3,000 worth of assets. This petition was filed by Louis Ginsberg as administrator of the estate of David Ginsberg on a claim of \$2,361 judgment obtained May 22, 1908, for the death of David Ginsberg. Schedules in the assignment filed recently show liabilities of \$13,531, nominal assets of \$80, and actual assets of \$24.

NEWS OF THE GARAGES.

Bridgeport, Conn.—It is announced that the garage and agency business of the Blue Ribbon Auto and Carriage Company has passed into the hands of a new company, and will hereafter be known as the Blue Ribbon Garage. The latter will continue the agencies maintained by the former, which include the Packard, Cadillac and Franklin cars.

Hartford, Conn.—R. D. & C. O. Britton, local representatives of the Maxwell and the Stoddard-Dayton, have practically completed their remodeled garage on Allyn street and are now moving in. The concern will now be in a position to care for the increasing trade. The outlook for both cars is very good.

New York City.—The Riverside Garage Company announce the opening of a

new garage at 202 West One Hundred and First street, New York City. The building is new and absolutely fireproof, with floor space for 200 cars.

Hutchison, Kan.—This town is to have a new and up-to-date garage. The Taylor Motor Car Company has leased the new structure at 29-31 East Sherman avenue, which is to be 50x150 feet.

Prady, Tex.—Sheridan & Wade, who are starting in the automobile business, have leased a large lot near the post-office and will erect a garage.

Philadelphia.—W. H. Schofield & Son has opened the New Camac Garage at 250 South Camac street.

JONES SPEEDOMETER DINNER.

Saturday night, January 9, the New York representatives of the Jones Speedometer Company gave a beefsteak dinner in Healey's "Log Cabin," at Broadway and Sixty-sixth streets, to a few friends and out-of-town Jones agents who were in the city. All discussion of a business nature was tabooed, the occasion being simply a social gathering, with everyone doing full justice to the ample layout provided.

The list of guests included Gaston Plantiff, manager of the New York branch of the Ford Motor Company; Col. K. C. Pardee, of the Maxwell-Briscoe Company; G. A. Wahlgreen, Denver; C. O. Sacks, president Rowland Advertising Company; J. A. Clark, Peerless Motor Car Company; E. B. Jackson, of the Packard Motor Car Company, and Harvey Adams, of the Auto Supply Company. Among the Jones representatives were General Manager G. L. Holmes and Sales Manager E. P. Nussbaum, of the New York branch; F. G. Dwight, manager of the Philadelphia branch, and R. C. Peet, Western representative.

The others present were: F. H. McFarland, W. J. Turp, A. C. Nichols, A. W. Owen, W. C. Boome, Thomas Boome, C. A. Kline, P. S. Barrett, Mr. Steckle and A. C. Howell, whose introductions of the speakers were a feature of the function.

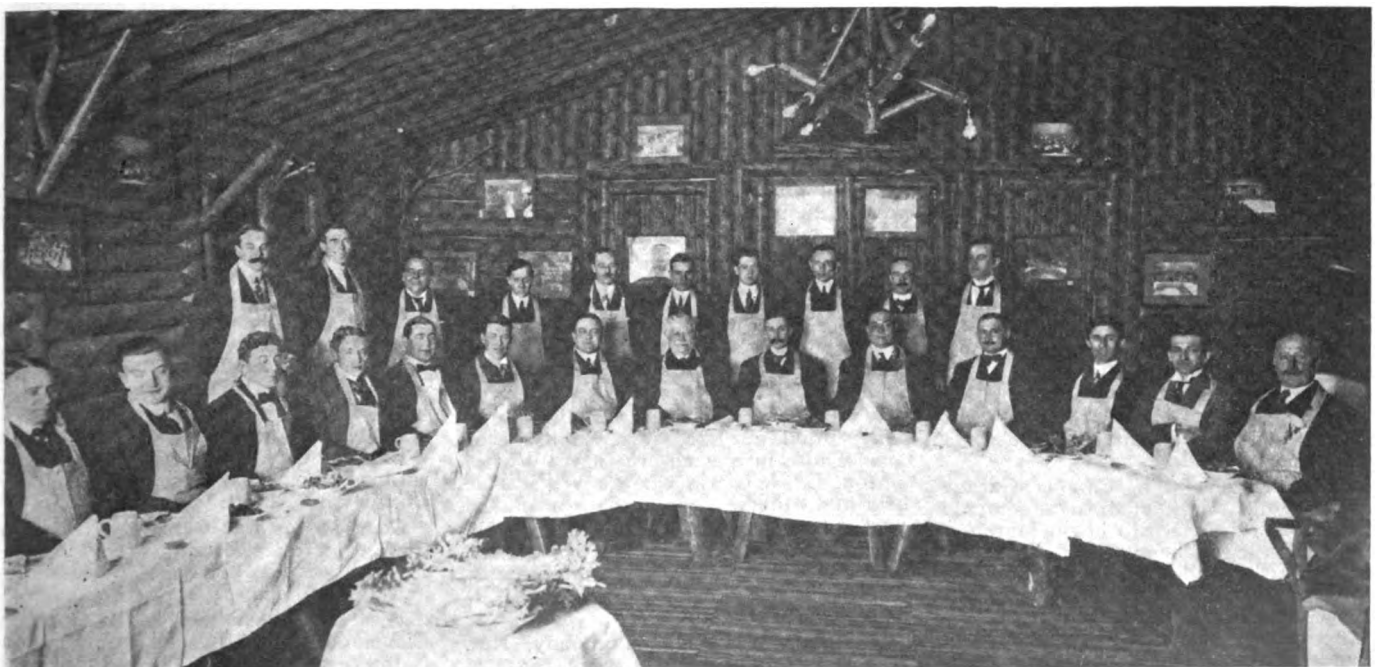

Jones Speedometer Representatives and Friends Enjoying Beefsteak Dinner at Healy's "Log Cabin," New York City.

TAXICAB AND TRANSIT.

New Cab Service.—It is said that a prominent automobile manufacturer is backing the project to start a taxicab service over the Queensboro Bridge, New York City, as soon as it is open to traffic. It is likely that it will be a year or more after the opening of the bridge before the trolleys are running, and an auto service would prove very profitable as well as convenient. The New York and Queens County Railroad is willing to allow the service.

Wyandotte, Mich.—Edwin A. George and G. W. Blake, both of this city, are the backers of an auto express service which is to be maintained between Detroit and western suburban points, including River Rouge, Delray, Wyandotte, Trenton and other adjacent territory. A number of Grabowsky power wagons are to be used, and a central collecting station is to be maintained in Detroit. The service will probably start February 1.

Four Wheel Drive Auto for Duluth.—The Four Traction Auto Company of Mankato, Minn., has received the contract for a police patrol to be delivered to the city of Duluth. This product has a three-speed transmission, which delivers power to all four wheels, which superior traction will be necessary on the city's bad hills. The body will be equipped with an ambulance outfit comprising stretcher and Red Cross outfit.

Schenectady, N. Y.—The Winter schedule of the P. R. & S. Transportation Company has been discontinued and will not be resumed until suitable Winter tops can be secured for the machines. Specifications are now being prepared for regular Winter cars, and it is also the intention of the company to put on three new cars in the Spring. It is likely, also, that lines will be started to South Schenectady and Burnt Hills.

Pittsburg, Pa.—J. L. Shearer, Jr., of Harrisburg, who was one of the prime movers in the organization of the taxicab service there, is interested in the formation of a similar concern here. Application for a broad charter will be made, and the city will be covered by an extensive system. There will, however, be no connection between the two companies.

Asbury Park, N. J.—A taxicab company is being organized here to maintain an all-the-year-round service at the leading hotels. Among those interested in the company, which has a \$25,000 capitalization, are Michael E. Sexton, Milan Ross, Dr. T. H. Pratt, and others. In the Winter time a central station service will take the place of the more numerous Summer stands.

Los Angeles, Cal.—F. M. Hoblitt, who is representing the American Berliet Locomotive Company, is looking over the local field with the intention of running an automobile freight line from this city to Wilmington, Cal. A regular schedule is to be maintained and a company will be organized to look after the business at this end of the line.

Lexington, Ky.—The Phoenix Garage Company has completed arrangements for a cab service here to begin March 1. These cabs have been ordered by the company, who will have their headquarters in the Phoenix Hotel Building. The fares charged and taximeters used will be the same as those used in New York City.

Marshfield, Ore.—William Wade and Thomas Goodale, of Marshfield, Ore.,

have formed a partnership to start an auto 'bus line between that city and Roseburg, a distance of 65 miles. They have purchased three eight-passenger Thomas cars, which will be put into service at once.

Hartford, Conn.—A taxicab line will be inaugurated by R. D. & C. O. Britton, local Maxwell agents. Four-cylinder Maxwell chasses will be used for the purpose. At present there is nothing of this sort in service, though several liverymen have done a good trade in motoring livery.

Pittsburg.—Application will shortly be made for a charter for a new concern, to be known as the Pittsburg Taxicab Company, which is to run a general taxicab business. Weil & Thorpe are the solicitors.

Allentown, Pa.—Arthur A. Barber is to go into the auto livery business the first of the year. He has prepared to make his headquarters with the Berwin Automobile Company on North Eighth street.

Los Angeles, Cal.—The Needles-Parker Transportation Company has established an auto 'bus line between Needles and Parker, which will maintain a regular schedule in conjunction with the Santa Fe Railway.

Wilkes-Barre, Pa.—The Scranton Automobile Company will install a taxicab service in Wilkes-Barre beginning January 1, a satisfactory arrangement having been made with the Posten Transfer Company.

New Bedford, Mass.—A taxicab service will be established on January 1, using the same cab and taximeter now used in Boston, the charges for the services being similar.

Philadelphia.—Application is to be made for a charter for a new company, to be known as the Theobald Motor Car Company, which will deal in motor cars and accessories.

RECENT INCORPORATIONS.

The Northern Motor Car Company, Detroit, Mich., has filed articles at Lansing decreasing its capital stock from \$500,000 to \$1,000. The Northern Motor Car Company has been practically dissolved since the consolidation with the E.-M.-F. Company, but the nominal capital will keep the concern in existence until all debts are paid.

Winchester Automobile Company, Winchester, Mass., capital stock \$10,000, and will do a general automobile business. Incorporators: C. E. Tedford, of Boston, who is president, and George O. Fogg, of Winchester, treasurer.

Manhattan and Essex Auto Express Company, Newark, N. J., capital stock \$100,000, and will do a general transportation business. Incorporators: O. M. Jackson, C. M. Hammell, Newark, and V. S. Richardson, of East Orange.

Worthington Clark Automobile Company, Fond du Lac, Wis., capital \$20,000. Those interested are G. W. Worthington, E. N. Clark, George W. Stanchfield and others.

The Tourist Auto Car Company, Niagara Falls, N. Y., capital stock \$10,000, and will operate and rent automobiles. Incorporators: J. H. Bridges, E. N. Wheeler and S. C. Fagard.

New Haven Taxicab Company, New Haven, Conn.—Capital stock, \$25,000. George G., Peter C. and Robert G. Nesbit.

NEW INCORPORATIONS.

Savoy Auto and Taximeter Cab Company, Far Rockaway, N. Y., to run a taxicab service in the Rockaways. The incorporators and officers are: President, M. Katz; vice-president, L. T. Walter, Jr.; secretary, R. S. Smith; treasurer, F. Fitter, Jr.

Nightingale Whistle Manufacturing Company, New York City.—Capital stock, \$1,000. Will manufacture whistles for automobiles and motors, tire inflators, air compressors, etc. Incorporators: G. Stoddard, E. L. Keer and E. H. Carpenter.

Kennedy Ideal Carbureter Company, Boston.—Capital stock, \$25,000. Will do a general automobile business. Incorporators: J. C. Kennedy, of Newton, who is the president, and W. E. Spear, of Boston, treasurer.

Marathon Automobile and Garage Company, New York City.—Capital stock, \$1,000. Will do a garage and storage business. Incorporators: R. G. Berille, W. C. Wyckoff and P. G. Chedbum.

American Motor Cycle Company, Chicago, capital stock \$15,000, will manufacture and deal in motorcycles and automobiles. Incorporators: W. H. Hess and A. J. Musselman.

Model Automobile and Garage Company, Belleville, Ill., capital stock \$2,000, to operate a garage and manufacture autos and accessories. Incorporators: Joseph and E. L. Schwarz.

Dillard Delivery Company, Brooklyn, N. Y.—Capital stock, \$2,000. Will manufacture wagons, carriages and automobiles. Incorporators: J. A. Dillard, H. B. Lyons and O. F. Fix.

Scientific Research Company, New York City.—Capital stock, \$100,000. Will manufacture automobiles, motor boats, etc. Incorporators: A. E. Ranney, A. M. Day and A. J. Robinson.

Summit Motor Car Company, Summit, N. J., capital \$5,000, to manufacture automobiles, bicycles and supplies. H. H. Day, Harry Baldwin and Rosalie Nelson are the incorporators.

Lake Avenue Auto Company, Cleveland, to do a garage and jobbing business. President, James Fleming; vice-president, John C. McLean; secretary, Albert Redmond.

Juruick Auto Company, Brooklyn, N. Y., capital stock, \$5,000. Will manufacture automobiles, etc. Incorporators: M. F. Juruick, L. R. Smith and Anne Juruick.

Carl Klemp Company, Chicago.—Capital stock, \$2,100. Will manufacture automobiles and accessories. Incorporators: Carl Klemp, H. T. Kett and T. E. Rooney.

Vanguard Mfg. Company, Joliet, Ill.—Capital \$25,000, will manufacture automobiles and accessories. Incorporators: C. F. Jensen, C. N. Steinhart and N. L. Hurd.

Overland Automobile Sales Company, Oklahoma City, capital \$10,000. Incorporators: Jerome Harrington, Will G. Brown and Alta E. Funk.

Cory Motor Car Company, Oklahoma City, capital \$25,000. Incorporators: C. P. Cory, C. D. Crouch, W. E. Crouch and W. L. Peck.

Western Reserve Motor Car Company, Cleveland, capital \$50,000. John H. Price is interested.

Automobile Motor Boat Company, Jefferson, O., capital \$10,000.

THE AUTOMOBILE

Garden Show
Undeniably Gratifying

Artistic
and
Impressive

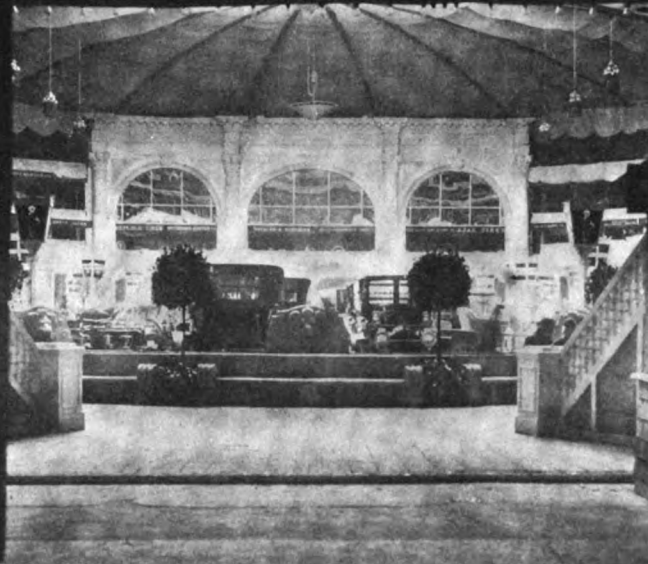

Attendance
Indicates
Interest

AMERICA'S automobile industry is in its tenth year. To the man who saw it in its swaddling clothes, noted when it began to creep, next how it actually walked, and finally experienced elation at its exultant strides, there is much that is gratifying and impressive in this ninth exhibition of motor-driven vehicles in Madison Square Garden. The chapters that will follow in automobile history will be more gradually accumulated and possibly with less blaring of trumpets and still just as adequately satisfying. While it is unquestionably true that the greater part of the firms occupying spaces in the Garden do not produce what are termed "popular" cars, the fact is plainly evident that these confidence-inviting concerns are assured of a prosperous year, in the conclusion of which there will be little, if any, of their outputs still seeking 1909 customers. The fear that is expressed by many is that the prosperity of the moment may cause undue preparations for another year, which might then exceed the figures computed in this present period of roseate hue. One's optimism should always have a safety valve at hand.

Unpropitious weather and ice-bound streets, as if the storms of the universe came to see the beginning of the show, ushered in the opening Saturday night, January 16, bringing along the whirl of the wind and the scenery of the poles. Despite all the inclemency that the weather heaped up, the A. L. A. M. show started in a swirl of glory, for the patrons of the industry were there in force to witness the very sight that some have it crossed the line of vision of George B. Selden in the year

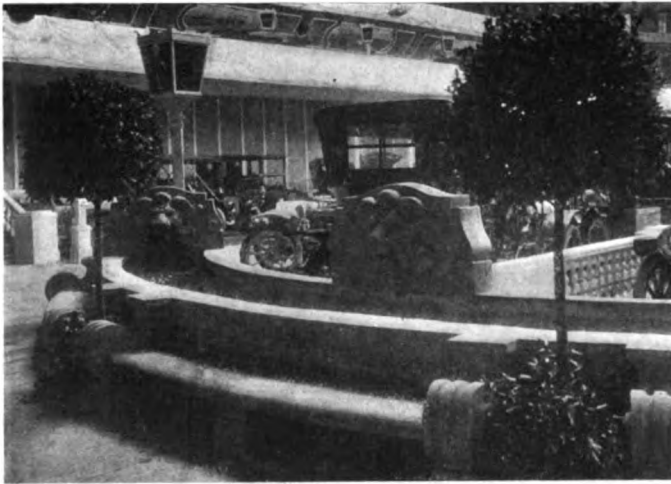

Where Tired Patrons Find Rest from Labors.

1879. This single model of that year would scarcely feel at home in the company now strewn around the big building, unless it is that age lends vigor and the right to glory in the improvements wrought.

Tremendous as the development is, as the evidence at the Garden amply indicates, it is not so great as to blind the men who did the work and stood the brunt of the fiercest battles to the fact that back of the show is the force which made it possible, and that this same force must be added to as time wears on. This force is not alone in the cars at the Garden, nor is it concentrated at the shops in which the cars were turned out. It is the combination of the cars, the shops, and the patrons of the industry.

After the first night, which was a typical first night according to the fashion "Manhattan," the patrons were of the class who come to see what the "craft" has to offer by way of improvements and as a result of the experiences of a year before, which must go down in history as a world-beater from the point of view of "hard" money and a big scare for every business but the automobile. Why the automobile should have side-stepped the drubbing is a question never to be understood by anyone outside of the charmed circle, if indeed the wise of the fraternity may not go a little astray when it comes to a clear statement of fact.

Whatever the reason, laying aside all the pros and cons, it is still to be seen that the A. L. A. M. has been a power in the trade which can be looked upon as a "balance-wheel" of no mean

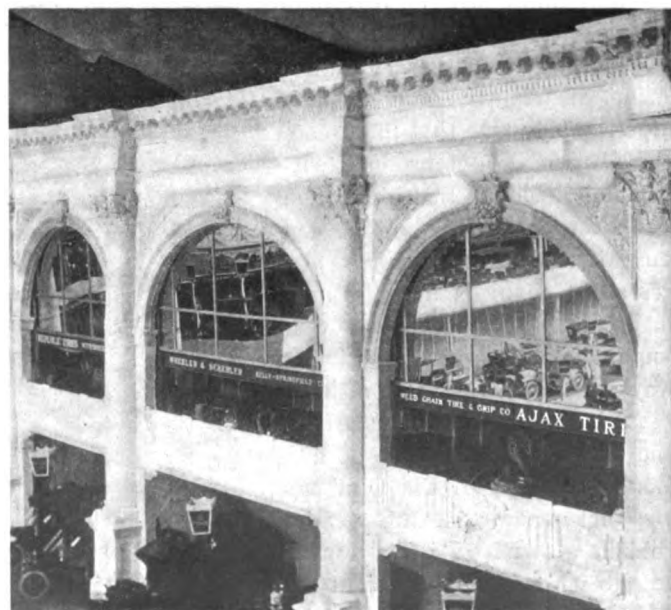

This Gives Idea of Garden's Attractiveness.

purport. That the trade needed a "leveler" may not be realized to its fullest force, merely because the ship of fortune "docked" on time and in its hold were found all the voyagers in good financial health. Likewise it is to note that the buyers of cars, the absorbers of the product, toe the scratch with a glow of good health in their cheeks and an eye sparkling which is not the property of a fagged-out "hasbeen."

The former supporters of the industry, during the days when men of ordinary means or business acumen declined to risk a purchase, made bold to visit the haunts of their earlier exploits, and as a result it is pleasant to note that "Society" went to the show. There is no denying the fact that the automobile industry owes much to the earlier buyers of cars, buyers who paid a large price for what they received in turn, and at a time when the industry was much in need of "extravagant" methods; the extravagance, of course, coming mostly from the patrons of the industry. It is therefore a duty, as well as a pleasure, to report the continued interest of the very supporters of what was but an infant industry within ten years.

In view of the fact that the trend of the industry is adequately discussed elsewhere in THE AUTOMOBILE, it will be more to the point to confine the introductory matter to the features at the Garden as they intercept the eye of the visitor. One of the main schemes was to render the appearance of the show less crowded than was the case formerly. It is conceded that the plan was such as to lend color to the scheme. Then it was desired to prevent "bunching" of the visitors, as was the case in some of the earlier exhibits, due to placing the cars in such a way that the ones the visitors took the most interest in were in close proximity to each other.

By spreading the cars out in such a way as to prevent "bunching," it was also possible to do justice to all. It is a fact that interest oftentimes lies in what may be called an obscure exhibition, and the patrons will miss the very car they would be delighted to see under the old plan. Then the arrangement this year was by way of greater chance of seeing the cars. True, it is not uncommon to hear some of the spectators express the opinion that many go to the Garden to see many more. Supposing they do, it is also a fact that they go to see the cars, and it is of the greatest advantage to enable them to have a look, and a good one at that.

The crowd has been coming since the opening night, and each day the attendance figures have increased until the Garden capacity was only obtainable through increased compression. The wise man visits the Garden early, though he seems to find that other wise men have preceded him in generous quantities. All in all, it is a reassuring show and one that marks another epoch in the automobile's progress.

These statistics of the Garden show tell a story which will be most interesting to the man who delights in figures:

Gasoline.	Commercial.	Electrics.
Complete cars....117	Complete cars.....19	Complete cars.....37
Complete chassis. 28	Complete chassis.. 5	Complete chassis.. 5
	Taxicabs 8	
Bodies.		Motors.
Seven-passenger touring..... 20		Water-cooled138
Five-passenger touring..... 23		Air-cooled 7
Two-passenger runabout..... 3		Four-cycle140
Three-passenger runabout..... 8		Two-cycle 5
Four-passenger runabout.... 10		Eight-cylinder 0
Toy tonneau 21		Six-cylinder 25
Limousine 17		Four-cylinder116
Landaulet 8		Three-cylinder 3
Town car 4		One-cylinder 1
Miscellaneous 2		Cylinders cast in pairs..... 96
		Cylinders cast separately.... 41
Clutches.		Cylinders cast en bloc..... 6
Cone 56		Cylinders cast in threes..... 2
Multiple disc..... 56		
Expanding 22		Ignition.
Contracting 10		Jump spark.....125
		Make-and-break 20
Gearsets.		
Selective131		Jump Spark System.
Progressive 13		Double 48
Planetary 1		Dual 56
Friction 0		Single 21
On rear axle 14		H-T magneto..... 75
Unit with crankcase..... 5		L-T magneto..... 15
As separate unit.....126		Storage battery..... 79
		Dry cells..... 59
Final Drive.		
Shaft122		
Side chain..... 22		
Single chain..... 1		

January 21, 1909.

THE AUTOMOBILE.

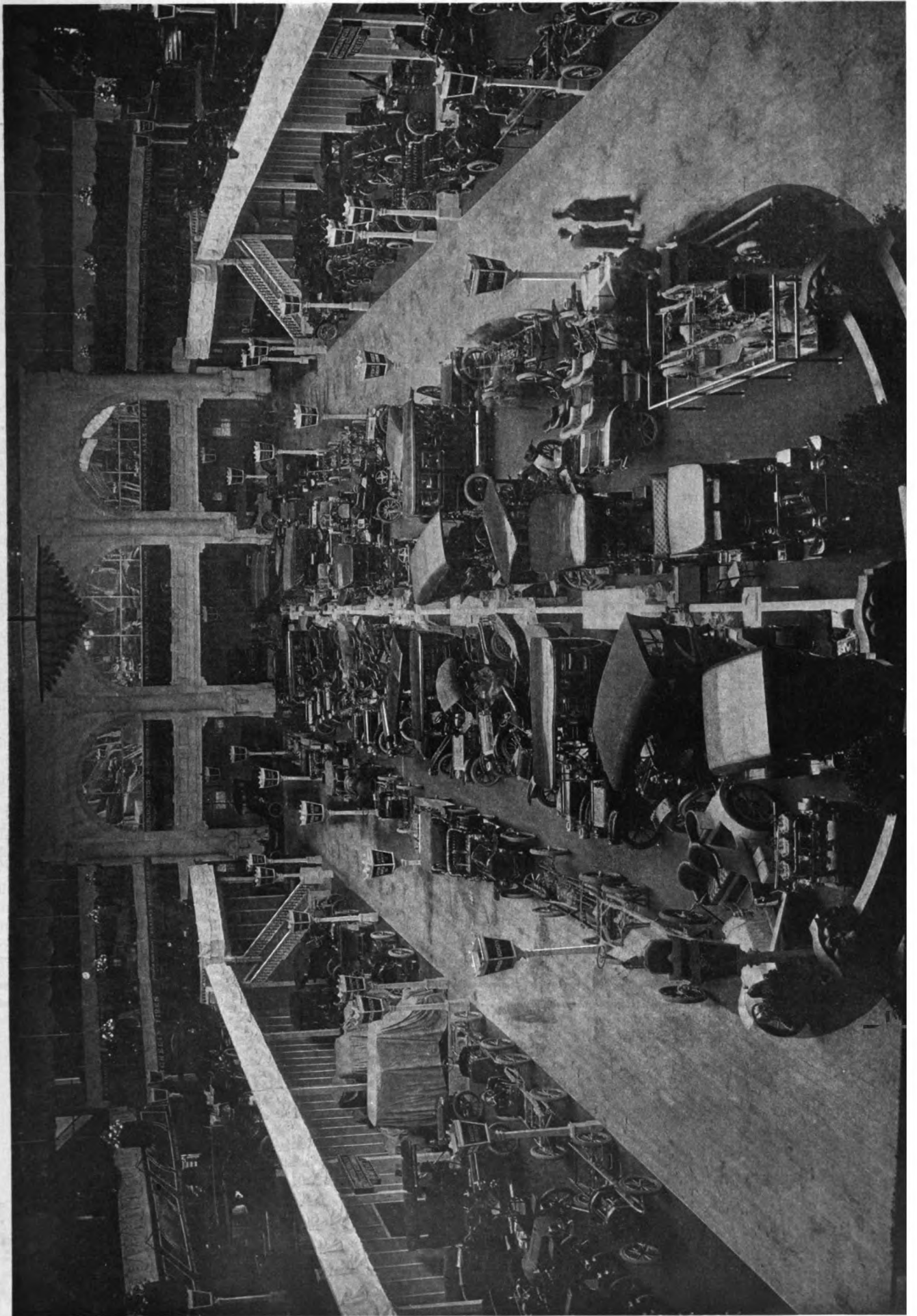



IN ENGLAND
1830



HAYNES
APPERSON



APPERSON
1904

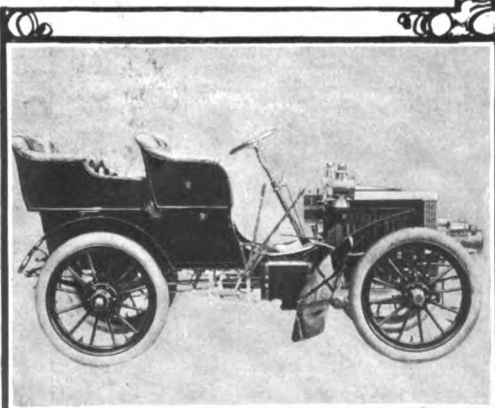

PEERLESS

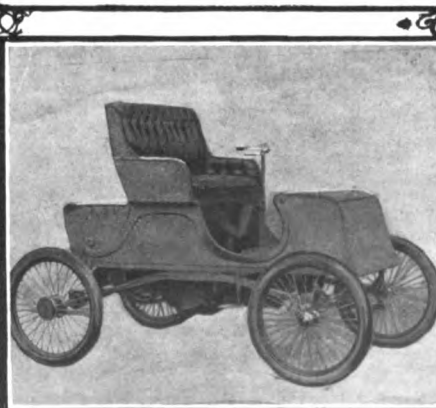

KNOX 1902

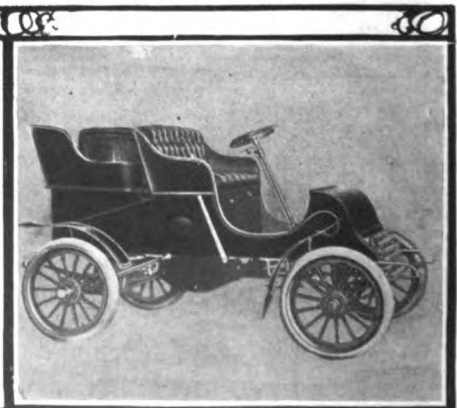

CADILLAC

UNLIKE the Oriental, the vigor of the present is upon us, the future looks bright, the potentiality of things accomplished presses, and, if a pause is made, it is for the purpose of taking stock, thereby to locate the advantage of things accomplished on the end of the lever.

Taking the cars at the Garden as the subject, allowing that for the most part they are the product of pioneers, while they are all there assembled it will be the more easy to observe the difference between what they are and the rude contrivances from whence they came. But in order to illustrate the advances made it will be necessary to refresh the memory with illustrations of automobiles long since reduced to inactivity. If they are captives of retirement, they are also the milestones measuring the distance which progress has made, and by contrast these same evidences of the pioneers lend zest to the comparison.

Without going back to the Noah's Ark of automobiles—this is not to be a history—it will be fair to allow that the World's Fair, held at Chicago in 1893, was at the bottom of much of the activity leading up to the automobile as it is now understood. Some of the first attempts in the direction of the modern automobile were merely as horse-drawn vehicles, in whose bowels a motor of a very crude order was concealed. From the crude beginning down to the present time progress has been the order of each and every day—like water over the great falls, the rush of improvement, one might say, has been headlong—and these advances wrought are now as a whirlpool of perfection to be witnessed at the Garden. Nor will it be possible to point out some one or two examples of fineness in a sea of things of scarcely less merit. To adequately describe the situation is to say that the level on which modern automobiles stand is broad enough for all the cars, and all of them are there.

Nor will it be fair to say all are alike; they are not all intended to be the same, and all are not from the same point of view; each is with the idea of utility along certain well defined lines. It will be understood, then, that the cars developed in planes consistent with the respective requirements, each toward the goal called perfection to which all roads lead. Some of the cars traveled down the smooth boulevard on pleasure bent; more were on the hard pavement appropriate to the centers of trade; others went by way of specialized channels; but all were heading for the common goal: the house of perfection.

Perfection is difficult to describe, for 'tis many sided, and it is possible to have the same degree of perfection under many sets of circumstances in which the intrinsic merit is defined in terms of "for value received." A glance at the illustrations as here offered will afford means of tracing back to the cars of the past, and then a look at the cars at the Garden will suffice for the purpose. In the meantime it will be at a profit to glance over the cars to be seen at the Garden, and in them locate the differences in fact. That they look different in a way, is too true to take time to say it; the real difference is below the surface, and it is a many sided difference besides. Take, for illustration, the motor in the Apperson Model M car as it is

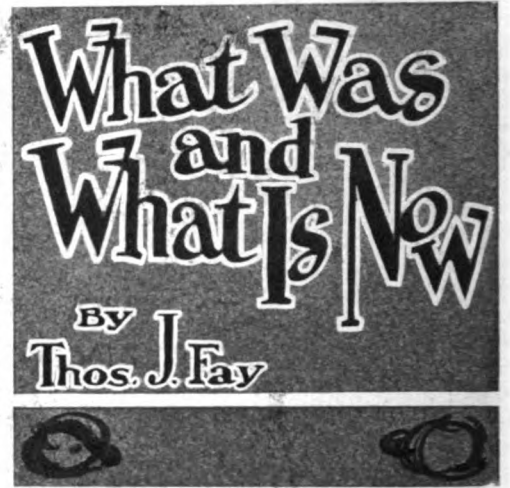

From the Beginning Down to the Present

exhibited. Note that the motor case is provided with means for excluding the foreign matter which abounds on the road. The flare of the motor case is such as to leave no crevices through which the "silt" can steal. By the same device the several motor accessories are afforded a nest in which to snug, out of harm's way, yet withal within the glare of the fullest utility. Or, if, perchance the opportunity affords, be wise enough to lift the bonnet of the Autocar, and feast the eyes upon a power plant the order of which is self-contained, in which the individual cylinders are secured to an aluminum case, so made as to

render the plant, from the fan in front to the universal joint of the propeller shaft, as a single unit. It is the Type XIV power plant of the Autocar make.

Pass on and look at the Columbia, known to fame as Mark XLVIII. Just to show something of the logic of events, screw off the hub cap of a road wheel which conceals the Hess-Bright ball bearings; compare them with the old "plain artillery" types of the not-so-long-ago. Glance at the spiral gears in the engine, doing service which for utility is all that man can want, and doing that service noiselessly. Think of the time past—perhaps a lapse of only five years—when it was said that spiral gears would serve but poorly in any responsible service.

With the journey scarcely under way it is to fall upon the Chalmers-Detroit, a 30-horsepower car in which the cylinders are cast "en bloc" and in which the crankshaft is with two ball bearings; as much as to say, if bearings are prone to give trouble, the less there are of them the better. In the same car it is to note the presence of a Bosch magneto, so nicely placed as to render the installation easy and quick removal assured. Then the spring suspension is worth a glance in that the rear springs are of the three-quarter elliptic order, with a scroll in the quarter, the functions of which are well understood by the autoists who have had occasion to use roads in which "waterbreaks" come at unexpected intervals of time.

In quest of something to make a contrast, something to take the sameness out of the atmosphere, it is to stroll in the direction of the Corbin exhibit, there to note the manner in which a water-cooled motor is so devised as to have the advantages of the self-contained power plant without sacrificing the qualities which reside in the plants along lines consistent with the school of the "individual units." It will be seen that the under half of the motor case extends backward; that the motor is thus afforded the protection of the case, and then that the motor case is provided with large openings through which the vitals may be inspected and adjusted. The covers that go over the openings in the case are so devised that they can be put into place in a moment, and they will stay tight, too.

Thus far it was the fortune of the investigator to run the gauntlet of the cars in which the power plants were of the kind using four-stroke-cycle motors. Just for a change, it is to hesitate at the booth of the Elmore, a notable exponent of the two-stroke-cycle motor, the fame of which has spread throughout motordom's length and breadth. It is not so much the fact that men who merely guess say that a two-stroke-cycle motor lacks in some particular—by them not named—as it is

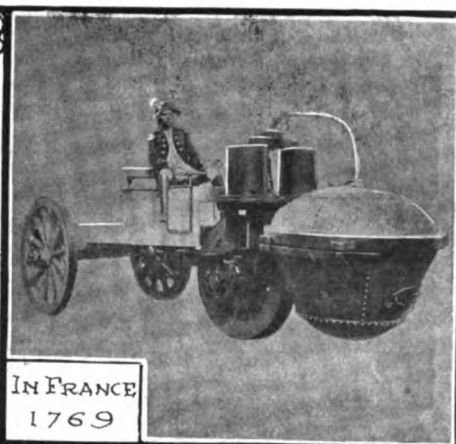

IN FRANCE
1769



WINTON
1902

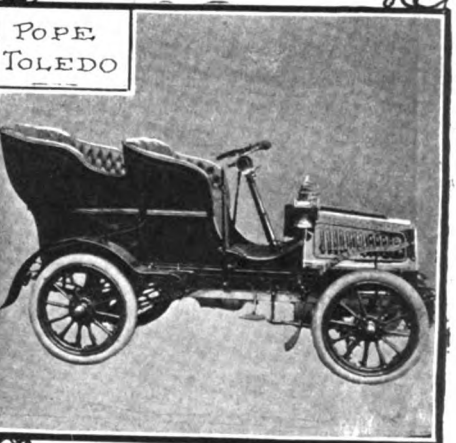

POPE
TOLEDO

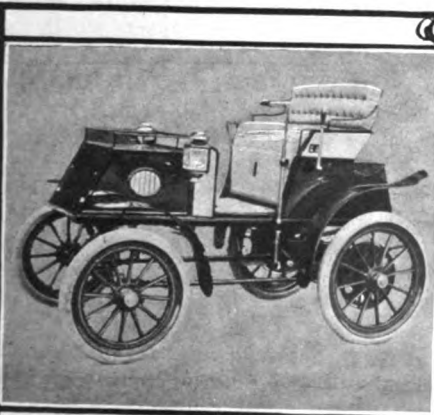

COLUMBIA

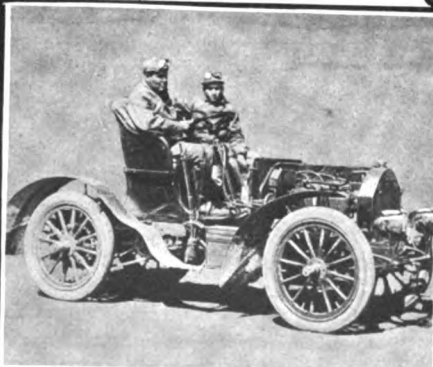

LOCOMOBILE

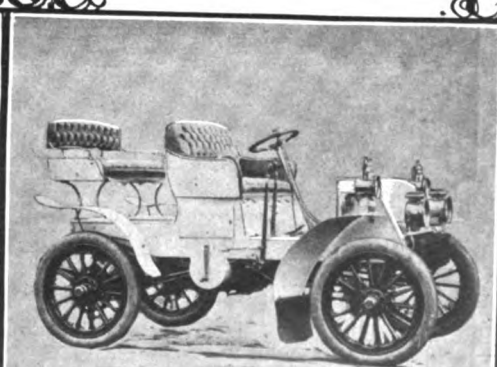

PACKARD

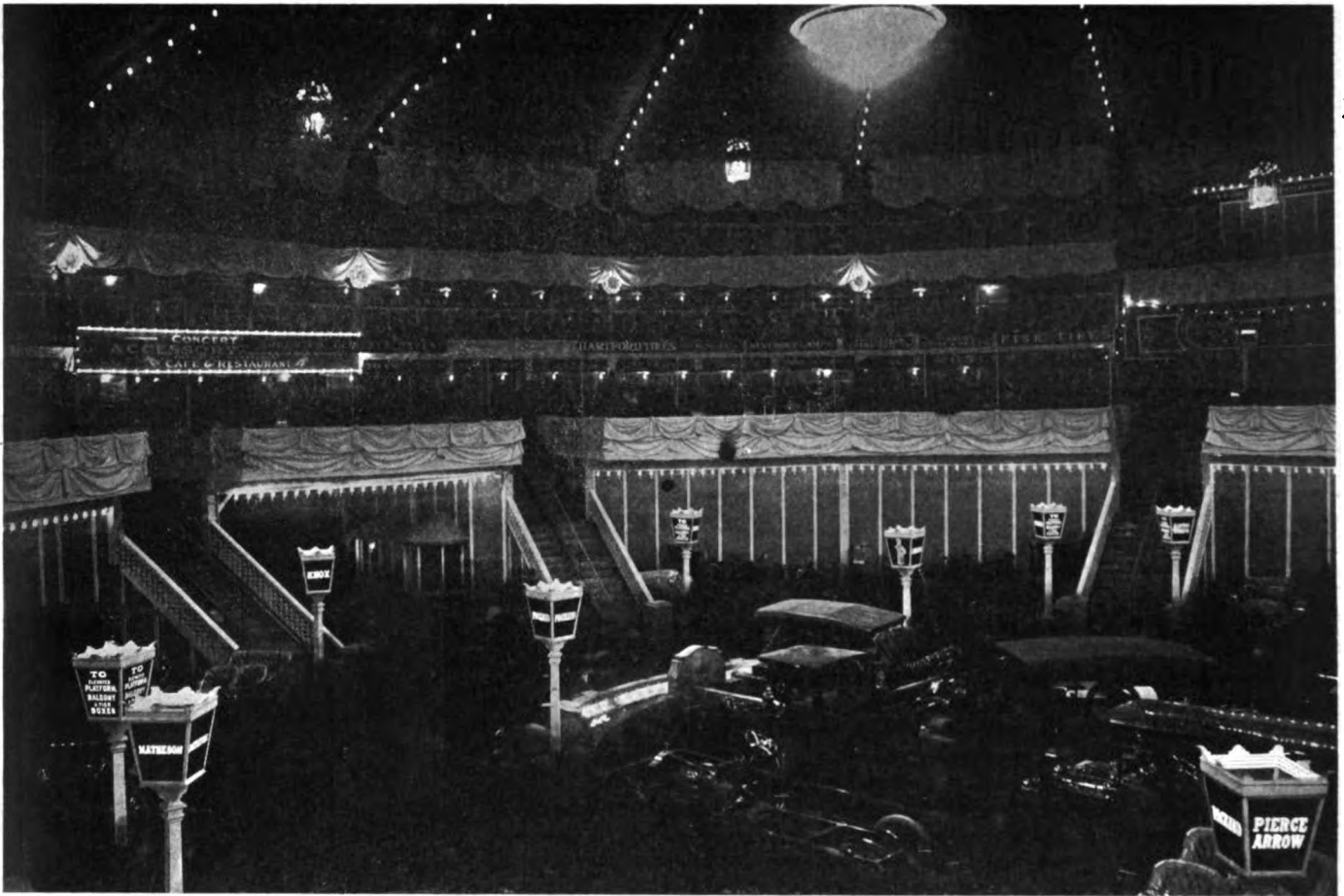

Madison Avenue End of the Garden as Seen at Night When the Electric Lights Lend Their Splendor.

the absence of complicated landmarks which makes one look again. At all events, the sight is one of simplicity in fact, since of valves there are none; gears and camshafts, as well as the bearings and the trinkets to go with them, of course are also absent. It is a simple plant, the Elmore—and it works.

In some cases the makers of cars are famous for the ingenuity they display in defeating mechanical incongruities. Then there are the designers who evolve distinctive features, while once in a while it is to find a company whose product is noted for its strict conformity to the conventions. Stop at the exhibition of the E-M-F. It might be said that if there is nothing unusual about this product, there is nothing unusual to describe. Walk around the circle, gaze upon the project at another angle, and what will be the conclusion? There is but one! the conclusion is that the whole thing is unusual. In this product will be found the pyramided experience of the designers of the world; rejecting ideas however good if perchance they fail to make for smooth construction. In this way, taking good advantage of things as they fall from the lap of experience, merit is assured, and it is this same virtue which is to be found in the cars of 1909, to the exclusion of the things, lacking.

But the phase changes. A look at the illustrations of some of the pioneer cars will locate the Franklin. A look in the Garden will also disclose the Franklin, and, strange as it may seem, it has undergone less change than any other type of car. True, the little Franklin of 1903, as illustrated, is not so much of a car as the modern products from the same plant, yet even so it is a fact that the resemblance is there, and it is with the air-cooled motor, somewhat altered as to detail, but holding its own in a sea of motors of the other kinds. In the modern motor, of the Franklin make, one discovers the introduction of "concentric" valves, means for quickly disposing of the products of combustion, and all the refinements in point of materials and in design as well to be had by any designer of the keenness of

perception of the power behind the Franklin. Owing to the skepticism of the autoists who have hearsay evidence of the performance of air-cooled motors, let us take a ride in the Franklin "six." The side entrance of the tonneau is so ample as to lend the impression of entering some grand arcade, the feet contact with "linoleum," and as we sink into the cushions of the ample seat, it is suggestive of luxury, crowned with hand-buffed leather of the finest grade; the suggestion becomes a reality. The chauffeur, evidently pleased with life, cranks the motor—no, he starts on the spark. Off brakes, in clutch; away we go, free as a bird, careless of the future, alive to but one fact, and that is by way of full assurance of entire competence. Moreover, it is rendered plain that the "armored wood frame" is not only competent, but it is resilient.

Having returned to the Garden, in quest of further information, the eye intercepts the peculiar transmission on the Haynes Model X car, the lines of which are so good as to compel notice. The bevel drive usual in cars is here absent, and in its stead will be found the Haynes roller pinion and sprocket. Wise-aces, in the past, said it would not work, but it has been working so long and so well that it will stand a little study. Instead of the customary bevel gear, as before stated, the idea embraces the combination of a driving shaft with two integral flanges, spaced about one inch apart. At equidistant points on the pitch line, roller pins are placed and rollers are slipped over them. The engaging member is a specially devised sprocket, which by means of the teeth thereon engages the rollers and acts to the same end as a bevel gearset. The plan works exceedingly well, and of noise there is none; even the rumble, usual to bevel gears, is absent in the Haynes plan. The control of the car is along lines to accomplish the purpose, and in divers ways the car would support far more attention than can be given.

On the way up from the basement of the Garden when time was short, notice was taken of the Hewitt product. Investiga-

THE AUTOMOBILE.

tion disclosed a modern truck chassis of the conventional Hewitt design, in which all is for stability and low cost of maintenance, even in the hands of the class of men to whom trucks must be entrusted. But the writer happens to know more interesting things about the same product, as, for illustration, it is a Hewitt "coal" truck which will be seen day after day in the streets of New York City hauling more coal in a given time, on a basis of a lower cost per ton mile, than any coal man ever before heard of, and the steady reliability of the service is a marvel.

Speaking of trucks, there is the Knox line, and also of the same company's product, it will be well to examine into the pleasure vehicles while at the Garden. Let us have a look at the Model O, which is a four-cylinder car of some pretence, borne out by closer acquaintance, due in no small measure to the use of fine materials coupled with taste in design, which did not defeat symmetry; nor is strength lacking. With the cover of the gear box off, it is opportune to look at the gears, and it will be noticed that the materials have a peculiar yellowish color, which with an appearance of "close grain" is a good indication of the use of "chrome nickel steel," and this is what the gears are made of. The straight-line drive to the floating-type live rear axle is at once noticeable, and along the line evidences of refinement are as outcroppings.

Of absorbing interest is the Palmer & Singer show. This company has a comparatively new line of cars of its own, and as sole distributors for the "Simplex" it is known to fame in company with pioneers. The Simplex is so well known as to require no heralding at all. It was a Simplex that held "fourth" place in the first Vanderbilt race, driven by Frank Croker, and originally Simplex cars were intended to defeat the importation of the better makes of foreign cars by the simple process of actual superiority at a lower price. When the Palmer & Singer interests took hold, it was found that the market was far greater than the output of the builders, and the Palmer &

Singer was added in order to be able to supply a greater portion of the demand. The Skimabout, of the P & S line, was quickly snapped up by the buyers of cars, and later the company added the "6-60," which as the characters indicate is a six-cylinder car, rated at 60 horsepower.

Speaking of the Vanderbilt race it reminds one of the Locomobile, and the performance of the "racer" in the last race. In the meantime it will be a good idea to go to the Locomobile exhibit, and see what a year has done for the company. This is one of the companies which held to the side-chain drive for years, and it will come as a surprise to many to learn that the company now has a "shaft drive" car; a 30-horsepower model, embodying all the 1909 features known to be of value in this type of car. One point of unusual merit lies in the use of distance rods as they ordinarily obtain in side-chain drives, and in this way parallelism is maintained with the same degree of certainty as is the case in the side chain drives. Before departing from the Locomobile, it will be a good idea to note one or two of the innovations that go to render flexibility assured. The spring perches will be found free to rotate, and the springs will not have to sustain any part of the torsional load. This may not seem to be a matter of great moment, yet even so it is just such matters that have to be looked after if it is desired to keep to the shaft drive and not put up with "pinching" of the members that hold in their makeup what is known as relative motion. In the new Locomobile all these matters were given the ample attention they deserve, and the result is, as one would suppose, the shaft drive is quite as free from objections as any car can be.

In the same way it might be observed that the Lozier products are now of the shaft drive exclusively, and in the new cars of the line there is the absence of torsion rods. When the car is loaded the propeller shaft is horizontal, and the use of alloy steel is in evidence. But the most important detail of the Lozier

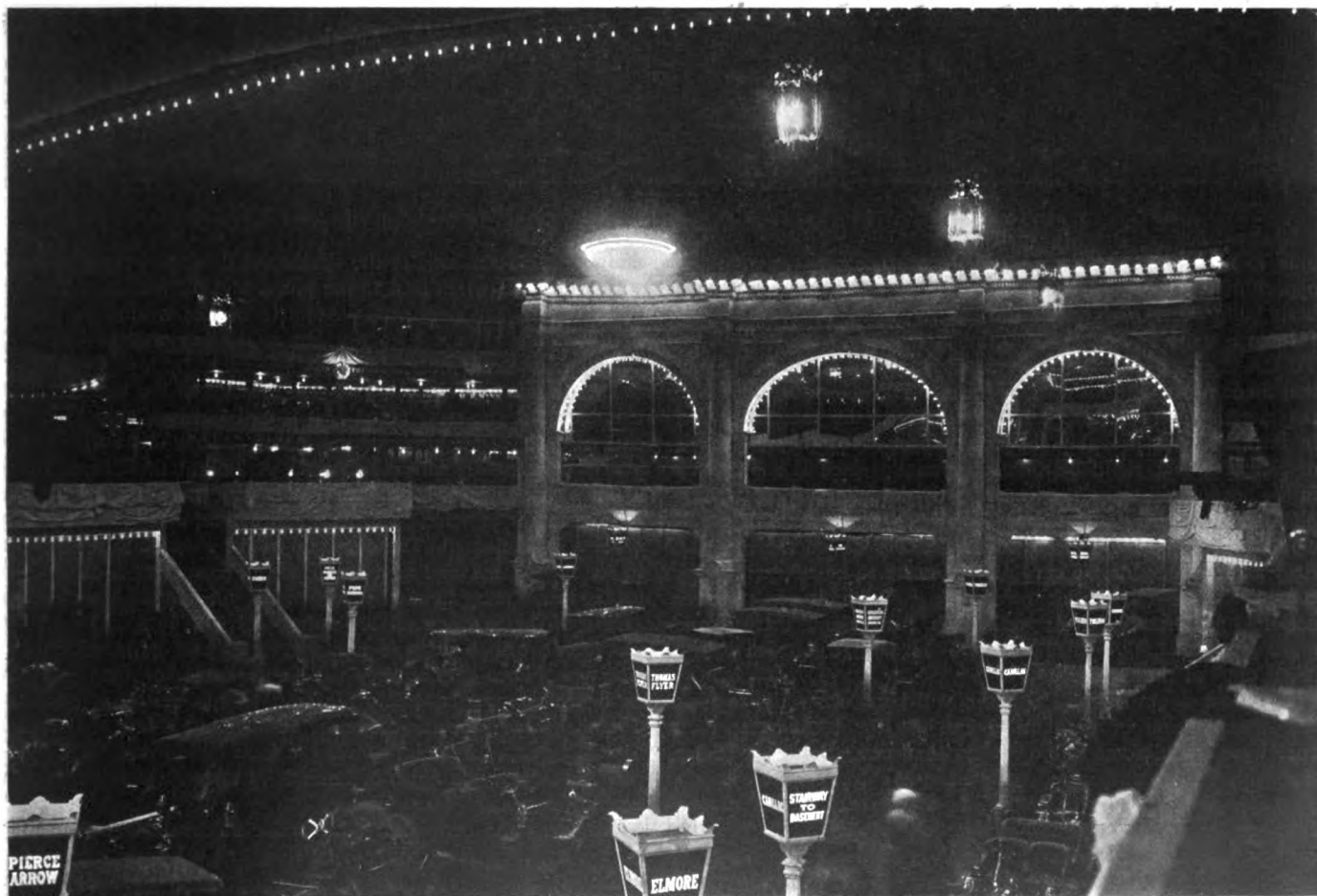

The Garden at Night as Seen When Looking Toward the East or Fourth Avenue End of the Building.

is yet to be noted: look into the crankcase and there note the shaft. It is of the ball bearing type, and it is not new. This type of crankshaft has been in use on Lozier cars for some years, and, contrary to the "blatter" of the mob, it works fine. Whether there is any chance of ball bearing crankshafts giving trouble, if the workmanship is poor, is another question; the Lozier work is the kind which augurs for success anyway.

By way of a digression, let us take a trip to the "Giant's Despair," sit on a boulder by the roadside, get a breath after the tedious climb, await the passing of events. In the distance the soft purr-r-r-r of a powerful automobile will be heard, it is coming nearer—nearer-er-er. The grade is masterly, the road is not wide, the conditions are such as to make one imagine that if an automobile should come that way, the manifestation will be as a chug—a long interval—another interval—another chug. The time for dreaming is short, the purr-r-r becomes more pronounced, the car bursts into sight; it is there, it is gone. Mathe-son! Better stop at this stand at this show.

Instead of returning to the Garden, let us go to the plant of the Packard; it is in Detroit. To tell how big it is in ordinary terms means so little that an attempt will not be made. The Society of Automobile Engineers was conducted through the plant last Summer, and after walking for the better part of a half day the plant was half done. True, it was the idea to be

feed out unless a valve is adjusted to allow the reserve to reach the carbureter. This is a good idea, and it is one to be encouraged by autoists. Then there is the question of lubrication to be taken into serious account. Take the Peerless for instance; examine Model 19. In the crankcase will be found a storage, cast integral, in which a gallon or more of lubricating oil is stored, and by a suitable mechanical means the flow of the oil is regulated in such a way as to assure, (a) profuse lubrication of the bearings, (b) the return of every drop of oil to the place from whence it came, there to be cleaned and re-used up to the limit of its ability. But the oil will not be re-used so many times as to be reduced to inability. Enough is used so that in replacing the same the lubrication value of the whole is kept up to a high state of efficiency. The gear-driven oiler, for the purpose, is on the half-time gear shaft, and it has the facility of not requiring any attention at all. While the Peerless is in sight, have a look at the crankshaft, for it is of special steel, drop-forged, machined to grinding size, and it is then ground to size so close that even a man of good skill cannot find an error, using a micrometer for the purpose. This is not unusual, it might be said; but it is. Only the best cars can claim that the crankshaft is "true," that the journals are not out of round, and that the centers are all to a common axis. Just by way of indicating the close attention to detail which actuates the Peerless

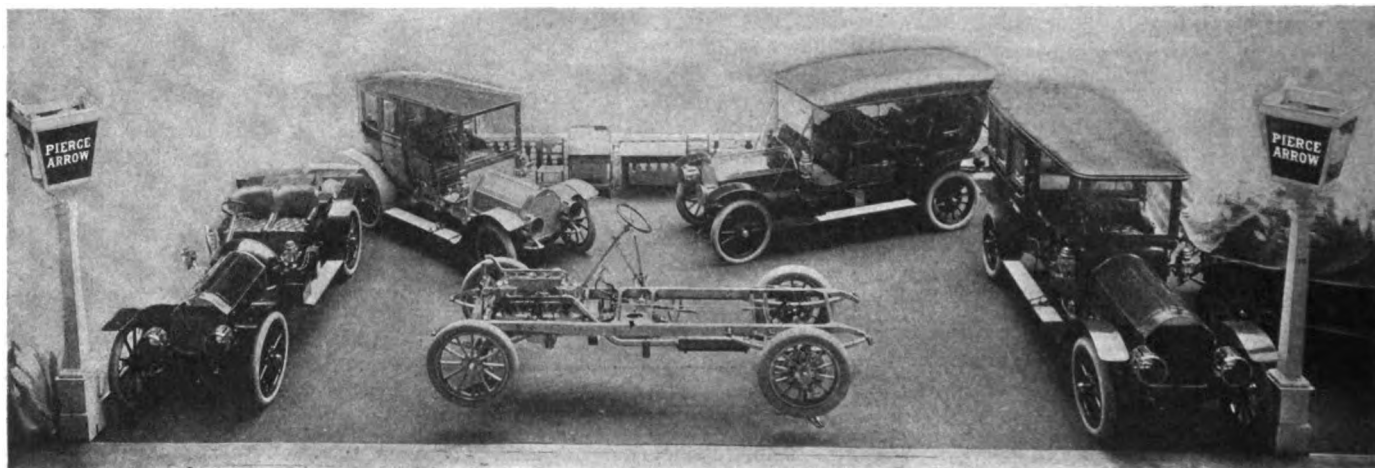

The Display of Pierce Arrows Was Effective and in Keeping with that Well-Known Company's Reputation.

able to see things as they are done at the Packard, and the opportunity was adequately afforded. The output may not have been quite \$10,000,000. The manner in which the task is performed is quite as leisurely—on the surface—as anything can be. To the skilled eye, it was the masterly system of the company that made haste without making waste. The laboratory in which the metallurgist ascertained the qualities of the materials used in Packards was probably the best indication of the real merit of the cars that could be found, especially since it showed up in the product all along the line. But if the laboratory was complete, the designing office was so very extensive and so well equipped as to leave nothing to be desired. Then there is the road performance of the cars of this make to be taken into account. As one English visitor put it: "We think our cars are noiseless performers, but as you say in 'Yankeeland' there is one more guess coming." The Packard "18" at the Garden is the "little one" of the family.

If we are again in the Garden, it will be worth while to look into the question of gasoline tanks, just for a moment; they once were troublesome in more ways than one. Some are under the drivers' seat and gravity furnishes the force which impels gasoline to the carbureter. More are at the back of the chassis frame; securely fastened and well up out of the way, when the cars are backed into the curb. Mostly all are of copper. They are sweated and riveted in a manner to assure tightness, and the "filler caps" are quite large. It is also true of a number of them that a reserve supply is at hand, in that all the gasoline will not

designers, have a look at the ignition system, and note the care with which the wires lead to the plugs, and the manner in which the terminals are completed. Autoists will be willing to believe that such matters are a good index of the fair way in which all the work on a car might be done.

The question of noise is also one to concern the autoist, since it is true that the same noise, if it is extinguished, may be at the cost of quite some power of the motor. That this follows as a matter of necessity is not believed. A look at the Pierce Great Arrows will dispel the illusion, if it is true there is one. In this car the motor is noiseless in its performance, and the loss in the process is eliminated. The manifold of the exhaust is so made as to set up vortices, and as a result the exhaust is as a continuous efflux, thus aiding in the scavenging of the motor, even with a saving of the energy available rather than at a loss. The muffler has little work to do, and it manages its part quite effectively. The new Pierce cars as they will be available for 1909 are with an improved gearset, employing four speeds, selective, and materials such as were the dream of autoists but a few short years ago. From the art point of view, a look within one "Great Arrow" will disclose a finish in Louis XVI effect, which for tone is worth going a long way to see.

Last year the cars were with brake mechanisms of superior ability, but it is true of them that they had too little surface for arduous service. This year the question is on a better footing, in that the brake surfaces are ample, while at the same time the mechanical motions are quite up to the highest standards. Take

the Pope-Hartford as an illustration; the brakes are of greater diameter, wider face, better linkages, and the result is the cars will respond to the brakes in a way not to be easily explained. To begin with, it is not desired that brakes should skid the wheels; then it is assured that the car will be stopped in the shortest possible distance, if it is true that the brakes will lend all the pressure possible to apply without skidding the road wheels. If the shoes have not the requisite surface they will afford a "fierce" action and the good effect desired is out of the question. In the Pope-Hartford the same reasoning was made to apply to the clutch, with the result that the clutch has a wider face than formerly and the service rendered is quite as perfect as the designers found by experience should be the case. In other ways the Pope-Hartford is modernized; a difficult task to be sure, in view of the degree of perfection which was one of its fair claims. One finds a very nice redesign of the chassis frame, in which a "goose-neck" spring hanger lends charm and strength, while the springs go for easy riding qualities.

While the name is up, it will be a good idea to look at the Pope-Toledo, therein to note the extent to which this well-known product has kept pace with time. The first thing to attract notice is the crankshaft; it is of the ball-bearing type; that it is retained is an assurance of the fact that it works. This

In a word, the cars at the Garden are rated in accord with a prearranged plan, and the result is that they relate to each other in a manner which allows of a comparison, especially when it is desired to note the relation of power of the motors to the weight of the cars, and in this way ascertain if the road performance will accord with the needs in any given case. This is not to say that the gear ratio or the power for weight should be the same for all places. In a matter of this sort it is necessary to take into account the roads, and the gear ratio should be in accord with the needs. All the cars are so devised as to enable the makers to adjust for road conditions, and there is no argument in saying that a car is a superior hill climber, if the power available is the same as in some other car, unless it is that the gear ratio is adjusted to suit hill work. Before leaving the Royal, let us look at a few of the points of more than the usual note, and by so doing lend to the impression that this company has done its share to maintain the status of the A. L. A. M. In the Model M of this make the transmission is of the four-speed selective type, and the workmanship is up to a standard which lends character to the car. The wheelbase is long, longer than last year, and the general appearance is much enhanced, although the Royal was never of the short wheelbase class. In the matter of brakes, this car is so well equipped as to be noteworthy.

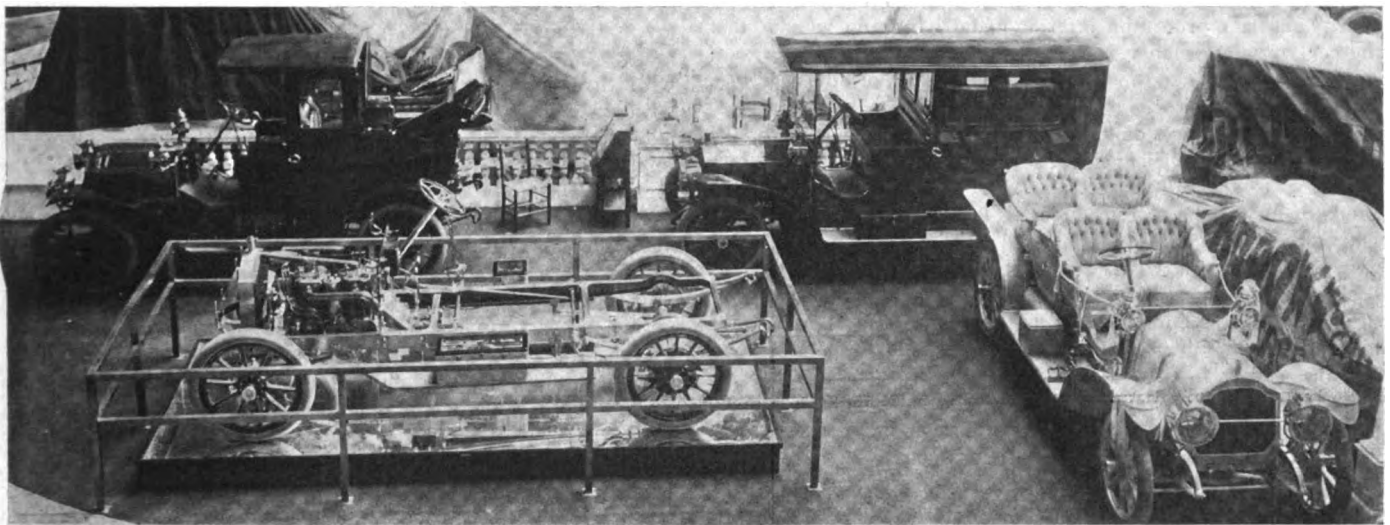

At the Packard Stand an Array of Cars Notable for Constructive Features and Fine Finish Occupied the Floor.

company was never of the class to keep a thing a moment after its competence was questioned. This is pleasant to note in view of the fact that some designers say ball bearings do not really have to be used in crankshaft work. They do not go so far as to say that the ball bearings are out of place, nor will they be able to show that they give any trouble which cannot be traced to outside cause. On the other hand, motorists can well afford to encourage two things in automobiles. One of these is good oiling and the other is ball or roller bearings. Anything which will enable a motorist to go about his business on the road without the fear of "frozen" bearings is a good thing to encourage. In the first place, if a bearing is "frozen," it ruins the same; then too, it discommodes the motorist, and besides it ruins the materials of the crankshaft, or whatever it may be. It is in such cars that one will look for the peculiar tint of alloy steel; it is there, in the Pope-Toledo.

Thus far in our journey through the Garden little or no attention was paid to the sizes of motors used. In a way it is true the matter was as a dream, but it is necessary to pay specific attention to a matter of such great importance as the sizes of the cylinders. Under the circumstances, it will be prudent to begin now. In the Royal, the one of the 48-horsepower motor has cylinders with a bore of 5 1-2 inches. It is a four-cylinder motor and according to the A. L. A. M. formula the power would be:

$$\frac{5.5^2 \times 4}{25} = 48 \text{ 2-5 horsepower.}$$

There are three sets of brakes, two of which are on the rear road wheels and the third is on the propeller shaft. The Royal is also provided with a self-starter as an extra in every case in which the autoist thinks he would like to run his own car.

From the relatively high priced car, as above referred to, to the Selden is a big drop in the matter of price, but it is not so sure that the quality of the car can be reduced in anything like the same ratio. In other words, it is but to look at the Selden and to note a full fledged automobile the price of which is \$2,000. On the road it is a fact that the Selden is a consistent performer, which is not to mention the fact that it is especially free from noise, under all fair conditions. This is probably due to the skill of the designer, E. T. Birdsall, one of those who succeeded in making machines run at high speeds and not make a noise. This is due to the right distribution of the metal, having in view the fact that noise is not wanted, and that it is worth while to spend a few pounds of metal in the right place to accomplish the result. The end is that the crankcase is not so thin as it could be from the strength point of view, the gearcase is a little more stocky than some cases are, and means are provided to keep a film in all the little bearings in and about the chassis, thereby to prevent rattle, which also assures long life and small loss of power. It may not be generally appreciated that noise is at the expense of power; it is even possible that there are autoists who do not realize that if a spring bends, power of the motor is absorbed in the process. But the de-

signer of the Selden knows about such things, and in the Selden car all these little matters were gone over.

To show the difference in price on a basis in which the difference in quality keeps pace, it is but necessary to examine the Stearns cars, one of which costs \$4,600 and is rated at 30-60 horsepower. In the first place the Stearns is intended for the man who cares to pay for the best car that money can buy, in which every detail is on a plane such as would make it utterly impossible for a man of ordinary means to think of paying the bill. In this car it is optional with the purchaser to select either the shaft, or the double side-chain drive, and in a dozen ways the car is one of luxury and refinement. The eye of the skilled engineer quickly locates high priced annular ball bearings all through this car, and the material has the ring of close grain, great toughness, resiliency, and just the characteristics which are present in the product, capable of doing the work for years, with but small chance of even temporary trouble. In the shop where these cars are built it is well worth taking into account the fact that the highest quality—chronometer quality—is what is aimed at, and it is no stretch of the imagination to say bull's-eye accuracy is the result. The extent to which this matter is carried is shown in the simple fact that a "test coupon" is cast on every aluminum casting entering into a Stearns and the company would be able to quickly locate any attempt to "burn" superior proofs on inferior metal. It is no wonder that the car runs into money in comparison with cars which are not so highly powered, and in which the "finish" is not advanced to a "chronometer" basis.

But the subject gets dull, so full of interest is it, which for the sake of contrast will demand a shift to some car of a different school, so to speak. To cast about is to quickly find one at the hands of one of the oldest builders. Take a look at the Stevens-Duryea; it is with a self-contained power plant, in which the flywheel is in front. This is the aluminum motorcase extended back, without change in contour until it makes almost a tube of symmetrical section, the strength of which is assured on a high plane. The flywheel in front gives the maximum clearance, and the leaders in this school of design have good reasons for bolstering up their claims of superiority. The self-contained power plant is with clutch and transmission gearset all in one housing, and the whole mechanism is adequately protected from dirt, and road inequalities cannot upset the alignment of the bearings. Of course, there are various ways to accomplish a thing, and this is one of the ways that time has put the seal of approval upon. In a large measure the success of the car is due to the fine materials used in all the parts, and on the whole it would be pleasant to remain around the stand and admire the details, in view of the nice features of design to be seen.

Magnetos Are the Mainstay for Ignition Service.

For fear it might escape, let us go to the Studebaker exhibition and have a look at the Bosch magnetic spark plugs used instead of the other well known ways. In this scheme it is easy to see that theory has a chance to expand, and the aim is to depart from some of the fallacies which cling like a specter to the methods of the past, as they are used in some cases. In this case the Bosch magneto is used as formerly, but the magnetic spark plugs serve instead of the ordinary kind. The spark plugs so made are self-contained, and a timer of the ordinary description is done away with. The plan has the benefit of a good long try-out and is much liked by the users of the cars. There are a lot of other things to be looked at in the Studebaker which will have to be left for some other time. It will be of interest to go to the Thomas booth and while there look at the six-cylinder cars which made the "Thomas" famous. It will be well to go prepared to take off hats to the "sixes" as they emanate from the Thomas plant. Past performances will influence the situation more than a little; it was a Thomas which won the New York to Paris (won in a walk), and it is also true of the same cars that they have always received favorable competitive mention. Take the "6-40" as an illustration of the

latest efforts of the company. The barrel type crankcase is the first thing to greet the eye of the man who knows the scenery. Then, it is to note that the alloy steel crankshaft is centered on annular ball bearings, and the workmanship is a sight well worth going to see. The clutch is of the regular Thomas design in which three (cork insert) discs are used, the same clutch that served in a Thomas in the run around the world. From the clutch to the gearbox the eye quickly takes in a three-speed gearbox of the "selective" type. The gearset is housed in the rear axle, and the axle construction is a modern creation. The springs on which the chassis rides are of the full elliptic (scroll) type, now regarded as a Thomas feature, the value of which cannot be overestimated. In this car the center of gravity is very low indeed, and the road performance is thoroughly good. In a car such as this the question of price is not to be discussed at all. Buyers of Thomas cars are of the class who want the best and they know it is only to be had on a basis to allow the maker to cover the business risk in a manner to leave no chance for an excuse to trim down on the quality.

Grand-stand Play of Six-cylinder Cars.

Before closing out what is more or less of a panorama, it will be important to pay a visit to the Winton, noting at the first glance that the cars are all "sixes," and then to observe the "self-starter," which is a distinct advance on trying to "spin" motors of great power. In some cases the same cars are fitted with tire-inflating equipment, and together with all the other advances which go to make Winton fame, renders the Winton exhibition one to linger in, and the cars, of the greatest possible interest. Winton—the name—is historic, and the cars are the logical outcome of a plant which has always been known as "producers," not only of automobiles but of ideas. The new Winton "six" is rated at 48-horsepower and is the same Winton that established the record for low cost of maintenance last year on all the cars produced, which is quite different from noting the performance of a single car under special conditions.

"Steamer," you say; want to look at a steamer. The White Company will be glad to show you. The White booth has two models, both the same in point of the power plant excepting in one particular; the power rating is not the same. On White steamers of the present time it is to note the use of the "joy" valve gear, the value of which is not to be stated in ordinary terms. With this valve gear displacing the "Stephenson," the performance is not only far more flexible, but the economy is much improved as well. Model O is the new (somewhat smaller power plant) car, and it is in every way up to the White standard of excellence.

Body Work Represents Plain Elegance.

Before leaving the show, let us stand at some point of vantage, there to look at it as a whole. What is it that strikes the mind's eye? Is it not the fact that all the cars look different? When we say the cars at the Garden look different, then to explain the manner of the difference is the natural sequence. To render the explanation potent is quite another matter. In the first place it is the bodies that we see, and the difference must reside in the fact that the body work has moved up. It is the difference as between costumes. If they are the product of "Worth," it is one thing; but if they are from some establishment noted for lack of style, it is quite another matter. In a word, something has happened to the 1909 automobiles; they certainly do look different. The best explanation of this lies in the fact that it is not the cars that have changed so much as it is the fact that the designers have moved up. We see the result in the cars, it is true, but it would never be there were it not for the fact that the designers have arrived at a point in their mundane career when to do things on a big scale is the natural bent. This year of 1909 is the year of the "natural bent"; in other words, it is the year in which the ambitions of the men of the high ideals have been cut loose from the environs of the past; the past in which the influences of "horsemen" lent zest to fallacies.

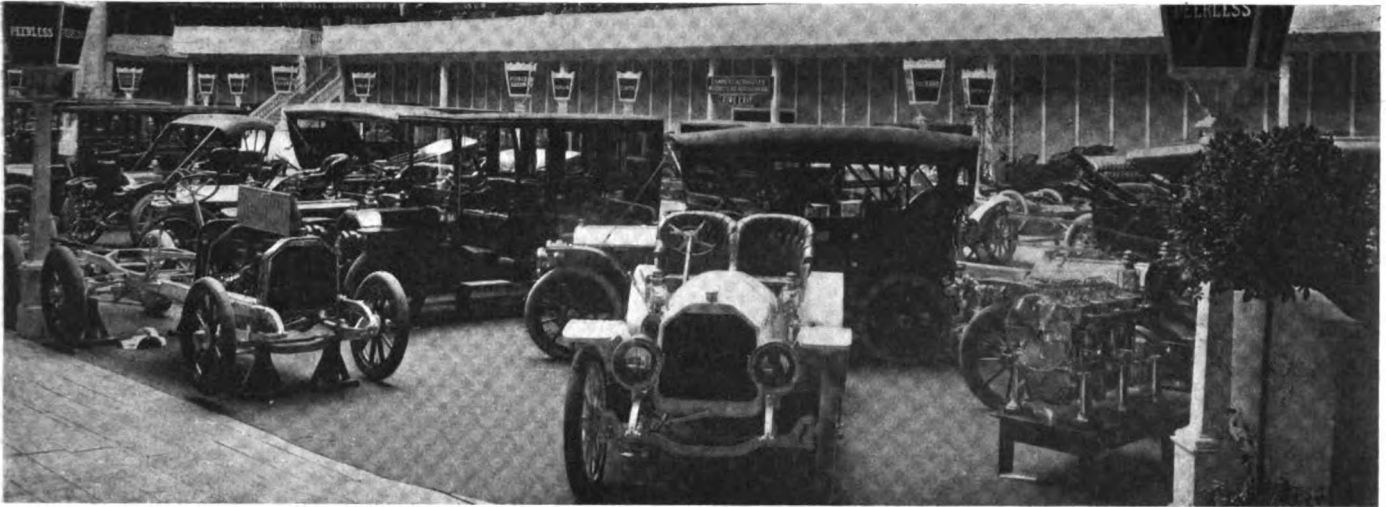

Peerless Exhibit, Showing Chassis, Roadster, and Touring Cars, Backed by a Splendid Limousine.

SIMPLICITY AND STABILITY IS KEYNOTE OF BODY WORK

NOTHING short of good bodies will be found on the chassis at the Garden. Even so, there are differences as compared with the practices of former days. In the first place, it is not now possible to go into the Garden and find a single example of a very inferior chassis hid under a very fine body. But it is possible to go into the same Garden and find a fine chassis sporting a body of no great pretense. In a word, this is the year of standard chassis work and plain body work in the main. Still, this plain body work is with lines; straight lines, they call them.

They are good body propositions, in the main, and free from the strictures that went with the average body not so long ago. The framing of the bodies at the show is the kind of framing that will stand the "gaff." Then there is a decided difference in weight in favor of the 1909 body work. This in itself would be as an incident of no great moment because it is of the greatest importance to distribute the weight in a manner to assure a low center of gravity.

In the work to be seen at the show the center of gravity is held low because the framing is heavy enough to stand and the superstructure is designed for low weight. There is no doubt of the fact that a light framing in the superstructure will last longer than heavy work. It is out of the question to have the superwork heavy and be sure that the body will hold together. The underwork is not so stable as to afford a platform for heavy superwork, and while it took some time to arrive at the facts, the cars at the Garden adequately conform to all the requirements in the light of experience.

Prior to the proper disposal of the details of design along lines taking into account the distribution of the weight it was not uncommon to see body work in which the panels were "checked" rather too soon. Indeed, it was not uncommon to discover this "check" trouble after the very first time the cars had a day under conditions of inclement weather. Part of this trouble was due to other causes, but much of it could be traced to the strains set up in the framing.

Some of the earlier examples of body work included a large use of putty, and it was not uncommon to discover "plaster of Paris" as a lining behind the panels. All such evidences are gone; the work is on a good basis, and it is a pleasure to be able to say that it is now "good form" to use a plain body on a fine chassis just as a silver case oftentimes encloses a fine chronometer. Why not? Is it not the body that goes out of style? If the chassis is of a good design, and if the materials are good as well (and they are in the cars as they can now be had), it will be a very simple matter to change the body at will,

if, perchance, the same drops out of step later on with the prevailing styles, which is a likely contingency.

The "straight line" effects as they are to be seen on about all the cars this year certainly do please the eye, for the time being at any rate, and it is the prevailing opinion that these effects will stand better than the "swanlike curves" of the past. Then, it is of the greatest advantage to have wide openings, and it is a fact that the cars of the year are with side entrances wider than they were even last year, which was a year of reform.

In relation to the ventilation of the closed types of body work, it is to note some reforms by way of maintaining a certain purity of the air. There is more evidence of provision by way of preventing the upheaval of dust on the road. These are all questions that are, and should be, discussed in connection with the body work, and it is the bodymaker who looks after them in nearly every case. Even slight differences in the contour will effect this question, and if the bodymaker does not mend the defects it is a moral certainty that the chassis maker will not have time to do anything about it. Even the design of the mudguards is a body question, and it is much to the credit of the bodymakers that the present shapes of mudguards are in vogue. There is probably no one reform that is so pronounced this year as that of the mudguards; as it is, they are all to be desired, and it is assured that the question of any further advances along these lines will be difficult.

As respects types of body work to be seen at the Garden, it is almost enough to say there are none left out. On the other hand, there is no doubt of the fact that there is a decided increase in the number of landaulet types, and they are looked upon as fitting for both town car and taxicab work. In town car service it is not uncommon to see the upholstery in broadcloth, whipcord and, in some cases, goatskin. Some of the examples are works of art, more are on what might be called a standard basis, and in a very few cases it is as "show," with little to back it up. Of course in the latter cases the cost of the body is low, and in full accord with the value.

In taxicabs the interior is on a very substantial basis, using hand-buffed leather for the upholstery, and it is safe to say the work is on a basis to assure long life, at a low cost of upkeep, which is the matter of the greatest importance. Limousine body work is at the Garden in considerable force; this class of work is on a basis that can be set down as stable, and the interior finish is tasty. In limousines it is not uncommon to see the finer grades of broadcloth, a good display of whipcord materials, and goatskin is much in evidence. Colors are in some variety, and there is quite an attempt at ornamentation.

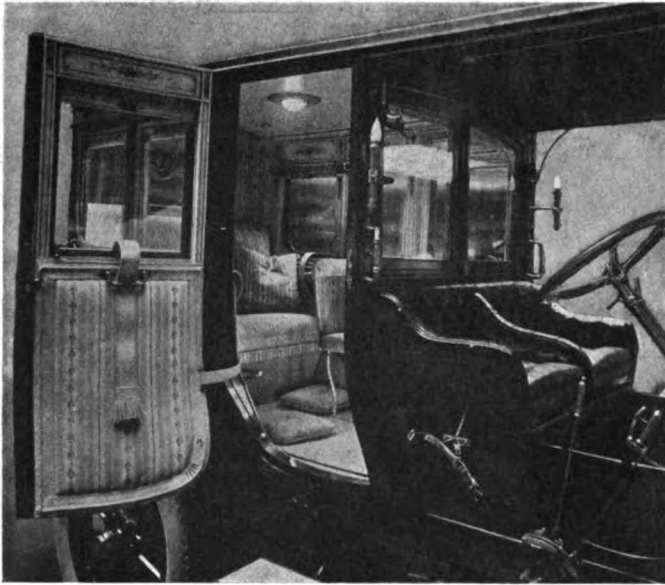

Pierce Limousine Louisa XVI Style Embodies Art.

Broadcloth and whipcord fabrics as they are used in the better class of body work will scarcely require discussion, on the ground that cloth finishes come with the high-priced cars in which the body is usually as a "special" and the purchaser is well able to take care of his own interest. If he does not know of his own knowledge he can pay for the services of an expert who may understand the situation. On the other hand, it is in the low-priced cars that the body work must be at a low cost, and the chances of falling heir to upholstery below a fitting standard will have to be taken into account.

The Importance of Substantial Upholstery.

That leather is the most fitting material for the purpose is a well-established fact if the purpose is to use a car in general service and get the most possible out of it. When it comes to leather, there are as many grades as there are cows to skin. There is, however, a general average to be taken into account, and the value of the leather for the purpose depends upon several considerations. In a general way it will be fair to say hides are split in three thicknesses, and it is a natural sequence that the value of the upholstery will depend upon which layer is used. When a hide is skinned it is salted, and if the salting is not well done the hide will deteriorate very rapidly. Then, there is the question of the manner in which the skinning is done; it is oftentimes the case that the hides are damaged in the

skinning process. At all events in the tanning process which may be delayed too long, considering a hide is not properly salted, the first thing to do is to remove the epidermis. From this point on it is a tanning process pure and simple. The "corium" or true hide is soaked in water to remove the salt and such other matter as will dissolve in the water. From this process to the "lime" vat is as a step, the idea being to remove hair and such other matter as will be susceptible to the liming. Scraping follows this, and the hides are then "bated" to remove the lime, which is liable to work an injury to the hides. Finally the hides go into the tanning bath and are processed according to the aims of the tanner, depending upon the quality of leather it is desired to produce. At all events, to come to the point, it is true that the hides are put through the "slitting" process, and in the slitting machine they are slit into two or three thicknesses, if the leather is to be used for upholstery work. Now, the separate layers are not all of the same value for the purpose, and it is to the point to know that the leather is of a certain value for the purpose. Then there is the question of the further process after the leather is slit and the tanning work is done. If in the "stuffing" process the leather is stuffed with glycerine, we will say, instead of cod liver oil, which many consider better for the purpose, it will be at a loss to the ultimate buyer, since glycerine is soluble in water, and the leather will not sustain in service as upholstery for automobiles.

Finally there is the finish to be considered. If the leather is of a satisfactory grade, and it is hand-buffed, it will show it, not only in the appearance, but in the pliability. If it looks flaky, and if it is not firm, then it is a sign of leather that is not of a desirable grade, the reason for which may be one of several. The spongy condition is frequently due to the fact that leather is far higher priced than tanning material, and in the "plumbing" process it is the aim to distend the pores of the leather to the greatest possible extent in order that the tannin will "take" to the greatest degree. It will be understood that there is a difference between leather and a hide or a pelt. Leather is a compound of the fiber of the hide with the tannin. If the process is conducted to excess there will be too much tannin, and spongy leather will be the result. Of course, there are dozens of details attached to the process, and it is not the purpose here to discuss them. The point is to show that good leather for upholstery will be from desirable hides, the prime of the slitting process, and the leather should be "stuffed" with cod liver, or other suitable oil.

Finally, it is true that old leather is of small value for the purpose, and yet there is a vast amount of leather that lays in storage for a time too long. If the upholstery is not pliable, of even texture, and if it is not at least of a good machine-buffed surface, it would seem as if it does not belong in a car.



Winton Exhibit Showing Chassis as Foreground for Touring Cars and a Limousine with a Distinctive Body.



Stevens-Duryea Exhibition of Chassis and Body Work by Way of Touring, Roadster, and a Limousine.

Of the work in the stock cars as they were examined it is a pleasure to note that in even some of the quite low-priced cars the leather is of a prime hand-buffed grade from hides that could not have been of a grade below a fitting standard. There may have been cases in which the leather could be questioned, but even they were not so inferior as to demand a strong objection.

No mention has been made of the patent leather finishes. This is a product that will only bow to experience. Even the makers refuse to guarantee it, and under such conditions it is not to be expected that writers will reflect its qualities. Even so, it does seem to serve very well, and many autoists take kindly to it on the ground that it does lend enchantment to the body finish. For the man with the pocketbook of sparing purport it might be a good idea to go after tanned leather of the standard finishes on the ground that the risk is well below that of the patent leather expectations, despite its fair utility. In fillings for cushions (stuffing), springs and air cushions are the most durable, but it is now common to use hair. In the "skin" jobs it is the practice to use hair on the top and excelsior for the most part. The latter material is of no value, on the count that it has no life, nor will it stand up for more than a few days.

Some Reflections of the Use of Good Materials.

An examination of the cars at the Garden discloses a diversity in style and of finish, and it is to point out a little diversity. Otherwise it is to note that the materials used are up to a standard which leaves little to be desired, especially in the big cars. In nearly every example of limousine at the Garden the seating capacity is seven; and some ingenuity is in evidence by way of the two extra seats. In the case of the Selden, the shape of the body is novel, in that it narrows toward the front considerably, and it is rather a pleasing effect at that. In the Locomobile the limousine can best be designated as roomy and luxurious. It is a standard product in every way and quite up to the chassis.

Then there is the Simplex with a limousine, also to be classed as luxurious. In body work such as this it is only fitting on the cars of the higher class on account of the cost of the body work. It is not uncommon to have the body foot up to over \$2,000, which is overmuch to pay, if the chassis is of a comparatively low cost. But if the cars as noted have body work of a character to be mentioned, it is also worth while to say that nearly every make of car at the Garden is accompanied with an example of limousine, the value of which is not to be overestimated. Then there is the Springfield Metal Body Company, with a fine display of body work in all the types to be seen on the cars, many of which are of the Springfield make.

The White Steamer is there with the usual display in body work along the lines which made the White distinctive for a

number of years, but it is a moral certainty that the White "roadster" type of body will be very popular. Then there is a White "close-couple" idea, in which a platform is available at the rear big enough to accommodate baggage, trunks, etc. This idea is one that we have not seen the last of.

On the Stearns cars the body work is on the same high plane as the cars, and this is saying more than a little. In the first place, it will be remembered that the Stearns cars are on a high basis, both in point of materials and in the design. The body work is so in keeping with the cars as to make the whole a picture in harmony. The Stearns limousine should attract more than a little attention among the autoists of good taste, primarily because of the quality of the work in the chassis, and again because of the lines of the body and the degree of finish, as well as the color scheme. Of course, when it comes to color, it is difficult to say what any one will take to. Some like yellow and more like green; all will agree on a high degree of finish, no matter what may be the color.

The Craftsman's Skill Displayed in Body Work.

Back of the color is the panel work and the framing upon which the color must rest. If the foundation is not stable, then

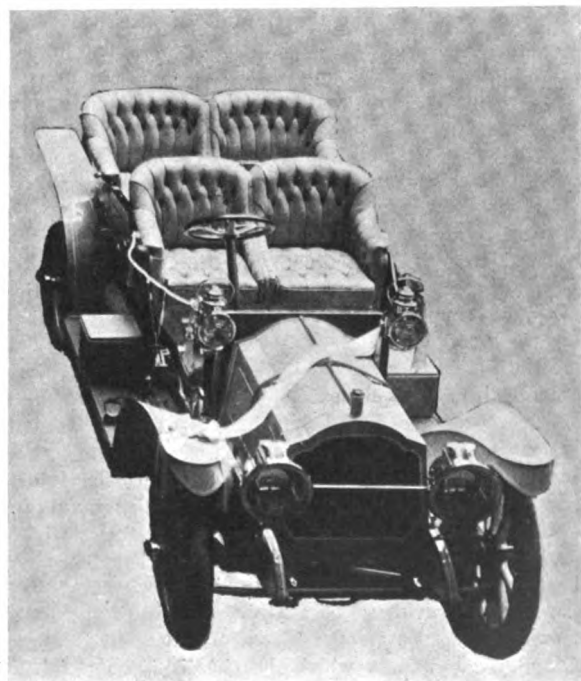

Packard Close-Couple, Sensation of the Garden.

it is plain that the color will "rub off." Sheet steel is now much in vogue, and of it there is something to be said beyond the fact that it is strong and of a permanent character. If the panels of sheet steel are properly made, they will add much to the strength of the whole, although it may be true that a sheet of steel, unsupported, has but little stiffness. It is the flanging and the curvature that adds the strength, and it is at almost no cost, nor does the weight increase materially.

The sheet steel can be "black" or it may be coated with aluminum. For that matter it can be galvanized, and even a prime coat of red lead will afford all the protection that necessity demands. Of the sheet steel body work, then, it is plain that it is not high-priced, nor is it likely to deform in service, and, again, it will not check; which is the danger to be encountered when wood is used for the panel work. On the other hand, it is only certain kinds of woodwork which are prone to warp and check. If the wood body work is up to a fitting standard the chances of trouble are slim, although it is true that a good wood body will cost quite as much as one of steel. This would seem to be at variance with the dictates of reason, but it must be remembered that, with steel body work, once the forms are avail-

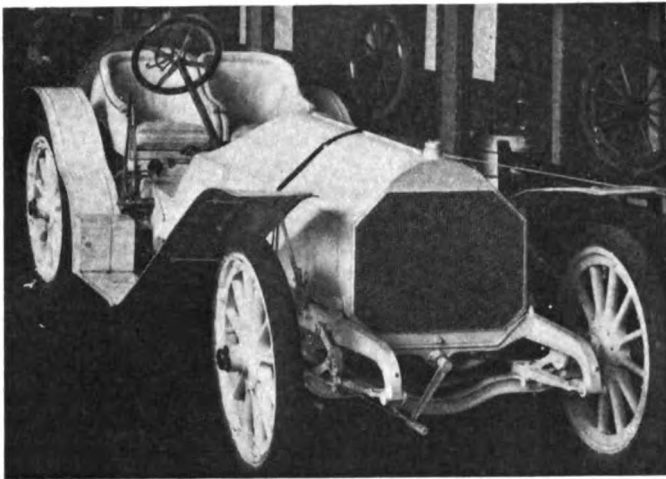

Roebing-Planche, Built by the Walter Company.

able, it is whipped into shape with a minimum of labor, and in the long run it is the labor item that "canters" into money.

Aluminum is used quite as much as usual in the more costly types of body creations and the framing in such body examples is of wood. As a matter of fact, the framing has to be very stout if aluminum is used unless the sheet aluminum is rather thick. Then there is the question of the life of aluminum bodies to take into account. If the aluminum is exposed at any point, or if water seeps through and gets between the aluminum and the wood frame, it is assured that the aluminum will corrode away, and the time taken in the process is too short. On the whole, then, if aluminum is not used in the body work of the lower-priced cars, it is fortunate for the patrons who cannot afford to pay the higher price for the aluminum creations, if there is good chance of their not lasting as long as the steel plate or the wood body.

As to the finish, there is small chance of discussing the questions involved in limited space. With a foundation in which to rest the repeated coats of "finish," there can be as many of them as the autoist has money to pay for. In a general way it will be fair to say 22 coats of finish and varnish (total) will result in a product equal to about anything that man can produce. From the buyer's point of view it may as well be said it is rather a fine body that requires so much work, at a cost that has to be taken into account. The "stock cars" for 1909 will scarcely show evidence of anything like finish at the expense of 22, or even 18 separate finish coats. Indeed, it is a question if the low-priced cars, in which the chassis is on a fairly high plane, will stand the cost of "coach" work in the finishing.

As a matter of fact, it is a question to be seriously considered

if "machinery" finish is not more appropriate in cars of this class. Certainly the examples of machinery finish to be seen at the show look quite up to a high standard, and the lasting qualities of the machinery finish should be considered. In machinery finish the base is pure white lead, with a small percentage of zinc. The lead and zinc are ground in oil, and pigment is added to give the color desired. If there is to be a luster, then varnish is added to the materials for the last coat or even two coats. If this paint (which is all it is) is laid on thin, and over a good foundation, it will slick down to a good finish, and five such coats will suffice for any automobile to cost, say, less than \$2,000.

Machinery finish is far more durable than "coach" finish, and it can be touched up in due course as the occasion requires. The "coach" finish, on the other hand, will not look first class if it is tinkered with, and it is claimed that to refinish it is necessary to burn off the old coat before applying the new. On the whole, it is well to be satisfied with a little less finish on the body work of the cheaper cars, especially if more automobile is given instead. Indeed, it seems to be the case this year that the finish is less striking and the machinery is conspicuously good.

Some of the Notable Bodies.

In conclusion, it will be the idea to mention several of the highest-priced bodies in the show, especially as they are something by way of an art proposition that is of considerable interest. This is particularly true of the Pierce Arrow, Louis XVI creation, as talked about in THE AUTOMOBILE last week. In view of the description as given last week, and the illustrations afforded, it will not be necessary to go into the matter at further length at this time.

In some of the exhibits the cars are provided with bodies on a plane indicating that it is the aim to deal with the over fastidious to their hearts' content. The distinction to be made is this: As a rule, the stock cars in the Garden are fitted with bodies up to a certain standard of excellence, with the understanding that "creations" can be had as specials. In some of the cases, however, the body work is of such a fine character that it must be confessed that there are no "creations" that would make a better showing. Take, for illustration, the Packard "close-couple"; it is one of the types of body to which the patrons of the industry have taken a strong fancy, and the particular example is up to such a high standard that it is bound to have a lasting effect on the future of automobile body work.

The Thomas "4-60" with a limousine is one of the cars of the show to which the pilgrims with money to spend are invariably tracked, and it is assured that this car, with the luxurious body it supports, is in keeping with Thomas aspirations in all respects. In a certain sense this body work differs from many of its neighbors in that it is not in any sense loud; to fully appreciate its excellent qualities it is necessary to go into the limousine and stay there long enough to get used to quiet luxury. The "6-40" Thomas is also there to be examined, and it is worth a trip to the Garden for that purpose alone.

THE NEW ROEBLING-PLANCHE CARS.

The Roebing-Planche, of the Walter Automobile Company, Trenton, N. J., though a newcomer, embodies standard methods long and favorably known for true worth. The cars are of the tried-out, modern methods, using most approved materials and designs that stand road work, as would have to be the case considering the motors of great power used in the Roebing-Planche cars. The motor work belongs to the class with "T" cylinders, and the castings are positively superior. The chassis frame is of splendid strength all along the line. The ambition comprises three cars, one of which is the big racer, rated at 120 horsepower; the second is a medium-powered car to go about a mile a minute or a little better, and the third is a comfortable, little power plant proposition in which speed is secondary, but in which it will be found adequate for all reasonable needs in town cars, taxicabs and for many purposes.

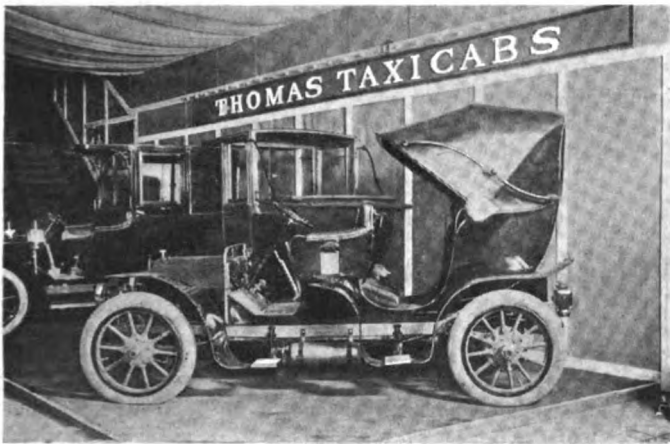

Thomas Taxicabs Naturally Attract Much Attention.

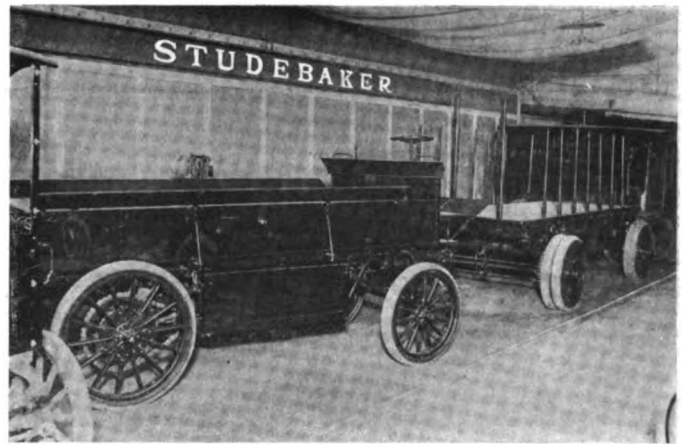

Studebaker Electric Trucks Have Substantial Look.

DETAILED PROGRESS AS TOLD IN COMMERCIAL CARS

THE commercial section shows many peculiarities, among which the most noticeable is the matter of load capacities. It was formerly thought that the truck reached its maximum capacity at or about five tons. The development of the past year or two decided in the minds of many manufacturers the fact that this limit had been placed too high and in the light of their experience should be reduced to three tons. That this opinion was not universal was shown at the other show, where one prominent commercial manufacturer showed a new five-ton truck, which had, moreover, a 50 per cent. overload capacity, thus bringing the nominal five-ton rating up to 7 1-2 tons.

Many Big Trucks Shown for First Time.

On top of this the present show chronicles the first public appearance of a new four-ton and a new five-ton, as well as the showing of another five-ton, and the cataloguing by the latter maker of a ten-ton machine. This latter is now the largest-capacity single vehicle in the world. In the light of these facts, it would appear as if the load limit not only had not been reached at five, but probably should be no less than ten tons. So the peculiar situation obtains, either the limit is three tons or the limit is ten tons; pay your money and take your choice.

Going into the details shows that the progress in load-capacity, if it can be called that, has been in the past largely a matter of the ability of rubber tires to stand up under the hard work. In fact, it may be pertinent to the subject under discussion, to repeat the statement of the maker of five and ten-ton machines previously spoken of. He says in part: "We could not build a successful ten-ton truck until the block tires were tested out and found satisfactory for heavy loads," and, again, "the wheels have been calculated so that the pressure on the ground does not exceed 700 pounds per inch of tire width, while the loads on horse-drawn vehicles commonly exceed a ton per inch of width." The latter are, of course, of steel, so that an analysis of this subject, and, particularly of the above statement, shows that the load progressed only with the progress in tires. In this connection, dual tires are on all of the heavy vehicles, and the block tires with individually replaceable blocks have made substantial and lasting progress. But the end of the tire question is not reached by any means.

New Spring Device on Newcomer.

It has been aided perhaps by suitable springing, Alden Sampson, for instance, fitting a spiral spring arrangement on the rear end of the very flat and very stiff rear springs. This carries the body empty and with very light loads absorbing all of the little shocks and jolts, while for heavier loads, close to the capacity of the vehicle, these are down tight together and consequently out of action, the stiff rear springs doing all of the work.

A side issue bearing indirectly upon this is the matter of carry-

ing the radiator upon springs. This very delicate part, always susceptible to the smallest shock, it thus adequately protected and one source of trouble and expense removed. The writer knows of a maker who tried to support the radiator on soft pine blocks; result, more broken radiators. Then very thick soft leather was used in combination with the wooden blocks; result, not as many broken, but a constant source of trouble. Thus it is seen that this is a big step in advance. If the fact that an ordinary heavy truck radiator in place represents no less than \$100 to \$124 (and repairs cost proportionately), is mentioned, the advantages of properly protecting this part are stated in a few words.

To note all of the springs is to see the use of wider steel, a lesser number of plates and a flatter shape. The springs are of a superior material, in some cases of an alloy steel. The flatter shape necessitates greater stiffness for the same length, which is secured without overdoing the matter by the use of greater widths. Some consideration is being given to the matter of spring suspension for the motor and transmission, although none is shown.

How Knox Has Solved Proper Unit Suspension.

This item of proper unit suspension is, however, solved in several ways, all of which bear the earmarks of careful design. The Knox truck has adopted the three-point suspension with the engine and transmission as one unit; the Autocar people have the three-point, it is true, but there are two units, the engine and transmission mounted upon a sub-frame attached to the main frame at one central point in the rear and two in front. Alden Sampson, on the other hand, has hung the engine on a sub-frame, which in turn is flexibly spring suspended from the main frame. On this car, too, the transmission and differential units are each on spherically seated three-point suspensions. Each one of these methods has its own individual advantages, while the general idea of all three is to relieve these important parts of vibration and the strains due to the distortion of the main frame, this latter being necessary.

Very Few Shaft Drives Shown.

But three advocates of the shaft drive are to be noticed, each one of these being an outgrowth of the same manufacturer's pleasure car business. Two of these, the Thomas town car and the Autocar delivery wagon, deserve no special mention, but on the third, the Franklin, is noted the use of a worm drive. This has perhaps an advantage for light work that cannot be overestimated, combining as it does with efficiency and other features, the more important one of noiselessness.

Some other outcroppings of this reduction in the noise idea, so noticeable in the pleasure car section, are to be seen. Thus Sampson has used a silent chain for the final drive, which has

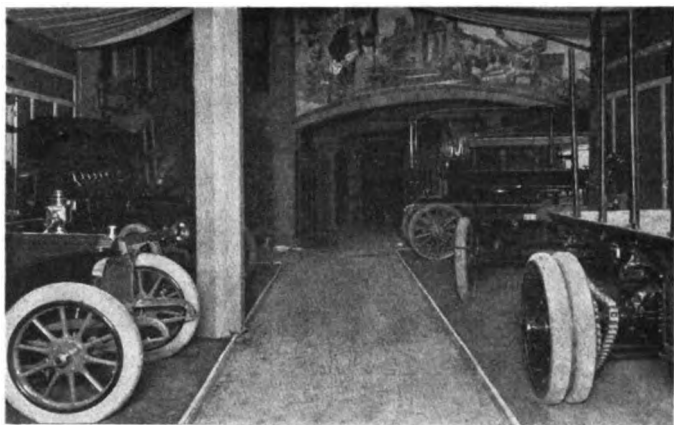

In the Basement the Commercial Vehicles Hold Forth.

been further augmented by the fitting of a chain case. The latter reduces the wear of the former, by providing proper lubrication and secure protection from dirt, stones, etc. Other makers have arrived at this point, where they admit the necessity of this and will furnish it upon demand. These latter have gone to larger stronger chains as a safeguard against future trouble.

As noticed at the other show, the unreliable differential is losing ground, in one case in favor of a positive acting differential of an entirely different type. An idea shown in working form for the first time at the Garden show is a differential lock. This is hand applied, the idea being that when one wheel drops into a rut or slippery place the driver can, by throwing in this lock, pull out unaided. Then, too, this had a positive advantage in the unusual case of a chain breaking. Then by throwing in this lock the car can limp home using one chain.

Small Cars Lead in Progress, Though Small in Numbers.

In the small cars the progress is perhaps more noticeable than among the larger ones. In numbers they are about equally divided, but the latter are nearly all newcomers, so that as showing the modern tendencies it would appear as if the smaller car was gaining ground faster than the large one. The Autocar Company show its light delivery wagon for the first time, a chassis, and one of the Atlantic & Pacific Tea Company's wagons being exhibited. An engine and transmission in a dummy frame illustrate the quick removable sub-frame, this firm being the only advocate of that form of construction.

Franklin shows a full line of air-cooled commercial cars. These include a taxicab, a 1,000-pound express wagon with covered sides, and a two-ton truck with open stake platform. In all of these the same motor is used, this being 3 3-8 by 4, four-cylinder of the regular Franklin construction. The usual features, full elliptic springs, wood frame, tubular axles, etc., are retained.



Electric Driven Ambulance Built by Studebaker.

Hewitt exhibits for the first time the chassis of a new two-ton truck. The phrase, "Pedals to push—that's all," indicates clearly the construction. The keynote of simplicity carries all the way through, thermo-syphon cooling, double opposed motor, planetary transmission and other features being present. This same maker also builds, but did not show, a three-ton truck on these lines.

Mention of the Electrics.

No discussion or mention of the power wagons would be complete without mentioning the electrics. These are out in force, and vary in numbers from a single machine by the Champion Wagon Company up to five by the General Vehicle Company, and six by Studebaker. The Champion exhibit is a 1,000-pound wagon for the United States Express Company. This has single motor equipment driving a countershaft by Morse silent chain, and from there double roller chains to the rear wheels. The motor is of the G-E 10-20 type. Wheels are 36 inches in diameter with 3-inch tires all around.

General Vehicle Company Has a Full Line.

The General Vehicle Company show an unusually full line, ranging from a 350-pound light delivery with single motor, left hand control, tiller steer and other delivery wagon characteristics, up to a 3 1-2-ton truck with double motor equipment, open stake body, wheel steer and heavy, substantial construction throughout.

The basement showing of the Studebaker company includes an 850-pound delivery, a 1,500-pound delivery, 2,500-pound express truck without a top and a five-ton open platform truck. The delivery wagons are both fitted with lever steer, while on the trucks wheels are used. The big truck shows good attention to details, the axles, springs and wheels being well proportioned to the load. Upstairs the rest of the Studebaker exhibit consists of a twelve-passenger brake and an ambulance.

Fire Apparatus Attracts Much Attention.

The marked attention being given of late to the vehicles for hospitals, and more particularly for fire service, is to be noted in a pair of fire wagons exhibited by the Knox company. One of these is a high-pressure hose wagon for the city of New York. This is on a five-ton chassis equipped with 60-horsepower motor. There are two plugs on each side of the wagon, four in all, allowing four high-pressure lines to be coupled on. These lead to a large, high, pivoted nozzle in the center of the car, which, except for height, answers all of the purposes of a fire tower. The body of the wagon is arranged in the form of bins, three being provided, to hold a total of 21 lengths of 50 feet each of 3-inch high-pressure hose. Additional space and running boards provide for the carrying of a large number of men. Another fire department first aid wagon is also exhibited.

The commercial cars as a whole, gasoline and electric, while few in numbers, make apparent big advances in almost every department. The progress in this line may be slow, but it at least has to offset that, the merit of being sure. It is to be regretted that the well-known pleasure car manufacturers now building trucks or some other form of commercial cars do not exhibit alongside of the strictly commercial firms, as the comparison would be invaluable for all concerned. Thus the Packard, Pierce, Peerless and Locomobile trucks added to those on view would have made an exhibition worth going miles to see.

CLEVELAND IS USING THE "TAXI."

CLEVELAND, Jan. 19.—A month ago taxicabs were regarded with grave doubt in this city. Now three concerns are operating them, with rush orders in for thirty-five additional cars. The Charles B. Shanks Company, using Chalmers-Detroit cars, and the Studebaker Automobile Company led off, followed by the organization of the Citizens' Taxicab Company. The latter company is using Elmore and Cleveland autocab machines, the latter being designed by Louis P. Mooers.

The Citizens' Company is headed by a former New Yorker, Francis J. Wallace, and is devoted solely to running taxies. The cabs ordered by them are now arriving in this city.



A View of the Artistic Waverley Exhibit.

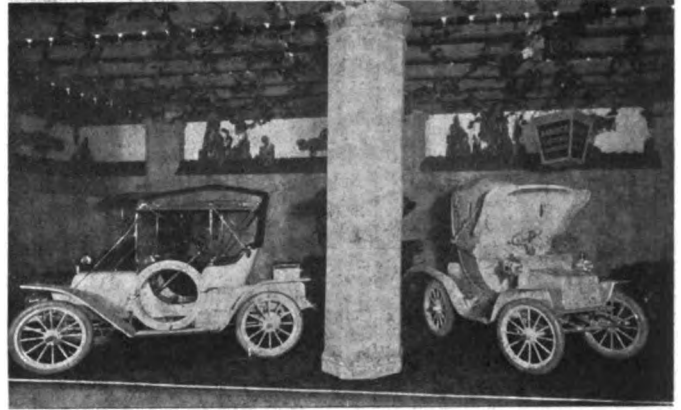

Babcock's Natty Runabout and Bridal Car.

ELECTRICS, VASTLY IMPROVED, ARE VERY POPULAR

THE electrics, segregated as they are in a neat little entrance hall, beautifully finished off, have some advantages in location alone, in that they will not be bothered by the vast crowd of the curious, only those vitally interested being at the pains to hunt them up. That this is fact rather than theory is shown in the number of people present there at any one time as compared with the main hall or balconies. With this geographical advantage of location we find the additional advantage of harmony, in that the exhibits all harmonize. Nearly every maker shows a closed body in black finish, usually a brougham; every one except the E. V. Company show in addition a victoria phaeton; in addition all have an exhibit of batteries, motor, or final drive, something to compare with the finely finished chassis of the gasoline cars, and perhaps the most noticeable feature of all is the runabout. In the attention given to this and the prominence accorded it in the exhibits, together with the bare idea of such a design, we find the first indication of the gasoline car practice. This is evident not alone in the body, but also in the phoney hood, the wheel steer, arrangement of the control with long vertical side levers, the use of some form of dashboard, the swing and style of the fenders, straight lines of the body, style and appearance of the top as well as many small mechanical details.

All these bespeak the success of the gasoline car and the desire of the electric makers to get in on it. This is very praiseworthy, but as much cannot be said of the working out of the idea, for that has seen the first evidences of a loss of identity, the electric by a process of future development along this same line, finally degenerating into a virtual copy of the gasoline car with only the substitution of electric power.

Bailey shows a very attractive victoria phaeton with beautiful body line. This had a most unusual steering wheel, the peculiarity being in the shape, circular for about two-thirds of the circumference, the rest of the wheel consisting of two straight sides. A runabout of strictly gasoline lines made a very attractive appearance.

Baker was one of the premier advocates of few batteries, thus securing light weight, and this company has about the smartest raciest looking runabout seen yet. This has a high-speed capacity when required with all of the usual normal speeds for ordinary work. A long wheelbase, rakish tilt to the left-handed steering post, and long sweeping fenders give a low long appearance which indicates speed. A liberal use of annular ball bearings makes for easier running and higher speed.

The only vehicle shown by the Electric Vehicle Company is an inside operated brougham, known as Mark LXVIII. This is a very luxuriously finished car, the upholstery and trimming being worthy of particular mention.

Considering the geographical location of the Anderson factory

at Detroit, close to the always successful Packard, it is not surprising that this firm's runabout closely resembles in appearance that well known car. The straight line body, the wheel and hub caps, springs and spring hanging, all show traces of the original from which the copy was made. The copy possesses in its own field, too, equally as much merit as the original.

While Rauch & Lang manufacture twelve different cars in six styles, but two are shown, a coupé and a phaeton. In addition to the former, a very popular Winter car, and the latter, a more pleasing type for warm weather use, a set of batteries wired up to a motor, as well as the controller, were shown on a dummy sub-frame.

As this was the first portion of the automobile field exploited by Studebaker, this large concern, it is but natural that a very strong exhibit would be made in this division. The runabout, phaeton and coupé are all shown, in addition to which there is shown a four-seated brake and an ambulance. The latter is a great source of interest and evidences great attention to details of construction on the part of the factory. Thus the rear end of the body has two separate and distinct spring suspensions. The chassis is on a pair of semi-elliptic springs, while the body is hung upon a distinct set of springs of the full platform type.

The Waverley Company exhibit upon entering the hall is the first sight to greet the eye. These are the two new types with the even newer features. But best of all is an electric exhibit of the motor and rear axle construction, showing the enclosed double gear reduction, the floating rear axle, etc.

The Woods Motor Vehicle Company has wandered away from the crowd in location at the show, being on the elevated platform, commanding a fine view of the main hall. This commanding view and isolated position are perhaps typical of the maker's standing in the industry. The use of annular ball bearings throughout the car, no less than sixteen being used of the highest grade, makes a fine showing for the prospective purchaser. The idea is that the ball bearings alone do represent much, but taken with the fine workmanship necessary in conjunction with the proper use of these imported bearings, means much more. A complete assembly frame is shown, this including motor, reduction gears, differential and countershaft. A noticeable feature is the use of herringbone reduction gears. These are very expensive to manufacture and assemble in comparison with spur gears, but otherwise all of the advantages are with the herringbone. The sprockets, too, show careful workmanship, being cut from dropped forged blanks and carefully hardened.

Taken as a whole, the electrics seem to have gained in popularity, coincident with improvement in electrical and mechanical details, superior materials, improved workmanship and up-to-date design. It is not strange in the light of these detailed improvements that the 100-mile car is in evidence.

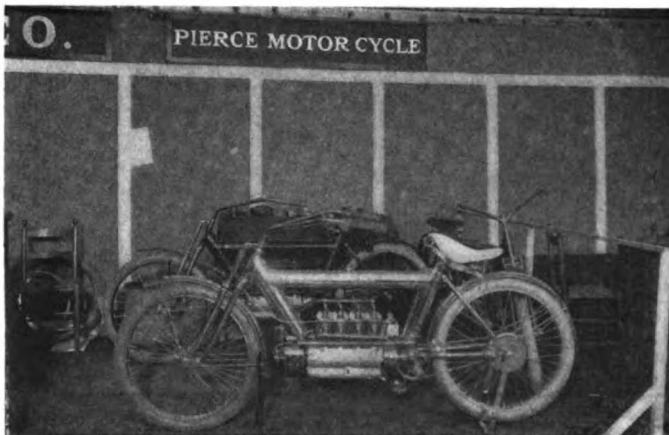

Pierce Company Displays an Attractive Four-Cylinder.

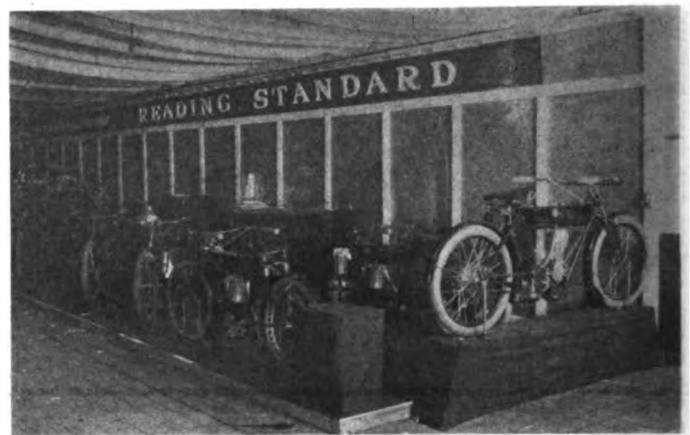

Reading Standard, One of the Motorcycle Pioneers.

MOTORCYCLES FOLLOW AUTOS—SHOW BIG IMPROVEMENTS

THE tendencies among the motorcycles seem to be those that bring this vehicle closer and closer to the automobile. This industry, if it may be properly classified as a separate industry, seems to be going through the period of change preceding a period of standardization, which was peculiar to the automobile industry a year or a year and a half ago. The question of ignition, relative to single or double, magneto, timer or both, which finally resulted in the nearly universal adoption of single ignition with a magneto as a source of current, is now being fought out once more in the motorcycle division with the added zest lent by the fact that the make-and-break system has a proportionately larger and more influential following. The handwriting on the wall is seen in the adoption of the Bosch magneto as a single source of current on such leaders as Pierce, F. N., M. & M., Peugeot, Royal and N.S.U., also fitted as an extra on Excelsior, R-S and Thor.

Another feature in which automobile influence is shown very markedly is in the number of cylinders. The two-cylinder finds many more adherents than does the single; in fact, this tendency is so marked that hardly a manufacturer present has had the temerity to stake his reputation on single cylinders only, all showing both single and double cylinder models. In this case, too, the multiple cylinder machine is given the preference over the one-lunger. This tendency is being carried forward to the four-cylinder, as it was a year ago in the automobile field, being plainly shown in two four-cylinder models exhibited, both being comparatively recent arrivals, but in each case from an old-established house. Rumors of several more four-cylinders the coming season are heard.

In this connection the matter of valve operation similar to the four-wheeled machine motor is gradually receding from

suction inlet valves towards mechanically operated and interchangeable valves. In this class, which is constantly growing, we find to-day N.S.U., Royal, R-S and others.

The final drive, too, shows a decided leading towards the practice of the past on the four-wheeler; that is, in the increase in favor of the positive drive over the friction or belt drive, and in the former class the gain made by the shaft. One year ago to-day there were no shaft drives; to-day, two of the latest models show them, these two incidentally being the two four-cylinder machines. The chain continues to gain over the belt, and in turn has lost some adherents to the shaft class. Six chain drives were observed and seven belts, but of the latter the V or trapezoidal belt had four adherents. As the latter is very close to chain construction with its wedging non-slipping action, these might without serious error be classed with the chains.

Not the end of this list of comparisons, by any means, is the matter of transmissions and clutches. Where one year ago these were unknown in the two-wheeled vehicles, the present show reveals one or two of the latter and still more of the former, the stock argument being usefulness of low speed for

In materials, too, the hue and cry raised a year ago in the motor world has awakened the motorcycle man to the great advantages of superior materials. So we find a liberal use of nickel and other alloy steel for crankshafts, wrist pins, valves and other parts, as well as a lot of special steel for springs, front forks, etc.

Longer wheelbase, larger tires, better and more comfortable seats, more cars fitted with foot rests to allow a change of position, longer and more comfortable riding handle bars, a lower center of gravity, better mudguards, a more efficient exhaust system, and stronger frames, are the more noticeable changes.



A Very Complete Line Is Exhibited of N. S. U. Cycles.

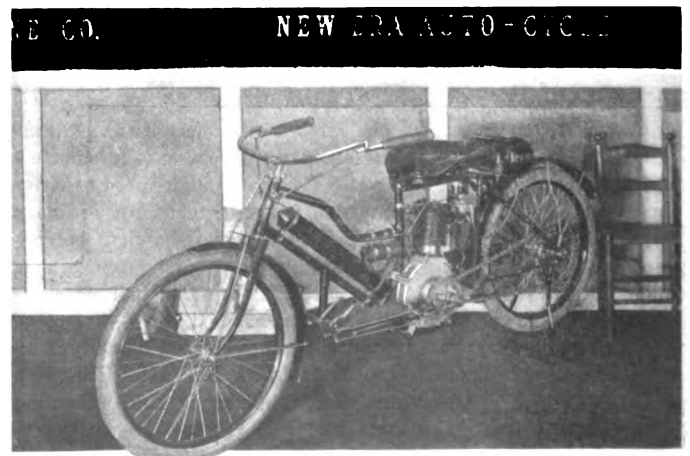

New Era Auto-Cycle Has Attractive Appearance.

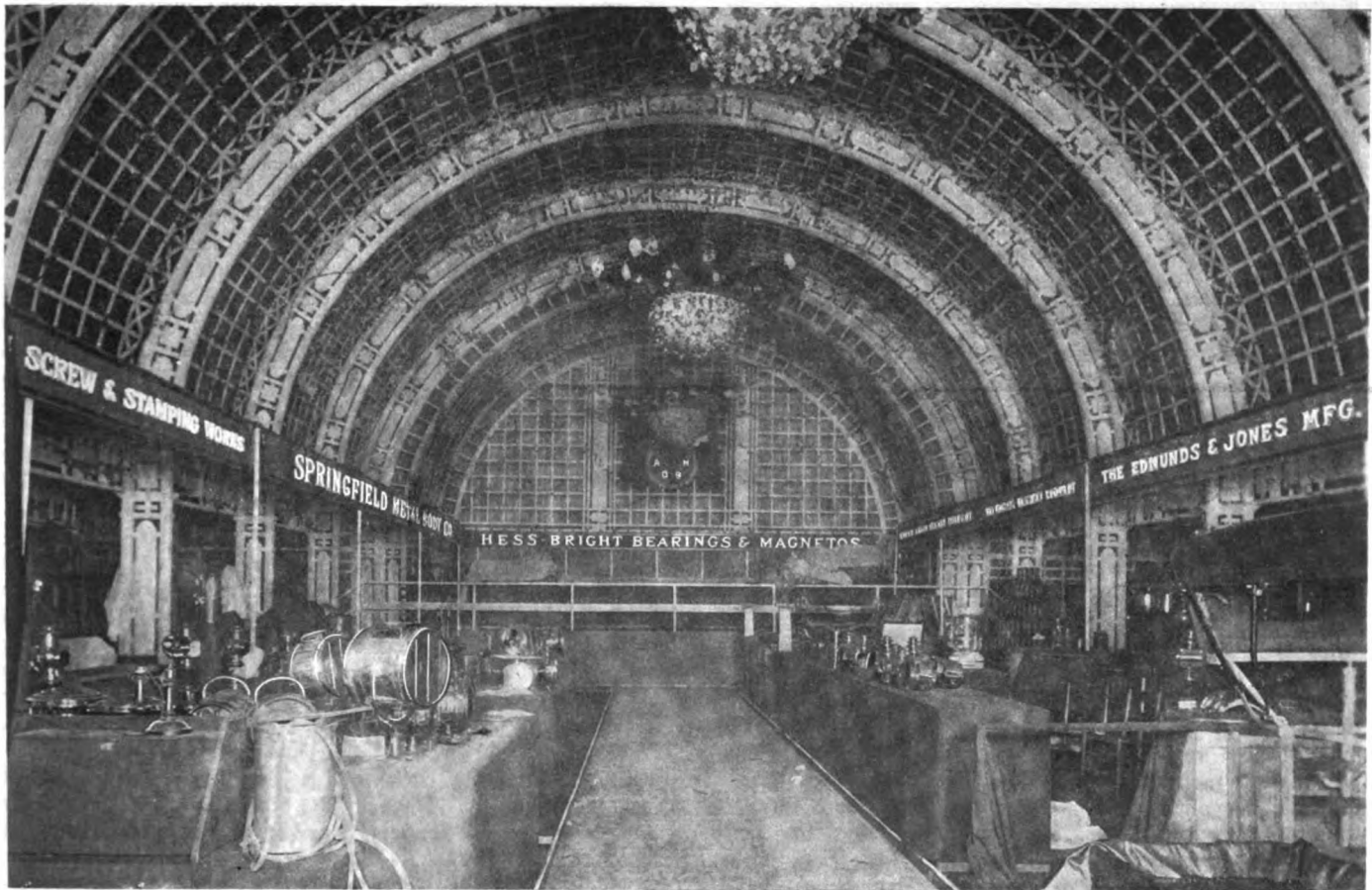

Concert Hall is Most Artistically Arranged and the Accessory Makers Housed Therein Are Happily Comfortable.

ACCESSORIES WITH FIRST 1909 SHOWING IN THE GARDEN

AFTER the cars have been examined—and often before—the innumerable accessories command the most careful interest and examination. The proof of this is easily demonstrated by the coteries assembled at the various spaces where something is added making for the more complete and greater enjoyment of automobiling.

At the Garden few of the accessory exhibits seen at the Grand Central Palace are missing, but as many are added as subtracted from the grand total.

In a general way, it may not be out of place to mention one or two tendencies. For illustration, it is quite plain that “non-skids” have the center of the stage in one zone of activity; then there is a fine display of “demountable” rims, and “detachable” ideas are there in plenty. In a word, the “footwear” of the auto is receiving much attention.

It is also a fact that the question of lubrication is so thoroughly in hand as to render it a conspicuous feature of the accessory exhibition at the Garden. Autoists now appreciate the fact that the absence of an oil bill is a sure sign of a repair bill, and they also know that the oil bill is the least of the evils.

Of jacks and such devices there is also a good showing; but it is the ignition situation that is the most on the surface, if indications count for anything. All through the booths, and down in the cars, everywhere, the ignition question is uppermost. There are points in relation to this phase of the automobile which would stand much discussion were the time and the space available. In the first place, if the earlier schemes of igniting had faults, the same faults are now conspicuous for their absence. The reasoning of last year is defective this year, and it is more of a problem than ever to be able to decide in an unbiased manner the means for the end.

Magnetos are quite as conspicuous as before; they are in

superior form, just as one would reason; but it is not any more plain that they should be applied in one way or the other than it was some time ago. The other side of the question is as full of meat as a cocoanut, and the “magnetic spark plug” is having a large say. Then, there is the unit coil, the Atwater-Kent system, the master vibrator and numerous other details, all so carefully worked out that it is a great game to look them up and discuss their relative advantages, only to conclude that it is simply a matter of appropriate selection in the long run.

So on, all through the show, devices of merit, each in its place, all displayed to the greatest advantage, and interested spectators everywhere. It is a source of regret not to be able to render again a full description of all the accessories at the Garden, but the information will be found in *THE AUTOMOBILE* of last week, or the week before, or the week before that; in the meantime it will be the aim to discuss such new matters as the search is sure to unearth.

TIRES AND ACCESSORIES.

Atlas Rubber Co., Buffalo, N. Y.—The exhibit of this company consists of a non-puncture inner case. This is a device looking not unlike a very light cloth-covered outer shoe, which is placed between the shoe and the tube. When this is done punctures are absolutely impossible. This feature is secured by inserting, in what might be called the tread of this inner case, a series of flat discs of steel. These overlap one another and enough are used to protect completely the inner tube. These strips are very thin and not very wide, being about 1-32 by 3-8-inch in cross section, but the size is kept down purposely so as not to increase seriously the weight of the tire nor impair the resiliency.



Dow Demountable Rim, New York City.—The very general interest of the past year in methods of quickly removing a punctured tire and replacing it with another good tire has culminated in a lot of demountable rims, tires and wheels. One of the best of these is the Dow rim shown in the basement of the Garden. This consists of a series of five converse wedges on the felloe which co-operate with an equal number similarly placed on the rim. These not only taper in a circumferential direction but sideways as well, so that when once turned on the rim simply cannot come off; when turned so as to come off the two tapers aid in removing it quickly. This turning is easily accomplished by means of a rack fastened to the rim, the turning of it being done by a key with teeth on it, which teeth engage with the rack. A locking device or plate is simply to prevent change of relative position, and while it takes the driving strain, the size is such as to preclude any possibility of failure. The change with this rim may be made by a novice in a few seconds, the reverse process of putting it on being made with equal facility and speed.

Hopewell Bros., Cambridge, Mass.—Not the least of the exhibitors is the showing of the garment makers. This firm shows fabrics, robes, vests, etc., as well as the Hopewell tire case. Now that a great deal of interest in the subject of tires

has been aroused, many autoists who did not do so formerly are now carrying extra or spare tires. To do this properly requires a tire case. The tire cases made by this firm have many points of superiority and many special features, all of which go to make a trip to its booth in the gallery well worth while. They have no buttons, no laces, are perfect fitting, and absolutely waterproof. If that doesn't suffice to arouse curiosity enough to visit the exhibit, then the case is hopeless.

Trenton Rubber Mfg. Co., Trenton, N. J.—Prominent in the balcony is this firm, manufacturers of wrapped tread tire casings, other rubber specialties, and "Thermoid" brake lining. The latter has attracted a whole lot of attention during the past year from the fact that it will not burn out, lasts indefinitely, and grips instantly. With these sterling qualities it could not help but be a successful lining for brakes. It is made in all standard widths from 1 by 1-8 inch up to 4 by 1-2 inch, but may be had in any length, width and thickness. Aside from rubber tubing and other minor rubber specialties, the wrapped tread casings attract the most attention. These are very well and carefully manufactured, the tire is perfectly and uniformly cured, at the same time guarding against buckles and blisters. The price of these is low, giving the buyer either the same tire for less money or more value in the tire at the same price, so that the buyer wins out either way.

Nadall Mfg. Co., Chicago.—One of the best of the demountable rim devices is shown at this stand, this, by the way, being a newcomer. The rim has a series of three arc-shaped shoes which hold the clincher rim to the felloe as they are forced radially outwards. This forcing is done by means of a special wrench which fits a nut on the inner projecting ends of the shoes. When rotated one way this pushes the shoes outwards, locking the rim in place, while rotation in the opposite direction serves to loosen it. A locking device at the end is covered by means of a light brass threaded ferrule which also contains a lubricant, thus keeping the whole device in an operable condition at all times. The shoes, which are the important

part, are of cold rolled steel, 3 inches long, 1 inch wide, and 1-2 inch deep at the thickest part. The outer surface of these is curved, this curvature being the same as that of the slot in the clincher rim which receives it, both radii being different from the radius of the inside of the rim. Beveled edges allow pressure upwards and to the side, as well as an easy entrance of the shoes into the slots.

U. S. Spare Wheel Co., Detroit.—This is a new spare wheel with a quick attaching device. The wheels are light, yet very strong, without felloes, spokes or hubs. The ingenious mechanical fastener consists of four parts, two stationary and two locking clamps. The two latter operate by the simple pulling up of a ratchet lever, which may be done as quickly as it is told. To release, a catch is held up by the thumb and the lever pushed in the opposite direction. All arguments applied to spare and demountable wheels and rims

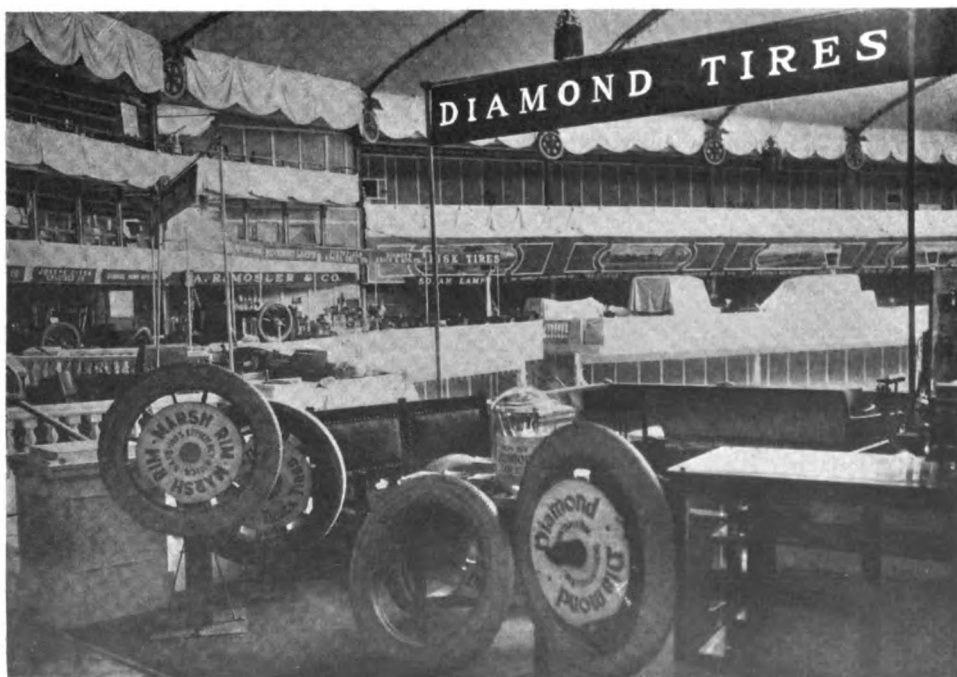

apply with equal force to this one, the quick-locking device being an additional good point.

TANKS, RADIATORS, ETC.

Avery Portable Lighting Co., Milwaukee.—These pioneer makers of gas tanks under the trade name of "Autogas" show the three automobile sizes and the very newest motorcycle size. The latter is a small one, being but 2 inches in diameter by 15 inches long. At that it will supply a one-quarter foot burner for 28 hours. The cylinders used for all of these are of cold drawn seamless steel of a heavy gauge, the bottoms being double and brazed to resist greater pressure than the sides. After plating they are tested to 800 pounds, so that with the filling restricted to 225 pounds pressure a factor of safety of over 3 1-2 is secured. To insure additional safety, a plug is fitted in the bottom of each tank, which will rupture at 500 pounds and permit the gas to escape. The idea of this is to preserve the tanks, which in comparison with their contents are very expensive. The tanks are fitted with purified and dried acetylene gas generated at the factory in special large generators. The pressed steel boxes for carrying an extra tank on the running board were also shown, these being of simple yet pleasing design and extremely neat in both internal and external appearance.

Auto Pump Co., Springville, N. Y.—This is one of the simplest and plainest yet most useful exhibits of the show, being but an exposition of the Spencer power air pump. It is a one-cylinder pump for tires and has two pistons, so that the single cylinder is as effective as two. The shape is such as to allow holding in the two hands while connection is inserted and held in the end of the starting crank. To allow this a special starting crank with a ratchet is furnished by the company, the ratchet allowing the crank to remain stationary while the pump is in use. Although small and inexpensive, this is very carefully made and every one is tested to 120 pounds pressure.

A-Z Co., New York City.—Surrounded by a bulwark of square tube radiators, as made for Lozier, Stevens-Duryea and many others, the real exhibit of the details of this company's construction are effectually hidden. Behind the bulwark, however, one finds an exposition of a new departure in radiator construction. This is of the bulge square seamless tube type supported on ball trunnions on either side, the latter following out the more modern tendency to do away with a solid fastening for delicate radiators. Various sheet metal accessories and novelties are shown, including hoods, fenders, trunks, mufflers, etc.

Livingston Radiator Co., New York City.—The excellent showing of square tube effect radiators as made for such discriminating buyers as Simplex and others, attracts much attention. The good features of this square tube, aside from the improved appearance, are more efficient cooling, due to larger air surface per square foot of frontal area, increased flow of water due to larger water

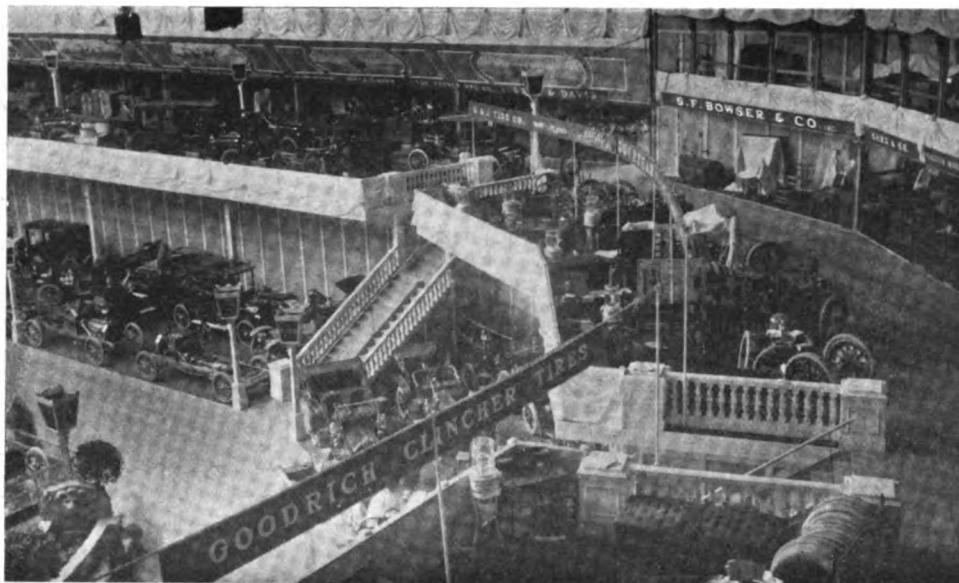

spaces, lighter weight per surface unit, strong non-leaking joints, and other minor points. All these are brought out at the exhibit space by the use of sections completed and partly completed, showing the various processes of soldering the edges of the sheets, etc. The radiators may be had with a seamless case or with double seamed and securely soldered joints. To insure against leakage from any cause whatever, all radiators are tested at the factory to 20 pounds pressure with both hot and cold water, while frequent tests using 40 pounds have had no serious results nor any breaks.

Lunkenheimer Co., Cincinnati.—The product of this concern is almost too well known to require any mention, including as it does all kinds of brass goods, gasoline strainers, priming, oil and grease cups, generator valves, etc. Recently, however, several exclusive automobile specialties have been developed. Chief among these are the multiple-feed mechanical oilers. These are made to suit individual requirements and may be had with or without an independent manifold or sight feed. These are worm driven from the belt shaft and may be had in any number of feeds from four on up. The pump portion of this is very simple, in marked contrast to the usual complicated pump. Another new specialty recently brought out is an exhaust pressure regulator which may be used anywhere that pressure is desirable,



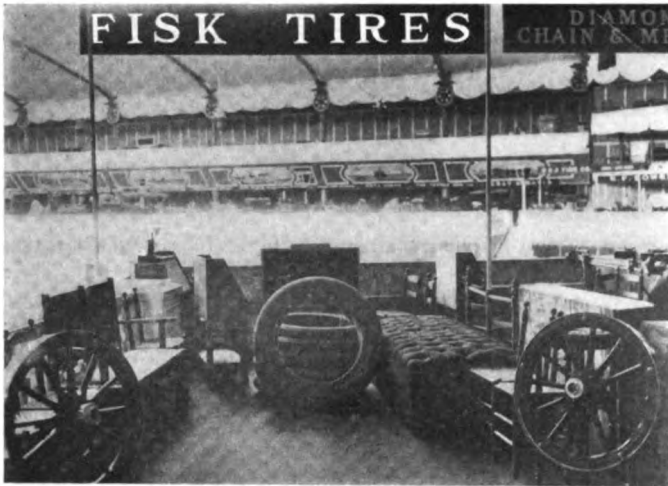

Fisk Exhibit Had a Picturesque Look and Outlook.

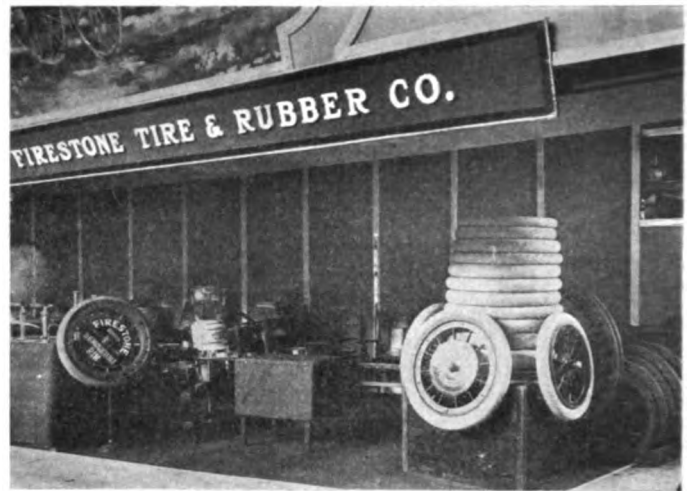

The Firestone Solid and Pneumatic Were Both Here.

as in connection with oil or gasoline tanks located at the rear of the chassis, for operating an exhaust pressure lubricator, or any similar use. This is a very simple positive device of small size, which in use has been uniformly successful. It has found favor among the autoists of discrimination and it is well worth looking into.

gasoline is rendered available at will, in just the right measure. In some cases the pump is located inside of the garage, and, again, for the greatest possible safety, the pump is located out of doors. In all such cases a suitable cabinet is to be had from the Bowser company, and, with the gasoline protected from evaporation, water excluded and the whole under lock and key,

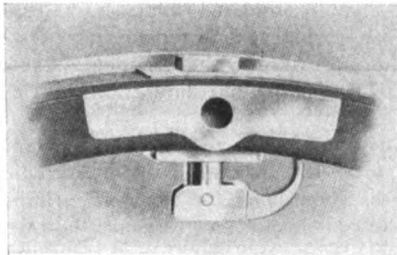

Dow Rim Showing Key In Position for Use.

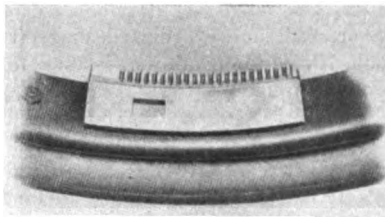

Dow Rim Showing Clamp Fixed to Felloe.

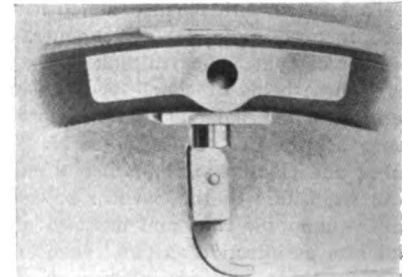

Dow Rim Showing Key Inserted to Make Ready.

S. F. Bowser & Co., Ft. Wayne, Ind.—This is the company whose equipment covers the field of gasoline storage on a basis of economy and safety. The exhibition at the Garden is of the greatest interest and includes a line of storage tanks, as well as pumps, of the class that will not only handle gasoline, but measure the same as well. It will be remembered that with the Bowser system the tank for the gasoline is underground, and by means of suitable piping to a pump conveniently located the

the system is one of the best investments for the autoist of business acumen. Then, there is the insurance question to be taken into account, and it is one of the advantages of the Bowser system that it is so good as to meet with the entire approval of the Association of Fire Underwriters. Thus, the installation must be made according to "code," but it is the practice of the Bowser company to furnish all the information required for the purpose so as to make it simple for the purchaser.

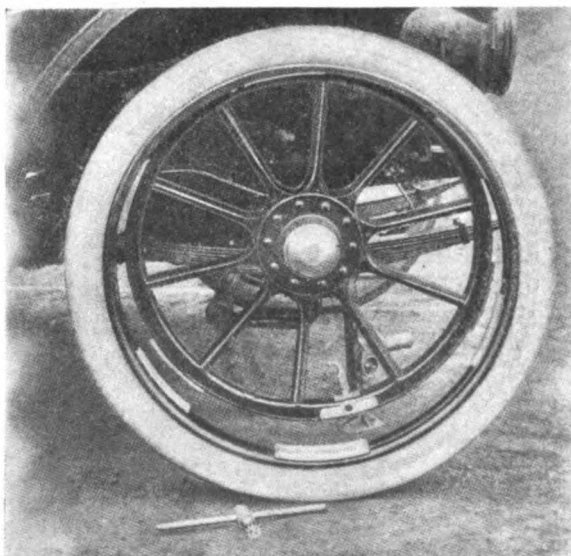

Dow Rim With Tire In Place Ready to Slip Over.

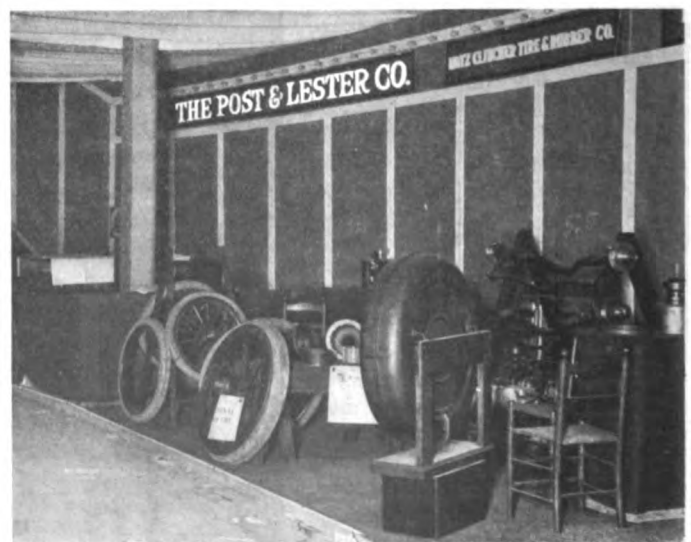

Where the Motz Clincher Tires Were Shown.

GOOD LUBRICATION AN AUTOMOBILE'S NECESSITY

Adam Cook's Sons, New York City.—This old and well-known firm showed the equally well-known Albany grease in four grades. The product is, however, made in seven regular numbers. Of those shown Nos. 0, 1, 2, and 3, the first two are for transmission, equalizing or other gears, the former in Winter and the latter in Summer. For other automobile uses No. 3 is recommended for Summer and the lighter, No. 2, for Winter use. This is a pure lubricant, which, its makers state, does not drip, splash, or waste away, is self-acting, and runs only when the parts are in motion. The quality of all of the seven numbers is the same, the only difference being in the consistency, this being done to suit the use for which it is intended. The exhibit was a simple exposition of the product on its merits, no attempt being made at original and startling effects.

Columbia Lubricants Co., New York City.—Prominent at this stand were two large glass cases, the one having a full line of this firm's familiar Monogram oils in the various grades.

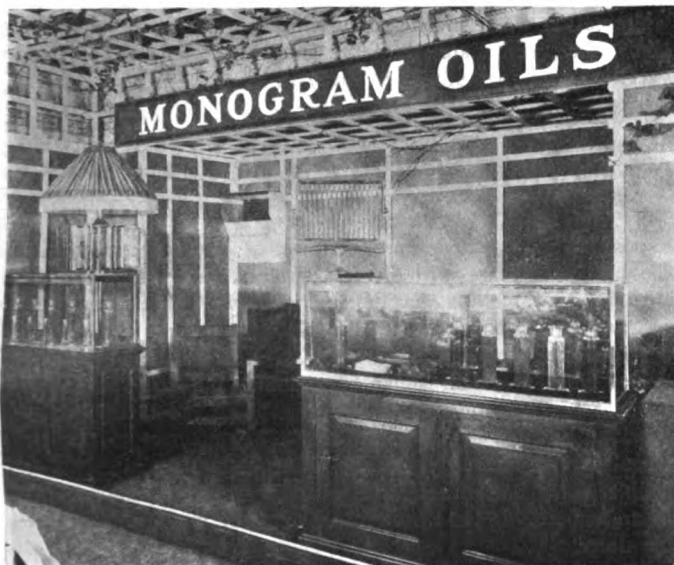

Monogram Oils Made an Effective Showing Here.

The other case held a rather unique and most interesting exhibit of the various numbers in the oil refining series, including waste and other undesirable products. By showing the process and undesirable constituents alongside of the pure finished product, the effectiveness of the latter was doubled. This is an oil that was developed for racing purposes where the question of price does not enter. In this line the oil has been uniformly successful, the first three cars in the Vanderbilt Cup race and the first five in the Savannah Grand Prize race being users of this product. No expense is spared in the factory production of this oil on the supposition that once a Monogram user always a Monogram user.

George A. Haws, New York City.—"The Oil that will not Char," the old standby Panhard in the familiar checkerboard cans, was shown, the three grades being exhibited in simple form, but the red cross-barred cans formed the greater portion of the exhibit. Every owner and driver of a car should be made to realize, early in his autoing career, the extreme importance of good lubrication, and that the use of the best grades of oil is the only safe policy to follow. In the line of well and carefully made products, containing no free tarry matters without lubricating value at high temperatures and with the inevitable decomposition, this product stands forth in a class distinctively its own. The adoption of the sealed spout on the can, preventing the substitution of inferior products, is one that cannot be com-

mended too highly. In these days of bargain, fire and other "wonderful" sales, anything that absolutely insures the identity of the product is a welcome change to the grateful autoist. In connection with Panhard oils and lubricants in general, attention is called to the fact that "light" as applied to oils refers to the gravity and not to the color, so that the lightest colored oil is not of a necessity the best. A little folder which this company is distributing gives, besides a full list of well-known cars and the correct grade of oil for use thereon, a series of trouble preventers under the heading, "Useful Hints."

White & Bagley Co., Worcester, Mass.—The products of this company bear the euphonious titles "Oilzum," "Cleanzum," and "Washzum." The last is a linseed oil car soap for washing cars. This is said to wash easier, quicker, and cleaner than other soaps, besides improving the luster of the varnish. "Cleanzum" is an antiseptic hand cleaner, put out in large 10-cent cans. The first-named, "Oilzum," is, however, the principal product. This is an absolutely carbonless cylinder oil and is made in five



Where the Original Panhard Oil Made Its Display.

grades, one for White steamers, one for Stanley steamers, and three other grades for gas engines. These are a heavy oil for air-coolers or low compression motors, medium for particular use on splash systems of lubrication. The third or light-bodied oil is intended primarily for cylinders. This is especially useful with tight-fitting pistons and for Winter use in all forms of cylinders. The carbon test of a pair of valves shows the big advantages of the product, one with a common oil showing carbon deposits after 150 miles running, while at 4,000 miles the valves with "Oilzum" were as bright and clean as when new. A little booklet, entitled "Oswald, the Chauffeur," is being distributed. This is a neat little love-story in which "Oilzum" plays an important part, and is told in the vernacular of the streets.

W. C. Robinson & Son Co., Baltimore.—In the selection of a good oil, the autoist should be guided by its record in the past, the appearance of it, and the feel. The last two were clearly shown to the people in this exhibit where five grades of the well-known Autoline oil were allowed to run from one series of cans to another over a plate of glass. Beneath this was placed a series of electric lights so that the appearance of the oil could be clearly seen. The troughs in the glass through which the oil ran were open so that one could feel of the oil. As to its past record, the company has been in the business for many years and "stands pat" on its reputation. This exhibition was a striking one, which drew an interested crowd at all times.

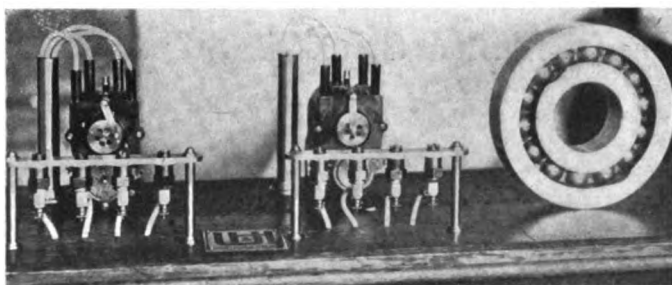

U. & H. Magnetos and F. & S. Bearings—Bretz Co.

Vacuum Oil Co., Rochester, N. Y.—Under the trademark of Vacuum Mobiloil this company has established a world-wide reputation for its product. The latter is made in five grades and a cup grease. Featured at this stand and particularly applicable at this time of year is the new oil which has been brought out very recently. This will bear the high-sounding name of Gargoyle Mobiloil Arctic. Its special features are non-carbonization, zero cold test, and will feed through any lubricator in any weather. The cold test feature is the one which makes the latter claim possible and really is a very desirable one from any point of view, for one may reason if any oil will work well in zero weather it must work as well and probably better in warm weather. A neat little 5 by 6 catalogue, distributed at this booth, gives pictures of the Vanderbilt and other famous races. In

the back of this four-pages devoted to emergency notes and three on sparks, are followed by a list of no less than 500 American and foreign cars, a grade of Mobiloil being recommended by each.

W. P. Miller's Sons, Long Island City, N. Y.—At a commanding position in one of the balconies was located the extensive showing of this firm's "Pan-o-lite" and excelsior automobile cylinder oils, excelsior Fiberous oil, and Miller's grease. This booth shows the characteristic energy of this firm which last Fall was displayed equally well in another way. This was at the scene of the Vanderbilt Cup race, where this firm was the only one to establish an oil camp to supply contestants with oil during the race. A series of postal cards showing several views of this camp were distributed.

W. R. Winn, New York City.—Not to be outdone by larger exhibitors with more space this maker had his small space very attractively arranged. The showing consisted of a line of gas engine cylinder oils in four grades, several grades of steamer oils, and a hand soap. The latter known as "Cleaneasy" is useful for all other purposes as well, but for the hands the writer knows it to be a very effective and efficient cleanser, in which respect it lines up to its name and "cleans easy." An extremely convenient and practical idea is the sale of snow white cotton waste in one-pound closed packages saving thereby labor, time, and material to the small dealer, besides being an excellent way for autoists to carry it.

IGNITION SPECIALTIES, COILS, PLUGS, SWITCHES, ETC.

American Electric Fuse Co., New York City.—The American Igniter combines within itself timer, coil and high-tension distributor. The whole is contained in a hard rubber case about four inches in diameter and three inches deep, and is connected on one side to a storage battery and on the other directly to the spark plugs.

E. M. Benford, Mt. Vernon, N. Y.—The "Monarch" line of ignition specialties comprises spark plugs of both the mica and porcelain types and a roller-contact timer. In the latter, both roller and contacts are made of imported tungsten steel, which is claimed to eliminate all wear in these parts. The ground connection is through a spring plunger in the cover bearing against the end of the shaft. The body is a solid piece of fiber enclosed in a nickel-plated shell. A special plug has been brought out for use with magnetos, in which the insulation, of mica, is twice the usual thickness.

R. E. Hardy Company, New York City.—A novelty at this stand is the combination spark coil and plug. The coil is mounted on the outer end of the plug in a tubular casing of non-conducting material. One master vibrator and condenser is used with any number of these plugs. Only the primary wiring is

exposed. This system has been in use experimentally during the past two years with perfect success. It is said to be especially desirable for marine engine work. The standard line of "Sta-Rite" spark plugs is also shown.

High Frequency Ignition Coil Co., Los Angeles, Cal.—The Seeley ignition system shown here mounts the spark coils on the cylinder heads in individual fiber cases about two inches in diameter and an inch and a half deep. They connect to the spark plugs through short brass strips. The system operates on eight ordinary dry batteries, and is claimed to draw only one-tenth of an ampere. It has no vibrators or other moving parts except the timer.

Mica Core Mfg. Co., New York City.—Two new ideas in spark plugs may be seen in this exhibit. In the "Eccentric" plug the spark gap is adjustable by turning the central electrode. The inner end of the shell is bored eccentrically, and the sparking point projecting at right angles from the electrode is by this means brought towards or away from the shell. The "Circle-Fyre" plug is of the closed end type and the central electrode is formed with a head at its lower end that will just pass through the opening of the shell. When the core is placed in the shell a circular spark gap is formed. The Raves timers and distributors are also shown.

Never-Miss Spark Plug Co., Lansing, Mich.—This company exhibits the well-known "Never-Miss" plugs in magneto and battery styles, all of which are guaranteed for one year. A novelty is their small clock intended to be fitted to one of the spokes of the steering wheel.

NAME PLATES, ETC.

Chandler Co., Pittsburg, Pa.—Name-plates and monograms of all descriptions are shown at this stand. They are made by a number of processes—stamping, casting or acid etching, according to the nature of the work required. The exhibit comprises specimens of each of these varieties, in the shape of name-plates for motors and gear-boxes, dashboard name-plates and license plates, names in special designs for demonstrating cars and initial monograms for individuals owners. In fine, it is an exhibition of name-plates along stock lines, or specials.



Lavalette & Company Showed Their Goods Here.

MATERIALS AND WELDING.

Erie Foundry Co., Erie, Pa.—Castings, gray iron castings, cylinder castings, in fact it would be to repeat the word casting as many times as there are kinds of castings in an automobile if reference is to the kind that look good, are made of good materials by a process which augurs for quality. Cast vertically, of a uniform thickness of walls, due to the fine core work and to the fact that the Erie is with the requisite experience, the specimens to be examined at the Garden are as a drop in the bucket by way of an approximation of what can be done in a foundry which is equipped for the work and caters to the automobile trade.

Thos. Prosser & Son, New York City.—It will be remembered that this well-known company represents Freid Krupp, A. G. Essen un Ruhr, and the display at the Garden includes the line of special auto steel as turned out by this firm of German gun makers. The line for this year includes spring steel of the better grades, as well as the usual run of Krupp chrome nickel steel; then there is the line of nickel steel, and die forgings in all the well known Krupp grades. In side frames the company reports considerable activity, using the well-known grades of Krupp steel for the purpose. The autoist who has the time to go to the Krupp exhibit will be able to see the extent to which alloy steel can be deformed without fracture, which is the sign of quality. Nor will it be a sign that the steel can be deformed easily. As a matter of fact, some of the steel resists on a basis of even 220,000 pounds per square inch when it is treated, and even in such cases the elastic limit is as high as 200,000 pounds per square inch. On the other hand, much of the steel is relatively soft, and the tensile strength can be as low as 100,000 pounds per square inch, with the elastic limit somewhat below this point. In all cases it is the claim of the company that the elongation and the kinetic properties are held at a very high point in the grades of Krupp steel used in automobile work.

Davis-Bourneville, New York City.—This exhibit is one that attracts a good deal of notice because the process is new, and it is also becoming of the greatest importance in automobile work. The exhibit comprises examples of the company's line of acetylene generators, with oxygen tanks to go with them, as well as regulators and the detailed parts such as will enable anyone to weld parts of any material. Cylinders are repaired by this process, aluminum cases are made as good as new, and in fact there is no part in an automobile that cannot be fixed by the process; even a crankshaft can be mended. Oxy-acetylene cutting is of the greatest interest, and the "artist" at the Garden will tell all about it.

TOOLS THAT MAY COME HANDY.

Cook's Standard Tool Co., Kalamazoo, Mich.—A line of "jacks," all with reversing levers as the 1909 feature. That the reversing lever is a decided advance on the old button idea is assured, the proof of which lies in the fact that autoists cluster around the booth and praise the new one for its close conformity to the needs; as every autoist sees it instantly he adds experience to his list of accomplishments. In this line of jacks the lifting is done on the downward stroke only, and the upward stroke is free.

Pratt & Whitney Co., New York City.—This company is so well and favorably known as makers of tools of every description for use in the manufacture of automobiles, and, in fine, everything, that it will be of more than passing interest to the autoists and the makers of automobiles to be able to meet the representatives of the company and examine the fine exhibition there to be seen. The 16-inch geared head engine lathe used in so many of the shops of the makers of automobiles is probably of the greatest interest, unless it is a fact that grinders are still regarded in the light of novelties. At all events, the thread milling machine is something to take a close look at, and the "splining" equipment is of the greatest value.

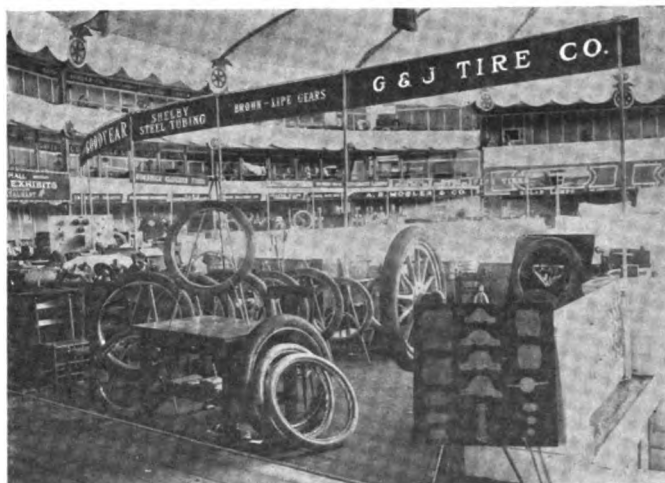

On the Balcony Where Parts Makers Flourished.

Duff Mfg. Co., Pittsburg, Pa., makers of Barrett jacks in all sizes up to the jacks that handle 10,000 pounds with the greatest ease; the company is at the Garden with a fine display. The importance of good jacks is not to be overlooked, and the "Barrett" is too well known for good qualities to be regarded in any but the clearest light. Take the Barrett Junior, for illustration; it is for use on runabout types of cars, gives a clear lift of six inches, and is of a size to allow of adjusting into place with ease. The new reversing lever on Barrett jacks is a feature to be appreciated by autoists who have had to do with jacks that were not so provided. With this lever in a position to be reached with ease—and since it is long enough to enable the motorist to reach it—the troubles of reversing are no more. There is a Barrett jack for every size of car, and it can be seen at the Garden.

MOTORS.

American & British Mfg. Co., Bridgeport, Conn.—At the Garden this company has a line of motors such as will undoubtedly attract the notice of builders of automobiles of the better grade. While in a sense, all motors look very much alike to the casual observer, the fact remains that the motors of the make in question at the Garden look neat, are of light weight,



Shelby Steel Tubing in Every Form and Size Was Shown.

and the materials used in them are quite up to a fitting standard. The line of motors are on the conventional design, and the company will fill any requirement as to the number of cylinders. The sizes range between 22 and 60-horsepower, using four and six cylinders, depending upon the size. All the motors have a one-piece crankshaft, cylinders are in pairs, valves are on one side, crankshafts are of special steel, heat treated to afford the most pronounced kinetic qualities, and the valves are of special nickel steel. The 26-horsepower motor is with cylinders 4 inches square, and it is adapted for use in cars of the class requiring a stable power plant that does not run into weight.

Brennan Motor Mfg. Co., Syracuse, N. Y.—In the middle of one side of the balcony the very large space allotted to this progressive firm is filled with the various types of engines and transmissions built by this concern. This exhibit is unusually complete in character, including as it does one six-cylinder, three four- and one two-cylinder engine as well as a selective type transmission. The whole modern trend toward six-cylinder motors gives this engine the most prominent place and it receives as well the greatest attention. The construction of placing the inlet valve directly over the exhaust valve permits of a design which it is asserted protects the valves from over-



Engines and Transmissions from the Brennan Works.

heating, pitting, or warping, avoids unnecessary openings to the valve chambers or cylinders, avoids unnecessary large pockets or chambers, making a motor that is efficient and economical in fuel. The cylinders are individual. The inlet and exhaust valves are mechanically operated from the one camshaft. The crankcase, made from the very best grade of aluminum, carries seven bearings for the crankshaft. All bearings are made from the very best white bronze, guaranteed not to score or cut. If desired the camshaft, crankshaft, rods and pistons can be removed without disturbing the motor from its mounted position; in addition, there is the usual large hand-hole plate in the side of case for adjustment of rods, etc. Lubrication is by force feed system, pumping the oil from the oil reservoir under the crankcase through tubes running to the various bearings. The surplus oil returns to the reservoir through the overflows in the crankcase, maintaining a constant level in the case and insuring even lubrication.

LAMPS TO SHOW THE WAY.

R. E. Dietz Co., New York City.—The very complete line of lamps shown leaves nothing to be desired in the lamp line. This includes mirror lens searchlights, flare-front headlights, searchlights and square dash lamps. The line is unusually complete, and the various pocketbooks are catered to as well, lamps at all prices being shown. The principal large lamps shown are 8-inch Superior searchlights, which live up to their trade name of Superior in every quality worthy of mention. The Sterling

and Sterling Junior square side lamps are of a very handsome pattern, made of the finest of heavy materials, and made to last. These are guaranteed to burn well at all times and may be had in polished brass and other standard finishes.

Manhattan Screw & Stamping Works, New York City.—One of the big problems of the lamp maker has always been the reflector; the all-glass has its faults, as has also the all-metal reflector. The manufacturer of Phoebus lamps has apparently hit upon a happy solution of the problem in the double focus reflector, which is of both metal and glass so constructed as to eliminate the poor features of both. This is designed to project the central rays horizontally, while the side rays rapidly diverge. The method in which this is accomplished is by the use of a plano-convex lens in the center of the mirror, this permitting a shorter focus than is otherwise possible. Thus the much-sought-after long central rays are projected far in advance of the automobile.

Rose Mfg. Co., Philadelphia.—The features of the Never-out patent motor and other lamps are the Mangin mirror used and the lens searchlight projector. As speaking well of the manufacturing processes in their factory and the care with which the parts are handled, all of the product is sold under the guarantee of satisfaction or money refunded. Besides a full line of all kinds of lamps and searchlights of the ordinary type, an additional line of combination headlights is made, consisting of a Neverout headlight, in combination with a patent hydro-pneumatic safety generator, the two constituting a complete outfit. These have a fine appearance as well, so as to be suitable for large and costly touring cars as well as on the smaller and less expensive machines.

SHIELDS, TOPS AND BODY MOUNTINGS.

Blue Ribbon Auto & Carriage Co., Bridgeport, Conn.—Bodies are shown here in either wood or metal to meet any requirement or taste. Especial care is given to the selection and completeness of interior fittings and equipment. There are also good examples of the latest designs in close-coupled and toy tonneaus. The company also makes cape tops, windshields and other fittings.

L. C. Chase & Co., Boston.—A complete line of waterproof fabrics for tops, etc., is shown here, in all colors and weights and in single and double texture. Lap robes and other similar articles also form part of the exhibit.

Chicago Windshield Company, Chicago, Ill.—The object of this company is to make shields to meet every possible need, and to this end a great variety of types are listed. On the latest models the glass is framed in square brass tubing which gives a very neat appearance. As side lines the company handles tire chains and a combination trouble lamp and cigar lighter.

L. J. Mutty Co., Boston.—Mutty's top fabrics are favorably known to all who have occasion to make use of such products. They have no startling novelties to exhibit, but continue to make the lines which have given satisfaction before.

Springfield Metal Body Co., Springfield, Mass.—The Springfield exhibit consists of four beautifully finished bodies of different types. There is one of the popular baby tonneaus, finished in gray with red upholstery, in which the driver's seat projects some three inches ahead of the other front seat, thus giving the driver more elbow room; the only door to the rear seat is on the right. Two touring car bodies are shown, a seven-passenger in dark red and black, and a smaller one in bright yellow with black upholstery, giving a very striking effect. A handsome extension landaulet is finished in a deep, rich green.

Vehicle Apron & Hood Co., Columbus, O.—Waterproof fabrics and the articles made from them form the subject of this exhibit. As an indication of the extent of the "Gordon" line it will be enough to mention their tire covers, both buttoned and laced, top covers, tire sleeves and inner patches, covers for lamps of all kinds and sizes, tool rolls, inner tube cases, aprons and lap robes.

EXHIBITS OF VARIOUS KINDS FOR VARIOUS USES

H. A. Allers & Co., New York City.—"Solarine" is the subject of this exhibit, and its merits are interestingly set forth. It may be used for polishing any sort of metal work, and as it contains no grit, acid, grease or poison is absolutely harmless.

A. O. Bricton, Brookings, S. D.—"Can't come off" is the claim made for the Bricton detachable tire tread. This is a protector for pneumatic tires, made of chrome leather and canvas, with steel studs on the tread to prevent skidding and take the wear of the road. It is held in place by air pressure between the tire proper and the rim.

M. H. Cormack & Company, New York City.—This company is the New York distributor for a number of accessory makers. One of the devices shown is the "Break-Circuit Auto Lock," a switch for either electric or gasoline vehicles controlled by a Yale lock with individual keys. The Fry spark plug, claimed to be practically indestructible, is a praiseworthy novelty in that it sells at about half the usual price. The company makes itself the "Cormack" combination grease and oil gun, in which the grease is expelled by a powerful, quick-acting lever device.

Commercial Acetylene Company, New York City.—Not the least of the scientific ideas advanced and proved in the past year has been that of "autogenous" welding. This is based upon the idea that a proper mixture of acetylene gas and oxygen will produce a higher temperature even than the better-known oxy-hydrogen flame. This company has a welding process which utilizes this principle, and cylinders, a crankcase and a large front axle, as well as a number of small parts, are shown which had (after breaking) been welded by this process. In addition the company is the owner of the Claude & Hess patent covering the storage of compressed acetylene dissolved in acetone, under which patent they have licensed the Prest-O-Lite Company.

G. L. Economizer Co., New York City.—The makers of this device believe that most carbureter trouble is due to the fact that the pressure in the float chamber and the suction at the nozzle are in constantly varying proportion. The "economizer" consists of an adjustable air valve or plug, which is screwed down to the cover of the float chamber and connected to the inlet pipe by two small tubes, one above the throttle and one below. A slight suction is thus created in the float chamber, holding the gasoline at a constant level in the spray nozzle. The device is adaptable to all makes of carbureters which embody a float and a throttle, and is claimed to improve the running of every kind of gasoline motor.

Hill Dryer Company, Worcester, Mass.—Of all the indispensable accessories for an automobile none are more useful than means for the proper handling of gasoline. This company shows gasoline funnels fitted with fine brass screen and a band at the top to hold a piece of chamois; also gasoline measuring cans in both the two and five-gallon sizes. Then there are the oily waste cans of galvanized iron for garages. These are fitted with a self-closing top and are riveted together so that heat will not affect the seams. They are made in four sizes, three for small or private garages, and a larger one for public garages. Any one of these sizes being endorsed by fire underwriters should be a good "buy." This firm, in addition, makes, but did not show, an automobile drip pan. It is of heavy galvanized sheet steel with a heavy steel rod inside of the rim. This latter is turned in, thus leaving no cracks around the edge. Made in two standard sizes for runabouts and large touring cars; larger sizes will be made to order at any time.

Jarman & Baker, New York City.—"The life of your tires depends on the care you give them." Many automobilists might well think over this warning, and incidentally consider the "Little Wonder" vulcanizer. The latest model of this useful little device is provided with an electric heater, which may be attached to any 110-volt lamp socket.

Leon Mann Co., New York City.—Different from the usual run of exhibitors in that clothing only is shown. The effectiveness of this is doubled by the use of lay figures, showing at once the appearance of the garments in actual use. Priestley's cravenetted cloth is shown in many varieties. These latter include Roseberry auto cloth in plain and fancy designs, and a wide range of khaki and other colorings. This fabric is woven at the famous Priestley mills at Bradford, England, especially for the automobile trade. Another strictly Priestley weave is in English mohair, also in all designs and colors. These made up in dusters or entire suits will shed dust, will not spot or wrinkle from rain, and are both cool and comfortable in warm weather.

John Lucas & Co., New York City.—Lucas "Auto-Klean" is claimed to be "the only" polish made especially for use on automobiles. It is put up in dust-proof cans, thus avoiding the danger of scratching the polished surfaces by the accumulation of dust or grit in the can.

Morrison-Ricker Mfg. Co., Grinnell, Ia.—The makers of Grinnell "Rist-Fit" gloves show a complete line of their product in several styles. For summer wear there is a ventilated glove in which the hands are kept cool and comfortable by tiny perforations across the back and fingers—too small to admit dust, but large enough to admit a current of air. All have the "Rist-Fit" feature, which consists of a strap with a special fastener to draw the glove tight about the wrist. A V-shaped piece of soft leather inserted in the cuff takes up the slack and prevents wrinkling when the strap is tightened.

New York Sporting Goods Co., New York City.—At this stand special prominence is given the Holley carbureter and magneto, and the Pittsfield coils and spark plugs, for which this company is the New York distributor. There is also shown a line of "Empire" non-sulphating batteries and "Helix" flexible shafting and wire coil belting. A novelty which should find a good sale is their rubber steering wheel grip, which consists of a corrugated casing of red or black rubber completely covering the rim of the steering wheel, with laces to draw it together on the inner edge. It should give a very firm grip for the hands.

Post & Lester Co., Hartford, Conn.—The feature of this exhibit is what is claimed to be the largest automobile horn ever made. It stands about eighteen inches high, and looks as if it had been requisitioned from the orchestra upstairs. In addition to acting as distributors for a number of other makers, the Post & Lester Company manufactures a number of specialties in its own plant. Among these may be mentioned the "Moto-Cle" wrench set, a neat-looking windshield, and a line of lamps in which the reflecting lenses are arranged to give both diffused light and a strong beam to show the road at a distance.

Supplementary Spiral Spring Company, St. Louis, Mo.—These easy riding adjuncts to the ordinary flat leaf spring are shown at balcony space No. 247 in particular and on many of the cars in the show. It is claimed for these that they prevent breaking of the side springs, eliminate all spring trouble, insure comfort and safety and save repair bills as well as tires. These are rather big claims, but on the word of a man who has used them, they are none too big. The springs are all right and should be on every car. They are so constructed as to be used in any one of a number of positions with half elliptic or platform springs at the front or rear end, above the spring end or below. Their real mission is to take out the small vibrations, the little jolts which are so unpleasant, and they do it and do it well. In no sense of the word are they a substitute for or a competitor of the flat leaf spring, but serve to amplify the latter.

Valentine & Co., New York City.—Valentine's varnishes are familiar to all users of such materials. A special color card has been brought out, showing the shades most suitable for automobile use. Special colors are also made to order.

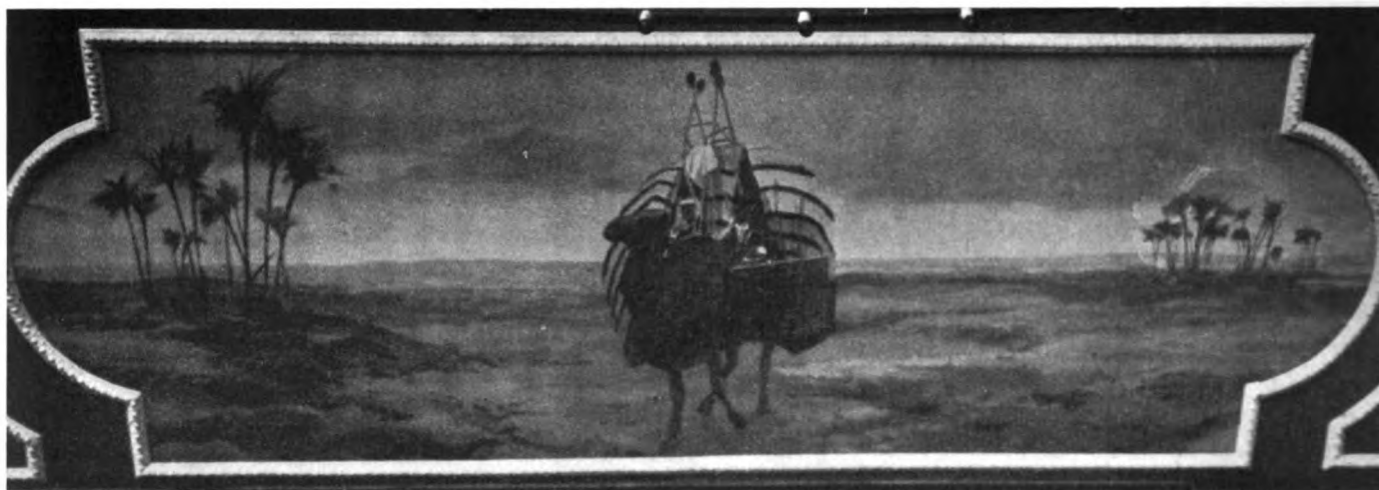

Sure-Footed Progress as Typified by the "Ship of the Desert"—Mural Decoration in Balcony.

THINGS HEARD IN AND ABOUT THE BIG GARDEN

For the Summer Bride.—"Oh, that's for a Summer bride, and that one over there for Winter," delightedly greeted a fair visitor to her escort on viewing the Packard in its bridal array, and then pointing over to the Pierce. It seems to be taken for granted that any car with an especially delicate finish, such as the Packard exhibit has had as a feature during the last two or three shows, must naturally be intended as a bridal car. The men take a more practical view of it, but their comments are equally interesting, as note that of the man who said he'd be jiggered if preparing an automobile show exhibit had not been raised to the grade of an art when even the tires on the Packard "bridal" and the Packard show chassis were specially finished to carry out the effect made by the rest of the machine.

Every Man His Own Designer.—When it comes to buying a Studebaker car, "Every man is his own designer" where the matter of body design and finish is concerned, the Studebaker line being the furthest removed from standardization imaginable in this respect. This may easily be noted by glancing at the cars forming its exhibit. No two of them are alike and none of them is exactly like any other car to be seen on the floor. The greatest novelty in body design to be found in the show is the Studebaker suburban with its four-seated body of curly maple and wickerwork, while the brocaded satin interior of the Studebaker limousine, which is a study in Nile green, is another of the artistic *pieces de resistance* of the show whose list price runs up into five figures.

Knox Exhibit Comes Over the Road.—"Just see what we lose by not having a wideawake publicity man," said a disgruntled attache at the Knox exhibit. "Everything in our big commercial exhibit down in the basement came over the road in midwinter, all the way from Springfield, Mass., under its own power, and no one has even heard so much as a peep about it. With snow and ice on the ground and the roads badly cut up, a run of 150 miles by commercial cars carrying overloads ranging as high as 50 per cent beyond their normal capacity is something worth while talking about, even in this day of record performances. Why, one of our 3,000-pound light Knox trucks brought a load of 4,800 pounds to the show all the way from Springfield without so much as hesitating once on the road."

Trail of the Non-Skid.—To judge from the tire equipment of many of the cars at the show, "the trail of the Firestone non-skid will be over the land" during the coming season, and as every turn of every wheel on the car prints its message as it rolls, the trail will be an unending one that will not be diffi-

cult for the initiated to decipher. If Firestone non-skids didn't become too common it might be a good idea to use them on a pacing car or guide instead of the usual confetti, was the suggestion offered by one observer. And it is one of considerable merit for the letters on a new Firestone non-skid tread are raised in such a manner that a clear and easily readable imprint is left on anything but the very hardest of roads.

First Sale of the Show.—The honor of having made the first actual sale of the show is claimed by the Chalmers-Detroit forces, and that there is considerable merit to the claim is to be seen in the fact that the sale was made almost before the show was well under way. According to Treasurer Roy D. Chapin, of the company, the Chalmers-Detroit sales forces also expect to make another record by selling the largest number of cars during the entire week. The question, "What is the Chalmers-Detroit made of?" is well answered by the sectional chassis which is shown in action at the booth and forms one of the main points of interest of the entire main floor.

Walter Thompson.—The Philadelphia Storage Battery Co. has a fine display of storage battery equipment for electric vehicle work under the trained direction of Walter Thompson, who reports a good demand for batteries, and it is worthy of note that the batteries of this make include light, medium, and relatively heavy plates, for use under the different conditions to be satisfied. The heavy plates, so called, are not heavy in the sense that they are related to stationary battery plates; they are simply heavy enough to handle certain classes of electric vehicle work in which high rates of discharge do not have to be considered and the life of the battery is prolonged.

The Cadillac Crowd.—"What's the crowd over there?" was the first question the average visitor asked when half-way on the first round of the main floor to the right he came in sight of the mass of people at the Cadillac booth. And just as a crowd draws a crowd, every one who saw the aggregation there immediately hastened to add his presence to it. But unlike most curiosity seekers, those who were thus drawn stayed to have the details of the new Cadillac "Thirty" made plain to them before getting away again, so that there was always a crowd about the Cadillac exhibit usually so thick that it was next to impossible to find any one connected with it.

The Man from Maine.—The E. T. Burrowes Company is adequately represented by C. H. Calkins, who takes a wide interest in the advance of the industry along conservative lines, and among other things looks in on the doings of the Society of Automobile Engineers when the opportunity affords.



Dog and Fuel Can Have Since Changed Places.

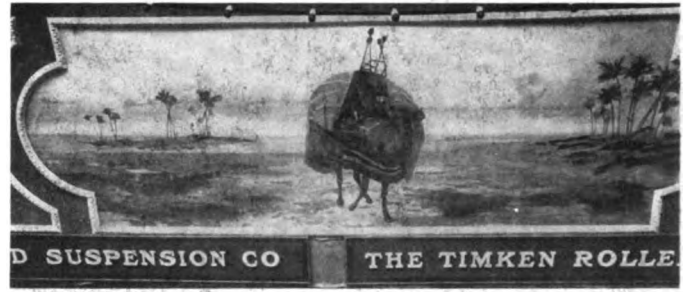

A Walking Commercial Car from "Afric's Sands."

Presented Plate to Selden.—At a luncheon Tuesday noon at the Prince George Hotel, E. L. Thomas, of the Thomas Motor Company, presented George B. Selden with the Selden license plate from the victorious New York-to-Paris car. Mr. Selden made a brief reply, telling of his experiences in constructing the first engine, and compared the round-the-world trip to that of Magellan who circumnavigated the globe. Others who spoke were George Schuster and Fay L. Faurote, of the Thomas company; W. H. Humphreys, of the New York *Evening Post*, and Richard Bacon, Jr., of the Haynes Automobile Company. Dr. C. G. Percival made an efficient toastmaster.

The Pierce Boudoir Car.—It did not take the fair sex long to christen the Pierce Great-Arrow \$12,500 creation of art. "Why, that's a real boudoir," exclaimed one of its early admirers, and it has been known by this designation ever since. To add that it is the *piece de resistance* of the show as a whole is to put it mildly, for a current quotation was, "You haven't seen the show unless you take in the Pierce beauty." It required a goodly part of the time of several of the attendants at the Pierce exhibit to explain the details of the artistic interior.

Will Not Discontinue Steamer.—One of the annual reports and one that crops out each year at show time, is about due to appear now. According to Windsor T. White, of the White Company, this is the usual time for the rumor to circulate that the manufacture of steamers will be discontinued. This nine-year-old rumor never fails to show up, and this time the White Company is discounting it and its effects by denying it in advance. According to President White, the company has no intention, plan, nor inclination to discontinue the White steamer.

Continentials for Hotel Decorations.—Probably the last place in the world where a person would look for automobile tires is in a swell hotel. Yet the automobile's indispensable footwear will be found in at least one New York hotel, the Astor using them to complete the decorations for show week. These tires have been selected because of popularity, which those who sell them insist is due to the great mileage and constant satisfaction afforded to owners.

Doings at the Simplex.—In East Eighty-third street, New York City, the Simplex Automobile Company, is making preparation to fill the orders which are sifting in from the Garden, and G. E. Franquist, the designer of their well-known car, reports everything in order for a busy year. In addition to the cars of this well-known make, the designer has well in hand all the special gigs, tools, dies and fixtures to assure good results from high grade materials on a basis taking into account accuracy of fit, and, what is more to the point, the perfect duplication of parts.

The Timken Roller Bearing Company.—The average spectator at the Garden is curious to know what the "big" front wheel knuckle is for. Many of them reach the conclusion that it is just as a sample of the bearings. They overlook the fact that in trucks it is not easy to steer if the knuckles offer much resistance to turning. The Timken plan is to provide roller-bearing knuckles in places of this sort. The new 1,500-pound Timken front and rear axles are attracting more than a little notice. They look quite up to the standard known as "fit," and bear the earmarks of careful construction.

Interest in the Exhibition.—The best way to prove the absorbing interest in the Garden and its contents is to go there during the hours when it would be reasoned that the patrons would not be there. Surprise waits the experimenter, for as a matter of fact there is no time during which the Garden is depleted of a vast count of spectators. Naturally it is recognized that the real buyers try to have a good look at the cars at a time when the spectators are in less presence. The truth is there are so many of them "on the same tack."

The Chalmers-Detroit in Action.—A stop at the booth of this company was of more than usual interest due to the fact that the exhibit had a motor turning over, and it was in section to show the working of the Chalmers-Detroit ideas. It was explained how a motor can be short, thus leaving the body with more room. It was pointed out how a crankshaft can be with two bearings and be the better for it. On the whole it is a quarter of an hour that could not be expended to better advantage.

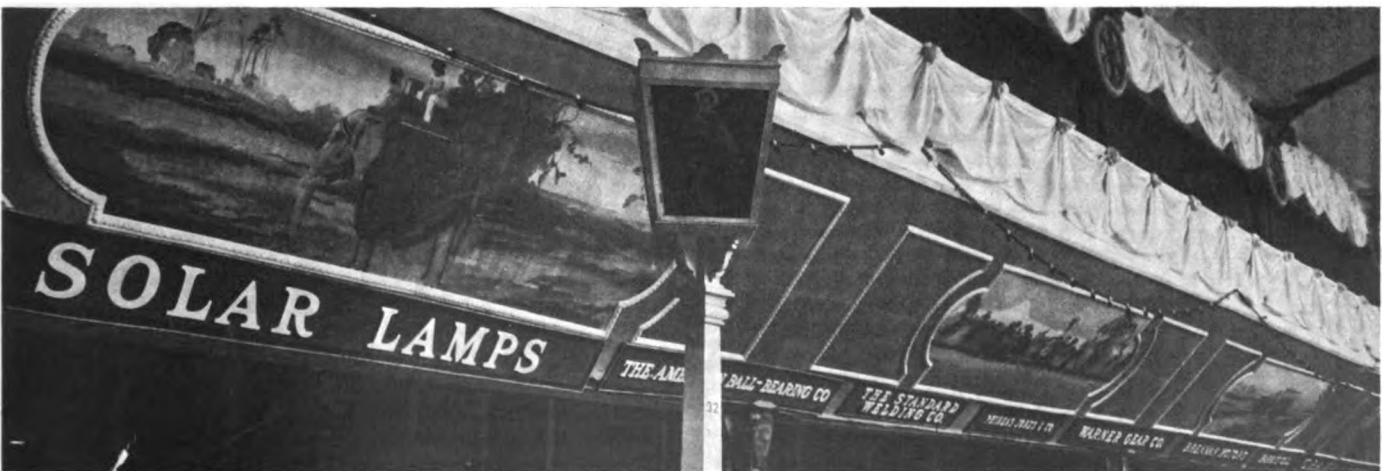
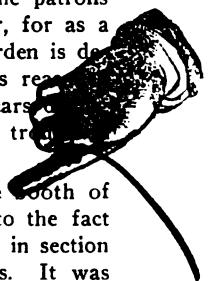

Decorative Scheme Above the Accessory Makers—Suggestive of Primitive Transportation Methods.

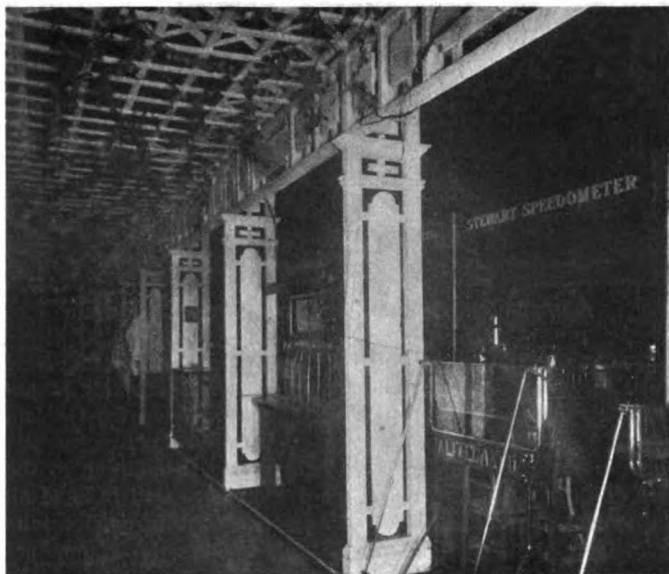

Concert Hall—An Aisle in the Accessories Section.

A Queer Car Starter.—"How on earth do you manage to start your car with that thing?" asked a puzzled inquirer of one of the attendants at the Winton booth, referring to the small brass cap employed to keep dirt out of the opening for the crank, which on all Winton cars is carried in the tool box. He had first taken hold of this small projection and after vainly trying to turn it, had given up and sought information. He went away considerably enlightened after being initiated into the mystery as well as the delightful convenience of the Winton self-starter. One of the Winton cars is a magnet for those who have to see, smell and feel everything in order to satisfy themselves of its identity. This particular car is a Winton six-cylinder roadster with a delicate cerise finish, the upholstery being of a tint resembling very closely the ordinary aluminum paint. The result is that every one who comes anywhere near the car goes up to it and rubs his finger on the leather to see if the finish will come off, affording no end of amusement to the Winton attendants.

Peerless Shows Its New Metropolitan Home.—"Yes, it is something that we are proud of and something that New Yorkers can take pride in as well," said L. H. Kittredge, president of the Peerless Motor Car Company, referring to the architect's water-color drawing of the façade of the building now under construction for the New York branch of the Peerless company at Fifty-seventh street and Broadway, directly adjoining the Tabernacle. In fact, the building is L-shaped, and surrounds the latter structure, having a frontage of 75 feet on Broadway and of 25 feet on Fifty-seventh street. It is to be nine stories in height, and will be one of the most prominent landmarks along automobile row. Speaking of its completion, Mr. Kittredge said that his company expected to be able to occupy it at the opening of the selling season for 1910, or about September next.

Explaining the Two-Cycle.—It would seem from many of the remarks heard in the vicinity of the Elmore booth that a great many people have still to learn something, if not a great deal, about the gasoline motor, if their knowledge of the simplicity of the two-cycle motor may be taken as a criterion. Many apparently have no idea whatever what the term "two-cycle" means at all, and the attendants at the Elmore exhibit are kept busy showing, by means of the sectional chassis of the Elmore car on view, just what the functioning of the motor is and how it compares with the four-cycle motor. But few of the visitors fail to be impressed with the great lack of small moving parts that characterize the Elmore motor, once the method of its working and the extreme simplicity of its design and construction are made clear to them.

Another Unusual Exhibit.—Where so many unusual features were present it was only a matter of looking around to find still another. At the Stearns exhibit was shown a toy tonneau that took very well with the ultra-critical crowd. This was finished in gray with black striping, while the upholstery was in natural kid with no tufting. The effect was very pleasing and the extra seat on the running board for the chauffeur received favorable mention. The small limousine or town car on the 15-30 chassis is a well-worked-out replica of the larger and more luxurious cars. Sales Manager Charles B. Shanks occasionally took a hand and told a customer Stearns points in a way that was convincing.

"Who's This Pope Toledo?"—"Who's the present Pope?" asked one Hibernian visitor of another at the show. "Pope Pius the Tenth," was the ready answer of his companion. "Well, who'll be the next Pope?" came the query. "And how can I tell that now?" "Well, what's all this Pope Toledo and Pope Hartford we're hearing so much about? Do they come from Rome?" The story has been going the rounds of the show and affording no end of amusement for the attendants at the exhibit of the Pope Toledo. Needless to add, they have been doing their share to keep it in circulation.

Connecticut Spark Coils.—Just as a reminder of the quality of "Connecticut," the Connecticut Telephone & Electric Co. is handing out to its friends and patrons a "diary" for 1909, the quality of which is quite up to the quality of the ignition devices of this company. E. C. Wilcox, of the firm, who attended the meeting of the Society of Automobile Engineers while in town, reports that orders are directed to Meriden, Conn., on a basis quite up to the best expectations, and that the factory is extremely busy in consequence.

Thomas Cars Could All Go Round the World.—The Thomas New York-to-Paris, or as it is now styled, round-the-world car, attracted many who had not previously seen it and many more who went for a second and third look. At the Thomas exhibit Advertising Manager Fay L. Faurote stated that every one of their cars is built good enough to repeat the performance on just as short notice if the necessity should arise.

Advertising Managers Are in Evidence.—Most of the managers of the advertising departments of important concerns are more or less in the big Garden. The list includes such well-known experts as E. Ralph Estep, of the Packard; C. W. Mears, of the Winton; R. H. Johnston, of the White; Fay L. Faurote, of the Thomas; E. LeRoy Pelletier, of the E-M-F and Studebaker; and George Davis, of the Pierce.

Press Agent Jervis on the Job.—Though not feeling as fit as he would like to be, A. N. Jervis, the dean of press agents, is pluckily sticking to his job, but after the conclusion of the show will take a well-earned rest. He says that the demand for "courtesies" has far exceeded anything of the sort that he has ever encountered before, and the excuses offered why press tickets should be supplied range from the sublime to the ridiculous.

FIRST ANNUAL DINNER OF THE M. & A. M.

Last night at Delmonico's the first annual dinner of the Motor & Accessory Manufacturers was successfully held. Job E. Hedges filled the position of toastmaster in his usual flexible manner, and the speakers included ex-Governor N. J. Bachelder, of New Hampshire, Master of the National Grange; William H. Hotchkiss, president of the American Automobile Association; Charles Clifton, president of the A. L. A. M.; Benjamin Briscoe, chairman of the A. M. C. M. A.; H. E. Raymond, first vice-president of the M. & A. M., and A. G. Batchelder, of the Class Journal Company. President H. S. White, of the M. & A. M., introduced the toastmaster of the occasion.

The complete report of the banquet will be given in THE AUTOMOBILE of January 28.

HONORED THE MAYOR OF SAVANNAH.

Tuesday night at Delmonico's, newspaper writers from New York, Boston, Philadelphia and Chicago, who were at Savannah, together with a hundred others prominent in the automobile industry, gave a midnight supper to Mayor George W. Tiedeman, of Savannah, and J. A. G. Carson and Harvey Granger, president and vice-president, respectively of the Savannah Board of Trade.



Savannah's Pair.

Mayor George W. Tiedeman and President Frank C. Battey of the Savannah Automobile Club.

F. C. Battey, president of the Savannah Automobile Club, was a regretted absentee, as was also W. J. Donlan, secretary of the Chamber of Commerce, who gave particular attention to the newspaper writers at the time of the Grand Prize race.

E. H. Broadwell and T. F. Moore were responsible for the excellent arrangements for the supper, which included several novelties, and wound up with a vaudeville entertainment. Arthur Brisbane, the well-known editor of the *New York Journal*, filled the role of toastmaster, though John C. Wetmore made one of his usual taking "fireworks" speeches in welcoming the visitors and introducing Mr. Brisbane. Mayor Tiedeman spoke on the "New South"; Mr. Carson's topic was the

"Commercial Development of the South," and Mr. Granger said that Savannah wanted another race. And then followed the festivities, which continued until Fifth avenue was deserted.

The list of those present included Chairman Robert Lee Morrell, of the A. C. A. Contest Committee; N. H. Van Sicklen, of Chicago, ex-chairman of the A. A. A. Technical Board, who figured in the successful outcome; and F. J. Wagner, who started the cars on their 400-mile journey.

QUAKERS THINK BIG CARS MAY BE SCARCE.

PHILADELPHIA, Jan. 18.—"Is there to be an actual dearth of cars to fill orders during the coming year?" is the anxious query of not a few of the local "Row" men. Archie Hughes, of the

hustling firm of Foss & Hughes, representatives of the Pierce-Arrow, E-M-F "30," and Knox commercials, thinks there is bound to be, and quotes cold figures to prove his claim. "Last year," said Archie to THE AUTOMOBILE representative, "we placed 152 cars, mostly Pierce-Arrows. It was a bad year for most automobile concerns, but with the boom started in mid-November to help out, we came under the wire a winner on the year's business—not by a big margin, it is true, but still a few to the good. In early Fall, while conditions were still bad, we made our arrangements with the Pierce people for the present year. Everybody was conservative to the limit. We shaded our demands about 20 per cent., and the factory people, having the then existing depression in mind, suggested a still further cut. Of course we acceded. The quota of Pierces of all models allotted to us was just 97, and it looked big then. Prayers and petitions to the factory met with little success. We have written every Pierce agent from here to Jericho offering to take all 1909 Pierces they can spare off their hands at once, but have found that in nearly every instance the other agents are in the same fix as we are. Conditions are now so good that had our present allotment been doubled, we would have little difficulty in disposing of them. Yes; I certainly think there is going to be a scarcity of high-grade American cars during the present year."

The claims of Mr. Hughes are borne out by the statement of Sales Manager E. C. Johnson, of the Keystone Motor Car Company, Packard agents. That concern's 1909 quota of Packards is practically exhausted, and while a lucky chance may throw an additional car here and there into their hands, there is no prospect of such a substantial addition to its allotment as would permit of filling all demands. Other habitues of the "Row" are sending up the same plaint, from which it may be gathered that the demand for high-grade cars during the present season will exceed the supply to such a degree as will compel the makers to boost their 1910 output figures to a marked degree.

W. K. V., JR., RIDES ROUND SAVANNAH COURSE.

SAVANNAH, GA., Jan. 18.—"A great automobile course. Those grandstands are just right." These are the opinions of William K. Vanderbilt, Jr., donor of the world's famous Vanderbilt cup, as expressed by him after driving over the automobile course in a big Packard driven by Roy A. Rainey.

Mr. Vanderbilt, who is staying some time at the Winter home of Mr. Rainey, in Bryan county, where he is passing his time away by fishing and shooting, came to Savannah to take a ride around the automobile course where the largest race was ever held, this being the first Grand Prize race. Mr. Vanderbilt went away from Savannah with a good impression, and stated that Savannah should have a big race every year.

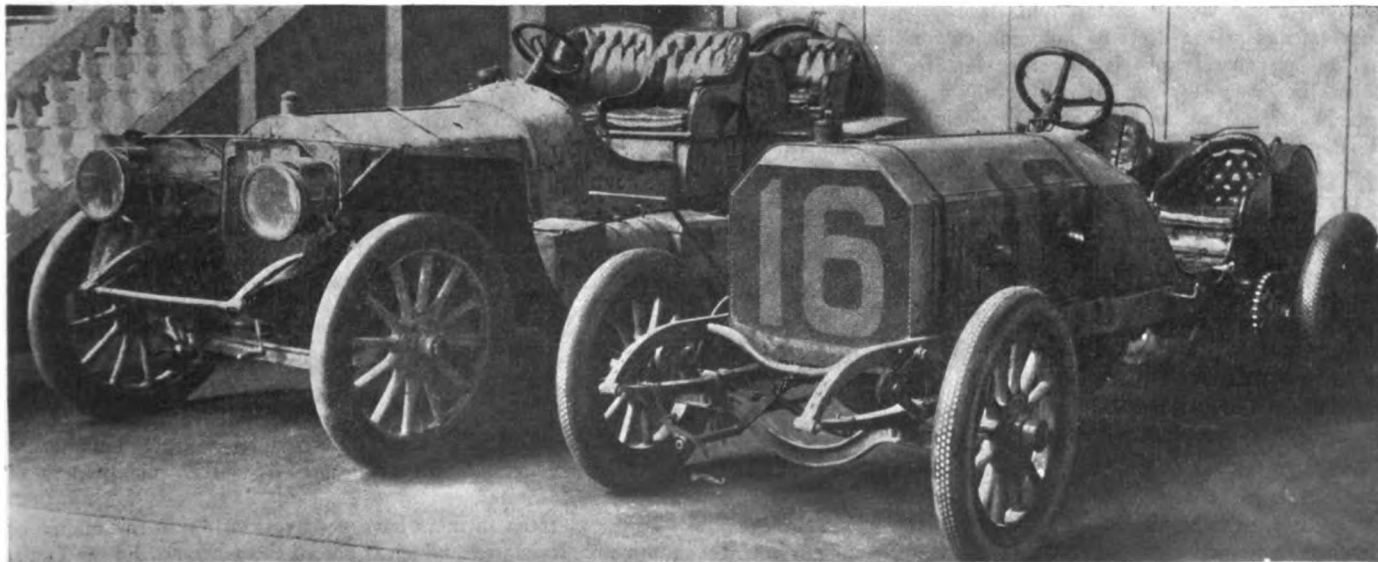

Two Champions—Thomas Round-the-World Car and the Locomobile Vanderbilt Cup Winner.

Pressed steel frames are generally heavier than used in America. Axles worthy of mention were the Lancia pressed steel front and the Fiat pressed steel rear casing.

Other axle, radius rod, torque rod and structural details generally were as frequent and variegated as the number of cars of the exhibitors. One car, such as the Hotchkiss, of acknowledged reputation and worth, shows a rear construction, in which all torque and car-driving strains are absorbed directly by the rear springs, whose front ends are anchored rigidly against the frame.

Perhaps as a next door neighbor would be found a car of equal reputation but equipped with radius rods, torque rod or tube (possibly two of them) and all the paraphernalia in any way excusable in such a connection.

The transmission problem would seem little changed, except perhaps for a tendency toward the progressive type on the smaller cars, retaining the selective for the larger models.

Clutches, as before, are cone, multiple disc, contracting and expanding band, metal-to-metal, leather-to-metal and Maverick. Certainly the simple cone type is at least holding its own.

European Fast Small Cars.

Reverting to the small car matters as being of considerable immediate interest to American constructors, upon the face of it, taking into account the extremely high speeds made in recent foreign small car races, it would appear that there exists abroad some magical touch of design, materials or construction, for in advance of anything American.

The real facts, however, are not by any means so discouraging. In the first place, we must remember that the character of European small car contests has been very different from anything over here. Here, except in the case of the last Savannah event, every effort has been put forward to limit the contesting cars to a construction at least approximately in accordance with the regular stock product of the manufacturer entering.

Even at Savannah, where leeway was given the maker along lines of special construction, insufficient time was allowed between the dates of the announcement and the running of the event to permit of the design, construction and test of any special racing car.

It must be remembered further in connection with this event that for six or eight weeks the organization controlling 90 per cent. of the contests throughout this country was holding over the head of each individual manufacturer the threat of disqualification should he permit a car to be entered.

The Savannah Small Car Race.

Glance for a moment at the Savannah result—a foreign car of a make perhaps acknowledged abroad to be the equal of any car there built—this particular car, a special one, built for racing, lightened even to the extreme extent of frame drilled full of holes, fresh from tests and trials in England, and sent here in perfect condition in ample time to work out over the course—this car in a distance of 196 miles and a total elapsed time of 3 hours 43 minutes 33 seconds, gained a total of 6 minutes 12 seconds over its next competitor, an American stock chassis, and 10 minutes 22 seconds over its next competitor, also an American stock chassis. It is a matter of record how much delay from tire and other trouble was experienced during the race by the three cars. The behavior of the other foreign cars is also a matter of record.

It is conceded that the winning car ran a beautiful race. It must also be conceded that the American cars finishing second and third were both faster than the winner, and that their delays were occasioned by insufficient or improper preparation, in one case at least (the third). It must also be considered that to make the third car eligible in the event it was necessary to reduce the bore of the cylinders, which was done without in any way lightening the stock chassis to keep pace with this reduction of power, all of which must have very materially affected the result. However, this car made the fastest lap (56 miles per hour), was in better running condition at the end of the run

than at the beginning and was immediately entered in other events in the South without the least overhauling.

The race was a fair one and was closely contested, the result being in doubt almost to the finish. A little bad luck with tires, and the result might have been different.

A good car well driven won the race. But because this car happened to be a foreign car it is the height of folly to conclude that all foreign stock small cars are superior to the similar product of America. The study of foreign small-car events will show that fully as many cars go down-and-out owing to troubles, minor and major, as in any similar American contest. I do not refer particularly to races, but to contests of all characters.

Freak Small Cars.

As to the construction of the small cars with which phenomenal speed has been developed abroad, the car that was booked to win the "4-inch race" on the Isle of Man had, of course a 4-inch bore, but an 8-inch stroke.

An accident, chargeable to the great speed of this machine, put it out of the running. Other cars have even longer strokes; for instance, the single-cylinder one which averaged better than 65 miles per hour for 100 miles on the Brooklands track was of 4-inch bore and 10-inch stroke.

One of the rules under which American contests have been run during the past year has been that the entrant must stand ready to sell the entry at the end of the race, for the regular price of the stock model of which the car entered is supposed to be a duplicate. It is interesting, as illustrating a far removal from stock properties, that the car last mentioned (there were three of them built) was quoted for sale at a figure in thousands that did not fall far short of the price of the real stock article in hundreds.

These special speed machines are admittedly impossible for stock models. Cars of this freak construction will run just as fast and can be constructed just as easily in America as elsewhere, but piston speeds of from 3,300 to 3,500 feet per minute, the employment of special oils for lubrication, and valves that are nearly as large as the cylinder itself are not factors that can enter into the healthy growth of the stock gas engine for general public utility. Even the makers of these machines shrug their shoulders at the suggestion of such a thing. Extreme vibration, high compressions, lubricating difficulties and a hundred and one other factors render unfit for public use a single-cylinder engine of 4-inch bore and 10-inch stroke, for which an output of over 30-horsepower can be claimed.

American Material and Workmanship.

The matters of material and workmanship do not enter into this equation at all. We have the finest workmen in the world in America. They are not merely machines perfected in the performance of certain labor, but have the advantage of the knowledge that a lively exercise of their brains will be appreciated by their employers. Nowhere in Europe can be found the "suggestion box" or any other of the several systems common to American shop practice, and through which is added to the mutual benefit of the employee and the employer the advantage of the observant eye and the active brain of the "man behind the bench."

We have seen in the past, much money spent by those allied with foreign interests, on the theory that even if the American manufacturer knew what material was right and proper (which was doubtful) and even if he did have this knowledge and chose to use it (which was beyond belief), that he would still be met by the insurmountable difficulty of not being able to get in America the proper metals. Admit, if you like, that in years past, there may have been ground for such statements. It is only natural that in countries such as France, where the motor car first saw commercial progress, that the question of materials should have received early attention. But the above noted theory is now an exploded one. It is my experience that for the season 1909, the American maker knows more in a minute about the quality of the steel in his product than the continental manu-

facturer does in an hour. Abroad, experiments and tests are made until a grade of material is found that will endure in the place it is desired to use it. This sample is then O.K.'d and the steel maker is asked to furnish material according to it. The French designer does not pretend to know the properties, the peculiarities or the chemical analysis of this material; he merely knows that it does his work. The American engineer and frequently the American purchasing agent, must have in his hands all data, physical, chemical and commercial, before an order for any certain material is placed.

Whatever may have been the conditions in the past it is with the present and the future that we have to deal; and the American motor car constructor has ready at hand and subject to call, in this country the equal, if not the superiors, of any of the metals of the world.

It is not in keeping with the spirit of American supremacy that the employment of such materials should be deliberately avoided by our motor car builders.

American Makers Depend Upon Experience, Not Racing.

In the big car classes, the American car has been at a disadvantage in that road racing here has never to any extent occupied the attention of the manufacturers, the American makers, generally speaking, being content to enter the stock chassis of the current year's model against the specially built foreign racing cars, driven almost invariably by men retained on yearly salary for this purpose alone, and whose experience should make them blush to "take candy from a baby"—by defeating the American drivers and cars put up against them.

In saying this, I do not reflect upon the nerve and good intentions of the American driver or the excellent American racing car; they have thriven phenomenally considering conditions here, and proven their surpassing merit in some international large car contests. With the right racing regulations, a large number of splendid, fast American racers would be built and their performances prove the mettle of the American designer in a more impressive and conclusive manner than ever before.

The point I make is that the foreign driver and the foreign racing car have been produced in an atmosphere that never has and never will exist fully in this country of stock car events and hustling production which throttle the idea of special racing car construction as demoralizing and poisonous to the manufacturing end.

In truly stock car events and particularly in small car racing the story in America will surely be satisfactory henceforth. In this newer development, we start in the game at least on a par generally with our foreign competitors, in excellence of machines and with the advantage of business and manufacturing methods that are far in advance of theirs.

Not only in methods and traditions is the foreign manufacturer

handicapped, but he is confronted by the equally or even more serious problem of a market. The European countries open to him are small, some of them bankrupt, and certainly all of them, where roads and financial conditions offer some promise, well able to meet the entire demand of Europe from their own factories, at any rate if worked upon the scale possible in America. Therefore, with a few exceptions, the foreign maker cannot produce such quantities as will allow him to realize upon his cheaper labor (less than half the cost of similar American labor) or upon his cheaper materials. As a result many of the greatest and best known foreign factories are either practically closed down or are operating under such conditions of decreased production, or variegated production, that they are losing money every day.

Reports of new loans negotiated and of impending failures are tabletalk in Paris—the hub of the continental industry.

The Tariff on American Imports.

The necessity behind the present attack upon our customs tariff is as clear as day to anyone familiar with this situation. Our present tariff protects the automobile as well as other similar industries of the United States, from the unfair competition of European labor, whose recompense is based upon conditions of life such as no American workman would tolerate and which, God willing, may never be forced upon him by a removal of ample tariff protection.

Even our present tariff rate would not be sufficient, were American business and manufacturing methods possible abroad. The machine tools of the United States are conceded to be easily the finest in the world—but all advantage in this respect is lost through the almost complete equipment of every foreign factory with the very latest of this product of American brains.

In England, where little or no protection is afforded by tariff, and where the conditions of living, the self-respect and intelligence of the labor element more nearly approximate the similar conditions in America, it has been fully realized that if the motor car industry is to survive, there must be enacted at once just such protective measures against continental overproduction and price cutting as now exist in the United States.

It is inconceivable how there can be any sentiment among American manufacturers, who, in worse than utter ignorance of the situation, can come forward with the proposition that our protection is unnecessarily high. Only a relatively few automobile makers import even a small part of their materials from Europe; and this material is not brought in because it can be done cheaply; therefore the further proposition to increase the tariff rate upon motor car materials would seem to impose a hardship upon the trade without any appreciable benefit to either the labor interests of the country or the revenue of the government.

FOR ANTI-SHOCK DEVICES IN WHEELS.

PARIS, Jan. 16.—Inventors who are desirous of putting the pneumatic tire out of business will have an opportunity of proving their worth in a public competition to be held from Paris to Nice and return next April. For the fourth year in succession the 1,400 miles from Paris to Nice and return will be covered by automobiles having their wheels equipped with various anti-shock devices other than pneumatic tires. A minimum weight is imposed for each class, beginning with one-lungers of 39-10 inches bore and ending with six-cylinder cars of 4-inch bore, while a minimum rate of speed will be fixed for each category. The stages will be Paris, Dijon, Lyons, Marseilles, Nice, where an exhibition will be held, and return by the same road. On arrival at Paris a critical examination will be made of the wheels, awards being made according to the condition in which they are found. Only one set of wheels can be carried; no work may be done on them without penalization, and every stop or failure to make controls on schedule time will cause a penalization to be applied.

AFFECTS AMERICAN FOREIGN CAR OWNERS.

The United States Circuit Court of Appeals has handed down a decision which will compel American owners of foreign touring cars returning to this country to pay duty upon their machines. They will be assessed at the same rate as other imported automobiles, that is, 45 per cent.

The court's decision reverses the judgment of the lower courts and the action of the General Appraisers. It was rendered in the case involving the importation of an automobile by W. R. Grace & Company, which had been repaired abroad. The practice has been to admit the automobiles of returning tourists free of duty as household effects.

The court held that the judgment of the lower court that only the repaired part should pay duty was an error, and added that the automobile could only be considered an entirety. The decision held that an automobile is not a household effect in the meaning of the law. That this ruling will have a marked effect upon the attitude of the autoist in his gyrations abroad is assured, and it will stall fraud.

FRANCE WILL HAVE VOITURETTE RACE IN JUNE

PARIS, Jan. 16.—Though there will be no Grand Prix, and consequently no club race for voiturettes this year, small one-lungers will not be altogether without a speed contest during the coming season. Some time in June *L'Auto* will put on foot its fifth annual voiturette race under rules that differ in one important particular from those of previous years. Formerly bore for a single-cylinder car has been limited to 3.9 inches, with stroke entirely unfettered. The natural result was that the stroke has increased in enormous proportions, makers who commenced with a piston stroke of 4 inches four years ago having since run up to 5, 6 and 7 inches, and last year reached the exceedingly long stroke of 9.4-5 inches for a bore of 3.9-10 inches.

The unlimited stroke clause was intended to prove that stroke is not a negligible quantity in the development of power by an internal combustion motor. This has been so clearly demonstrated by all the big European races having been won by long stroke engines that nobody could now be found to maintain that two single-cylinder motors, one of 3.9 by 3.9 bore and stroke and another of 3.9 by 9.8 bore and stroke were of equal power. It is on this account that engines of a larger bore than 3.9 inches will be admitted on condition that the stroke of the piston does not exceed a fixed limit. For a 3.9-inch bore the maximum

stroke is 9.8 inches; for 4.3 inches bore the maximum stroke is 6.3-5 inches bore; for the maximum bore of 4.7-10 inches the stroke is also 4.7-10. For two-cylinder engines the same rule holds good, a bore of 3.1-10 inches allowing a stroke of 7.1-2 inches; a bore of 3.7-10 inches allows a stroke not exceeding this.

For four-cylinder engines the lowest bore provided for is 2.1-2 inches, with a stroke not to exceed 5.1-2 inches; the bore may be increased to 2.9-10 inches, with a reduction of the stroke to the same figures.

In this year's race will be lined up cars of various bore with stroke in proportion, the long stroke engine always being encouraged. The Gobron type of motor, with two pistons per cylinder and two-stroke engines will be admitted on an equal footing. The aim of the rules is to prevent the development of the freak designs which were bound to make their appearance with attempts to still further increase the proportion of stroke to bore. Dismountable rims and dismountable wheels are allowed in the race.

It is intended to hold the speed test within sixty miles of Paris, on a varied type of course not more than 25 miles round. If more than 60 entries are obtained elimination races will be held.

BRITAIN'S FIGURES ARE MOST INTERESTING.

LONDON, Jan. 7.—With the assistance of the various licensing authorities, the R. A. C. has completed a census of the motor vehicles registered in the United Kingdom up to October 1 last. The grand total amounts to no less than 154,391, of which Scotland is responsible for 10,907 and Ireland for 6,139. The total for the corresponding date in 1905 was 74,038, so that the number of motors in use has been doubled in three years.

It is interesting to note how the present year's total is made up. Cars for private use number 71,381, while motor vehicles for trade purposes amount to 12,104. Motor 'buses and similar public conveyances reach a total of 5,880 and the remainder of 65,026 consists of motorcycles.

The number of registrations in London amounts to 34,908—only two thousand less than the estimated total for the whole of France. Birmingham ranks as the second city on the list with 3,651 vehicles registered and Manchester follows with 3,021.

SOME NEWS THAT WAS MADE IN GERMANY.

Nearly all the employees of the German factories are making a dead stand against the motor liability law, mass meetings having been called all over the country and resolutions set up. The men fear entire loss of work, as many factories are not only working shorter hours, but with fewer hands already to keep down expenses.

A 15-horsepower Mercedes will be put upon the market early next Spring; this item of news is received in Germany with satisfaction by many who were hitherto unable to purchase one of the bigger vehicles turned out at Untertuerkheim.

At the meeting of the German Motor Car Industrials a new formula for the Prince Henry tour was worked out which will permit vehicles of from 7 to 28 horsepower to compete. Nothing definite has been made known, although the debate on the subject lasted for a good many hours. Last year's rules were far from satisfactory and caused much dissent.

WILBUR WRIGHT LOCATES AT BASE OF PYRENEES

PARIS, Jan. 16.—At a dinner uniting the members of the Aero Club of the Sarthe and the Aviation Commission, Wilbur Wright has bid farewell to the town of Le Mans and in a few days will be installed near Pau, at the base of the Pyrenees. Before the rails were torn up and the wooden shed which has housed pilot and machine for so long was torn down a number of the engineers and mechanics of the Leon Bollee factory were invited to come for a flight. The machine was then dismantled, packed up and shipped by rail to the southwest corner of France. While waiting for his brother Orville and his sister, who are expected here in a few days, Wilbur Wright is spending a little time in Paris attending to private business.

As soon as his brother and sister have arrived the party will journey down to Pau and take up their quarters on the west plains five miles out of the town. A dwelling, consisting of five living-rooms, a workshop and sheds for several aeroplanes, has already been erected, and it is here that all future work will be done. The situation is an ideal one, the town of Pau being sufficiently near to supply all requisites, yet far enough away to insure quietness; for thirty miles to the north stretch the vast

Landes, without a tree, a house, or a patch of cultivated land.

The first month at Pau will be spent in training the three pupils, Comte de Lambert, Captain Girardville and Paul Tissandier, with probably the addition of Leon Delagrangé. At the end of the time Wilbur Wright will return to America, in order to fulfill his engagements with the United States Army Department. During his absence his brother Orville will supervise the construction of the six aeroplanes which must be constructed according to the Lazare Weiller contract. The spruce for these has been sent over from the States and in general features they will be similar to the one used at Le Mans. A Wright type of engine, built by Barriquand & Marre, of Paris, will be fitted, differing only from the one used last year in a few details. Another engine for the Wright aeroplane has been studied at the Leon Bollee factory at Le Mans.

On returning from America in the Spring, Wilbur and Orville Wright will commence further experimental work on their aeroplane, the nature of which has not been divulged. It is understood that an attempt will be made to very considerably improve what is at present the most remarkable machine in the world.

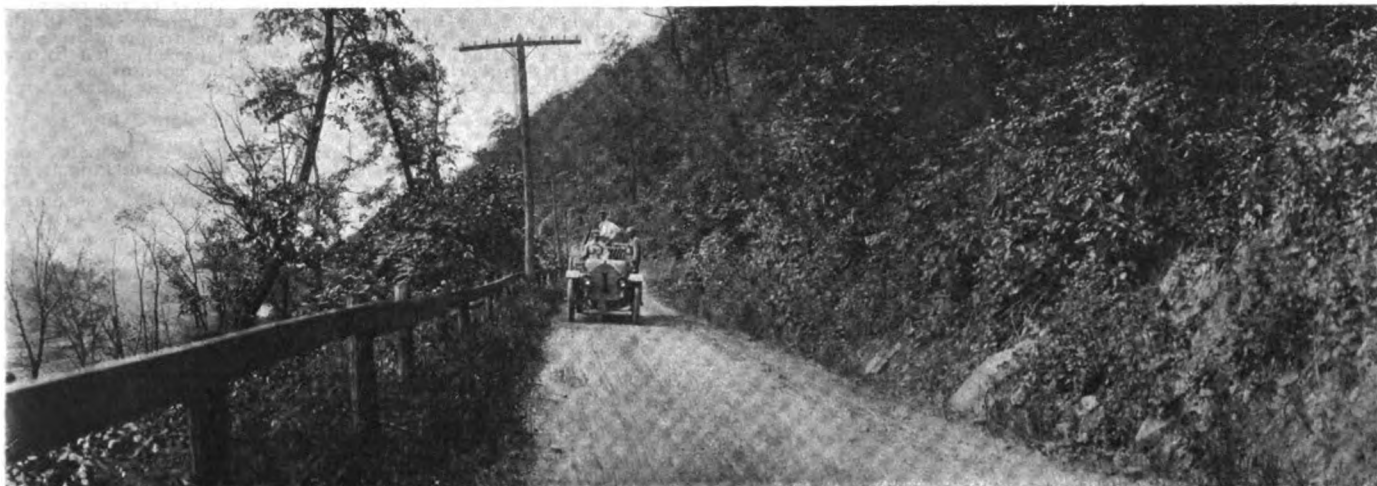

RULES GOVERNING SIXTH ANNUAL A. A. A. RELIABILITY TOUR

THE rules for the 1909 Glidden tour, published for the first time herewith, embody a number of changes from those in force last year, and it is believed that they will be found generally satisfactory to all concerned. The toy tonneau or double rumble car is now officially recognized as an individual class, and a separate trophy is offered for this class. All cars are classified according to price, in five groups, and the running time allowed is regulated to correspond with the presumed ability of each group.

The penalizations have been made much more strict than before. All spare parts, whether or not they are listed before the start, will be charged for, although those listed will entail a

smaller penalty than those made necessary by unforeseen emergencies. Listing is extended even to the tools to be used. Penalties will also be exacted for the time spent by driver and mechanic in repairs, except on tires, which as before cannot be the cause of any downfall. Last but not least, the system of club teams has been abolished. This will no doubt be a cause of satisfaction to the entrants.

Entries will close at noon June 16, 1909; each entry must be accompanied by the specified fee of \$200 for those received before May 15 and \$300 for all others. Entries should be sent to Frank B. Hower, chairman of the A. A. A. Contest Board, at his office at 760 Main street, Buffalo, N. Y.

TOUR OF 1909.

The Sixth Annual Reliability Touring Contest of the American Automobile Association will be held.....
to.....1909, starting at.....
and ending at.....

In connection therewith will be offered for competition certain trophies and certificates, described as follows:

1. For touring cars, the Charles J. Glidden trophy. (For details see deed of gift.)
2. For miniature tonneau and double-rumble cars the.....
3. For touring runabouts, the Frank B. Hower trophy.
4. For all cars completing the run as contestants, certificates.

Trophy Awards.

1. The trophy in each class shall be awarded to the entrant whose car completes the contest with the least points to its debit. A certificate will be awarded to each contestant who finishes the run under the rules.

Qualifications.

1. Each entrant shall be a member of a club affiliated with the American Automobile Association.
2. Any stock car consisting of a combination of the manufacturers standard touring car chassis, touring body and standard equipment, with seats for four people or more, and carrying four or more persons or ballast at the rate of 125 pounds per person, may complete for the Glidden trophy.
3. Any regular stock chassis with body equipped for two persons on the front seat and with standard equipment, and carrying not less than two persons, may compete for the Hower trophy. The car may have a rumble seat for one or two persons and additional passengers may be carried.
4. Any stock car, consisting of a combination of a miniature tonneau with doors, mounted upon the chassis regularly furnished with same and standard equipment, carrying four persons or ballast at the rate of 125 pounds per person, may compete for the..... trophy.
5. Cars shall at all times during the tour carry mufflers and mudguards, and be fully equipped as per manufacturer's catalogue specifications, except that tops and wind shields need not be carried.
6. Shock absorbers and spring wrappings may be added before the start as equipment, though not regularly furnished.

Responsibility of Entrants.

1. Each entrant by his signature to the entry blank shall agree that he is familiar with the rules, that he will abide thereby and accept the official records, and authorize the American Automobile Association to publish them in such manner as it shall determine.
2. Each entrant shall hold the American Automobile Association harmless and indemnify it against all loss or damage resulting directly or indirectly from or growing out of the operation, management, or control of the car entered by him.
3. The American Automobile Association shall not be responsible for any damage that may be done to any car, its passengers or contents during the tour, nor for the theft of any car or any of

its accessories or contents, the same being at all times subsequent to such entry, and until the close of the tour, at the risk in all respects of persons entering same.

4. Each entrant or his official representative shall be responsible for the acts of passengers in his car.
5. Each competing car must be delivered into the custody of the committee before 9 o'clock on the morning of, 1909, for official examination and to check the inventories of parts and tools hereinafter provided for.
6. Each entrant shall name an official representative for each of his entries, on or before July 1, 1909, failing which the driver of the car shall be considered the official representative.
7. The official representative of the entrant shall be subject to all rules and penalties prescribed for the entrant, and shall be considered as the entrant in fact.

Entries.

1. The time for receiving entries shall expire on June 16, 1909, at 12 o'clock noon at the office of Frank B. Hower, Chairman, Contest Board, at 760 Main street, Buffalo, N. Y. Each entry must be accompanied by the entrance fee. For entries received prior to May 15 the fee shall be \$200; after May 15 and until 12 o'clock noon on June 16 the entrance fee shall be \$300.
2. Each entrant shall give all details asked for in the entry blank and such additional information as the Contest Committee may from time to time require.
3. The Contest Committee of the American Automobile Association reserves the right to refuse any entry.
4. Entries shall be numbered in the order of their receipt.

The Route and Schedule.

1. This information will be supplied later.

Pacemaker.

Each day's tour will be preceded by a pacemaker's car; and any entrant or representative thereof who passes the pacemaker shall be disqualified. If the pacemaker's car breaks down or is compelled to travel at a rate of speed so slow as to impede the progress of the tour, his flag shall be transferred to the first car overtaking him, which car shall thereafter become pacemaker's car subject to the same conditions.

Class Schedule.

- Competing cars shall be divided into classes as follows:
- Class A.—Cars listed at \$3,751 and upwards.
 - Class B.—Cars listed at \$2,451 to \$3,750 inclusive.
 - Class C.—Cars listed at \$1,751 to \$2,450 inclusive.
 - Class D.—Cars listed at \$1,000 to \$1,750 inclusive.
 - Class E.—Cars listed at \$999 and under.

1. The Class A running time for each day shall be posted on the bulletin board at headquarters the previous evening. Each driver, using this as a basis, shall figure his own running time and when due at controls.

When the daily running time shall be 9 hours or more the running time of

- Class B will exceed that of Class A 20 minutes.
- Class C will exceed that of Class A 40 minutes.

Class D will exceed that of Class A 60 minutes.
 Class E will exceed that of Class A 80 minutes.
 When the daily running time shall be greater than 7½ hours and less than 9 hours the running time of
 Class B will exceed that of Class A 15 minutes.
 Class C will exceed that of Class A 30 minutes.
 Class D will exceed that of Class A 45 minutes.
 Class E will exceed that of Class A 60 minutes.
 When the daily running time shall be 7½ hours or less the running time of
 Class B will exceed that of Class A 10 minutes.
 Class C will exceed that of Class A 20 minutes.
 Class D will exceed that of Class A 30 minutes.
 Class E will exceed that of Class A 40 minutes.

Tools, Parts, Replacements and Repairs.

1. Each entrant shall furnish prior to the start an inventory of all parts carried in his car, and these shall be officially checked, sealed and record made of same, and charged for when used. Each entrant must furnish the manufacturer's price of each part carried.
2. All tools carried shall be listed by the entrant and officially checked prior to the start. Tools include wrenches, hammers, screw-drivers, etc., and not the small accessories frequently included in tool kits, such as emery, wire, solder, etc., which are parts or material and must be sealed.
3. Each entrant may carry as many tires, rims and tire chains and the parts which secure them in place as desired.

Tire Repairs.

There shall be no penalty for tire repairs, provided the engine be kept running while the repairs are made and no other work done. The time consumed in making tire repairs while the engine is running shall be added to the day's running time.

Controls.

1. Each contestant shall be ready to check out at 7 o'clock each morning. Checkers shall be at their stations at that time prepared to start the cars.
2. Each entrant, or official representative of such entrant, upon starting each day's run, shall sign a statement submitted by an official of the tour fixing the time of his departure, and shall be given a card, indicating such time. Failure to comply shall result in disqualification.
3. The Committee may establish such checking points as it may deem proper.
4. A car ahead of time at night controls may immediately check in.
5. There shall be established at the close of each day's run a parking station, in which all competing cars shall be stored. The station shall be in charge of the Chief Observer.
6. Each car shall be checked on arrival at the control.
7. Following the registration at each night control, each car shall be delivered into the custody of the officials of the tour to be by them held at owner's risk, and kept under direct charge and supervision of such officials or their agents until the time for starting on the following morning, but after registering, the car may deliver the occupants (other than the driver and observer) and baggage at hotel and then immediately proceed to the parking station.
8. Passengers and baggage may be taken on at the parking station after the car has been delivered over to the observer and driver before checking out in the morning, or at the hotel after checking out, but no time shall be allowed.

Intermediate Checking Stations.

Checking station will be inaugurated in so far as it is necessary to stop racing. Each driver shall receive a card when checking out in the morning which shall name checking stations, so that he can estimate his running time during the entire day. There shall be no appeal from the time registered by the various official watches.

Observers.

1. Each entrant shall furnish at his own expense one official observer for each car entered by him; all observers shall be acceptable to the committee and subject to its instructions. If the entrant is an automobile manufacturer or dealer, or in any way connected with the manufacture or sale of automobiles, each observer furnished by him shall be
 - (a) A person who has been regularly and exclusively employed by the entrant by whom he is nominated for a period of not less than three months immediately prior to the contest, or
 - (b) The entrant himself or an officer or director of his business, or
 - (c) A dealer in the car made by the entrant;
 - (d) An owner of a car made by the entrant.
2. If the entrant is not an automobile manufacturer or dealer, the observer furnished by him shall be satisfactory to the Committee.
3. Each observer may be assigned to a different car each day.
4. The Committee shall be empowered to suspend any observer who neglects, is incompetent, or for any other reason fails to fulfill the duties assigned to him, and to provide a suitable substitute at the expense of the entrant, by whom suspended observer was nominated.
5. It shall be the duty of each observer under all conditions and without evasion of this rule for any reason whatsoever, to remain with the car until he has been relieved by the chief observer and to report every detail of the performance of the car to which he is assigned, and all persons who operate, repair, assist or perform any action connected therewith.
6. Observers must not advise drivers as to the rules, but in case of a tire repair when the engine is running he shall sign and hand to the driver a printed form on which is filled in the time used and see that the time is added to the running time.
7. After the car is parked the observer shall present his record for inspection to the driver of the car on which he has ridden and obtain the driver's signature thereto. The record shall then be immediately delivered to the chief observer; the driver, the observer and other occupants of the car shall leave the parking station only when released by the chief observer.
8. In the event of sickness or an accident to an observer which shall make it an impossibility for him to remain with the car, or secure a substitute properly authorized, he shall select one of the passengers of the car as a substitute observer, who shall perform all of the duties pertaining to the position and shall, in addition thereto, have his record signed by all the occupants of the car during the time he is on duty.

9. Should any objection be made by the driver to the record, a report may be made immediately to the Chairman, who, in the event of a dispute as to facts, may require the driver to state his objections in writing. The record may also be inspected by one other properly authorized representative of the entrant, who shall also have a right to register an objection and submit proof in support thereof.

10. The observer shall ride in the seat assigned him by the entrant or driver.
 11. When any work, whether under penalty or non-penalty conditions, is being done on different parts of the car, making it impossible for the observer to properly watch each operation, the observer may compel one of the workmen to stop until such time as he can properly watch him.

Penalties.

1. All cars start with clean score.
2. Penalties shall be imposed for:
 - (a) Late arrival at night control.
 - (b) Repairs and replacements.
 - (c) Deterioration as shown by final examination under published schedule.
3. After an allowance of two minutes, each late arrival will be penalized one point for each minute or part thereof.
4. Parts, labor and use of tools shall be penalized as follows:
 5. Inventoried parts and material carried from the start: One-tenth of a point for each ten cents (10c.) or fraction thereof.
 6. Time consumed by driver and mechanic in work in connection with such parts: One-tenth of a point for each man working for each minute or fraction thereof.
 7. Outside labor: Two-tenths of a point for each man working for each minute or fraction thereof.
 8. Parts and material not inventoried and carried from the start: Two-tenths of a point for each ten cents (10c.) or fraction thereof.
 9. Time consumed in connection with such uninventoried parts: Two-tenths of a point for each minute or fraction thereof for each person.
 10. For the use by driver or mechanic of tools not listed: Two-tenths of a point for each man for each minute or fraction thereof that such tools are in use.
 11. When a number of parts are used at the same time, each part shall be separately penalized. Example: If a bolt and nut are used together, each will be recorded and penalized as a separate part.
 12. Any car which may, for any reason, discontinue as a contestant, shall be penalized 1,000 points in addition to all previous penalizations.
 13. In recording time to be penalized, the operator of the car and the observer must mutually agree as to the time when work commences, which shall be immediately recorded on observer's card, and as to the time when such work ceases, which shall also be immediately recorded.

Road Regulations.

1. Entrants and official representatives of entrants shall conform to all laws, ordinances and rules of the road, and any entrant or official representative of such entrant violating any of the provisions of these rules, or of other rules adopted by the Committee, or who shall fail to show due consideration to the officials or other participants in the tour or other users of the highways, may be disqualified.
2. Any car whose owner or driver shall be arrested for a violation of speed laws, or of any law or ordinance, may be disqualified.
3. When road conditions are so bad that a car cannot get sufficient traction to move, or is ditched, and reasonable effort has been made to extricate it, towing or other external means may be used to relieve the immediate distress only, but under no circumstances shall a car enter a night or any other control except under its own power. When towing, or assistance from any external source shall have been received by a car, its observer shall make a full and complete report, giving time, place, conditions, distance of tow, and any other details.
4. Each car shall have its official number prominently displayed on each side of the hood, and, if possible, painted on radiator.
5. No record of any previous performance, or sign, or special indication of the maker's name, other than a nameplate on the front of the radiator, shall be displayed on any car at any time during the tour.
6. All replacements, replenishments, adjustments, or repairs can be done only on the daily running time.
7. The tools listed may be used by the operator and by the mechanic without penalty, but must be done on running time.

Protests; Disqualification.

1. A written protest may be filed with the Committee, by any participant in the tour, but must be accompanied by the sum of \$25. If the protest is not sustained this sum will be retained by the American Automobile Association, but if the protest is sustained, the protest fee will be returned to the person making such deposit. No protest except conforming to the above requirements will be considered. Each protest will be acted upon at the earliest practicable moment.
 - (a) Any protests as to unfair rulings, routes, etc., shall be made within twelve hours after the occurrence.
 - (b) Any other protests shall be made during or immediately after the tour is concluded, and before any award is made.
2. No entrant, or his official representative, shall be disqualified until he shall have been notified of the act complained of, and if the act be denied, he shall be given a hearing, after which a decision shall be rendered. Upon notice of such disqualification he shall cease to run in the contest, the official numbers shall be removed from his car, and such entrant shall not receive any certificate, but shall be mentioned in the records as having been disqualified, and no entrant of any car that may be disqualified shall have any claim of any kind or nature whatsoever against the American Automobile Association of any member or members of any committee or any official of the tour, because of such disqualification, or the publication thereof, or failure to mention the performance of the disqualified car prior to its disqualification.
3. Contestants who withdraw may, in the discretion of the committee, continue on the tour as "non-contestants."

Powers of the Committee of the Contest Board.

1. The Committee of the Contest Board shall manage the tour, with full power to enforce the rules, render decisions and do anything else that would be within the province of the Contest Board of the American Automobile Association.

PROPOSES A NEW KIND OF COUNTRY ROAD

WASHINGTON, Jan. 19.—A new kind of country road—a combination of asphalt and macadam—was proposed to the Independent Asphalt Association at its annual meeting, in the New Willard Hotel, to-day. The innovation was suggested by Amzi L. Barber, who has spent most of his life in the asphalt business. A macadam highway, with a strip of asphalt in the middle, he said, was the hope of the future, the only highway to stand the heavier loads and



This is a Typical Stretch of Country Road in Michigan.

the ever increasing automobile traffic. The idea bears the stamp of novelty, and the speaker's argument was well presented. In the course of his address Mr. Barber quoted Government statistics to show how large a proportion of the country's wealth was produced by farmers, and what a small share of the Government appropriations, comparatively, was devoted to their interests. Largely on account of the unimproved state of the roads, he said, the mere hauling to markets and to shipping points costs the farmers of the country \$662,000,000 every year.

The speaker reviewed the progress of the good-roads movement in recent years, and advocated extensive Government aid.

"It is only a question of time," he said, "until such appropriations will be made. They are as necessary for good roads as for rivers and harbors, or for post-offices. The farmer has the same right to demand quick delivery, which is possible only over a good road, that the city man has to demand fast mail trains and frequent delivery by city carriers."

An Asphalt-Macadam Highway.

In approaching the problem of road construction, Mr. Barber sketched the advances made since John Loudon Macadam, a century ago, devised the kind of road which still bears his name. The macadam road, admirable as it is, has been found unable to stand against the wear and tear incident to modern vehicles, modern loads and modern speed. Mr. Barber said in part:

"Inasmuch as macadam and asphalt, by long evolution, the first for one hundred years, and the last for nearly forty years, have established themselves in many countries as the premier types of roads, I have, after long and careful consideration, come to the conclusion that the best, if not the only solution of our problem, is a combination of the two in the form of an asphalt strip of suitable width, running through, and usually in the middle of the macadam.

"Horses can be driven on the macadam as now, if desired. Automobiles, when the road is clear, will have an ideal surface in the middle, equal to a billiard table, with no ruts or lumps to look out for. When automobiles meet, they will slow down and turn out so as to run upon the macadam only on one side and for a few feet; and when rain first falls on the asphalt, making it slippery, they can run with one side on the pavement and one side on the macadam, to avoid skidding. When on the strip of pavement in the middle they will cause neither dust nor wear.

"Finally, and if no other advantage were to be gained, farmers can haul on the asphalt more than double the load that they can haul on macadam. This consideration alone should decide the matter in favor of the asphalt strip."

Mr. Barber spoke of the damage caused to the smooth surface of roads by automobiles and of the increasing seriousness of this damage.

"It is well known," he said, "that automobiles, even at moderate speed, tear up macadam and grind

its fragments into dust, thus destroying the road and causing a nuisance to all who use it, and to occupants of houses on the roadside. It is equally well known that automobiles do not destroy asphalt pavement nor cause any dust from it, no matter how great the speed may be.

The Automobile an Important Factor.

"Ten years ago the manufacture of automobiles in this country was practically *nil*. During the year 1907, according to excellent authority, there were produced 52,000 motor cars, with a value of \$105,000,000; and about the same output has taken place in 1908. For the year 1909 it is estimated that the manufacture of motor cars in the United States will reach 75,000, with a value of \$150,000,000.

"From these figures it seems safe to predict that the motor cars have come to stay. The farmers themselves, who bitterly opposed them at first, are now owning automobiles, and find them to be their most valuable acquisition.

"Statistics in former years show that farmers' wives provided a greater percentage of insanity than any other class. The introduction of the telephone and the rural free delivery have in some measure tended to remove the essential isolation and monotony which were considered the chief cause of the insanity. Automobiles and good roads will furnish complete remedies for these two handicaps to farm life.

"There are in the United States 225,000 miles of railroads, and 2,151,570 miles of public roads, only about 8 per cent. of the latter being improved. For every mile of railroad there are about nine miles of dirt and one mile of good stone road.

An Unanswerable Good Roads Argument.

"The total expenditures of the United States for the ten years ending in 1906 amounted to \$6,309,742,632. Of this vast amount only about three-fourths of 1 per cent., namely, \$47,000,817, was directly devoted to the interest of agriculture and yet the prosperity of the whole country depends primarily upon the condition of the agricultural interests. Manufacturing, transportation, trade and banking all are directly related to and dependent upon the crops which the farmers raise and haul to shipping points on rail or river. Every citizen of, and every person in, the United States is a consumer of farm products, and is directly benefited by cutting down the cost of hauling those products from the farms to the shipping points.

"Now, if Uncle Sam would appropriate, say, \$20,000,000 yearly for ten years for the building of good roads, and would apportion this among the States and Territories according to population, on condition that the States accepting should provide three times as much, the benefit to the whole people of the United States would be immediate and of enormous value. The States would eagerly accept their allotment, and could provide the three-fourths of the money required by contributing one-fourth themselves, and apportioning the two-fourths thus obtained among the counties, with the provision that the counties supply the remaining two-fourths. Then each county could itself contribute one-fourth and apportion the three-fourths among the townships, on condition that the townships accepting the apportionment provide the remaining one-fourth. This arrangement means that for every dollar provided by the United States each State, each county, and each township would provide another dollar. Under such an arrangement the building of good roads throughout all the United States would proceed by leaps and bounds."

Taking the average cost of making a sixteen-foot macadam

roadway as \$10,000 per mile, Mr. Barber estimated the total cost of a sixteen-foot road with a six-foot strip of asphalt in the middle at about \$13,000 a mile, an increase of 30 per cent.

"This asphalt strip," he said, "should last for from fifteen to twenty years, or longer. It will successfully overcome the old difficulties and avoid causing any new ones."

For the actual construction of the new kind of road, he proposed a portable plant for mixing and laying the asphalt. This plant, carried either on one four-wheel vehicle, or in separate parts on separate vehicles, would be self-propelling. The ingredients would be delivered alongside the plants in wagons, or along road at proper distances, for use as the machine was driven forward. The proposed plant would have its mixer in the rear, so that the hot mixture would fall directly upon the spot where it was to be laid. This method, as compared with the stationary plants employed in cities, would save the cost of hauling the mixture from the plant to the place where the work was in progress. The elimination of cost in hauling the mixture would be of vast importance.

PART OF AUTOIST IN NATIONAL CONSERVATION MOVEMENT

THE American automobilist has probably never regarded himself as a part of the great national conservation movement which has now taken root and which is being pushed by some of the ablest minds in the country.

Powell Evans, of Philadelphia, who is chairman of a delegation recently appointed by the American Automobile Association to confer with the National Conservation Commission, in a recent interview gives some idea of the duty which falls upon every member of the national automobile association in order to carry out to an ultimate and successful conclusion the building, maintenance, and mapping of a great chain of highways reaching in all directions over the United States.

Mr. Evans, who is also chairman of the A. A. A. Touring Information Board, believes that through the connection of the association with the National Conservation Commission the twenty thousand odd members will now be in a position to accomplish more in the direction of good roads than they have ever been able to do through any previous good roads organization.

Much Can Be Now Accomplished.

While a great deal has been done by automobile clubs scattered throughout the country, the effort has been more or less disjointed, and it is now believed that through the influences of the Conservation Commission all which has been done in the several States can be brought together, maintained and improved for the good of the whole country and for all users of every kind of vehicle.

"The formation of automobile users into clubs," says Mr. Evans, "has finally developed into a definite policy, which comprehends the broad question of good highways, well built, maintained and carefully posted and mapped. This policy also embraces the decent use of highways, not only by automobiles, but by all travelers, together with just and equitable legislation for every class of highway users. This programme is being advanced

with activity, honesty and intelligence. The National Conservation Commission recognized this fact when it invited the A. A. A. to become one of its conferrees.

"The Conservation Commission fully appreciates the fact that one of its greatest duties is the encouragement of a complete system of national highways. A good road conserves energy, time and money. It seems to be the consensus of opinion that States should themselves construct and maintain the great highways within their limit, and that the lesser division of the State should construct the smaller highways. This is the general trend of advanced good road legislation from the legislative standpoint.

One Law for All Road Users.

"As regards road use, the association believes that travel on main highways should be regulated by one law for all users, and that if lights on vehicles are necessary they should be used on horse-drawn vehicles as well as on automobiles. It is now pretty generally recognized that some allowance must be made for the destruction of road surface by rapidly moving vehicles. If the caulks in the feet of horses or the chains on motor car tires destroy portions of the roadbed this should be borne as a necessary evil and charged to highway maintenance.

"It is further believed by every man who has given serious thought to this highway problem that the rules governing the use of public thoroughfares should properly come under the Interstate Commerce and not be subject to change at the whim of

some unreasonable local legislator or town board. The association stands for broad and uniform road laws covering all travelers alike. It denounces recklessness, and urges the punishment of all inconsiderate drivers, and it invites all users of self-propelled vehicles to join in this good work.

"The important principles underlying all good roads work are known but not sufficiently adopted. It is the purpose of the association to make all these facts known to those in authority, thus conducting an educational campaign."



This is a Stretch of the Famous Old Jericho Turnpike on Long Island.

CLUBS PREPARE FOR WORK OF NEW YEAR

NEW YORK STATE'S LEGISLATIVE SITUATION.

ALBANY, N. Y., Jan. 18.—While motor vehicle legislation has been given an impetus thus early in the session of 1909 by the Governor's recommendation in his message, there is nothing exceptionally significant in the bills which have been introduced so far. The State Automobile Association bill, which was considered and amended in several particulars without changing the general plan and scope of the measure at the end of the regular session of 1908, has been reintroduced in the Senate by Senator Allds, of Chenango, and in the Assembly by Assemblyman Hamm, of Wayne. The principle of the proposed increased tax or license fees for autos is a tax on weight, and began with a registration fee of \$5 for a motor vehicle of 1,500 pounds weight or less; \$10 for one weighing over 1,500 pounds and not more than 2,500; and for every 500 pounds in excess of 2,500 pounds an additional \$5. This question of a weight tax will have to be fought out again, as there are members of the Legislature who own two or more cars who insist that such a scheme produces an excessive tax on the individual and all out of proportion to the damage the motor vehicles do to highways in comparison to other vehicles which use the highways without paying any tax save where they may by chance be assessed as personal property. It is likely to be some time before the legislators get seriously to work figuring out just what sort of a motor vehicle increase tax bill they will frame.

The other motor vehicle bill so far introduced is not a new one, having been introduced and not pressed to final passage in either house by Senator Grady, of New York, in one form or another for the past three years. Senator Grady says his bill is aimed only at the reckless driver or operator, and proposes a rigorous penalty for any autoist who endangers life or limb of others on the highway. Nor is it wholly restricted to motor cars in its application as it covers all kinds of conveyances driven or ridden over the highways.

SYRACUSE HAS AN EFFECTIVE CLUB.

SYRACUSE, N. Y., Jan. 18.—The Automobile Club of Syracuse had its annual meeting at the Yates, with 75 members in attendance. In the absence of President H. W. Smith, First Vice-President Howard P. Denison presided. Both he and Mr. Smith were re-elected to their positions, as were also Dr. C. M. Ryan, second vice-president, and Forman Wilkinson, secretary and treasurer.

The constitution was changed to provide for the serving with the officers of a board of directors, and the following men were chosen to act for the first year: Alexander T. Brown, D. E. Watson, J. William Smith, C. C. Bradley, Jr., and Willett F. Brown. The president, one of the vice-presidents and four of the directors will in future comprise a necessary quorum for the transaction of business. This will avoid the annoyance in the past of frequent meetings being called with no resultant necessary quorum, for heretofore the club has had no directors.

The report of Treasurer Wilkinson showed the club to be in excellent financial condition. The receipts during the past year were \$1,583 and the expenses \$1,263, leaving a balance on hand of \$319.

There was considerable outlay the past year for road signs. About \$200 went to the State Association to be used in connection with the fund for fighting inimical legislation at Albany.

The total membership of the club the first of this month was 217, 205 being residents and an even dozen being from out of town. Sixty-eight new members were taken in during the year. A determined effort is to be made to make the membership 300 or over before the end of the present year. President Smith will later appoint a route sign committee, as well as committees on exhibitions, contests, races and tours, law and order, and roads.

MINNEAPOLIS CLUB WANTS TO BUILD HILL.

MINNEAPOLIS, MINN., Jan. 18.—Again the question of building a scientifically-constructed hill with absolutely correct grade is engaging the attention of the members of the Minneapolis Automobile Club. The idea was broached last Summer and a subscription list was at once started among club members, and now again the subject is up for consideration. It is planned to build the hill on the club's property at Bloomington, 18 miles from Minneapolis, along the Minnesota River bottoms. If necessary land will be leased adjoining that of the club, and a hill half a mile in length can be built. It will vary from 8 to 24 per cent grade, and there will be a sharp, hairpin turn, which will take the cars in the opposite direction and bring the finish right in front of the spacious clubhouse. There will be plenty of room under this arrangement for the construction of grandstands and bleachers.

Col. F. M. Joyce, president of the Minnesota State Automobile Association, recently wired Chairman Hower, of the A. A. A. tours committee, regarding the chances of the Glidden tour coming to Minneapolis this Summer. The answer read: "Impossible to say; very uncertain at present, but route will surely be West." This answer means much, as Chairman Hower has said positively that if the tour is in the West this Summer it will include Minneapolis and possibly Duluth. Col. Joyce will go to Milwaukee shortly to confer with the Milwaukee club officials and to co-operate with them in making arrangements for the handling of the "Glidden army."

BALTIMOREANS OBJECT TO PROPOSED LAW.

BALTIMORE, Jan. 18.—At the meeting of the Automobile Club of Maryland the members went on record in opposition to the bill framed by the Automobile Commission of Maryland proposing a special tax on autos to assist in the construction of improved highways throughout the State. Osborne I. Yellott, counsel for the club and who presided in the absence of the president, Dr. H. M. Rowe, explained that the owners now pay a personal tax and if the proposed bill was passed it would put an additional tax of \$60 on a \$3,000 machine, \$80 more on a \$4,000 car and higher rates in proportion to the cost.

The club appointed Joel G. Nassauer chairman of a committee to look for a site for a country club within 10 or 12 miles from the city. The members also expressed themselves as favoring the proposed National highway from Washington to Gettysburg, Pa. A resolution to this effect, which was passed at the meeting, will be forwarded to Congress.

The show committee is hustling around in search of a site for the proposed show under the club auspices the latter part of the next month.

NORRISTOWN DEDICATES NEW CLUBHOUSE.

NORRISTOWN, PA., Jan. 18.—The members of the Norristown Automobile Club were fully rewarded for all the trouble and expense of providing a home when they were able to be present with many friends at the formal opening of the new clubhouse. Within a few minutes' run from here, situated on Ridge Pike, it is easily accessible from all parts of Montgomery county and Philadelphia. On the inside the large living room with its wide fireplace is a most noticeable feature. The roast pork dinner was a ravenous success. Among those who responded to ex-Assemblyman John H. Rex, who acted as toastmaster, were: S. Boyer Davis, chairman of the legislative committee of the Pennsylvania Motor Federation; Robert P. Hooper, president of the Federation; President John E. Mountain, of the Norristown club; Assistant District Attorney Charles McAvoy, Justice O. F. Lenhardt, County Treasurer William Higginbotham, Frank Boyer, Dr. J. N. Hunsberger and Prof. A. J. Schissler.



Vol. XX Thursday, January 21, 1908 No. 3

THE CLASS JOURNAL COMPANY
Thirty-ninth Street Building, 231-241 West 39th St.
New York City

H. M. SWETLAND, President

EDITORIAL DEPARTMENT

A. G. BATCHELDER, Managing Editor
R. F. KELSEY, Associate Editor C. B. HAYWARD, Engineering Editor
W. F. BRADLEY, Foreign Representative

BUSINESS DEPARTMENT

A. B. SWETLAND, Business Manager
LOUIS R. SMITH FRANK B. BARNETT
W. I. RALPH, 1085 Old South Building, Boston, Mass.
C. H. GURNETT,
F. W. VAN SICKLEN, 1200 Michigan Ave., Chicago, Ill.
H. H. GILL, Detroit, Mich.
T. B. VAN ALSTYNE, Philadelphia, Pa.

Cable Address - - - - - Autoland, New York
Long Distance Telephone - - - - - 2046 Bryant, New York

SUBSCRIPTION RATES:

United States and Mexico - - - - - One Year, \$3.00
Other Countries in Postal Union, including Canada - - - - - One Year, 5.00
To Subscribers—Do not send money by ordinary mail. Remit by Draft,
Post-Office or Express Money Order, or Register your letter.

FOREIGN SUBSCRIPTION AGENTS:

ENGLAND:—W. H. Smith & Sons, Ltd., 186 Strand, London, W. C., and all their
railroad bookstalls and agencies throughout Great Britain; also in Paris
at 248 Rue de Rivoli.
FRANCE:—L. Baudry de Saunier, offices of "Omnia," 20 Rue Duret, Avenue
de la Grande Armees, Paris.
GERMANY:—A. Seydel, Mohrenstrasse 9, Berlin.

Entered at New York, N. Y., as second-class matter.
The Automobile is a consolidation of The Automobile (monthly) and the Motor
Review (weekly), May, 1902, Dealer and Repairman (monthly), October, 1903
and the Automobile Magazine (monthly), July, 1907.

THE MADISON SQUARE GARDEN SHOW.

An automobile show, or any other show, for that matter, which is held in Madison Square Garden has the advantage of occupying what is undoubtedly the best amphitheater in this country, both in location and in architecture; and if the show fails to be a success the management certainly cannot complain of inconvenient accommodations. When to the natural advantages of the building is added a scheme of decoration designed by an artist and executed regardless of expense, success seems almost assured. The present automobile show would attract crowds of sightseers merely as a spectacle; it cannot be denied that many go who have no interest in automobiles whatever. This gives a golden opportunity to the salesmen, and they are by no means slack in taking advantage of it. Even those whose chief interest lies in the automobiles themselves cannot be insensible to the beauty of the setting.

The decorators have wisely avoided over-elaboration; all details are subordinated to the general effect of spaciousness suggested by the ample proportions of the hall. There are no tall signs to break the view; the exhibitors' names are displayed on inconspicuous standards at the corners of their spaces. And, crowning feature of the whole, the entire end of the building is occupied by three enormous mirrors, which seem to double the amphitheater and make it a complete ellipse.

But, of course, the automobiles are the most important part of the show; and they are present in abundance. The makers who exhibit at the Licensed Association show are all old and well-established, most of them pioneers in the industry. For this reason there are few really striking novelties to be seen; all progress is in the line of refinement and perfection of standard designs. Many of the cars shown are indistinguishable, except by the expert, from former models; yet there has been undoubted progress. A few of the makers have attempted to atone for what they perhaps considered the monotony of their mechanical designs by the use of weird and startling color schemes—a reminder of the monstrosities so common five years ago. As a rule, however, body designs show a marked improvement. The toy tonneaus at present so fashionable are shown in great numbers; although small many of them are more comfortable to ride in than the larger bodies. There is a marked tendency toward the use of individual seats in the rear as well as in front. Mudguards are always fully enclosed, and cape tops are universal, except of course on closed bodies; many other details show the increased care that is being taken for the comfort of the passengers.

To those who attend such a show for the first time one of the most surprising features is always the vast number of exhibitors of accessories. That some of these companies which apparently make only the most trivial playthings—electric cigar-lighters, or a new kind of snap terminal, or a special tire patch—should be able to exist and thrive on the crumbs, as it were, of the industry, is one of the most remarkable evidences of the way in which the auto has intertwined itself in our every-day life.

There is little need to elaborate on the prospects for the coming year; the automobile is now a staple article of trade, for which an extensive market is permanently assured. Financial depressions must continue to affect it to some extent, as they do all industries, though the automobile has become in many cases an actual necessity of life. But the financial sky is now clear. Factories are working to their fullest capacity, yet the agents still call for more cars. Demonstrations are in many cases becoming things of the past. Every indication points to a year more prosperous than any the industry has known before.



THE IMPORTATION OF AUTOMOBILES.

As an indication of the activity in the automobile industry it is possible to use the figures of the importation of automobiles and parts as a guide, on the ground that the imported cars will bear a relation to the total of the cars actually used. It is not a constant relation to be sure, but it will serve as a first approximation, and it is interesting to note the extent to which automobiles and parts are brought into this country. The following values are for eleven months ending November of the years given, as reported in the advance sheets of the Department of Commerce and Labor.

In 1906, value \$3,997,674; 1907, \$2,918,783; 1908, \$2,343,646.

As an incident it is to note that the value for 1908 is not so far below the previous year as some of the prognosticators would have indicated. There are other evidences of quite the same reliability and just as difficult to connect up. In a word the automobile industry is a thorough-going proposition.

AUTOMOBILE ENGINEERS HAVE SUCCESSFUL MEETING

By CHARLES B. HAYWARD.

WITH a session that opened at 10 A.M. at the Automobile Club of America and wound up with the annual banquet at the Engineers' Club about ten hours later, the Society of Automobile Engineers brought to a close its fourth annual meeting, which lasted for two days and was the most successful and enthusiastic gathering of its members that has ever been held. As was the case on the opening day of the meeting, the first thing on the program was the running of a series of dynamometer tests on the club apparatus. This was in charge of Henry Souther.

The first car to be placed on the drums was a Fiat touring type, and in this case the principal object of the tests was to check the accuracy of the Veeder tachometer with which the car was equipped, by means of the delicate electric recording apparatus of the dynamometer. The car was run at speeds ranging from 5 to 50 miles an hour, and the readings of the tachometer closely checked with those shown by the instruments at points five miles apart at both increasing and diminishing speeds. The result was an unusually favorable showing for accuracy where the tachometer was concerned, its percentage of error, regardless of the speed, being so small as to constitute practically a negligible quantity. Both at the extremes of its range, as well as at intermediate speeds, its readings checked up with those of the dynamometer to an unusually close degree, the indications at five miles an hour revealing a percentage of error requiring three decimal points to express when figured in fractions of a mile per hour, and its variation at the higher speeds was correspondingly small. The test was carried out at the special request of the owner of the car, transmitted through Amasa Trowbridge, factory manager of the Veeder Manufacturing Company, of Hartford, and one of the members of the society.

Big Benz Tries the Dynamometer.

Through the courtesy of Peter Fogarty, a member of the society and American representative of the Benz, the big racing car which finished such a close second in the A. C. A. grand prize race at Savannah this Fall, and which was such a consistent performer in France last Summer, was placed on the drums. In the past it has been customary to speak of cars having been tried out by the dynamometer, but after witnessing the performances of the big Benz it was the consensus of opinion, not only of the engineers who inspected the machine for the first time, but of those who have been familiar with its operations since it has been installed, that the huge racing car tried the mettle of the testing apparatus very severely, and that without reaching anything like its limit. One or two of the engineers present facetiously remarked that "if Mr. Souther let her out any more, there would be a realistic horsepower indication on the big chart where the Benz had gone through it and the wall back of it too." Fortunately, this did not occur, but the great amount of power developed by the big racing car without drawing upon its excess in the slightest provided one of the most impressive demonstrations that the engineers had ever witnessed.

Despite the large number of members present, the fact that the car was encumbered with nothing more above its frame line than the usual scant racing attire of two bucket seats, tank and tire racks, permitted of an excellent view being obtained, and when the big car began to send the power and speed indicators of the instrument well along toward their maximum without being let out, the interest was intense. Mr. Souther sat in one of the seats beside the driver and when the tape showed a mile a minute one of the members considerately handed him a pair of goggles, remarking that they were necessary at that speed. There was more truth than jest in the remark, for the powerful blower employed to keep the temperature of the cooling water in the radiator down to a normal point, not only kicks up a

breeze that is the equivalent of a speed of many miles per hour, but it had also begun to pick up oil and water and send it along in a manner that added considerable realism to the scene for those on the car. No attempt at conducting a regular series of tests was made, as this would have consumed too much time, but at a speed of 65 miles per hour, running on the second speed, the car developed a tractive effort of 500 pounds, showing that more than 100 horsepower was being delivered to the rear wheels at that rate of travel.

Sessions in Engineering Building.

Luncheon was served to about sixty-five of the members at the Automobile Club, a number having had to leave earlier, due to the necessity of keeping appointments. Following this an adjournment was taken to the Engineering Societies Building, in Thirty-ninth street, near Fifth avenue, the privileges of the quarters of the American Society of Mechanical Engineers having been extended to the members on behalf of the former by Professor Hutton.

Owing to the absence of the authors, the papers on "The Economics of Weight Reduction," by F. D. Howe, and "An Improved Type of Compression Coupling," by W. S. Noyes, were read by title, and a special request made for contributed discussion to be published in the following issue of the Transactions on these two subjects.

The paper on "Standardizing Motor Bearings," by S. P. Wetherill, Jr., was then read by the author, and resulted in a lively discussion of a number of points regarding this very essential feature of the design of every motor, that was productive of considerable interest. Mr. Wetherill's paper and the suggestion that it contained is largely based upon the recent successful development of die casting under compression, that has been extended to a point where many alloys not formerly regarded as adaptable to this process can be thus successfully handled. Its employment results in a great saving in the cost of bearings, owing to the elimination of all hand work, as well as the necessity of any machining, as the bearings are cast absolutely true to size.

A number of the members present gave their experience with the use of die-cast bearings, prominent among them being John Wilkinson, designer of the Franklin, whose company has been responsible for the development of die-casting to a very large extent, so that bearings made in this manner have always been a feature of the Franklin cars. A number of other members spoke in favor of the suggestion advanced by Mr. Wetherill, and it is more than likely that more will be heard on this subject in the future, as it is a matter that interests the designer and manufacturer of cars on a large scale in a vital point—namely, that of reducing the cost of production.

S. W. Rushmore gave a résumé of the paper of which he was a joint author with Herbert L. Towle, on a type of indicator with a continuously revolving drum, which, as Mr. Rushmore explained, was not invented with the idea in mind of perfecting a power indicator for the automobile engine, but for a specific purpose—that of locating a fault in a three-cylinder stationary engine installed in the Rushmore plant at Plainfield, N. J. The makers of the engine had carried out all their tests on the first cylinder, which was in perfect working order, and accordingly they were confident that their guarantee on the engine had been fulfilled. The other two cylinders were difficult of access, owing to the size and location of the engine, and Mr. Rushmore devised this special type of indicator to ascertain what was taking place in them, in which he was very successful.

As a matter of experiment, the indicator was then applied to a Locomobile car and a large number of cards taken at various speeds, these cards forming part of the paper itself. Owing to the difficulty of synchronizing the instrument with the motor, its

records naturally do not form a reliable index of the power developed, but they do serve to show what is going on in the cylinder to which it is attached, and are consequently of value for locating faults, such as deranged valve and ignition timing, and the simplicity of the apparatus is such that it was the inventor's idea that it could be employed by a repairman or garage attendant, as no great amount of skill was required to attach or use it, and benefit by its records, once the nature of the latter and their indications were known. Considerable discussion followed.

Autogenous Welding Explained by Mr. Cave.

Through the courtesy of the Davis-Bournonville Company, a complete set of autogenous welding appliances was on hand, and were used by Henry Cave to give a demonstration of the process in connection with his paper on this subject. As the paper was long, Mr. Cave simply gave a short résumé of it, and then proceeded with the demonstration, welding a flange on a cylinder and later joining various metals. In the discussion that followed, W. H. Smith, general manager of the John Keim Mills, Inc., of Buffalo, took a prominent part, owing to his not only having been a pioneer investigator of the art but one of its largest practical users for several years past.

Annual Banquet Was Largely Attended.

Jesse M. Smith, president of the American Society of Mechanical Engineers, was the special guest of the evening at the annual banquet, at which seventy-seven members and guests sat down, the largest number that has ever been on hand for one of the yearly gatherings. Some of the others present were: President Henry Hess; past presidents A. L. Riker and Thos. J. Fay; second vice-president B. D. Gray, Treasurer A. H.

Whiting, and several of the managers of the society past and present, such as Prof. R. C. Carpenter, of Cornell, H. W. Alden, F. J. Newman and H. M. Swetland. Among the members and guests present were: Dr. George W. Sargent, Henry Souther, Clarence E. Whitney, William Herreshoff, Rollin H. White, John Wilkinson, H. E. Coffin, J. O. Heinze, C. S. Mott, V. J. Mayo, C. E. Davis, E. W. M. Bailey, Elwood Haynes, Henri Chatain, H. J. Edwards, A. J. Doty, J. M. Landsden, Jr., G. E. Franquist, A. H. Raymond, W. B. Hasselkus, J. A. Anglada, Frank Cooke, Lindley D. Hubbell, H. S. Baldwin, L. K. Clarke, Stanley Beach, C. E. Clemens, A. Churchward, F. Moskovics, H. F. Donaldson, A. L. McMurtry, R. M. Petard, Bruce Ford, C. B. Hayward, and a number of others.

President Hess's Souvenir Program Made Hit.

The feature of the dinner was the souvenir program prepared by President Hess. It was an eight-page pamphlet entitled "Feast of the Sponsors of Red Devils, Green Dragons and Blue Flyers, and their spawn of Jersey Justice Jolliers," the cover being ornamented with the emblem of the society. The motto of the dinner was Patrick Henry's prophetic utterance of March 23, 1775, paraphrased for the occasion. "But as for me, give me liberty (A. M. C. M. A.), or give me license (A. L. A. M.)," which was fitting in view of the fact that the most prominent engineers of both organizations have long been members of the society. The only toast permitted was that printed over the translation of menu into "clear chauffese," and expressed the wish, "May your intake be unobstructed, May your exhaust be clear." Despite the "independents" present, full license was given to talk to the right, left, front or rear, but any man who got up to say anything was threatened with an assault of crockery or anything else throwable.

THE AUTOMOBILE CALENDAR

AMERICAN.

Shows and Meetings.

- Jan. 27-Feb. 3. Philadelphia, Second Regiment Armory, Eighth Annual Show, Philadelphia Automobile Trade Association.
- Feb. 6-13. Chicago Coliseum and First Regiment Armory, Eighth Annual National Exhibition, National Association of Automobile Manufacturers. S. A. Miles, Manager, 7 East 42d St., New York.
- Feb. 15-20. St. Louis, New Coliseum Building, Third Annual Show, St. Louis Automobile Manufacturers' and Dealers' Association. John J. Behen, Chairman.
- Feb. 15-20. Detroit, Wayne Pavilion, Annual Show, Detroit Automobile Dealers' Association. E. LeRoy Pelletier, Manager.
- Feb. 15-20. Cleveland, First Regiment Armory, Annual Show, Cleveland Automobile Dealers' Company.
- Feb. 15-20. Bangor, Me., Auditorium, Eastern Maine Automobile Show.
- Feb. 16-18. Denver, Colo., Auditorium, First Annual Automobile Show, Denver Motor Club.
- Feb. 18-25. Toronto, St. Lawrence Arena, Third Annual National Automobile, Motor Boat and Sportsmen's Exhibition. Ontario Motor League. R. M. Jaffray, Manager.
- Feb. 20-27. Newark, N. J., Essex Troop Armory, Roseville Avenue. Second Annual Show New Jersey Automobile Trade Association. H. A. Bonnell, Manager.
- Feb. 20-27. Hartford, Conn., Second Annual Show, Hartford Automobile Dealers' Association.
- Feb. 24-27. Omaha, Fourth Annual Automobile Show, Omaha Automobile Show Association. C. N. Powell, Sec'y.
- Mar. 1-6. Buffalo, Convention Hall, Annual Show, Automobile Club of Buffalo. D. H. Lewis, Secretary.
- Mar. 6-13. Boston, Mechanics Building, Seventh Annual Automobile Show, Boston Automobile Dealers' Association. C. I. Campbell, Manager, 5 Park Square.
- Mar. 8-13. Kansas City, Kansas City Automobile Dealers' Association Show.
- Mar. 11-13. Milwaukee, Wis., Hippodrome. First Annual Show of Milwaukee Automobile Club.

- Mar. 13-20. Minneapolis, Minn., National Guard Armory, Second Annual Show, Minneapolis Automobile Show Association. F. E. Murphy, Secretary.
- Mar. 15-20. Rochester, N. Y., Convention Hall, Annual Show, Rochester Automobile Dealers' Association. Charles J. Moran, Exhibition Manager.
- Mar. 27-Apr. 3. Pittsburg, Duquesne Garden, Automobile Show, Pittsburg Automobile Dealers' Association.

Races, Hill-Climbs, Etc.

- Feb. 20-22. New Orleans, Fair Grounds Track, Mardi Gras Race Meet, New Orleans Automobile Club. Henry George, Secretary.
- Mar. 5-12. Palm Beach, Fla., Lake Worth, Fifth Annual Regatta. Palm Beach Power Boat Association.
- Mar. 23-26. Daytona, Fla., Seventh Annual Florida Beach Races, Florida East Coast Automobile Association. New York Representative, W. J. Morgan, Thoroughfare Building.

FOREIGN.

Shows.

- Jan. 30-Feb. 14. Turin, Italy, Palais des Beaux Arts, Automobile Salon.
- Mar. 15-31. Vienna, Austria, Automobile Exposition, Automobile Club of Austria.

Races, Hill-Climbs, Etc.

- Mar. 31-Apr. 14. Monaco, Italy, Annual Motor Boat Regatta and Championships.
- May 2. Sicily, Targa Florio, Automobile Club of Italy.
- May 26. Russia, Moscow—St. Petersburg Race.
- June 10-18. Germany, Prince Henry Cup Competition.
- June 14-19. Scotland, Scottish Reliability Trials.
- July 1-3. France, Angers Course, Grand Prix, Automobile Club of France.
- July 13-17. Belgium, Ostend Automobile Race Week.
- Sept. 5. France, Mont Venteux Hill Climb.
- Sept. 11-19. Italy, Bologne, Florio Cup Race, Automobile Club Bologne.

400 AUTOS BURNED IN BOSTON.

BOSTON, Jan. 17.—What is unquestionably the most disastrous automobile fire that has ever happened in this country occurred at dawn this morning, when 400 automobiles were burned in the automobile storage and repair plant located near Park Square. The fire came from the rear of the building, and the exact cause is not clearly established.

The fire also spread to the old train shed of the Park Square Railroad station formerly used as the terminal of the Providence division of the New York, New Haven & Hartford Railroad, and destroyed the bicycle track and a large pavilion used for exhibition purposes. Six horses in one of the buildings were burned. It is said that the total damage was above \$800,000.

There were six garages, including several used chiefly for repairs, in the big storage station formerly the railroad freight shed. The principal occupants were the Park Square Auto Company, the Boston Motor Company, the Rambler Motor Company, the Boston Auto Exchange, the Concord Motor Car Company, and the repair shop of the Marmon Company. All the large sight-seeing automobiles in the city, numbering upward of a dozen, were burned, while there were between thirty and forty expensive cars of the limousine type in the storage. Out of the automobiles only two were saved.

The insurance rates on the destroyed property were somewhat higher than those in effect on other buildings of like use in the city, and the majority of the owners were only partly insured.

There were about twenty workmen in the building when the fire started, but all managed to get away, although several of them had narrow escapes. The fire was the largest in this city since last Summer. Coming just before dawn, with buildings and trees coated with sleet from last night's storm, the spectacle when the firemen reached the scene was an imposing one.

The hardest fight which the firemen had was to keep the flames from extending into the business blocks on Columbus avenue, and fully one-half the entire available force was centered on that side of the fire area. The rest of the firemen rushed bravely into the great train shed, the roof of which was burning fiercely, and there the flames were fought until they were stopped by the great brick wall at the upper end.

REMY COMPANY RECOVERS QUICK FROM FIRE.

ANDERSON, IND., Jan. 18.—The buildings containing the magnet-making department and the power plant of the Remy Electric Company were completely destroyed by fire last Wednesday morning. The loss amounted to between \$3,000 and \$4,000, covered by insurance.

On account of the boiler for the heating plant of the entire factory being put out of commission by the fire, the factory was shut down until repairs could be made. The fire occurring in the middle of the busiest season for the company, necessitated the quickest kind of work on the new building and the buildings were rebuilt complete and under roof by Thursday evening, the second day after the fire.

The entire plant is running as usual and deliveries of Remy Magnetos will not be delayed in any way.

PRESIDENT-ELECT TAFT AN ASSURED AUTOIST.

WASHINGTON, D. C., Jan. 16.—For the first time in the history of the country Congress is about to pass a law appropriating money for the purchase and maintenance of two automobiles for the new President of the United States. The urgent deficiency bill reported to the House of Representatives to-day contains an item of \$12,000 for the purchase and maintenance of automobiles for the White House. The chairman of the appropriation committee explained that Judge Taft had intimated that he would use automobiles during his occupancy of the White House, and that he might have the machines at the beginning of his administration on March 4 next, the item was included in the urgent deficiency bill. The entire automobile trade of the country will rejoice over this glad news.

DETROIT'S "BIGGEST LITTLE" SHOW.

DETROIT, Jan. 18.—Preparations for the "biggest little" show, to be held in the Wayne Pavilion, February 15-20, under the auspices of the Detroit Auto Dealers' Association, are going forward rapidly. All plans have been perfected, and the manner in which the details are being worked out under the direction of Manager E. Leroy Pelletier gives weight to the statement of the show committee that so far as it goes—and that is a long way—it will be the equal of anything else in the country, not barring the New York shows.

The decorations will be on a more elaborate scale than ever before attempted locally. Sculptor Edward Wagner, who first won recognition in connection with his work at the Pan-American Exposition, has been busy for weeks preparing designs in clay and an army of men are now engaged in reproducing these in staff. The piece de resistance will be a quartet of chauffeur mermen supporting the main bowl of the big fountain that is to occupy the center of the second floor. Each merman wears cap and goggles and his hands, the muscles on the bare arms standing forth boldly, grasp a steering wheel. The upper bowl is supported by racing chauffeurs, while at the entrance to the seats that enclose the fountain will be smiling automobile girls.

The lower floor will be converted into a Venetian garden with 200 canaries hidden among the foliage.

MILWAUKEE WILL HAVE AUTOMOBILE SHOW.

MILWAUKEE, WIS., Jan. 18.—The first show in the history of the automobile industry in Wisconsin will be held at the Hippodrome in Milwaukee, March 11, 12 and 13. The Milwaukee Automobile Club has just announced its plans for the exposition. The officials believe the time is ripe for Milwaukee to have a show, as the industry never experienced so great a growth as during 1908, and 1909 is expected to be even more successful.

The Hippodrome will be used this year, and beginning in 1910 shows will be held annually in the Milwaukee Auditorium, under construction at a cost of \$500,000. The Auditorium will not be completed until April 1.

Secretary James T. Drought, of the Milwaukee club, has already commenced active work on arrangements for the show. The Milwaukee Trade Association will give its hearty co-operation, they being closely identified with each other. There are about 35 agencies in Milwaukee and 40 makes represented.

CLEVELAND'S SHOW LOOKED UNCERTAIN.

CLEVELAND, Jan. 19.—For a few days last week the fate of the Cleveland Automobile Show, to be held February 22-27, was in doubt, for the fire wardens, learning through the efforts of an overly enthusiastic press agent that some 20,000 yards of bunting and thousands of incandescent lights were to be used, started an investigation. Since the terrible Collinwood school fire and the catastrophe in a five-and-ten-cent store, the word "fire" is something to be conjured with in this city.

The wardens served notice on the committee that they would have to give proof that there was no danger of fire. As a result, Sterling & Welch were obliged to give a demonstration of the result of their fireproofing. Many yards of bunting were subjected to such tests, and it was then announced that every incandescent light socket had an asbestos collar. The final result was that the committee was given permission to proceed under the supervision of the wardens.

PENNSYLVANIA WANTS UNIFORM AUTO LAW.

HARRISBURG, PA., Jan. 19.—A resolution asking Governor Stuart to invite the Governors of New York, New Jersey, Delaware, Maryland, West Virginia and Ohio to cooperate with Pennsylvania for a convention to enact a uniform automobile law in the States bordering upon Pennsylvania was introduced in the Senate to-day. The resolution, which was referred to committee, authorizes Governor Stuart to appoint five delegates to the convention.

FAIR WINNERS RECEIVE THEIR TROPHIES.

Unfortunately for some of the fair participants in the recent two-day run to the Quaker City and return of the Women's Motoring Club of Philadelphia, there were not enough prizes to go round, and as the decision of the committee regarding the six that were awarded was unanimous, there will doubtless be some heartburnings. Five of the successful contestants had perfect mechanical and time scores under the regulations of the run, while one prize winner had the misfortune to carry a mere man along as a guest and suffered in consequence, when it came to footing up scores.

Mrs. John Ramsey, of Hackensack, N. J., who drove a Maxwell runabout and carried Miss Hermine Jahns as a passenger, was awarded the Benjamin Briscoe trophy for the driver of a Maxwell making the best showing, while Mrs. J. N. Cuneo, of Richmond Hill, L. I., captured the Hugh Chalmers trophy by her spirited driving of the Lancia "Lampo" car. Her sister, Mrs. Harry Cushing, was the only passenger. Mrs. A. W. Seaman, of Brooklyn, who carried next to the largest number of passengers on the run in her Model D, 1906 Franklin, was awarded the Hol-Tan trophy. Beside the driver there were Mrs. D. H. Seaman, Dr. Elizabeth Hatton, Dr. Florence Lee-Jones and Dr. Ellen Lysaght. Mrs. Seaman was one of the champion drivers of the run, for though she only tips the scale at 90 pounds, she cranked the motor and swung five-gallon gasoline cars like a garage helper.

Miss Alice D. Heyes, of Brielle, N. J., captured the cup donated by the Women's Motoring Club by her skilful handling of one of the new Cadillac "Thirties." Her passenger list was the heaviest of the run, comprising Miss S. E. and M. R. Heyes, Miss E. M. Keysby and Mrs. E. S. Brainard. Mrs. Evelyn M. Buckman, driving a 24-30 Renault, was awarded the managers' donated by W. J. Morgan, while the Secretary's cup, given by Alex Schwalbach, was won by Mrs. A. C. Back, of Newark, N. J., who drove a Maxwell runabout and was accompanied by her husband. Mrs. Buckman, who is a tall and athletic Englishwoman, handled her Renault with consummate skill and stood among the first in the run, but her record suffered through the presence of mere man, who did nothing but lend his company to the occasion. Her other passengers were Mrs. Ida Goodel and Miss M. B. Schwalbach.

CONCERNING PLANS OF THE H. S. HOUPPT CO.

Editor THE AUTOMOBILE:

There has been some public discussion of the relations of the Harry S. Houppt Company and the E. R. Thomas Motor Company.

In order that there may be no misunderstanding of our position, we beg to announce that the Harry S. Houppt Company expects to continue as the agents of the E. R. Thomas Motor Company for the sale of Thomas cars in this district until the expiration of its present contract on August 1, 1909.

Harry S. Houppt, who is introducing the Herreshoff car, is acting as an individual solely. The Harry S. Houppt Company will continue to handle the Thomas car during the life of its contract with the E. R. Thomas Motor Company. The Harry S. Houppt Company will also continue the management of the garage department until the expiration of the agency contract with the E. R. Thomas Motor Company.

At the expiration of the contract on August 1, the Harry S. Houppt Company expects not only to take over Mr. Houppt's personal interest in the Herreshoff car, but to introduce another new car on the market to be known as the Houppt car.

The Houppt car will be a larger car than the Herreshoff—will be built both as a four-cylinder and a six-cylinder model. Details of its construction will be announced in due course.

HARRY S. HOUPPT COMPANY,
E. M. HOUPPT, Secretary and Treasurer.

New York City.

Brookland's 1909 Programme.—During 1909 the committee of the B. A. R. C. proposes to hold race meetings on Bank Holidays and other days to be announced later, and have decided to greatly increase the privileges of members. In addition to the regular race meetings, open to all comers, it is intended to hold one or more club contests with ordinary touring cars.

AUTO DOINGS IN CONNECTICUT'S CAPITAL.

HARTFORD, CONN., Jan. 19.—Halsey M. Barrett and Henry W. Nuckols, receivers of the Electric Vehicle Company, have filed their report of business done during the month of December, with the Superior Court. The Selden patent royalties helped somewhat to swell the cash statement. The report shows charges on account and cash sales of \$32,895.34 and purchases of \$26,283.65. There was collected by the receivers on the Electric Vehicle Company accounts \$3,138.38 and on the receivers' own account \$36,266.49, while the Selden patent netted \$1,311.92 and interest of \$782.32 brings the total receipts up to \$41,499.11. Of the disbursements, \$29,518.52 has been for the factory pay roll. The A. L. A. M. received \$1,139.40. The cash balance on deposit in the local bank and the Chase National Bank, of New York City, is \$141,812. It is said on good authority that a reorganization will be effected very shortly.

Rumor has it that the Adams-Farwell people will occupy the old Pope tube mills if negotiations can be successfully consummated. Representatives of the company have been in this city during the past few days and have endeavored to get capital interested in the Adams-Farwell car.

Albert L. Pope and George A. Yule, receivers of the old Pope Manufacturing Company, have rendered their report covering the business done under the receivership from November 30 to December 23, 1908. It will be remembered that the concern was reorganized the latter part of December, hence the report covers business done up to that time. The balance in bank and cash on hand in the company's office November 30 last was \$75,225.49; the cash receipts for the period total \$152,655.51. The disbursements amount to \$142,341.14. Except for minor details the receivership is practically at an end.

The McCue Company, builder of the McCue Hartford cars has erected a two-story brick building, 47 x 212 feet, on Pliny street. The front of the building will be devoted to the office quarters and the remainder for the shop proper. The McCue Company started work on the new building in November and it is nearly completed. At present the company is located on Capitol avenue, which quarters have become too crowded for the successful carrying on of the increasing business.

A movement is on foot to make free such ferries as now ply on the Connecticut River where there are no bridges. As autoists have no other means of reaching either shore without an extensive detour, the ferries derive quite a revenue. That at Lyme, at the mouth of the river, did a hustling business all summer. No one will raise the slightest objection to the ferries being made to transport free of charge.

NEW TWO-CYCLE, FRICTION DRIVE CAR.

St. Louis, Jan. 18.—At the opening of the automobile show a new local car manufacturer will make his public debut. The concern is now at work on its first two machines, which will be shown at the Coliseum exhibition, February 15-20. The car, to be called the Darby, will embody in its design all that is desired by the popular fancy and will sell at a price commensurate with the rapid advance of the low-priced automobile.

To provide simplicity and low first cost, a two-cycle, two-cylinder motor will be used in connection with friction-drive transmission. This motor, designed by C. T. Darby, will deliver a full 16-horsepower. The Darby will be built only in runabout style, with single and double rumble seat. In appearance it will be distinctly smart and speedy. The 30-inch wheels will be equipped with three-inch tires. Ignition will be well taken care of by the Atwater-Kent Unisparker. Left-hand drive will be provided.

Harvey D. Dunham and Allen Whittemore are officers in the Darby Motor Car Company, for which corporation papers have been filed. Both are well known in St. Louis society and have for a long time been enthusiastic autoists. Mr. Darby, designer, has had a thorough automobile engineering experience; he was recently connected with a well-known maker of light runabouts



Chas. Templeton, West Liberty, Ia., Using Ford in R. F. D. Work.

Crazy Over Racing.—Reports from the far West seem to indicate that the people on the Coast have gone crazy over automobile races, regardless of kind, place held or speed attained. Following closely upon the announcement of the surfacing of the Ascot track at Los Angeles for races, and a series of races held on the first surface, comes the road-record breaking. These were not confined to any particular course, but as soon as anyone made a record, on the plan pursued at the Donegal (Ireland) fairs, when you see a head hit it, someone immediately went out and broke the new record. This has been fostered by the trade in various ways. For instance, the Chanslor & Lyon people of San Francisco have recently offered a cup for the San Francisco-Del Monte round trip record. This will make a trip of about 200 miles and was to be opened on January 1. No sooner had the cup been announced than half a dozen ambitious road drivers announced their intention of going after it.

Stromberg's Successful Show.—After the show is over and the manufacturer begins to count the cost, the query begins to spring up, "Was it worth while?" The answer from the Stromberg Motor Devices Company, of Chicago, is favorable. Its officers say: "As far as we are concerned, the Palace show was a great success. A great many carbureters were sold direct to owners, and a number of manufacturers heretofore using other makes were intensely interested, going into details regarding the manufacture of the Stromberg carbureter and results obtained by its use. A number of demonstrating cars at the show were equipped with the Stromberg carbureter, and although the weather conditions changed most every day, the carbureter gave universal satisfaction."

National Sales Corporation Announcement.—Signed by Emil Grossman, president, the following announcement comes from this concern: "Owing to differences of opinion regarding the policy of handling the Soot-Proof plug and Automatic wind shield business, we have by mutual consent terminated our sales arrangements with C. A. Mezger, Inc. We will shortly notify you of the name of the wind shield and spark plug that we will be responsible for. Our long-established policy of selling high-grade goods at the lowest pos-

sible cost, protecting the trade in their legitimate profits, and making prompt shipments, as well as answering all letters courteously, will be continued as in the past."

Annual Meeting Carrico Motor Company.—This Ohio corporation held its annual meeting January 4, at 208-214 Elm street, Cincinnati. The following officers and directors were elected: President, O. E. Walker, president of the Queen City Forging Co.; vice-president and general manager, F. D. Carrico, formerly general manager of the Speed Changing Pulley Co., and designer of Carrico air-cooled engines; secretary, T. P. Walker, of the Queen City Forging Co.; treasurer, Charles S. Ferris; directors, R. K. LeBlond, of the R. K. LeBlond Machine Tool Co.; Edward Raber, of Raber Bros., hardware merchants, and W. H. Kratz. The increase of business is to bring about factory enlargements.

Toledo Dealers Incorporate.—The automobile dealers of Toledo have formed an association and incorporated under the name of the Toledo Automobile Dealers' Association. Some sixteen dealers have joined and three more are expected to do so. The directors will probably include A. A. Atwood, E. A. Kirk, S. C. Fisk, J. G. Swindeman, A. W. Norris and B. G. Gamble. Another meeting is scheduled for the near future, when officers will be chosen and the final details of the association perfected.

Wanted: American Automobile Agency in Germany.—An American consul in Germany reports that the demand for automobiles in his district is steadily growing and conditions are favorable for a large trade in first-class American makes. He furnishes the names of several local merchants, interested in this trade, who would be glad to correspond in regard to an agency for American vehicles. Address No. 2939 Bureau of Manufactures, Washington, D. C.

Rider-Lewis Motor Car Company's New Plant.—At Anderson, Ind., the new plant of this company is progressing rapidly, and it is expected that it will be ready for occupancy in the early Spring. The Rider-Lewis is a light six-cylinder car of 40-45-horsepower, made in three models, and sold for \$2,500. The estimated output for the season is placed at 200 cars.

Gramm-Logan Motor Truck.—Attention is called to the fact that the Gramm-

Logan truck exhibited at the Palace show is not in any sense of the word a continuation of the old Logan trucks, the company being entirely different and containing but two men formerly identified with the deceased Logan company. In addition, the details of the product are very different, the name of Logan being retained only for old association's sake.

Removal of an Old New York Firm.—John Lucas & Company, New York City, report that they have moved from Maiden Lane, where they have done business for thirty-seven years, to their new building at 521 Washington street, where they will have more room and a plant more modern in every respect.

IN AND ABOUT THE AGENCIES.

Pennsylvania, Philadelphia.—The J. M. Quinby Company, of Newark, N. J., which has been exploiting the Pennsylvania car in New York City and vicinity, has decided to open up a branch in Philadelphia. An interesting feature of the new move is the decision of the Quinby Company to sidestep the supposed-to-be vital advantages of a "gasoline row" location, and the innovation of opening new quarters in the Freeman Building, at the southwest corner of Twelfth and Walnut streets, will be watched with much interest, especially by those who claim that establishments out of the "select circle" of the "row" invariably wither and die. However, the Quinby reputation and the locality—right in the heart of the high-class shopping district and in close juxtaposition to the Quaker City's blue blood residential section—may prove a winning combination. Manager Thornton, of the firm of Thornton & Fuller, which represented several foreign cars in Philadelphia a few years ago, says the new quarters will be ready for a formal opening some time during the present week.

Franklin Agencies.—The following companies will represent the H. H. Franklin Mfg. Co. for 1909: Providence, R. I., Dauer Auto Company; Rutland, Vt., Rutland Machine & Auto Company; Newburgh, N. Y., George Mason; Scranton, Pa., Standard Motor Car Company; Danville, Va., L. Herman; Portsmouth, O., R. S. Pritchard; Peoria, Ill., Peoria Automobile Company; Danville, Ill., Robert Holmes & Bro.; St. Paul, Minn., Western Automobile Company; Salina, Kan., Saline Automobile Company; Portland, Ore., J. A. Hess & Company; Oklahoma City, Okla., Guy E. Blackwelder; Quitman, Ga., T. A. Bryson Auto Company; Montreal, Can., Wilson Automobile Company.

Continental, Los Angeles, Cal.—The Continental Caoutchouc Company, of New York City, has established an agency on the Pacific Coast with Seeley, Van Zandt & Crackel, 938 South Main street, Los Angeles. This firm will distribute Continental tires, demountable rims, and accessories in lower California.

National, New York City.—The Poertner Motor Car Company, 1876 Broadway, has just been appointed distributor for the National line in this vicinity. This firm will handle these cars exclusively and carry a full stock of parts as well.

Pope-Hartford, Philadelphia.—The West-Stillman Company (Robert Maynes, manager), 612 North Broad street, has landed the local agency for the sale of Pope-Hartford cars.

Reo, Philadelphia.—The Reo Motor Company, of Philadelphia, has been organized to take over the representation



Pierce Agency at Newark, N. J.

of that well-known car in the Quaker City, with headquarters at 338 North Broad street. G. L. Derrickson has been appointed manager of the new agency.

Philadelphia Rubber Tire Company will start business on February 10 at 680 North Broad street, under the management of Saul Levy, formerly connected with the G & J tire agency in the Quaker City.

Cadillac, Orlando, Fla.—Nolan & Rixford have opened a Cadillac branch at Orlando, Fla.

PERSONAL TRADE MENTION.

Stewart McDonald, vice-president of the Moon Motor Car Company, of St. Louis, states that prospects for a banner year for the Moon car were never brighter. Orders for cars have come in so rapidly to the Moon factory that Mr. McDonald was unable to attend the Palace Show and incidentally the fourth annual meeting of the Society of Automobile Engineers, to which he was recently elected a member.

E. P. Blake, the Boston agent for the Jackson cars, has resigned from the retail trade in that city to devote his entire time as distributor of Jackson cars in New England. The Boston agency will be in charge of Harry S. Merry, who will move into the new quarters at 24 Tennyson street, this week.

G. L. Wands, former manager of the Boston branch of the Prest-O-Lite Company, has opened an office at 303 Century Building, Denver, Col., where he will act as branch manager of the Safety Device Company and also the Hoosier Mfg. Company.

S. A. Foster has joined the selling force of the Boston branch of Thomas B. Jeffery & Company, makers of the Rambler. Mr. Foster was formerly assistant sales manager of the Corbin Motor Vehicle Corporation, of New Britain, Conn.

Lawrence C. Fuller, formerly of the firm of Thornton & Fuller, who represented the Simplex and other foreign cars in Philadelphia, has been appointed general manager of the Philadelphia Chadwick branch, 254 North Broad street.

George T. Smith.—At a meeting of the board of directors of the Joseph Dixon Crucible Company, Vice-President Smith was elected president to fill the vacancy caused by the death of E. F. C. Young. W. H. Corbin, counsel, was elected vice-president.

R. R. Drake, formerly associated with the Diamond Rubber Company, has assumed charge of adjustments for the Con-

tinental Caoutchouc Company. Mr. Drake will be located at the headquarters, 1788-90 Broadway, New York City.

Frank R. Talbot has resigned as assistant treasurer of the Firestone Tire & Rubber Company, of Akron, Ohio, and will move to Los Angeles, Cal., where he contemplates opening an agency for Firestone tires.

Paul P. Rippien has resigned as general manager of the Autolight and Motor Supply Company, of Philadelphia. Manager Janney, who succeeds him, will take charge at once.

OBITUARY.

Edward F. C. Young, president of the Joseph Dixon Crucible Company, died recently at his home in Jersey City. He had been associated with the company for thirty years and was influential in bringing it up to the present flourishing condition. He will be missed by a host of friends and business associates.

RECENT BUSINESS CHANGES.

Lozier Motor Company, New York City.—The announcement is made that the New York sales office of the Lozier company, having outgrown the present quarters at Fifty-fifth street and Broadway, will on February 1 remove to the Fifty-sixth street corner, occupying the five-story building built for and formerly occupied by the Hol-Tan company.

Banker Bros.' Automobile Company, Pittsburg, has been reorganized. C. M. Miller is president; R. P. McCurdy, former salesman, is now vice-president and general manager, succeeding Arthur Banker; and I. G. Davis is secretary. The company will still continue to handle the Pierce Arrow, Chalmers-Detroit, and Stevens-Duryea cars.

W. H. McIntyre Company announces that by permission of the Indiana Secretary of State it has adopted this name in place of the former one, which was the W. H. Kiblinger Company. The shops at Auburn, Ind., as well as the personnel and policy of this well-known builder of high wheel motor vehicles, remain the same.

K-W Ignition Company, Boston.—J. W. Forbes, the Boston representative of this manufacturer of high-grade ignition apparatus, has removed from 220 Congress street to 70 Long Wharf, where the Boston office of the company will be located also.

Reliance Motor Truck Company is now located in its new factory at Owosso, Mich., where all mail should be addressed. This new plant was designed and constructed especially for the manufacture of motor trucks.

RECENT INCORPORATIONS.

Adams Motor Transfer Company, Boston.—Capital stock, \$100,000. Will do a general automobile business. Incorporator: W. E. Eldridge, of Dorchester, who is president and treasurer.

The C. & O. Automobile Company, Jefferson City, Mo., capital stock \$6,000, and will rent automobiles. Incorporators: C. H. Duffer and E. E. Reuter.

Wonder Motor Car Company, Kansas City, capital \$35,000. Incorporators: E. F. Ettwein, L. A. Ettwein and F. N. Short.

Memphis Taxicab Company, Memphis, Tenn., capital stock \$25,000, by F. Farrell, R. H. Allen and W. S. Watson.

BUSINESS DIFFICULTIES.

E. T. Barton, who conducted a tire repairing establishment in Hartford, Conn., has filed a petition in bankruptcy. By his submitted schedules his liabilities are placed at \$4,159.49 and his assets at \$2,367.20.

TIMKEN GETS DETROIT PLANT.

CANTON, O., Jan. 18.—The importance of Detroit as an automobile manufacturing center is being realized more and more each day by the parts or accessory makers. The latest news from this hustling automobile city is to the effect that another immense plant will be added to the already long list. This latest announcement is to the effect that the Timken Roller Bearing Axle Company, of Canton, the well-known manufacturers of ball bearings and axles, has purchased and will soon occupy with a large force the plant of the Standard Sanitary Mfg. Co., on Clark avenue, the whole of which will be devoted exclusively to the manufacture of front and rear automobile axles. The plant occupies about three acres. This plant, devoted exclusively to the manufacture of automobile axles, will probably be the largest plant of its kind in the world.

The plant in Canton will be retained for the manufacture exclusively of Timken roller bearings, the steadily increasing demand for which has made it necessary to have larger manufacturing facilities.

HOW 'TIS DONE IN NORTHWEST.

MINNEAPOLIS, Minn., Jan. 18.—The Pence Automobile Company believes it can say without fear of being disputed that it is the largest automobile establishment in the United States engaged exclusively in the wholesale and retail automobile business. The building it will soon occupy has a frontage of 75 feet by 160 feet deep, eight stories and a basement.

The first or ground floor will be the offices and showrooms; the second floor will be the garage; the third floor stockrooms; fourth and fifth floor storage; sixth floor paint shop; seventh floor metal, woodworking and top departments; eighth floor machine and repair shop. The building will be constructed of reinforced concrete throughout and will have the most modern appliances and conveniences of every kind. The capital stock has just been increased from \$25,000 to \$250,000.



Pence Automobile Company Building.

THE AUTOMOBILE

GARDEN SHOW SUPPLIED GRATIFYING RESULTS

NOW that the "Ninth Annual National Automobile Show" held in Madison Square Garden is a thing of the past, a résumé of the results it served to accomplish is in order. It goes without saying that it was not alone the largest aggregation of the products of automobile builders and allied manufacturers that the big amphitheater of the Garden has ever housed in its show career, but it also proved to be the most successful event of the kind that has ever been fostered by the Association of Licensed Automobile Manufacturers in every other respect. Take the matter of attendance as a single item, as this is a factor upon which the success of any exhibition is largely dependent. Despite the fact that the entire week was marked by weather conditions that were far from ideal, the number of people who visited the show during the seven days its doors were open was put down as over 116,000 in round numbers—a total that exceeds by a very substantial percentage anything that has been approached in the show history of the Garden in the past.

Nor, as has been the case at previous events of the kind in other years, has this figure been arrived at by estimating the average attendance. Colonel George Pope, chairman of the Show Committee of the A. L. A. M., was in receipt of the figures for every morning, afternoon and evening crowd of each day of the week, and it was not difficult for even the uninitiated to note that the masses which surged up and down the unusually broad aisles and filled every available square foot of space in the balconies and galleries, were far and away greater than any similar event has ever attracted to the interior of the Garden, or any industrial exhibition heretofore contained in its capacious auditorium and galleries.

"Undoubtedly, the weather militated to a certain degree against the attendance," said Colonel Pope, "but it is improbable that any great percentage of those who remained away were either users or prospective purchasers of automobiles. I am certain that every exhibitor will join me in stating that a larger proportion of the week's visitors were people actually interested in the cars displayed than has ever been the case heretofore. No better proof of this could



Society Arrival at the Show.

be cited than the great familiarity displayed, not alone with the principles of automobile construction in general, but with many of its finer points, by the average caller who was sufficiently interested to request information from the attendants at the various exhibits, and the number of persons who did so was so great that it was impossible for the numerous salesmen on hand to properly take care of more than a fraction of those who were really seeking enlightenment to aid them in the selection of a machine. Considered as a business proposition, the automobile shows of former years have been held almost entirely for the benefit of the manufacturer and the dealer, but this year the actual user of the car was the predominant factor." This idea was very generally shared.

Of an importance even greater than that of the attendance, in its bearing upon the successful outcome of an automobile show, is the amount of business done by the

various exhibitors during the week, and in past years it has been customary to swell the figures to a very large extent by adding the totals of many prospective agency contracts that frequently failed to materialize. In this manner the volume of business done was made to appear truly phenomenal. Selling conditions in the automobile field, however, have been brought down to a business basis in the last year or two, where it is no longer necessary to resort to such means to make the sales appear larger than the reality. The actual facts are such that the real figures call for no exaggeration, so that the thousands of dollars worth of cars and accessories that is given as the net result of the week's business may well be regarded as a conservative estimate of what was really

transacted. Exact figures are not obtainable; guesswork is left out. But what must have been a huge total affords a striking illustration of the truly vast proportions that the automobile industry has now assumed, while the manner in which it was divided among the different interests assembled in the Garden serves to give some idea of their relative standing. The chief factor in the make-up of this amount was naturally composed of the sales of complete cars, denoting interest unquestioned.

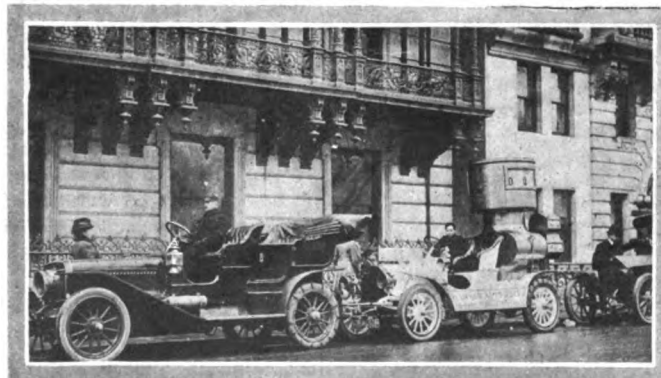

Demonstrating Cars in Waiting Outside the Garden.

Much of the increase in the volume of business done at the Garden during the week of the show, as compared with previous years, was generally attributed to the fact that buying during the Spring of 1908 was necessarily very light, owing to the conditions then prevailing, while many who were in the market for cars in the Summer or later, deferred their purchases until the advent of the show should provide an opportunity of examining offerings of best known makers under one roof.

SOME GOSSIP OF THE SHOW.

"Are You Afraid to Show What's Under It?"—To put a check on the ubiquitous meddler who insists on lifting the hood of every car he gets near, just to show his friends that he knows all about its mechanism, the Winton Company put small locks on the hoods of all cars in the Winton exhibit. The result was to preserve the finish of the bonnet and forward part of the dash from scratches and the bonnets were not half on and half off as was usually the case where they were meddled with, but some of the over-curious ones jumped to conclusions and asked, "Are you afraid to show what's under it?" before noting that one of the features of the Winton exhibit was a polished chassis, showing all the internals of the car. It was in the center of the booth, and was usually lost to sight in the crowd, so in that respect at least the curious ones were probably excusable.

Waldron Remembered by Packard Dealers.—At the annual dinner tendered by the Packard Motor Car Company to its agents at the Knickerbocker on Wednesday night of show week to Sales Manager S. D. Waldron was presented a silver service by the dealers as an expression of the appreciation of his work in upbuilding the retail sales end of the Packard, as well as of his efforts at the factory. The presentation was made by Clarence Godschalk, of Philadelphia. The dinner tendered to the dealers by the Packard Company is an annual fixture of show week. It was followed by four playlets presented by Miss Stella Mayhew and company. These were specially written for the occasion, and included impersonations of the different Packard dealers present. It would be difficult to furnish a better illustration of the harmony with which every member of the Packard organization works with his confreres, whether in or out of the factory, than this annual gathering.

"Nothing New at the E-M-F."—It was the boast of the attendants at the exhibit of the E-M-F cars during the early part of the week that they had absolutely nothing new to show. There were no novelties, no revolutionizers, and no world-beaters on the E-M-F car; in brief, it represented nothing but the very best standards of current engineering practise throughout. Then some genius came along and surprised one of the E-M-F salesmen by telling him he had the newest thing in the show. This is the convertible top for a surrey or two-seated runabout, and is something that top makers have been trying to evolve ever since the new three and four-seaters came into vogue.

Coker F. Clarkson, whom everybody knows as the able publicity department head of the A. L. A. M., should be given special mention for the very efficient way in which the special publicity side of the exhibition at the Garden was pulled off. That Mr. Clarkson furnished a vast amount of clear and explicit mechanical material for the press and general publicity purposes is too well understood to require more than the merest mention. The new "Handbook of Gasoline Automobiles" is one of Mr. Clarkson's most recent efforts, in which will be found an illustration and concise specifications of every automobile turned out by members of the A. L. A. M. This is a work of art embodying the greatest utility from the point of view of the prospective purchasers of automobiles.

"Oh, About 180 Degrees or So."—Paul Lacroix, sales manager of the Renault Freres Selling Branch, was accosted at the show by a friend in search of information regarding a two-cylinder taxicab motor, a description of which recently appeared in *Omnia*. "It would appear from this description," said the

searcher after information to Mr. Lacroix, "as if the crankpins of this two-cylinder motor were set at 180 degrees. Do you know if that is the case?" "Oh, yes," answered Mr. Lacroix, "it is somewhere about there; something like that."

"Foolish Question No. 4396."—One of the features of the *Evening Mail* at present is a running series of cartoons depicting the asinine tendency of the average individual to ask if you are going out when he sees you putting on a hat, overcoat and gloves, or if you are going fishing when he notes that you are burdened with piscatorial paraphernalia and are headed for the creek. If the artist responsible for the sketches could have put in a few hours at the exhibit of the Royal Tourist he would doubtless have accumulated a fund of automobile foolish queries that would shortly bring his series into columns of six figures. "Oh, they use the steering post for a horn," is one that became common at the Royal booth. "No, that's the internal expanding brake," pointing to the two big bronze hands studded with cork inserts, "and this is the emergency over on this side," indicating the sprag and its teeth on the brake drum. "Never put on your emergency till you have to and then use it good and plenty," was the sage advice gratuitously added. "My, that's just like a miniature reproduction of the old Packard reverse lever." is another that crops up every time a new one sees the small auxiliary lever intended to bring the sprag into operation, while "What are those lumps on the brake shafts?" has become classic. The new ignition bus bar carrying both magneto and battery terminals is responsible for another lot of its own, and so on *ad lib*.

"Human Nature's Tendency."—The universal tendency of human nature to finger things was very cleverly utilized by the Republic Rubber Company at the show. Close to the rail which separated its booth from the passing public, the Republic people put a partly finished Republic tire. From each of the rubber studs projected a little spear of rubber about two inches long, giving to the tire somewhat the appearance of a cactus plant. Every man who passed that way seemed to have an almost irresistible inclination to catch hold of these little rubber ends and snap them. That moment gave the salesman an opportunity to explain that this is the result of the peculiar way in which the Republic tire is molded, which makes an inseparable union of the rubber with the canvas carcass. Hundreds of people stopped who otherwise would have passed by and a large number of sales resulted.

"What Car Is That Going On?"—One of the striking features of the Heinze Electric Company's exhibit was a monster four-unit coil as big as a young trunk. It operates spark plugs a foot high with gaps of fully an inch, and when it is going it sounds like nothing so much as the valve action of an old-time four-cylinder engine that had seen much service. "What car is that going on?" was the query that it was responsible for, while as a corollary there came, "Is that the spark that really takes place in the cylinder?" "Yes, they're in parallel, was one of the bright answers to a query regarding the Heinze analogue showing the crankshaft and pistons of a car, to which was attached one of the new Heinze magnetos and a set of plugs, showing how it could be operated merely by turning a small crank slowly. "Just the thing for a four-cylinder motorcycle," was another anent the overgrown Heinze coil.

"Do You Build the Chassis, Too?"—One of the exhibits on the north side elevated platform of the Garden that attracted quite an amount of attention from the uninitiated observer was that of the Springfield Metal Body Company. A great many of the visitors who were not familiar with automobile construction could not exactly fathom the wherefore of the numerous types of separate bodies that were displayed on low stands, and quite a few of them were not averse to making inquiries to satisfy their curiosity. As a result, the question, "Do you make the chassis, too?" became a standard at the Springfield exhibit, and Hinsdale Smith, president of the company, said that he would be tempted to have a placard painted reading, "No, we don't build the chassis; we build automobile bodies," and post it conspicuously, had not the regulations of the show prevented.

CONSPICUOUS FEATURES ON CARS AT THE GARDEN

By THOMAS J. FAY.

Brake-drum on the Propeller Shaft.—In the Pope-Hartford it is to note that the brake-drum on the propeller shaft is a die pressing of steel, and that the driving member of the universal joint is bolted thereto. It is a very neat arrangement

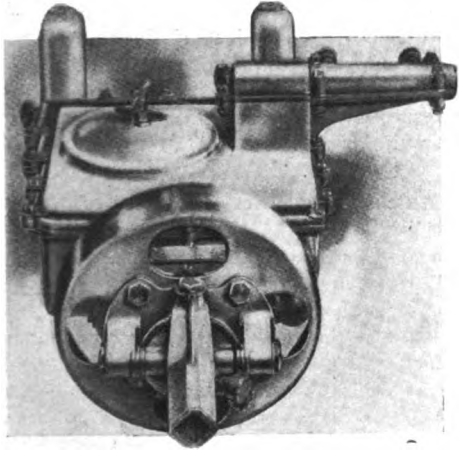

Pope-Hartford Brake Drum on Propeller Shaft, Showing Universal.

that should be very satisfying to the users of cars. The drum is of adequate diameter, and the face of the brake-shoes is adequate, considering the location and the speed of the drum. A glance at the illustration will disclose the fact that the propeller shaft is fitted into a square, and the whole situation is one that augurs for a low cost of maintenance.

Cadillac Oils Universal Joints with a Stream of Oil.—It is a source of regret not to be able to illustrate the manner in which the Cadillac universal joints are lubricated. It is a well understood fact that a universal joint is a common nuisance if it is not oiled, on the ground that dirt will get in if oil is not there to keep it out. In the case of the Cadillac, it is a case of oil, constantly replenished, and there is no chance of dirt to make its way into the joint. Even so, it is a fact that the joints as used in this make of cars are with large bearing surfaces, and the radius at which the pressure is applied is great enough to limit the pressures.

The Royal Radius-Rod Is as a Lattice Girder.—An illustration of the radius-rod on the Royal type of chassis is well worth the attention of the spectators who want to become familiar with the question of the design of automobiles. In this case the radius-rod is as a lattice girder, and, as is well understood, this is a very good way to get all there is in a given weight of steel for a given amount of work to be done. The girder is in the plane of strains in such a way as to work the metal to the greatest advantage, and the extreme fiber strain is held low enough to assure safety.

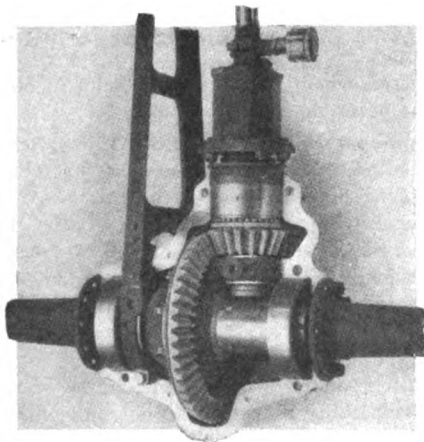

Royal Tourist Rear Axle, Showing Radius Rod.

Planetary Gear of the Hewitt Trucks.—As will be remembered, the Hewitt trucks are very large indeed, intended as they are for the roughest service, and to take all the merchandise that the platforms will hold, piled up as high as the nerve of the truckman will indicate. The planetary gears used are with a view to safety, under severe conditions, and the Hewitt Company indicated how well the planetary gear system answered the purpose by showing a set of gears which had done service for a long time without taking the tool marks out of the gears. The gears are of alloy steel, and the construction is such as to avoid

all the ills of keys, and the little details which, in many cases, made planetary gears a source of annoyance. Edward R. Hewitt simply demonstrated that planetary gears can be made to serve the purpose in the hands of unskilled labor, with small chance of damaging either the gears or the power plant.

1909 Mud-guard Construction Is Satisfying.—The idea of completely protecting the chassis from the mud which is bound to splash up and fly off the road wheels is so good that none of the cars of the year have neglected to do something along the same lines. The illustration here given is of the Knox, and while each company had its own way about the details, yet even so it is well to call attention to the plan, and in the Knox the protection afforded is adequate for the purpose.

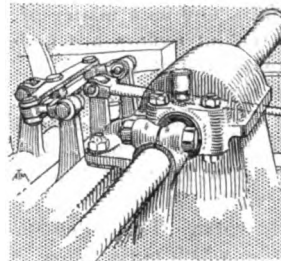

Foot Brake Equalizing Device on Simplex.

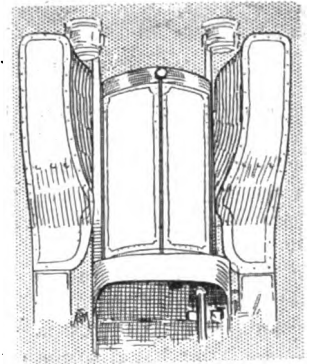

Mud Guard Construction Shown on Knox.

Brake Equalizers on the Simplex.—As is well understood, it is quite out of the question to get any good out of a set of brakes on the rear wheels unless the set of brakes act through an equalizer in such a way as to assure that the pull will come on the brakes on both the rear wheels at the same time, and in such a way as to be equally effective in point of pressure on both wheels. In the Simplex this matter is taken care of in a very good way, and the space required for the device is but little. The idea is adequately illustrated, and the device has been in use so long, and worked so well, that it is now regarded as a standard idea in automobile work.

Supplementary Valve on Franklin Motor.—This is not new, nor is it so well understood as not to be a fair subject for further discussion. The illustration given shows the manner in which the Franklin air-cooled motor is provided with a supplementary exhaust valve at the bottom of the stroke to help scavenge the motor and rid the cylinders of the hot gases at the earliest instant after the work of a useful nature is wrung out as completely as possible from the expanding products of combustion. That the Franklin air-cooled motor has been a uniform success from the start, is one of the certainties of the automobile situation. That it is in a large measure due to Franklin thoroughness must be the case, in view of the fact that the air-cooled situation has not been a bed of roses. As will be observed, the supple-

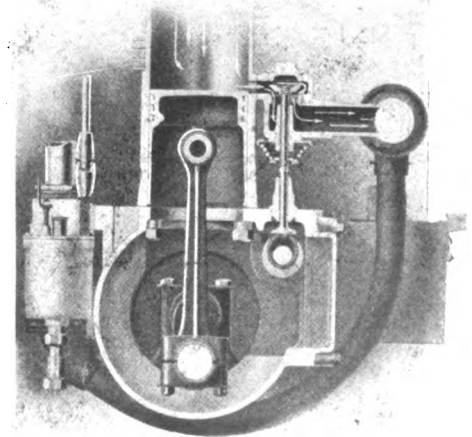

Franklin Auxiliary Exhaust

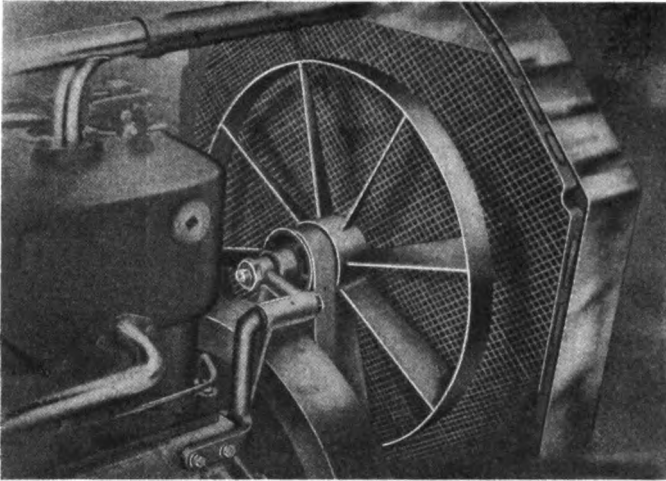

Automatic Fan Belt Adjuster on Stevens-Duryea.

mentary valve is mechanically operated, and as a matter of fact it is clearly a case in which the Franklin motors are provided with an exhaust valve at the bottom as well as at the top. The gases only have to travel half the usual distance, and the exhaust is cleared out of the cylinder in the shortest possible time. It is in this way that the cylinders are kept cool, since if the hot gases are not in the cylinder so long, the heat will be less likely to cling to the cylinder walls. It is, in fact, just a plain case of good reasoning, and it works. The added complication is far less than the complication which must follow if the air-cooled motor should fail to work and water-cooling should have to be resorted to.

Details of Thomas Six-cylinder Motors.—A look at the illustration will disclose the fact that the fan is on the periphery of the flywheel, which is an idea with a lot of good meat in its makeup. While the illustration is available, it will be at a profit to look at the universal joint and see how it is incorporated; it lies just back of the flywheel. This same illustration shows the foot-pedals and the swivel joints which attach the "pads" to the pedals. These are all refinements characteristic of the Thomas, and in conclusion it is the purpose to call attention to the wide flange on the chassis frame, just back of the flywheel, at the bend. The laterals are also of good dimensions, and on the whole it is evident that the Thomas is a car of some nice details.

Adjustable Fan on the Stevens-Duryea.—There is a great difference as between a fan belt which has to be taken up by the process of cutting some of the belt out, and the manner in which the plan is worked out on a Stevens-Duryea, as it was seen at the Garden. The illustration here given shows the manner in which the belt is adjusted, and as an incident it may be well to

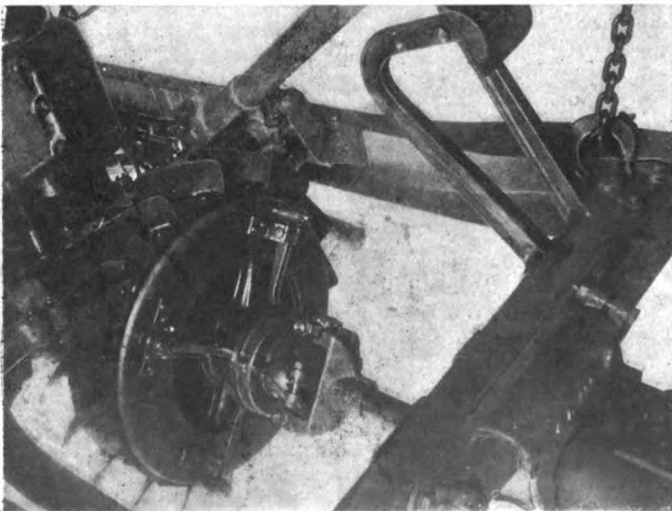

Fan Outside of Flywheel on Thomas Cars.

call attention to the use of a wide belt on the fan. The fan itself is different from fans in general in that it is of extra diameter and the blades are narrow. It is claimed that this fan will handle more air than the fans of the conventional design; air is what is wanted in this situation.

Chassis Frame of Selden Automobiles.—It is interesting to note that in the chassis frames of the Selden cars the frame runs out towards the front, maintaining the depth to an unusual degree and without much drop. The result is that the frame is in shape to withstand a good deal of abuse, even to the extent of end impact, due to a collision. The general appearance is good, and it is assured that there is much of utility in the idea. In other respects the frame is quite up to a fitting standard, and it speaks well for the cleverness of the designing staff of the company.

Peerless Live Rear Axle Construction Impresses.—The illustration of a Peerless live rear axle will adequately disclose the principles of design and construction which have stood the company in good stead. As will be observed, the "strut" is of such good dimensions as to assure long service. This is of the greatest importance, in view of the fact that there are examples of live rear axles in which a "strut" of small diameter is placed to do work, the nature of which is so arduous as to defeat the aims of the designers. The bevel gearset in the Peerless is so nicely made as to last quite as long as the car, and this is a matter of the greatest importance. The accessibility of the parts

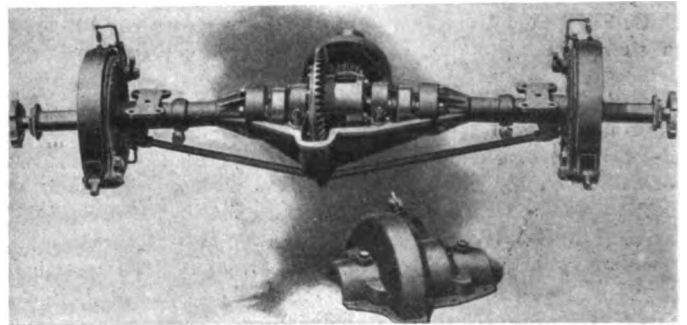

Construction Details of Peerless Rear Axle.

is shown in the illustration, and in other ways the construction is desirable in the extreme.

Separate Provision for Oiling Bearings in Transmissions.—The exterior of a Peerless transmission gearset is shown to bring out the point to be made. As will be understood, it is almost impossible to keep the grease which is placed in the gearbox from seeping into the ball or roller bearings. This grease is laden with the chippings from the gears, and it is anything but a lubricant. In the case of the Peerless this question is taken care of in a way which must attract the notice of the autoist of experience. Each bearing is fed from an oil pipe, led to it direct, and from the prime source of lubricating oil. The result is that the bearings are not only oiled, but they are kept free from the grease in which the chips from the gears will be found. The reason for this lies in the fact that the oil is always entering the gearbox, and as it enters it drives the grease before it in such a way as to keep the bearings washed. Incidentally, it is fair to assume that the gears will be kept profusely lubricated by the same oil, and on the whole it should follow that the transmission will be free from undue depreciation.

Low-Tension Ignition System on Locomobile.—In the case of the Locomobile the company makes the magneto, and the type is of the low-tension genera. The system was devised in 1905, and it is now in a high state of perfection, although it is true that it has been a good success from the start. The illustrations afforded with this discussion will give a good idea of the manner in which the details are worked out, and that the low-tension system is of excellent value, if it is free from mechanical defects, is a self-evident fact. The make-and-break is very simple, as is shown, and the "iridium" contacts used

last for a long time. Because of the nice way in which the mechanical details are worked out, the system is free from the trouble of frequent timing, which was the main question in former times in connection with some of the low-tension systems.

Distance Rods on Shaft-drive Locomobile.—As a rule it is the custom to see shaft-drive cars with radius rods which extend up to the axis of the whole motion as it rotates around the universal joint at the upper end of the propeller shaft. In the new Locomobile distance rods are used just as in side chain drives. The idea makes for great flexibility in the Locomobile, and the car is so thoroughly worked out along lines taking into

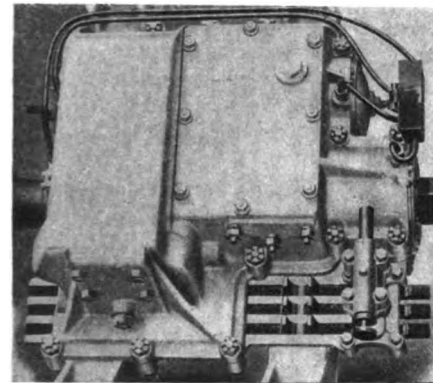

Peerless Separate Oiling System for Gear Box Bearings.

account the question of flexibility that it is bound to serve as a school of design. A. L. Riker, chief engineer of the company, showed that he could do something by way of originality when he delivered the automobile that came home first in the Vanderbilt race.

Rear Axle on Stearns New 15-30 Model.—It has

been quite some time since the exhibitions of automobiles disclosed anything quite so novel as the new Stearns live rear axle, an illustration of which is here given. In this case, the differential housing is provided with bolting pads which fit on suitable faces on the bow of the axle. The axle itself is of tubular section, from the extremities to a point inside of the spring perches, and as the axle recedes from the perches it is joined by an I-section elliptic formation, the two branches of which are in the same vertical plane. In this fashion the differential and the bevel drive are supported by the axle so formed, without any tendency to put strains on the housing, beyond the torsions due to the torque of the propeller shaft, and the resistance offered by the live rear axle members. The axle is of great strength, and all the shock is taken by the kinetic material of which the axle is made, instead of having to transmit through the castings of the housing. The construction is light, the appearance is a little strange, yet it does look healthy, and the patrons of the industry take kindly to the idea on the ground that what looks good is good. The springs on which the chassis is suspended take the torsion of the axle, and they, in turn, are 2½ inches wide, of alloy steel, hence adequate for

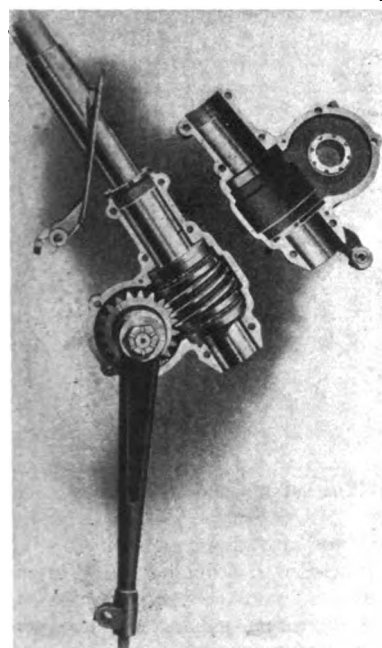

Ball Bearing Worm and Gear Peerless Steering Device.

the purpose of springs and maintaining axle position.

Oxy-Acetylene Apparatus for Cutting Steel.—In crankshaft work, if the crankshafts are not die-forged, it becomes a serious matter to be able to "slab" the steel and thereafter ex-

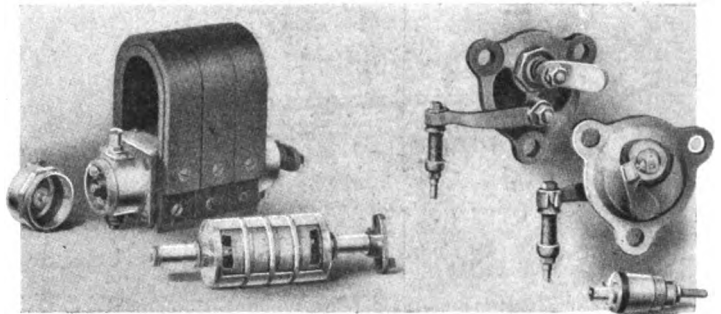

Locomobile Low-Tension Magneto with Igniters.

tract the shape of the crankshaft from the slab. The Davis-Bournonville Company had at the show all the equipment necessary for the purpose, and, too, the question of "autogenous welding" was illustrated sufficiently for the purpose of enabling the average autoist to reach the conclusion that he can have his repairs done by the process in a very efficient manner. This is one of the present year's distinct advances, and it is of such great importance as to merit special mention in connection with the discussion of the advances in automobiles. Certainly it is an advance in automobiles to be able to make repairs in some cases without even taking the parts to be welded out of the nest in which they belong.

Elmore Two-cycle Motor in Modern Chassis.—The motor was illustrated during the show, and favorable comment was

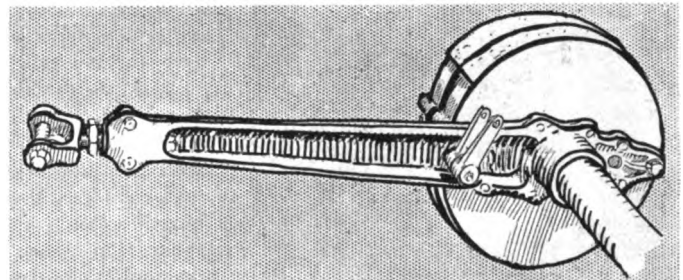

Locomobile Radius Rod Carrying Brake Mechanism.

made on the good performance of the power plant. While this is a question of the utmost importance, it is a fact, nevertheless, that the plant should be protected, and a glance at the illustration will show that the Elmore designers are alive to the needs. In this case the apron extends back of the gearbox, and the levers, as well as the linkages, are all protected from mud. The equalizer for the brakes is in sight in the illustration, and that the plan is of more than ordinary merit is assured. As will be observed, the power plant rests on a sub-frame, and a straight-line drive is one of the Elmore features. The polished chassis of the Elmore at the Garden was one of the sights of the show.

Influence of Tires on the Cost of Trucking.—The "bis-cuit" tires on the Hewitt trucks made more of a commotion in

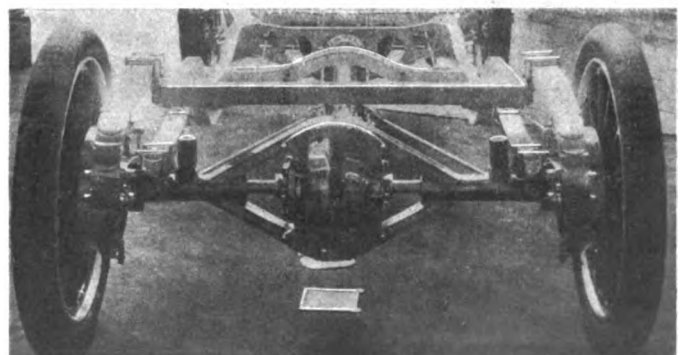

Stearns 15-30 New Rear Axle Construction.

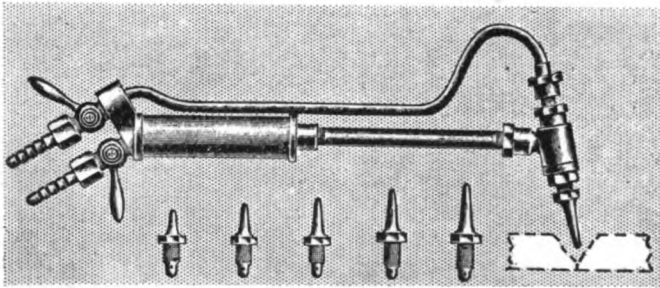

Davis-Bourneville Autogenous Welding Equipment.

some ways than any other one idea of prominence at the show. In the first place, the trucks are large, and again the wheels do not look quite so large as they would were the tires of the usual solid construction. These "biscuit" or "block" tires are best understood by examining them, and the next best plan will be to look at the illustrations as here given. The blocks are symmetrically disposed around the rim, and are held in place by plates of the desired shape, which allow the projecting blocks to stand out radially, thus enabling the blocks to do the work while the plates hold them in place. The tire question has been a serious matter in trucking service, and it is assured that the block idea is a vast improvement to the service.

Figures, taken from data gathered during five years' operation of a two-ton Hewitt truck, show that the tires are not the one big item in the maintenance by any means. The total cost per year was found to be \$2,890, with such items as \$500 for depreciation, \$900 for labor, and others which together with the \$400 for tires completed the annual cost account. This shows that only 13.84 per cent. of the expense was borne by the tires.

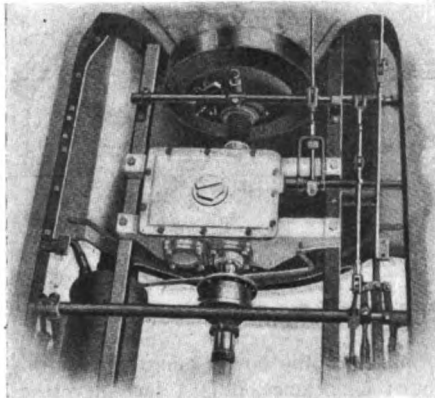

The Elmore Clutch and Gear Box.

it was the custom to design automobiles with never a thought of the accessories, and the means for their proper application. This year, it is not uncommon to locate all the means for the ready application of the accessories, even in the cars that do not include such accessories at the initial selling price. Take, for

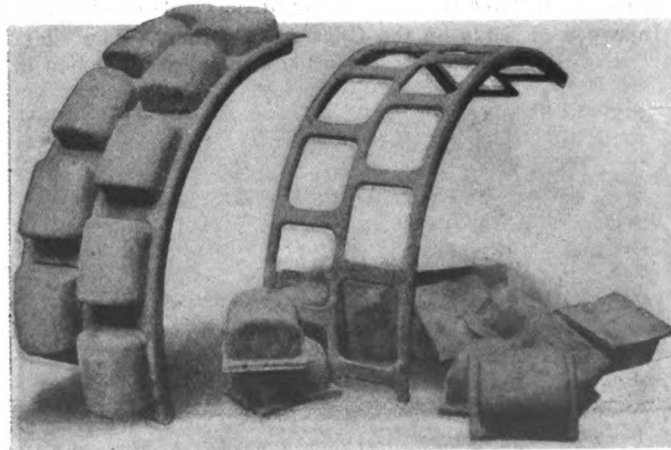

Rim and Treads of Consolidated "Biscuit" Tires.

illustration, Gabriel horns: they work from the exhaust, taking into account the muffler, and in many cases the designers of the automobiles have arranged for the connections of the horns. This is a good idea, even though the cars may be put out without the horns. With all the provisions, it will then be possible for the buyers of the cars to do as they see fit later on, and the cost of the option is as nothing.

Perfection Springs.—The Perfection Spring Company showed a line of chassis springs in all the usual forms in which the question of the material is given the greatest possible attention. In the better class of the springs turned out by this company, it is Krupp steel that is used, the properties for which, for the purpose, are vouched for by the large number of the better class of automobiles in which they do service. This Krupp steel is a high silicon product, and as a rule the spring makers who do not understand how to handle such fine materials fail to deliver the good results which follow the use of Perfection springs. At

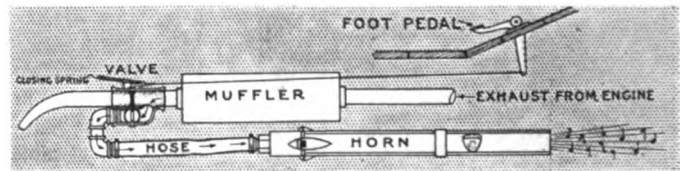

Plan of Connections of Gabriel Exhaust Horns.

the company's booth was to be seen some of the modern springs as used on the noteworthy cars at the Garden, such as the Stearns line of cars. These springs are 2 1-2 inches wide, of very artistic shape, and the easy riding qualities of the Stearns car speak well for the design and quality of the springs used. In some cases the springs, as shown, indicated the suppleness, which is essential to good service, without the excess "bounce," which generally does follow the adaption of what is best described as a "sloppy" action. In a word, it is a case of limited suppleness, and a gradual snubbing of the body motion.

Winton Shock Absorbers Are Self-Sustaining.—Among other Winton features is the shock absorber of the company's make. The illustration of this absorber will show that it is a fixed brake-drum secured to the chassis frame (one on each side of the car, over the rear axle), on which drum will be found a brake band and a lever system to take advantage of the friction of the band on the drum. The band is fitted with a take-up, actuated by a spring in such a way as to compensate for wear. The scheme is neat in design, yet even so the fact remains that the adjustment is of a permanent character, so much to be desired in shock-absorbers. Incidentally, it is worthy of

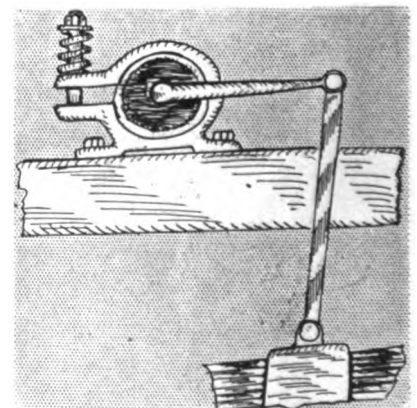

The Winton Shock Absorber.

of note that the Winton cars are also fitted out with "self-starters," and a tire inflating device. In scanning the Winton exhibition at the Garden, it was to note the high degree of finish and the careful proportioning of the exhaust and mixture manifolds, as well as the water piping system, and since it is generally well understood that the efficiency of an automobile motor is much affected by the dimensions and design of the manifolds and the piping, it is equally easy to understand why the Winton "Six" is a powerful as well as a noiseless performer. It is not difficult to make motors perform quite noiselessly, but it is generally appreciated that the noiselessness is at the expense of power.

EASE AND COMFORT BIG MOTORCYCLE FEATURES

THE great, in fact, one might almost say the abnormal, interest manifested in motorcycles in the past year culminated very properly in the excellent exhibit at the Garden show. This was one of the best and probably the most complete exhibitions of this class of vehicles ever seen. Such being the case, it is an easy matter to notice the salient points, or perhaps it would be better to say the general trend. This seems to have taken the way of ease and comfort.

Perhaps these were an outgrowth of the increased attention given to this form of locomotion; possibly the latter was but the effect of the former. In any case, the proof of the statement is a simple matter of mentioning details, regardless of which was the cause and which the effect.

Prominent among the improvements which make for increased ease and comfort is the new loop frame. This differs radically from the old diamond frame, which was an outgrowth of bicycle construction. It adds strength and great rigidity without adding to the weight, while the easy curve of the lower tube forms a strong natural cradle for the motor. The old diamond frame put the rider in one set position, rather high and far forward, while this newer creation allows of the seat being carried farther back and lower. The effect of this is to lower the center of gravity, thus increasing the stability and making the machine ride easier.

Then there is the matter of seats. Most of these are altered over the former bicycle seats; in fact, so much so that the indications of the old bicycle type are even difficult to find.

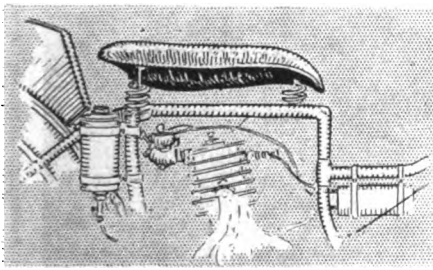

Easy Riding Form Seat.

The width has been greatly increased, and, added to this, the distance between supports or length of the leather has been stretched out. This, coupled with the width, has materially increased the ease of riding. A newer idea, even than this, is the form seat. This is very wide, flat, and comfortable, being correctly formed to the shape of the body. As worked out in the cars it is made from sheet steel, pressed into the correct anatomical shape, upholstered with a large, thick, hair and leather cushion. Over and above the shapes is the springing of the saddles. All of them are spring suspended, the springs being three in number, first the flat spring of the body of the saddle, second the main coil spring of the rear part, and third the small auxiliary or supplementary coil spring at the rear. This combination of well-adapted springs, in combination with the improved shapes, has done more to eliminate saddle soreness or saddle fatigue, as it is variously called, than any other one thing. In so doing the good cause of ease and comfort was advanced apace.

Another part of the construction to which much time and attention has been given in the attempt to make the roads ride like velvet, is the front fork. This works out in various ways, in the spring fork, in the piston arrangement, and in the link mechanism. The first is the most numerous if mere numbers indi-

cate anything, but most of these, as is natural, differ. There is the barrel arrangement with 2 feet or more of spiral springs inside, which in combination with additional rebound springs works very nicely. The other ways of working this out include an arrangement in which the lower section of the fork is connected with the head section by means of a strong hinge joint suspended between springs. An adjustment on these allows of any desired tension, thus adapting the cushioning effect to the weight of the rider and the quality of the road.

The girder frame is an adaptation of this in that a sort of light, flexible king post truss is used, each lateral member of this being in reality a spring. All these, to cut a long story short, eliminate vibrations of the front end of the machine, and consequently make the natural riding strains on the arms less. There never has been a word or phrase coined to express these strains and the resulting fatigue, but that it exists after a very short ride, any motorcycle advocate will prove.

The arms, body, and seat having been properly cared for, there remained only the feet and legs whose comfort had not been looked up.

This has worked out in several forms, one of which, the foot-rest, is very simple. It takes the form of a pair of extra fixed pedals set on a stud forward of the regular pedals about six inches. In use, when a rider's legs tire of the normal position, the feet are lifted from the regular pedals and placed on the extra fixed pedals. Besides the change of position, the latter are so placed as to afford rest to the tired members.

Another and perhaps a better outcropping of the same idea is the fitting of a footboard or running board. This has width and length, so that the whole foot is rested in a manner that is impossible with the narrow pedal accommodating only a portion of the ball of the foot.

Not the least of the comfort-improvements is the use of a transmission. This allows a reducing gear which lowers the speed to a rate that is safe in crowded streets, the usual laborious method of shutting off the engine and pedalling, being dispensed with.

The addition of a luggage carrier over the rear wheel surely makes for increased comfort, the comfort that comes with the knowledge of ever-ready soap, towels, clean linen, and similar items. These are neatly worked out, folded up out of the way when not in use, are of a skeleton construction, weighing very little, so that the advantages of this "extra" far out-balance the disadvantages.

The indications show a considerable expansion of trade in motorcycles for the coming year, which has been foreseen and skilfully promoted by the use of whatever makes for increased comfort, greater ease and improved stability.

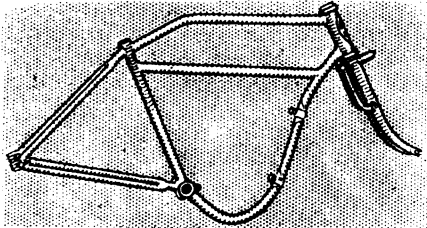

New Loop Frame In Detail.

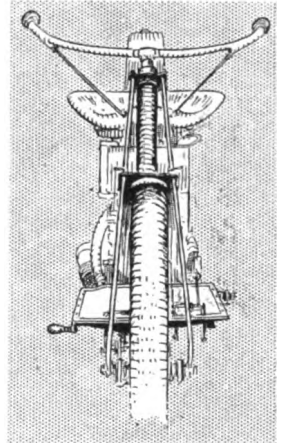

Front View of Foot Rest.

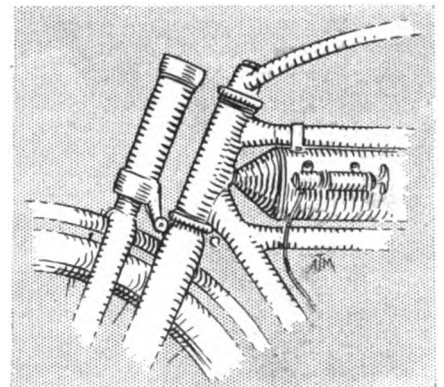

Cushioned Forks Save the Arms.



First Annual Banquet of the Motor and Accessory Manufacturers Successfully Held at Delmonico's, New York City, Wednesday Evening, January 20, 1909.

WITH a membership of 170 concerns and a comfortable balance of \$27,000 in the treasury, the Motor and Accessory Manufacturers are in a most prosperous and promising condition. Its first annual banquet, held on the evening of January 20 at Delmonico's, was a most successful function, well arranged and attended, and carried out to a nicety by the committee in charge. Of course, there will be a similar function next year.

When it is said that Job E. Hedges filled the rôle of toastmaster it will be known that each speaker had a suitable introduction and intermingled were quips of wit and epigrams of scintillating brilliancy of the quality now known as "Jobhedgian."

H. S. White, president of the M. & A. M., contributed a graceful installation of the toastmaster. Ex-Governor N. J. Bachelder, of New Hampshire, Master of the National Grange, made it apparent that the farmers as a whole now recognize that the coming of the automobile is a benefit to all mankind, including he who tills the soil.

Charles Clifton, president of the Association of Licensed Automobile Manufacturers, supplied a businesslike talk that struck home deeply to those present. His remarks elicited applause and comment of general acceptance.

William H. Hotchkiss, president of the American Automobile Association, told of the worth of the national organization of users to the industry as a whole. He referred to the needs of its existence in a national form, and said its place could not be filled by any local club, no matter how large its membership or local influence.

Benjamin Briscoe, chairman of the committee of management of the American Motor Car Manufacturers' Association, took a fall out of the excessive figures current concerning the 1909 output, and found that in reality about 90,000 automobiles would be made for this year's sales. "I make a prediction," said he, "that in ten years horses will be as rare as automobiles were ten years ago." Applause told that his hearers agreed with this belief.

A. G. Batchelder, of the Class Journal Company, spoke on "The Trade Press."

H. E. Raymond, first vice-president, then dwelt upon past, present and future of the Motor and Accessory Manufacturers,

naming D. J. Post as the man really responsible for its formation. Mr. Raymond predicted a much greater future and enlarged upon some of the plans for bringing this about.

Preceding the banquet, the annual meeting of the association took place. There were elected for a term of three years to succeed themselves on the board of directors: L. M. Wainwright, Diamond Chain & Manufacturing Company, Indianapolis; F. E. Castle, Atwood-Castle Company, Detroit, Mich.; H. T. Dunn, Fisk Rubber Company, Chicopee Falls, Mass., and E. S. Fretz, Light Manufacturing & Foundry Company, Pottstown, Pa.

At the Waldorf-Astoria, January 21, the board of directors organized for the year with these selections: President, H. E. Raymond, B. F. Goodrich Company, Akron, O.; first vice-president, H. T. Dunn, Fisk Rubber Company, Chicopee Falls, Mass.; second vice-president, F. E. Castle, Atwood-Castle Company, Detroit, Mich.; third vice-president, C. E. Whitney, the Whitney Manufacturing Company, Hartford, Conn.; treasurer, W. S. Gordon, Standard Welding Company, Cleveland; secretary, P. S. Steenstrup, Hyatt Roller Bearing Company, Newark, N. J.

One of the immediate future plans to add to the value of the Motor and Accessory Manufacturers is the segregating of the makers of the various accessories in sub-committees. For instance, the tire makers will pass upon all matters affecting the making and sell-

ing of tires as far as such concerns its association membership; the lamp makers will similarly consider questions affecting themselves, and the idea will be followed in the classifying of the entire membership. The advantages in so doing are so plainly apparent that the idea met with instant approval from all concerned. The newly elected president, Mr. Raymond, is known as an organizer, and it is anticipated in advance that the plan will be successfully carried out before many weeks have passed. Results are certain to follow in its wake.

The list of those present at the banquet will be found to contain the majority of those actively engaged in accessory making. In addition to the speakers, the guests of the occasion included Alfred Reeves, general manager, A. M. C. M. A.; S. A. Miles,

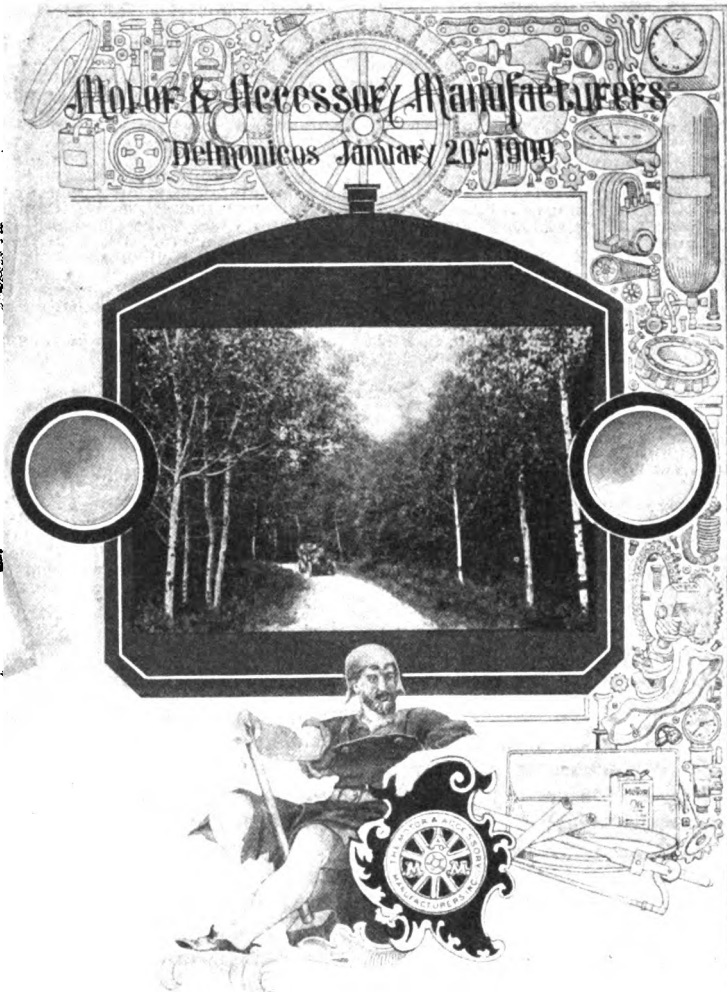

general manager, N. A. A. M.; E. P. Chalfant, general manager, A. L. A. M.; M. L. Downs, secretary Show Committee A. L. A. M.; W. M. Sweet, assistant secretary M. & A. M.

The list of members who attended is as follows:

American Lamp Company—C. M. Hall.
 Atwood-Castle Company—I. H. Atwood, F. E. Castle.
 A-Z Company—R. S. Woodbridge.
 American Ball Bearing Company—F. Phillip Dorn.
 American & British Manufacturing Company—C. L. Gullick, W. I. Starr.
 Brown-Lipe Gear Company—H. W. Chapin, Thomas J. Wetzel.
 K. Franklin Peterson, L. D. Bolton.
 Ajax-Grieb Rubber Company—Wm. C. Grieb, Harry Grieb, Wm. L. Hughson, H. W. Stimpson, H. de Lisser.
 Badger Brass Manufacturing Company—R. H. Welles, Louis J. Keck.
 Bowser Company, S. F. (Inc.)—S. B. Bechtel, W. T. Hatmaker.
 D. A. Corey.
 Baldwin Chain & Manufacturing Company—Wm. H. Gates, H. V. Greenwood.
 Byrne, Kingston & Company—C. T. Byrne.
 Coes Wrench Company—G. V. Allen.
 Chandler Company (Inc.)—L. J. Chandler.
 Continental Rubber Works—T. R. Palmer, Wm. J. Surre, Alex. Jarecki.
 Cramp & Sons Ship & Engine Building Company, Wm.—Courtland D. Cramp.
 Cowles & Company, C.—Louis C. Cowles.
 Continental Caoutchouc Company—J. M. Gilbert, E. E. McMaster.
 Consolidated Rubber Tire Company—Van H. Vartmell, F. E. Holcomb.
 Connecticut Telephone & Electric Company—E. C. Wilcox.
 Columbia Nut & Bolt Company—Fred Atwater.
 Cook's Standard Tool Company—Eugene Cook.
 Detroit Steel Products Company—Jno. G. Rumney.
 Dow Tire Company—A. V. R. Barnwell, Alex. Dow.
 R. E. Dietz Company—Richard Everett.
 Diamond Rubber Company—W. B. Miller, H. J. Woodard, G. J. Bradley, E. P. Weber, E. H. Fitch, C. E. Mathewson, O. J. Woodward, N. E. Oliver.
 Diamond Chain & Manufacturing Company—L. M. Wainwright.
 Federal Rubber Company—O. R. Cook, O. S. Tweedy.
 Fisk Rubber Company—E. H. Broadwell, B. H. Pratt, H. G. Flsk.
 J. B. Kavanaugh, H. T. Dunn, A. N. Mayo, W. P. Kearney, J. C. Cole.
 Firestone Tire & Rubber Company—H. S. Firestone, R. J. Firestone, F. H. Martin, J. V. Mowe, Jas. Couzens.
 G & J Tire Company—B. C. Dowse, H. A. Githens.
 Gabriel Horn Manufacturing Company—C. H. Foster, R. M. Brown.
 Gemmer Manufacturing Company—Geo. Brandenburg, J. I. Brandenburg.
 Goodrich Company, B. F.—H. E. Raymond, F. Y. Stewart, H. C. Miller, J. W. Lyman, H. B. Linwise, W. O. Rutherford, A. J. Wills.
 Globe Machine & Stamping Company—A. F. Schroeder.
 Goodyear Tire & Rubber Company—Chas. Measure, Wm. T. Teagon, O. L. Measure, E. F. Jackson, A. F. Osterloh, G. M. Stadelman.

Gray & Davis—L. Hollander.
 Hartford Rubber Works Company—H. E. Field, J. D. Anderson.
 M. C. Stokes, E. S. Edwards, W. R. Barnes.
 R. E. Hardy Company—R. E. Hardy, C. D. Manley.
 Heinze Electric Company—J. H. Heinze.
 Ham Manufacturing Company, C. T.—Jas. Barnes, W. A. Graham.
 Hodgman Rubber Company—G. B. Hodgman, S. F. Hodgman, A. W. Warren.
 Hartford Suspension Company—Arthur Waterman.
 Hess-Bright Manufacturing Company—Henry Hess.
 Hyatt Roller Bearing Company—C. A. Sloan, P. S. Steenstrup.
 B. G. Koether, H. A. Brown.
 Phineas Jones & Company—Henry P. Jones.
 Jones Speedometer Company—W. Lashar, G. L. Holmes.
 Lebanon Steel Casting Company—W. E. Farrell, W. H. Worrlow.
 Light Manufacturing & Foundry Company—W. I. Grubb, E. R. Cassel, F. S. Brant.
 Leather Tire Goods Company—C. B. Woodworth.
 Manufacturers' Foundry Company—Fred'k C. Fromme, Edward W. Beach, Chas. M. Clark.
 Mosler & Company, A. R.—A. R. Mosler, L. V. Hansen, A. W. Moyer.
 Manhattan Screw & Stamping Works—Louis F. Leland, Frederick M. Stevens.
 Morgan & Wright—C. J. Butler, A. I. Philp, J. C. Weston.
 Molsinger Device Manufacturing Company—P. J. Dasey, H. N. Molsinger.
 McCord & Company—P. L. Parter, J. W. Cain.
 National Battery Company—E. B. Cottrell.
 National Carbon Company—Nelson C. Cotabish.
 N. Y. & N. J. Lubricant Company—T. A. Matthews, F. J. Barnes.
 W. F. Kimball, J. H. Bennis.
 New Process Raw Hide Company—T. G. Meachem.
 Randall-Falchney Company—W. A. Randall, Frank Harden.
 Rands Manufacturing Company—W. C. Rands.
 Republic Rubber Company—H. W. Pratt, F. Hill, J. H. Kelly.
 Rose Manufacturing Company—H. C. Rosenbluth.
 Standard Roller Bearing Company—P. M. Germane, T. J. Heller.
 Shelby Steel Tube Company—H. S. White, J. G. Bateman, H. A. Flagg, C. Wharton, Jr., J. J. Dunn, H. O. Ramsey, F. Lyman, J. E. Millen, E. F. Hollinger.
 A. O. Smith Company—A. O. Smith.
 Sprague Umbrella Company—Col. Sprague.
 Standard Welding Company—W. S. Gorton, W. H. Pirrong, L. D. Rockwell.
 Sallabury Wheel Manufacturing Company—S. H. Penfield.
 Strleby & Foote—C. W. Baker, W. C. Nicoll, K. L. Ryman.
 Schwarz Wheel Company—L. S. Bowers.
 Spltdorf, C. F.—P. J. W. Kelley, G. H. Murphy.
 Syracuse Aluminum & Bronze Company—C. L. Ackerson.
 Swinehart Clincher Tire & Rubber Company—B. C. Swinehart.
 Timken Roller Bearing Axle Company—W. R. Timken, E. W. Lewis.
 Veeder Manufacturing Company—D. J. Post, Geo. Collister, W. F. Sagle.
 Vacuum Oil Company—F. B. Thurber.
 Warner Gear Company—T. W. Warner, R. P. Johnson.
 Westchester Appliance Company—Jas. M. Fischer.
 Whitney Manufacturing Company—C. E. Whitney, W. W. Totman, W. Hill (of London, England).
 Wheeler, F. H.—F. H. Wheeler, E. W. Spencer.

S. D. WALDON ELECTED PRESIDENT N. A. A. M.

At the annual meeting of the National Association of Automobile Manufacturers, which was held at the New York headquarters, 7 East Forty-second street, January 20, the election, which was practically the only thing of moment on the program, resulted in the choice of the following officers for the present year:

President, S. D. Waldon, Packard; first vice-president, William E. Metzger, E-M-F; second vice-president, L. H. Kittredge, Peerless; third vice-president, C. C. Hildebrand, Stevens-Duryea; secretary, Benjamin Briscoe, Maxwell, and treasurer, William R. Innis, Studebaker.

Thomas Henderson, Winton, the retiring president, was again chosen as one of the members of the executive committee, the result of the election otherwise being to move every one of the officers for the past year up one peg. The retiring members of the directorate were re-elected, so that this body remains the same as before.

It is made up of S. T. Davis, Jr.,

Locomobile; Windsor T. White, White; Charles Clifton, Pierce; Thomas Henderson, Winton; W. E. Metzger, E-M-F; S. D. Waldon, Packard; W. R. Innis, Studebaker; C. C. Hildebrand, Stevens-Duryea; H. O. Smith, Premier; Albert L. Pope, Pope-Hartford; Benjamin Briscoe, Maxwell; L. H. Kittredge, Peerless; R. D. Chapin, Chalmers-Detroit; W. M. Lewis, Mitchell, and C. G. Stoddard, Stoddard-Dayton.



S. D. Waldon.

THE SUCCESSFUL A. M. C. M. A. SHOW.

In view of the enormous attendance and the great number of exhibitors at the Ninth Annual International Automobile Show in the Grand Central Palace during the first week of the year, it did not come as a surprise to those who paid for space there to learn that the Committee of Management of the A. M. C. M. A. had decided to make a rebate of 67 per cent. to all exhibitors—a figure that has never been approached at any previous event of the kind. This was the first year in which the show has been held under the auspices of the American Motor Car Manufacturers' Association. The show committee made its report at a meeting held at the association headquarters, 29 West Forty-second street, New York, January 20. The Importers' Automobile Salon and the Motor and Accessory Manufacturers, Inc., are interested in the division of the profits with the A. M. C. M. A.

To the show committee, consisting of H. O. Smith, chairman, S. H. Mora, R. M. Owen, Benjamin Briscoe, E. R. Hollander, D. J. Post and Alfred Reeves, general manager, was extended a unanimous vote of thanks for their very able management.

A standard form of warranty that will be fair to the buyer and to the manufacturer, the matter of good roads, as well as other routine business, were acted upon. The annual meeting of the association will be held at Chicago, Tuesday, February 9.

In attendance at the meeting were Benjamin Briscoe, chairman, Maxwell-Briscoe Motor Company; James Couzens, Ford Motor Company; C. G. Stoddard, Dayton Motor Car Company; Charles Lewis, Jackson Automobile Company; H. O. Smith, Premier Motor Mfg. Co.; R. E. Olds, Reo Motor Car Company; Walter Marmon, Nordyke & Marmon Company; S. H. Mora, Mora Motor Car Company; W. H. VanDerVoort, Moline Automobile Company; Alfred Reeves, general manager.

CHICAGO'S BIG SHOW WILL BE AN EYE-OPENER

CHICAGO, Jan. 27.—Preparations for the N. A. A. M. show, which will open here a week from Saturday, are being rushed, and are in such shape that the decorators will be at work in the two big buildings, the Coliseum and the First Regiment Armory, by next Monday. This will be the earliest the show people ever have been given the keys to the buildings, and will enable the decorators to finish their work in plenty of time for the exhibitors to get in and have everything in readiness for the opening of the show. This time the slow ones will not be able to blame the decorators.

Anticipating securing the buildings early, Manager Miles and Assistant Fest have pushed along the work of making the decorations, and as a result they now have the papier-maché and stucco embellishments ready. They are stored in warehouses, and there will be no delay in installing them. Those who have had a peep at the decorations predict that the Chicago show will be more beautiful than ever. Collaborating, Manager Miles and Artist Thiede have devised a color scheme in which copper, bronze and old gold will play an important part. Old Mercury will again be "on the job," but he will be dignified this time by being in the center of stained-glass windows in variegated colors instead of staring down, a mass of stucco, from a red or green board as he has done for several years past. Green silk and golden trimmings also will be used.

In the way of signs, the show visitor can locate the different

exhibitors easily because the signs themselves will be located on the top of the sections. They will consist of white and gold raised letters on a red silk background, and immediately above will be placed white flower boxes filled to a height of two feet with real ferns and flowers.

Papier-maché has been largely used in the decorative work, although stucco has not been entirely discarded. Manager Miles tried papier-maché for the first time in his last show and he found it preferable because of its comparatively light weight, so he has retained it. As an argument for its use, it is pointed out that two men can handle a piece of papier-maché decoration where it takes ten men to move plaster. This, therefore, will greatly facilitate the installation of the decorations. Two hundred girls have been engaged making these, and in addition fifty painters and half a dozen sculptors have been working under the orders of Assistant Manager Fest.

The Chicago show will have in the neighborhood of 255 exhibitors, smaller, perhaps, than at either of the New York shows, but, on the other hand, the spaces at Chicago are claimed to be much larger than the ones in the East. It wasn't because Miles could not get more exhibitors that the list is confined to 255 names—he simply could not place any more. Even now he has a waiting list a yard long, and it is hinted that one of the reasons he went to New York was to dodge those who came here simply insisting they must be given space.

QUAKERTOWN IS HAVING ITS ANNUAL AUTO SHOW

PHILADELPHIA, Jan. 27.—In a building one-half the required size—its usual handicap—the Philadelphia Automobile Trade Association to-night opened its eighth annual exhibition. Small as is the Second Regiment Armory, it is yet 50 per cent. larger than the most available downtown building, the First Regiment Armory, the scene of most of the association's former shows. Within a few days of the initial announcement, some months ago, the latest available inch of space was bespoken.

While the members of the association—there are 45 of them—were naturally given first choice as regards location, the spaces were laid down of a uniform size, and each concern was allowed but one of them. In that way only could even the "carly birds" be accommodated. That the committee has worked to some purpose may be gathered from the fact that by thus limiting the space assignments 50 of the three-score cars represented in Philadelphia found a resting place under the armory roof when the ball dropped to-night. With each annually recurring automobile show there is a howl for a big exhibition building in this "conservative and slow-going" old burg; such a plaint is rising now, from various quarters, and—who knows?—perhaps by this time next year there may be such a building here, and Philadelphia will come to its own as a show center and give the national exhibitions a rub for the honors. Apropos of this, a movement has been started to make such additions to the building in which the show is being held as to double the amount of floor space and provide the city with a much-needed exhibition building before the end of the present year.

At the Philadelphia show the licensed and the unlicensed car lie down together, and the foreigner fraternizes with both. There are no side issues in the way of upstairs, basement or company-room exhibits. Even the accessories and the trade journals are on a level with the big cars. Nobody is compelled to climb up and down but the band. It is one of the most compact and easily getatable shows ever held in this city.

The innovation of a midweek start—necessitated by the fortnight's interval between the New York and Chicago shows—will be watched with interest. The three days intervening be-

tween the close of the Garden exhibition and the beginning of the Quaker show permitted of the bringing here of many of the former's exhibits without the usual rush which marked the Saturday or Monday openings of former years. But with the opening of the Windy City affair some of the exhibits which are scheduled for both will have to be handled very quickly in order to reach Chicago by Saturday night.

The cars on exhibition include the Acme, Chalmers Detroit, Columbia, Crawford, Elmore, E-M-F 30, Ford, Fiat, Franklin, Gaeth, Grout, Isotta, Jackson, Knox, Lancia, Locomobile, Lozier, Marmon, Matheson, Maxwell, Middleby, National, Overland, Packard, Palmer Singer, Peerless, Pennsylvania, Pierce-Arrow, Pullman, Rambler, Regal, Detroit, Royal Tourist, Simplex, Speedwell, Stanley, Stearns, Stevens-Duryea, Stoddard-Dayton, Studebaker, Thomas, White Steamer, Winton—just an even half-hundred, included the Carroll carbonic acid gas car, which is on exhibition for the first time.

The latter is expected to arouse a great deal of interest, for it will be a Philadelphia invention, built here by local capital, the Carroll Power Company having secured a factory here and started work. Among the many claims for it, is the ability to run from here to Chicago on a single charge of gasoline costing at retail not over 50 cents.

The apparent dearth of accessories is explained by the inability of the show committee to scare up space. About a score of odd corners here and there were awarded the applicants in the order in which the requests were mailed. A full score of disappointed applicants, including several automobile dealers, were left out in the cold. Partly as a result of this, and partly from choice, several of the "Gasoline Row" concerns are running individual shows, with all the usual musical, decorative and gastronomic side features. Among these are Oldsmobile, Reo, Buick and a few others. Besides these, most of the "Row" concerns, unable with the limited space awarded them by the Armory show management to make a comprehensive exhibit of their cars, are having supplementary shows at their several agencies and branch houses.

DEVELOPMENT OF FOREIGN AND DOMESTIC CARS

By E. T. BIRDSALL, M. E., A. L. A. M.

IN the early days of the automobile industry in the United States little or nothing was known of the properties required in the materials of construction. For example: Aluminum was a novelty, cast iron and bronze were used for the gear wheels of the speed-change mechanism; roller bearings having unhardened rolls operated in soft axle tubes as a bearing for soft-steel solid axles; bronze and malleable iron were used for connecting rods; the hardening and grinding of crankshafts and many other parts were unknown; brakes were lined with wood blocks; any yellow metal for bearings was "bronze," regardless of its composition; hardening meant "case-hardening" sometimes .001 inch deep, sometimes more, but always an indefinite amount. Heat treatment, alloy steels and hardening as we know them to-day were practically unknown in the early days of auto making. Structural steel; bar, plate and rod stock; woods of various kinds; cast iron; brass and bronze of the ordinary "merchant" shapes and qualities were alone available for the automobile builder.

Where the Foreign Maker Had Early Advantages.

In Europe, on the other hand, the requirements of foreign gunmakers, engine builders and others had created a demand for special steels and bronzes. From the beginning of the automobile industry in France the machines were entered in races and other competitions that developed in a few hours weaknesses and shortcomings of design in materials that would have taken months of ordinary use.

Finding that increasing the size alone of a weak part to make it strong enough was not always the remedy, or even always feasible, the manufacturers naturally turned to the steel-makers for better materials.

Right here another difference between the United States and Europe should be noted. In the United States the steel-makers wanted "tonnage." That is, they would not get out a special grade of metal and set up the rolls to shape it unless an order for many thousands of tons was placed. Whereas, in Europe the steel mills would take an order for a few hundred pounds of a steel of special composition.

The net result was that the French automobile builders by races that tested the materials and design of construction, by the facility and possibility of procuring proper materials, by cleverness in design and by keen competition, soon distanced all other nations in the production of cars that were reliable, fast and dependable.

How One American Maker Made a Test.

A concrete example of the above is furnished by the actual experience of one of the early American manufacturers who conceived the idea of building in this country an exact copy of a well-known and successful French car. After the first car was built the testing out proved that the American tubing used in the frame had only about one-half the strength and stiffness of the tubing used in the model. The gears would not stand up under the work and the wearing qualities and general durability of the entire machine were far below the French model. A careful investigation showed that the difference was solely due to the quality of the materials used.

As at that time practically no one here who was available knew the difference between the materials in the model and the copy and there were not procurable in this country materials from a constructive and commercial point of view that would answer the purpose, the manufacture of the car was discontinued.

Conditions in the American engineering talent and material market have in the last three or four years completely changed.

We now know what material to use in each particular place,



E. T. Birdsall.

how to use it, where to get it and why we use it.

It is, moreover, a fact that the reverse of the above-mentioned case has happened. An American manufacturer in 1899 and 1900 produced a number of 8-horsepower cars with single cylinder, vertical in front engine. The owner of one of these cars appeared within the past two months at a New York salesroom and stated that he still used his little 8-horsepower original American car and that the bearings and all of the parts had stood up wonderfully well. This car must have had excellent material and admirable design. As a matter of fact, one of the largest manufacturers in Germany acquired in 1898 exclusive rights to manufacture this same car

of American design and on American specifications for material. All the detailed drawings were converted into the metric system and sent to Europe with a model and some parts. The car, though well known and successful in the United States, was not satisfactory when made by the German maker with European material.

The American industry has grown to such proportions that steel and other material manufacturers seek and cater to the wants of the automobile builder. At the present time there is not, and, in fact, for some time past there has not been the difference between the foreign and the domestic car that formerly existed. If the American engineer is not satisfied with American materials all kinds and grades of foreign materials can now be procured in stock in the American market and at prices commercially practicable.

The only possible reason for the purchase of a foreign car in this country to-day is the same one leads many people to buy English clothes and French hair dyes.

There is an idea very prevalent in some quarters that practically all the cars made in France, England, Italy, Germany and Belgium are as good or better than the better grades of cars made in this country, whereas the reverse is really the truth.

Some of the foreign cars that have had a large sale and vogue in this country and been accepted without question as being of the highest grade were classed as second grade at home. Taking the good and the bad together, the average quality is higher in this country to-day than in Europe.

It is true that there are more builders of high-grade, finely finished cars in Europe than in this country. But their combined output is not as great as the combined output of the relatively few similar makers here. On the other hand, there are practically no cars built here as "rotten" as some foreign ones.

AUTOBUS WILL ANSWER IN PITTSBURGH.

PITTSBURGH, Jan. 25.—Angered by the repeated failures to get the Pittsburgh Railways Company to give them any sort of transfer service across the city, the Duquesne Incline Plane Company has contracted with the Automobile Transfer Company for the hauling of passengers from the foot of the plane on the South Side to Fifth and Liberty avenues, the most central point in the city. The contract calls for automobiles to be furnished every four minutes during the rush hours and every eight minutes during the remainder of the day. The service will be established April 1.

The distance from the foot of the Duquesne incline to Fifth and Liberty is something over a mile. The incline is the main source of access for thousands of people on the South Side hill tops. For a long time the Incline Company issued transfers, which were accepted by the Pittsburgh Railways Company. Lately the "trolley trust" has refused to accept these transfers, and the contract with the Automobile Transfer Company is the result. The cars contracted for will carry 22 passengers each.

USE OF ALUMINUM, NICKEL AND VANADIUM STEEL

By ELWOOD HAYNES, A. L. A. M.

A FEW years ago it was considered impossible to build a self-propelled vehicle for the common roads that could be operated continuously in a practical way because of the very high cost of up-keep. A large part of this excessive maintenance cost was due to the breaking or bending of the various parts of the machine. The early builders of automobiles were not only annoyed almost beyond endurance from this cause, but the problem became so serious that for a time the success or failure of the entire business seemed to hinge upon the possibility of obtaining the materials which would stand the extraordinary stresses imposed by this new means of locomotion.

Many entertained the idea at first that excessively tough materials would best answer the purpose and hence employed Swedish iron or very low carbon Bessemer steels. These were found to be absolutely unsuitable in many instances, not because of breakage, but on account of the readiness with which they would bend and take excessive and permanent set, thus throwing the parts out of line and rendering the machine in a short time practically inoperative. Higher carbon Bessemer steels were employed with but little advantage; it is true that they were more elastic, but after a limited amount of use they would deteriorate in strength and finally break in most unexpected places.

Introduction and Use of Nickel Steel.

Alloy steels were almost unknown in mechanical construction in the nineties, though nickel-steel had been tested to some extent chiefly by firms supplying armor-plate steel to the Government. However, it was of doubtful utility until introduced into the automobile. The early users of this steel were highly pleased with the extraordinary improvement which it introduced into the machines. First, it proved a great boon in the construction of live rear axles, which when made of ordinary steel had been bending or breaking to an alarming degree. Next, it was tried in crankshafts, which had also given much trouble. Later, it was used for the construction of sliding gear wheels employed in the transmission of the car. Its introduction was not always attended with satisfactory results, but generally speaking, the improvement which it made was most marked.

Unfortunately a number of builders regarded nickel steel simply as an alloy of iron and nickel containing a certain percent. of the latter metal. They were not particular about the other constituents of the alloy or how the steel was made. This was the cause of a great deal of trouble in the early use of nickel steel. Firms that had never had any experience with alloy steels immediately began making nickel steel of inferior quality and placing it upon the market. Much of this steel was too high in carbon for the purpose intended, other samples contained considerable quantities of phosphorus and sulphur, thus rendering them unfit for use, while still others were carelessly made up and little if any superior to the ordinary Bessemer product. Gradually, however, it was learned that certain precautions were necessary to make a good nickel steel and that the steel must be of such a composition as to answer the requirements necessary in a particular part of the machine.

Marked Effect of Introduction of Chromium.

A little later chromium was introduced into the nickel steel and its effect was found to be very marked: but while it greatly improved the strength of the nickel steel, it was found to be very much harder to work, and since it is a triple alloy of iron, chromium and nickel, besides containing various percentages of carbon, its manufacture and manipulation required much greater care than the making of carbon steel or nickel steel. Moreover, the carbon content must be very carefully controlled or the



Elwood Haynes.

steel will be greatly modified in its properties and may be rendered utterly unsuitable for the purpose intended. Owing the great hardness of this steel in its natural or annealed condition, special tools were required for forming and machining it, and even these did not work it rapidly.

Fortunately at about this time a new alloy tool steel had been compounded which greatly aided in the working of the nickel-chrome steel. This new tool steel is, generally speaking, an alloy of iron, tungsten and chromium, containing but a small per cent. of carbon. It possesses the extraordinary property of becoming exceedingly hard when heated to whiteness and dipped in oil. The hardness thus imparted to the steel is not readily reduced by heating, and for this reason the tools made of this substance will hold a cutting edge even though the iron or steel shavings are heated to redness in the process of turning. It is questionable whether nickel-chrome steel could have been successfully introduced into the automobile without the use of this special tool-steel alloy.

Much difficulty was experienced with the nickel-chrome steel, aside from the difficulty of working it. It is very sensitive to slight differences in temperature employed in tempering it, and to make sure of accurate results a pyrometer must be employed for every operation. Owing to this fact and to the further fact that nickel steel lends itself to a variety of uses, there has arisen a difference of opinion in regard to which of these materials is more suitable to employ. Many high-class builders use a limited amount of both in the different parts of their machines.

Vanadium and Its Peculiar Effects on Steel.

Closely following the nickel-chrome steel came the introduction of vanadium steel, or more properly speaking, vanadium-chrome steel, since vanadium alone is seldom used in automobile steels. The effect of vanadium upon iron and steel has been very carefully studied by Mr. J. Kent-Smith, to whom largely belongs the credit of introducing this valuable material.

Much has been said and written about the peculiar effect of vanadium upon steel. It is generally conceded now that it acts largely as a scavenger and exercises a beneficial influence on almost all of the carbon and alloy steels when introduced in minute quantity during the melting process. Its chief office seems to be that of removing the last traces of oxygen and oxides, as well as minute quantities of nitrogen, which latter element exercises a very bad influence on iron and steel even when present in exceedingly small quantity. It is perfectly certain that vanadium exercises a very beneficial effect upon the finished product, giving it closeness and fineness of grain, splendid elasticity, coupled with extraordinary toughness. Fortunately in addition to these very desirable properties, the steel is sufficiently soft in its annealed state to be turned and machined like ordinary low carbon steel.

Difficulty Experienced in Case-hardening.

One difficulty in the manipulation of this steel is the persistence with which it resists case hardening. While nickel steel takes up carbon readily at a temperature of from 750 to 800 degrees Centigrade, under an exposure of from two to four hours, vanadium steel under the same condition and, in fact, in the same annealing box, shows only a slight penetration by carbon after an exposure of from 10 to 12 hours. This is probably due to its very dense character. It will, however, take up carbon slowly if exposed to a temperature of 900 degrees Centigrade. But a continuous temperature as high as this exercises a rather marked effect upon the furnace and annealing pots—in fact, in case-hardening this steel I have found it advisable to use graphite pots instead of cast-iron ones.

Besides the steels already mentioned, special grades of open-hearth steel may be employed for parts which are not required to resist special stress. And in cases where rigidity rather than high elastic limit is the prime requisite, a good moderately low-carbon steel of high purity will answer as well as an alloy steel. As a matter of fact, the writer has made a large number of tests which indicate that an open-hearth steel of moderate carbon content is stiffer than nickel steel, though not quite so stiff as nickel-chrome steel or vanadium steel.

Suitable Heat Treatment the Keynote.

No matter what steel is employed in the construction of an automobile, its full value is only obtained by suitable treatment. For instance, a 1/2-inch square bar of nickel steel 6 inches in length supported at both ends resisted a load of 900 pounds when it took a permanent set. The same steel after treatment sustained a load of 2,700 pounds before taking the slightest set. A vanadium-steel bar under the same condition took a permanent set under a load of about 900 pounds; after treatment it resisted a load of 4,000 pounds without taking the slightest set. In fact, the alloy steel before treatment will frequently show but little more strength than good untreated open-hearth steel. The nature of the treatment depends largely upon the use made of the steel, and each manufacturer has a treatment of his own which has been carefully worked out to meet the specific requirements in the various parts of the car.

Besides the various drop forgings, which should never be made of Bessemer steel, high-grade crucible steel castings may be employed for certain parts of the machine. For example, a steel of this character is much better for rear-axle housings than malleable iron; in fact, the latter substance, in the opinion of the writer, should have no place in the car excepting for elbows,

tees, etc., which are not subjected to engine stress or road stresses in which dynamic ability is necessary.

Bronzes, Babbitts and Aluminum.

The other metals besides iron and steel employed in the automobile are mainly bronzes of various kinds (including bearing metals, etc.) and aluminum. High-grade babbitt metals are now employed to a considerable extent in the place of bronze, since they have the advantage of never cutting the shaft in case the oil supply should fail. Aluminum castings are employed by nearly all high-class builders for crank-cases and gear-cases. If properly designed, these castings give excellent results; and at the present price of aluminum are probably as cheap as any that could be employed for the purpose. It is a notable fact that the Americans were the first to introduce both aluminum and nickel steel into automobile construction, though it is generally supposed that these progressive steps should be credited to the French. The extensive introduction of vanadium steel is also due to Americans.

The Transformed Automobile a Marvel of the Age.

With improved design in mechanical parts and the introduction of high-grade alloy steels, together with anti-friction bearings wherever practicable, the automobile has been transformed from the uncouth and unreliable mechanism of a few years ago to one of the most perfect and reliable machines in use. It is certainly a high tribute to the scientist, the metallurgist, the engineer, and the designer that this mechanism has been created and perfected within the last few years to such an extent that its power, endurance, reliability, and speed are among the marvels of the age, and its operation rendered so simple that it can be manipulated and controlled with ease by one in no way skilled in the art of mechanics.

AUTOMOBILES MAY SOLVE THE TRAFFIC PROBLEM

BUFFALO, N. Y., Jan. 25.—One of the biggest and vexing problems in any large municipality is the traffic problem, on which engineers and others have spent years in search of the correct solution. This, which might be likened to the squaring of the circle, now appears to be likely, through the use of motor-propelled vehicles. It is now possible to show by official records just how far the supplanting of horses by motor cars has progressed. In a report recently issued by the London traffic branch of the Board of Trade on conditions in London it is shown that between 1903 and 1907 the number of mechanical cabs has increased by 700, while the horse-drawn cab has decreased by 1,500. Motor omnibuses have increased by 1,200 and horse-drawn buses have decreased 1,000. Statistics concerning the replacement of private carriages are not given.

Perhaps the most pertinent matter brought out in these facts is that of the saving of space in city streets through the use of motor cars. Almost every city has been confronted with an endless congestion in certain thoroughfares and has faced the necessity of widening the pavements. To show the saving of street space that could be made by the universal use of motor cars, the George N. Pierce Company, of Buffalo, N. Y., has made comparisons between the relative spaces occupied by motor and horse-drawn vehicles. Measurements were taken of the street space occupied by the five models of Pierce Arrow cars and of the more prominent kinds of horse-drawn vehicles. In both cases the length over all was used, the length of the horse vehicles, of course, included the horses. The square feet occupied by the various cars is:

	Horsepower	Length Over all	Sq. Ft.
Pierce Arrow	24	12 ft. 8 in.	59.1
"	36	13 ft. 0 in.	60.7
"	40	14 ft. 5 in.	67.0
"	48	15 ft. 0 in.	70.0
"	60	15 ft. 7 in.	72.8
5-ton truck	40	18 ft. 6 in.	84.0

The measurements of the horsed vehicles are:

	Length over all	Sq. Ft.
One-horse cab	19 feet	88.7
Two-horse cab	20 feet	93.3
One-horse delivery wagon	20 feet	93.3
Two-horse delivery wagon	20 feet	93.3
Moving van	24 feet	112.0
Brewery wagon	26 feet	121.1

The most striking comparison is that between the six-cylinder, 60-horsepower car with a seating capacity of seven persons and the one-horse cab. The touring car requires 72.8 square feet of street and the one-horse cab 88.7 feet, a clear saving of 15.9 feet, or 18 per cent., of street space. With the smaller 24-horsepower car, which conforms more closely to the one-horse cab in seating capacity, the difference is even more noticeable. The automobile occupies only 59.1 square feet, giving a difference of 28.6 square feet, or 32 per cent.

Another striking illustration is the space saved by the motor truck. A five-ton truck is the illustration in this case, and the nearest approach to this is the brewery wagon. This occupies 37.1 square feet more street space than the truck, so the use of the latter would mean a saving of 69 per cent.

The figures were shown to an engineer in Buffalo with considerable experience in municipal problems, whose first statement was:

"It looks as if one of the most vexing problems on municipalities—that of increasing the pavement space to prevent the congestion of traffic—will work out through the automobile. Every city of any size has had the question forced on its attention at one time or another, but the more general use of the automobile would allow putting off consideration of it for years enough to bring out some new method of handling street traffic without disturbing existing building lines. At that time, with automobiles in general use, we will have thought out some plan that will relieve the congestion in a manner undreamed of now."

CONCERNING DOUBLE IGNITION PATENT CLAIMS

FROM the Bartholomew Company, of Peoria, Ill., makers of the Glide, come copies of some correspondence which has passed between that company and Elmer Apperson, of Kokomo, Ind., in reference to the double ignition patent claims put forth by the latter. The letters tell the story in such manner as to make it perfectly clear that the patentee will have to go to court before obtaining royalties from this particular concern. Here-with the correspondence is presented in full, containing some information which may be of interest to many readers:

From Elmer Apperson to Bartholomew Company.

APPERSON BROS. AUTOMOBILE CO.

KOKOMO, IND., December 24, 1908.

The Bartholomew Company, Peoria, Ill.:

Gentlemen:—In connection with the motors which you are using, do you use two or more separate electric igniting devices, provided with separate circuits and with means for throwing the igniting devices into or out of action simultaneously or independently, as well as covering the use of two or more spark plugs or sparking points having electrical connections with a magneto and battery with means for throwing the spark plugs or points into or out of operation?

If so, do you consider such method of ignition of value?

I am the owner of Letters Patent of the United States No. 617,806, granted to F. E. Canda, January 17, 1899, for electric igniter for explosion engines, and also of Letters Patent No. 905,625, granted to Elmer Apperson, December 1, 1908, for improvements in explosion engines.

I have no disposition to unnecessarily embarrass any manufacturer now using the device on which I own broad and strong patents. I have spent much time and money in developing this system of ignition to its present effectiveness, and believe that any manufacturer will hold that an owner of a patent of value is entitled to a reasonable compensation therefrom.

If you are now using the system, and if you wish to continue using it, or if you desire to commence using it, I should be glad to hear from you in the near future, and there is no doubt but what we can make arrangements that will prove to be mutually satisfactory. I shall appreciate having your reply to this letter by early mail.

Yours very truly,

ELMER APPERSON.

From Bartholomew Company to Elmer Apperson.

THE BARTHOLOMEW COMPANY.

PEORIA, ILL., January 11, 1909.

Mr. Elmer Apperson, Kokomo, Ind.:

Dear Sir:—We have received your notice concerning the alleged inventions and patents. Concerning this patent to yourself of December 1, 1908, application filed July 3, 1906, we are compelled to say that we cannot recognize this patent as a legal patent, for we had been making cars more than three years prior to the date of this application, containing two spark plugs and the other elements mentioned in the patent. Many of these cars were made and put on the market at that period.

If you should like to have any information concerning the matter, or data, we will hold ourselves in readiness to give it to you any time you come to Peoria. This offer is made in a friendly way, and until such time as we have either had an opportunity to show you in person or in a friendly way the situation as outlined above, or before the court, if it is your pleasure we will drop the matter of this particular patent.

As to the patent of F. E. Canda of January 17, 1909, application filed August 26, 1907: In our opinion this patent does not relate to ignition devices whereby a battery is used for ignition on one set of electrical apparatus and a magneto is used for ignition on another set of electrical apparatus, which are both entirely independent and in nowise connected with each other, each having a switch for throwing it in and out entirely independent of the other.

Kindly let us know if you do not agree with us with reference to the Canda claims.

Yours very truly,

THE BARTHOLOMEW COMPANY.

Per J. B. BARTHOLOMEW, President.

From Elmer Apperson to Bartholomew Company.

APPERSON BROS. AUTOMOBILE CO.

KOKOMO, IND., January 13, 1909.

The Bartholomew Company, Peoria, Ill.:

Gentlemen:—I have just received your letter of the 11th, and note what you say about your having used two spark plugs in each cylinder more than three years prior to the date of the application

of my patent. If you were using spark plugs of this nature three years prior to 1906 I failed to hear of you; in fact, I do not remember of any such concern being in the automobile business in 1903 or prior to that time. In fact, at the present time I do not know or hear of your making very many automobiles, so that in reality what we might collect from you would not be large, to say the most; but in our opinion, it is a fact that you copied this double ignition system from cars which I exhibited at the Chicago show during the Winter of 1904 and 1905. You state in one paragraph of your letter that "many of these cars were made and put on the market at that period." Will you kindly refer me to some one to whom you sold cars as far back as 1903? If you actually made cars in 1903 using two complete systems of ignition, using two spark plugs in each cylinder, I should be very glad for the information, and will have an apology to offer for the statement that I did not know you were in the automobile business at that time. The Canda patent covers one or more sparking points in the same cylinder.

Very truly yours,

APPERSON BROS. AUTOMOBILE COMPANY,
Per ELMER APPERSON.

From Bartholomew Company to Elmer Apperson.

THE BARTHOLOMEW COMPANY.

PEORIA, ILL., January 16, 1909.

Mr. Elmer Apperson, Care of Apperson Bros. Auto Co., Kokomo, Ind.:

Dear Sir:—In response to yours of the 13th, beg to say the tone of your letter reminds the writer of the old story of the fellow who was so deafened by the rattle of his own cart and so blinded by the dust he was kicking up himself that he had seen or heard of no one else along the highway.

The dust you are stirring,

Is still in the air.

You will have to ride through it.

Better stir it with care.

We took your notification in good faith and thought you would be interested in the information our letter contained, for we know, as a matter of fact, there are a good many erroneous impressions that exist among the people engaged in the automobile industry; and while we have been modest in our operations, we have been busily engaged in the business of turning out automobiles to the trade ever since 1900, but the most of our experimental history dates back of even that, and you might be interested to know, as a matter of history, concerning the industry, that in our shops an automobile was made as early as 1889. While it was a very crude affair, it actually traveled half way across one big State and entirely across another, and from that time on we have been more or less engaged in one way or another in automobile experiments, construction and exploiting; but nevertheless, during this period were very busily engaged in the manufacture of other machinery.

In 1893, on behalf of my company, I negotiated a contract with Mr. Charles E. Duryea et al., in which contract the undertaking was the production of a gasoline automobile of his design, and this was done before he had completed any working drawings, and it might be interesting to you to know that one of our present stockholders made all of his drawings, covering all of his various constructions up to the date he moved from Peoria to Reading.

As a result of this connection, automobiles of his design were produced here in Peoria, and within the next fifteen months or such a matter were running on the streets of Peoria, and these machines, I believe, are still in existence.

In our foundry, in 1894, we made the first cylinder castings from Mr. Duryea's first pattern. This may or may not have bearing on the questions under consideration; but it is interesting, nevertheless, to know that in his construction the cylinders were all cast integral, a system of manufacturing that is being promoted by some of the more recent concerns, and is strongly advocated because of its being of French origin. (?) We have the first casting that was made from his pattern in our sample-room at the present time, and it is held there as a relic, having been cast as early as 1894.

Without going into detail as to what happened from that time down to 1900, except to say the writer was in some manner or other more or less engaged in the exploiting of motor-driven vehicles, but in 1900 we had arrived at the point where we were ready to commence the delivery of Glide cars to the trade, and while, as before stated, our movements have been conducted in a modest way, we want to answer that part of your letter which states you failed to hear of us and do not remember of any such concern being in the automobile business in 1903 or prior to that time, and even now do not hear of our making very many automobiles, by informing you that there are at the present time more Glide cars in the hands of users than there are cars manufactured

by all other automobile manufacturers of Kokomo, Ind., put together.

We did state in our former letter that many of these cars were made and put on the market at that period, namely, as far back as 1903, and if we understand your letter, you want us to qualify as to the meaning of many. We turned out machines enough and got publicity enough in our work to destroy the value of any patent that might have been taken out unbeknown to us on devices we had produced and put on the market to what we term the extent of many.

For this purpose it seems to me that five would be enough to justify in saying many, although we put out more than 100 machines, and, to answer your inquiry, we will give you the name of H. H. Bliss, Ouray Building, Washington, D. C., as the party to whom we shipped one of our cars on October 6, 1903, and will say also that there were 12 other machines of the same pattern built and delivered the same month of that same year, all of which were equipped with the double spark plug system, which was our common practice during that entire season.

So when you have established these facts you will be able to see clearly that these machines could not have been copied from your machine shown in the Winter of 1905 at the Chicago Automobile Show. In this connection, we are prompted to suggest that possibly you might have seen our machine with the two-spark plug system exhibited at the Chicago Automobile Show in February, 1904. It was there, and the writer remembers distinctly of a man by the name of "Apperson"—either that year or the year before—coming onto our space, but as I understood it, he was with the Haynes-Apperson Automobile Company.

We made our first exhibit at the show in February, 1903, and if you care to look this matter up you can write to S. A. Miles, and ask him if we did not pay him for space on February 19, 1903. We have exhibited at the Chicago show every year since, and we do not understand how you could have overlooked these important exhibitions we have given. Some of them have been exceedingly attractive and interesting.

Concerning the Canda patents, if you will turn back to our letter of the 11th and read it carefully you will see your statement, "The Canda patent covers one or more sparking points in the same cylinder," does not answer in that it does not agree or disagree with our opinion as stated.

You might be excused for making a statement of this kind, if you did not know better. We will assume you have written your letter without knowledge as to the exact character of the claims of this patent. Nevertheless, inasmuch as we have taken this matter up in good faith with you, we believe we are entitled to an expression from you as to whether or not you entertain our opinion or disagree with us concerning this patent.

Therefore, we want to put the matter up to you squarely in this way: If our machines for 1909 are made with two sets of spark plugs for each cylinder, with a battery circuit for one plug to each cylinder and a magneto circuit for the other plug to each cylinder, both circuits entirely separate from each other, with a separate switch for each circuit to throw it on and off, under such circumstances would you consider our product an infringement of the Canda patent?

You say if we actually made cars in 1903, using two complete systems of ignition, using two spark plugs in each cylinder, you would be very glad for the information, and will have an apology to offer for the statement that you did not know we were in the automobile business. You can make the apology now or wait until you have further evidence; but it is going to be up to you.

And now one word in conclusion, and that is, Mr. Apperson, is it not possible that since you were not familiar with those engaged in the automobile business at this earlier period and with what they were doing, that there are many other things in the art about which you are not well informed?

Yours very truly,

THE BARTHOLOMEW COMPANY,

Per J. B. BARTHOLOMEW, President.

NEW BOOKS FOR THE AUTOIST

Magnetos for Automobilists.—This 64-page book is written by S. R. Bottone, and the publisher is the D. Van Nostrand Company, New York City. The book is full of meat in acceptable form for the autoist who wants to know about magnetos and other means of ignition. It is a skilled résumé of the situation, involving as it does divers problems, intricate in a sense, so plainly depicted as to clearly indicate the skill of the author, who, by the way, is too well known to require any introduction at all. The historical chapter is of interest, and is followed by a chapter about materials; then there is a discussion of special forms, and enough to say on the phase of the problem involving the several applications, with deductions of value. The price of the book is \$1.

THE AUTOMOBILE CALENDAR.

AMERICAN.

Shows and Meetings.

- Jan. 27-Feb. 3. Philadelphia, Second Regiment Armory, Eighth Annual Show, Philadelphia Automobile Trade Association.
- Feb. 6-13. Chicago Coliseum and First Regiment Armory, Eighth Annual National Exhibition, National Association of Automobile Manufacturers. S. A. Miles, Manager, 7 East 42d St., New York.
- Feb. 15-20. St. Louis, New Coliseum Building, Third Annual Show, St. Louis Automobile Manufacturers' and Dealers' Association. John J. Behen, Chairman.
- Feb. 15-20. Detroit, Wayne Pavilion, Annual Show, Detroit Automobile Dealers' Association. E. LeRoy Pelletier, Manager.
- Feb. 22-27. Cleveland, First Regiment Armory, Annual Show, Cleveland Automobile Dealers' Company.
- Feb. 15-20. Bangor, Me., Auditorium, Eastern Maine Automobile Show.
- Feb. 16-18. Denver, Colo., Auditorium, First Annual Automobile Show, Denver Motor Club.
- Feb. 18-25. Toronto, St. Lawrence Arena, Third Annual National Automobile, Motor Boat and Sportsmen's Exhibition. Ontario Motor League. R. M. Jaffray, Manager.
- Feb. 20-27. Newark, N. J., Essex Troop Armory, Roseville Avenue. Second Annual Show New Jersey Automobile Trade Association. H. A. Bonnell, Manager.
- Feb. 20-27. Hartford, Conn., Second Annual Show, Hartford Automobile Dealers' Association.
- Feb. 24-27. Omaha, Fourth Annual Automobile Show, Omaha Automobile Show Association. C. N. Powell, Sec'y.
- Mar. 1-6. Buffalo, Convention Hall, Annual Show, Automobile Club of Buffalo. D. H. Lewis, Secretary.
- Mar. 6-13. Boston, Mechanics Building, Seventh Annual Automobile Show, Boston Automobile Dealers' Association. C. I. Campbell, Manager, 5 Park Square.
- Mar. 8-13. Kansas City, Kansas City Automobile Dealers' Association Show.
- Mar. 8-14. Portland, Ore., First Annual Automobile and Sportsman's Show, Portland Automobile Club. W. F. Lipman, Secretary.
- Mar. 11-13. Milwaukee, Wis., Hippodrome, First Annual Show of Milwaukee Automobile Club.
- Mar. 13-20. Minneapolis, Minn., National Guard Armory, Second Annual Show, Minneapolis Automobile Show Association. F. E. Murphy, Secretary.
- Mar. 15-20. Rochester, N. Y., Convention Hall, Annual Show, Rochester Automobile Dealers' Association. Charles J. Moran, Exhibition Manager.
- Mar. 27-Apr. 3. Pittsburg, Duquesne Garden, Automobile Show, Pittsburg Automobile Dealers' Association.

Races, Hill-climbs, Etc.

- Feb. 20-22. New Orleans, Fair Grounds Track, Mardi Gras Race Meet, New Orleans Automobile Club. Henry George, Secretary.
- Mar. 5-12. Palm Beach, Fla., Lake Worth, Fifth Annual Regatta. Palm Beach Power Boat Association.
- Mar. 23-26. Daytona, Fla., Seventh Annual Florida Beach Races, Florida East Coast Automobile Association. New York Representative, W. J. Morgan, Thoroughfare Building.

FOREIGN.

Shows.

- Jan. 30-Feb. 14. Turin, Italy, Palais des Beaux Arts, Automobile Salon.
- Mar. 15-31. Vienna, Austria, Automobile Exposition, Automobile Club of Austria.

Races, Hill-climbs, Etc.

- Mar. 31-Apr. 14. Monaco, Italy, Annual Motor Boat Regatta and Championships.
- May 2. Sicily, Targa Florio, Automobile Club of Italy.
- May 26. Russia, Moscow—St. Petersburg Race.
- June 10-18. Germany, Prince Henry Cup Competition.
- June 14-19. Scotland, Scottish Reliability Trials.
- July 1-3. France, Angers Course, Grand Prix, Automobile Club of France.
- July 13-17. Belgium, Ostead Automobile Race Week.
- Sept. 5. France, Mont Venteux Hill Climb.
- Sept. 11-19. Italy, Bologne, Florio Cup Race, Automobile Club Bologne.

LETTERS INTERESTING AND INSTRUCTIVE

TO MAKE THE SPRINGS BEHAVE PROPERLY.

Editor THE AUTOMOBILE:

[1,711.]—I have followed your articles on springs and shock absorbers with great interest, but have not found definite answers to some questions. My runabout has rear seat attachment, and when heavily loaded rides very nicely, but as a runabout is "hard" riding, the springs being evidently much too stiff. As I understand it, there is no kind of shock absorbers that would help matters in this case. I could make room for coil springs, made to order, at the end of the present leaf springs that would give three or possibly four inches of play there on the principle of those spiral springs I see advertised for this purpose. I am afraid the advertised ones would not give me enough play to be of much value.

Please advise me what can best be done to make it ride as easy when as a runabout as with 400 pounds more in it. Could I use coil springs to take the place of the 400 pounds extra weight to act in opposition to the leaf springs now on there? It seems to me this would work if the coil springs could be made to exert about the same pressure through their required range of action. How would it be to put on light springs that would give the body chance to come down four or five inches before bumping and some kind of shock absorbers that would cause the oscillating movements to be slower? In fact, I don't believe the "level platform" is so important as it is to reduce the rapidity of the up and down motion to a point where it ceases to throw us. I am bound to do something to make this car ride easier, but I do not know what to do, and your opinion will carry much weight with it.

Fulton, N. Y.

CHARLES V. ARMSTRONG.

The problem is one to give you some little trouble any way you care to look at it. As a general proposition, it is necessary to stress the materials of which the springs are made to a point bordering upon the elastic limit, if it is desired to realize easy riding qualities with quite wide variations of the load. To take advantage of this method of proceeding requires the use of materials such as will stand the work for a length of time said to be satisfactory. Simultaneously, it is necessary to have the springs so long that the vertical bounce will be at a slow rate. This is a matter depending upon the length of the springs, just as the swing of a pendulum is dependent upon the length. When the length of a spring is fixed on a basis to satisfy this phase of the subject, then it is time to determine as to the volume of the material, such as will absorb the energy represented in the motion of the mass and the rate of change thereof. On the other hand, as before stated, if the material is not stressed to a point very near the elastic limit of the same, motion will not be arrested in a way to satisfy the conditions, especially if it is true that the load is not to be the same at all times. Whether or not you can approximate the conditions you have in mind through the use of coil springs, is a question to be arrived at on a basis called "cut and try." The "level platform," as referred to by you, is desirable, but you will have to go over the literature on the subject again; you failed to absorb the information.

EXPERIENCE WILL BEST TELL THE TALE.

Editor THE AUTOMOBILE:

[1,712.]—May an automobile agency be made a feasible, paying project in a small town, the total territory allotted to include three adjacent counties, fairly well populated and containing a number of small cities and villages? The promoter is a practising dentist who would do the correspondence and advertising from his office, and his partner is a reliable and dependable man who would give all his time to demonstrating and closing sales in all parts of the territory. A conveniently located barn can be rented for keeping a few machines in on arrival, obviating the necessity of an investment for that purpose. An agency for a reliable and very popular line can be secured on making a small cash deposit for five cars. What do you think of such a venture? A SUBSCRIBER.

Cumberland, Wis.

The proposition sounds all right and you have probably taken into account such conditions as roads, the class of people you will deal with, etc. You are very likely to find that some provision for small repairs will have to be made at an early date if you intend to establish an agency on a sound basis. Your customers will have to be taken care of.

TO DETERMINE GEAR RATIOS IN GEAR BOX.

Editor THE AUTOMOBILE:

[1,713.]—Kindly publish, in this week's issue if possible, how you would determine the ratio of the gears in a car when same is on low gear, i.e., providing the standard ratio of the rear axle gears is 3:5 to 1 or 4 to 1.

INTERESTED.

Given the fixed gear ratio in rear axle, the ratio of the gears in the gear-box may be determined by first fixing the speed at which you wish the car to travel with the motor turning over at a given number of revolutions per minute.

Let:

(1) The fixed reduction = 3.5 to 1.

(2) The speed of the car (for low gear) = eight miles per hour at 1,000 r.p.m. of the motor.

(3) The diameter of the rear wheels = 34 inches.

To travel eight miles per hour 34-inch wheels must make 79 (approx.) revolutions per minute, and with a 3.5 to 1 ratio in bevel-gear drive, the propeller shaft must make $79 \times 3.5 = 277$ r.p.m. (approx.). Then with a motor speed of 1,000 r.p.m. and propeller shaft turning at 277 r.p.m., the ratio of the low-speed gears will be as 1,000 is to 277, or about 3.6 to 1, giving a total reduction of about 12.5 to 1.

If you have access to an "Automobile Trade Directory" you will find tables on page 408 which will be of assistance in calculating these ratios.

INFLUENCE OF KEROSENE ON LUBRICATING OIL.

Editor THE AUTOMOBILE:

[1,714.]—What is recommended for lubricating oil in the automobile to keep the oil from congealing when the car is used in extremely cold weather? The belief is that kerosene or gasoline is sometimes mixed with the oil for the purpose. Can you advise as to the right proportions to use? B. B. B.

Waterbury, Conn.

Excess mobility in lubricating oil is the phenomenon noted when the oil shows a decided tendency to solidify as the temperature is lowered. The right grade of oil would be the grade which would hold to a constant viscosity under all likely conditions of temperature. Some of the grades of oil are more perfect in this respect than are others and it is advantageous to pay more money for the grades of oil which do show the requisite properties.

Constant mobility is quite out of the question, to be sure, and the refiners of oil practice the art of furnishing lubricating oil in several selections as respects viscosity. The right course, then, is to use thin oil in cold weather, thin enough so that it will flow, and as the weather warms up the selection should be in favor of the heavier grades of oil.

As respects kerosene and gasoline in the lubricating oil, enough it is to say the oil is ruined for the purpose of lubricating if it is thus diluted. Proof of this is given in the plan by which kerosene is used in clutch oil if the clutch will not hold. In a word, lubricating oil in the clutch is too slippery, and kerosene is added to diminish the unctuousness on the one hand, and a still more important property on the other, namely, the ability of lubricating oil to persist in remaining between two surfaces under great pressure. In the case of the clutch it is desired to have the oil squeeze out from the discs with ease. This case would be ruinous to a crankshaft bearing, as will be self-evident.

But the story is not even half told: the "flash point" of the lubricating oil is of the greatest importance, and this point will be much altered if the oil is tinkered with. The flash point of kerosene is low in comparison with the same point of lubricating oil, and while the writer has not the data of the resultant flash point before him, yet even so it is a good guess that the resultant flash point will be so low as to defeat the whole project.

Constantly feeding kerosene to the cylinders of a motor, even

if the same is sneaked in with the lubricating oil, is bound to result in the unbalancing of the explosive mixture, and, too, it is plain that the question of "carbon deposit" will be rendered the more prominent. Nor is it believed that the question is all in; it would be a subject for more than a little investigation before all the ills of such a procedure would be on the surface; the trouble is that the reasons as they are known are so many and so formidable as to demand no further thought at the expense of time or money.

BROKEN-DOWN SPARK COIL HARD TO REPAIR.

Editor THE AUTOMOBILE:

[1,715.]—I would like to have your opinion on the following: I have a double Cauret (?) coil, which has been working quite well until the last few weeks. But there seems to be a short circuit somewhere in the coil when there is no contact at the timer and when the current is thrown on a small spark may be seen at the plugs if the secondary is touched to the plug. What part of the coil is most likely to be injured? Will the current break through the insulation on the primary windings of the coil? How does this current get through the coil? The coil will buzz only part of the time. Where is the "safety gap" put in the coil? Would it help matters any to re-wind the secondary? E. H. SCHROEDER.
High River, Alta.

It would be within the range of facts to consider that, the timer is short-circuited. If the timer is out of order it will be easy to account for the intermittent service you claim is rendered. If there is a "safety gap" provided it will be in sight. As regards the breaking down of the insulation in the coil, it is probably due to the building up of the electromotive force to a point in excess of the ability of the insulation on the windings. Sometimes it is possible for the coil to work even with a partial short-circuit, and you will find that by closing in the gap of the plugs to the minimum (say, the thickness of a visiting card) the insulation will be relieved of much of the electrostatic strain and it may then be capable of sustaining in service.

You will not be able to rewind the secondary, in all probability, for the reason that the winding is of great length, and it is done in a machine. You would have difficulty in getting so much wire on the spool even were you to use new wire. If the coil is not filled with paraffine you can bake it in an oven at a gentle heat for some time to drive out the water and then you can boil it in paraffine, which may be the means of lifting the short circuit, if one there is.

Before doing anything to the coil look for your trouble in the wiring or in the timer. Make sure that the battery is in good order and examine the ground connections. A loose joint would do just what you claim is happening.

CHAUFFEUR IS REGARDED AS A PAID EMPLOYEE.

Editor THE AUTOMOBILE:

[1,716.]—Please answer the following questions in THE AUTOMOBILE as soon as possible:

1. Is there any difference between a driver and a chauffeur?
2. Is it necessary for a chauffeur to have a license in Iowa? In other States? How may it be obtained?
3. Where could I get a book which maps out all the country roads in the central and eastern part of Iowa? A READER.
Onita, Ia.

(1) If you drive your own car you are not a chauffeur; on the other hand, if you are a chauffeur you are also a driver; it is fair to explain the situation as it seems to adhere to the minds of autoists in general. On the other hand, the word "chauffeur" is defined as a noun and the chauffeur is defined as fireman, stoker and on certain other occasions as a robber. (See Spiers & Surene's French Pronouncing Dictionary.) Taking the last definition as the correct one, it is plain that you cannot drive your own car as a chauffeur. In all probability, the word chauffeur was expanded to include drivers of automobiles, through the use of steam boilers and engines, in the early types of automobiles. They were so designed as to require a fireman (chauffeur) and when the change came the fireman was advanced to the new position, holding to the old

name. In this will be seen evidence of the fact that the chauffeur is as a paid employee.

(2) The paid employee may be required to take out a license. You, as an owner, will not have to do so, but you will have to file your name and address, with a description of the machine, on a prepared blank in the office of the Secretary of State. Upon application the Secretary will forward to you a blank for the purpose. As a chauffeur apply to the office of the Secretary of State (by letter) for a copy of the law in relation to the matter. For other States go through the same process.

(3) A book mapping all the country roads in Iowa may be difficult to find. The "Automobile Blue Book" is the nearest thing to it.

COMPOUNDS FOR PROLONGING LIFE OF RUBBER.

Editor THE AUTOMOBILE:

[1,717.]—Kindly tell me what you may know of the virtue or otherwise of a liquid on the market known as "Rubberlife." It is said to harden, increase the resiliency and revive rubber; therefore to greatly prolong the life of automobile tires when duly applied. L. N. DAVIS, M.D.

Farmland, Ind.

Possibly the makers of the product to which you refer will be willing to advise you of the qualities of the material for the purpose. In the meantime it may not be out of place to observe that it is not desirable to "harden" the rubber; what is wanted is to conserve the good condition which is present in the new tires. If the air is the cushion in fact and the tire is merely an envelope, it is a fact that the minimum value of the equation which follows is what is wanted.

Work required to strain the body

Work returned by the body

= minimum value for best result.

It would seem as if the tire should be as flexible as possible if the loss in the tire is to be the minimum. The life of rubber is prolonged if it is kept free from wounds, and if the atmosphere is not too dry, provided "direct light" is warded off. Tires should be allowed to hold to their natural shape, else the fabric will become weakened in consequence of deformations.

WANTS TO KNOW ABOUT SPROCKET RATIOS.

Editor THE AUTOMOBILE:

[1,718.]—Would a 24-tooth sprocket be a suitable sized one for the rear axle of a light 12-horsepower runabout having a planetary transmission fitted with a 10-tooth sprocket? Direct drive by roller chain is used. The engine is a horizontal opposed, with 4 1-4-inch cylinders, and runs at the average rate of speed of this type. The rear wheels have 30x3 1-2-inch tires. Will you please mention some of the sprocket ratios used on different chain-driven cars of about this power?

If you can give me the name of a firm from which one could obtain 4 1-4-inch piston rings, 5-16-inch wide, and answer the above, you will greatly oblige. M. R. S.

Springfield, Mass.

Would recommend that you use 14 teeth in the pinion, and use at least three times as many teeth in the mate. If you are compelled to keep to a low limit, then it is to tolerate a condition which cannot be looked upon as healthy. On high gear the ratio ranges between 3 to 4 in usual cases. You can procure what you want by way of piston rings from the maker of your motor, or, from some maker of motors; see advertising columns of THE AUTOMOBILE. Then there is the "Automobile Trade Directory," in which you will find much valuable information in relation to such and kindred matters.

TAKE A LOOK AT THE IGNITION SYSTEM.

Editor THE AUTOMOBILE:

[1,719.]—I saw an answer to my inquiry in "Letters Interesting and Instructive" in your show number. I have put a Schebler on my Franklin 1904 car, and still it will not start without priming when cold, no matter how hard I turn the motor over, although the motor does not choke up when I open the throttle up. Can you give me any remedy for this? I saw an article in "The Automobile" in this same department saying that by putting a teaspoonful of flake graphite in the lubricating oil every two weeks it would give motor good compression. Would graphite (flake) hurt an air-cooled motor?

How is the low speed and reverse tightened up on the 1904 Franklin? It has a planetary transmission. Do you have any diagram of how to put a fan in a 1904 Franklin, and what would be needed in the way of fixtures and bearings?

Your show number was certainly a dandy. Keep up the good work and you will never know failure.

Corona, L. I. CHARLES B. FRANKS.

One of two points will have to be settled before you can make any further headway. In the first place you cannot be sure that your new carbureter is properly adjusted until the motor can be started without priming. In the meantime take a look at the ignition system and see if it is all right. Make sure of the battery.

Graphite in proper form should be of advantage to you. Confer with the venders of the same; they will gladly give you the benefit of a vast experience.

Write to the Franklin Company; the chances of realizing the best information from first sources are always good.

ABOUT THE FIXED POINT OF IGNITION.

Editor THE AUTOMOBILE:

[1,720.]—Will you kindly publish in your "Letters Interesting and Instructive" some information on two types of magnetos, viz., one using a spark advance, as in the battery and coil system, and the other using a fixed point of ignition. I contemplate adding a magneto to the equipment on my car and have been told and think I have read in your columns that the fixed point of ignition was the better of the two, as it tended to lengthen the life of the motor and give as good service as the system which used the advance. Will you please state in your columns whether the system using the fixed point of ignition is O. K. and whether or not it will give the same results as the other system? An answer to my query will be appreciated.

CINCINNATI.

Cincinnati, O.

By using the magneto with the fixed point of ignition you will get a good average result and through its use the possibility of bad performances are at a minimum. In very large motors the cranking difficulty is great. In certain classes of service it is an advantage to have the fixed point of ignition, as in taxicab work, but it is not necessary to an autoist who drives his own car.

BUT A. A. A. CLUBS ARE DOING MUCH.

Editor THE AUTOMOBILE:

[1,721.]—Quite a few months ago I wrote an article which you published, suggesting the formation of an "Automobile Owners' Protective Association." This, I believe, is becoming more of a necessity every day, as it is the only way to remedy many abuses we have now to endure, such as extortionate charges of some garages and hotels; using of cars for so-called "joy rides"; unjust arrests by constables or deputy sheriffs, otherwise known to owners as "road agents."

There are many benefits to be gained by owners getting together, such as combined purchasing power, besides endeavoring to correct above evils; also aiding members on road when they are in any kind of trouble; in fact, the subject is so full of suggestions and possibilities and benefits, such as are not derived from belonging to a local automobile club—for that is more of a social affair—whereas what I suggest is a business matter for mutual protection and profit to its members.

WILLIAM D. THOMAS.

Brooklyn, N. Y.

Is it not possible to induce the automobile club to extend its zone of activity, if it is generally believed that there is a need for these added benefits.

THE USE OF LEATHER TIRE CASINGS.

Editor THE AUTOMOBILE:

[1,722.]—I would like to know through "Letters Interesting and Instructive" if the leather tire casings which are advertised are good. Do they protect the case and prevent so-called punctures? As all the ruptures that I have had come on the inside of the tube next the rim, will the case last longer with them? Will not gravel and sand get in between the cover and the case and chafe? Do they make the car run harder? Please give me the advantages of them, if any.

W. F. STETSON.

Cherry Creek, N. Y.

Anything which will tend to increase the life of the tires is good, and as many autoists continue to use the leather casings it is pretty good evidence that they are doing good work.

DEPENDS UPON THE AUTOMOBILE ENTIRELY.

Editor THE AUTOMOBILE:

[1,723.]—Would you please tell me in your "Letters Interesting and Instructive" what angle do the forward wheels take when making a short turn and how to find the answer of any turn?

New York.

M. L. C.

As a general statement it will be possible to say the wheels cant over about 36 degrees, maximum. As a matter of fact, the maximum possible cant is dependent upon the section of the tires, the diameter of the road wheels, and the space between the wheels and the chassis frame. On the other hand, the mean turning radius of a car depends upon the length of the wheelbase of the same, if it is desired to avoid undue tire strains. Taking the length of the wheelbase as the sine of the angle, then it is possible to ascertain, that the radius, which will be found on a basis of the sine given, will equal the mean turning radius of the car.

FRANKLIN CONCENTRIC VALVE PERFORMANCE.

Editor THE AUTOMOBILE:

[1,724.]—I have been much interested in the "Letters Interesting and Instructive" department of your paper, and as I have just purchased a Franklin, Type D, car (not yet received), will appreciate a detailed explanation of the working of the Franklin concentric valve.

W. K. E.

Charleston, W. Va.

You will find the literature of the Franklin Company is so plain as to serve your purpose most thoroughly if you will look it over. Any explanation of the working of the concentric valves that might be printed here would simply be a repetition of that contained in the Franklin instruction book.

DOPE IN THE GASOLINE.

Editor THE AUTOMOBILE:

[1,725.]—What amount of ether do some racing cars use in their gasoline; someone said two teaspoonfuls to a gallon. Is this correct? What is the use of having ball and socket joints for brake rods and other minor parts instead of simple clevis joints?

Middletown, N. Y.

A SUBSCRIBER.

We have no definite information in relation to ether in gasoline. Perforce, some user will enlighten us through the columns of "Letters Interesting and Instructive." The ball joint is adjustable, and the surface is that of a sphere, which is the maximum.

ANTI-FREEZING SOLUTIONS IN THE SOUTH.

Editor THE AUTOMOBILE:

[1,726.]—Kindly advise me what is the best anti-freeze to use and proportion necessary to prevent freezing at different temperatures.

Columbia, S. C.

S. B. FISHBURNE, M.D.

If raw corn whiskey is cheaper in the South than alcohol, use it. Add to the whiskey an equal amount of water. It may "slush" at a very low temperature, which will do no harm. See issue of THE AUTOMOBILE, November 19, 1908, it deals with this question at some length.

HOW OLD IS AN ODOMETER?

Editor THE AUTOMOBILE:

[1,727.]—In the "Diary of John Evelyn," published by Charles Scribner & Sons, New York, under date of August 6, 1657, is the following:

"I went to see Col. Blount, who shewed me the application of the WAY-WISER to a coach, exactly measuring the miles, and shewing them by an index as we went on. It had three circles, one pointing to the number of rods, another to the miles by 10 to 1,000, with all the subdivisions of quarters; very pretty and usefull."

This shows its use at least 250 years ago, and may be interesting information to some of your readers.

X. Y. Z.

Portsmouth, N. H.

SKEIN IS UNRAVELED FOR NO. 1,696.

Editor THE AUTOMOBILE:

[1,728.]—The carbureter popping in the case of No. 1,696 is undoubtedly due to a leaky valve. Had the same trouble myself. Repairmen were puzzled, and, after I had spent over \$100, a new cylinder and valves cured the trouble.

ELIOT GORTON.

Summit, N. J.

OREGON'S COOS BAY COUNTRY.

PORTLAND, ORE., Jan. 23.—One of the richest endowed regions, from a scenic point of view, anywhere on the Pacific Coast will, it is believed, be this year opened up and made easy of access for the tourist's automobile. This is the Coos Bay country and the mountains lying between this natural harbor and the railroad. All this district has been penetrated by only a few automobilists.

The State of Oregon has within its borders three or four regions of high cultivation within themselves, but difficult to reach from the outside for several months each year. The Coos Bay country in the southwestern part of the State is accessible by land only after a long stage ride which, no matter which route the traveler takes, is about 60 miles.

So general has become the demand for better roads that it is now determined the present year shall see the completion of a better highway from Roseburg, on the Southern Pacific, to Coos Bay, on which are several live, thriving towns. The question at present is not whether there shall be a road, but which route shall be utilized. One road brings the traveler from the railway to Myrtle Point, where after a long stage journey he takes the little railroad which skirts the shores of the bay. The other route is called the Coos Bay wagon road. Both routes are now covered by stages.

The first auto trip over the Myrtle Point road was made last Summer by A. H. Stutsman, of Marshfield, the principal town of the bay group. He went to Roseburg and back, and at once began agitating for an automobile thoroughfare to the Southern Pacific, for he declared there were no obstacles which could not easily be overcome. Henry Harth, of Roseburg, took a party of friends over the road a little later.

Crossing the Coast Range of mountains, this road, and the so-called Coos Bay route as well, afford the man who seeks something new in scenery many opportunities to gratifying his view-loving senses. The incline is 12 miles up one side of the range and four miles down the other side, and every rod of the distance is worth traveling for its scenic beauties. The summit is 3,000 feet above the level of the Pacific. Mr. Harth, among others, prefers the Coos Bay route.

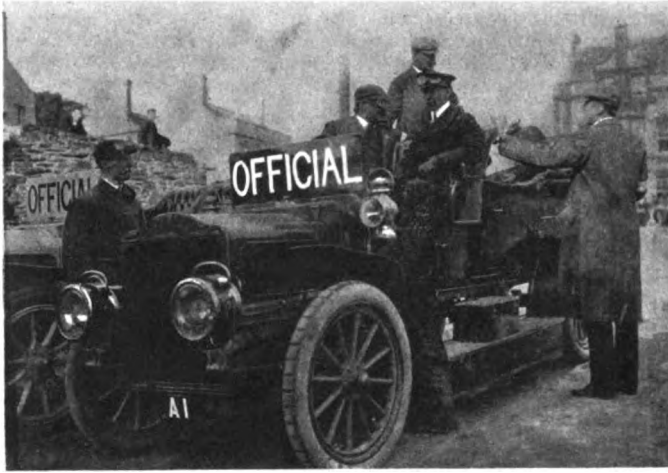

Earl Russell's White Steamer Bears British No. "A-1."

WHITE STEAMER FIRST CAR IN BRITAIN.

LONDON, Jan. 21.—On the last day of 1908 the total number of motor vehicles registered in London to date reached just short of the 40,000 mark. It is interesting to note that the first of this big number was a White steamer, the property of Earl Russell, which consequently has A1 on its number plates. The accompanying photos of this car were taken at Ramsey, Isle of Man, at the last of the Tourist Trophy races. Earl Russell, who is a member of the R. A. C. committee, is in the driving seat, with the chauffeur alongside. Lady Russell is sitting in the back of the car, and standing up in the tonneau is Col. Holden, the ex-chairman of the competitions committee, while at the side is Mr. Merwyn O'Gorman, chairman of the technical committee.

WHAT MICHIGAN'S ROAD MAKER WANTS.

DETROIT, Jan. 18.—If State Highway Commissioner Horatio S. Earle has his way automobilists will no longer be permitted to spin about the State utilizing the model highways constructed primarily for the benefit of the honest tiller of the soil without paying for the privilege. Commissioner Earle will ask the present Legislature to impose a tax on automobiles for road purposes, the rate proposed being 10 cents per horsepower per year. As there are some 7,000 automobiles owned in Michigan, it will be seen that such a course would add a nice little sum each year to the good roads fund.

However, Michigan is already contributing liberally to the good roads cause. Commissioner Earle will ask for \$215,000 from the Legislature this year and \$320,000 next. Inasmuch as there are more automobiles manufactured in Detroit and Michigan than in a similar area in the country, and inasmuch as the makers and owners are called upon to bear their portion of the good roads appropriation in addition to the proposed tax, it is not at all likely that Commissioner Earle will have clear sailing with his latest project, motorists generally feeling that they are doing their share without the imposition of a further burden.

SENATE SAYS TAFT CANNOT HAVE AUTOS.

WASHINGTON, Jan. 21.—President Taft will have to walk, stick to the saddle or be conveyed from place to place in street cars or in horse-drawn vehicles.

The Senate Committee on Appropriations to-day ran across an item in the Urgent Deficiency Bill granting \$12,000 for the purchase and care of automobiles for the use of the executive office. The automobile has not made many friends in the Senate, as was disclosed in the debate of the last few days on the proposed purchase of such vehicles for government officials, and the committee struck the item out. The appropriateness of the automobile in the service of the President is scarcely to be questioned, and it is pretty nearly certain that Congress will reconsider anon.

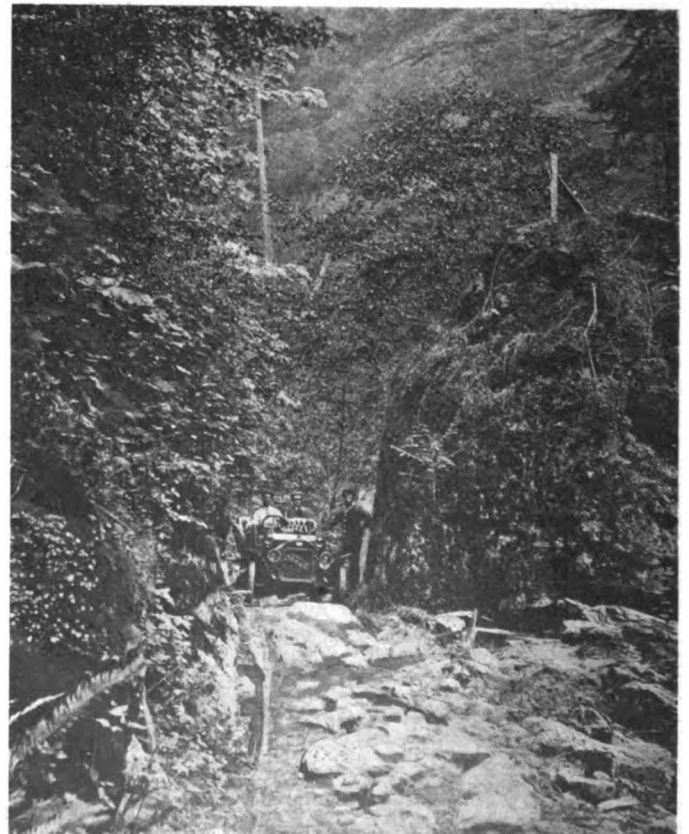

First Auto Through Devil's Gate, Coos Bay, Oregon.

EFFORTS TOWARDS UNIFORM AUTOMOBILE LAW

THE desirability of a uniform automobile law is generally recognized and any effort in this direction seems assured in advance to meet the unanimous support of a large majority of automobilists. Governor Hughes, in his annual message to the New York State Legislature, recommended the adoption by New York and neighboring States of a uniform motor vehicle law, and suggested that the work could be properly done within the purview of the duties of the Commissioners on Uniform State Laws.

Pursuant to the suggestion of Governor Hughes, the Commissioners on Uniform State Laws of New York, New Jersey and Connecticut were invited to a conference, which was of considerable duration, the various diversities at present existing in the laws of the States were discussed and plans laid for the elimination of the differences as far as might be. The con-

ference requested that Charles Thaddeus Terry, who is one of the commissioners from New York and also chairman of the A. A. A. Legislative Board, draft a proposed uniform act to form the basis for the deliberations of the conference. This has now been done. The draft has been printed, and copies have been distributed among the commissioners of the States in question.

The next meeting of the conference will be held in New York City on Saturday of this week, when it is anticipated that the final form of the bill to be recommended to the several legislatures will be decided upon. Suggestions with reference to and criticisms of the bill are invited and will receive the attention of the conference. The matter being one of such vital interest to all concerned, it has been deemed advisable to print in full the following draft of the proposed law:

AN ACT

PROVIDING FOR THE REGISTRATION, IDENTIFICATION AND REGULATION OF MOTOR VEHICLES OPERATED UPON THE PUBLIC HIGHWAYS OF THIS STATE, AND OF THE OPERATORS OF SUCH VEHICLES; AND PROVIDING A FUND FOR THE MAINTENANCE AND IMPROVEMENT OF THE PUBLIC HIGHWAYS OF THIS STATE.

The People of the State of represented in Senate and Assembly, Do Enact as follows:

Section 1. Definitions.—The Term "motor vehicle" as used in this act, except where otherwise expressly provided, shall include all vehicles propelled by any power other than muscular power, except motor-bicycles, motor-cycles, traction engines, road rollers, fire wagons, engines, police patrol wagons, ambulances and such vehicles as run only upon rails or tracks. The term "local authorities" shall include all officers of counties, cities, boroughs, towns or villages, as well as all boards, committees and other public officials of such counties, cities, boroughs, towns or villages. The term "chauffeur" shall mean any person operating a motor vehicle for hire, or as the employee of the owner thereof. The term "state" as used in this act, except where otherwise expressly provided, shall also include the territories and the federal districts of the United States. The term "owner" shall also include any person, firm, association or corporation renting a motor vehicle or having the exclusive use thereof, under a lease or otherwise, for a period greater than thirty days. The term "public highway" shall include any highway, county road, state road, public street, avenue, alley, park, parkway or public place in any county, city, borough, town or village, except any speedway which may have been or may be expressly set apart by law for the exclusive use of horses and light carriages.

Sec. 2. Subdivision 1. Registration of Motor Vehicles.—Every owner of a motor vehicle which shall be operated or driven upon the public highways of this state, shall, for each motor vehicle owned, except as herein otherwise expressly provided, cause to be filed, by mail or otherwise, in the office of the secretary of state a verified application for registration on a blank to be furnished by the secretary of state for that purpose, containing: (1) A brief description of the motor vehicle to be registered, including the name of the manufacturer, the style, type and factory number of such vehicle, the character of the motor power and the amount of such motor power stated in figures of horsepower. (2) The name, residence and business address of the owner of such motor vehicle and the name of the county in which he resides; provided that if such motor vehicle is used or to be used solely for commercial purposes, or, if propelled by electric battery power, is used or to be used solely within the confines of a city, the applicant shall so certify.

Subd. 2. Registration Book.—Upon the receipt of an application for registration of a motor vehicle or vehicles as provided in this section and in section four of this act, the secretary of state shall file such application in his office and register such motor vehicle or vehicles with the name, residence and business address of the owner, manufacturer or dealer as the case may be, together with the facts stated in such application, in a book or index to be kept for the purpose, under the distinctive number assigned to such motor vehicle by the secretary of state, which book or index shall be open to inspection during reasonable business hours.

Subd. 3. Certificate of Registration.—Upon the filing of such application and the payment of the fee provided in subdivision six

of this section, the secretary of state shall assign to such motor vehicle a distinctive number, and, without expense to the applicant, issue and deliver to the owner a certificate of registration, in duplicate, in the form and size provided in subdivision three hereof. In the event of the loss, mutilation or destruction of a certificate of registration, the owner of a registered motor vehicle may obtain from the secretary of state a duplicate thereof, upon filing in the office of the secretary of state an affidavit showing the fact and the payment of a fee of one dollar for each duplicate.

Subd. 4. Registration Lists to be Furnished County Clerks.—The secretary of state shall, within sixty days after this act takes effect, and thereafter, on or before the first day of February of each year, furnish to the clerk of every county in the state a full and accurate list of all motor vehicles so registered, stating the distinctive numbers so assigned to them and the names, residences and business addresses of the owners, manufacturers or dealers, as the case may be, and once each month thereafter a similar list of the additional registrations, which additional list shall be entered by each county clerk upon the original list received by him. Such lists shall be filed by such county clerks and be kept as public records, open to inspection during reasonable business hours.

Subd. 5. Re-registration Annually.—Such registration shall be renewed annually in the same manner and upon the payment of the same fee as provided in this section for original registration. Such renewal to take effect on the first day of January of each year.

Subd. 6. Registration Fees.—The following fees shall be paid to the secretary of state upon the registration of a motor vehicle in accordance with the provisions of this act: Three dollars upon the registration of a motor vehicle having a rating of less than twenty horsepower; five dollars upon the registration of a motor vehicle having a rating of twenty horsepower and less than thirty horsepower, and ten dollars upon the registration of a motor vehicle having a rating of thirty horsepower or more; and if a motor vehicle has two ratings of horsepower, the registration fee shall be based on the higher rating; provided that the owner of any motor vehicle which has been registered under existing law subsequent to the day of one thousand nine hundred and shall be entitled to a credit or rebate of the fees paid under such law for such registration; and provided further that for motor vehicles which in the verified application for registration are stated to be used solely for commercial purposes, or, if propelled by electric battery power, to be used solely within the confines of a city, the fee for such registration shall be five dollars.

Subd. 7. Sale and Registration by Vendee.—Upon the sale of a motor vehicle registered in accordance with this section, the vendee shall, within ten days after the date of such sale, notify the secretary of state of the same upon a blank furnished by him for that purpose, stating the name and business address of the previous owner, if known, the number under which such motor vehicle is registered and the name, residence and business address of such vendee. Upon filing such statement such vendee shall pay to the secretary of state a fee of one dollar, and upon receipt of such statement and fee the secretary of state shall file such statement in his office and note upon the registration book or index such change in ownership, and at least monthly notify every county clerk of the state of such sales, each of whom shall immediately note the same on the list of registered vehicles received and kept on file by him as herein provided.

Subd. 8. Fees in Lieu of Taxes.—The registration fees imposed by this act upon motor vehicles other than those of manufacturers and dealers and those used solely for commercial purposes, shall be in lieu of all other taxes, general or local, to which motor vehicles may be subjected as personal property under the laws of this state.

Sec. 3. Subd. 1. Distinctive Number Must Be Carried on Motor Vehicles.—No person shall operate or drive a motor vehicle on the public highways of this state after theday of..... nineteen hundred and..... unless such vehicle shall have the certificates of registration assigned to it by the secretary of state conspicuously displayed, one on the front and one on the rear of such vehicle, each securely fastened so as to prevent the same from swinging, provided that the owners of motor vehicles registered and assigned numbers under any law in force at the time this act takes effect, shall continue to display such numbers thereon until the.....day of....., nineteen hundred and..... No person shall display on such vehicle at the same time any number assigned to it under any other motor vehicle law or ordinance.

Subd. 2. Color of Number Plate to Be Changed Annually.—Such certificates of registration shall be of a distinctly different color or shade each year, to be designated and selected by the secretary of state, and there shall be at all times a marked contrast between the color of the number plates and that of the numerals or letters thereon.

Subd. 3. Form of Certificate.—Such certificate of registration shall be an enameled plate or placard of metal, four and one-half inches wide and not more than twelve inches in length, in the upper left hand corner of which there shall be a fac-simile of the seal of the state, underneath which there shall be the initials "....." and to the right of which seal and initials there shall be the distinctive number assigned to the vehicle set forth in numerals three inches long, each stroke of which shall be at least one-half an inch in width; provided that in the case of a motor vehicle registered under section four of this act there shall be on such plate or placard in addition to the foregoing the letter "M," the same to be at the right of the distinctive number, each stroke of such letter to be at least three inches long and one-half an inch in width.

Sec. 4. Subdivision 1. Registration by Manufacturers and Dealers.—Every person, firm, association or corporation manufacturing or dealing in motor vehicles may, instead of registering each motor vehicle so manufactured or dealt in, make a verified application upon a blank to be furnished by the secretary of state for a general distinctive number for all the motor vehicles owned or controlled by such manufacturer or dealer, such application to contain: (1) a brief description of each style or type of motor vehicle manufactured or dealt in by such manufacturer or dealer, including the character of the motor power, the amount of such motor power stated in figures of horsepower, and the weight in pounds of each such style or type; and (2) the name, residence and business address of such manufacturer or dealer. On the payment of a registration fee of ten dollars, such application shall be filed and registered in the office of the secretary of state in the manner provided in section two of this act. There shall thereupon be assigned and issued to such manufacturer or dealer a general distinctive number and duplicate certificates of registration in the manner provided by section two, which shall be in the form of plates as provided in section three, duplicates of which shall be carried or displayed by every motor vehicle of such manufacturer or dealer, so registered when the same is driven or operated on the public highways. Such manufacturer or dealer may obtain as many duplicates of such certificates of registration as may be desired upon payment to the secretary of state of one dollar for each duplicate. Nothing in this subdivision shall be construed to apply to a motor vehicle operated by a manufacturer or dealer for private use or for hire.

Subd. 2. Re-registration Annually.—Such registration shall be renewed annually in the same manner upon the payment of a fee of ten dollars, such renewal to take effect on the first day of January of each year.

Sec. 5. Exemption of Non-resident Owners.—The provisions of the foregoing sections shall not apply to a motor vehicle owned by a non-resident of this state, provided that the owner thereof shall have complied with the provisions of the law of the state of his residence relative to motor vehicles and the operation thereof and shall conspicuously display his state number, and provided further that the provisions of the foregoing sections of this act are substantially in force in such state; provided that this exemption shall not apply to non-resident corporations doing business in this state.

Sec. 6. Subd. 1. Brakes, Horns, Lamps, et cetera.—Every motor vehicle, operated and driven upon the public highways of this state, shall be provided with adequate brakes sufficient to control the vehicle at all times, and a suitable and adequate bell, horn or other device for signaling, and shall, during the period from one hour after sunset to one hour before sunrise, display at least two

lighted lamps on the front and one on the rear of such vehicle, which shall also display a red light visible from the rear. The white rays of such rear lamp shall shine upon the number plate carried on the rear of such vehicle. The light of the front lamps shall be visible at least two hundred feet in the direction in which the motor vehicle is proceeding.

Subd. 2. Use of Non-skidding Devices.—No person shall operate or drive on the public highways of this state a motor vehicle on any of whose wheels is a tire chain or non-skidding contrivance or tire composed in whole or in part of metal, except when such highways are wet and slippery or covered with ice or snow.

Subd. 3. Stopping on Signal.—A person operating a motor vehicle shall, at request or on signal by putting up the hand, from a person riding, leading or driving a horse or horses or other draft animals, bring such motor vehicle immediately to a stop, and, if traveling in the opposite direction, remain stationary, so long as may be reasonable to allow such horse or animal to pass, and, if traveling in the same direction, use reasonable caution in thereafter passing such horse or animal; provided that, in case such horse or animal appears badly frightened or the person operating such motor vehicle is requested so to do, such person shall cause the motor of such vehicle to cease running so long as it shall be reasonably necessary to prevent accident and insure the safety of others.

Sec. 7. Speed Permitted.—No person shall operate a motor vehicle upon the public highways of this state recklessly or at a rate of speed greater than is reasonable and proper having regard to the width, traffic and use of the highway, or so as to endanger property, or the life or limb of any person.

Sec. 8. Subdivision 1. Registration of Chauffeurs.—Every person hereafter desiring to operate a motor vehicle as a chauffeur shall file in the office of the secretary of state, upon the payment of a registration fee of five dollars, a verified application for registration on a blank to be furnished by the secretary of state for that purpose containing (1) the name and residence address of the applicant and that he is competent to operate a motor vehicle and is over 18 years of age; (2) the trade name and motor power of the motor vehicle or vehicles he is competent to operate; (3) whether or not the applicant has been previously convicted of a violation of any of the provisions of this or any other motor vehicle law or ordinance, giving the date and place of such conviction and the provision or provisions of the law or ordinance violated; provided that if such chauffeur shall intend to operate only vehicles used solely for commercial purposes, he shall so certify in such application and shall pay a registration fee of two dollars.

Subd. 2. Chauffeur's Registration Book; List to Be Furnished County Clerks.—Upon the receipt of such an application, the secretary of state shall thereupon file the same in his office, assign the applicant a number and register him in a book or index which shall be kept in the same manner as the book or index for the registration of motor vehicles. The secretary of state shall also furnish to the clerk of every county of the state within sixty days after this act takes effect and once each month thereafter, a full and accurate list of chauffeurs so registered, with their addresses and the numbers assigned to each, in the same manner as provided in section two with reference to registered motor vehicles. Such lists shall be filed by such county clerks and be kept as public records, open to inspection during reasonable business hours.

Subd. 3. Chauffeur's Badge.—The secretary of state shall forthwith upon registering such chauffeur, and without other fee, issue and deliver to him a badge of aluminum or other suitable metal, which shall be oval in form with its greater diameter not more than two inches, upon which shall be stamped the words "Registered Chauffeur Number; State of" with the number inserted therein. This badge shall thereafter be worn by such chauffeur, pinned upon his clothing in a conspicuous place, at all times while he is operating a motor vehicle upon the public highways of this state. In the event of the loss, mutilation or destruction of a chauffeur's badge, such chauffeur may obtain from the secretary of state a duplicate thereof upon filing in the office of the secretary of state an affidavit showing the fact and the payment of a fee of one dollar.

Subd. 4. Fictitious Badge.—No chauffeur, having registered as hereinbefore provided, shall voluntarily permit any other person to wear his badge; nor shall any person, while operating a motor vehicle upon the public highways of this state, wear a chauffeur's badge belonging to another person, or a fictitious chauffeur's badge.

Subd. 5. Unregistered Chauffeurs Cannot Drive Motor Vehicles.—No person shall operate or drive a motor vehicle as a chauffeur, upon the public highways of this state after thirty days after this act takes effect, unless such person shall have complied in all respects with the requirement of this section, provided, however, that a non-resident chauffeur, who has registered under the provisions of the law of the state of his residence which are substantially similar to the provisions of this section, shall be exempt from registration under this section; and provided further

he shall wear the badge assigned to him in the state of his residence in the manner provided in subdivision three of this section.

Sec. 9. Local Ordinances Prohibited.—Except as herein otherwise provided, local authorities shall have no power to pass, enforce or maintain any ordinance, rule or regulation requiring from any owner or chauffeur to whom this act is applicable, any tax, license or permit for the use of the public highways, or excluding any such owner or chauffeur from the free use of such public highways, or in any other way respecting motor vehicles or their speed upon or use of the public highways; and no ordinance, rule or regulation contrary to the provisions of this act, now in force or hereafter enacted, shall have any effect; provided however, that the powers given to local authorities to regulate vehicles offered to the public for hire, and processions, assemblages, or parades in the streets or public places, and all ordinances, rules and regulations which may have been, or which may be enacted in pursuance of such powers shall remain in full force and effect; and, provided, further, that local authorities may set aside for a given time a specified public highway for speed contests or races, to be conducted under proper restrictions for the safety of the public, and provided further, that local authorities may exclude motor vehicles from any cemetery or grounds used for the burial of the dead.

Sec. 10. Subdivision 1. Penalty for Violations of Sections Two, Three, Four, Five and Six.—The violation of any of the provisions of sections two, three, four, five and six of this act shall be punishable by a fine not exceeding fifty dollars.

Subd. 2. Penalty for Violations of Section Seven.—The violation of any of the provisions of section seven of this act shall be deemed a misdemeanor punishable by a fine not exceeding two hundred and fifty dollars for a first offense and by a fine not exceeding five hundred dollars or imprisonment for not more than six months or both for a second or subsequent offense; but nothing herein shall prevent the indictment of a person so violating under any other law.

Subd. 3. Penalties for Violations of Section Eight.—The violation of any of the provisions of section eight of this act shall be punishable by a fine not exceeding fifty dollars or the suspension of the right to operate a motor vehicle as a registered chauffeur under the provisions of this act for a period not more than six months.

Subd. 4. Penalty for Tampering With or Using a Motor Vehicle Without Permission.—Any person using, operating, driving or tampering with a motor vehicle without the permission of the owner of such motor vehicle is guilty of a misdemeanor punishable by a fine not exceeding five hundred dollars and imprisonment for not more than six months, or both.

Subd. 5. Certifying Convictions to the Secretary of State.—Upon the conviction of any person for a violation of any of the provisions of this act, the magistrate, or other judicial officer before whom the proceedings are held, shall immediately certify the facts of the case, including the name and address of the offender, the character of the punishment and the amount of any fine imposed and paid, to the secretary of state, who shall enter the same either in the book or index of registered motor vehicles or in the book or index of registered chauffeurs as the case may be, opposite the name of the person so convicted, and in the case of any other person, in a book or index of offenders to be kept for such purpose, in alphabetical order. The secretary of state shall send notices of all convictions for violations of section seven of this act, with the names and addresses of the persons convicted and the judgments of the court on such convictions, to the clerk of every county in the state, who shall enter the same on the lists of registered motor vehicles or registered chauffeurs as the case may be, opposite the name of the person so convicted, or on a list of other offenders which he shall maintain in his office as a public record in the same manner as the lists of registered motor vehicles and registered chauffeurs, and on due application furnish copies of such lists to the magistrates or other judicial officers of his county before whom violations of the provisions of this act are triable. If any such convictions shall be reversed upon appeal therefrom, the person whose conviction has been so reversed may serve on the secretary of state a certified copy of the order of reversal, whereupon the secretary of state shall enter the same in the proper book or index in connection with the record of such conviction, and shall also notify each county clerk of the same.

Subd. 6. Release from Custody, Bail, et cetera.—In case any person shall be taken into custody because of a violation of any of the provisions of this act, he shall forthwith be taken before the nearest magistrate or justice of the peace in any city, village or county, or before any accessible captain, sergeant of police or acting captain or sergeant of police who shall have the powers of a magistrate or justice of the peace, and be entitled to an immediate hearing; and if such hearing cannot then be had, be released from custody on giving a bond or undertaking executed by a fidelity or surety company authorized to do business in this

state, such bond or undertaking to be in an amount not exceeding two hundred and fifty dollars for his appearance to answer for such violation at such time and place as shall then be indicated, or on giving his personal undertaking to appear to answer for such violation at such time and place as shall then be indicated, secured by the deposit of a sum not exceeding two hundred and fifty dollars, or in lieu thereof, in case the person taken into custody is the owner, by leaving the motor vehicle, or in case such person taken into custody is not the owner, by leaving the motor vehicle with a written consent given at the time by the owner who must be present, with such judicial officer; or in case such judicial officer is not accessible be forthwith released from custody on giving his name and address to the person making the arrest and depositing with such arresting officer the sum of two hundred and fifty dollars, or in lieu thereof, in case the person taken into custody is the owner, by leaving the motor vehicle, or in case such person taken into custody is not the owner, by leaving the motor vehicle with a written consent given at the time, by the owner, who must be present; provided that in such case, the officer making the arrest shall give a receipt in writing for such sum or vehicle deposited, and notify such person to appear before the most accessible magistrate, naming him, and specifying the place and the hour. In case such bond or undertaking shall not be given, or deposit made by an owner, or other person taken into custody, the provisions of law in reference to bail in cases of misdemeanor shall apply.

Subd. 7. Holding Defendant to Answer Where Magistrate Has Not Jurisdiction to Try Offender; Admitting to Bail.—In case the magistrate before whom any person shall be taken, charged with the violation of any provision of this act, shall not have jurisdiction to try the defendant, but shall hold the defendant to answer as provided by..... of the he shall admit such defendant to bail upon his giving a surety company's bond or undertaking to appear to answer for such violation at such time and place as shall then be indicated, or upon his giving his written undertaking in the form provided in of the in a sum equal to the maximum fine for the offense with which he is charged, or upon depositing such amount in cash with such magistrate who shall give a receipt in writing for such sum.

Subd. 8. Return of Bail.—Upon the person who has been taken into custody and given security or bail for his appearance presenting himself for trial, the judicial officer before whom such person is to be tried, shall, before the beginning of such trial, return to the person about to be tried, the property or money given as security or bail.

Sec. 11. Subdivision 1. Registration Fees to Be Paid Into State Treasury.—The registration fees provided herein shall be paid by the secretary of state into the state treasury. The legislature shall annually make appropriations of an amount sufficient to pay all proper expenses of this act.

Subd. 2. Certain Fines and Penalties; to Whom Paid.—All fines, penalties or forfeitures imposed or collected for a violation of any of the provisions of this act, or of any act in relation to the use of the public highways by motor vehicles now in force or hereafter passed, which are imposed or collected under the sentence or judgment of a court of special sessions, held or presided over by a justice of the peace, shall be paid over by such justice of the peace within ten days after receipt thereof to the treasurer of the state, with a statement accompanying the same, setting forth the action or proceeding in which such moneys were collected, the name and residence of the defendant, the nature of the offense and the fine, penalty or sentence imposed. On the first day of each month, or within ten days thereafter, such justice of the peace shall make and forward to the treasurer of the state a verified report of all criminal proceedings instituted or tried before him during the preceding calendar month for violations of any of the provisions of this act, or of any act in relation to the use of the public highways by motor vehicles, which report shall set forth the name and address of the defendants, the nature of the offenses and the fines and penalties collected or imposed by such justice; which reports shall be public records and open to inspection during reasonable business hours.

Subd. 3. Registration Fees and Fines to Be Used for the Maintenance of Public Highways.—All moneys paid into the state treasury pursuant to this act, except such as shall be appropriated under subdivision one of this section, shall there be maintained as a separate fund for the maintenance and repair of the improved roads of this state.

Sec. 12. Acts Repealed.—All acts or parts of acts inconsistent herewith or contrary hereto are hereby expressly repealed.

Sec. 13. Title of Act and When it Takes Effect.—This act shall be known as the "Motor Vehicle Law" and shall take effect the first day of nineteen hundred and; provided that applications for registration may be made and registration certificates and badges issued at any time within thirty days prior to such date.



Vol. XX Thursday, January 28, 1909 No. 4

THE CLASS JOURNAL COMPANY
Thirty-ninth Street Building, 231-241 West 39th St.
New York City

H. M. SWETLAND, President

EDITORIAL DEPARTMENT

A. G. BATCHELDER, Managing Editor
R. F. KELSEY, Associate Editor C. B. HAYWARD, Engineering Editor
W. F. BRADLEY, Foreign Representative

BUSINESS DEPARTMENT

A. B. SWETLAND, Business Manager
LOUIS R. SMITH, FRANK B. BARNETT
W. I. RALPH, 1085 Old South Building, Boston, Mass.
C. H. GURNETT, } 1200 Michigan Ave., Chicago, Ill.
F. W. VAN SICKLEN, }
H. H. GILL, Detroit, Mich.
T. B. VAN ALSTYNE, Philadelphia, Pa.

Cable Address - - - - - Autoland, New York
Long Distance Telephone - - - - - 2946 Bryant, New York

SUBSCRIPTION RATES:

United States and Mexico - - - - - One Year, \$3.00
Other Countries in Postal Union, including Canada - - - - - One Year, 5.00
To Subscribers—Do not send money by ordinary mail. Remit by Draft,
Post-Office or Express Money Order, or Register your letter.

FOREIGN SUBSCRIPTION AGENTS:

ENGLAND:—W. H. Smith & Sons, Ltd., 186 Strand, London, W. C., and all their
railroad bookstalls and agencies throughout Great Britain; also in Paris
at 248 Rue de Rivoli.
FRANCE:—L. Baudry de Saunier, offices of "Omnia," 20 Rue Duret, Avenue
de la Grande Armee, Paris.
GERMANY:—A. Seydel, Mohrenstrasse 9, Berlin.

Entered at New York, N. Y., as second-class matter.
The Automobile is a consolidation of The Automobile (monthly) and the Motor
Review (weekly), May, 1902, Dealer and Repairman (monthly), October, 1903
and the Automobile Magazine (monthly), July, 1907.

SHOWS WITH LESSER TRAPPINGS.

At this time of the year, after the closing of the second
big show and just prior to the opening of the next one,
a consideration of the show question is particularly appropriate.
This is a question that has aroused much
discussion and more comment abroad, particularly in
France, where the need for financial retrenchment was
more necessary. No solution has been reached, and in
the meantime the shows will continue to be held, but on
a more quiet, less expensive and more sane basis.

After it is all said and done, what does this elaborate
display of mirrors, bunting, myriads of electric lights,
bright fresh paint, and other show paraphernalia add to
the real merit of the car? What do all these trappings
help in the way of a better-running, longer-lived engine,
a simpler transmission, a better frame, or a more suitable
body? To answer this question is to answer, nothing,
nothing at all! So then we are forced to the unwelcome
but logical conclusion that money is spent in very large
amounts for no useful purpose. Therefore, in time, it
must cease, for the public, throwing the cold clear light
of reason upon it, can only arrive at the same conclusion,
that it is mostly useless and must go.

But in bringing manufacturer, selling agent, and buyer
together for mutual benefits, the show serves some purpose.
The objections, then, are founded only upon the
basis of needless expenditures. Remove these and the

objections are removed. What will be left then? The
show of the future, robbed of all glitter and glamour, separated
from all idea of display, simply a clean, clear exposition
of the merits of the various products in the
least expensive way. This then is the simple and sane
show which manufacturers, sales agents, and buyers will
welcome equally, for all will profit by it. Of course there
should be some relieving of the monotony of an undecorated
amphitheater, but now 'tis too elaborate for the
necessities of the occasion.



THE CONTROL OF SPEED RACING.

It would appear that some of the manufacturers and
importers still believe in the advertising value of high-
speed automobile racing. It would also seem possible
that the A. A. A. in relegating this branch of competition
to such a secondary position as it has may have taken
action which was slightly premature, in view of the un-
questioned demand for a fairly liberal continuance, for
at least another year, of speed contests. If upon a re-
survey of the situation evidence is plentiful to the effect
that high-speed competition still requires a considerable
amount of attention, it is a matter of wisdom that the
A. A. A. should again place this form of the sport in
the hands of a board giving it entire attention. But at
the same time this board could well be one composed
for the most part of manufacturers interested in racing,
and this board might also be given authority to select its
own chairman and secretary. Make membership on it
open to any manufacturer who would agree in advance
to compete in one or more of the year's big events.

In order to convince the public that the acts of this
board were subject to amendment, and, if necessary,
annulment, a disinterested board of appeals could be
established, for the purpose of passing upon any complaints
that may arise in the conduct of the sport.

There is no logical reason whatever for any "war"
over the control of the sport, for such a proceeding would
be detrimental all around, and this would prove as disastrous
as it would be costly and utterly unnecessary.
There must be government, and racing should be one of
the A. A. A. departments, even though it might be conducted
on different lines in the future than in the past.
Conditions change, and unquestionably conditions have
changed in relation to high-speed racing. Common sense
and a get-together program should be the outcome.



THE CALL FOR UNIFORM AUTO LAWS.

What seems to be a promising beginning in the direction
of uniform automobile laws has been made through the instrumentality
of Governor Hughes of New York State,
which beginning is told in this issue in the presentation
on another page of the first draft of a law prepared and
being considered by the Commissioners on Uniform State
Laws of New York, New Jersey and Connecticut. While
this measure may be more or less modified before it finds
permanent lodgment on the statute books, the chances are
not unlikely that in slightly revised form it will become a
reality in the States mentioned and in other common-
wealths where there is a desire to treat fairly with those
automobilists who are deserving of just consideration in
the framing of the law.

THE SENATE OF A GREAT COUNTRY!

WASHINGTON, D. C., Jan. 24.—Because the item read "for the purchase of a horse and carriage, or other vehicle," the United States Senate has refused to sanction an appropriation for furnishing the Speaker of the House of Representatives with carriage service during his official term. In rejecting the item several senators got into a very heated argument about automobiles, Senator Bailey, of Texas, and Senator Bacon, of Georgia, being particularly caustic in their arraignment of the automobile, while Senator Warren, of Wyoming, warmly commended it. Senator Warren called attention to the fact that on his big ranch in Wyoming automobiles were almost indispensable in rounding up lost cattle, and because of their speed and adaptability they were far superior to horses for this purpose.

Senator Bailey tearfully told the Senate that the automobile was an abomination and that its use on the public highways should be curtailed, if not abolished. The introduction of automobiles into the government service, he said, made it appear that the government was trying to drive the horse, one of the farmer's mainstays, out of business. Senator Warren responded to this by saying that while the use of automobiles was daily increasing by leaps and bounds, the prices of horses in the market had not been lowered.

Senator Bacon, while agreeing with everything his Texas colleague had said about the automobile, stated that Congress should not stand in the way of progress. The automobile, he said, had apparently come to stay, and while he was opposed to them on general principles, still if they were found efficient the government should adopt them wherever practicable.

The appropriation was finally voted down on the ground that it was unwise to provide government officials with vehicles at the public expense. It should be understood that this does not apply in the case of the President of the United States, to whom is given an appropriation every year of \$25,000 for the purchase of horses and the maintenance of the White House stables.

While this debate was in progress in the Senate, the House was devoting some time to the consideration of the item of \$12,000 in the urgent deficiency bill for the purchase and maintenance of two automobiles for President-elect Taft. Chairman Tawney, of the Appropriation Committee, informed the House that the item was included in the bill at the express wish of Judge Taft, who desired to replace the White House horses and carriages with the more modern mode of locomotion. Recognizing the utility of the automobile, the House passed the item without question. The Senate Committee on Appropriations, however, killed the item in reporting the bill to the Senate. There is reason to believe, however, that a way will eventually be found to enable Judge Taft to carry out his pet idea of having the automobile as the official White House conveyance.

MOTOR SPEEDWAY WILL BE BUILT.

INDIANAPOLIS, IND., Jan. 25.—Plans for the motor speedway have been completed and construction will start February 15 with the understanding that it is to be completed by May 15. It is the intention to hold the first events on the track some time in June. The outer track is to be oval and will be two miles in circumference with loops winding toward the center, making the whole track five miles long. It will be twenty-five feet wide except at the turns, where it will be thirty-five feet wide, well banked, to allow high speed.

To build the track and promote events the Indianapolis Motor Speedway Co. has been organized with \$200,000 capital, with the following officers: President, Carl G. Fisher, president of the Prest-O-Lite Company and treasurer of the Fisher Automobile Co.; vice-president, A. C. Newby, secretary and treasurer of the National Motor Vehicle Co.; second vice-president, F. H. Wheeler, of Wheeler & Schebler, carbureter manufacturers; and secretary and treasurer, James A. Allison, secretary-treasurer of the Prest-O-Lite Company. It is understood that men prominent in automobile circles over the country have subscribed for the stock.

The company has purchased 320 acres of land on a flat plateau about three miles northwest of the center of the city.

LATEST IDEAS CONCERNING BRIARCLIFF.

In deciding upon the rules for a stock chassis race difficulties are always encountered, and it appears that the Manufacturers' Contest Committee is having the usual trouble in trying to formulate regulations for the holding of the Briarcliff Trophy race that will be generally satisfactory. Three meetings have now been held in the course of six weeks, and three radically different sets of rules have been promulgated, the last practically reverting to the original regulations under which the race was run in the Spring of 1908, with the very important difference, however, that it is proposed to eliminate the stock chassis feature altogether. The last meeting was held at the A. C. A. on Monday of the present week and resulted in the increase of the bore limit to 5 3-4 inches, which is the equivalent of last year's limitation that the total piston area of a four-cylinder motor should not exceed 103.87 square inches. But coincident with this concession to those prospective entrants who built large motors for last year's event, all restrictions on the stroke and weight have been done away with, placing the contest on exactly the same plane as the Vanderbilt race or the Grand Prize of the A. C. A. and entirely eliminating its stock features. These changes, however, are subject to the approval of the donor of the cup, W. W. Law, and they will be submitted to him before being officially adopted.

That the stock car idea was not killed without at least one defender rising in the attempt to save it, is evident from the protest of George H. Strout, representing the Apperson interests at Monday's meeting. While the fact that the Apperson Brothers Company had already gone to the expense of making patterns conforming to the rules previously adopted would not cause them to lose interest in the race, even though the new rules made the patterns worthless, Mr. Strout strongly contended that the engine should be such as to permit the manufacturer to turn it to some commercial use as a type for the following year. The day of the motor with a 5 3-4-inch bore and an exaggerated stroke, as a stock proposition, was past, asserted Mr. Strout, and he accordingly tried to have the conditions fixed so as to place a limit on the stroke, or to have a piston displacement limit set that would not permit engines with a stroke greater than 6 inches. He was, however, overruled on both points. This naturally carries with it the elision of the "ten similar cars" clause of last year's regulations.

QUAKERS DON'T LIKE THE DECISION.

PHILADELPHIA, Jan. 25.—Basing its decision on the absence of any rule governing the case in the conditions of the Quaker City Motor Club's New Year's endurance run, and on the claim that permission to unload passengers in slippery places where traction could not be obtained had been verbally granted by one of the club officials, Chairman Frank B. Hower, of the A. A. A. Contest Committee, to-day sent a communication to President P. D. Folwell, of the Q. C. M. C., sustaining the protests of the entrants of Premier car (No. 21), Ray MacNamara driver, which had been disqualified for disembarking its passengers in the effort to reach the top of ice-covered Grant's Despair on the second day of the contest.

As a result of the recognition of the Premier claims the Quakers are fighting mad. They say the A. A. A. has no organized set of rules governing endurance runs, and in such absence the club formulated a set of rules of its own which the contestants were bound to live up to, and that the A. A. A. had, therefore, no jurisdiction in the matter; that even with its disqualification removed, the Premier can finish no higher than fourth place, owing to its accumulation of checkers' and observers' penalties; that the Matheson people have the cup and will doubtless keep it; and, finally, that if necessary to the upholding of its right to formulate and carry out its own rules (in the absence of any national regulations) it shall be found advisable to break away from the A. A. A., the club may even resort to such an extreme measure rather than stultify itself in the eyes of the motoring world. Meanwhile the Quakers have formally notified

Frederick H. Elliott, the A. A. A. secretary, that they are preparing an appeal to the national body's executive board, the basis of which will be that Chairman Hower's committee has no jurisdiction in the matter.

W. K. VANDERBILT, JR., GOES TO EUROPE.

William K. Vanderbilt, Jr., donor of the famous cup and president of the Long Island Motor Parkway, sailed for Europe on Saturday last for a more or less extended vacation abroad. While various rumors have been current anent the recent Vanderbilt Cup race, the latest news is to the effect that the bills in connection with that affair are now being taken care of by the Parkway Company, which in reality assumed the obligations in connection with the race. This came about because the Nassau County authorities refused to accept any bond except that of the Parkway Company, which owned real estate in the county.

The Parkway plans for the future seem to be somewhat in doubt, but the indications are that ultimately work will be resumed. Nothing can be prophesied at this time as to any 1909 race for the Vanderbilt Cup, but it is hardly probable that this famous trophy will be allowed to drop out of sight.

FLORIDA BEACH RACES, MARCH 23 TO 26.

According to "Senator" W. J. Morgan, who has been connected with the Florida race meets for some years and will again manage this year's meeting, the indications are that March 23 to 26, inclusive, will see a successful program of events. F. D. Stidham, who is in Florida looking over the ground, has wired that the Florida East Coast Automobile Association has succeeded in raising sufficient money to insure the success of the meet. The name of Charles G. Burgoyne, of New York, has been added to the list of contributors with a donation of \$500, and this, together with the other offers of prizes, either in the form of money or plate, makes certain that each event will be worth competing for. The majority of the races will be for short distances, with the exception of the 100-mile race for the \$2,000 Minneapolis cup and the 200-mile stock car event, with \$1,000 in cash prizes, as well as the trophy.

EFFORTS TO FORM NEW RACING BODY.

During the Garden show several meetings were held by representatives of several American firms and importers, looking forward to the formation of a new body to look after high speed racing participated in by those represented. Nothing definite seems to have been decided upon, but another meeting is called to take place during the Chicago show, at which time something more tangible, it is asserted, will be forthcoming. The situation is somewhat confusing, some believing that the A. A. A. has made a mistake in involving high speed racing with touring and other similar contests, while others contend that this arrangement should be tried at least for the present year. Indications are that those who supply the entries are inclined to have something to say in the conduct of this branch of the sport.

HART O. BERG ARRIVES IN AMERICA.

Hart O. Berg, business partner of the Wright Brothers, arrived Tuesday on the *Kaiser Wilhelm der Grosse*. He is most enthusiastic about the aeroplane outlook abroad, and states that the Wright brothers have made an unqualified success.

It is not probable that Wilbur Wright will compete in the Monaco aeroplane races. He hopes to conclude his present work in Southern France in time to return to America early in June.

SUIT SETTLED OUT OF COURT.

HARTFORD, CONN., Jan. 25.—The suit of L. D. Parker against the Hartford Rubber Company has been settled out of court. The suit involved a five-year contract and letters patent, with salary figures of \$35,000 a year.

TIRE COMPANIES HOLD MEETINGS.

AKRON, O., Jan. 23.—At the annual meeting of the B. F. Goodrich Company the old board of directors and officers were elected. The directors are George W. Crouse, George T. Perkins, B. G. Work, Frank H. Mason, Elmer Shaw, C. C. Goodrich, and H. E. Raymond. The officers chosen by the directors are as follows: President, B. G. Work; chairman of the board of directors, Col. George T. Perkins; first vice-president, Frank H. Mason; second vice-president, H. E. Raymond; secretary, Charles B. Raymond; treasurer, W. A. Folger. The reports of the officers showed one of the best years in the company's business, and an especial growth in the automobile tire department. Big additions to the plant are being made. One of the changes in the managerial department is that of W. E. Hemenover being made assistant general superintendent to succeed H. E. Joy, who was advanced to succeed C. C. Goodrich, resigned, as general superintendent. Hemenover is a comparatively new man in the plant, coming from St. Louis four years ago to be manager of the boot and shoe department.

At the annual meeting of the Swinehart Tire & Rubber Company the following directors were elected: J. A. Swinehart, B. C. Swinehart, C. O. Baughman, J. W. Rock, W. S. Frank and M. S. Rudgers. The directors elected officers as follows: President, J. A. Swinehart; vice-president, B. C. Swinehart; secretary and treasurer, C. O. Baughman. According to reports of the officers, the output of the plant will be doubled this year, although no definite action was taken at the meeting to increase the capacity of the plant.

The annual meeting of the Mansfield Rubber Company, which is just starting a plant to manufacture tires and casings, resulted in the stockholders naming F. A. Wilcox, C. H. Walters, L. Hautzenroeder, H. Homberger, F. M. Bushnell, and W. H. Bissman as directors. F. A. Wilcox was elected president and general manager; C. H. Walters, vice-president and superintendent; F. C. Walters, secretary; F. M. Bushnell, treasurer. The business being booked indicates that the plant will be kept busy from the start. Already three car loads of machinery have been installed, and the plant is expected to start by March 1.

THE AUTOMOBILE TRADE DIRECTORY.

For its first quarterly issue of 1909 "The Automobile Trade Directory" has a most complete list of all concerns interested in any way in the automobile industry, which means that the book is fat and prolific of facts. Its 500 pages, which is an increase of 60 pages over the previous issue, include a complete list of the manufacturers of all kinds of automobiles, motorcycles, motor boats, and parts and accessories; in fact, anything from a cotter pin to a complete chassis. There is also a complete list of all makers of machinery tools and equipment for factories, garages, and repair shops. The indices to these classifications require ten pages, two columns to the page, and covers some 2,000 articles. There are also 65 pages of valuable data and tables for engineers, which are alone worth the full price of the volume, including as they do all features of design of engines, clutches, bearings, and chains, together with such additional amplifactory material on weights and measures, physical properties of materials, wheel, tire, and rim dimensions as would be useful and necessary. "The Automobile Trade Directory" is issued by the Class Journal Company at 239 West Thirty-ninth Street, New York City.

CORBIN PLANT IS RUSHED WITH ORDERS.

NEW BRITAIN, CONN., Jan. 25.—An enormous demand for Corbin cars is reported by the Corbin Motor Vehicle Corporation, and in the near future the plant will have to begin running day and night in order to fill the orders which were booked before and during the recent Garden show. A large addition to the working force has been made, and it is stated that the motor vehicle department of the Corbin Corporation will be continued as heretofore, though various rumors have recently embodied statements to the contrary.

OREGON BUYING AUTOS, WANTS SHOW.

PORTLAND, ORE., Jan. 25.—Speaking of progress, some of the far Western cities have made such great strides in the past few years that they hardly dare to tell of it, for it will not be believed. Thus, Portland, which in 1900 had a population of 91,000, has to-day an increase of 200 per cent. to add to those figures. In the line of automobiles the increase has been more rapid than that, and the city hopes to have the greatest number of machines in relation to its population of any city in the United States. The figures on this are of absorbing interest to those interested in statistics.

Six years ago there were not more than 20 automobiles here. The following year this jumped to 45, an increase of 125 per cent. in one year. The year after that the good work was continued, a rise of 100 per cent. being chronicled. As another twelve-month rolled around the figures chalked up were 227 per cent., 295 machines total; 1907 showed these at 600 machines, a trifling increase of 107 per cent, while the figures for the past year reach to 1,100. While this is only 83 per cent. more than 1907, it represents an increase over 1903 of no less than the stupendous total of 5,400 per cent.

So, with an increase in interest of that sort, an automobile show came next in order, and the first annual Automobile Show, given under the auspices of the Portland Automobile Club, will be held in the Armory from March 8 to 14. This show will be to the Pacific Northwest what the New York show is to the East and Chicago is to the Middle West.

A. C. OF PHILADELPHIA POSTING SIGNS.

PHILADELPHIA, Jan. 11.—Snow and ice do not curtail the activities of the Automobile Club of Philadelphia on its chosen line. During the month of December, 22 mileage and 11 direction signs were posted on the Philadelphia-Gettysburg route, and the Routes, Maps and Tours committee announces that it is preparing to publish the result of its last eighteen months' work in book form; these books will not only be distributed to members, but will be placed on sale for the benefit of the general motoring public. As they include data for all the well-traveled roads running out of Philadelphia, extending to Western Pennsylvania, New Jersey, and even as far as New England, these routes will prove valuable to the automobile tourist.

S. Boyer Davis, club counsel, is rounding up all A. C. of Philadelphia members, who have suffered from applications of Jersey justice during the past six months, hoping in this way to discover what has become of numerous fines which have been imposed by certain justices in that State, but which have as yet failed to reach the treasury at Trenton, as the law requires. The investigation will be pushed with vigor.

JERSEY CLUB DATE FOR ANNUAL BANQUET.

NEWARK, N. J., Jan. 25.—It has been decided by the special committee appointed to manage the annual banquet of the New Jersey Automobile and Motor Club, that the event shall be held in Krueger's Auditorium, Thursday evening, March 18. The committee of arrangements consists of H. D. Bowman, chairman; A. B. Le Massena, James R. English, W. C. Crosby, J. H. Wood, W. S. Sheppard, George Simonds, H. A. Bonnell, G. O. Groebe, C. W. Baker and Albert Schurr.

INTERESTING LECTURES AT THE A. C. A.

Following a special meeting of the club on Tuesday evening at the Automobile Club of America two interesting lectures were given, one by Roger B. Whitman, whose subject was, "The Magneto as a Source of Current for High Tension Ignition Systems," and the other by Henry Cave, who gave "A Demonstration of the Autogenous Welding as Applied to the Manufacture and Repair of Automobiles." The attendance was excellent.

POPE-TOLEDO TO BE APPERSON-TOLEDO.

TOLEDO, O., Jan. 25.—After many rumors to the effect that the plant of the Pope Motor Car Company had been sold to various purchasers, the announcement that it has been transferred to new owners is now made definitely. A syndicate of capitalists, headed by Richard D. Apperson, vice-president of the American National Bank, of Lynchburg, Va., has acquired control, and will shortly begin to operate the plant at its full capacity.

The company will be known as the Apperson-Toledo Motor Car Company, and its product will also be known as the Apperson-Toledo car, these changes in name being the only ones occasioned by the new management. The company has been operating on a reduced scale during the two years it has been in the hands of a receiver, and in that time Harold Pope, one of the receivers, has managed to liquidate a large part of the outstanding liabilities.

The similarity of names at first gave rise to the impression that the purchasers were the Apperson Brothers, of Kokomo, Ind., and that their intention was to consolidate the two plants. The new purchaser of the plant, however, cannot claim any relationship or connection with the pioneer automobile builders, and stated that the plant was not acquired with a view to any consolidation.

MAXWELL-BRISCOE MOTOR CLUB ORGANIZED.

Seldom has any automobiling organization come into existence with such an impressive list of charter members as that of the Maxwell-Briscoe Motor Club, for when the latter sprung into being as the result of the meeting held in connection with the annual reunion of Maxwell supporters at the Hotel Manhattan during the Palace show, the new club had no less than 349 members. The officers are:

President, H. A. Hover, Spokane, Wash.; first vice-president, Hon. P. T. Barlow, New York; second vice-president, J. D. Schofield, Dallas, Tex.; treasurer, H. B. Worthen, Brooklyn; secretary, Ernest Coler, New York. The directorate is composed of the foregoing officers, with Frank Bropst, New York, and Dr. F. J. Spargur, Cleveland, O.

There is also a woman's division, headed by Mrs. J. R. Ramsey, Hackensack, N. J.; first vice-president, Mrs. Lillian Gillespie, Poughkeepsie, N. Y.; second vice-president, Mrs. E. P. Gresh, Norristown, Pa.; secretary, Mrs. L. C. Norton, Highstown, N. J.

From the fact that the officers hail from all parts of the country, it will be seen that the club is to be truly national in its scope. Mr. Hover is soon to renew his round-the-world trip in a Maxwell car.

PREMIER MAKING MORE CENTURIES.

Not satisfied with its already creditable record of something like 15,000 miles, the Premier 100-Century car is again on the road between New York and Chicago, driven by Ray McNamara, with J. P. Slack in the other seat. This car with the same driver started its famous career during the Summer, when it competed in the Glidden contest and afterward continued to make at least 100 miles a day for 100 days, ending up with over 12,000 miles to the good. After passing a severe examination in Chicago for mechanical troubles, of which none was reported, the car has been on the road almost continuously ever since, making trips from city to city or taking part in various endurance contests. In December it was driven East and took part in the two days' endurance run of the Quaker City Motor Club from Philadelphia to Wilkes-Barre and return, finishing with a perfect mechanical score.

In order to be on hand for the opening of the Chicago show, opening next week Saturday, the car left Times Square Monday morning well prepared to battle with all sorts of road conditions. The company wishes to demonstrate that after going through the severest of tests to which this car has been put, and without any vital repairs of any sort, it is still in condition to make the trip to Chicago over the Winter roads.

A STRIKING EXAMPLE OF THE NEW FIRE WAGONS

ONE of the most noticeable, if not the most noticeable, feature of the commercial situation is that in respect to fire fighting apparatus. The progress made in the past few years in this line simply cannot be overstated. This progress is perhaps of two kinds, the actual or physical progress shown in the wagons actually put out into service, and the moral progress not so well shown; in fact, it might almost be said to be hidden. As the latter is the real cause of the former, it will be best to speak of it first of all.

A few years ago the fire departments as a whole opposed the self-propelled wagons in every possible way, from the chiefs through the ranks down to the very lowest hostlers. Gradually through the involuntary progress of the pleasure cars in speed, refinement, capability, steadiness and reliability, but principally the last named, the firemen were won over. This movement gained in strength and spread upwards and outwards, until to-day all fire department men are enthusiastic in their praise of the work already done, and loud in their clamor for more and still more motor-propelled apparatus.

There have been a few companies awake to this movement, and they have carefully catered to the existing demands, until a large business has been built up in this line. Foremost among these manufacturers has been the Knox Automobile Company, of Springfield, Mass. This company has recently turned out a high-pressure hose wagon for New York City.

From the factory the wagon was taken to fire headquarters in Springfield and inspected by the Fire Commission and other fire officials. It was then brought over the road to the New York show, following which it was placed in active service.

Fire apparatus in New York City has considerably more to

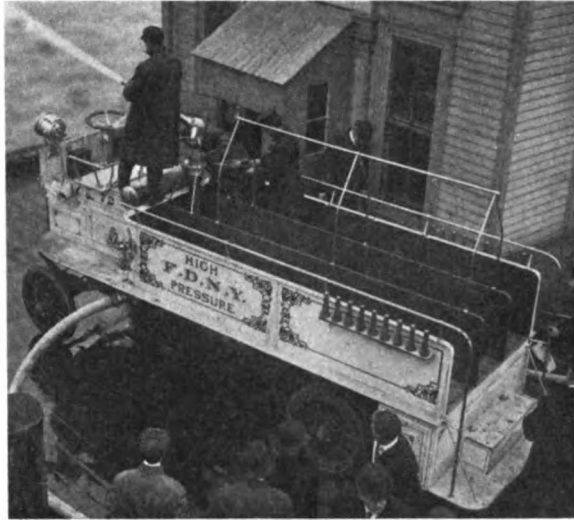

Trying Out the Knox Hose Wagon on a New York City Dock, Foot of Gansevoort Street.

contend with than has that of any other large city, consequently this truck is most characteristic of what heavy fire wagons must be. It is a combination hose wagon and water tower, this latter feature being a large iron pipe in the rear of the driver's seat, into which there are directed four pipes, with outlets and couplings on either side of the truck, just below the driver's seat. Four streams, when converged into the one pipe with a powerful nozzle, will furnish a stream with force enough to throw 25 feet higher than the most powerful water tower.

This wagon will see a different kind of service from the usual type of fire apparatus with motor power in that it will be constantly in action, the engine being required to drive the wagon from place to place and into different positions, accord-

ing to the progress of the fire and the necessity for the tower.

The chassis for this truck is the regular model 18, five-ton truck, with a maximum road speed of 12 miles per hour. The rated load capacity is 8,000 pounds; wheelbase, 149 inches; tread, 57 inches; tires, solid rubber, 36x4 inches front and 36x4 dual rear; front axle, four-inch I-beam; rear axle, 2½ inches square; Timken roller bearings for all road wheels; five-inch channel steel main frame, four-cylinder, water-cooled 60-horsepower engine, double ignition dry cells and magneto, selective type transmission, three speeds forward and one reverse, double chain drive, foot brake applies on countershaft and hand brake to hubs of rear wheels; semi-elliptic springs, three inches wide, length 40 inches front and 50 inches rear; DeDion system of lubrication from a well in the crank case.

The body of the wagon is known as an iron body, although the floor and partitions are of wood. It is 13 feet 8 inches long, 68 inches wide and 24 inches high. The inside of the wagon is so

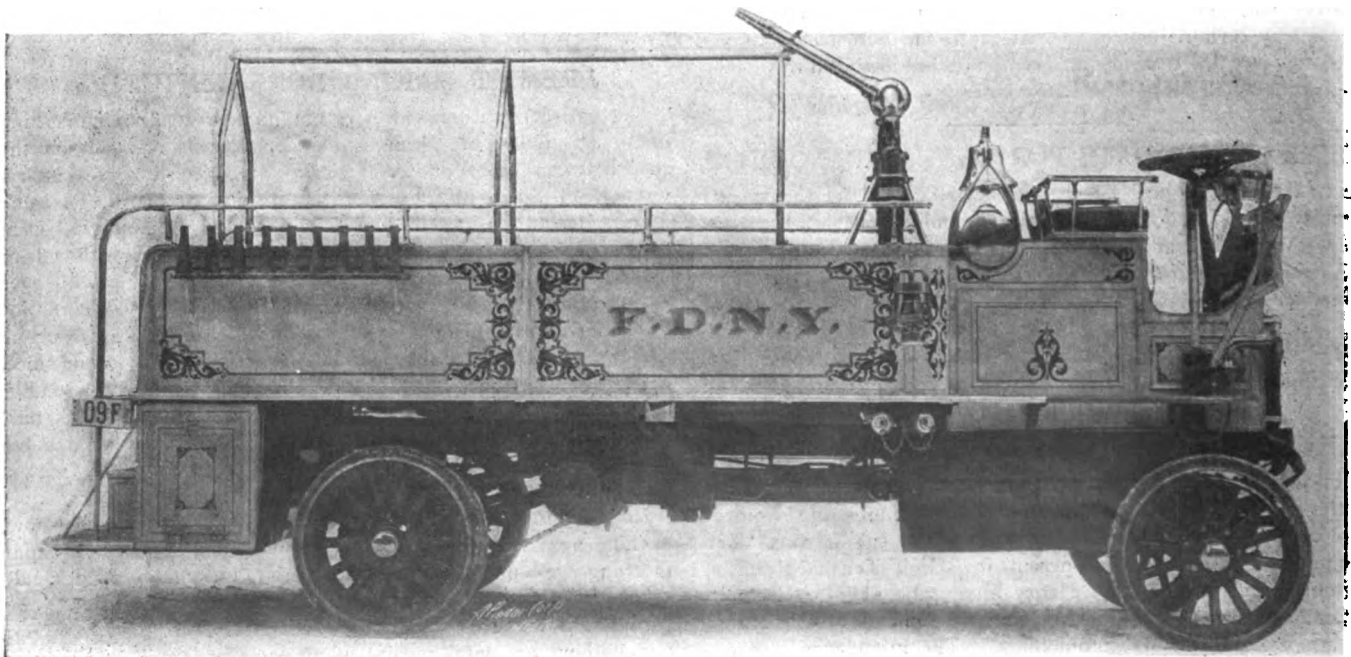

High-Pressure Hose Wagon Built for the Fire Department of New York City, by Knox Automobile Company.

divided that there are three compartments suitable for folding 350 feet of hose in each compartment, or 1,050 feet in all, the hose being three inches in diameter and extra heavy. The floor of the wagon is made of slate, with a space underneath for the circulation of air. Under the body of the wagon there is a tool box, and on each side and hanging from the rear are steps wide and long enough to accommodate many firemen.

There are brass and nickel plated railings on the seat and along the sides of the wagon, as well as one railing running the length of the wagon, through the center. A locomotive type of bell is swung between stanchions in the center of the wagon. Fastened to the driver's seat there are three tarpaulins for covering the hose, each being the width of the hose compartment.

The turret pipe, which is the most important part of the body, is located two feet from the driver's seat and in the center of the body. It is a four and a half inch iron pipe and high enough so that when the nozzle is attached the distance from the floor to the tip of the nozzle will be seven feet. Pipe connections extend from the sides of the wagon to the turret pipe and are

fitted with three-inch, three-way siamese connections. Four hose connections can be made, so that four streams of water will be thrown into the turret pipe, or if needed four siamese connections can be made to the regular number of connections in such a way as to allow eight streams of water to be turned into the turret pipe. The 18 nozzles that go with the wagon are in three sizes and are carried on holders, nine in a row on each side of the wagon. The running gear of the wagon is maroon, broad gold stripe and salmon colored fine line. The wagon body is white with red stripe and presents a fine appearance, the long body and wheel base giving it a very powerful look.

At the close of the Garden Show the vehicle was driven to the general shops of the fire department for official inspection and later from there to the testing ground at the foot of Gansevoort street. There, under the direction of Commissioner Whitney and Chief Croker, the fireboat *Thomas Willet* supplied it with two streams of water under 300 pounds pressure. The test, shown in the accompanying illustration, was very successful and doubtless other similar fire wagons will be added later.

EXPRESS SERVICE IMPROVED BY MOTOR TRUCKS

THROUGH express from the West now is delivered in New York City just twenty-four hours sooner than it was before the Adams Express Company placed a truck in night service. This truck, which is one of the fourteen Packard trucks used by the Adams company in the metropolitan district, runs between the Jersey City dock, garage and distributing station on West 47th Street, station on 124th Street and its Brooklyn depot. The service which it renders through the night allows the actual delivery of Western express packages one day in advance of the previous schedule.

This company was one of the first advocates of motor wagons. Its experience in motor traffic started with steam wagons, which were discarded in favor of electrics. A number of the latter are now used extensively in several cities. This work in the development of motor service has been due to a firm belief in the eventual superseding of horses for business hauling. The volume of business in New York and other large cities is increasing so rapidly that the old system will soon be rendered absolutely inadequate. Not only has the routine delivery and collection work on established routes become steadily greater, but more territory has to be covered, and this territory will continue to increase. Consequently, motor trucks hauling heavy loads over comparatively long distances will greatly increase efficiency and effect economy.

The recent installation of Packard three-ton trucks is obvi-

ously the beginning of an extensive installation of gasoline wagons in New York and other cities. The company's practice speaks particularly well of the Packard trucks, because of the eighteen installed, fourteen are Packards, either the ones just put into service or the smaller trucks which have been doing such good work that they will be continued. The express company has gone about the maintenance of its gasoline trucks in a thorough and practical manner. At 242 West 47th Street there is a special garage of concrete construction, with storage room, repair shop and a staff of mechanics, under the charge of a superintendent of garages, who directs the care of the trucks and plans their usage. Most of the drivers were broken in to the work by the Adams company and constitute a more carefully trained corps than is ordinarily encountered.

"VAN" TO MANAGE CHICAGO KNOX BRANCH.

CHICAGO, Jan. 26.—Arrangements have been consummated whereby N. H. Van Sicklen, well known throughout the industry and the former owner of "Motor Age," will take charge of the Chicago branch of the Knox Automobile Company. Mr. Van Sicklen will assume active charge February 1, and he is busy making extensive arrangements for Knox representation, to include both the pleasure and commercial vehicles manufactured by the company.



Two of the Fourteen Packard Trucks Now in Active Service for the Adams Express Company, in New York City.

GERMAN BEARINGS MAKER VISITS AMERICA.

One of the interested visitors to the Garden show last week was Ernst Sachs, technical head of the great German firm of Fichtel & Sachs, of Schweinfurt, Bavaria. Herr Sachs expressed himself as greatly impressed by the phenomenal growth of the automobile industry in America during the past few years, and remarked that, although the rapid increase in his own export business to this country had prepared him to find automobiles extensively used here, the reality amazed him. Both in its magnitude and in the high degree of excellence achieved by American designers, he pronounced the American automobile industry to have far surpassed anything he ever dreamed could be possible.

In view of the very extensive adoption by American automobile builders of the product of Fichtel & Sachs, it is interesting to note that this firm operates to-day the largest factory in the world devoted to the manufacture of ball bearings, their daily output of about 12,500 ball bearings of all types exceeding that of any other single manufacturer. Of the 20,000 souls making up the population of Schweinfurt, over 2,000 are employed in the F. & S. ball-bearing factory, and 800 in the allied factory where the steel balls are made. Some idea of the magnitude of the plant may be gathered from the fact that the bearing factory uses 1,750 horsepower and the ball factory 800 horsepower, and in the latter plant there are 2,000 machines for grinding balls. Of the total product of balls and bearings, about three-quarters is used outside of Germany—France, England and America being the largest foreign consumers.

Fichtel & Sachs are owners of some of the most valuable patents extant on the subject of ball bearings, including the basic Kouns patent on the side-entering slot, the Sachs patent on the diagonal side-entering slot, and the Blin patent covering the use of side-entering slots shallower than the ball paths. Under the Blin patent the balls are sprung in under pressure, and when once in never again touch the side slots. This permits practically the entire race to be filled with balls, and all F. & S. annular ball bearings are now made under this patent. It is understood that some questions which have arisen in connection with these patents have had something to do with Herr Sachs's visit.

FRANKLIN SALESMEN'S SEMI-ANNUAL.

SYRACUSE, N. Y., Jan. 25.—The traveling salesmen of the H. H. Franklin Manufacturing Company have just completed their semi-annual conference at the company's factory, reviewing conditions in the automobile trade for the past six months and discussing plans for more than a year ahead. There was a unanimity of belief that an enlarged prosperity would be shown during 1909, both in the manufacture and sale of cars and in practically every other line of business.

During the sessions the salesmen were addressed by Vice-President G. H. Stilwell, on "The Franklin Company's Position in the Association of Licensed Automobile Manufacturers"; by Treasurer H. B. Webb, on "The Season of 1908 from a Financial Viewpoint"; by Manager J. G. Barker, of the sundry department, on "Sundry Matters"; by Manager J. E. Walker, of the advertising department, on "What We Are Doing to Help Sales by Way of Advertising," and by Sales Manager F. R. Bump, on "Our Policy for 1910."

ROBBINS FOR CHICAGO OAKLAND BRANCH.

CHICAGO, Jan. 25.—A branch house has been established at 1725 Michigan Avenue, by the Centaur Motor Company, of Buffalo, general selling agents for the Oakland Motor Car Company, of Pontiac, Mich. This is the location formerly occupied by the Rainier Company. Arthur M. Robbins, formerly with the Aero-car Company, of New York, and later with the Rainier people of Chicago, will have charge of the new branch. Mr. Robbins is one of the pioneers in the automobile industry and is well known. This branch house will have full charge of the sale of Oakland cars in Chicago and immediate vicinity, as well as carrying a full supply of repair parts.

AUTOMOBILE TAKES TALLY-HO'S PLACE.

PHILADELPHIA, Jan. 25.—The next fortnight will witness a recrudescence of the old tally-ho and post-road days between this city and New York, only instead of the coach-and-four, with relays of horseflesh every ten or dozen miles, the vehicles to be used will be Acme touring cars, the enterprise being backed by the Acme Motor Car Company, of Reading, Pa. The Bellevue-Stratford Hotel, in this city, and the Waldorf-Astoria, in New York, will be the termini of the new line, and the round trip will be made in two days. It is proposed to begin operations with but one car, and add others as the increase of business renders it necessary. The fare for the round trip will be \$20. The scheme originated with President H. W. Sternbergh, of the Acme Company, who is very enthusiastic over the outlook.

W. H. BARNARD NOW HEADS IMPORTERS' SALON.

NEW YORK, Jan. 25.—At the annual stockholders' meeting of the Importers' Automobile Salon, held at the headquarters of the association in the Bryant Arcade Building to-day, W. H. Barnard, of the Delahaye Import Company, succeeded André Massenet, of the Panhard Company, as president. Mr. Massenet held that office during the past year, but declined a renomination, and Mr. Barnard, who served as vice-president last year, was unanimously elected.

The other officers chosen were: Vice-President, Paul Lacroix. Renault; treasurer, Walter C. Allen, De Dietrich; secretary, E. Rand Hollander, Fiat. Besides the officers the following were elected to serve on the board of directors: Harry Fosdick, Lancia; A. C. Andrade, Jr., Isotta, and Julian Block, C. G. V.

Walter C. Lee was reappointed general manager. Although the past year has been the most trying one that the importers have had, the report of the treasurer showed the association to be in excellent financial condition.

RENAULT LEADS THE FOREIGNERS.

NEW YORK CITY, Jan. 25.—To followers of the American automobile industry, import and export figures are always very interesting. This has been particularly true in the past year or two, so that the recently published figures of the Custom House are of more than passing interest. These figures show that twelve foreign makes of cars have been imported to the number of 735. These include one German, four Italian and seven French cars. The figures are:

Renault, 244; Fiat, 149; Panhard, 89; Mercedes, 89; Isotta, 40; Itala, 24; Hotchkiss, 22; DeDietrich, 19; Lancia, 18; C. G. V., 16; De Launay Belleville, 14; and Rochet Schneider, 11.

In noting the Renault's large lead over the others, it will be remembered that in 1907 this maker also led, but with a smaller number of cars, 214. So the past year shows, at least for this maker, a gain of 14 per cent. These figures also include taxicabs, of which a number have been brought in, particularly for service in this city, where the sloping bonnet of this leading French make is a familiar sight.



Renault with Berline Body, Now Popular in Paris.



Mrs. K. R. Otis, who Made a Notable Midwinter Trip from New York to Boston and Return, in Stearns Car.

News in General

Round-the-World Tourers in Republic Wreck.—H. A. Hover and wife, the transcontinental tourists from Spokane, Wash., reached the East coast after an uneventful trip and sailed on January 22 on the ill-fated *Republic*, which was wrecked. Nothing daunted, they will make a fresh start on another boat and pick up their car, which was forwarded on another steamer, on the other side. Their present destination is Algiers, where they will resume their trip around the world. They are making their trip in a four-cylinder 30 horse-power Maxwell touring car, with an equipment consisting of a tent and the necessary utensils for camping, as the countries where they are going are such that it will be necessary for them to pass many nights without shelter of any kind. In all, they have already traveled 7,000 miles in this country.

100,000 Miles on 1909 Warner Odometer.—The Warner Instrument Company's odometer for 1909 will show a season total of 100,000 miles instead of 10,000, as stated in our January 7 issue. In the past most speedometers for mileage recorders have shown only 10,000 miles, but letters received from many car users indi-

cate season mileage of 30,000 and 40,000 miles, thus necessitating a larger instrument. This new model, as well as all others, will have the new shaft and simplified drive. This is a pressed-steel, hand-riveted, hardened-shaft which will make but one-half the number of revolutions made in former instruments.

Tom Lynch's New Job.—The automobile owner will be insured a better tire by more thorough tests on the part of manufacturers, so it is a source of pleasure to chronicle the announcement that many makers are establishing a new department of tests to take care of this work. The latest announcement in this line comes from the Continental Caouchouc Company, which has placed the well-known automobile driver and racing man, Tom Lynch, in charge. Each style of tire will be tested out on a Lozier Briarcliff model, covering from 100 to 150 miles each day regardless of weather.

In Maryland, Not in Indiana.—In the January 14 issue of THE AUTOMOBILE it was stated that the Carter Motor Car Corporation's factory was located at Hyattville, Ind., whereas it is in reality located at Hyattsville, Md.

PERSONAL TRADE MENTION.

William F. Hurlbut, for several years manager of the New York branch of the Packard Company, and until recently president of the Garford Motor Car Company, of New York, recently resigned from the latter office to become connected with the New York representation of the E. R. Thomas Motor Company, of Buffalo. Mr. Hurlbut has just returned from an extended trip abroad. He is planning an active campaign in support of the Thomas interests.

Thomas J. Wetzel, who has been confined to his New York City home for an extended period by an attack of typhoid fever, was one of the visitors of the Garden show who received a very cordial welcome from his friends, as he was very seriously ill, and at one time his recovery was in doubt.

E. T. Birdsall, designer of the Selden car, and who has been chief engineer of the Selden Motor Vehicle Company, Rochester, N. Y., for the past two years, has severed his connection with the concern in question. Mr. Birdsall expects to make an announcement concerning his plans in the near future.

Lawrence C. Fuller, has been appointed general manager of the Philadelphia branch of the Chadwick Engineering Works, of Pottstown, Pa. Mr. Fuller is well known to the trade, having been with Thornton & Fuller, Simplex agents, and with the J. M. Quimby & Co., representatives.

V. M. Palmer, at one time connected with the Hagerstown plant of the Pope Manufacturing Company, has succeeded E. T. Birdsall as chief engineer of the Selden Motor Vehicle Company, Rochester, N. Y. Mr. Palmer entered upon the duties last week.

E. G. Mertens, with the Electric Vehicle Company as a salesman, has severed that connection and will go into business for himself. He has bought an interest in the Glens Falls Auto Company of Glens Falls, N. Y., and at a recent meeting was elected its vice-president.

Edwin B. Finch, formerly in the technical department of the Packard Motor Car Company, Detroit, has resigned and will be with the Chalmers-Detroit Company. He is well known in the trade having at one time manufactured cars.

V. A. Charles, former manager of the Rambler Boston branch, has accepted a similar position with the S. M. Supplies Company in Boston. This firm will open salesrooms at 22 Lincoln street and will have the Midland agency.

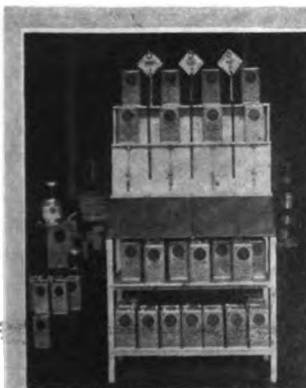

A. W. Harris Oil Company, Providence, R. I.

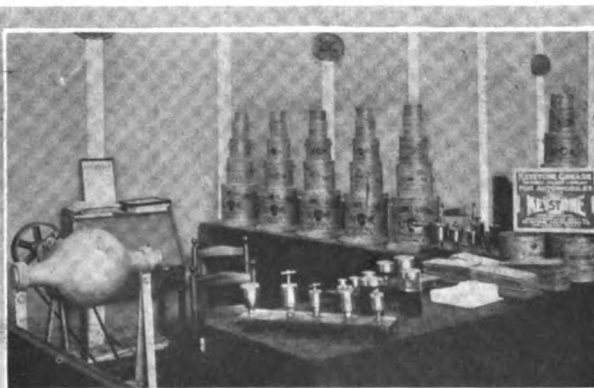

The Keystone Lubricating Company, Philadelphia, Pa.



Havoline Oil Company, New York City.

Three Prominent Lubricating Exhibitors Who Exploited Their Products in the Madison Square Garden Show.

ONE CONCERN'S PUBLICITY.

After a good car has emerged from the factory, it is a necessitated sequence that well directed publicity should proceed and follow in its wake. The proper use of the art of the printer comes pretty close to being a science, and there-



E. Ralph Estep.

in E. Ralph Estep, advertising manager of the Packard Motor Car Company, gives evidence of his past experience in the "Art Preservative." Estep usually participates in Packard performances of all kinds, and his material is usually right "off the bat," and apropos.

Recent issues from his department include several notable examples. In "Following the Confetti" are pictorially presented incidents in the journey of the Packard official press car on the Glidden tour of 1908. No better advertisement of this year's event could be utilized by the A. A. A. Contest Board than a distribution of this inviting and neatly bound pictorial tale.

"A Family Tour from Ocean to Ocean," by J. M. Murdock, is an account of the 1908 tour of the author and his family across the country in a Packard "30," wherein he expresses appreciation "of my Packard car for its wonderful stability, capability, and reliability."

"The Flight of the Thirty" is the story of an overland dash of 606 miles from Detroit to Chicago and back in the space of 20 hours 35 minutes. Sales Manager S. D. Waldon was the man at the wheel, but Fred Graves relates the story.

Another little pamphlet is devoted to the "Pittsburg to Philadelphia, 14 Hours 1 Minute" performance. Of course, the company issues a calendar, and this, too, is a work of art, with neat sketches of more or less Packard complexion.

NOW PIERCE ARROW MOTOR CO.

When the rumor was circulated at the show last week that Colonel Charles Clifton and all of his associates in the George N. Pierce Company, Buffalo, had resigned from that concern, it spread like wildfire, and as it received the smiling confirmation of Colonel Clifton himself, when he was approached on the subject, it was at first thought to be literally true. What actually did happen was the organization of the Pierce Arrow Motor Company, a corporation formed to take over the entire assets, good-will, and business of the George N. Pierce Company. There will be no change in the business and the officers remain the same, these being: President, George H. Birge; vice-president, Henry May; treasurer, Charles Clifton; secretary, Laurence H. Gardner; the directorate being comprised of the foregoing officers together with William B. Hoyt, so that the change is merely one of name.

In order to provide for the carrying on of the business of the company and to take care of future developments, the capitalization has been increased.

IN AND ABOUT THE AGENCIES.

American and Grout, Philadelphia.—A new company, the Stoyale Automobile

Company, has taken the agency for the American car, the territory being Eastern Pennsylvania, New Jersey, New York, Delaware and Maryland. In addition the Grout, made in New England, will be handled. The members of the firm are W. H. Stoyale and Louis Vogel, both well known in Philadelphia. The company has taken the large building at the southeast corner of Broad and Race streets.

Goodyear Tires on Pacific Coast.—The W. D. Newerf Rubber Company of Los Angeles, Pacific Coast agents for the Goodyear Company has completed arrangements to represent this company in British Columbia, Oregon, Washington, Idaho, Nevada, Arizona, Mexico and the Hawaiian Islands. In addition to having large stores in Los Angeles and San Francisco, branches will be established in Vancouver, B. C.; Seattle, Spokane Falls, Pasadena, City of Mexico and Honolulu.

Firestone Tires, Los Angeles, Cal.—A new direct branch has been opened by the Firestone Tire & Rubber Company at 957 South Main street, where the whole of Southern California will be cared for. G. C. Calbetzor, formerly Pacific Coast representative, and Frank R. Talbott, former assistant treasurer, the Akron factory, will have charge.

Benz, New York City.—One of the finest show rooms along that portion of the Great White Way known as Automobile Row, has been fitted up for and is now occupied by the Benz Auto Import Company of America. This is located at 1599-1601 Broadway, where a full line of Benz cars may be seen.

Post & Lester, New England.—Two new branch retail stores have been opened by the Post & Lester Company, Hartford, Conn., at 1085 Chapel street,



New Peerless New York Branch Will Be Imposing.

New Haven, Conn., and 125 Ridge street, Springfield, Mass. Both houses will handle auto accessories exclusively.

OBITUARY.

H. F. Kellogg, New England representative of Hoyt Electrical Instrument Works, Penacook, N. H., died at Newton, Mass., January 16. Mr. Kellogg was particularly well known in the industry, in which he had many friends, who will regret to learn of his death.

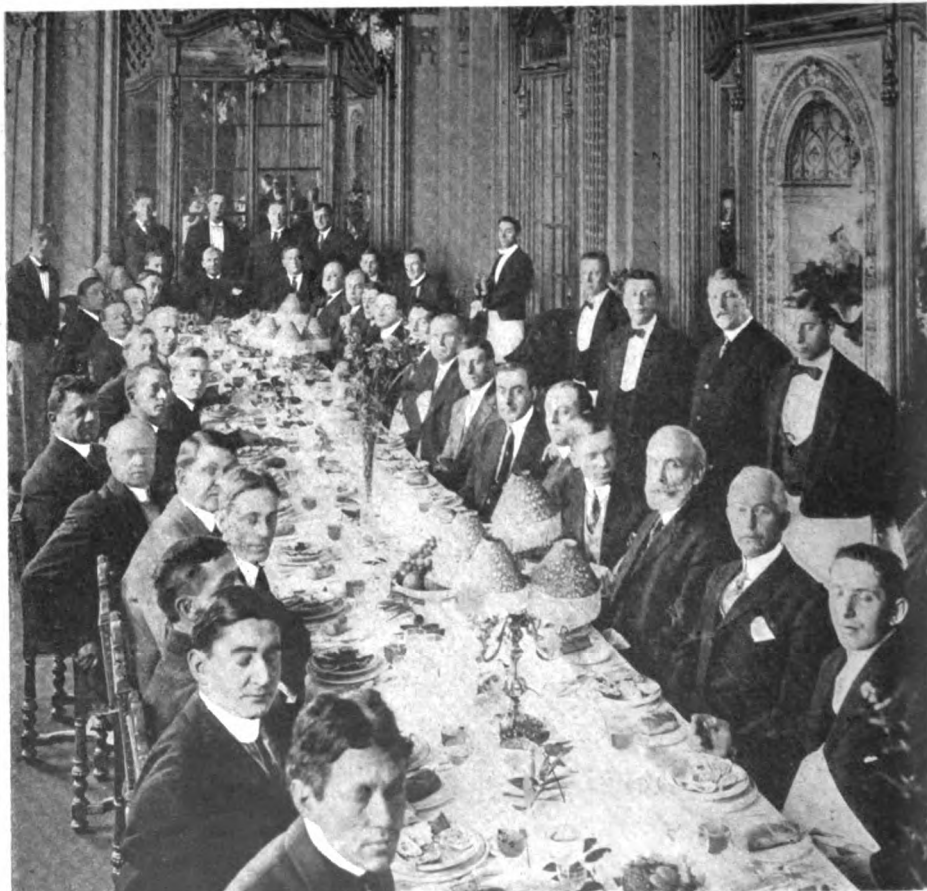

E. R. Thomas Motor Company's Luncheon to George B. Selden.

At this function E. R. Thomas presented to Mr. Selden the license plate which was carried round the world by the Thomas winner of that event.

THE AUTOMOBILE



Eighth Annual National Exhibition of the Chicago, C. N. A. M. February 6-13, 1909



CHICAGO, FEB. 4.—And now comes the real national automobile show of the country—that of the National Association of Automobile Manufacturers, held in the Coliseum and First Regiment Armory. Of course, S. A. Miles is the general manager of the show, the committee for which also includes A. L. Pope, chairman; Windsor T. White, Thomas Henderson, C. C. Hildebrand and W. E. Metzger—all pioneers of an unparalleled industry.



This national display—and Chicagoans are proud in their claim that it is the only event of its kind that is truly national—will eclipse its predecessors in number of exhibitors, variety of displays, and lavishness of decorative and lighting effects. Indications are that every record for attendance will be shattered, and ample preparations have been made for caring for the thousands, not only from Chicago but from all parts of the West, who will throng the two capacious buildings, which will be filled to the bursting point.



Given under N. A. A. M. auspices, every interest has worked in harmony for the success of the show. Every detail has received the careful attention of some member of the committee having such matters in charge. Everywhere has been in evidence the spirit of the West, the steady pulling together to achieve a common result, the swift mastering of details and rapid rounding of them into perfected form, the obliteration of discords and jealousies, and the placing of every exhibitor on an equal footing.

Scenes typical of the West, too, will be in evidence during the progress of the national show. Particularly marked, along this line, will be the opening of the doors of the show at 8 o'clock each morning to accommodate dealers from the West who prefer going direct to the show from the train and immediately begin business.



Another characteristically Western feature will be the presence of the farmers, coming from long distances and putting an end to the common error that the farmer is the implacable enemy of the motor-driven vehicle. The prosperity of the West is of all classes, and the farmer each year is taking up motor vehicles in increasing numbers.

All that has been accomplished here has been done in less than a decade, for the first Chicago show goes back only to 1900. The association now known as the National Association of Automobile Manufacturers, Inc., came into existence about ten years ago, in New York. Five years later came the trade dispute and the organization of both the Association of Licensed Automobile Manufacturers and of the American Motor Car Manufacturers Association, thus dividing the old association membership. Following this breach, really a trade quarrel, came the two New York shows, the Licensed association securing the Madison Square Garden, and the other organization taking up the Grand Central Palace show.

While New York has had her two shows annually, and because of the rivalry neither can fully claim really national characteristics, Chicago has remained neutral, knowing neither the "licensed" nor "unlicensed" maker, and inviting each to meet on common ground in the Coliseum and Armory, select exhibit space by lot, and stand in all respects equal. In this way Chicago holds for her show the features that make it truly national, and the marvellous growth since that first show in the Windy City testifies most eloquently to how public and manufacturers alike look upon it.

The first show in Chicago, in 1900, was promoted without reference to any association. The automobile manufacturers were few, exhibits consequently difficult to secure, yet, despite all obstacles, the show was held. From the standpoint of the managers it was not a financial success, but the exhibitors found in it something that proved almost a gold mine. Enthusiasm was aroused among agents, prospective buyers, and the public at large, and before the show closed its doors every exhibitor had applied for space in the show that was to be given the ensuing year.

The next year found the available space increased by using the Coliseum annex. In earlier days it had been considered essential that the cars be seen in motion, and to meet this demand a track eighteen feet wide encircled the building. The second year found the track, owing to the demands for space coupled with the opinions of the manufacturers that it was not necessary, abandoned for all time and in its place two great machines had been erected on which cars might be driven at highest speed while a dial indicated the distance traveled.

It was during this show, too, that the National Association of Automobile Manufacturers, Inc., first appeared and every show since that time has been given under the auspices of that organization. This second show, considering the condition of the automobile industry at that time, has never been excelled. It demonstrated the absolute need of a Western exhibit, regardless of what shows New York might offer, and since that time the history of the Chicago automobile show is the record of steady, well-founded growth.

For the third show the Coliseum annex was added and the second floor of the annex had to be pressed into service for the fourth show. When the fifth was given, in order to accommodate exhibitors it became necessary to not only add the First Regiment Armory but to floor over the seating space in the Coliseum gallery as well, and even then the demand could not be fully met.

The sixth show managed with the same quarters, but the seventh found added the basement of the Coliseum annex and the Seventh Regiment Armory for commercial vehicles. This gave a combined floor space of 150,000 square feet.

This year's show finds 323 exhibitors placed, and about one hundred of them are showing an average of three automobiles each. A feature of particular interest promises to be the motor-cycle display, twenty-one makers having secured space.

In decorations the 1909 show will eclipse its predecessors,

lavish as they have been. The success of the papier-mâché work last year justified its use this year again, supplemented by staff. The 1909 show will be a show of bronze, or copper, or old gold, to suit the pleasure of the visitor.

Down the center of each of four groups of equal size will run a column of massive pillars, supporting representations of bronze statuary, each designed and made for the occasion and bearing the imprint of automobiling, sport, utility, and commerce combined. The principal feature in each group will be a massive wheel, six feet in diameter, placed at a height of fifteen feet, and below it a man of heroic size in the act of giving it impetus.

The electric lighting will be brilliant. Sixty-four flaming arcs are to be used in addition to the usual lighting equipment and smaller decorative effects, such as 250 twelve-inch globes and a greater number of incandescent lights.

It is not generally known perhaps that the Coliseum is the largest structure devoted to amusements and public gatherings in the United States, largely exceeding the size of Madison Square Garden, and with its galleries and annex affording about 10,000 more square feet of exhibition space.

Among the meetings to be held during the show, in addition to that of the National Association of Automobile Manufacturers, which will meet to elect officers, and of the American Automobile Association, are those of the National Retail Automobile Dealers' Association, and the National Association of Chauffeurs.

SOME GOSSIP OF THE SHOW.

Chadwick's Independent Show.—In view of the great prominence which the Chadwick Great Six stock car has won for itself in every event in which it has been entered during the past year, not a few of the visitors to the Coliseum will be disappointed at being unable to find the exhibit of the Chadwick Engineering Works there. The makers explain their absence as being due to the fact that they were unable to secure what they considered proper exhibition space and accordingly decided to confine their exhibit to the Chicago salesrooms at 1218 Michigan avenue, where H. B. Larzelere, sales-manager of the company, will be in charge throughout the week, assisted by the Chadwick Chicago representative.

Annual Gathering of the Pioneers.—One of the social functions of the show will be the third annual gathering of the Auto-Cyclo Pioneers, those who were connected with the predecessor of the automobile and have a connection with the succeeding industry. Present plans include a beefsteak supper on Wednesday night at the Southern Hotel, immediately after the closing of the show. The affair is in charge of a committee of "old timers," the secretary of which is George G. Greenburg, whose Chicago address is 1380 West Jackson boulevard. Of course, there will be something to eat, some music, and some talk about the days that are gone; in fact, nothing at all elaborate is planned, but simply a get-together of those who progressed from one industry into its natural successor.

White Books of White Matches.—Unconsciously, or rather unintentionally, The White Company may become a quasi-offender against the universal rule of "No smoking" that now prevails at all automobile shows, by supplying handy books of white-headed matches to all comers. A match is an incentive to light a cigar, particularly where this essential has been lacking hitherto, but this will not prevent the distribution of thousands of these neat little books during the course of the show at the Coliseum, and many a smoker will carry a White souvenir around with him for the next week or so. The advertising embodied in the souvenir is brief and directly to the point, reading on the flap: "The White Steamer is the only make of car which has been favorably reported on by the United States Government. The White Steamer is the only American touring car sold in quantity in England, France, Germany, and Italy in competition with the home product." It will carry its message home to thousands before the rows of White matches have all served their purpose and gone the way of their predecessors.

CHICAGO'S LIST OF EXHIBITORS

AMERICAN GASOLINE PLEASURE CARS.

AMERICAN SIMPLEX: Simplex Co., Mishawaka, Ind.	C.M.F.	N-1
APPERSON: Apperson Bros. Auto Co., Kokomo, Ind.	C.M.F.	E-1
APPERSON-TOLEDO: A. T. Motor Car Toledo, O.	C.M.F.	E-4
ALCO: American Locomobile Co., New York City	C.M.F.	F-1
AUBURN: Auburn Auto Co., Auburn, Ind.	A.M.F.	D-4
ATLAS: Atlas Motor Car Co., Springfield, Mass.	A.M.F.	B-3
AUSTIN: Austin Auto Co., Grand Rapids, Mich.	C.M.F.	O-2
BUICK: Buick Motor Co., Flint, Mich.	C.M.F.	E-2
BRUSH: Brush Runabout Co., Detroit.	A.M.F.	H-1
CADILLAC: Cadillac Motor Car Co., Detroit.	C.M.F.	D-3
CAMERON: Cameron Car Co., Beverly, Mass.	C.B.	58
CHALMERS-DETROIT: C.-D. Motor Co., Detroit.	C.M.F.	M-1
CORBIN: Corbin Motor Veh. Corp., New Britain, Conn.	C.M.F.	F-4
CARTERCAR: Cartercar Company, Pontiac, Mich.	A.M.F.	C-2
DE LUXE: De Luxe Motor Car Co., Detroit.	C.M.F.	J-1
DORRIS: Dorris Motor Car Co., St. Louis.	A.M.F.	B-4
ELMORE: Elmore Mfg. Co., Clyde, O.	C.M.F.	A-6
E-M-F: Everitt-Metzger-Flanders Co., Detroit.	C.M.F.	C-2
EMANCIPATOR: Emancipator Auto Co., Chicago.	C.B.	11-15
FRANKLIN: H. H. Franklin Mfg. Co., Syracuse, N. Y.	C.M.F.	D-6
FIRESTONE: Columbus Buggy Co., Columbus, O.	A.M.F.	B-1
GAETH: Gaeth Automobile Co., Cleveland.	A.M.F.	G-3
GLIDE: Bartholomew Company, Peoria, Ill.	C.M.F.	H-1
GREAT WESTERN: Model Auto Co., Peru, Ind.	A.M.F.	F-2
HAYNES: Haynes Automobile Co., Kokomo, Ind.	C.M.F.	C-6
HALLIDAY: Streater Motor Car Co., Streater, Ill.	A.M.F.	E-6
INTER-STATE: Inter-State Auto Co., Muncie, Ind.	C.B.	25-30
JACKSON: Jackson Automobile Co., Jackson, Mich.	A.M.F.	A-4
KNOX: Knox Automobile Co., Springfield, Mass.	C.M.F.	G-2
KISSELCAR: Kissel Motor Car Co., Hartford, Wis.	A.M.F.	A-1
LAMBERT: Buckeye Mfg. Co., Anderson, Ind.	A.M.F.	A-3
LOCOMOBILE: Loco. Co. of Am., Bridgeport, Conn.	C.M.F.	D-5
LOZIER: Lozier Motor Co., New York City.	C.M.F.	H-2
MARMON: Nordyke & Marmon Co., Indianapolis.	A.M.F.	D-2
MATHESON: Matheson Motor Car Co., Wilkes-Barre, Pa.	C.M.F.	G-1
MAXWELL: Maxwell-Eriscoe Motor Co., Tarrytown, N. Y.	C.M.F.	D-4
MIDLAND: Midland Motor Co., Moline, Ill.	C.M.F.	Q-2
MITCHELL: Mitchell Motor Car Co., Racine, Wis.	C.M.F.	K-1
METEOR: Meteor Motor Car Co., Bettendorf, Ia.	A.M.F.	E-5
MOLINE: Moline Auto Co., East Moline, Ill.	A.M.F.	D-3
MOON: Moon Motor Car Co., St. Louis.	A.M.F.	B-2
MORA: Mora Motor Car Co., Newark, N. Y.	A.M.F.	D-1
NATIONAL: National Motor Veh. Co., Indianapolis.	C.M.F.	C-5
OVERLAND: Overland Automobile Co., Indianapolis.	A.M.F.	C-1
OAKLAND: Oakland Motor Car Co., Pontiac.	C.M.F.	P-1
OLDSMOBILE: Olds Motor Works, Lansing, Mich.	C.M.F.	F-3
OWEN THOMAS: Thomas Motor Co., Janesville, Wis.	C.B.	35
PACKARD: Packard Motor Car Co., Detroit.	C.M.F.	C-1
PEERLESS: Peerless Motor Car Co., Cleveland.	C.M.F.	A-5
PENNSYLVANIA: Penn. Auto-Motor Co., Bryn Mawr, Pa.	C.M.F.	Q-1
PIERCE-ARROW: Pierce-Arrow Motor Car Co., Buffalo.	C.M.F.	F-2
PITTSBURG-SIX: Ft. Pitt Mfg. Co., New Kensington, Pa.	A.M.F.	A-2
POPE-HARTFORD: Pope Mfg. Co., Hartford, Conn.	C.M.F.	G-1
PREMIER: Premier Motor Mfg. Co., Indianapolis.	C.M.F.	C-3

PULLMAN: York Motor Car Co., York, Pa.	C.M.F.	O-1
REO: Reo Motor Car Co., Lansing, Mich.	C.M.F.	B-6
RICKETTS: Ricketts Auto Works, South Bend, Ind.	C.M.F.	L-1
RAMBLER: Thos. B. Jeffery & Co., Kenosha, Wis.	C.M.F.	B-2
RIDER-LEWIS: Rider-Lewis Motor Car Co., Muncie, Ind.	C.B.	21-24
RICHMOND: Wayne Works, Richmond, Ind.	A.M.F.	G-2
STEARNS: F. B. Stearns Co., Cleveland.	C.M.F.	B-5
STEVENS-DURYEA: S.-D. Co., Chicopee Falls, Mass.	C.M.F.	A-4
SPEEDWELL: Speedwell Motor Car Co., Dayton, O.	A.M.F.	A-2
STUDEBAKER: Studebaker Auto Co., South Bend, Ind.	C.M.F.	C-4
STODDARD-DAYTON: Dayton Motor Car Co., Dayton, O.	C.M.F.	D-2
THOMAS: E. R. Thomas Motor Co., Buffalo.	C.M.F.	A-3 & C.B.
WELCH: Welch Motor Car Co., Pontiac, Mich.	C.M.F.	Q-3
WINTON: Winton Motor Carriage Co., Cleveland.	C.M.F.	A-1

STEAMER PLEASURE CARS.

WHITE: The White Co., Cleveland.	C.M.F.	D-1
----------------------------------	--------	-----

ELECTRIC PLEASURE CARS.

BABCOCK: Babcock Electric Co., Buffalo, N. Y.	C.M.F.	B-3
BAKER: Baker Motor Vehicle Co., Cleveland.	C.M.F.	B-4
DETROIT: Anderson Carriage Co., Detroit, Mich.	A.M.F.	F-1
STUDEBAKER: Studebaker Auto Co., So. Bend, Ind.	C.M.F.	C-4
RAUCH & LANG: Rauch & Lang Car Co., Cleveland.	A.M.F.	Q-5
WAVERLY: Waverly Company, Indianapolis.	A.M.F.	C-3
WOODS: Woods Motor Vehicle Co., Chicago.	C.M.F.	B-1

HIGH WHEEL PLEASURE CARS.

ANDERSON: Anderson Carriage Mfg. Co., Anderson, Ind.	A.M.F.	E-1
BLACK: Black Mfg. Co., Chicago.	A.M.F.	E-4
BENDIX: Bendix Company, Chicago.	C.B.	31-32
DUER: Chicago Coach & Carriage Co., Chicago.	A.M.F.	E-1
HOLSMAN: Holsman Automobile Co., Chicago.	C.M.F.	E-3
HATFIELD: Clark-Hatfield Auto Co., Oshkosh, Wis.	C.B.	51
KIBLINGER: W. H. McIntyre Co., Auburn, Ind.	A.M.F.	C-4
MIER: Mier Carriage & Buggy Co., Ligonier, Ind.	C.B.	57
SCHACHT: Schacht Mfg. Co., Cincinnati, O.	C.B.	12
STAVER: Staver Carriage Co., Chicago.	A.M.F.	EE
ZIMMERMAN: Zimmerman Mfg. Co., Auburn, Ind.	C.B.	1

FOREIGN PLEASURE CARS.

BERLIET: Berliet Import Co., Chicago.	A.M.F.	G-4
FIAT: Fiat Automobile Co., New York City.	A.M.F.	G-1

COMMERCIAL VEHICLES.

GRABOWSKY: Grabowsky Power Wagon Co., Detroit.	C.B.	38-40
RANDOLPH: Randolph Motor Car Co., Chicago.	C.B.	17-20
RAPID: Rapid Motor Vehicle Co., Pontiac, Mich.	A.M.F.	E-2

TIRES.

Ajax-Grieb Rubber Co., Trenton, N. J.	C.A.S.	85
Continental Caoutchouc Co., New York City.	C.A.S.	104 & 121
Consolidated Rubber Tire Co., New York City.	C.A.S.	
Diamond Rubber Co., Akron, O.	C.G.	34
Dayton Rubber Mfg. Co., Dayton, O.	A.G.	25
Ennis Rubber Mfg. Co., Newark, N. J.	A.G.	B-28
Empire Auto Tire Co., Trenton, N. J.	C.A.S.	142
Fox Metallic Tire Belt Co., New York City.	C.A.S.	116
Firestone Tire & Rubber Co., Akron, O.	C.G.	67
Fisk Rubber Co., Chicopee Falls, Mass.	C.G.	38
G & J Tire Co., Indianapolis, Ind.	C.G.	44
B. F. Goodrich Co., Akron, O.	C.G.	47
Goodyear Tire & Rubber Co., Akron, O.	C.G.	51
Hartford Rubber Works Co., Hartford Conn.	C.G.	30
Morgan & Wright, Detroit, Mich.	C.G.	26
Metz Glincher Tire & Rubber Co., Akron, O.	C.A.S.	108
Michelin Tire Co., Milltown, N. J.	C.A.S.	112
Pennsylvania Rubber Co., Jeanette, Pa.	C.G.	62
Republic Rubber Co., Youngstown, O.	C.G.	12
Swinehart Tire & Rubber Co., Akron, O.	C.G.	54
Zeglen Bullet Proof Cloth Co., Chicago.	C.B.	2

TIRE ACCESSORIES.

E. T. Burrows Co., Portland, Me.	C.B.	49
Leather Tire Goods Co., Newton Upper Falls, Mass.	C.A.S.	105
Nadall Mfg. Co., Chicago.	C.B.	56
J. H. Sager Co., Rochester, N. Y.	C.A.S.	84
C. A. Shaler Co., Waupun, Wis.	G.G.	9
Standard Tire Protector Co., Saginaw, Mich.	A.G.	B-25
Universal Tire Protector Co., Angola, Ind.	A.G.	36
Weed Chain Tire Grip Co., New York City.	C.G.	77

BATTERIES.

Chicago Battery Co., Chicago.	C.G.	33
Commercial Electric Battery Co., Chicago.	C.G.	10
Electric Storage Battery Co., Philadelphia.	A.G.	61
National Carbon Co., Cleveland.	C.G.	46
National Battery Co., Buffalo, N. Y.	C.A.S.	110
Vesta Accumulator Co., Chicago.	C.G.	22
Vivax Storage Battery Co., Chicago.	A.G.	9
Witherbee Igniter Co., New York City.	C.A.S.	107

PLUGS, SWITCHES, AND GENERAL IGNITION.

American Electric Novelty & Mfg. Co., New York City.	C.G.	15
Champion Ignition Company, Flint, Mich.	C.B.	48
High Frequency Ignition Co., Chicago.	A.G.	31
R. E. Hardy Co., New York City.	C.G.	56
Legnard Bros. (Inc.), Waukegan, Ill.	A.G.	15
A. R. Mosier & Co., New York City.	C.A.S.	82
Never-Miss Spark Plug Co., Lansing, Mich.	C.G.	70
Pfanstiehl Elec. Lab., North Chicago.	C.B.	5
Pittsfield Spark Coil Co., Dalton, Mass.	C.A.S.	119

MAGNETOS AND TIMERS.

Atwater-Kent Mfg. Co., Philadelphia.	C.G.	17
Bosch Magneto Co., Chicago.	C.B.	53
Heinze Electric Co., Lowell, Mass.	C.G.	63
Motsinger Device Mfg. Co., Pendleton, Ind.	C.G.	24
Monitor Mfg. Co., Boston.	A.G.	20
C. F. Spiltdorf, New York City.	C.G.	49
F. H. Wheeler, Indianapolis.	C.G.	20
Witherbee Igniter Co., New York City.	C.A.S.	107

Abbreviations for Location of Exhibitors.—C.M.F.—Coliseum, main floor. C.B.—Coliseum, basement. C.G.—Coliseum, gallery. C.A.S.—Coliseum Annex, second floor. A.M.F.—First Regiment Armory, main floor. A.G.—First Regiment Armory, gallery.

COILS.

Atwater-Kent Mfg. Co., Philadelphia.....	C.G.	17
Conn. Tel. & Elec. Co., Meriden, Conn.....	C.A.S.	106
Heinze Electric Co., Lowell, Mass.....	C.G.	63
Kokomo Electric Co., Kokomo, Ind.....	C.G.	75
National Coil Co., Lansing, Mich.....	C.A.S.	88
Pittsfield Spark Coil Co., Dalton, Mass.....	C.A.S.	119
Remy Electric Co., Anderson, Ind.....	C.G.	65
C. F. Splitdorf, New York City.....	C.G.	49

LAMPS.

Badger Brass Mfg. Co., Kenosha, Wis.....	C.G.	40
R. E. Deitz & Co., New York City.....	C.G.	28
Edmunds & Jones Mfg. Co., Detroit.....	C.G.	74
Gray & Davis, Amesbury, Mass.....	C.G.	42
Ham Mfg. Co., Rochester, N. Y.....	C.A.S.	81

SHOCK ABSORBERS AND SPRINGS.

Ernst Fientje, Cambridge, Mass.....	C.B.	8
Gabriel Horn Mfg. Co., Cleveland.....	C.G.	50
Hartford Suspension Co., Jersey City.....	C.G.	8
J. H. Sager Company, Rochester, N. Y.....	C.A.S.	84
Triple Action Spring Co., Chicago.....	C.B.	6

SPEEDOMETERS.

Auto Improvement Co., New York City.....	C.G.	14
Chicago Reometre Co., Chicago.....	C.B.	4
Hoffecker, C., Boston.....	C.A.S.	115
J. W. Jones, New York City.....	C.G.	55
Stewart & Clark Mfg. Co., Chicago.....	C.A.S.	80
Veeder Mfg. Co., Hartford, Conn.....	C.G.	42
Warner Instrument Co., Beloit, Wis.....	C.G.	18

RADIATORS, PUMPS, MUFFLERS, AND HORNS.

Gabriel Horn Mfg. Co., Cleveland.....	C.G.	50
Grey-Hawley Mfg. Co., Detroit.....	C.A.S.	83
Imperial Brass Mfg. Co., Chicago.....	C.G.	7
Long Mfg. Co., Chicago.....	C.G.	53
McCord Mfg. Co., Detroit.....	C.G.	32
Randall-Faichney Co., Boston.....	C.A.S.	117

AXLES AND BEARINGS.

Bower Roller Bearing Co., Dayton, O.....	C.A.S.	148
High Wheel Auto Parts Co., Muncie, Ind.....	C.B.	47
Timken Roller Bearing Axle Co., Canton, O.....	C.G.	29

LUBRICANT AND LUBRICATORS.

Adam Cook Sons, New York City.....	C.A.S.	88
Dixon Crucible Co., Jersey City.....	C.A.S.	87
Hancock Mfg. Co., Charlotte, Mich.....	C.G.	16
A. W. Harris Oil Co., Providence, R. I.....	C.G.	25
McCanna Mfg. Co., Chicago.....	A.G.	19
N. Y. & N. J. Lubricant Co., New York City.....	C.G.	19

MATERIALS.

Wm. Cramp & Sons, Philadelphia.....	C.G.	59
Globe Machine & Stamping Co., Cleveland.....	C.A.S.	114
Shelby Steel Tube Co., Pittsburg.....	C.G.	60
A. O. Smith Co., Milwaukee.....	C.G.	6
Spicer Universal Joint Mfg. Co., Plainfield, N. J.....	C.G.	37
Whiteley Steel Co., Muncie, Ind.....	C.A.S.	109

CARBURETERS AND GASOLINE TANKS.

Avery Portable Lighting Co., Milwaukee.....	C.A.S.	118
Byrne-Kingston Co., Kokomo, Ind.....	C.G.	76
S. F. Bowser & Co., Fort Wayne, Ind.....	C.G.	72
Stromberg Motor Devices Co., Chicago.....	A.G.	16
F. H. Wheeler, Indianapolis.....	C.G.	20

ENGINES, TRANSMISSIONS, AND STEERING.

Brown-Lipe Gear Co., Syracuse.....	C.G.	36
Gemmer Mfg. Co., Detroit.....	C.A.S.	145
High Wheel Auto Parts Co., Muncie, Ind.....	C.B.	47
Milwaukee Motor Co., Milwaukee.....	C.A.S.	147
Ross Gear & Tool Co., Lafayette, Ind.....	C.A.S.	88
Warner Gear Co., Muncie, Ind.....	C.G.	57

SHIELDS, TOPS, AND BODY MOUNTINGS.

Chicago Wind Shield Co., Chicago.....	C.B.	43
L. C. Chase Co., Boston.....	C.A.S.	111
C. P. Kimball & Co., Chicago.....	A.M.F.	G-6
Fellock Auto & Mfg. Co., Evansville, Ind.....	C.B.	42
Limousine Carriage Mfg. Co., Chicago.....	C.A.S.	120
Longdin-Brugger Co., Fond du Lac, Wis.....	C.B.	46
Pantastote Company, New York City.....	C.G.	78
Rands Mfg. Co., Detroit.....	C.G.	10
Sprague Umbrella Co., Norwalk, O.....	C.G.	2-4
20th Century Motor Car Co., South Bend, Ind.....	C.B.	44
Troy Carriage Sunshade Co., Troy, O.....	C.B.	41
Vanguard Mfg. Co., Joliet, Ill.....	C.B.	50
Vehicle Top & Supply Co., St. Louis.....	C.B.	45

WHEELS AND CHAINS.

Baldwin Chain & Mfg. Co., Worcester, Mass.....	C.G.	64
Diamond Chain & Mfg. Co., Indianapolis.....	C.G.	58
Whitney Mfg. Co., Hartford, Conn.....	C.G.	23

WRENCHES AND OTHER TOOLS.

Buda Foundry & Mfg. Co., Chicago.....	C.B.	55
Cooks Standard Tool Co., Kalamazoo.....	C.G.	5
Duff Mfg. Co., Pittsburg.....	C.G.	66
Elite Mfg. Co., Ashland, O.....	A.G.	34
Norton Co., Worcester, Mass.....	C.B.	3
Oliver Mfg. Co., Chicago.....	C.G.	71
Quincy, Manchester, Sargent Co., Plainfield, N. J.....	A.G.	B-27

IN GENERAL.

"The Automobile," New York City.....	A.G.	A-24
Eugene Arnstein, Chicago.....	A.G.	21
Austro-Am. Separator Co., Cleveland.....	A.G.	3
"Automobile Topics," New York City.....	A.G.	11
S. Breakstone, Chicago.....	A.G.	13
Brandenburg & Co., Chicago.....	C.A.S.	146
Central Rubber Co., Chicago.....	A.G.	8
"Cycle & Automobile Trade Journal," Philadelphia.....	A.G.	6
Excelsior Supply Co., Chicago.....	A.G.	25
Fulton & Zinke, Chicago.....	C.B.	9
Garage Equipment Co., Milwaukee.....	C.B.	7
"Horseless Age," New York City.....	A.G.	17
H. C. Knight & Co., Chicago.....	A.G.	32
London Auto Supply Co., Chicago.....	A.G.	1
Morrison-Ricker Mfg. Co., Grinnell, Ia.....	A.G.	12
"Motor," New York City.....	A.G.	A-28
Motor & Accessories Mfgs.....	C.G.	69
"Motor," New York City.....	A.G.	A-28
Neely & Co., Chicago.....	A.G.	4
Wm. Pratt Mfg. Co., Chicago.....	C.G.	1
Rochester Safety Lock Co., Rochester, N. Y.....	A.G.	7
T. J. Rockford & Co., Chicago.....	A.G.	33
Royal Equipment Co., Bridgeport, Conn.....	C.B.	52
F. W. Smith, Aberdeen, S. D.....	A.G.	29
F. E. Sparks, Chicago.....	C.B.	37
Standard Varnish Works, Chicago.....	A.G.	18
Valentine & Co., New York City.....	C.G.	11

MOTORCYCLE DEPARTMENT.

Coliseum Annex—Second Floor.

American Motor Co., Brockton, Mass.....	C.A.S.	138
Armco Motor Co., Chicago.....	C.A.S.	97
Aurora Automatic Mach. Co., Aurora, Ill.....	C.A.S.	134
Auto-BI Company, Buffalo, N. Y.....	C.A.S.	137
"Bicycling World," New York City.....	C.A.S.	101
Consolidated Mfg. Co., Toledo.....	C.A.S.	131
Excelsior Motor & Mfg. Co., Chicago.....	C.A.S.	128
Harley-Davidson Motor Co., Chicago.....	C.A.S.	127
Hendee Mfg. Co., Springfield, Mass.....	C.A.S.	122-126
Hornecker Motor Mfg. Co., Geneseo, Ill.....	C.A.S.	96
Magnet Motor Co., Chicago.....	C.A.S.	102
Merkel Light Motor Co., Pottstown, Pa.....	C.A.S.	91
Minneapolis Motor Cycle Co., Minneapolis, Minn.....	C.A.S.	89
"Motorcycle," Illustrated, New York City.....	C.A.S.	103
N. S. U. Motor Co., New York City.....	C.A.S.	140
New Era Gas Engine Co., Dayton, O.....	C.A.S.	98
Ovington Motor Co., New York City.....	C.A.S.	132
Pierce Cycle Co., Buffalo, N. Y.....	C.A.S.	90
Reading Standard Co., Reading, Pa.....	C.A.S.	94
Thlem Mfg. Co., Minneapolis, Minn.....	C.A.S.	136
Wagner Motor Cycle Co., St. Paul, Minn.....	C.A.S.	130

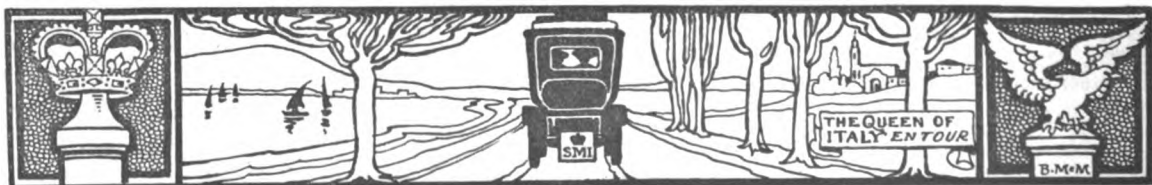

ESSENTIAL DETAILS OF THE 1909 CAR LIST

FIRST came the Grand Central Palace Show of the American Motor Car Manufacturers' Association and the Importers' Automobile Salon. Next followed the Madison Square Garden Show of the Association of Licensed Automobile Manufacturers. Now comes the Chicago exhibition of the National Association of Automobile Manufacturers.

In this show the two New York affairs are practically rolled

into one. Since the participants in the three shows compose the flower of the American automobile industry, a tabular summary will prove both interesting and instructive and convenient to the man who is about to buy a new car and perforce desires to regulate his purchase by consideration of the dollar mark.

Therefore, herewith is presented the roll call of, with few exceptions, all the cars on sale at the present time:

AMERICAN GASOLINE PLEASURE CARS.

CARS AND MODEL	Maker	Price	H. P.	Type
Peerless 25	Peerless Motor Car Co.	\$7,300	57	Landaulet
Pierce-Arrow 60	Pierce-Arrow Motor Car Co.	\$7,200	60	Landau
Peerless 25	Peerless Motor Car Co.	\$7,000	57	Limousine
Welch	Welch Motor Car Co.	\$7,000	75	Optional
Simplex	Simplex Automobile Co.	\$6,750	53	Landaulet
Chadwick	Chadwick Eng. Works	\$6,500	60	Runabout
De Luxe C.	De Luxe Motor Car Co.	\$6,250	50-60	Limousine
Pierce-Arrow 48	Pierce-Arrow Motor Car Co.	\$6,200	48	Landaulet
Thomas 6-70	E. R. Thomas Motor Co.	\$6,000	72	Touring
Thomas 4-60	E. R. Thomas Motor Co.	\$6,000	53	Limousine
Alco	American Locomotive Co.	\$6,000	60	Touring
Acme XXV	Acme Motor Car Co.	\$6,000	60	Touring
Pierce-Arrow 60	Pierce-Arrow Motor Car Co.	\$6,000	60	Touring
Peerless 25	Peerless Motor Car Co.	\$6,000	50	Touring
Welch	Welch Motor Car Co.	\$6,000	75	Optional
Austin	Austin Automobile Co.	\$6,000	60-90	Limousine
Oldsmobile Z	Olds Motor Works	\$6,000	54	Landaulet
Lozier I	Lozier Motor Co.	\$6,000	51	Touring
Lozier H	Lozier Motor Co.	\$6,000	44	Limousine
Locomobile 40	Locomobile Co. of America	\$5,900	40	Limousine
Peerless 19	Peerless Motor Car Co.	\$5,800	38	Landaulet
Oldsmobile Z	Olds Motor Works	\$5,800	54	Limousine
Stearns 30-60	F. B. Stearns Co.	\$5,750	46	Limousine
Simplex	Simplex Automobile Co.	\$5,750	53	Touring
Simplex	Simplex Automobile Co.	\$5,750	53	Speed Car
Royal-Tourist M	Royal-Tourist Car Co.	\$5,700	48	Limousine
Packard 30	Packard Motor Car Co.	\$5,650	40	Landaulet
Packard 30	Packard Motor Car Co.	\$5,550	40	Limousine
Chadwick	Chadwick Eng. Co.	\$5,500	60	Touring
Welch	Welch Motor Car Co.	\$5,500	50	Limousine
Peerless 19	Peerless Motor Car Co.	\$5,500	38	Limousine
Pierce-Arrow 40	Pierce-Arrow Motor Car Co.	\$5,400	40	Limousine
Studebaker B	Studebaker Automobile Co.	\$5,100	36	Landaulet
Alco	American Locomotive Co.	\$5,000	40	Touring
Walter M	Walter Automobile Co.	\$5,000	48	Touring
American Simplex D	Simplex Motor Car Co.	\$5,000	50	Limousine
Austin	Austin Automobile Co.	\$5,000	60-90	Touring
Austin	Austin Automobile Co.	\$5,000	50-60	Limousine
Studebaker D	Studebaker Automobile Co.	\$5,000	36	Limousine
Lozier H	Lozier Motor Co.	\$5,000	44	Briarcliff
Knox M	Knox Automobile Co.	\$5,000	48	Touring
American	American Motor Car Co.	\$5,000	50	Limousine
National 9-60	National Motor Veh. Co.	\$5,000	60	Touring
De Luxe	De Luxe Motor Car Co.	\$5,000	50-60	Optional
Pierce-Arrow 48	Pierce-Arrow Motor Car Co.	\$4,800	48	Touring
Austin	Austin Automobile Co.	\$4,700	60-90	Roadster
Stearns 30-60	F. B. Stearns Co.	\$4,700	46	Pullman
Apperson K	Apperson Bros. Auto. Co.	\$4,700	48	Touring
Pierce-Arrow 36	Pierce-Arrow Motor Car Co.	\$4,650	36	Brougham
Stearns 30-60	F. B. Stearns Co.	\$4,600	46	Touring
Thomas 4-60	E. R. Thomas Motor Co.	\$4,500	53	Touring
Thomas 6-40	E. R. Thomas Motor Co.	\$4,500	31	Limousine
Alco	American Locomotive Co.	\$4,500	22	Limousine
Welch 4-L	Welch Motor Car Co.	\$4,500	50	Touring
Welch 4-O	Welch Motor Car Co.	\$4,500	50	Close Coupled
Welch 4-M	Welch Motor Car Co.	\$4,500	50	Runabout
Royal-Tourist M	Royal-Tourist Car Co.	\$4,500	48	Touring
Apper-Toledo XXII	A.-T. Motor Car Co.	\$4,500	38	Touring
Apperson-Toledo XXII	A.-T. Motor Car Co.	\$4,500	38	Runabout
Matheson E	Matheson Motor Car Co.	\$4,500	40	Touring
Acme XX	Acme Motor Car Co.	\$4,500	48	Touring
Acme XXI	Acme Motor Car Co.	\$4,500	48	Runabout
Gaeth XXI	Gaeth Automobile Co.	\$4,500	38	Limousine
Oldsmobile ZR	Olds Motor Works	\$4,500	54	Runabout
Oldsmobile Z	Olds Motor Works	\$4,500	54	Touring
Locomobile 40	Locomobile Co. of America	\$4,500	40	Touring
Winton 6-18	Winton Motor Carriage Co.	\$4,500	60	Touring
Packard 18	Packard Motor Car Co.	\$4,400	26	Landaulet
Packard 18	Packard Motor Car Co.	\$4,300	26	Limousine
Peerless 19	Peerless Motor Car Co.	\$4,300	38	Touring
Peerless 19	Peerless Motor Car Co.	\$4,300	38	Roadster
Moon D	Moon Motor Car Co.	\$4,250	32	Brevette
Winton 6-17	Winton Motor Carriage Co.	\$4,250	48	Limousine
National 9-60	National Motor Veh. Co.	\$4,200	50	Touring
Packard 30	Packard Motor Car Co.	\$4,200	40	Touring
Packard 30	Packard Motor Car Co.	\$4,200	40	Runabout
Oldsmobile D	Olds Motor Works	\$4,000	36	Landaulet
Alco	American Locomotive Co.	\$4,000	22	Touring
American Simplex D	Simplex Motor Car Co.	\$4,000	50	Touring

CAR AND MODEL	Maker	Price	H. P.	Type
American Simplex D	Simplex Motor Car Co.	\$4,000	50	Runabout
Great Western 22	Model Automobile Co.	\$4,000	50	Touring
Austin 50	Austin Automobile Co.	\$4,000	50-60	Touring
American "Tourist"	American Motor Car Co.	\$4,000	50	Touring
American "Traveler"	American Motor Car Co.	\$4,000	50	Runabout
Stevens-Duryea Y	Stevens-Duryea Co.	\$4,000	54	Touring
Studebaker D	Studebaker Automobile Co.	\$4,000	36	Touring
Studebaker B	Studebaker Automobile Co.	\$4,000	36	Speed Car
Pierce-Arrow 36	Pierce-Arrow Motor Car Co.	\$4,000	36	Touring
Pierce-Arrow 24	Pierce-Arrow Motor Car Co.	\$3,950	24	Landaulet
Apperson Little 6	Apperson Bros. Auto. Co.	\$3,900	45	Touring
Moon D	Moon Motor Car Co.	\$3,850	32	Town Car
Austin 45	Austin Automobile Co.	\$3,850	45-50	Limousine
Stearns 15-30	F. B. Stearns Co.	\$3,800	32	Landaulet
Oldsmobile D	Olds Motor Works	\$3,800	36	Limousine
Pennsylvania E	Penn. Auto-Motor Co.	\$3,800	36.8	Touring
Austin 50	Austin Automobile Co.	\$3,750	50-60	Runabout
Franklin H	H. H. Franklin Mfg. Co.	\$3,750	43	Touring
Stevens-Duryea X	Stevens-Duryea Co.	\$3,750	36	Limousine
American	American Motor Car Co.	\$3,750	50	Roadster
Mora	Mora Motor Car Co.	\$3,750	42-50	Roadster
Marmon 50	Nordyke & Marmon Co.	\$3,750	50-80	Touring
Marmon 50	Nordyke & Marmon Co.	\$3,750	50-60	Close Coupled
Meteor F	Meteor Motor Car Co.	\$3,750	45-50	Touring
Meteor F-1	Meteor Motor Car Co.	\$3,750	45-50	Baby Ton.
Columbia 48	Electric Vehicle Co.	\$3,750	29	Limousine
Pope-Hartford S	Pope Mfg. Co.	\$3,750	30	Landaulet
National 9-40	National Motor Veh. Co.	\$3,700	40	Touring
Acme XXVII	Acme Motor Car Co.	\$3,700	35	Touring
Dorris	Dorris Motor Car Co.	\$3,600	28.9	Limousine
Mora	Mora Motor Car Co.	\$3,600	42	Touring
Lozier Little Six	Lozier Motor Co.	\$3,500	33	Touring
Studebaker A	Studebaker Automobile Co.	\$3,500	27	Suburban
Stevens-Duryea U	Stevens-Duryea Co.	\$3,500	36	Touring
Royal Tourist X	Royal-Tourist Car Co.	\$3,500	42	Touring
Royal-Tourist Y	Royal-Tourist Car Co.	\$3,500	42	Close Coupled
Oldsmobile Dr	Olds Motor Works	\$3,500	36	Coupe
Moon D	Moon Motor Car Co.	\$3,500	30-35	Touring
Speedwell ME	Speedwell Motor Car Co.	\$3,500	40	Limousine
Acme XXVI	Acme Motor Car Co.	\$3,500	30	Touring
Locomobile 30	Locomobile Co. of America	\$3,500	32	Touring
Locomobile 30	Locomobile Co. of America	\$3,500	32	Runabout
Palmer-Singer XXXII	Palmer & Singer Mfg. Co.	\$3,500	28	Landaulet
Palmer-Singer LXII	Palmer & Singer Mfg. Co.	\$3,500	57	Short Ton.
Corbin 14	Corbin Motor Veh. Corp.	\$3,500	32	Limousine
Pullman M	York Motor Car Co.	\$3,500	40	Touring
Pittsburg Six D	Ft. Pitt Motor Mfg. Co.	\$3,500	54	Touring
Premier 45	Premier Motor Mfg. Co.	\$3,500	45-55	Touring
Premier 45	Premier Motor Mfg. Co.	\$3,500	45-55	Runabout
Marmon 45	Nordyke & Marmon Co.	\$3,500	45-50	Touring
Gaeth XX	Gaeth Automobile Co.	\$3,500	38	Touring
Gaeth XX	Gaeth Automobile Co.	\$3,500	38	Close Coupled
Mora Light Six	Mora Motor Car Co.	\$3,500	42-50	Racytype
Apperson M	Apperson Bros. Auto. Co.	\$3,500	36	Touring
Palmer-Singer LXII	Palmer & Singer Mfg. Co.	\$3,520	57	Runabout
Coates-Goshen 25	Coates-Goshen Auto. Co.	\$3,250	25	Landaulet
Gearless	Gearless Motor Car Co.	\$3,250	30-60	Optional
Kissel Kar	Kissel Motor Car Co.	\$3,250	60	Coupe
Pittsburg Six C	Ft. Pitt Motor Mfg. Co.	\$3,200	54	Roadster
Kissel Kar D-9	Kissel Motor Mfg. Co.	\$3,200	40	Limousine
Packard 18	Packard Motor Car Co.	\$3,200	26	Touring
Packard 18	Packard Motor Car Co.	\$3,200	26	Runabout
Stearns 15-30	F. B. Stearns Co.	\$3,200	32	Touring
Stearns 15-30	F. B. Stearns Co.	\$3,200	32	Runabout
Pierce-Arrow 24	Pierce-Arrow Motor Car Co.	\$3,100	24	Runabout
Owen Thomas	Owen Thomas Motor Co.	\$3,000	48	Touring
Coates-Goshen 32	Coates-Goshen Auto. Co.	\$3,000	32	Touring
Moon C	Moon Motor Car Co.	\$3,000	30-35	Touring
Moon C	Moon Motor Car Co.	\$3,000	30-35	Runabout
Pittsburg Six B	Ft. Pitt Motor Mfg. Co.	\$3,000	54	Runabout
Kissel Kar G-9	Kissel Motor Car Co.	\$3,000	60	Touring
Pennsylvania C	Penn. Auto-Motor Co.	\$3,000	36	Touring
Pennsylvania C	Penn. Auto-Motor Co.	\$3,000	36	Runabout
Winton 6-17	Winton Motor Carriage Co.	\$3,000	48	Touring
Winton 6-17	Winton Motor Carriage Co.	\$3,000	48	Runabout
Thomas 6-40	E. R. Thomas Motor Co.	\$3,000	31	Touring
Thomas 6-40	E. R. Thomas Motor Co.	\$3,000	31	Flyabout
Thomas 4-16	E. R. Thomas Motor Co.	\$3,000	18	Brougham
Selden 29	Selden Motor Veh. Co.	\$3,000	29	Limousine
Sultan	Sultan Motor Co.	\$3,000	10-12	Landaulet
Austin 45	Austin Automobile Co.	\$3,000	45	Touring
Pullman 4-40	York Motor Car Co.	\$3,000	40	Runabout
Pope-Hartford S	Pope Mfg. Co.	\$3,000	30	Touring
Haynes X	Haynes Automobile Co.	\$3,000	36	Touring

CAR AND MODEL	Maker	Price	H. P.	Type
Knox O	Knox Automobile Co.	\$3,000	38	Touring
Apperson M	Apperson Bros. Auto. Co.	\$3,000	36	Runabout
Knox O	Knox Automobile Co.	\$2,950	38	Short Ton
Knox O	Knox Automobile Co.	\$2,900	38	Runabout
Haynes XI	Haynes Automobile Co.	\$2,900	36	Runabout
Coates-Goshen 32	Coates-Goshen Auto. Co.	\$2,850	32	Runabout
Austin 45	Austin Automobile Co.	\$2,850	45	Runabout
Stevens-Duryea XXX	Stevens-Duryea Co.	\$2,850	36	Runabout
Pope-Hartford S	Pope Mfg. Co.	\$2,815	30	Roadster
Owen Thomas	Owen Thomas Motor Co.	\$2,800	48	Dble. Road.
Franklin D	H. H. Franklin Mfg. Co.	\$2,800	28	Touring
Oldsmobile D	Olds Motor Works	\$2,750	36	Touring
Oldsmobile D	Olds Motor Works	\$2,750	36	Toy Tonneau
Oldsmobile Dr	Olds Motor Works	\$2,750	36	Runabout
Buick 6 & 7	Buick Motor Co.	\$2,750	45	Optional
Gearless 50	Gearless Motor Car Co.	\$2,750	50	Touring
Pullman 6-30	York Motor Car Co.	\$2,750	30	Runabout
Mora Large Four	Mora Motor Car Co.	\$2,750	60	Touring
Mora Large Four	Mora Motor Car Co.	\$2,750	60	Racetype
Stevens-Duryea X	Stevens-Duryea Co.	\$2,750	36	Touring
Pope-Hartford S	Pope Mfg. Co.	\$2,750	30	Touring
Pope-Hartford S	Pope Mfg. Co.	\$2,750	30	Short Ton.
National 9-35	National Motor Veh. Co.	\$2,750	35	Optional
KisselKar G-9	Kissel Motor Car Co.	\$2,750	60	Touring
KisselKar G-9	Kissel Motor Car Co.	\$2,750	60	Roadster
Chalmers-Detroit 40	Chalmers-Detroit Motor Co.	\$2,750	40	Touring
Chalmers-Detroit 40	Chalmers-Detroit Motor Co.	\$2,750	40	Runabout
Columbia 48	Electric Veh. Co.	\$2,750	29	Touring
Corbin O-2	Corbin Motor Veh. Corp.	\$2,650	32	Short Ton.
Elmore 44	Elmore Mfg. Co.	\$2,500	2	2 cycle Touring
Corbin K-2	Corbin Motor Veh. Corp.	\$2,500	32	Touring
Corbin S-2	Corbin Motor Veh. Corp.	\$2,500	32	Runabout
Rambler 45	Thos. B. Jeffery & Co.	\$2,500	45	Touring
Speedwell M-D	Speedwell Motor Car Co.	\$2,500	40	Touring
Speedwell M-C	Speedwell Motor Car Co.	\$2,500	40	Roadster
Atlas T	Atlas Motor Car Co.	\$2,500	22	Town Car
Acme XIX	Acme Motor Car Co.	\$2,500	25	Runabout
Great Western 21	Model Automobile Co.	\$2,500	40	Det. Tonneau
Glide G	Bartholomew Co.	\$2,500	45	Touring
Halladay D	Streator Motor Car Co.	\$2,500	40	Touring
Dorris	Dorris Motor Car Co.	\$2,500	28.9	Optional
Rider-Lewis X	Rider-Lewis Motor Car Co.	\$2,500	38.4	Tonneauette
Rider-Lewis IX	Rider-Lewis Motor Car Co.	\$2,500	38.4	Roadster
Rider-Lewis VIII	Rider-Lewis Motor Car Co.	\$2,500	38.4	Touring
Stoddard-D. 9-F	Dayton Motor Car Co.	\$2,500	45	Touring
Stoddard-D. 9-K	Dayton Motor Car Co.	\$2,500	45	Runabout
Premier 30	Premier Motor Mfg. Co.	\$2,500	30-35	Touring
Chalmers-Detroit 30	Chalmers-Detroit Motor Co.	\$2,500	24	Louisine
Apperson O	Apperson Bros. Auto. Co.	\$2,450	30	Touring
Coates-Goshen 25	Coates-Goshen Auto. Co.	\$2,450	25	Runabout
Marmon 32	Nordyke & Marmon Co.	\$2,400	32-40	Touring
Marmon 33	Nordyke & Marmon Co.	\$2,400	32-40	Runabout
KisselKar D-9	Kissel Motor Car Co.	\$2,300	40	Close Coupled
Rambler 44	Thos. B. Jeffery & Co.	\$2,250	34	Optional
Midland G	Midland Motor Co.	\$2,250	30-35	Optional
Elmore 33	Elmore Mfg. Co.	\$2,250	2	2-cycle Landaulet
Palmer-Singer 32	Palmer & Singer Mfg. Co.	\$2,250	28	Runabout
McCue	McCue Company	\$2,200	30	Touring
Pennsylvania D-25	Penn. Auto-Motor Co.	\$2,100	28.9	Touring
Glide R	Bartholomew Co.	\$2,000	45	Roadster
McCue	McCue Company	\$2,000	30	Roadster
KisselKar D-9	Kissel Motor Car Co.	\$2,000	40	Touring
KisselKar D-9	Kissel Motor Car Co.	\$2,000	40	Runabout
Selden 29	Selden Motor Veh. Co.	\$2,000	29	Touring
Selden 29	Selden Motor Veh. Co.	\$2,000	29	Roadster
Pennsylvania D-25	Penn. Auto-Motor Co.	\$2,000	28.9	Touring
Lambert B-2	Buckeye Mfg. Co.	\$2,000	40	Touring
Overland 34	Overland Automobile Co.	\$2,000	35	Touring
Overland 34	Overland Automobile Co.	\$2,000	35	Touring
Mitchell L	Mitchell Motor Car Co.	\$2,000	35-40	Touring
Pullman K	York Motor Car Co.	\$2,000	30	Touring
Stoddard-D. 9-A	Dayton Motor Car Co.	\$2,000	35	Touring
Stoddard-D. 9-C	Dayton Motor Car Co.	\$2,000	35	Roadster
Jackson E	Jackson Automobile Co.	\$2,000	35	Touring
Jackson E	Jackson Automobile Co.	\$2,000	35	Roadster
Rambler 34-A	Thos. B. Jeffery & Co.	\$2,000	32	Roadster
Benner	Benner Motor Car Co.	\$1,850	25-30	Toy Tonneau
Atlas F	Atlas Motor Car Co.	\$1,850	33	Touring
Mora Light Four	Mora Motor Car Co.	\$1,850	24-28	Racetype
Franklin G	H. H. Franklin Mfg. Co.	\$1,850	18	Touring
Atlas F	Atlas Motor Car Co.	\$1,800	33	Runabout
KisselKar LD-9	Kissel Motor Car Co.	\$1,800	30	Coupe
Midland E	Midland Motor Co.	\$1,800	25-30	Toy Tonneau
Benner	Bonner Motor Car Co.	\$1,800	25-30	Roadster
McCue	McCue Company	\$1,800	30	Runabout
Elmore 33	Elmore Mfg. Co.	\$1,750	2-cycle	Touring
Elmore 33	Elmore Mfg. Co.	\$1,750	2-cycle	Roadster
Buick 16 & 17	Buick Motor Co.	\$1,750	32	Optional
Benner	Benner Motor Car Co.	\$1,750	25-30	Roadster
Inter-State 25	Inter-State Auto. Co.	\$1,750	35-40	Optional
Lambert 19	Buckeye Mfg. Co.	\$1,750	35-40	Touring
Maxwell DA	Maxwell-Briscoe Motor Co.	\$1,750	24-30	Touring
Maxwell KA	Maxwell-Briscoe Motor Co.	\$1,750	24-30	Runabout
Gearless Olympic	Gearless Motor Car Co.	\$1,650	35	Optional
Great Western 20	Model Automobile Co.	\$1,600	30	Det. Tonneau
Great Western 20A	Model Automobile Co.	\$1,600	30	Runabout
Jackson H	Jackson Automobile Co.	\$1,600	30	Touring
Jackson H	Jackson Automobile Co.	\$1,600	30	Touring
Oakland 40-G	Oakland Motor Car Co.	\$1,600	40	Touring
Oakland 40-F	Oakland Motor Car Co.	\$1,600	40	Touring
Chalmers-Detroit 30	Chalmers-Detroit Motor Co.	\$1,500	24	Touring
Chalmers-Detroit 30	Chalmers-Detroit Motor Co.	\$1,500	24	Runabout
Gearless 35	Gearless Motor Car Co.	\$1,500	35	Optional
Moline M	Moline Automobile Co.	\$1,500	24	Touring
Cameron 11	Cameron Car Co.	\$1,500	36	Touring
Cameron 11	Cameron Car Co.	\$1,500	36	Roadster
Stoddard-D. 9-H	Dayton Motor Car Co.	\$1,500	25	Runabout
Pullman L	York Motor Car Co.	\$1,500	20	Runabout
Mitchell K	Mitchell Motor Car Co.	\$1,500	28-30	Det. Tonneau
KisselKar LD-9	Kissel Motor Car Co.	\$1,500	30	Touring
Bendix 9-L	Bendix Co.	\$1,500	25.6	Roadster
Overland 32	Overland Automobile Co.	\$1,500	32	Touring
Overland 32	Overland Automobile Co.	\$1,500	32	Runabout
Maxwell HD	Maxwell-Briscoe Motor Co.	\$1,450	20	Touring
Cadillac 30	Cadillac Motor Co.	\$1,400	25	Touring
Auburn B	Auburn Auto. Co.	\$1,400	25-30	Touring

CAR AND MODEL	Maker	Price	H.P.	Type
Cadillac 30	Cadillac Motor Car Co.	\$1,400	25	Roadster
Overland 31	Overland Automobile Co.	\$1,400	30	Optional
Rambler 41	Thos. B. Jeffery & Co.	\$1,350	32	Optional
KisselKar LD-9	Kissel Motor Car Co.	\$1,350	30	Roadster
Great Western 18	Model Automobile Co.	\$1,350	20	Det. Tonneau
Cartercar G	Cartercar Company	\$1,350	22-24	Roadster
Cartercar K	Cartercar Company	\$1,350	22-24	Touring
Auburn C	Auburn Automobile Co.	\$1,350	25-30	Roadster
Auburn D	Auburn Automobile Co.	\$1,300	25-30	Roadster
Overland 30	Overland Automobile Co.	\$1,300	30	Runabout
Auburn G	Auburn Automobile Co.	\$1,250	24	Touring
Black 40	Black Mfg. Co.	\$1,250	40	Touring
Lambert 30	Buckeye Mfg. Co.	\$1,250	28	Touring
Atlas R	Atlas Motor Car Co.	\$1,250	22	Runabout
Jackson C	Jackson Automobile Co.	\$1,260	20-24	Touring
E-M-F 30	Everitt-Metzger-Flanders Co.	\$1,250	25	Touring
E-M-F 30	Everitt-Metzger-Flanders Co.	\$1,250	25	Roadster
Overland 30	Overland Automobile Co.	\$1,250	30	Runabout
Regal A	Regal Motor Car Co.	\$1,250	30	Touring
Regal B	Regal Motor Car Co.	\$1,250	30	Roadster
Oakland 20-B	Oakland Motor Car Co.	\$1,250	20	Touring
Buick F & G	Buick Motor Co.	\$1,250	16	Optional
Halladay J	Streator Motor Car Co.	\$1,200	24	Touring
Oakland 20-A	Oakland Motor Car Co.	\$1,200	24	Touring
Auburn K	Auburn Automobile Co.	\$1,150	24	Roadster
Rambler 47	Thos. B. Jeffery & Co.	\$1,150	22	Optional
Richmond J-3	Wayne Works	\$1,150	26.6	Touring
Cameron 16	Cameron Car Co.	\$1,100	20-24	Touring
Cameron 16	Cameron Car Co.	\$1,100	20-24	Roadster
Halladay F	Streator Motor Car Co.	\$1,000	24	Surrey
Richmond J-2	Wayne Works	\$1,050	22.5	Surrey
Halladay E	Streator Motor Car Co.	\$1,050	24	Roadster
Cartercar H	Cartercar Company	\$1,000	18-20	Runabout
Ford T	Ford Motor Co.	\$1,000	20	Town Car
Reo D	Reo Motor Car Co.	\$1,000	20-22	Touring
Reo HR	Reo Motor Car Co.	\$1,000	20-22	Touring
Mitchell J	Mitchell Motor Car Co.	\$1,000	20	Runabout
Cameron 15	Cameron Car Co.	\$1,000	20-24	Runabout
Buick 10	Buick Motor Co.	\$1,000	22	Runabout
Cameron 14	Cameron Car Co.	\$950	20-24	Roadster
Cadillac T	Cadillac Motor Car Co.	\$950	10	Touring
Ford T	Ford Motor Co.	\$950	20	Coupe
Richmond J-1	Wayne Works	\$900	22.5	Roadster
Cameron 14	Cameron Car Co.	\$900	20-24	Runabout
Lambert A-3	Buckeye Mfg. Co.	\$875	20	Touring
Middleby A or B	Middleby Automobile Co.	\$850	25	Optional
Jackson K	Jackson Automobile Co.	\$850	16-18	Touring
Jackson F	Jackson Automobile Co.	\$850	16-18	Runabout
Ford T	Ford Motor Co.	\$850	20	Touring
Maxwell LB	Maxwell-Briscoe Co.	\$850	14	Runabout
Gyroscope	Blomstrom Mfg. Co.	\$800	16	Roadster
Lambert A-1	Buckeye Mfg. Co.	\$800	20	Runabout
Gyroscope	Blomstrom Mfg. Co.	\$750	16	Optional
Anderson C	Anderson Carriage Co.	\$650	12	Runabout
Brush B	Brush Runabout Co.	\$550	7	Runabout
Maxwell A	Maxwell-Briscoe Co.	\$500	10	Runabout
Reo G	Reo Motor Car Co.	\$500	10	Runabout
Waltham 17	C. H. Metz.	\$350	4	Buckboard

STEAM PLEASURE CARS.

CAR AND MODEL	Maker	Price	H. P.	Type
White-M	The White Co.	\$4,000	40	Touring
Lane-17	Lane Motor Vehicle Co.	\$3,100	30	Touring
Lane-18	Lane Motor Vehicle Co.	\$3,000	30	Close Coupled
Lane-16	Lane Motor Vehicle Co.	\$2,800	30	Roadster
Lane-15	Lane Motor Vehicle Co.	\$2,000	20	Touring
White-0	The White Co.	\$2,000	20	Touring
Lane-14	Lane Motor Vehicle Co.	\$1,800	20	Runabout

FOREIGN PLEASURE CARS.

CAR AND MODEL	Importer	Price	H.P.
C. G. V.	C. G. V. Import Co.	\$10,000	90-120
DeLaunay-B'ville	Palais de L'Automobile	\$10,000	60-75
Panhard	Panhard & Lavassor	\$8,700	65-80
Isotta	Isotta Import Co.	\$8,500	50-65
Panhard	Panhard & Lavassor	\$7,500	50-60
C. G. V.	C. G. V. Import Co.	\$7,500	75-90
Fiat	Fiat Automobile Co.	\$7,250	60
DeLaunay B'ville	Palais de L'Automobile	\$7,000	40-55
Berliet	Berliet Import Co.	\$6,500	40-50
Hotchkiss V	Hotchkiss Import Co.	\$6,250	65
DeLaunay-B'ville	Palais de L'Automobile	\$6,100	40-50
Fiat	Fiat Automobile Co.	\$6,000	45
C. G. V.	C. G. V. Import Co.	\$6,000	50-60
Isotta	Isotta Import Co.	\$5,600	40-45
Berliet	Berliet Import Co.	\$5,500	40-50
Panhard	Panhard & Lavassor	\$5,400	35-45
Fiat	Fiat Automobile Co.	\$5,250	45
Isotta	Isotta Import Co.	\$5,250	15-25
DeLaunay-B'ville	Palais de L'Automobile	\$5,100	25-40
DeLaunay-B'ville	Palais de L'Automobile	\$5,000	28-35
Panhard	Panhard & Lavassor	\$5,000	30-40
Fiat	Fiat Automobile Co.	\$5,000	40
C. G. V.	C. G. V. Import Co.	\$5,000	30-40
Hotchkiss U	Hotchkiss Import Co.	\$4,750	30-40
Isotta	Isotta Import Co.	\$4,600	18-24
Berliet	Berliet Import Co.	\$4,500	20-30
Panhard	Panhard & Lavassor	\$4,500	25-35
Fiat	Fiat Automobile Co.	\$4,500	25
C. V. G.	C. V. G. Import Co.	\$4,500	20-30
Isotta	Isotta Import Co.	\$4,500	18-24
DeLaunay-B'ville	Palais de L'Automobile	\$4,400	20-30
Isotta	Isotta Import Co.	\$4,250	14-20

CAR AND MODEL	Importer	Price	H.P.
Hotchkiss X.	Hotchkiss Import Co.	\$4,250	20-30
Panhard.	Panhard & Lavassor.	\$4,100	18-30
Delaunay-B'ville.	Palais de L'Automobile.	\$4,000	15-25
Berliet.	Berliet Import Co.	\$4,000	15-20
Lancia.	Hol-Tan Co.	\$4,000	12-18
Delaunay-B'ville.	Palais de L'Automobile.	\$3,500	15-22
Hotchkiss T.	Hotchkiss Import Co.	\$3,500	16-20
Panhard.	Panhard & Lavassor.	\$3,500	15-20
Fiat.	Fiat Automobile Co.	\$3,500	18
Lancia.	Hol-Tan Co.	\$3,500	12-18
C. G. V.	C. G. V. Import Co.	\$3,300	12-15
Lancia.	Hol-Tan Co.	\$3,300	12-18
C. G. V.	C. G. V. Import Co.	\$3,250	15-20
Panhard.	Panhard & Lavassor.	\$3,000	10-15
C. G. V.	C. G. V. Import Co.	\$3,000	12-15
Lancia.	Hol-Tan Co.	\$3,000	12-18
Delaunay-B'ville.	Palais de L'Automobile.	\$2,800	10-15
Fiat.	Fiat Automobile Co.	\$2,750	12
C. G. V.	C. G. V. Import Co.	\$2,500	8-10
Panhard.	Panhard & Lavassor.	\$1,850	8-11
DeDietrich Cfo-6.	DeDietrich Import Co.		75
DeDietrich FER.	DeDietrich Import Co.		60
DeDietrich Cfo.	DeDietrich Import Co.		40
DeDietrich Cfo.	DeDietrich Import Co.		28
DeDietrich Cfi.	DeDietrich Import Co.		18
DeDietrich Cffi.	DeDietrich Import Co.		20
DeDietrich VPH.	DeDietrich Import Co.		14
Renault.	Renault Freres Selling Branch.		50-60
Renault.	Renault Freres Selling Branch.		35-45
Renault.	Renault Freres Selling Branch.		20-30
Renault.	Renault Freres Selling Branch.		14-20
Renault.	Renault Freres Selling Branch.		12-16
Renault.	Renault Freres Selling Branch.		10-14
Renault.	Renault Freres Selling Branch.		9-12
Renault.	Renault Freres Selling Branch.		8-10

HIGH WHEEL TYPES OF PLEASURE CARS.

CAR AND MODEL	Maker	Price	H. P.	Type
Bendix 9H.	Bendix Company	\$1,500	25.6	Roadster
Bendix 4.	Bendix Company	\$1,400	25.6	Roadster
Black 40.	Black Mfg. Co.	\$1,250	40	Touring
Holsman H15.	Holsman Automobile Co.	\$1,000	26	Coupe
Staver 20.	Staver Carriage Co.	\$975	22-24	Roadster
Holsman 11.	Holsman Automobile Co.	\$800	12.8	Surrey
Zimmerman I.	Zimmerman Mfg. Co.	\$750	16	Surrey
Mier D.	Mier Carriage and Buggy Co	\$750	16.2	Surrey
Duer.	Chicago Coach & Carriage Co	\$750	16	Buggy
Kiblinger M.	W. H. McIntyre Co.	\$750	27	
Holsman 10.	Holsman Automobile Co.	\$750	12.8	Stanhope
Zimmerman K.	Zimmerman Mfg. Co.	\$735	16	Roadster
Holsman 9.	Holsman Automobile Co.	\$700	12.8	
Schacht K.	Schacht Mfg. Co.	\$680	18-20	Corning
Kiblinger P.	W. H. McIntyre Co.	\$675	16	
Zimmerman H.	Zimmerman Mfg. Co.	\$650	14	Runabout
Mier C.	Mier Carriage & Buggy Co.	\$650	16.2	Runabout
Hatfield 23.	Clark-Hatfield Auto. Co.	\$650	14.4	Buggy
Black 118.	Black Mfg. Co.	\$650	20	Surrey
Holsman 8.	Holsman Automobile Co.	\$650	12.8	
Zimmerman G.	Zimmerman Mfg. Co.	\$650	12	Buggy
Kiblinger GG.	W. H. McIntyre Co.	\$600	16	Surrey
Kiblinger NN.	W. H. McIntyre Co.	\$600	16	Roadster
Black 115.	Black Mfg. Co.	\$575	20	Roadster
Mier A & B.	Mier Carriage & Buggy Co.	\$575	12.8	Runabout
Kiblinger N.	W. H. McIntyre Co.	\$550	16	Runabout
Holsman 4.	Holsman Automobile Co.	\$550	16	Runabout
Anderson B.	Anderson Carriage Mfg. Co.	\$550	12	Runabout
Kiblinger L.	W. H. McIntyre Co.	\$500	13.5	Runabout
Kiblinger K.	W. H. McIntyre Co.	\$475	13.5	Runabout
Kiblinger H.	W. H. McIntyre Co.	\$450	13.5	Runabout
Black 12.	Black Mfg. Co.	\$450	14	Stanhope

ELECTRIC PLEASURE CARS.

CAR AND MODEL	Maker	Price	Model
Baker 1.	Baker Motor Vehicle Co.	\$4,000	Brougham
Babcock 7.	Babcock Electric Co.	\$4,000	
Rauch & Lang 144.	Rauch & Lang Carriage Co.	\$4,000	Combination
Rauch & Lang 144.	Rauch & Lang Carriage Co.	\$2,800	Coupe
Rauch & L 144 S.	Rauch & Lang Carriage Co.	\$2,700	Coupe
Woods 214 A.	Woods Motor Vehicle Co.	\$2,700	Combination
Baker M.	Baker Motor Vehicle Co.	\$2,500	Roadster
Baker.	Baker Motor Vehicle Co.	\$2,500	Coupe
Babcock.	Babcock Electric Co.	\$2,500	Town Car
Detroit D.	Anderson Carriage Co.	\$2,400	Brougham
Detroit C.	Anderson Carriage Co.	\$2,250	Coupe
R & L 13.	Rauch & Lang Carriage Co.	\$2,200	Victoria
Waverley 750.	Waverley Company.	\$2,150	Victoria
Woods 214.	Woods Motor Vehicle Co.	\$2,100	Victoria
Babcock 10.	Babcock Electric Co.	\$2,100	Coupe
R & L 12.	Rauch & Lang Carriage Co.	\$2,050	Stanhope
Babcock.	Babcock Electric Co.	\$2,000	Roadster
Rauch & Lang 10.	Rauch & Lang Carriage Co.	\$1,900	Stanhope
Detroit B.	Anderson Carriage Co.	\$1,900	Victoria
Detroit A.	Anderson Carriage Co.	\$1,850	Victoria
Baker L.	Baker Motor Vehicle Co.	\$1,850	Victoria
Baker R.	Baker Motor Vehicle Co.	\$1,850	Runabout
Studebaker.	Studebaker Automobile Co.	\$1,800	Coupe
Babcock 1.	Babcock Electric Co.	\$1,800	Special
Babcock 6.	Babcock Electric Co.	\$1,700	Phaeton
Columbia.	Electric Vehicle Co.	\$1,600	Phaeton
Waverley 74.	Waverley Co.	\$1,500	Stanhope
Studebaker.	Studebaker Automobile Co.	\$1,500	Stanhope
Detroit L.	Anderson Carriage Co.	\$1,350	Roadster

COMMERCIAL VEHICLES.

CAR AND MODEL	Maker	Price	H. P.	Type
Manhattan.	Mack Bros. Motor Car Co.	\$6,500	50	22 Bus
Manhattan.	Mack Bros. Motor Car Co.	\$6,000	50	5 Ton Dump
Manhattan.	Mack Bros. Motor Car Co.	\$5,500	50	20 Passenger
Manhattan.	Mack Bros. Motor Car Co.	\$5,100	50	5 Ton
Hewitt.	Hewitt Motor Co.	\$5,000	28	5 Ton
Manhattan.	Mack Bros. Motor Car Co.	\$5,000	50	16 Passenger
Manhattan.	Mack Bros. Motor Car Co.	\$4,800	50	12 Passenger
Studebaker 2012.	Studebaker Automobile Co.	\$4,500	Elec.	5 Ton
American O.	American Motor Truck Co.	\$4,500	65	5 Ton
Sampson 4-9A.	Alden Sampson Co.	\$4,500	40	4 Ton
Manhattan.	Mack Bros. Motor Car Co.	\$4,400	50	3 Ton Woolen
Knox 18.	Knox Automobile Co.	\$4,300	50	5 Ton
Manhattan.	Mack Bros. Motor Car Co.	\$4,250	50	3 Ton Exp.
Packard.	Packard Motor Car Co.	\$3,850	32	3 Ton
American D.	American Motor Truck Co.	\$3,800	55	Stage
American L.	American Motor Truck Co.	\$3,800	55	Truck
Randolph.	Randolph Motor Car Co.	\$3,750	40	4 Ton
Manhattan.	Mack Bros. Motor Car Co.	\$3,750	50	2 Ton
Lansden 46.	Lansden Company	\$3,600	Elec.	2 Ton
Alco.	American Locomotive Co.	\$3,500	16	Express
Gramm-Logan X.	Gramm-Logan Motor Car Co.	\$3,500	45	3 Ton
Randolph.	Randolph Motor Car Co.	\$3,250	36	3 Ton
Grabowsky 600A.	Grabowsky Pow. Wagon Co.	\$3,100	25-30	Palace Car
Grabowsky 505A.	Grabowsky Pow. Wagon Co.	\$3,050	25-30	2 Ton
Hewitt.	Hewitt Motor Co.	\$3,000	24	2 Ton
Grabowsky.	Grabowsky Pow. Wagon Co.	\$3,000	25-30	Fire or Police
American 6 or M.	American Motor Truck Co.	\$3,000	35-40	Bus or Truck
Grabowsky 420A.	Grabowsky Pow. Wagon Co.	\$2,800	25-30	
Rockwell.	Bristol Eng. Works.	\$2,750	20	Taxicab
American M.	American Motor Truck Co.	\$2,750	35-40	1 1-2 Ton
Studebaker 2008.	Studebaker Automobile Co.	\$2,700	Elec.	1 1-4 Ton
Lansden 36.	Lansden Company	\$2,650	Elec.	1 1-2 Ton
Grabowsky 200A.	Grabowsky Pow. Wagon Co.	\$2,600	25-30	Bus
Randolph.	Randolph Motor Car Co.	\$2,500	35	2 Ton
Studebaker.	Studebaker Automobile Co.	\$2,500	Elec.	Ambulance
Speedwell.	Speedwell Motor Car Co.	\$2,500	24	Truck
Atlas.	Atlas Motor Car Co.	\$2,500	22	Taxicab
Pullman.	York Motor Car Co.	\$2,500	20	Taxicab
American S.	American Motor Truck Co.	\$2,500	25	1 Ton
Lansden 36.	Lansden Company	\$2,450	Elec.	1 Ton
Studebaker 2007.	Studebaker Automobile Co.	\$2,300	Elec.	1,500 lbs.
Grabowsky.	Grabowsky Pow. Wagon Co.	\$2,300	25-30	1 Ton
Gramm-Logan V.	Gramm-Logan Mot. Car Co.	\$2,250	25	1 1-2 Ton
Autocar 18.	Autocar Company	\$2,225	18	1 Ton
Randolph.	Randolph Motor Car Co.	\$2,000	22	Optional
Lansden 359.	Lansden Company	\$1,850	Elec.	2 Ton
American T.	American Motor Truck Co.	\$1,750	20	Delivery
Gramm-Logan Y.	Gramm-Logan Mot. Car Co.	\$1,600	25	Delivery
Randolph.	Randolph Motor Car Co.	\$1,500	22	Optional
Maxwell OD.	Maxwell-Briscoe Co.	\$1,400	20	Delivery
Knox 20.	Knox Automobile Co.	\$1,400	12	Delivery
Hart-Kraft A-3.	Hart-Kraft Motor Co.	\$1,200	14	Delivery
Hart-Kraft A-2.	Hart-Kraft Motor Co.	\$1,175	14	Delivery
Hart-Kraft A-1.	Hart-Kraft Motor Co.	\$1,100	14	Delivery
Hart-Kraft A-0.	Hart-Kraft Motor Co.	\$1,050	14	Delivery
Ford T.	Ford Motor Co.	\$950	20	Taxicab
Kiblinger 180.	W. H. McIntyre Co.	\$825	16	Delivery
Duer.	Chicago Coach & Car. Co.	\$750	16	Delivery
Holsman 12.	Holsman Automobile Co.	\$700	12.8	Delivery
Brush.	Brush Runabout Co.	\$600	7	Delivery
Kiblinger R.	W. H. McIntyre Co.	\$475	13-16	Mail Wagon
Rapid.	Rapid Motor Vehicle Co.		24-30	1 Ton
Rapid.	Rapid Motor Vehicle Co.		24-30	1 1-2 Ton
Rapid.	Rapid Motor Vehicle Co.		24-30	16-20 Pass.
Rapid.	Rapid Motor Vehicle Co.		24-30	Fire or Police
Rapid.	Rapid Motor Vehicle Co.		24-30	Ambulance
Rapid.	Rapid Motor Vehicle Co.		60	5 Tons
Pittsburg.	Pittsburg Motor Veh. Co.		Elec.	Express
Pittsburg.	Pittsburg Motor Veh. Co.		Elec.	1 Ton
Pittsburg.	Pittsburg Motor Veh. Co.		Elec.	2 Ton
Geneva.	Cleveland Autocab Co.		24	Taxicab
Pope-Hartford.	Pope Mfg. Co.		30	Ambulance
Pope-Hartford.	Pope Mfg. Co.		30	Fire or Police
General.	General Vehicle Co.		Elec.	Delivery
General.	General Vehicle Co.		Elec.	1-2 Ton
General.	General Vehicle Co.		Elec.	1 Ton
General.	General Vehicle Co.		Elec.	2 Ton
General.	General Vehicle Co.		Elec.	3 1-2 Ton
General.	General Vehicle Co.		Elec.	3 1-2 Ton
General.	General Vehicle Co.		Elec.	5 Ton
Champion.	Champion Wagon Co.		Elec.	Delivery

ALL RIGHT, NOW, FOR CLEVELAND SHOW.

CLEVELAND, Feb. 2.—After considerable fluttering, the dove of peace has decided to rest securely on the local automobile show, scheduled for the week of February 22. Because all the dealers could not secure space which they considered suitable, an effort to hold a separate show was considered by some. Cooler heads have probably prevented this, and there is now little likelihood of any such venture. As it now stands, however, the Pierce-Arrow, Mitchel, Mora and Regal will not exhibit locally. Some of the dealers refused to accept balcony space, that being the underlying cause of the trouble. It is impossible to get all in on the ground floor, owing to lack of space.



CARS HAVING THEIR FIRST 1909 SHOWING

ONE big event has the advantage of including everything to be seen by way of automobiles in a way to render comparison much more easy, and with less chance of defeating the aim. The average autoist goes to an automobile exhibition with the idea of sizing up the situation against the time when it will be up to him to pick the car which will more nearly accord with his needs, and memory is too treacherous to enable him to do full justice to the situation when the cars have to be examined in two installments, with a difference in time of two weeks.

In New York City some of the cars did not show in either the Palace or the Garden, and it is fortunate for the interested autoist that in Chicago all are to be seen at one time and place. Also as a matter of fact it seems that at Chicago there are quite a number of exhibits which were not at the shows in New York,

Auburn.—The Auburn Automobile Company, Auburn, Ind., has brought out an entirely new model this year which will be built in connection with its present two-cylinder model. The new model is equipped with a four-cylinder Rutenber motor, the cylinders being separately cast with integral heads, water jackets and valve chambers. Valves are all on one side. The camshaft, crankshaft, and connecting rods are all drop forgings with ground bearing surfaces, and cams are integral with shafts. The crankcase, of cast aluminum alloy, is divided horizontally and all bearings are contained in the upper half—the lower portion acting as a reservoir for the self-contained oil system. The lower part of the case is divided into four compartments, and the level is maintained by an overflow arrangement and a gear pump. Features of the cooling system are the solid brass water connections, the bronze water pump attached to the end of the camshaft by means of a square-jawed self-centering coupling, the adjustable belt-driven fan attached to the front cylinder, and the cellular type of vertical tube radiator. The carbureter shuts the main air intake to facilitate starting in cold weather. Jump spark ignition with a standard storage battery, dry cells, Lacoste timer and a vibrator coil on the dash, is the regular equipment, but provision is made for the attachment of a Bosch magneto. The multiple disc clutch is contained in an aluminum housing which is part of the transmission case and runs in oil. The transmission of the sliding gear, selective type has three forward speeds, and is fitted with Hess-Bright ball bearings. Drive is by shaft to a floating type rear axle, which is equipped with ball thrust and roller-bearings. The front axle is a one-piece I-beam forging with bronze bushings for the steering spindles. The frame is pressed steel, elliptic springs being used in the rear. The brakes are of the contracting and expanding type on the rear wheel drums. This car has 106-inch wheelbase, 10 inches road clearance and 58-inch tread. The smaller car is practically unchanged, the same two-cylinder, double-opposed, water-cooled motor being used.

Bendix.—The Bendix Automobile Company, Chicago, is building four motor buggy models. No. 4 and No. 5, equipped with roadster and surrey bodies, have a four-cylinder vertical, water-cooled motor, friction transmission, double chain drive, 96-inch wheelbase, and 41-inch wheels equipped with 2-inch solid tires. Models 9-H and 9-L are roadsters with single or double rumble seats, the same motor as in other models, multiple disc clutch, selective transmission, double chain drive, 41-inch wheels equipped with 3-inch solid tires, full elliptic springs, and a wheel-

and it is of equal interest to note that even the companies which did show in the metropolis found it desirable to vary the scenery to quite some extent, in that they went to Chicago prepared to extend the interest so as to include types of cars not displayed before for 1909 selling.

In the tabulations of cars will be found quite a number which are introduced for the first time at Chicago, and the electric section will be of especial interest. The situation at Chicago, taking it as a whole, leaves little to be desired, and as before stated it is a great advantage to be able to see all the cars at one time and make a selection in the light of all the facts. Herewith are described some of the new faces, in one way or another, for 1909. They represent a certain advance in the industry, and that they are potent factors is fully assured.

base of 105 inches. The cylinders of this motor are cast in pairs with integral heads, valve chambers and water jackets; valves are all on one side and operated from a camshaft within the crankcase. The camshaft bearings are of the annular ball type; crankshaft and connecting rod bearings are of Banca babbitt with phosphor bronze wrist-pin bushings. Ignition is jump spark with Splittorf magneto, dry cells and one set of plugs; the honeycomb radiator, a centrifugal pump, and a belt-driven fan constitute the cooling system. Annular ball bearings are used throughout the transmission.

Berliet.—The Berliet, one of the only two foreign exhibitors to be at the show, is in four models for 1909. These consist of four chasses, equipped with all types of bodies, two of which, the 15-20 horsepower and the 20-30 horsepower, are shaft-drive cars, and the other two, rated at 40-50 horsepower, are chain driven. Three of these models have four-cylinder motors, and the fourth has a six-cylinder motor. All motors are of the same mechanical construction except that in the six-cylinder motor the cylinders are cast in threes, whereas in the four-cylinder the cylinders are cast in pairs, and in the 15-20-horsepower model the Thermo-syphon cooling system is used.

Clark-Hatfield.—The Clark-Hatfield motor buggy, built by the Clark-Hatfield Auto Company, Oshkosh, Wis., varies considerably from the general line of vehicles of this type, in that 39-inch wheels are used instead of the greater diameter. It also has the motor located transversely above the back axle, with a friction drive system ahead of the motor and final drive by chain to the solid one-piece rear axle. The motor, an opposed air-cooled one of the four-cycle type, has $4\frac{1}{4}$ by 4-inch cylinders cast with circumferential cooling flanges. The crankcase, made in the usual box type, has the crankshaft carried in the lower part, and the upper portion serves chiefly in the capacity of a cover and carries the camshaft. Particular care has been shown in the make-up of the motor, accessibility being kept in the foreground. The crankshaft, $1\frac{3}{4}$ -inch in diameter, has Parsons white brass bushings $3\frac{3}{8}$ inches long, all hand-scraped to size. Connecting rods are forty-point carbon steel provided for adjustment at the crankshaft end by five thin brass liners. The cylinders are bored, annealed, and finally surfaced by grinding and lapping. The cooling fins are thin and unusually deep, giving a total radiating surface of 3,600 square inches. Both sets of mechanical valves are of nickel steel, located in pockets on the upper side of the cylinder. The springs are set in pressed steel cups lined with asbestos and elevated from the cylinder walls to protect them from heat.

Columbus Electric.—The five types of electric vehicles manufactured by the Columbus Buggy Company, Columbus, O., are designated 1000, 1001, 1002, 1100 and 1202, fitted with Victoria and buggy top Stanhope, four-passenger brougham, and two or three passenger coupé bodies, respectively. Model 1000 has a multipolar type motor of about 2-horsepower and twenty-four cells of 9 M. V. Exide battery. This motor is set in an aluminum frame, fitted with annular ball bearings, and is provided with a noiseless transmission from the armature to the jackshaft, enclosed in an aluminum case. The controller is of the radial type and fool-proof. Drive to the rear axle is by means of side chains provided with mud guards. The steering gear is of the side lever type. The service brake operates on the shaft and is applied by a further movement of the controller after the motor is cut out of service, and the foot brake operates upon the rear wheel drums. The frame is of pressed steel, full elliptic rear, and half platform front springs are used; wheels are equipped with 30 by 3½-inch front and 31 by 4-inch rear tires and roller bearings. The wheelbase is 74 inches, and the car weighs 1,725 pounds. Model 1001 is the same, except that the body is fitted with a Victoria top. Model 1002 is the same as Model 1000, except that it has a two-passenger coupé body, with an extra child's seat, is inside driven and weighs 1,875 pounds. Model 1100 is also the same as Model 1000, except that it has an 86-inch wheelbase, 34 by 4-inch pneumatic tires, a 2½-horsepower motor, twenty-four cells of 11 M. V. Exide, weighs 2,250 pounds, and has a four-passenger surrey type body. Model 1202 has four-passenger coupé body, inside driven, 76-inch wheelbase, twenty-four cells of 11 M. V. Exide battery, 32 by 3½-inch front and 33 by 4-inch rear tires.

Dorris.—The Dorris car, manufactured by the Dorris Motor Car Company, St. Louis, is built with touring car, roadster, combination roadster and touring car, limousine and landaulet bodies this year, all on the same chassis, which is somewhat changed from that of previous years. The intake pipe is made of copper tubing instead of aluminum; the front engine hanger is changed so that the camshaft can be removed without removing the hanger; the clutch housing has been changed so that the crankshaft can be removed by taking off the gearbox only. The steering gear has been improved; the brakes are now operated by a cam and are lined with thermoid, and the wheelbase has been lengthened 2 inches by placing the cross spring at the rear on a bracket attached to the back cross member of the frame. The motor valves are in cages in the head and operated by means of rocker arms from one camshaft contained in the crankcase. The latter is a one-piece iron casting, with two large inspection plates on either side, held in place by a central yoke. Parsons bronze bearings are used throughout, and the connecting rods are drilled for the lubrication of the wrist pins. A mechanical oiler with six sight feeds, one for each cylinder and the two end bearings, is operated from the camshaft by means of an eccentric.

Duer.—The Chicago Coach and Carriage Company makes the Duer motor buggy, which is presented in practically the same design as last year, excepting that a larger motor is used, having a 4½-inch bore with 4-inch stroke, instead of the 4 by 4 type of last season. This motor is constructed to be interchangeable with the smaller size, which permits of buyers having an option on the horsepower when purchasing. The Duer has several characteristics, all of its own, one of which is the transmission used. The motor is air-cooled, located crosswise in front and lubricated from a two-feed mechanical oiler, one lead of which passes to the left cylinder and the other to the cam box where it feeds the two to one gear. The right cylinder is oiled entirely by splash. The reason of feeding an oil lead to the left cylinder only is that the latter is cared for by the splash from the crankcase which, owing to the rotation of the crankshaft, receives a greater quota of oil from this source than does the other cylinder. A change in the running gear of this car has been the strengthening of the axle as well as the wheels. The axles are now 1¼ inches square, and the wheels made with 1¾-inch spokes instead of 1½. The use of 44 and 48-inch wheels gives the car an out-and-out motor buggy appearance.

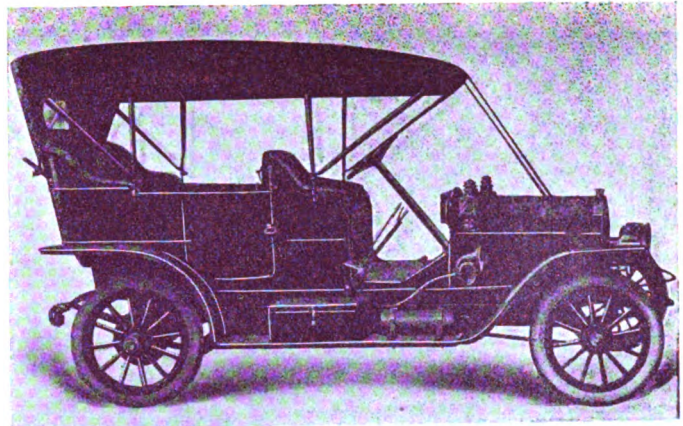

Halladay Model D Touring Car with Top Complete.

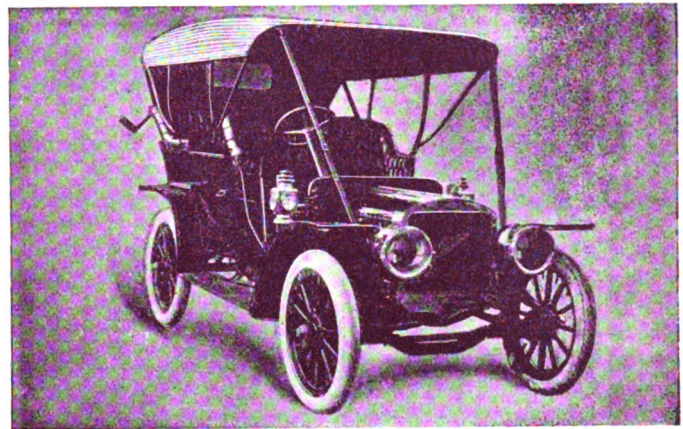

Dorris Known as Model F with Top and Accessories.

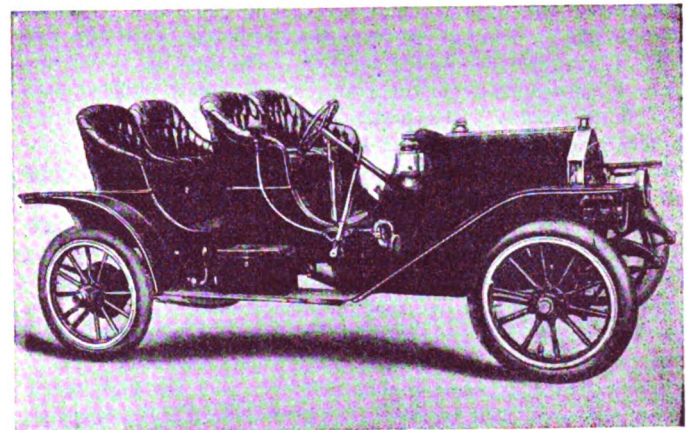

Great Western with a Body for Two Times Two.

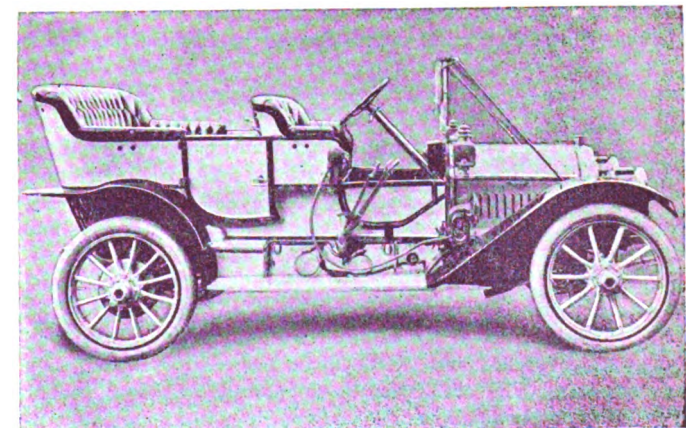

Olds Touring Car with a Roomy Tonneau and Luxurious.



Emancipator.—The Emancipator Automobile Company, Aurora, Ill., manufactures three models of pleasure cars. Model A, five-passenger

touring car, and B, four-passenger toy tonneau, and the Aurora runabout with rumble seat. These models have a four-cylinder multi-unit quadruple opposed motor, watercooled, and rated at 20 horsepower; a planetary three-point suspension transmission; floating type rear axle; 32-inch wheels; $3\frac{1}{2}$ -inch pneumatic tires and 100-inch wheelbase, but the Aurora model has a two-cylinder opposed motor, watercooled and rated at 16 horsepower, and three-quarter platform rear springs. The four-cylinder motor of the Emancipator models is located in front under the hood. The cylinders are cast in pairs, and the bases of each pair widen out to form the crankcase when the two pairs of cylinders are bolted together. The lugs by which the motor is suspended from the frame are also cast integral with the cylinder heads. The cylinders being of the L-type, all valves are located on the top side and operated by means of offset push-rods. The pistons are also cast in pairs with but one connecting rod for each pair; and the crankshaft of the two-throw type rests on two babitted phosphor bronze bearings. A cellular type radiator is used in connection with a thermo-syphon water-cooling system; ignition is by jump spark with battery and coil, and lubrication is by means of a five-feed mechanical oiler. The planetary transmission is equipped with babbit bearings, and fibre-lined steel bands acting upon pressed steel drums are used for low and reverse speeds while a cone clutch is used for high speed. The floating rear axle is equipped with Standard roller-bearings. The frame is of pressed steel; an irreversible steering gear with the tie-rod back of the front axle is used; and the brakes are of the internal and external type on the rear wheel drums.

Glide.—The Glide cars, manufactured by the Bartholomew Company, Peoria, Ill., are now built in two models, the new addition to the family being the Model R roadster. The Model G touring car is a refinement of the 1908 Glide, with but few changes. The fan is now placed on an adjustable bracket on the front cylinder; the front axle is dropped instead of straight; $4\frac{1}{2}$ -inch tires are used instead of the 4-inch; wider running boards have been fitted, and the steering gear, speed change, and brake levers have been improved. Both models are identical except for the difference in wheelbase, wheels, gasoline capacity, and the greater road clearance on the roadster. A four-cylinder Rutenber motor is used, of the vertical, water-cooled type with separately cast cylinders and valves all on one side, operated from one camshaft. The crankshaft is supported on five phosphor bronze bearings in the upper half of the case, which is of aluminum. The lower portion of the crankcase forms a reservoir for the self-contained oiling system.

Great Western.—The Great Western line for 1909, manufactured by the Model Automobile Company, Peru, Ind., consists of three chassis with four-cylinder motors, rated at 30, 40 and 50 horsepower, respectively, and one chassis with a two-cylinder motor which is a reproduction of the Model 14 of 1908, with a few minor changes, such as longer wheelbase, semi-elliptic springs in front in place of elliptics, and a high-tension magneto, which is now included in the regular equipment. The three models with the four-cylinder motors are practically the same except in length of wheel bases, sizes of tires, and spring suspension, the 50-horsepower car having semi-elliptic springs all around, but elliptic rear springs are used on the small models. The motor is characterized by its valve arrangement, the exhaust valves being located centrally in the top of the cylinder heads, and operated by means of rocker arms and push rods from the camshaft in the crankcase, while the intake valves are in the bottom of the valve chambers on the right side of the cylinders, and are operated from the same camshaft by means of adjustable lifters. The cylinders are separately cast with integral heads and water jackets and bolted on to studs which pass right through the crankcase to support the five bronze bearing caps of the crankshaft. The crankcase is of aluminum with a removable lower portion, and has two large inspection plates on either side, held in place by one central yoke for each pair. The crankshaft is heat-treated, ground and offset $\frac{1}{2}$ -inch. The water circulation is maintained by a gear driven pump located at the front of the motor on the left, and the magneto occupies the same position on the opposite side. An adjustable belt-driven fan, attached to the front cylinder, assists in the cooling. Double ignition is used, with magneto and battery. Lubrication is by means of a seven-feed mechanical oiler, which is ratchet driven, and located at the rear, on the left side under the exhaust pipe. A cone clutch is used, faced with Raybestos, with springs underneath to ease the engagement. Between the clutch, which is released through a ball-thrust bearing, and the transmission, is a double universal joint which allows of the usual sliding for disengagements. A selective gearset, giving three speeds forward, is carried on the same subframe which supports the motor, and Timken roller bearings support both shafts which lie in the same vertical plane. A floating type rear axle runs on ball-bearings, while the front axle is drop-forged of I-beam section with ball-bearing spindles. Annular ball-bearings are used in the wheels. The steering gear is of the worm and sector type; the main frame is of pressed channel steel, narrowed in front to reduce the turning radius, and the brakes are contracting and expanding on rear wheel drums. The two-cylinder car is equipped with an opposed motor located amidships on the left hand side, bringing the flywheel directly in the middle and the planetary transmission to the right.

Halladay.—In connection with its five- and seven-passenger, 40-horsepower touring car, the Streator Motor Car Company, Streator, Ill., is bringing out an entirely new model. The chassis of this new model may be fitted with either two-passenger roadster with artillery rear seat, surrey type or touring car bodies, and has a four-cylinder motor with cylinders separately cast, but having integral heads, waterjackets and valve chambers. The valves are on opposite sides and operated from two camshafts, with integral cams. The crankshaft is heat treated and ground, and Cramp's ship-metal bearings are used throughout the motor. Ignition is jump spark with storage battery and Bosch magneto as extra equipment. Lubrication is by splash in the crankcase, the level being maintained by means of a gear pump in the sump of the crankcase. A thermo-syphon cooling system is used with a vertical tube radiator, and a fan driven by belt from the crankshaft. The clutch of the multiple disk type, has twenty-eight metal disks. Drive from the clutch to the transmission, which is located on the rear axle, is through one universal joint, and a shaft enclosed in a torsion tube which is supported in front on lugs from a cross member of the frame. The transmission is of the sliding gear type with two forward speeds. Hess-Bright bearings are used throughout the transmission and Hyatt roller-bearings in the semi-floating rear axle. The frame is of pressed steel elliptic springs, being used in the rear, while the steering gear is of the worm and sleeve type with the tie-rod behind the axle. One set of contracting band brakes is provided, operated by pedal and acting on rear wheel drums. A number of improvements have been made on the Model D, 40-horsepower car, among which are a multiple disk clutch, selective sliding gear-set, the use of Hess-Bright annular ball-bearings throughout the gear-set and rear axle, and more room in the tonneau, owing to the lengthening of the wheelbase. The motor is of the Rutenber type. The crankshaft is supported on Cramp's ship metal bearings in the upper half of the aluminium crankcase. Lubrication is by splash, self-contained, the same as on the smaller car. Provision is made for the attachment of a Bosch high-tension magneto in connection with storage battery system.

Meteor.—The Meteor line, built by the Meteor Motor Car Company, Bettendorf, Ia., comprises two models, Type F, a seven-passenger touring car, and Type F1, a baby tonneau car. The same chassis is used in both, except that in the roadster model the steering column is tilted more towards the horizontal. A Fedder's square tube radiator is used and is set back on the frame 2½ inches, making the hood that much shorter. The Eisemann ignition system has been replaced by the Bosch dual system with the cylindrical coil and switch located on the dash. The fender design has also been slightly changed. These cars have a four-cylinder motor rated at 40 horsepower, a selective gearsset, and are shaft-driven. A rather unusual appearance is given to the motor by the square cylinder trunks which rest upon the aluminum crankcase. These cylinders are cast separately with the valves on opposite sides, operated from camshafts contained within the crankcase. In order to reduce the length of the motor, as well as to facilitate casting, the front and rear faces of the water jackets are cut away and rectangular plates fitted. The crankcase is divided horizontally in two parts, the crankshaft being carried on five bearings in the upper section. The forward gears are contained in oil-tight housing. Use is made of hand-buffed aluminum pipes for intake and exhaust gases as well as for both intake and outlet water pipes. The intake and exhaust manifold are similar, and the water connections are at the top side of the valve chambers instead of in the cylinder heads. The magneto is located on the right side just back of the rear cylinder, and driven through a shaft from the forward gear-housing, and the five-feed mechanical oiler, located in the same position on the opposite side, is driven in the same manner. A multiple-disk clutch of the regular alternating disk type with an easy method of adjusting the clutch tension, is fitted. The gearsset is carried in a one-piece casting, the front end of which is removable.

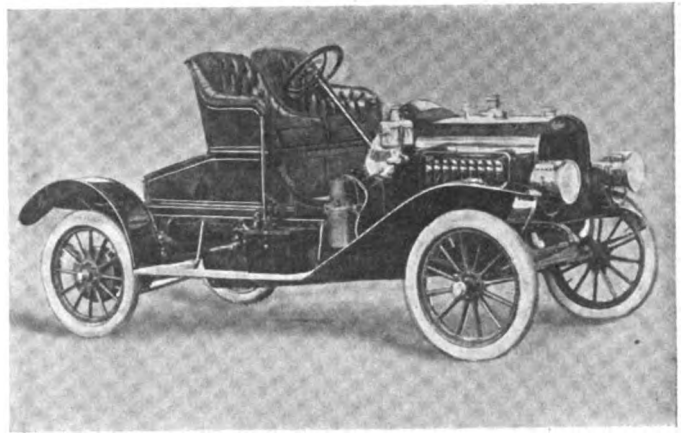

Rambler Runabout for the Professional and Pleasure.

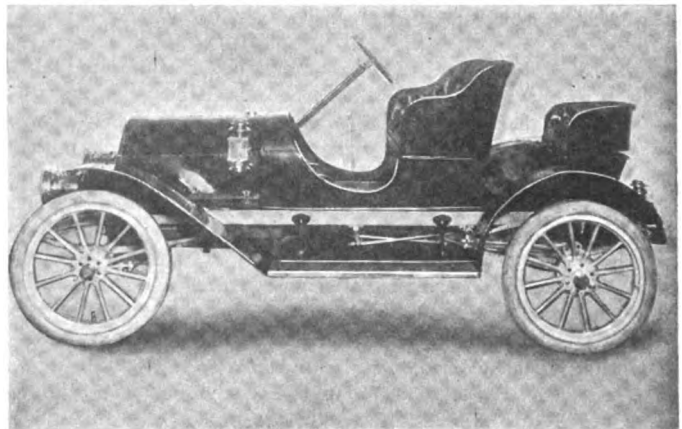

Cameron Roadster with Tools Under the Rumble Seat.

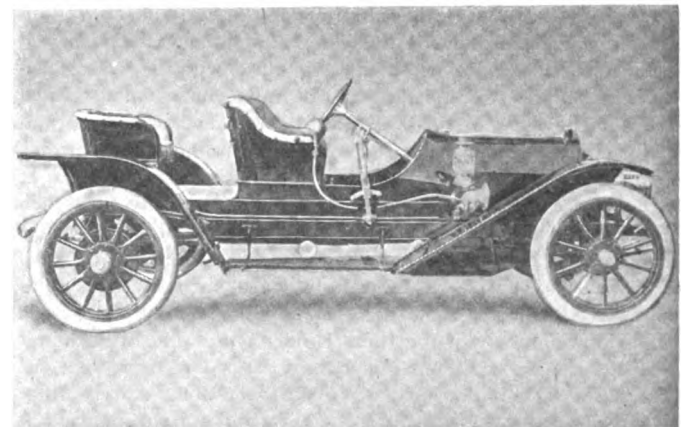

Chalmers-Detroit Runabout Built for Speed.

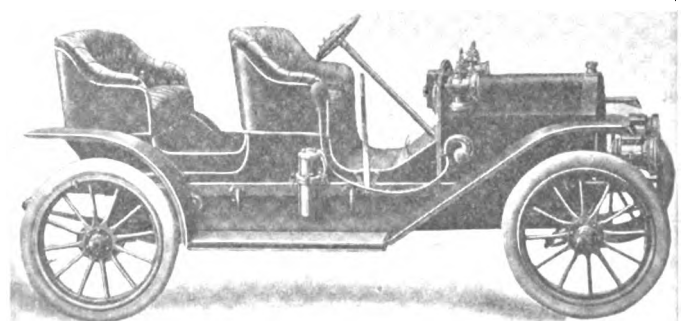

Halladay Model F with a Four-Passenger Body.



Clark-Hatfeld Wheel Steer Buggy Type for Doctors.



Zimmerman Model H Buggy Type of Roadster Elegance.

Mier.—The Mier Company, Ligonier, Ind., has four models for 1909 with runabout and surrey bodies. Models A and B are practically the same except for a few changes in regard to body construction. The chassis has a two-cylinder, water-cooled motor rated at 12.8 horsepower, A.L.A.M. Ignition is jump spark with storage battery. A tubular radiator is used in the cooling system. Lubrication is by means of a mechanical oiler. These cars have friction drive to the jackshaft and side chains to the rear wheels. An angle iron frame is used and brakes are of the expanding type. The wheelbase is 86 inches and solid or pneumatic tires may be fitted to the wheels, which are 30 inches in front and 32 inches in the rear. Models C and D are identical with Models A and B, except for body changes, and larger motors.

Oldsmobile.—The output of the Olds Motor Works, Lansing, Mich., for 1909 will consist of eight models built on four different chassis. Models D, toy tonneau and touring car, and DR, flying roadster and detachable toy tonneau, are built on a chassis with 112-inch wheelbase, 34-inch wheels, equipped with $3\frac{1}{2}$ and 4-inch tires, full elliptic rear springs, and a four-cylinder motor rated at 40 horsepower. Model X Special has 106-inch wheelbase, 32-inch wheels, $3\frac{1}{2}$ and 4-inch tires, three-fourth elliptic rear springs and a four-cylinder motor rated at 35 horsepower. Models Z, touring car and runabout, have a 130-inch wheelbase, 36-inch wheels, equipped with $4\frac{1}{2}$ and 5-inch tires, full elliptic rear springs and a six-cylinder motor rated at 60 horsepower. Model 20, the least expensive of the line, has a 91-inch wheelbase, 30-inch wheels with $3\frac{1}{2}$ -inch tires, full elliptic rear springs and a 22 horsepower motor of the four-cylinder type. The six-cylinder chassis is of the same general characteristics excepting that the parts are designed for the extra work to be done, and in other ways the "six" is in conformity with the requirements, and it represents degrees of flexibility such as will please users.

Pittsburg Six.—The Pittsburg Six cars are made by the Ft. Pitt Motor Car Company, New Kensington, Pa., in three models—a three-passenger roadster with disappearing rumble seat, a four-passenger roadster, and a seven-passenger touring car, all with practically the same chassis, excepting that for the seven-passenger touring car some frame changes are made to accommodate the larger body. Of particular interest in the Pittsburg six-cylinder chassis is the use of separately cast cylinders with opposite valves. This year a new style of intake manifold has been adopted. It is of the loop variety, in which a horizontal pipe gives off a lateral branch to each cylinder, this pipe being parallel with the feeding pipe of the same length from the carburetor uniting with it by end loops, so that the mixture leaving the carburetor travels in both directions through the feeder pipe. The mixture thus travels the same distance to each cylinder, part going in one direction and part in the other. The motor has shown a greater speed range since the adoption of this manifold. Another change this year is the employment of a Hele-Shaw multiple disk clutch which supersedes the cone type of former years. This clutch is of the regular Hele-Shaw type with corrugated disks, but incorporating certain changes which the American licensee has seen fit to make for American needs. A further change is the employment of vanadium steel in the rear axle, to which might be added a line of general improvements in many small details on the car. The Pittsburg Six motor for all three chassis is made with cylinders having $4\frac{3}{4}$ -inch bore and $5\frac{1}{4}$ -inch stroke, and is rated at 54.72 horsepower. According to the A.L.A.M. formula, is 54.6 horsepower. The cylinders are bored and ground to finish, the crankshaft revolves on seven bearings, and the valves have nickel-steel heads electrically welded to mild steel stems. The crankcase, cast in upper and lower halves, makes use of the lower as an oil reservoir in conjunction with splash lubrication.

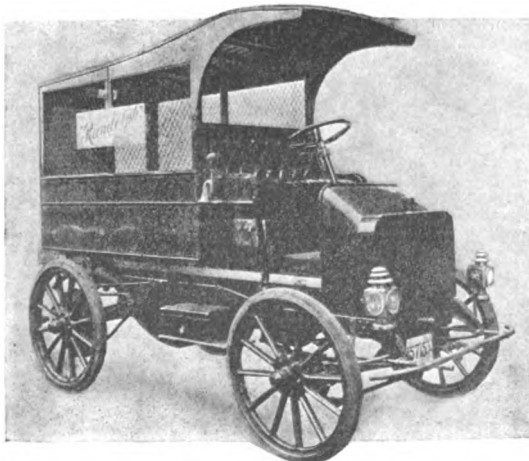

Randolph Delivery Wagon with Cage Body.

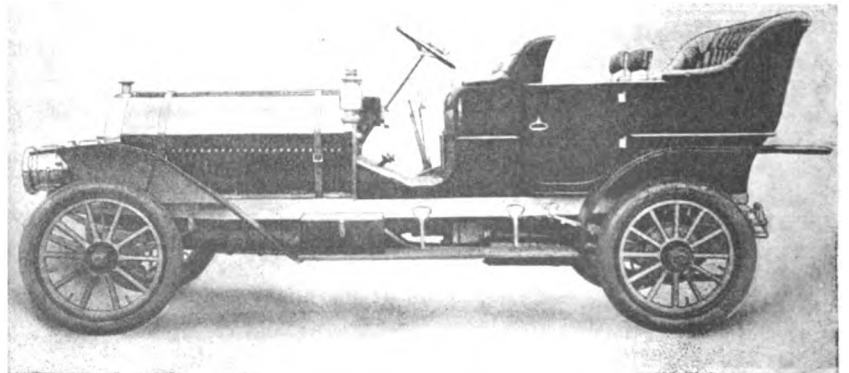

Popular Pittsburg Six Known as Model D.

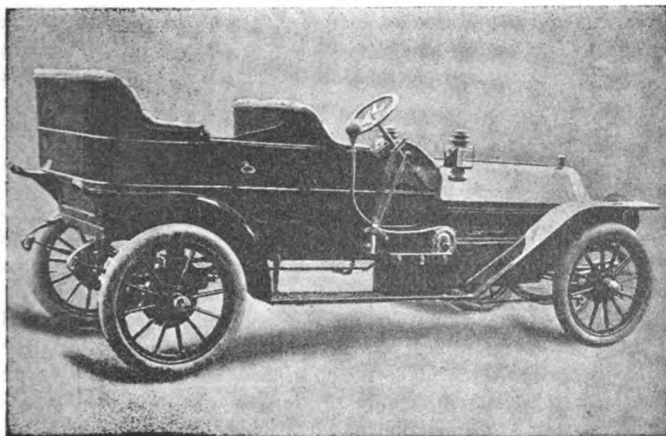

Rider-Lewis Touring Car Rides on Scroll Elliptics.

Rambler.—The major efforts of Thomas B. Jeffery & Co., Kenosha, Wis., will be on four-cylinder cars, but a couple of two-cylinder types are also being marketed. The four-cylinder chassis are alike in design, but vary in size and constructive strength. They are known as models 44 and 45, the former a 34-horsepower chassis with cylinders $4\frac{1}{2}$ inches square and fitted with five-passenger body; and model 45, a 45-horsepower chassis with 5 by $5\frac{1}{2}$ -inch cylinders and seven-passenger body. In addition, however, both chassis are fitted with roadster and toy tonneau body style, and the company is manufacturing closed body types. The Rambler chassis contains several improvements over the 1908 type. The location of the timer at the right front of the motor has been improved by raising it, resulting in increased accessibility. The use of the magneto in conjunction with the batteries results in a complete dual system. The Rambler roller contact timer is used in which the wires remain stationary during any advance or retard of the spark. A change in the lubrication system is that the oiler is mounted lengthwise and further to the rear than last year. In the new location, its accessibility is increased and the capacity has been increased 50 per cent. The water pump is now located back of the transverse tubular support at the front end, and in this new location is entirely separate from the half-time gear housing. An important improvement in the selective gearset is that the two shifter rods are carried in a boss in the right side of the case, one being a rod and the other a surrounding sleeve. On the rear end of each is a short arm with ball ending, with which the shifter mechanism attaches. A change in the clutch is the discontinuance of the balanced type of inverted cone heretofore used and the adoption of a direct cone with a 50 per cent. greater friction surface.

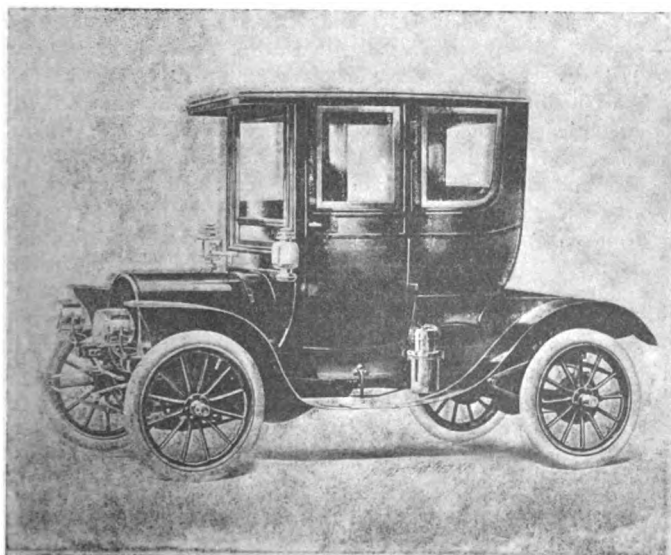

Franklin Straight Front Brougham for Town Service.

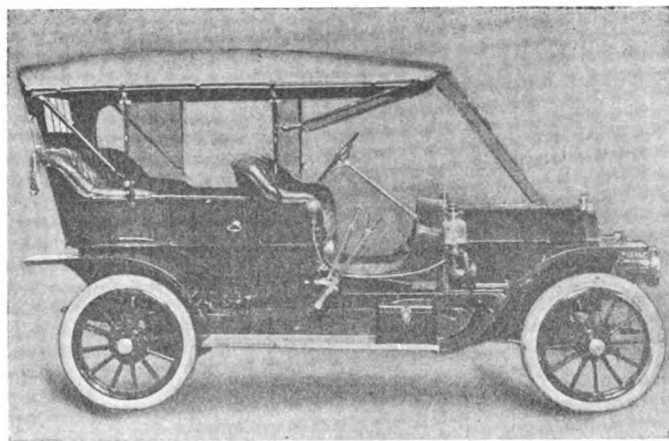

Auburn Touring Car with a Canopy Top and Room.

Randolph.—The Randolph motor truck is a new Chicago product, manufactured by the Randolph Motor Car Company, and is somewhat exclusive in its lines, in that it is designed for a 1,250-pound load and combines in its make-up a transmission system not common in vehicles of this capacity. Its chassis contains a two-cylinder opposed motor mounted transversely in front and transmission from this is through a planetary gearset of the conventional disk and wheel type, the wheel mounted on a cross jackshaft on the ends of which are sprockets for driving to the rear wheels. The car, built with an 80-inch wheelbase, and 34-inch front and 36-inch rear wheels, is well adapted for light delivery purposes and is built with enclosed bodies of wire screen or panel variety. Most notable is the dropping of the frame at the front end, which lowers the center of gravity to some extent and makes it possible to use a fairly large friction disk without encroaching upon the load-carrying space. The front of the frame is supported on semi-elliptics in the usual manner, but full elliptics do service in the rear, supporting the frame through trunnions. A differential gear is used on the cross shaft carrying the friction wheel, and when engaging the friction wheel with the friction disk the jackshaft is not carried forward as so frequently done in friction constructions, but the disk is thrust rearward against the wheel. The motor rated at 22 horsepower, uses conventional water-jacketed cylinders with valve chambers, so that the valve springs, etc., are accessibly located. The cylinders bolt to opposite sides of the crankcase and end plates are used for the bearings, which does away with the splitting of the case. The top is a removable plate, and when off discloses the valve mechanisms. Cooling is by thermo-syphon, the water course being from the radiator base to the motor.

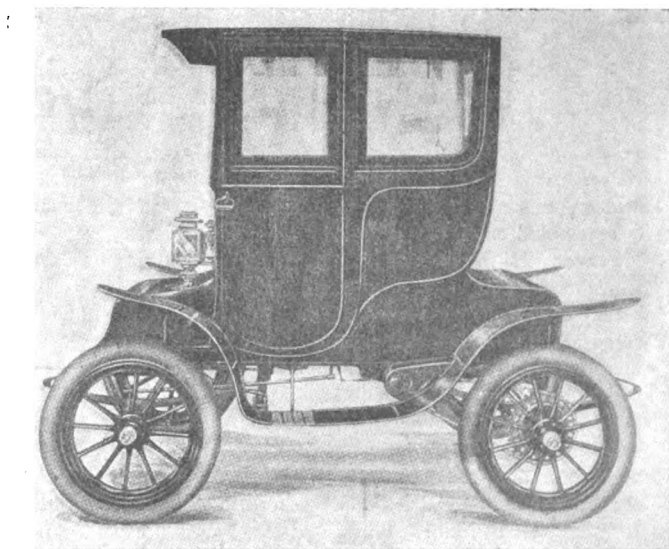

Columbus Electric for Town Car Service.

Richmond.—The Richmond line for 1909, manufactured by the Wayne Works, Richmond, Ind., consists of three models—J-1, J-2, and J-3—all of which have the same chassis construction with a few minor exceptions, such as length of wheelbase, size of tires and motor. Model J-1, a runabout with a detachable rumble seat, has an 88-inch wheelbase, 3-inch tires, and a motor rated at 22.5-horsepower. Model J-2, a runabout with a double seat in the rear, has a 96-inch wheelbase, 3½-inch tires, and a 22.5-horsepower motor. Model J-3, a light touring car with baby tonneau, has 102-inch wheelbase, 3½-inch tires, and a motor rated at 25.6-horsepower. The motors in these cars are all of the same L type, four cylinders, vertical, air-cooled, with integrally-cast heads, valve chambers and cooling flanges. Valves are all mechanically operated from one camshaft. The intake valves are located in the top of the valve chamber, and are operated by means of rocker arms, and the exhaust valves, located in the bottom of the valve chamber, are operated direct from the lifters below.

Ricketts.—The Ricketts Automobile Works, South Bend, Ind., are manufacturing three models on a standard chassis. These cars are fitted with baby tonneau, five-passenger touring, and three-passenger roadster bodies. The prominent features of this chassis are the unit power plant with its three-point suspension, six-cylinder, water-cooled, valves-in-the-head motor, multiple-disk clutch, selective gearset, propeller shaft with one universal joint enclosed in a torsion tube, the straight-line drive, and the floating-type rear axle. The cylinders of this motor are cast in pairs and the valves are all operated from one camshaft contained within the crankcase. The flywheel is located in front of the motor and the gearbox is bolted on to the rear end of the crankcase. At the front of the motor between the flywheel and the crankcase is a transverse shaft, driving the water pump on one end and the U. & H. magneto on the other. The timing gears at the forward end are contained in the crankcase proper. At the rear end the gearset is designed with the mainshaft above the countershaft and the multiple-disk clutch is carried within the gearbox housing. The clutch and brake pedals are attached directly to the gearbox housing. Double ignition is used with two sets of plugs, dry cells, Heine coil and magneto. Lubrication is self-contained with a gear-driven double-gear pump to circulate the oil.

Rider-Lewis.—Three models, all built on a standard chassis with a six-cylinder water-cooled motor, comprises the 1909 line of the Rider-Lewis Motor Car Co., Muncie, Ind. These cars are equipped with five and seven-passenger touring, four-passenger toy tonneau, or two and three-passenger roadster bodies. Although they are designed along the lines of conventional construction, they have a number of distinguishing features, the most striking of which is the design of the motor. The cylinders are separately cast with integral spherical-shaped water jackets; the valves are contained in cages in the heads, a little to the right and left of the center, and are operated by means of rocker arms from an overhead camshaft centrally located along the tops of the cylinders. This camshaft is driven by means of double gears and a vertical shaft in front of the motor, the cams and rocker arms being protected by an aluminum housing. The crankcase is of one-piece construction into which the crankshaft is assembled endwise, and closed in by end plates.

Staver High-Wheeler.—The Staver Carriage Company, Chicago, is marketing one model of motor buggy for 1909. It is of the three-passenger roadster type with a four-cylinder motor rated at 22 horsepower, multiple-disk clutch, a sliding-gear transmission, 92-inch wheelbase, and 38-inch wheels equipped with 2-inch solid tires. These cylinders are cast separately with integral heads, valve chambers and water jackets; valves are on opposite sides and are operated through pushrods. The crankcase is of aluminum and of two-part construction, supporting the crankshaft in the upper half, the lower portion forming the reservoir for the self-contained oiling system, the oil circulation being maintained by means of a gear-driven, gear pump. The thermosiphon cooling system is used in connection with a honeycomb

radiator; and ignition is jump spark with storage battery, and Bosch high-tension magneto as extra equipment. The sliding gear transmission is located on the rear axle and equipped with ball bearings.

Owen Thomas.—The Owen Thomas Six, manufactured by the Owen Thomas Company, Janesville, Wis., makes its first appearance in the field of high-class automobile competition this year. After 2 years of trying out parts, making jigs, tools, templates and gauges to produce interchangeable parts in quantities, the Owen Thomas company is now offering one type of chassis equipped with either seven-passenger touring, five-passenger roadster, or two or three-passenger runabout bodies. The power units are all the same and include all operating levers, pedals, etc., independent of body or frame; the variation in wheelbase affecting only the length of the torsion tube and drive shaft. The engine and transmission form a unit power plant all working parts of which are encased, run in oil and are supported on three points. By loosening a few nuts, the body with the rear axle and torsion tube can be wheeled back, leaving the power plant on the front axle and all parts of the engine and transmission accessible.

The crankshaft is a patented construction, cut from a solid billet of hammer-forged oil-tempered Vanadium steel with ground bearings. Instead of the ordinary crank arms, hollow disks are used between the crank pins; these disks are a little larger in diameter than the outside of the pins. The crankcase being of one-piece construction, is bored out so that the crankshaft with its bearings can be inserted through the rear of the case. The transmission case is bolted to a flange on the engine case to form the unit power plant. On the front end of the crankshaft is bolted a spiral gear from which the valves, generator, oil pump, fan and fuel pumps are driven. All gears used in the motor are of the spiral type. Rotary valves are used doing away with all springs, cams, pushrods, etc. One valve is placed in the head of each cylinder supported on ball-bearings.

A direct-current generator of special design is driven from the forward end of the crankshaft and supplies current for the ignition and lighting systems, besides keeping the storage batteries full charged. The batteries are also used in starting the engine. No distributor or timer is used in the ignition system, both of these functions being performed in supplying fuel by direct injection into the cylinders. For exterior cooling, a cast aluminum fan forces air against the outside of the cylinders. The clutch is of the expanding ring type and runs in oil, the ring being of bronze and expanding into the rim of the flywheel.

Zimmerman.—The Zimmerman Mfg. Co., Auburn, Ind., has four models for 1909, one of which, Model G, a motor buggy type, has a double disk friction transmission and the other three, Models H, I and K, runabout, surrey and three-passenger roadster, are all fitted with planetary transmissions. The motors on these buggies are all of the same mechanical construction, but differ in dimensions and horsepower. All are air-cooled with two opposed cylinders of the L-type, which are offset and bolted to the cast-iron crankcase. The valve chambers and cooling fins are integrally cast and the valves, which are contained in detachable cages, are operated by pushrods from a single camshaft contained in the upper portion of the crankcase. This upper portion is removable with the pushrods and camshaft intact. The crankshaft and connecting rods are steel forgings and fitted with bronze bearings of extra length. Lubrication is by means of a mechanical oiler; ignition is jump spark with vibrating coil on the dash and dry cells. The carbureter is of the float feed type and a ball-bearing roller-type commutator is used. The large fan flywheel materially assists in the cooling. The frame is of angle steel; and whereas the springs on Model G are of the full elliptic type, two in number, those of the other models are of the three-quarter scroll type, four in number, and attached to each corner of the frame. The brakes are of the expanding type on the rear wheels and operated by pedal.

TREND IN TRANSMISSION PRACTICE

By Thos. J. Fay

IN the automobile's early days steam was generously used, and steam engines are so flexible as not to require a transmission gearset. In steam motors it is easy to reverse the direction of motion, and as a result the early designers of automobiles did not contemplate the use of a transmission gearset as it will be found in automobiles of the present day.

When the internal combustion gasoline motor came into vogue it was soon found that to reverse motion was to labor under disadvantages in divers ways. Power would be lost owing to the inferior timing relation which must follow if the camshaft was designed to suit reversing conditions. Unless certain complications were introduced into the valve action, and since, in any case, it would be necessary to add to the flexibility of the motor by the use of gearsets, it would seem unnecessary to add to the valve motion anything by way of complicated devices, since an addition to the gearset would be less complicated and the end would be adequately served.

The present status of the devices utilized in connection with motors as used in automobiles for the purpose of obtaining the best results came as the product of much "cut and try," following many failures of methods which seemed to be right, in the absence of experience. Of course many old ideas had to be abandoned. True, the theory of "machines" still holds, and it was the lack of proper application of the theory which led to the earlier failures, or indifferent successes.

The ideas of the present are in full accord with the theory of "machines," and the results are so thoroughly good as to leave little to be desired. That there are many things yet to be done is conceded, but they are advances as the zone of activity of the industry broadens.

Some Basic Considerations of Transmissions.

If motors could be so designed as to afford an increasing torque with decreasing speed, and certain relations of torque considering speed, all would be well, and the transmission gear could be eliminated. As it is, taking into account the power of motors at the several speeds, nothing of the sort can be considered. It is a well-established fact that cars take power in a certain proportion up to say 20 miles per hour; after which speed the wind resistance begins to be a factor, and from that point on the power must be increased in accordance with the effect of the wind resistance, which becomes the dominant factor. At very low speeds torque becomes of the greatest importance, as for illustration, if a car is plowing its way through sand, necessarily slowly, it is low speed and high torque that are wanted.

Taking the motor performance alone, it is to note that the torque falls off as the speed decreases below a certain point, and the torque also decreases as the speed increases above a certain point. In a word, the torque of a motor is not in conformity with the requirements of the car, either at the low or the high speed. This is not to say that all motors perform in a like manner in this respect. Some motors will deliver power at higher speeds than will others, due to the shape of the torque curve—which can be influenced by the design—to a very considerable extent. In some mo-

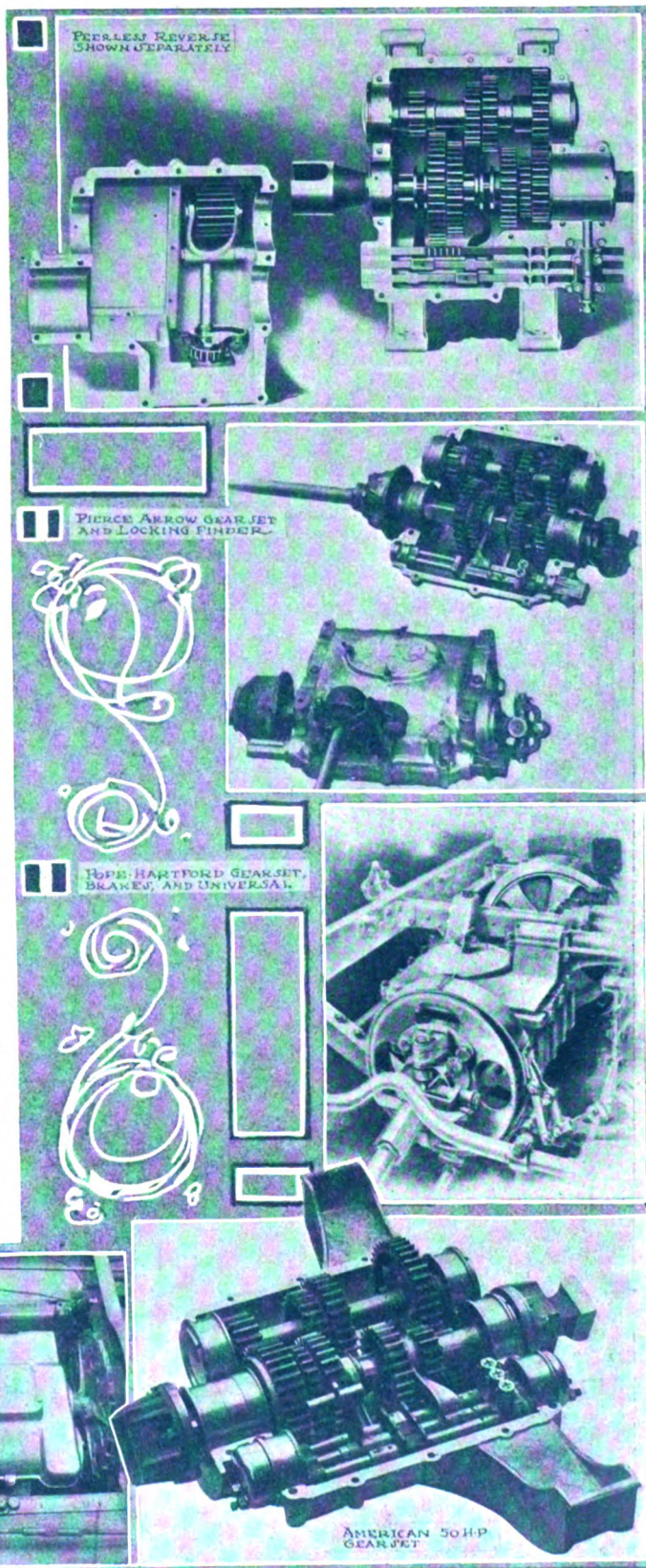

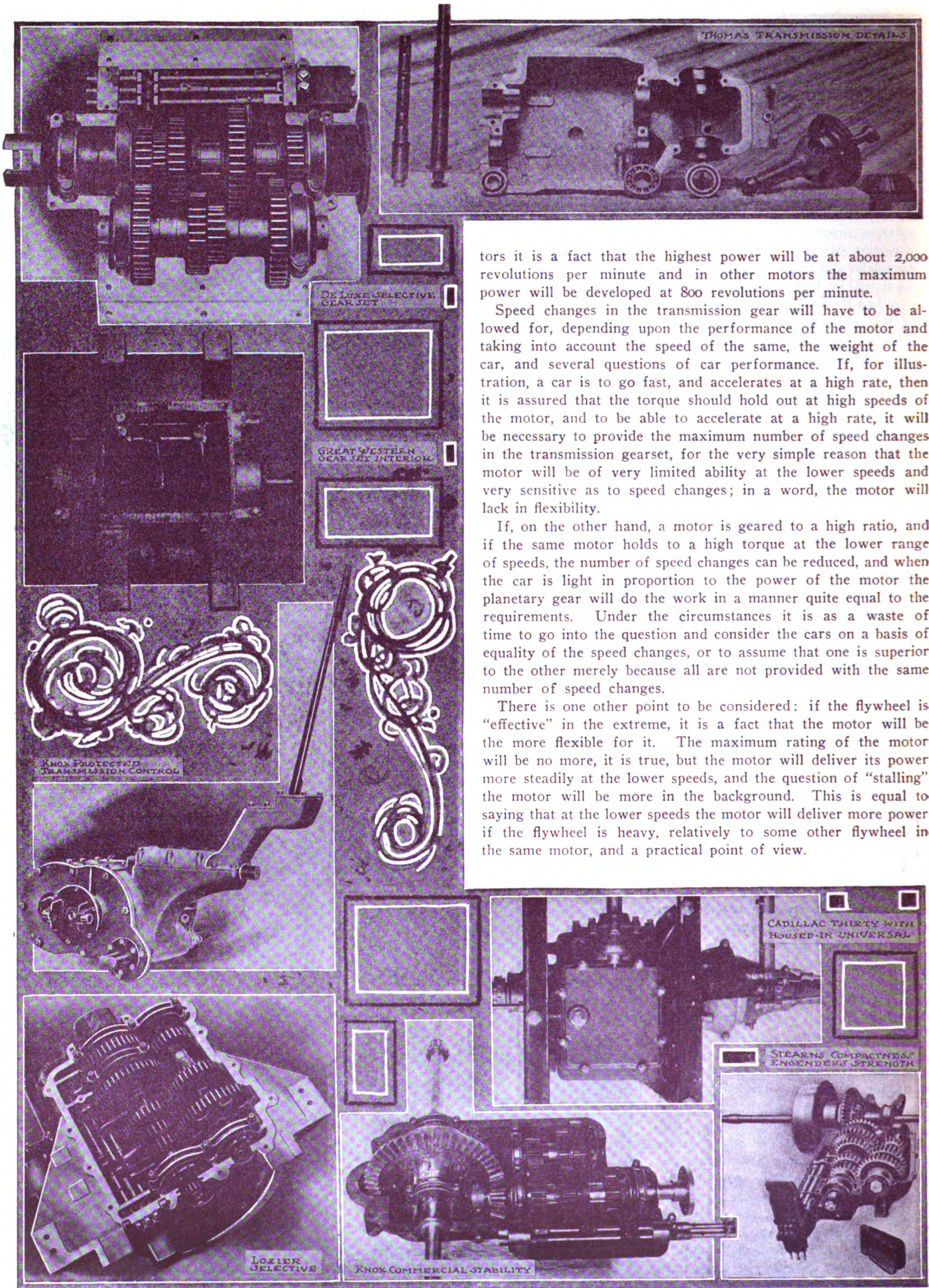

tors it is a fact that the highest power will be at about 2,000 revolutions per minute and in other motors the maximum power will be developed at 800 revolutions per minute.

Speed changes in the transmission gear will have to be allowed for, depending upon the performance of the motor and taking into account the speed of the same, the weight of the car, and several questions of car performance. If, for illustration, a car is to go fast, and accelerates at a high rate, then it is assured that the torque should hold out at high speeds of the motor, and to be able to accelerate at a high rate, it will be necessary to provide the maximum number of speed changes in the transmission gearset, for the very simple reason that the motor will be of very limited ability at the lower speeds and very sensitive as to speed changes; in a word, the motor will lack in flexibility.

If, on the other hand, a motor is geared to a high ratio, and if the same motor holds to a high torque at the lower range of speeds, the number of speed changes can be reduced, and when the car is light in proportion to the power of the motor the planetary gear will do the work in a manner quite equal to the requirements. Under the circumstances it is as a waste of time to go into the question and consider the cars on a basis of equality of the speed changes, or to assume that one is superior to the other merely because all are not provided with the same number of speed changes.

There is one other point to be considered: if the flywheel is "effective" in the extreme, it is a fact that the motor will be the more flexible for it. The maximum rating of the motor will be no more, it is true, but the motor will deliver its power more steadily at the lower speeds, and the question of "stalling" the motor will be more in the background. This is equal to saying that at the lower speeds the motor will deliver more power if the flywheel is heavy, relatively to some other flywheel in the same motor, and a practical point of view.

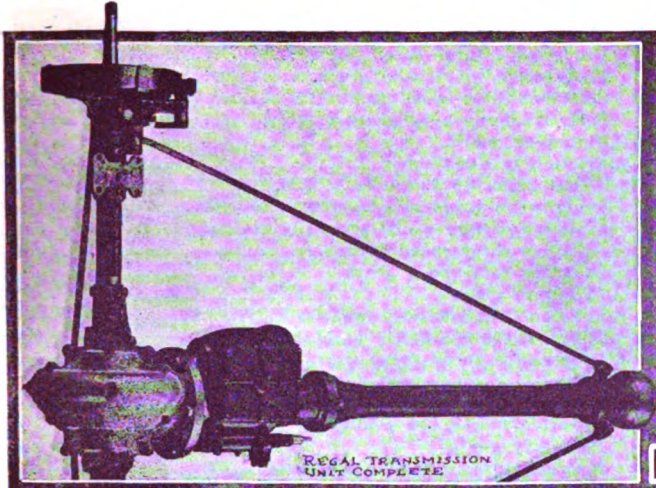

REGAL TRANSMISSION UNIT COMPLETE

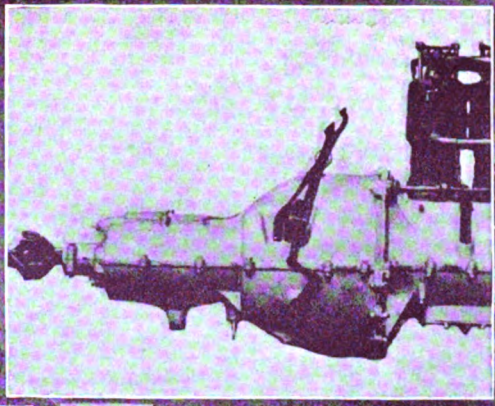

AUTOCAR SELF CONTAINED UNIT

Autoists are prone to question the ratings of motors (from the point of view of the maximum rating) if they find that some motors are rated higher than others, considering the same bore and stroke. This is not a question that they generally handle in a manner to accord with the true facts. In the first place, if a motor is designed to deliver its maximum power at a very high speed, it is plain that some other motors designed to deliver its maximum power at a far lower speed (if both motors are of the same bore and stroke) will be a motor of lower power.

Why the differences? Why not have all the motors designed to deliver the maximum possible power? Why, because it would be the height of folly. Take, for illustration, motors in the racing car types; put the same motors in a truck; what possible chance would the truck have of sustaining a good reputation? None; the misfit would be only too evident, and the only way the motor could be made to work would be through the use of a gearset of many speed changes.

Possibly, the reader will say, if this is an article in relation to transmission gears, why not confine it to them? It will scarcely be necessary to say that it is being confined to the subject, on the ground that the transmission gearset is as an accessory to the motor, an interpreter of the same, in the interest of the chassis. Without the motor it would be unnecessary to have the transmission, whereas with the motor it is possible to get some work out of the balance of the combination minus the transmission gearset.

No discussion of the questions involving the transmission gearset can be of the slightest value if it is divorced from the motor. It is the lack of ability of the motor that ends in the use of a transmission gearset, and the real question is, How can the motor be devised to do without the transmission gear, or how can the motor be made the more efficient for the purpose, or why are the transmissions at variance with each other? That they are at variance with each other is a fact that is too apparent to require even the merest statement, and that the reasons are good is also a fact that will easily float to the top at the behest of but the slightest investigation.

Departing from what might be termed vague admissions of fact, and insinuations of terms of the natural limitations, let it be said that something more tangible will whet the interest.

By way of further light on the several phases of the subject, let the cars of the year be counted, and by so doing, ascertain the facts, from the point of view of the transmissions actually used in them. In this manner it will be possible to note if the trend is in accord with what would seem to be the requirements. The following is a very close count of (transmission gear) noses:

CARS COSTING LESS THAN \$1,000 (A.L.A.M.).	
Progressive three-speed gears.....	0
Progressive four-speed gears.....	0
Selective three-speed gears.....	0
Selective four-speed gears.....	0
Planetary gears	1
Friction transmission	1

AUTOCAR SELF CONTAINED UNIT

RAMBLER REAR AXLE AND TRANSMISSION

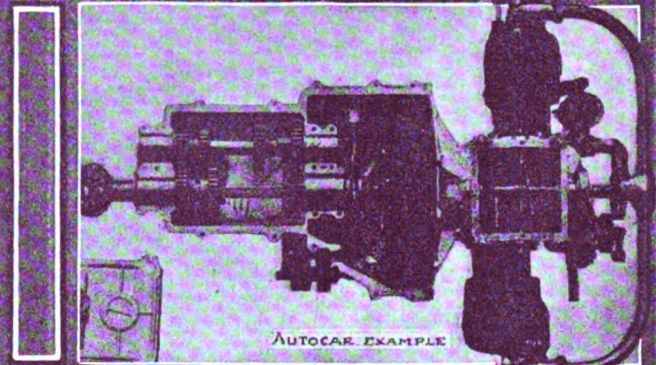

AUTOCAR EXAMPLE

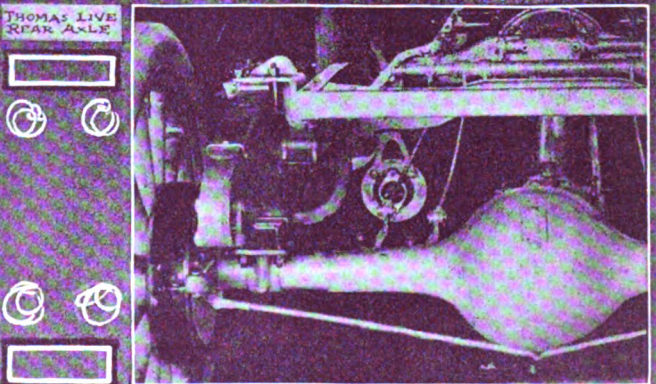

THOMAS LIVE REAR AXLE

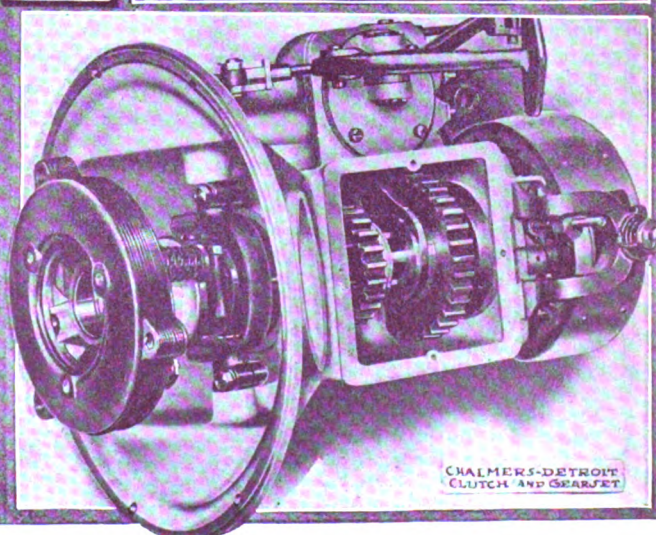

CHALMERS-DETROIT CLUTCH AND GEARSET

COSTING FROM \$1,000 TO \$2,000 (A.L.A.M.).

Progressive three-speed gears.....	1
Progressive four-speed gears.....	0
Selective three-speed gears.....	13
Selective four-speed gears.....	0
Planetary gears.....	0
Friction transmissions.....	0

COSTING FROM \$2,000 TO \$3,000 (A.L.A.M.).

Progressive three-speed gears.....	2
Progressive four-speed gears.....	0
Selective three-speed gears.....	26
Selective four-speed gears.....	1
Planetary gears.....	0
Friction transmissions.....	0

COSTING FROM \$3,000 TO \$4,000 (A.L.A.M.).

Progressive three-speed gears.....	8
Progressive four-speed gears.....	0
Selective three-speed gears.....	8
Selective four-speed gears.....	11

COSTING FROM \$1,500 TO \$2,000 (A.M.C.M.A.).

Progressive three-speed gears.....	0
Progressive four-speed gears.....	0
Selective three-speed gears.....	30
Selective four-speed gears.....	0
Planetary gears.....	0
Friction transmissions.....	2

COSTING \$2,000 TO \$3,000 (A.M.C.M.A.).

Progressive three-speed gears.....	1
Progressive four-speed gears.....	0
Selective three-speed gears.....	35
Selective four-speed gears.....	0
Planetary gears.....	0
Friction transmission (gearless).....	2

COSTING \$3,000 TO \$4,000 (A.M.C.M.A.).

Progressive three-speed gears.....	4
Progressive four-speed gears.....	4
Selective three-speed gears.....	18
Selective four-speed gears.....	5
Planetary gears.....	0
Friction transmission (gearless).....	1

CARS COSTING FROM \$4,000 TO \$5,000 (A.M.C.M.A.).

Progressive three-speed gears.....	1
Progressive four-speed gears.....	0
Selective three-speed gears.....	6
Selective four-speed gears.....	6
Planetary gears.....	0
Friction transmission.....	0

CARS COSTING MORE THAN \$5,000 (A.M.C.M.A.).

Progressive three-speed gears (semi).....	1
Progressive four-speed gears.....	0
Selective three-speed gears.....	5
Selective four-speed gears.....	5
Planetary gears.....	0
Friction transmissions.....	0

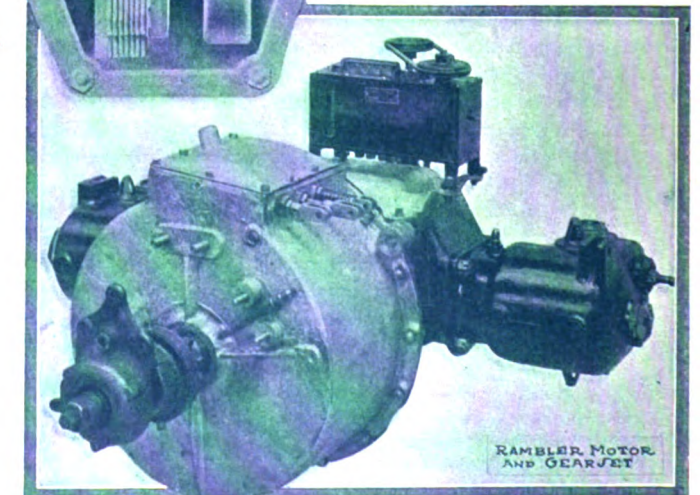
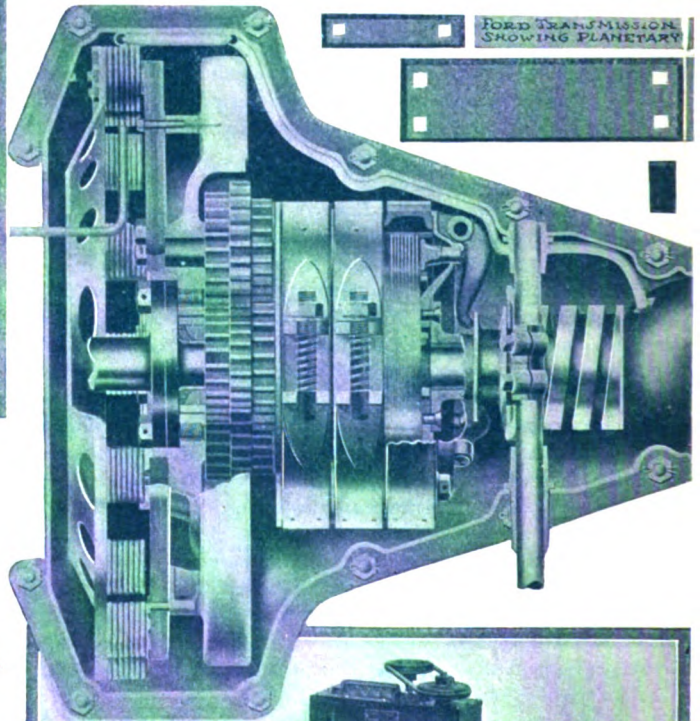
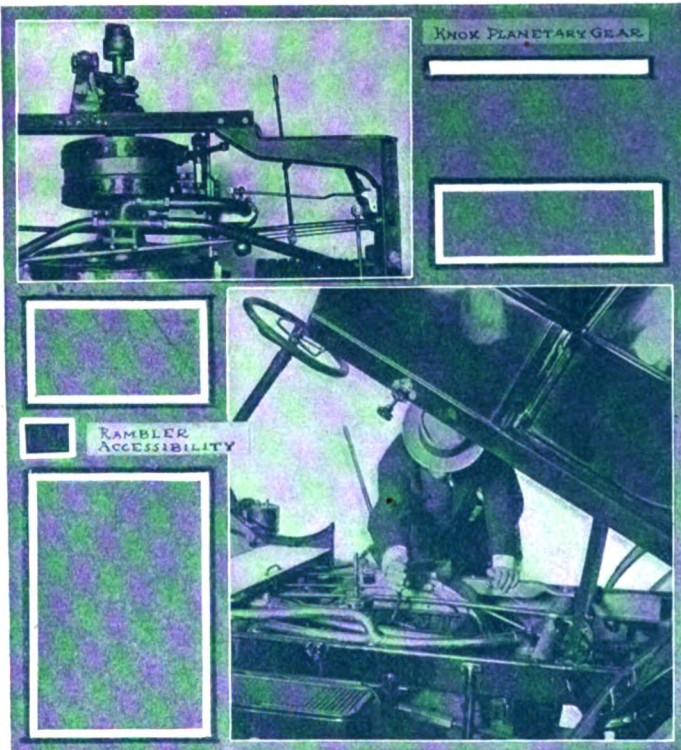

Planetary gears.....	0
Friction transmissions.....	0

COSTING FROM \$4,000 TO \$5,000 (A.L.A.M.).

Progressive three-speed gears.....	2
Progressive four-speed gears.....	3
Selective three-speed gears.....	2
Selective four-speed gears.....	22
Planetary gears.....	0
Friction transmissions.....	0

RECAPITULATION, WITHOUT RESPECT TO PRICE (A.L.A.M.).

Progressive three-speed gears.....	13
Progressive four-speed gears.....	3
Selective three-speed gears.....	59
Selective four-speed gears.....	34
Planetary gears.....	1
Friction transmissions.....	1

CARS COSTING LESS THAN \$1,000 (A.M.C.M.A.).

Progressive three-speed gears.....	1
Progressive four-speed gears.....	0
Selective three-speed gears.....	4
Selective four-speed gears.....	0
Planetary gears.....	16
Friction transmissions.....	5

COSTING FROM \$1,000 TO \$1,500 (A.M.C.M.A.).

Progressive three-speed gears.....	0
Progressive four-speed gears.....	0
Selective three-speed gears.....	20
Selective four-speed gears.....	0
Planetary gears.....	7
Friction transmissions.....	2

The following recapitulation of the cars of the A. M. C. M. A. shows that the three speed selective system has taken a hold of the industry in a way to be called vigorous to say the least. An inspection of the transmission gears as here illustrated will show a very decided compactness, especially in connection with the progressive types, more particularly of the three speed designs, many of which are "direct on high," which is also a strong factor for compactness and stability. This question of rigidity is one which will be better understood when the designs of the gear-spindles are taken into account a little later. Obviously it is an advantage to have the members quite as short as possible, for then the bending moments will induce less flexure, and the dynamic life of the members will be increased.

RECAPITULATION WITHOUT RESPECT TO PRICE (A.M.C.M.A.).

Progressive three-speed gears.....	8
Progressive four-speed gears.....	4
Selective three-speed gears.....	118
Selective four-speed gears.....	16
Planetary gears	0
Friction transmissions	0

Considering all the cars of the makes in the two associations, of which knowledge is available, the situation without respect to price is as follows:

RESUME OF THE STATISTICS OF GEARSETS OF ALL MAKES.

Progressive three-speed gears.....	21
Progressive four-speed gears.....	7
Selective three-speed gears.....	177
Selective four-speed gears.....	50
Planetary gears	24
Friction transmissions	13

Considering some 292 automobiles, the approximate percentage situation is as follows:

Progressive three-speed gears.....	9.2 + per cent.
Progressive four-speed gears.....	2.4 — per cent.
Selective three-speed gears.....	60.6 + per cent.
Selective four-speed gears.....	17.1 + per cent.
Planetary gears	8.2 + per cent.
Friction transmissions	4.4 — per cent.

Comment in relation to the percentages of the respective classes of transmissions in actual use is a waste of time, but it will be worth saying that there has been a decided shift, in that the time was when progressive four-speed gears predominated. In view of the fact that these transmission gearsets took up much room, and weighed overmuch, they have been eliminated in many cases, despite the fact that there are properties in the progressive system that made many friends. As it is, the chances are that the several systems have been reduced to good practice, taking into account the point of view, which is everything in automobile work.

In the progressive system it is true that less skill is required when it comes to accelerating a car, since it is necessary to throw in the low gear first and progress to the high gear. This is at the expense of a little time, and the motor is enabled to pick up. If, on the other hand, it is the selective system that is used, the operator can be mistaken as to the gear to use, unless selections are made in regular increments, from the low gear to the high, without skipping any available gear.

Since it is but a matter of a little skill to be able to select the most suitable gear ratio in any case, many of the experienced drivers take kindly to the selective system. The only way by which the question becomes annoying is when an autoist who has been using one of the systems finds himself in possession of a car equipped in the other way. It naturally will take a little time to get used to the change.

Materials Suitable for Use in Transmission Gears.

This is a branch of the work which must receive the most careful attention if it is to be attended with notable results. A fairly detailed discussion of this phase of the subject may be in order in view of the general advances made in connection with the automobiles for the year, rather with the idea of show-

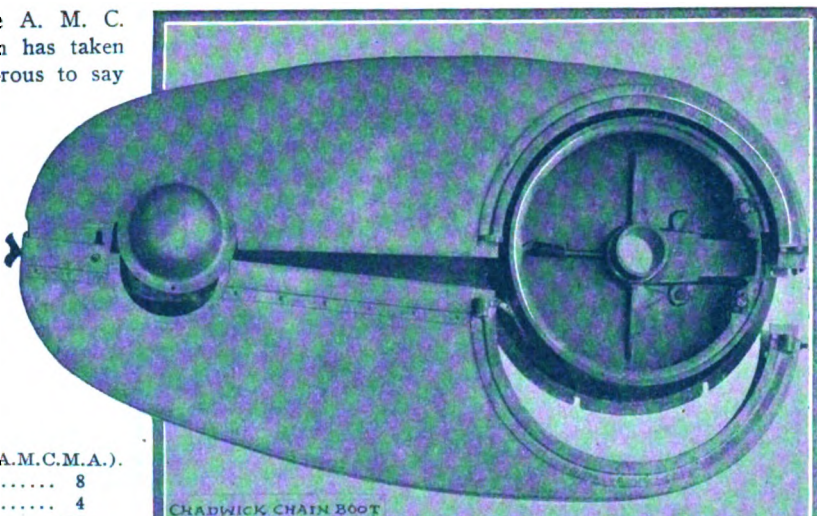

CHADWICK CHAIN BOOT

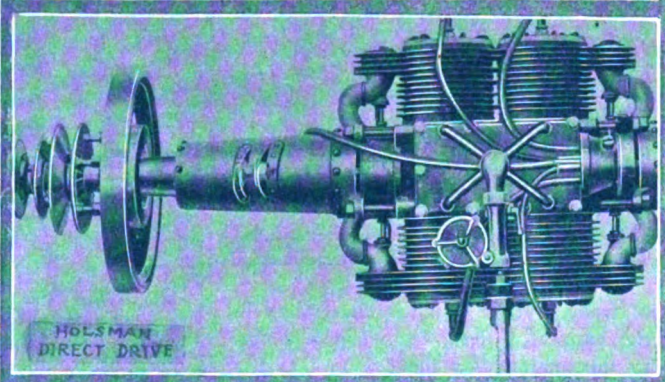

HOLSMAN DIRECT DRIVE

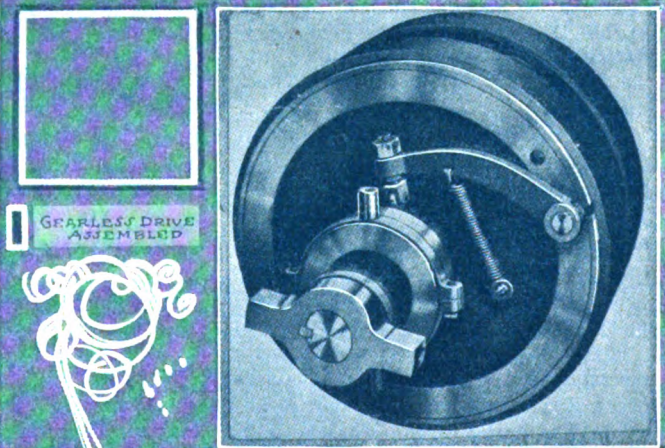

GEARLESS DRIVE ASSEMBLED

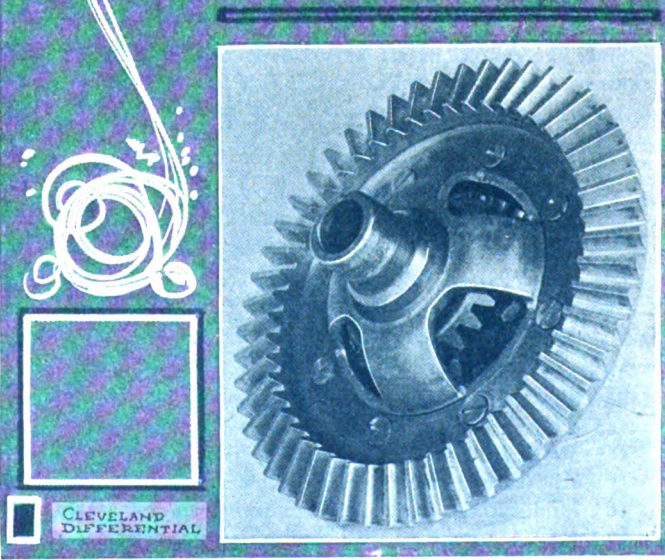

CLEVELAND DIFFERENTIAL

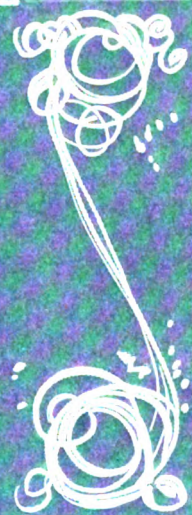

ing the extent of the advances, with the further notion of affording information to those who may need it, and that buyers of cars will really be able to see why the question of the relative cost is not one which can show on the surface. The other side of the question is one in which it is intended to show that the cost of the material is not to be the sole criterion.

That the quality of the material to use must be disposed of before the design is fixed upon, is assured; it would be as a waste of time to lay out a structure on a basis of the use of steel and then substitute lead for the steel; and yet there is fully this difference between the superior grades of steel as used in gears and the ordinary run of steel as it is offered in the marts

PROPERTIES OF CARBON STEEL OF VARIOUS COMPOSITIONS.
Composition (acid open-hearth steel).

Number.	Carbon.	Silicon.	Sulphur.	Phosphorus.	Manganese.
1.....	0.132	0.026	0.031	0.055	0.400
2.....	0.183	0.037	0.024	0.052	0.710
3.....	0.311	0.040	0.021	0.052	0.575
4.....	0.370	0.062	0.021	0.029	0.800

PHYSICAL PROPERTIES.

(Heated to 610 deg. Centigrade and cooled in air.)

Number.	Tensile Strength Tons per Sq. In.	Elastic Limit Tons per Sq. In.	Elongation Per Cent. in 6 Inches.	Reduction of Area in Per Cent.	Brinell Hardness Number.
1.....	25.35	12.33	30.60	62.65	78.1
2.....	30.20	15.58	27.70	60.70	96.1
3.....	33.09	13.96	24.10	55.32	102.0
4.....	35.63	17.53	22.03	52.82	111.0

(Report of W. F. Harbord, Feb. 20, '08. Paper read before the Institute Mechanical Engineers.)

at which quenching from above 900 degrees centigrade will cause any noticeable hardness. The limit is 20 points of carbon, and it is generally conceded that 16 points of carbon should be the maximum if the gears are to be "cemented" (case-hardened);

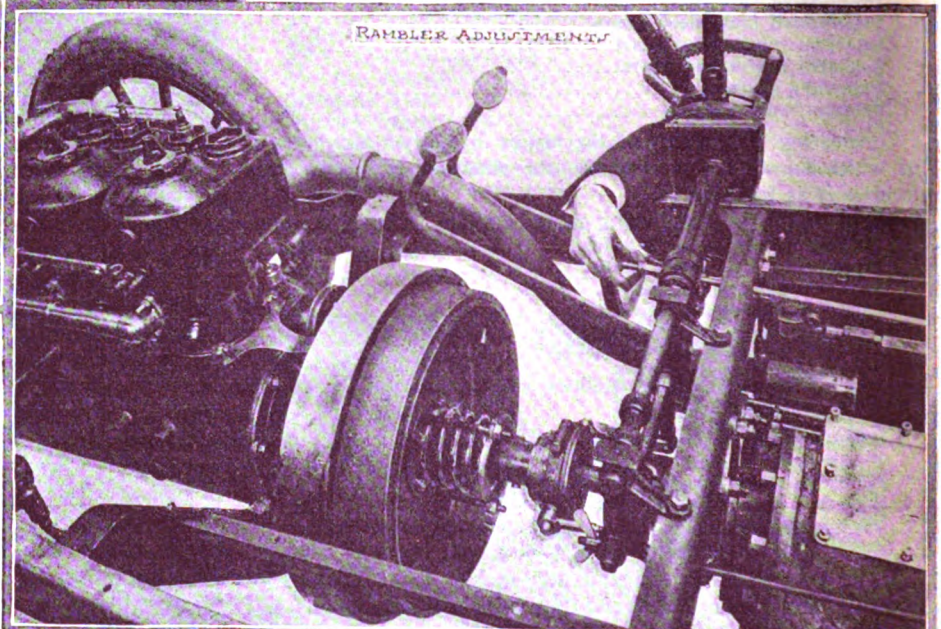
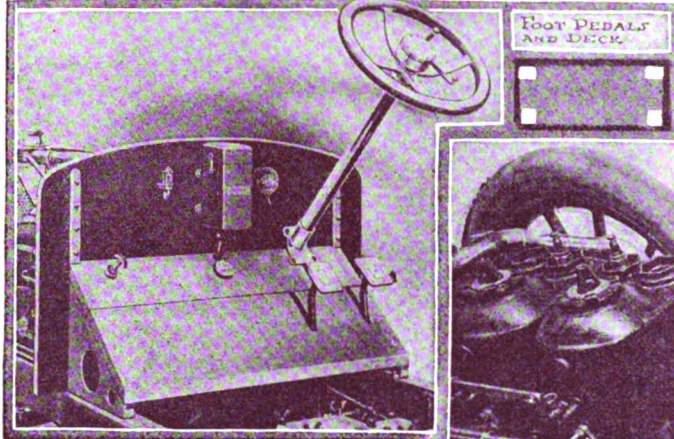

of trade. There is much uncertainty in the haunts of designers when it comes to this matter, for the reason that the vendors of steel have opinions in relation to quality which are so flexible as to stretch in all directions, depending upon the information disclosed by the "stock sheet."

The illustrations afforded with this article will adequately disclose the great uniformity which obtains in practice when reference is had to the gear dimensions; there is a great uniformity; it is to be expected, for reasons as follows:

- (a) The gear ratios are very much the same in the several makes of cars of the respective classes;
- (b) Motors are very close together in point of power in the several makes of cars of the same class;
- (c) Road conditions are equal for all the makes of cars;
- (d) The duties of the gearsets, in the several makes of cars of a common class, do not differ from each other to any great extent.

Since the conditions are very closely approximated in the various cars of the several classes, it is a fair assumption that the gears will have to do about the same amount of work, and it is the "factor of safety" which will be altered if the materials are not the same, assuming gears of precisely the same design. True, it is possible to introduce many variations, and in point of detail, many are the variations in actual practice. Equally true, there are limitations to all, limitations, in fact, which, if not taken into account, will terminate the performance in disaster in the cases which do not conform to the torque requirements.

Special Grades of Carbon Are Used.

The materials used in gears may be classed in the manner as follows, as they are used in cars of the present time:

- (a) Mild carbon steel of the acid open-hearth genera;
- (b) Mild carbon steel of the basic open-hearth genera;
- (c) Mild carbon steel of the Bessemer genera;
- (d) Mild carbon steel of the crucible genera.

In the above grades of steel the carbon is kept below the point

they would have to be so treated, if mild steel of the carbon series is used, to attain the requisite hardness on the surface and to be tough as well as dynamic in the core section. All the above products, then, are for case-hardening, and that there is a difference in the performance depending upon the mode of production is assured, it being the case that the acid open-hearth or the crucible steel (acid raw material) will evolve the best results, with a difference so great as not to be neglected if the performance is to be noteworthy.

There is no other grade of carbon steel suitable for use in gears if "cementing" is to be resorted to excepting that the remaining contents can be varied over considerable ranges, and the "heat treatment" can be conducted in divers ways.

(To be continued.)

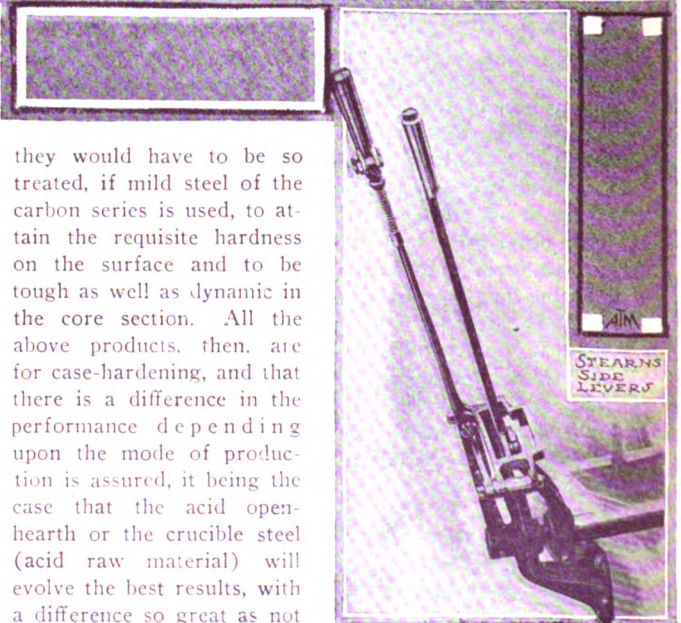



PHILADELPHIA, Feb. 3.—To-night the Philadelphia show closed with a most satisfactory accounting all around. The attendance has been excellent, interest has been plainly apparent, and sales have followed as a natural sequence. There is no doubt but that the exhibition has been of great material benefit to the industry in this city, and the general impression prevails that a Winter show is still an asset worth the trouble and expense for several years to come.

Made up of 66 separate exhibits—of which 42 are of automobiles, 4 of motorcycles and 20 of accessories—the show was really the most comprehensive ever held in Philadelphia. Fifty-two of the better-known American and foreign cars were crowded under the armory roof, the actual number of cars on exhibition being 154.

The color scheme was a daring departure from the tenets of the "quiet and dignified"—nothing less than Nile green and pink, if you please. But perhaps that combination isn't a winner! It gave the big armory the effect of the interior of a huge square tent, the central roof feature being a huge staff device dotted with myriads of electric globes, with long strings of lamps carried therefrom to every side and corner of the armory, while immediately above were looped alternate strips of Nile green and cerise material, so closely draped as to entirely hide from view the unsightly girders of the roof. These strips were carried from above the huge central electric device to the far sides and ends of the building, giving the tent effect spoken of. Opposite the main entrance debouched into the main aisle, which was lined on each side (placed at booth intersections) with staff columns in Byzantine period effect, each opposite pair connected by a graceful lattice work arch entwined with beautiful artificial flowers. This lattice work effect was repeated around the sides of the entire armory, giving a general effect, which, while decidedly effective, was not garish.

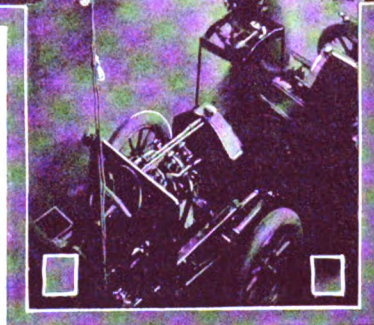

Kendle's string band, perched on a hanging balcony at the far end of the armory, could be heard but not seen, being ensconced in a veritable floral-electric bower. Manager Beck came in for unlimited compliments on the decorative scheme—even the exhibitors and visitors on business bent being forced to admit the compelling effect of beautiful surroundings in a venture where the great desideratum in the final analysis is the almighty dollar.

While it had been the original intention, owing to the lack of space, to limit the exhibits to automobiles and accessories, the pleas of the motorcycle makers became so insistent that at the eleventh hour Manager Beck decided to secure one of the large main-floor company rooms to accommodate them. Here, to the right of the main entrance, was the "Motorcycle Annex," and four rivals for the "two-wheeler" business hold forth here with fifteen machines of various power and price. They were the Reading, Standard, Thor, Marsh-Metz and N. S. U.

The lack of the exhibition room was impressed upon the visitor from the moment he entered by the crowding into the corridor at the left of the entrance of a single specimen—but a most beautiful one—of the handiwork of the Woods Motor Vehicle Company, of Chicago. It was a coupé fitted up with every luxury and convenience, and on McKinley's birthday it was fairly smothered in pink carnations. Despite the uptown location of the armory and the distance from the hotel, wholesale and automobile districts in the center of the city, the show exceeded by 50 per cent. all previous attendance records for similar exhibitions held in this city. Manager Beck figured out on Saturday night, the fourth of the show, average daily admissions of nearly 8,500, which, in view of the narrow aisles—necessitated by the clamorous demands for space and more space—made uncomfortable crowding a nightly occurrence. Indeed, even the afternoon crowds were so comparatively dense as to

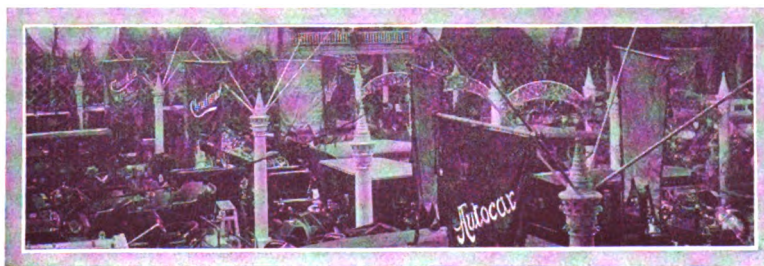

push the overflow into the various stands and interfere somewhat with the conversation artists connected with the various displays getting in their best licks. However, the real business of the mornings and early afternoons more than compensated for the evening discomforts, and there were few dissatisfied exhibitors. All hands know the handicap under which Philadelphia show promoters have long labored, and "if we only had a Madison Square Garden here" was often heard from visitor and exhibitor alike.

Like all modern automobile shows, real novelties were conspicuous by their absence. But there was "something new" at the Philadelphia show, whether it is practical or not. It is the Carroll carbonic acid gas car. Mounted on a runabout frame of about the 1905 vintage, the little engine for which the inventor claims 31 horsepower, looked insignificant indeed. The utter simplicity of the engine is accentuated by the absence of radiator, carbureter, sparking devices, and all the other necessities which go to make up a complete gasoline car chassis. And yet, Mr. Carroll claims he has harnessed C O₂ until it will do his will. A peculiar feature of the Carroll exhibit was that there was no "conversation corps" to dilate on the merits of the invention—and Lord knows one was needed, despite the fact that a neat little booklet was handed out at the stand which answers possibly a third of the questions asked concerning it! No attempt was made to secure purchasers or subscribers to stock. The exhibit stood there for the crowds to look at, feel of—smell, if they cared to—and that was all there was to it. That it "goes," hundreds of Philadelphians are willing to swear. What makes it go they are not so sure of. Perhaps this show has launched a revolutionizer. *Quien sabe?*

Every exhibitor whose product has captured trophies on track or road had his plunder displayed prominently. The Fiat had its \$5,000 Savannah Grand Prize cup. At the Matheson stand proudly among other trophies reposed the \$600 MacDonald & Campbell cup, captured on the heart-breaking Wilkes-Barre run of the Quaker City Motor Club. The Acme exhibit's main feature in the prize line was its second place in the Fairmount Park Founders' Week race, the Locomobile crowd going them several better, with the cups symbolical of first place in the same contest and its still greater win in the Vanderbilt race. A veritable forest of small cups crowned the Pullman exhibit; a similar display being a marked feature also of the Stanley exhibit—and so on. The little "Lampo" was the star card at the Lancia booth, the triumph of Hilliard at Savannah having been supplemented only recently by Mrs. Cuneo's win in the same little car on the run of the Women's Motor Club, of New York, from the metropolis to this city and return. The dust and mud-begrimed transcontinental Brush was also in evidence, the car being carefully watched in order that none of the apparently precious grime of travel should be accidentally removed.

The show early promised to be as successful as a business proposition as it was pleasing to the eye. Not in the sense that

it proved a money-maker for the promoters—for that was a foregone conclusion before the doors were opened last Wednesday night—but that exhibitors as a rule found their expenditures for space and the extras well worth while. Possibly the biggest bit of business done was the closing of a deal between the Autocar Company and the Pennsylvania Taxicab Company, whereby the former will furnish 25 vehicles for the latter for use in this city. Wayne Davis "sneaked one over" on his fellows when, fifteen minutes after 8 o'clock on Wednesday night, he recorded the first actual sale of the show—a replica of the Matheson, which won the Philadelphia-Wilkes-Barre endurance of the Quaker City Motor Club. After that sales were numerous reported, scarcely a single exhibitor being overlooked.

Every day saw an influx of national automobile celebrities; it would have been impossible to shy a brick at random anywhere into the crowd without bringing down a star card. All of the elect, who put in the first days of the week storing up energy after the exhaustion following the Garden show and preparatory to the further demands upon them next week at Chicago, floated into town to tune up a trifle at the expense of the Quakers. Publicity men, sales managers, factory experts and manufacturers—place them in any order you please—were here. Fred L. Estey, in his inimitable interviews with himself, garnered column after column of dollar-a-line space gratis for the E-M-F, the local sheets snapping it up with avidity. Ernest Coler became so warm over some of his cracks that he fell into the trap and helped the game along. Beginning in fun and dealing at first in generalities, Estey brought around his ears a bunch of competitors with defies in their pockets, blood in their eyes and chips on their shoulders—and laughingly skipped the town. E. L. Thomas, Harry Fosdick, "Dunc" Curry, C. S. Jamison, W. C. Churchill, H. B. Larzalere, R. H. Johnston, Lee Counselman, E. P. Nussbaum, W. H. Kirkpatrick, "Major" Humphries, Frank Pearce, George Bennett, "Senator" Morgan and "On-the-Spot" Spooner were just a few of the celebrities who spent the first half of the show in town.

The heavy storm of Tuesday night, previous to the opening of the show, deprived the visitors of the opportunity of witnessing the free-moving picture exhibition, which the management had provided as a side-show to the star attractions in the main tent. A huge tent had been erected on the vacant lot next the armory, but Old Boreas put in his most vicious licks and ripped the tent to pieces. Fortunately, the moving picture machine was not injured, but it was found impossible to secure another tent on such short notice, and this feature was reluctantly abandoned. It was perhaps just as well, for with a blizzard on Saturday night and intensely cold weather during the latter part of the show, it would have been impossible to properly warm the tent. Thus did Dame Nature thwart dire pneumonia.

Despite environs and conditions of inclement weather, Philadelphia has done it, and the "straws" are scattered to the "four winds" of solid business, some of which is in hand.

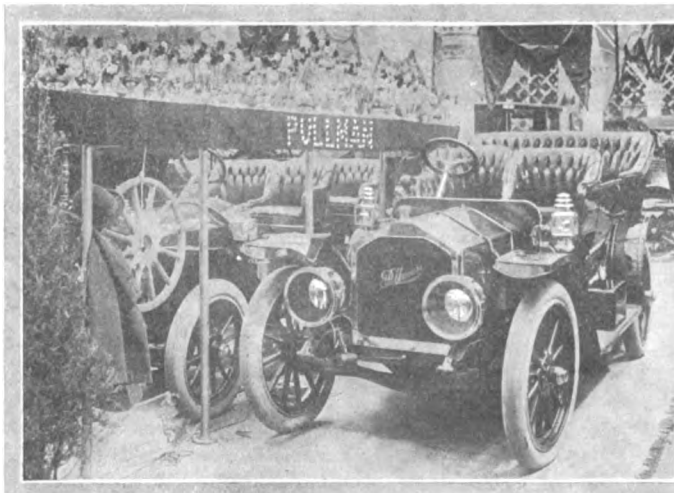

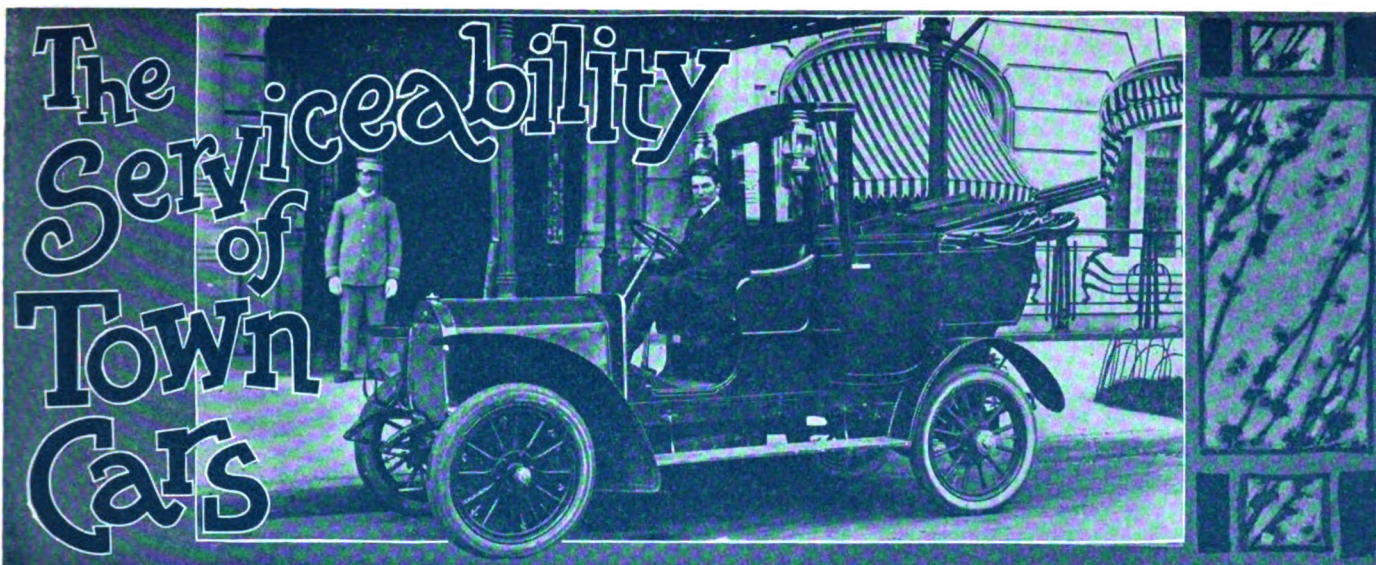

THE apparent popularity of the town car is a definite measure of its value in the service to which it is dedicated. Of town cars it may be said that a considerable variation in types of bodies, or, better yet, in body designs, will be found. The limousine type of body is largely used in town work, the landaulet is sometimes employed for the purpose, but the brougham type represents comfort and luxury in the extreme.

Of the limousine, and the advantages thereof, roominess is the most pronounced feature. This style of body is preferred by the patrons of the industry whose needs are by way of a spacious body, seating five persons within. In all other respects, the limousine type can be rendered just as comfortable and possess all the elements of luxuriousness possible of attainment in connection with the brougham.

The landaulet, on the other hand, has for its basis an entirely different set of features. With the landaulet, it is possible to take advantage of the clemency of weather by folding back the collapsible top and avoid thereby the cooped-in feeling, so prone to grow upon one if the atmospheric influences favor open-air life. There is no lack of comfortable surroundings or luxuries in connection with the superb designs of landaulet, to be seen at every hand, and in them the seating capacity is not less than in the limousine types, excepting that the auxiliary seat requires the occupants to ride backward, as a rule.

This question of seating capacity is secondary in town cars, for, in all truth, they are not intended to serve in the capacity of a carry-all. Indeed, there is a decided preference, when it comes to the brougham type, in favor of limiting the seating capacity to two persons and no more. In the brougham type of town car, utilized as it is by way of a convenience in social life, there is a distinct disadvantage if the seating capacity does not exceed that which will afford a liberal accommodation for two persons. "Her ladyship" in transit for the opera is not costumed with the idea of being sandwiched in between two persons, nor is it feasible to utilize auxiliary seats, for the reason that the entrance would be obstructed under conditions that are most disagreeable.

The town brougham affords a commodious and luxurious seating space for two persons, which in itself would be of no advantage at all in the absence of a wide entrance, free from obstructions of every character. On this account it is the custom to make the depth of the chauffeur's seat not more than 18 inches at the most; his foot room is reduced to approximately 20 inches, lengthwise of the car, and the preference is for the short motor; again with a view of rendering the space within the maximum possible without bringing the seats of the occupants over the rear axle, which is an advantage in this service.

In the best examples of town cars, the turning radius of the car is taken into account in practically every case. It is desired to be able to maneuver in congested streets, and to make a turning

movement in fairly narrow thoroughfares, without having to back and fill, as it were. In this we see a still further reason for a short wheelbase, which in turn indicates very little room for the chauffeur's seat, the least possible for the motor, and the balance for the body proper, that luxury may repose within.

The wheelbase can scarcely be more than 100 inches, if the turning radius is to be half the width of thoroughfares as they generally do obtain. This in itself would scarcely suffice for the purpose, in the absence of a limited "canting" angle, of the front wheels, and this angle depends not only upon the diameter, but upon the width of the chassis frame in juxtaposition to the front wheels. These are all matters that now receive their quota of attention, while in former times it was considered that a touring car chassis could be fitted out for town car service, hoping to render it fit if perchance the body was a luxurious creation, with room enough in the seating space to dance the minuet.

Not so with the modern creations. They are town cars pure and simple, designed specifically for the purpose, and are limited to town service, since, forsooth, they would be as faulty for touring as is the touring car when converted over. Likewise in the town car there is a penchant in favor of the shaft drive, since by the elimination of the side chains the sprocket-wheel guard will not obstruct the side entrance or take up space on the running board. In the expression of this preference in favor of the shaft drive, there is naught by way of questioning the mechanical ability of chains, nor does this preference indicate a more pronounced condition of stability of the shaft drive. It is a mere case of prejudice upon the part of the patrons who do not care to have the side entrance obstructed in any way.

Town Cars Are Heavy.

Criticisms of weight may be well taken when aimed at light touring cars, or cars in which high speed is a requisite, but in a town car weight is an essential to that "Pullman" effect so much to be desired. But if weight is a favorable factor (which will, of course, run up the tire account), the weight must be placed where it will do the most good, *i. e.*, as near the ground as possible. "Top hamper" would cause lateral rolling and engender other ill effects, as pitching in the longitudinal plane. The modern town car body, then, is designed with stout under-framing and light, even to frailness, in the over-body. The chassis is also, as a rule, much heavier than would be necessary in a touring car, or other pleasure automobile. The wheels are not of a maximum diameter, and the ground clearance seems to be adequate under the conditions of service of the town cars, and it brings the running board at a nice elevation in relation to the customary stepping stones; which running board, in turn, is well situated with respect to the sill of the side entrance.

In spite of the desire for weight in town cars, they are not

with great power of the motor, because they do not have to negotiate unpaved streets, nor are they noted for high speed. In some town cars, weighing perhaps two gross tons, the power is even down to 16 to 20-horsepower. There seems to be no trouble on this account, while there is a factor in favor of economy in the directions as follows:

- (a) The fuel consumption is remarkably low.
- (b) The tire bills are minimized.
- (c) The upkeep factor, due to shock, is less than it otherwise would be.

These are important matters and properties of the most recent types of town cars realized, without having to consider the absence of any innovation worthy of the name, since the speed attainable is all that can be used in the thoroughfares.

The Accessories of Town Cars.

Headlights are not included with the equipment of town cars, since ethically there is nothing in favor of blinding the pilots of approaching vehicles, merely to cast a glare where none is necessary; the lighting system, then, is complete with side-lights and a tail-lamp, conforming to the legal requirements. When reference is had to the signal system of a town car, a positive but not conspicuously noisy signal, free from trinkets, should be included.

But the occupants of the car will ever find it necessary to indicate to the chauffeur the direction in which to go, how fast to travel, when to start and when to stop. A speaking tube or a telegraph is therefore essential to the equipment, and an annunciator is placed to intercept the line of vision of the chauffeur, which in itself is an electrical device, as a rule, with drops suitably inscribed. Within the body of the best types of town cars will be found a time-piece, and a *secrétaire* with paper, envelopes, and such little trinkets as lend zest to luxury.

The Vagaries in Design.

There are no finishes in connection with the carriage makers' craft so pronounced in artistic effect or varied as to detail as will be found in conjunction with the town car. The lines of the body in the best examples are at the hands of artists of no mean repute, and it is not uncommon to see samples of town cars in which the body alone reaches to the comfortable figure of several thousand dollars. Unappreciative persons of no experience, to whom the shadow of a dollar exceeds the purchasing ability of the coin itself, would scarcely see in these marvelous creations any whit of their real worth or the embellishment of true art and stability personified.

It has been so from the beginning in the automobile zone of activity. No sooner did designers sink into a groove than some new and improved plan bounced off the horizon and fell upon

them with convincing force. Take, for illustration, the "taxi-cab," which in all truth is but a fitting evolution of the town car. It is the town car for the resident and the taxicab for the transient, and nothing short. It will not be out of place, then, to intimate that the taxicab was one of the offshoots of the experiences with town-car work.

Some Influences of Town Service on Cars.—Prior to the introduction of the town car as a type, and for some time thereafter, it was the custom to use the regular stock chassis, the body changing. Murmurs of discontent were soon to be heard, due to the awkwardness of the side entrance, and the fact that the sprocket guard was in the way. The shaft drive car was the solution, by means of which the sprocket guard was eliminated, and the drop frame rendered the distance from the "curb" suitable for the purpose. In relation to the drop frame it is a fact that it did not stop with the "town car," and in the course of events it was found that the idea had value for other reasons than the mere fact that the side entrance of the town car was made more accessible. Predictions that the drop frame would prove weak and valueless for the purpose were as chaff before the wind in the light of even a little experience, for, in all truth, the drop frame proved to be more than equal to the occasion. In other words, this type of frame was found to have a wider range of usefulness, in that it afforded a superior car performance in many cases and in divers ways. With the drop frame it is possible to realize the "straight-line drive," which in itself is a matter of more than a little moment. The universal joints that formerly sustained serious hardships are in a straight-line drive enabled to perform their normal functions without having to transmit under conditions involving an undue angle.

The drop frame has had its influence upon the center of gravity and as a result the car performance under severe road conditions. This is a matter to be viewed in the light of reduced cost of maintenance rather than with the idea of engendering a greater speed. In the matter of appearance it is assured that the drop frame has had a marked effect on cars, nor can it be claimed that the change has been for the worse. The earlier types of cars looked as if something was missing; the drop frame had a lot to do with the discovery of the missing link. In some cases the whole frame is lowered rather than offset the frame, as in drop-frame construction. The practical result is the same in any event, since the center of gravity is lowered and the car performance is very much improved as a direct result. The frames are more substantial than was the case in the earlier days, and the materials used are superior for the purpose. Sag is aborted in some cases by inducing an artificial sag, in the process of manufacture.

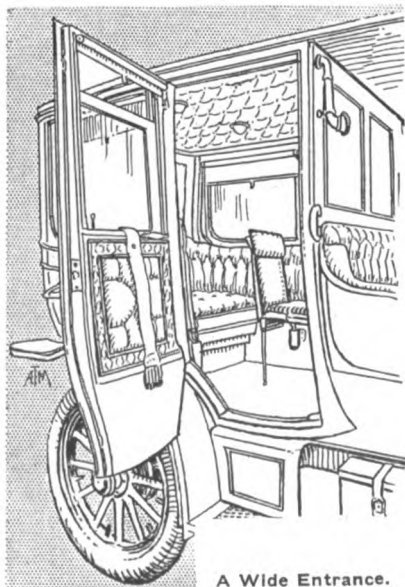

A Wide Entrance.

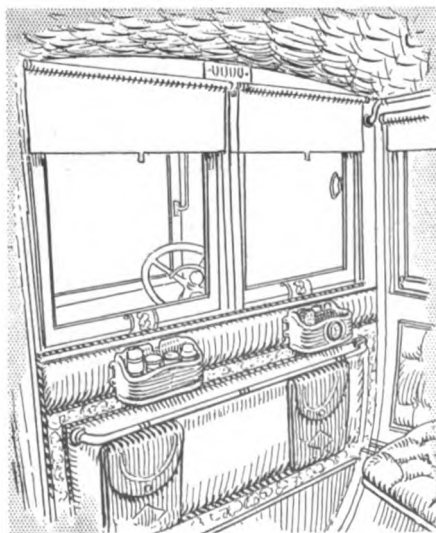

Details Within, Auguring for Comfort.

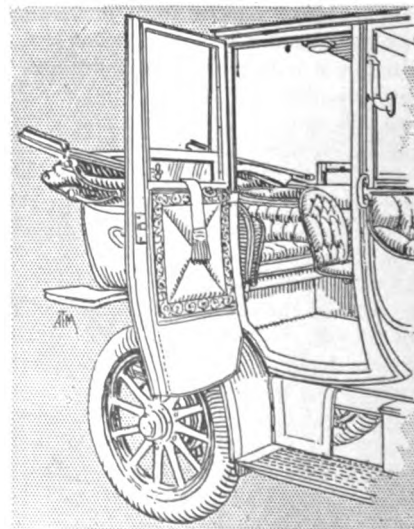

Showing Top of Landaulet Folded Back.

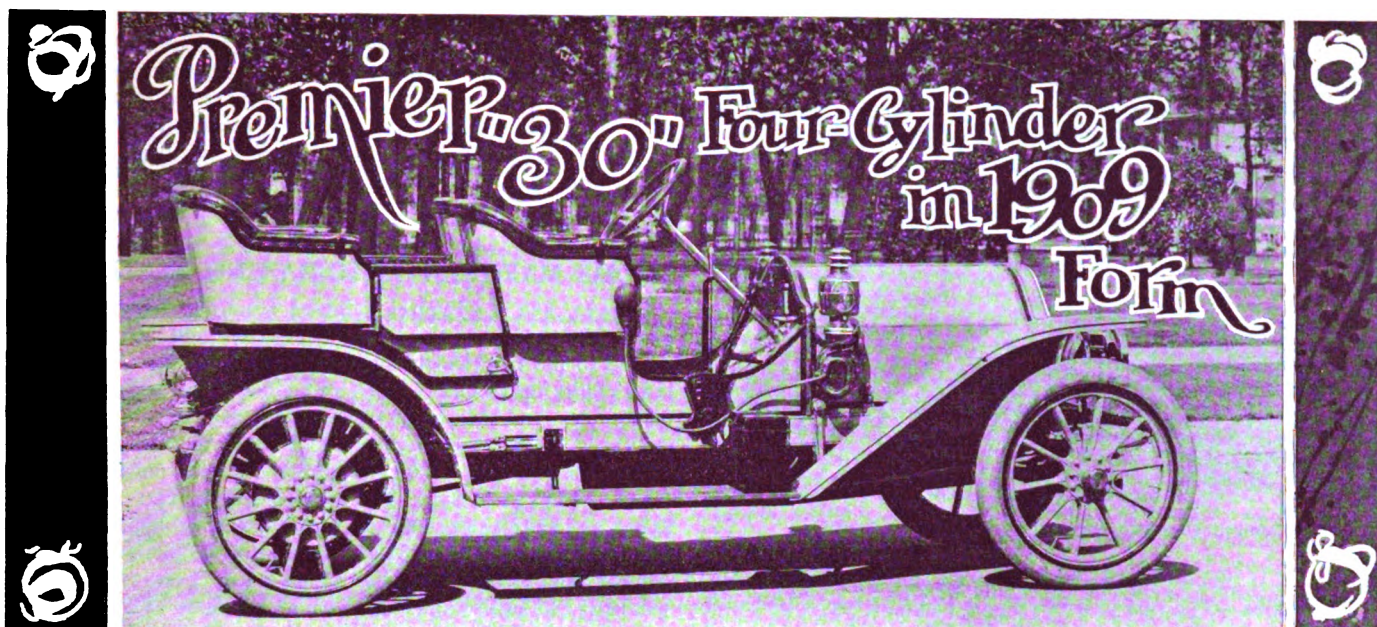

INDIANAPOLIS, Feb. 1.—Clean, straight lines, rounded out with a few well-chosen curves, characterize the 1909 product of the Premier Motor Manufacturing Company. This will consist of two models, a four-cylinder rated at 30 and a "six" nominally called 45. The former, or 30, may be had in four body styles, a single or double-seated roadster, double roadster with doors, touring car and limousine. All body work will be of the now general straight-line design and the material, sheet metal.

Power Plant.—This consists of a four-cylinder unit of exclusive design. The cylinders are of gray iron, cast in pairs, with valves on opposite sides and the induction pipe integral. Bore and stroke are the same at 4 1-2 inches, this being a "square" motor. The nickel-steel valves have both the stems and seats ground to size, which requires more expert workmanship. The valve guides in the cylinders are bushed to allow removal in case of wear rather than necessitating the scrapping of the cylinder. Both valves are mechanically operated, of a liberal diameter and interchangeable. Another feature which may be mentioned is the four piston rings, pinned together in pairs, each pair being used in a single groove. The crankshaft runs on three large bearings of Parsons white bronze, as do also the I-section connecting rods. A new departure of some moment is the use of cast iron for the crank case, aluminum being rejected as not rigid enough for holding the crankshaft and not suitable for thread cutting.

Make-and-Break Ignition.—The mechanical sparking device, so successful in previous years, has been retained. A low-tension Bosch magneto located on the right-hand side is the source of current, being driven through a universally jointed shaft which allows quick removal and replacement.

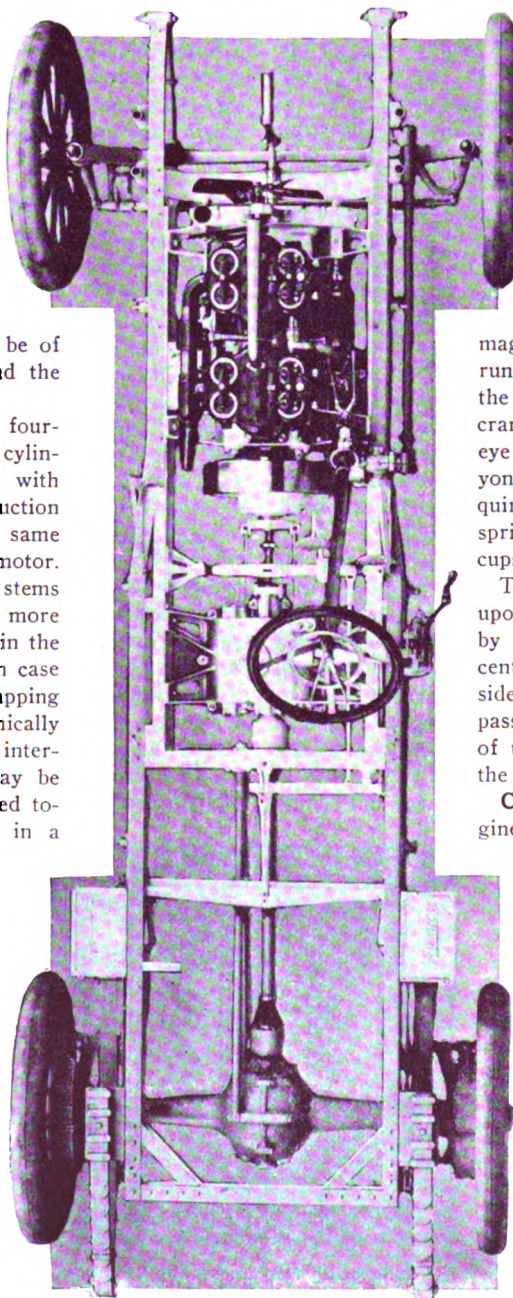

The ignition cams, shown in the view of the cylinder, are driven from spiral gears on the inlet camshaft by means of a vertical shaft, broken by a three-jaw coupling and running on annular ball bearings. A second or auxiliary system is provided consisting of a battery, special single-coil and a high-tension distributor.

The motor is lubricated by a force feed lubricator located opposite to the magneto and gear driven. From there leads run to each cylinder, the main bearings and the gear case, but the lubrication within the crank case is of the splash type, a round bull's-eye in the case indicating the oil level. Beyond the motor itself, all parts of the car requiring lubrication, including springs and spring shackles, have liberal grease or oil cups, accessibly located.

The radiator is of the cellular type mounted upon rubber buffers and fastened to the frame by reinforced brackets. A large gear-driven centrifugal pump, located on the left-hand side of the engine, circulates the water, but all passages are liberally designed with the idea of utilizing thermo-syphon circulation in case the pump fails, to do the work.

Clutch and Transmission.—From the engine, the drive is through a multiple disc clutch of the Weston type to a three-speed and reverse transmission.

This clutch takes hold very gradually and thus avoids severe shocks. Universal coupling is interposed between this and the transmission. The latter operates on the selective principle in an H-segment and has direct drive on the high gear. The gear shafts are hardened, ground, and mounted upon imported annular bearings. The view with the cover removed shows the compactness of this. The drive to the rear axle is by shaft, a pair of Premier combination slip and universal joints taking care of all inequalities. These joints are of very large diameter and

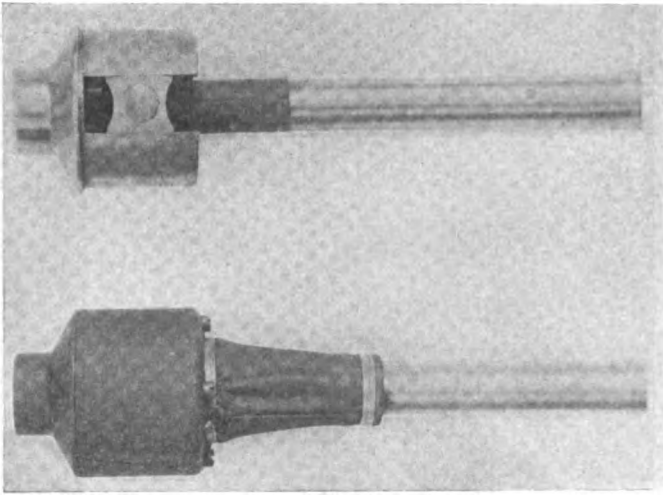

Combination Slip and Universal Joint on Premier.

provision is made for a large amount of longitudinal slip.

The Axles.—The rear axle housing is made of two ball-shaped crucible steel castings, heavily ribbed on the inside, in which it shows a departure from conventional practice. With this construction the use of truss rods is avoided and a very strong combination results. The bearings are all of the annular ball type and the driving is done by means of large diameter three-jaw clutches forged integral with the axle spindle. The front axle is on a line with the front end of the radiator. It is a one-piece drop forging of very deep I-beam section and the material is a very tough special steel. The spring seats are forged integral and machined to size. In the selection of the springs, always a vital point, the greatest care is used. The type is the semi-elliptic front and three-quarter "ell" rear, these being of an unusual grade of spring steel. The leaves are thin, wide and individually lipped, besides which rebound clips are fitted.

The frame is really in two parts, the main or body frame and the sub or power-plant frame. The former is of a pressed steel channel section with very wide top and bottom flanges, and tied together by channel-shaped cross-stiffeners, the sub frame, which extends from the forward cross brace to the rear end and of the transmission, is of an angle section securely riveted to the inside of the main frame.

Brakes.—Not the least important part of any car are the brakes and the braking system. On the Premier 30 these are of two kinds, internal expanding 3 inches wide by 14-7-8 inches in diameter with 44 cork inserts, 1 1-8 inches in diameter pressed into 3-4-inch holes. This makes a brake that is right and will do the work at all times. The external brakes are of the contracting band type, lined with camel's hair belting and applied through a long pressed steel equalizer, as is also the foot brake. External adjustment is provided on both.

All told, this chassis reflects credit on its designers and should

be as successful as its predecessor. The price of Type 30, with any body, is \$2,500, except the Limousine, which lists at \$3,500. A fitting companion for the "30" is Type 45, which may be had in the same styles of body work. The price of these is \$3,500 up to the Limousine, for which \$4,750 is asked. Thirty-four-inch wheels are regularly fitted on all models, the tires being 3 1-2 and 4-inch on the runabout, 4-inch all around on touring cars, while on the 45's, 4 and 4 1-2-inch sizes are used.

SOME MICHIGAN AUTO-MAKING STATISTICS.

DETROIT, Feb. 1.—Figures gathered from authoritative sources prove interesting as showing how Detroit and Michigan have forged to the front in the production of automobiles until there is in reality no second. In Detroit alone there are fifteen companies that manufacture automobiles, aside from the parts makers. These fifteen companies will this year turn out 50,000 cars—actual, not press-agent figures. These run all the way from a runabout at \$500 up to seven-passenger cars that sell for \$5,000 or more, according to the tastes of the buyer. Cars ranging from \$1,200 to \$1,500 form a great majority of this number, and with the former figure as an average, it will be seen that the local output will have a sale value of \$60,000,000.

Scattered throughout the State, chiefly within a few miles of Detroit, are ten more factories that will produce many thousands of cars this year. Within eleven years a dozen of these concerns have trebled their capital stock, until now they have more than \$6,500,000 to their credit. A careful canvass shows that in Michigan more than \$50,000,000 is invested.

RAINIER PLANT MAY RESUME.

SAGINAW, Mich., Feb. 1.—Further advices received here indicate that the Rainier automobile plant will continue operations in this city. George C. Comstock, the company's attorney, has bought for \$20,000 at public auction all of the company's plant, machinery, unfinished product, etc., not covered by the \$100,000 mortgage, including also the company's equity in the mortgaged property. Besides being attorney for the company, Mr. Comstock is a director, and it is believed that with this purchase, and that of A. T. Ferrell, a Saginaw man, of the company's \$100,000 bonds, all conflicting interests have been harmonized.

THIS ONE HAS PERPETUAL MOTION ALSO.

SAVANNAH, GA., Feb. 1.—A resident of Valdesta, near here, J. J. Pittman by name, has practically perfected an automobile run by compressed air generated by the machine itself. After working on it for many years he has now satisfied himself of its practicability and his patent attorneys have assured him that the invention will solve the perpetual motion problem. Doubtless with a few slight modifications this same machine can be used to transmute the baser metals into gold, square the circle, and generally clear up all of those old and time-worn problems!

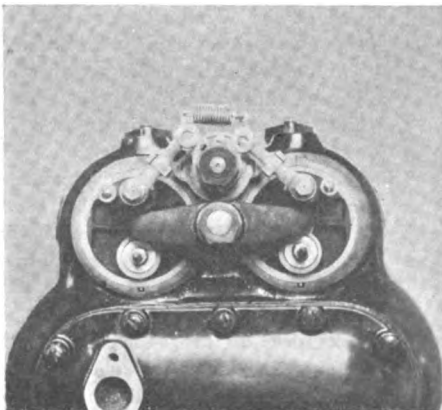

Premier Low Tension Igniters.

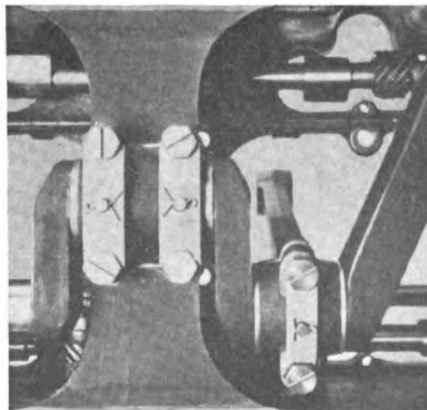

Connecting Rod and Main Bearings.

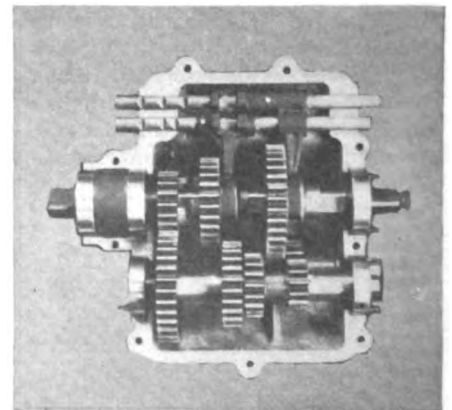

Premier Selective Transmission.

THE NEW MATHESON "SIX" FOR 1909

WILKES-BARRE, Pa., Feb. 1.—The newest addition to the Matheson line, the baby, so to speak, while showing the dominant Matheson features and workmanship, also shows a few departures more in keeping with up-to-the-minute practice. This new car is a six-cylinder, the first to be regularly produced in the Pennsylvania factory. Rated at 50 horsepower these 41-2

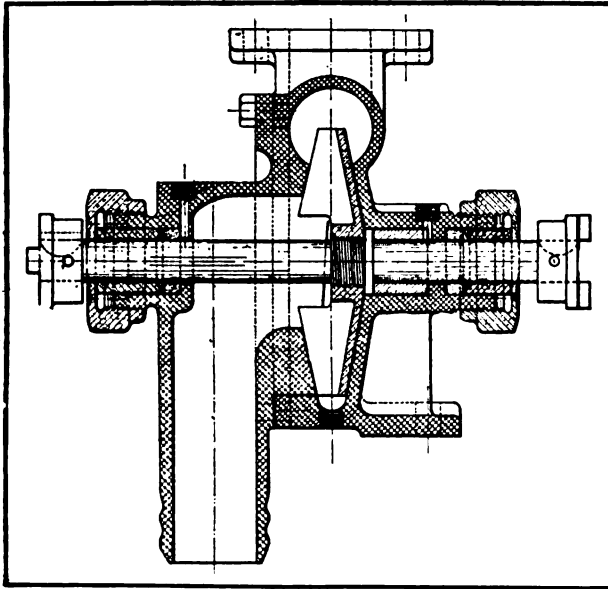

The Matheson's Powerful Gear-Driven Centrifugal Pump.

by 5 inch cylinders are fully up to the standard set by their older brothers. Strength and power is the Matheson keynote, and in the latest production of Designer Kenen this is upheld.

The motor, in common with the rest of the car, shows a few changes. Thus, the cylinders are cast in pairs. On the other hand, the valves in the head have been retained, these being of large diameter, mechanically operated and interchangeable. They are operated from a single camshaft on the right side, this being enclosed within the crankcase, and having cams milled out from the solid. From this to the overhead rocker arms the motion is transmitted by the long tappet rods. Former practice placed both pipes, inlet and exhaust, on the left, but on the present model the exhaust remains, while the inlet and carbureter have been removed to the right side. The latter is similar to the carbureter used on the large model.

Crankshaft Discs Increase Flywheel Effect.

The crankshaft is a one-piece forging with the flywheel flange forged integrally. This has two large discs for perfect balancing forged with it and runs on bearings of anti-friction bronze. The aluminum crankcase is of the box type and forms a solid pan from the radiator to the back of the flywheel. The lower section is the reservoir for the oil used in the auxiliary splash and lubrication of the main bearings. This is cast with compartments for each cylinder and is removable for access without disturbing the bearings or other parts. The gear-driven fan is mounted on imported annual bearings.

Ignition shows a marked breaking away from the practice exemplified on the four-cylinder motor, which will be retained for 1909. This is a patented low-tension system with a particularly effective make-and-break. The new system, on the other hand, uses an imported high-tension magneto as the source of current for a jump-spark system, a vibrator coil being used for starting. Extra batteries are carried in reserve to provide for any possible failure of the magneto system or any of its parts. This magneto, an Eiseman, is directly driven from the auxiliary shaft

on the left hand side. The latter drives in succession, from the front end back, the lubricator which forms part of the crankcase, the centrifugal pump and opposite cylinders four and five, the magneto. This shaft, as is shown in the pump illustration herewith is made with a series of universal joints, which allow of the removal or replacement of any of the units.

Transmission Forms Part of the Rear Axle.

The drive from the engine is through a multiple disc clutch to a three-speed selective transmission located on the rear axle, and from there by floating rear axle to the wheels. This represents a big concession to public opinion and a radical departure from the usual Matheson chain drive. A multiple disc clutch, consisting of fifty-one discs, affords a friction surface of 1,500 square inches. This is practically indestructible, absolutely reliable, runs in oil, and is located in the hub of the flywheel. It is extremely flexible; will slip without heating; requires a light pedal pressure; absorbs all undue shocks, and affords a maximum of comfort to the passengers. The circulation of the water is effected by means of a powerful gear-driven centrifugal pump. Very large pipes are used in the cooling system, and a honeycomb type of radiator. Control is by spark and throttle levers on top of the steering wheel, an auxiliary foot throttle, hand lever for the speeds, and outside hand-brake lever. The important question of lubrication is well taken care of by a force feed lubricator forming part of the crankcase, with a small sight feed on the dash. Every engine bearing, including the valve rocker arms, is positively lubricated.

Four compensating brakes are fitted, two contracting bands on the outside of drums attached to the rear wheels, two internal expanding inside the drums. Metal-lined throughout and operated by pull rods, no cables are used. A simple hill pawl operating in the rear drum enables the car to be stopped on up-grade without recourse to the brakes.

A pressed-steel frame of the drop type, of liberal dimensions and reinforced by trusses, taken in combination with the three-

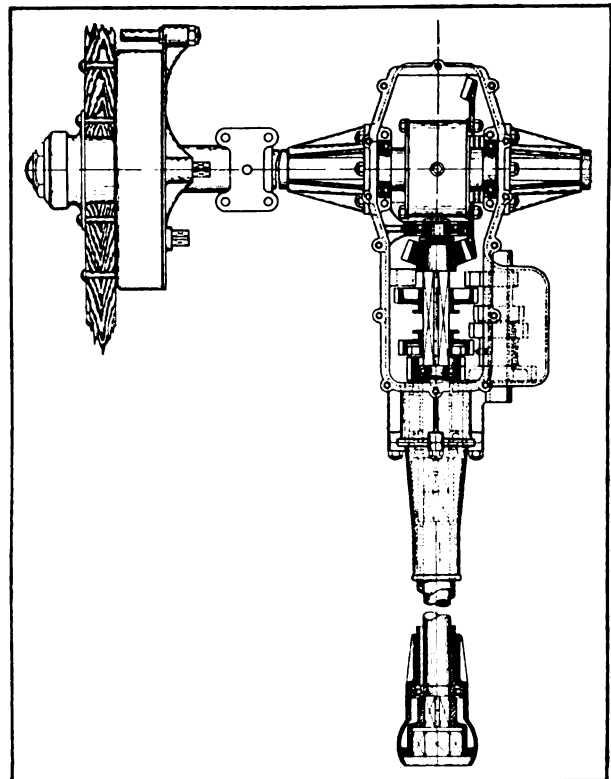

Outline Plan of Rear Axle and Transmission.

quarter scroll elliptic rear springs allows a maximum of comfort. The axles are of nickel steel, the front being an I-section forging; 36-inch wheels run on Timken roller bearings in front and imported annular ball bearings in the rear. These wheels are equipped with 4-inch tires all around, which is an unusually large size for a car of this weight, 2,900 pounds, and at this

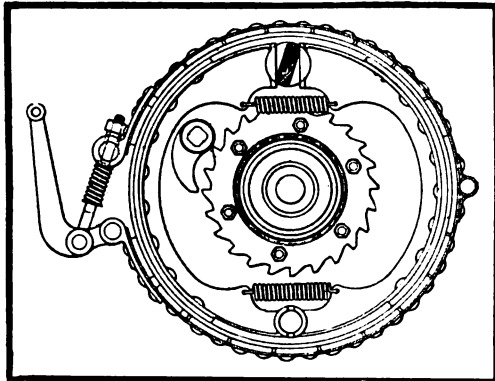

Pawl for Stopping Car on Hill Without Brakes.

price, \$3,000. A long wheel base of 125 1-2 inches, coupled with the fine springing, will assure easy riding, being an excess of from three to six inches over former cars selling at the same price.

The bodies are of sheet steel following closely along foreign lines, are luxuriously upholstered and very comfortable. The equipment is unusually full, consisting of five lamps and gas tank, horn, tools, tire-repair outfit, tire carriers, etc.

CADILLACS WON BRITISH MERIT PRIZE.

LONDON, Jan. 27.—The Dewar Challenge Trophy is annually awarded by the R. A. C. for the most meritorious trial held during the year. After careful consideration of the many trials during 1908, the committee unanimously decided that the trophy be awarded to the Anglo-American Motor Car Co., Ltd. The following are the official particulars:

"Standardization Test of Three Cadillac Cars, February 29, 1908.—Three 10-horsepower cars for this test were selected from stock by the club. The cars, after being run about twenty-seven miles on Brooklands track, were dismantled and subsequently regrouped and reassembled, some parts also being taken from stock to replace some removed by the technical committee. The assembling was done without any "fitting," and the cars started up without trouble, each subsequently running 500 miles at an average speed of 34 miles per hour, with an average fuel consumption of 29.64 miles per gallon. No. 2 car had one minute's stop to replace a split pin in the ignition rod."

ONE MAN'S WORK IN AUTO BUILDING.

It was in the late eighties that R. E. Olds began his experience with the "horseless carriage." It is interesting to note his progress since that time up to the present, and herewith is given the official chronology, and some production statistics for late years, supplied by the Reo Motor Car Company, of Lansing, Mich.

1864, June 3.	Birth of R. E. Olds at Geneva, Ohio.
1885,	Purchased one-half interest in shop of P. F. Olds & Son.
1886,	Started first experiments with "horseless carriage."
1887,	Constructed and operated his first three-wheeled "horseless carriage."
1890,	Olds Gasoline Engine Works incorporated with capital of \$30,000.
1892,	Brought out a practical four-wheeled automobile.
1893,	Sold his first motor car to an India patent medicine company.
1896,	Olds Motor Vehicle Company organized with a capital of \$50,000.
1899,	Olds Motor Works incorporated, absorbing Olds Motor Vehicle Company and Olds Gasoline Engine Works, R. E. Olds, president and general manager.
1904, Jan.	R. E. Olds severed connection with Olds Motor Works.
1904, Aug. 17,	Reo Motor Car Company organized, R. E. Olds, president and general manager.
1904, Sept. 5,	Ground broken for first building of Reo plant.
1904, Oct. 15,	First Reo car run out of temporary quarters and started on a 2,000-mile test run, with R. E. Olds at the wheel.
1904, Dec. 1,	First Reo building completed.
1905, Jan. 1,	Wheels of new Reo plant set in motion.
1905, Mar. 21	First carload of Reos shipped from the factory.
1905,	Volume of Reo business first year, \$1,374,084.02.
1906,	Volume of Reo business second year, 3,097,579.15.
1907,	Volume of Reo business third year, 4,336,208.14.
1908,	Volume of Reo business fourth year, 4,799,010.71.

SPAIN'S MARKET AFFECTED BY HIGH PRICE OF GASOLINE

CONSUL-GENERAL FRANK D. HILL forwards from Barcelona a letter addressed to him from Madrid, calling attention to the restriction in the motor machine trade through the high price of gasoline:

"Your attention is respectfully called to the following data referring to the gasoline market in Spain and the effect of same on the sale of so-called explosive engines or motors. It is the consensus of opinion of all those who, like the writer, have studied the possibility of creating in Spain a market and demand for engines or motors in which power is developed by the combustion of vaporized petroleum products (gasoline, benzine, naphtha, kerosene, etc.) that a trade amounting to an annual sale of hundreds of motors, ranging in power from 1 to 20 horsepower, and in price, at the seaboard of the United States, from \$50 to \$1,000 each, could be and would be developed were it possible to employ such motors economically; i.e., were it possible to develop power with such motors or engines at a cost that would allow some profit on same to the immense number of users of small quantities of power whose industries will not warrant the installation or care of expensive steam or electrical power producers. This motor trade is barred from Spain at present by the prohibitive cost of gasoline. The per horsepower cost in the United States of 1 cent is increased to approximately 5 cents in Spain for the same unit.

"The technical result of a reduction in price to one-half would be the replacement by vapor or explosive motors or engines of

thousands of horse and hand gears, and the general commercial result would be the ability of the small class industrial all over the country to produce locally the exact amount of horsepower necessary to his specific needs at 15 centimes (\$0.026) per horsepower-hour instead of the present minimum cost of 30 centimes (\$0.051), with a minimum of capital invested in his power-producing installation. The so-called small class industrial exists by thousands, and the fact that 15 centimes (\$0.026) per hour is a profit-giving cost of 1 horsepower, proves beyond the possibility of successful contradiction that the consumption of gasoline, lubricating oils and other petroleum products would be increased many fold in a relatively short space of time.

"The lowest reasonable estimate of the number of motors which would be placed (given a reasonable price on gasoline) must necessarily run into the thousands, while the increase in the number of autovehicles consuming gasoline and mineral lubricating oils would of course be considerable. As the consumption of a 3-horsepower motor, when worked to full capacity, is 3 gallons per 10 hours, or 900 gallons per year of 300 working days, it will readily be seen that the annual consumption of gasoline in Spain would soon be increased millions of gallons, and as only high-class lubricating oils (side products in petroleum refinement) can be used on both motors and autos, the increased consumption of same would be correspondingly great." The future of this situation will be well worth looking into and that the field will pay for exploitation is assured.

EFFICIENCY OF MANLY HYDRAULIC DRIVE SYSTEM*

IN the issue of THE AUTOMOBILE, December 10, 1908, the preliminary report of the Manly drive showed the machinery and afforded such information as was then to be had within the bounds of accuracy. The question of efficiency had been investigated, but the figures were not available. The report of George H. Barrows, of Boston, Mass., is appended (in part), and it is believed that this material will adequately make up for the lack of information, of a certain character, purposely left out of the first description of the equipment. The report of the engineer as follows is herewith essentially given:

The Manly drive is a device for transmitting power by hydraulic means from one revolving shaft to another, with the object, first, to secure any desired speed of the driven shaft, either forward or backward, without changing the speed or direction of motion of the driving shaft, and second, to transmit the power to a shaft which is either in line with the driving shaft or which lies at any angle to the driving shaft and separated therefrom.

It consists of a multi-cylinder pump with variable stroke which is attached to the driving shaft, and one or more multi-cylinder motors having a fixed stroke, which are attached to the driven shaft, together with pipe connections or passages between them for transmitting the working fluid. The various cylinders, both of the pump and motors, radiate equidistantly from a central crank-chamber, and the pistons or plungers are connected to a single crankpin, which is common to all. The fluid used is ordinary machine oil, the lubricating qualities of which, and its freedom from danger of freezing, admirably fit it for such a purpose. When once filled the oil is used over and over again, being in continuous circulation from pump to motor through one set of pipes or passages and back again from motor to pump through another set.

Technical Description of the Manly Drive.—Fig. 1 shows the location of the multi-cylinders around the central crank chamber, the number in use in the instance illustrated being five. Fig. 4 gives an elementary sectional elevation showing the cylinders and valves of both pump and motor, and the pipes forming the connection between them. A represents the plungers and B the valves of the pump. Connection between the two is made by passages leading from the head ends of the pump cylinders to the centers of the corresponding valve chambers. C represents the valves and D the plungers of the motor. Here the passages between the valve chambers and the plunger cylinders lead from the center of the valve chambers to the head ends of the motor cylinders. The corresponding ends of the two valve chambers are connected by the pipes E and F. One pipe carries the oil in one direction and the other pipe returns it in the opposite direction. The outer ends of the five valve chambers of the pump are connected by the circular passage G and the inner ends by the circular passage H. Likewise the five valve chambers of the motor are connected by the circular passages I and J. In this elementary diagram the two shafts (both driving shaft K and driven shaft L) are shown in the same line, although disconnected. It will be readily seen that the two shafts may occupy any angular position with reference to each other, and any distance apart, the connecting pipes being arranged

* Continuation of the article in relation to the Manly drive, from the issue of December 10, 1908.

The Length of the Stroke is Adjustable.—The stroke of the pump may be varied at will; that of the motor is fixed. The variation of the pump stroke is accomplished by a crank on which is mounted an eccentric bushing. By revolving the bushing with reference to the crank its center line is brought into alignment with the center of the shaft, and when this position is reached no reciprocating motion is communicated to the pump plungers.

The High Speed is Coincident with Full Stroke.—When the pump

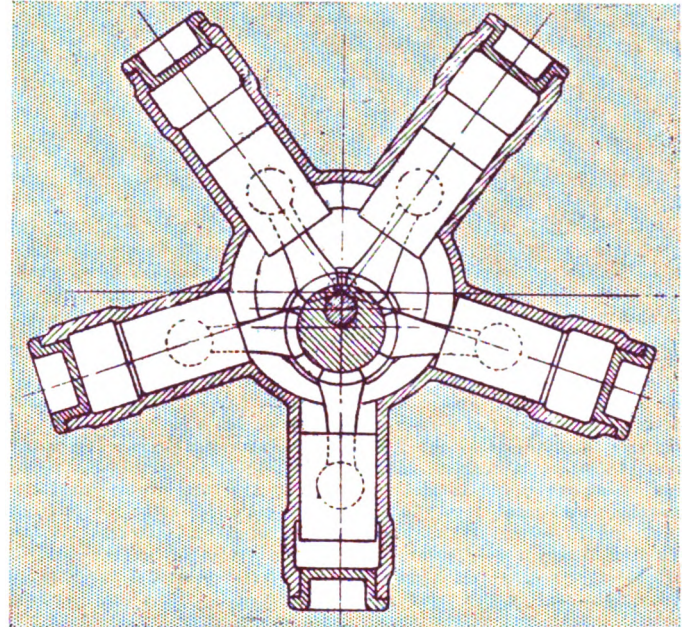

Fig. 1—Disposition of Multi-Cylinders Around Crank Chamber.

is running at full stroke the motor operates at the highest speed. By varying the pump stroke and thereby the velocity of the oil in circulation, the motor runs at a speed which is just in proportion to the amount of oil that passes through it. Any desired rotative speed can therefore be secured and maintained. For reversal the pump stroke first passes through the zero point. Then the valves change, and the oil is simply pumped in the opposite direction through the ports and pipes. Referring to Fig. 4, when the motor is going forward, Pipe E furnishes a supply to the motor transmitting the oil under pressure from pump to motor, while Pipe F returns it from motor to pump, thereby answering the purpose of an exhaust pipe. When the motor goes backward Pipe F becomes the supply pipe under pressure, and Pipe E changes to the exhaust pipe; the direction of circulation through the connecting pipes being completely reversed. In case of a sudden check in the speed or a quick reversal, the momentum due to

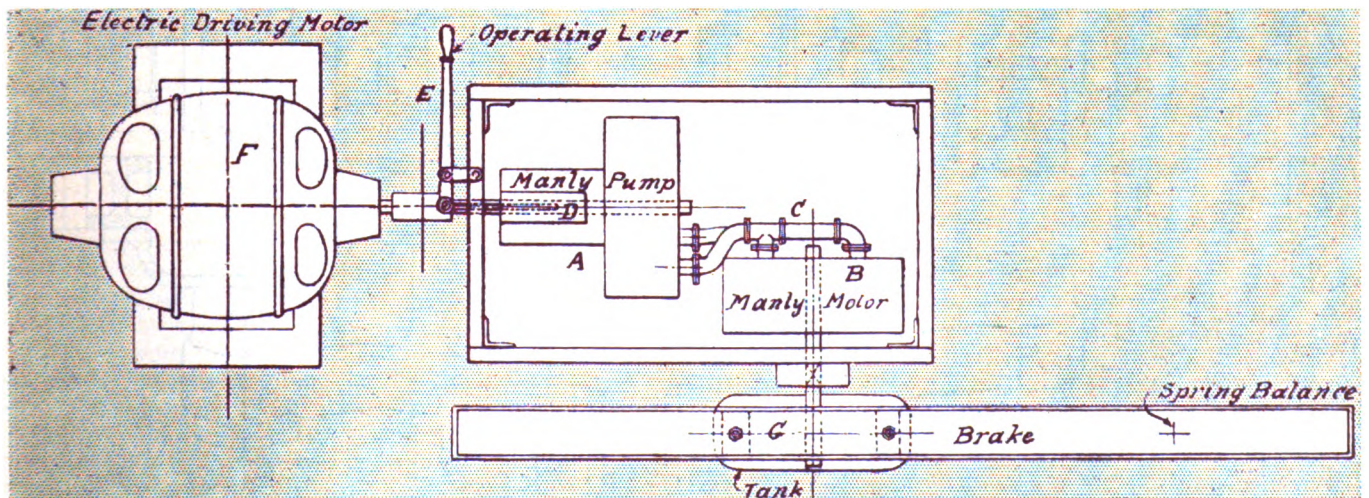

Fig. 2—Diagram of Testing Equipment Involving Motor, Manly Drive, and Prony Brake Suitably Balanced and Calibrated.

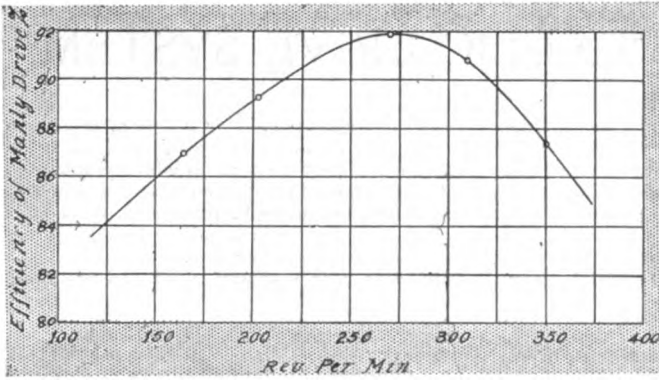

Fig. 3—Curve of Efficiency of Manly Drive as Found by Test.

running in one direction is taken up in the device itself. A safety valve, set at 2,000 pounds per square inch, opens a by-pass when there is an over-pressure, and this acts as a cushion, preventing injury to the machine.

How the Length of the Stroke is Adjusted.—Considering Fig. 3, the crank by which the length of the pump stroke is adjusted: A is the center of the shaft, B is the center of the bushing, while C is the center of the crank. Point C lies half way between points A and B when all three are in line. With this arrangement it is readily seen that when the bushing is rotated at 180 degrees around the center C of the crank, the center of the bushing, which is the real crankpin, is brought into exact alignment with the center of the shaft, and when this occurs, the length of the crank becomes zero and the reciprocations cease, as explained above.

Speed is Changed by the Rotation of Crank Bushings.—The rotation of the crank bushing from the position of maximum stroke to the no-stroke point is accomplished by the use of an auxiliary piston, lying parallel to the shaft, and supplied with power from the fluid pressure of the pump, and this piston operates on the bushing through appropriate mechanism. It is under the control of a pilot-valve, which is moved at will by means of a hand-lever. By simply moving this lever from one end of its throw to a central position, the speed of the motor shaft is varied from its maximum speed to a condition of absolute rest, and by moving the lever to the other end of its throw the motion is reversed and any speed is secured ranging from zero to a maximum speed in the reverse direction. Meanwhile, the driving shaft continues to run at con-

stant speed, whatever the speeds or direction of motion of the driven shaft.

In Neutral the Drive Serves as a Brake.—When the motor comes to absolute rest, the pump stroke being reduced to zero, no motion of the motor is permissible in either direction until the adjustment is changed so that the fluid again begins to flow from pump to motor. Its effect at such times is that of a brake applied to the wheels, though much more positive and reliable. The importance of the brake feature can hardly be overestimated when it is remembered that all the effects as to varying speed, reversal of motion and brake action are brought about by the movement of a single hand-lever. When the lever is in its forward position the machine goes forward at maximum speed. When the lever is pulled over to the middle position the machine comes to rest and is locked there as with a brake. When the lever is pulled over still farther to its extreme backward position, the machine goes backward at maximum speed.

Torque Increases as the Speed Decreases.—Still another feature of the Manly drive should be mentioned which peculiarly adapts it to road vehicles traveling in a hilly country, and that is the increase of torque in the driven shaft as the speed is reduced. The torque increases in exact proportion as the speed decreases. In other words, by slowing down the driven shaft the torque or pulling power may be increased to any degree within the limiting blow-off pressure of the safety-valve. Whatever the capacity of the engine, the vehicle may be propelled up any hill, however steep the grade, provided the speed is slow enough, and the wheels do not slip.

By referring back to the earlier article in THE AUTOMOBILE the aims and possibilities of the drive will be rendered at once apparent, and by examining the curve for efficiency (Fig. 3), as given in this article, it will be seen that the plan not only represents flexibility, but that the power is quite thoroughly used up in actual tractive work. Fig. 4 is a diagram of the equipment for test purposes.

As will be observed the efficiency is not only very high, but it is what is designated as a "flat-top" curve. True, the efficiency is not absolutely constant for all speeds, but it is very nearly so. The lowest efficiency is at the lowest speed (84 per cent.), and the highest efficiency is at the mid speed (92 per cent.), while the speeds range from about 120 to 375 revolutions per minute. Considering the very low speed, on the one hand, and the wide range of speeds on the other, the performance is extremely good, especially in commercial work involving slow speeds.

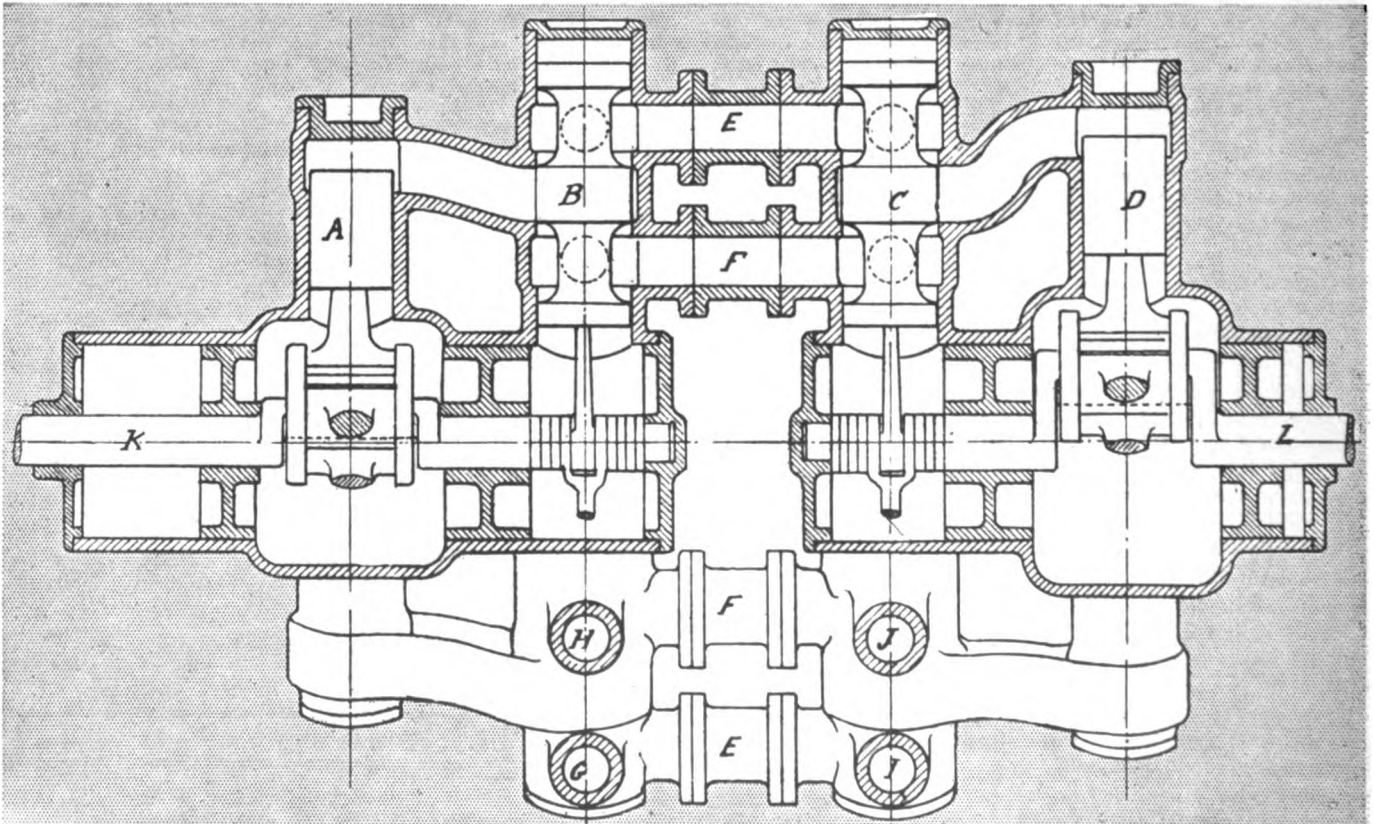
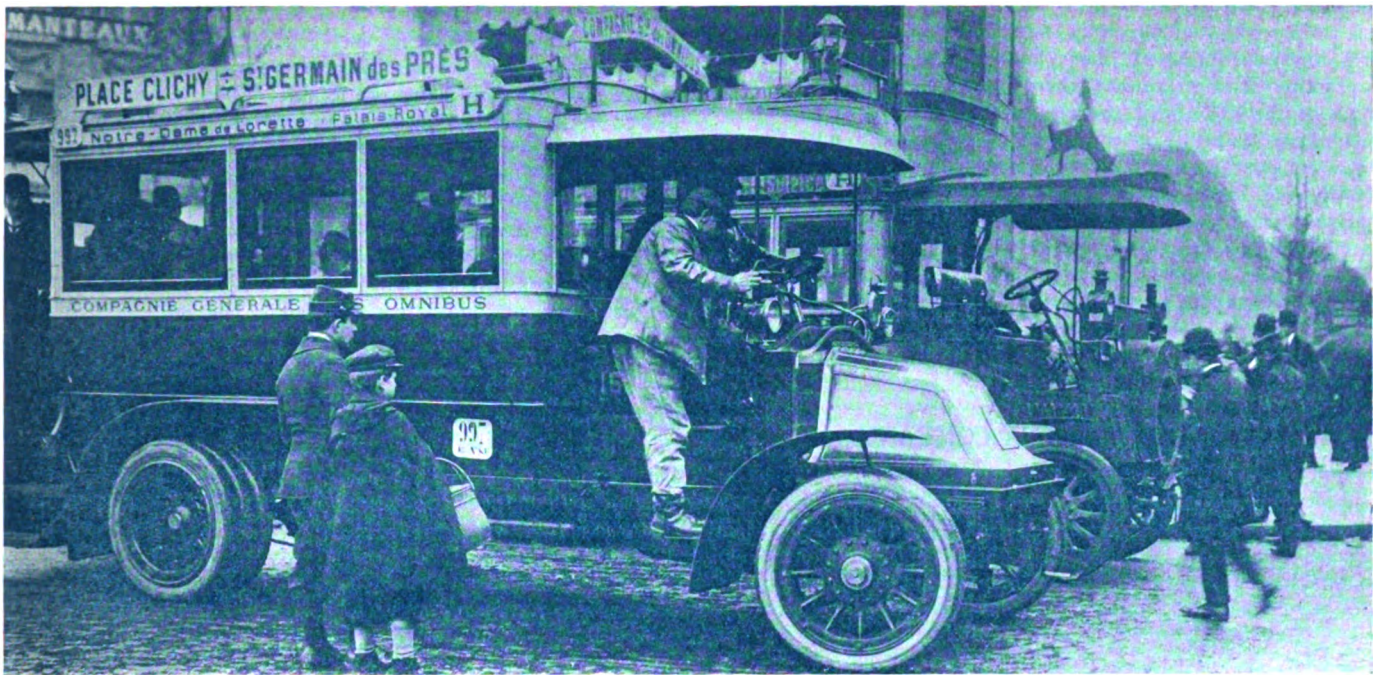

Fig. 4—Elementary Sectional Elevation Showing Cylinders and Valves of Both Pump and Motor.



New Renault Omnibus Now in Service in Paris, with Double and Triple Tires—Old Type 'Bus Alongside.

A FRENCH OMNIBUS WHICH USES PNEUMATIC TIRES

PARIS, Jan. 27.—An omnibus mounted on pneumatic tires is the luxury that the General Omnibus Company of the French capital is offering to its clients. In a little over a year's time the monopoly of the present company will expire, and if it is renewed it will be only on condition that all horse buses are abolished and a satisfactory type of mechanical vehicle substituted throughout the city. With a view to showing what it was capable of doing the company commenced the gradual conversion of its vehicles about three years ago, certain lines being changed from horse to gasoline traction. But a perfect type of bus was not easy to find, and, although the company has now nearly two hundred buses, they are not all of the A1 mark. Automobile traffic moves fast in Paris, the buses being no exception. The consequence is that the mechanism, mounted on solid rubber tired wheels, goes to pieces long before it ought to, the passengers suffer from excessive vibration and the inhabitants of houses along the routes complain of the noise and shaking of their dwellings.

After numerous tests the company has now decided to adopt a new type of bus, and it is as the result of this decision that the public is now initiated to the luxury of pneumatic tires. The first of the new vehicles, a Renault of 20-30 horse-power, has just gone into service from Place Clichy to St. Germain des Pres, Paris, one of the most difficult routes in the city, for it comprises crowded streets, some steep grades and rough pave, all enemies of the motorbus. The new Renault, the first of a series of 75 similar vehicles, is mounted on Michelin triple and twin tires, the former being for the rear wheels and the latter for the steerers. This new type of rim and tire, which has been under test for the past two years, only made its appearance in public at the recent Paris Salon, and is now being given its first real commercial test, the Renault being the first ordinary public service bus in the world to be mounted on pneumatic tires.

All previous buses have been two-deckers, with canopy top for the protection of outside passengers. The Renault is a single-decker, having capacity for 21 passengers, nine of them having first-class seats in the forward part of the bus, six second-class seats and six standing on the rear platform. The body is swung lower than on any previous type of bus, is wider, has a much more commodious platform and is entered with greater ease.

Artificial lighting is by powerful acetylene lamps, big side windows, in place of smaller ones on the older buses, let in ample daylight, and heating is by means of a pan running the full length of the bus and receiving the hot gases from the exhaust. Normally the exhaust is discharged vertically at the top of the vehicle, but when required for heating can be turned into the foot pan, thus going for utility.

A touring car chassis would naturally be impossible for a vehicle destined to take a charge of three tons; but though the Renault bus is a special construction, it embodies all the distinctive Renault features. Thus the frame is of very deep section pressed steel, strongly bound by cross members and angle plates and suspended on semi-elliptic springs both front and rear. The front wheels are wood artillery type, with special double dismountable rims; the rear wheels are of the steel plate type, each with dismountable rims for three tires. There is a considerable rear overhang of the frame to give the necessary body space, the body itself, however, being kept within the axles.

The engine, unlike other Paris buses, is not under the driver's seat, but carried forward under a Renault type of bonnet, with radiator on the dash, the water circulation through it being by thermo-syphon. The driver's seat is placed on the left-hand side, with brake and change speed levers in the center of the space, this position, it is believed, being to the advantage of the driver for crowded city work. Another innovation for a city bus is the use of a self-starter of the compressed air type, worked off the timing gears, as on Renault touring cars. The control of the starter is at the left-hand side of the dashboard, and is provided with a special lead for taking off compressed air.

Even for such heavy work all Renault touring car characteristics are adhered to for transmission and final drive, the clutch being of the leather-faced, inverted cone type, the gear set of the progressive type, with three speeds forward and reverse, and the final drive by propeller shaft and rear live axle. Naturally, all the parts are adequately strengthened for the work they have to perform, and gear ratio is very much lower than on touring models.

It remains to be seen whether a bus of this type—perfect from the standpoint of the passenger, for it possesses speed, quietness and an entire absence of vibration—will be satisfactory to the

operating company. It is declared that the ten pneumatic tires cost no more to maintain than the solid rubber and rubber block tires formerly employed. This, however, remains to be proved in practice. It is certain that there will be a considerable lengthening of the life of the mechanism as the result of the use of pneumatics, and this item will have to be taken into account when considering the smaller earnings of the bus due to the abolition of the upper deck. It has commonly been supposed that pneumatic tires were impossible for public service vehicles on account of their cost, but there was also another factor, namely, their inability to carry the loads put on commercial vehicles. If, as is claimed, the tire cost is not excessive, the introduction of twin and triple tires will cause a revolution in the motorbus world, for the public will not consent to ride on solids where pneumatics are available.

TRUCKS FOR TEA COMPANY.

NEW YORK CITY, Jan. 25.—A move indicative of the tendency of the times is the substitution of motor delivery wagons for the former horse service. This move on the part of any large company as a result of thorough investigation of the problem will doubtless be watched very closely by hundreds of allied concerns who are seriously considering a similar change.

The latest announcement in this line is that the Great Atlantic & Pacific Tea Company, of Jersey City, N. J., which operate 323 branch stores, and employ 1,500 horses in the handling and distribution of their supplies, have, after a series of extensive and varied tests, covering a period of over two years, decided to adopt the gasoline motor vehicle for delivery service.

This company's conversion has been demonstrated by placing its first order with the Autocar Company, of Ardmore, Pa., for a number of trucks to be used at five of their prominent branches, notably Baltimore, Newark, Washington, Passaic and Jersey City.

BUT THE "CABBIES" WILL DISAPPEAR.

DETROIT, Feb. 1.—A truce has been patched up between the warring factions in the cab-taximeter fight, and peace once more reigns, for the time being at least. When taxicabs first appeared in Detroit and stationed themselves in front of the hotels, a howl went up from the local jehus guiding the archaic vehicles compelled by the common council to content themselves with stands about the city hall. The "cabbies" wanted the "taxies" placed under the same restrictions regarding rates of fare as governed them, and insisted on the taxicabs being kept away from the hotels.

Finally a compromise was effected. The question of fares was waived by the "cabbies," and in return Manager Scrimger, of the taxicab company, expressed a willingness to share the space in front of the hotels with the horse-drawn vehicles, providing the latter could secure written permission from the owners of the hostleries. As a result the "cabbies" are congratulating themselves on their victory, although the desired permission has not yet been granted.

IF WAR, FRANCE WILL TAKE ALL AUTOS.

PARIS, Jan. 27.—All automobiles in France, whether used for pleasure or business purposes, are to be controlled and registered in such a way that they will be ready for incorporation into the service of the army in time of war. Every year, from January 1 to 15, according to a project which has just received the sanction of Parliament, a census of automobiles must be taken.

Price to be paid the owner of an automobile being requisitioned for active service, will be clearly settled in advance, the vehicles being placed into three categories, comprizing those less than two years old, those having been in existence two, three or four years and those having been constructed five or more years before the date when the census is taken.

ONE ST. LOUIS COMPANY EMPLOYS 53 ELECTRIC TRUCKS

ST. LOUIS, Feb. 1.—One of the large brewing companies of this city operates 53 electric trucks and delivery wagons, more than half of which are Waverleys. Of the 53 electrics, 48 are in daily service and are standing up to their duties in a truly remarkable manner, as the following record for month's service, taken at random, will show:

28 did not lose a minute's service for any reason whatever.

16 missed one day apiece during the month on account of the drivers not being on duty.

4 lost from half a day to a full day on account of general repairs.

In other words, the number of automobiles out of commission for the month on account of repairs was less than one-fourth of

1 per cent. of the total in operation—and this is the record of a company that keeps its wagons constantly active.

To keep all these electrics in operation requires only one machinist, one battery man, a boy, a foreman and two wagon washers. This small amount of labor for so much equipment goes to show that electrics are easily maintained in first-class condition under favorable conditions of cost.

The Waverley Company, of Indianapolis, is the pioneer builder of electric vehicles for commercial purposes in this country and has spent thousands of dollars in costly experiments to develop its trucks to their present high state of efficiency. The value of this experience is now becoming manifest in the growing use and appreciation of electric commercial vehicles in all the large cities in very important work.



Waverley Electric Trucks in Daily Service for One of the Large St. Louis Breweries.

ELECTRICS CHASSIS AND BODY NOW BUILT SEPARATE

"In ye olden times" electric vehicles were so designed as to include chassis and body as inseparable. It was not then possible to select a chassis on which all the equipment would be found, and thereafter use any kind of a body that fancy might dictate. In connection with gasoline automobiles the reverse was true almost from the start, and it was soon rendered apparent that advantage was with the designs in which the chassis was complete and the body work figured as a separate unit, taking into account the convenience of the autoist.

It will come as no surprise to those who have kept tabs on the doings of the advanced designers of electric vehicles in the statement of the fact that "Baker" makes the chassis of the electric separate, and that any kind of a body can be selected. The illustration of one of the Baker chassis as here given will at once disclose the fact that all the machinery, including the battery and the control, is quite independent of the body work, and any desired design can be selected, or, in the course of events, it is desired, to make a change it is easy.

There are manifest advantages in a plan of this sort, aside from the fact that the body can be as wanted or changed at will. It is generally well understood that body work as it obtained in the past did not thrive because the battery gave off acid fumes, and the action of the fumes was such as to depreciate the body at a too rapid rate. In the new Baker way of building electrics the body is so separated as not to be under the influence of the battery, and the electrical equipment is so distinct as not to influence the situation for ill. On the other hand, the separate chassis idea is good in that should the body give out in time only a question of a new body would have to be considered, instead of being confronted with not only a new body but much more besides. Under the old plan, even if the chassis could be rescued, the fact remains that the battery box, wiring, and oft-times much else, would have to be replaced, and the upshot was that the task became far too formidable, with the result that the cars so designed went to the second-hand dealer.

In the illustration it is to be noted that the motor (electric) is located in the mid position, between the front and rear axles, and the "drum" type controller comes forward of the motor, under the footboards of the deck. The motor is of the "double reduction gear" type, and brakes are provided on a drum on the second shaft. The sprocket pinion is also on the second shaft, and one chain connects with the differential sprocket on the live rear axle. The live rear axle is of the latest and most approved type, provided with emergency brakes, and in every way it is up to a most fitting standard.

The front axle is a standard automobile proposition in every particular, and the one big difference lies in the fact that the steering wheel is on the left side. This scheme of steering is looked upon as of the greatest benefit in "town service," and it is in this same town service that electrics have proven to be of the greatest utility. The chassis frame is of the channel section quite up to the standard set for gasoline cars, and the spring suspension is elliptic in the rear, with half-elliptic front springs.

The electric wiring, which was the bane of all the earlier electric efforts, is so nicely done in the new Baker cars as to demand special mention. All who may have had occasion to follow the progress of the electrics in the past were in accord in one or two particulars, and it is very likely that the wiring question, with its high depreciation, was one of the points on which they agreed. They will all be glad to know that in the Baker chassis this question is not to be one for future trouble. The wiring is so arranged as not to be in the category of trouble. In the event of trouble on the road, which is remote in a car of good design, it will be easy to handle in view of the accessibility of the wiring, controller, and the motive power.

The steering wheel is of standard characteristics, and the drum

controller is manipulated through the good offices of a "miter gear," one member of which is on the drum and the other member is on a tube related to the steering post in such a way as to enable the driver to manipulate the drum with ease and according to the requirements. All the details for the perfect control of the car are worked out in the light of much experience, and they show the earmarks of a shop adequately equipped.

The battery space is large, and the ease with which the battery can be examined is something to be taken into account. In the older types of cars in which the battery, more often than

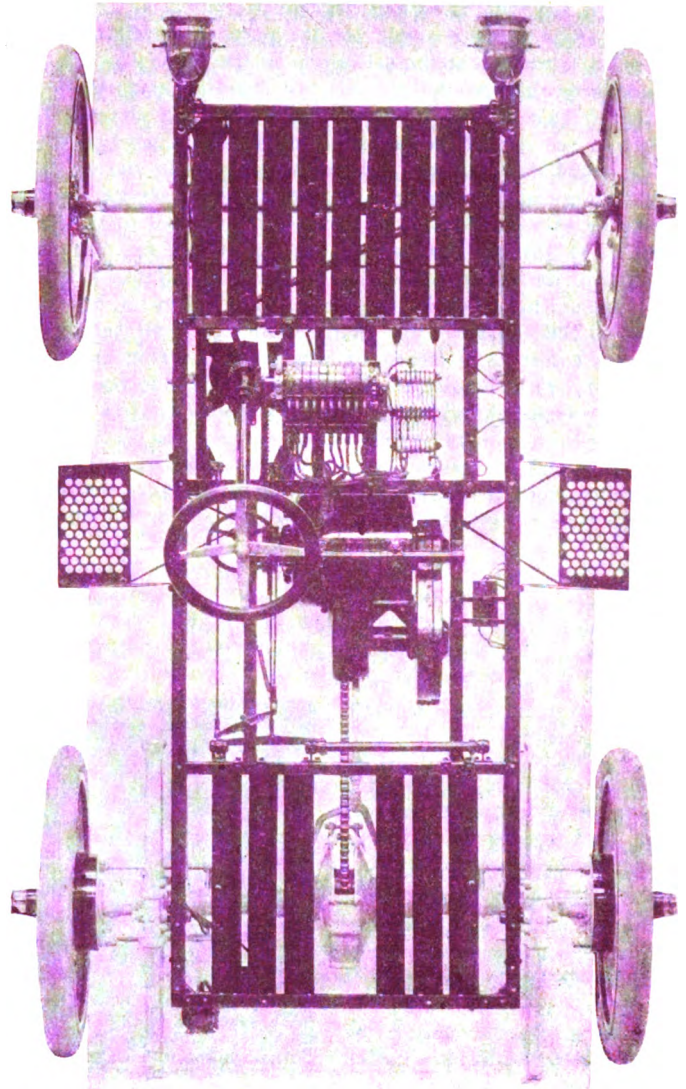

Baker Chassis Complete Allows of Body Choices.

not, was so placed as to be inaccessible, trouble was frequently of the sort that ended in a feeling of great dissatisfaction, on the count that if the "spot" could be reached the trouble would melt as snow in the full blaze of a tropical sun. In other words it was not the magnitude of the trouble so much as it was the fact that the "itch" could not be reached.

There is one other point in relation to the cars of the subject. It is well understood that the energy of the battery should be conserved, and if the chassis is not carefully designed along lines to cement harmony the energy of the battery is bound to be dissipated to a vast extent, and the mileage of the car will then be reduced. In the Baker cars this question of the mileage is well looked after and the losses are reduced to the minimum through the use of anti-friction bearings.

A HOME GARAGE EQUIPPED FOR ELECTRICS

THE garage illustrated is that of Mrs. John T. Brush, of Indianapolis, Ind., and in view of the wide interest in the practicability of the scheme it will come as a pleasurable bit of information, with assurance that, in this case, the home garage is an unqualified success. In view of the interest taken in this phase of the automobile situation, it will be well to outline the plan, enumerate the equipment, and state some of the advantages, and to say that the Pope-Waverly electric used in this case is what is known as the model 70-C. As a general rule it is true that space is cramped in well-populated districts, and a stable is not without serious drawbacks.

The garage is quite ample for the purpose in this case, but the point is made that there is room in the same which is not monopolized, in that the car and the charging equipment take up but a fair amount of space. The charging equipment is shown to one side of the car, and it consists of a panel on which are mounted in a neat and substantial manner the devices used for the purpose. The outfit consists of (a) the "service" switch, by means of which the electric service is admitted to the "bus-bars"; (b) the charging switch, through which the current is admitted to the battery; (c) a lighting switch, by means of which the lights are turned on in the garage; (d) a voltmeter, by means of which the voltage of the charging current is measured; (e) an ampere meter, by means of which the charging current is measured; (f) a rheostat, the function of which is to regulate the strength of the charging current; (g) suitable safety devices, affording protection as against excesses of the electrical supply; (h) the panel of marble, on which the devices are mounted (sometimes slate is used), the panel itself acting as an insulator; (i) the framing, of iron, which serves to maintain the panel in position.

The panel stands out from the wall enough to enable the workman to mount the devices from the back, and the wiring and connections are all out of sight, yet accessible.

When a direct current of electricity is available, it is the rheostat that is used for the purpose of regulating the strength of the current. If, on the other hand, alternating current has to be dealt with, it is then that a "rectifier" is provided for the purpose. At all events, the scheme is perfectly simple, and the charging plug is so devised that it cannot be inserted wrong, and in divers ways protection is afforded so that any one can do the work.

In Pope-Waverly electric vehicles the battery is so arranged and of such a capacity that it is rarely drawn upon for a full charge, and when it is to be charged it is "floated" on the circuit, so that the "man" does not have to attend to it, to any great extent, if at all. On rare occasions it is desirable to give the battery a full "corrective" charge, which is only a matter of starting the charge at a somewhat higher rate, and allowing the same to "taper" down to the minimum, then, by increasing the charging rate again and allowing it to taper off as before, the battery becomes refreshed to

a marked degree, and the amount of work attending is but slight.

Any one can do the "charging," as it is called, after being shown once, and while it is true that the time will arrive when the "batteryman" will have to come around and take the "gravity" of the electrolyte and equalize the same, it is far from the amount of work which has to be expended upon even a single horse. The vehicle is always ready for service, and it can be taken off the "float" at a moment's notice. As a matter of fact, the more the vehicle is used the better will the battery work, since it is true of batteries that the "pores" are kept open if the battery is charged and discharged frequently. True, the life of the battery must, in the long run, be taken into account, but it is remarkable how long a battery will last, especially if it is kept in constant use, receiving its charge daily, as the car comes home.

There is no denying the fact that constant use is better than intermittent service, and it is one of the advantages of the electric vehicle that it thrives in service. The Pope-Waverly is intended for that class of users who really need a car, and who utilize it frequently. Every attempt is made to reduce the maintenance to an automatic basis, and in the control of the car simplicity is so conspicuous that the cars may well be entrusted even to a girl of few years and small experience.

The car rolls on anti-friction bearings, the weight is moderate, and the distribution of the weight is on a scientific basis. As a result, the performance is smooth, the battery is conserved, and noiseless elegance is written all over the product. After the car (in a given case) has performed its day's work, it is run into the garage, washed, and the charging plug is inserted, the resistance is adjusted, and the rest is done without the personal attention of the owner or the man whose duty it may be to look to the wants of the car.

On the whole, it is plain that an electric will do far more work than can be done with horses, and the attention which must be lavished on horses would be wasted on the electric, moreover the electric is an equipment of surpassing elegance, ever ready.

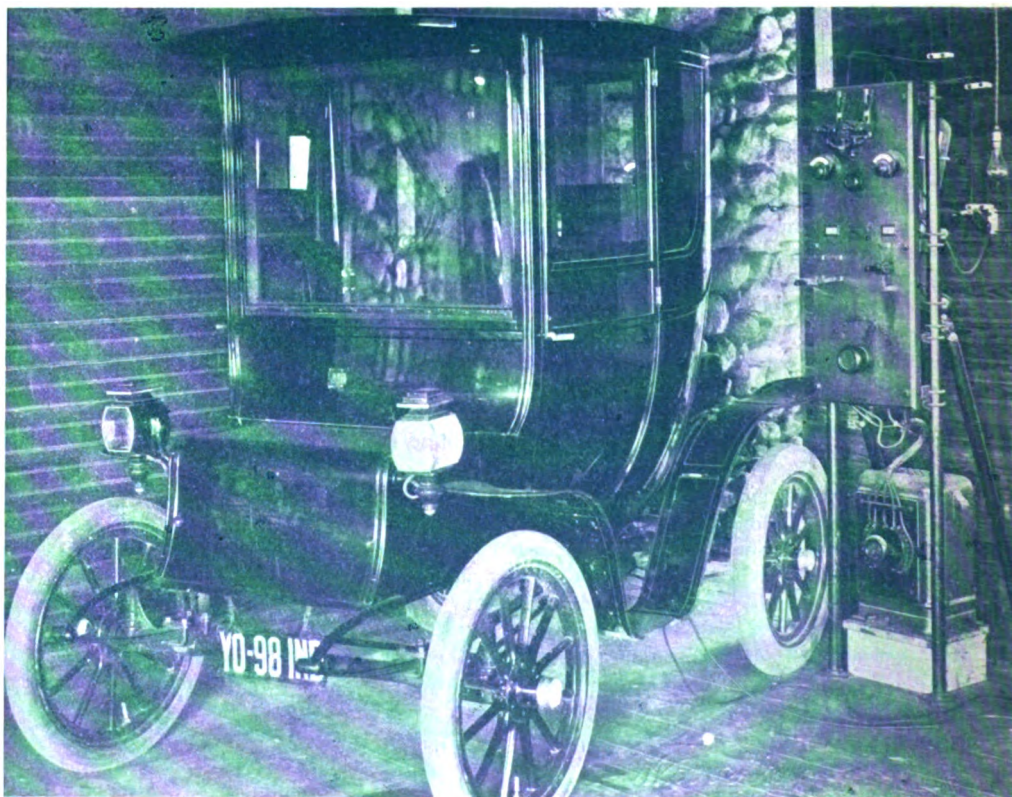

Charging Plant in the Garage of Mrs. John T. Brush, of Indianapolis, Ind.

LETTERS INTERESTING AND INSTRUCTIVE

COMPARISONS ARE EXTREMELY ODIUS.

Editor THE AUTOMOBILE:

[1,729.]—Will you kindly inform me in your "Letters Interesting and Instructive" whether there is any inherent defects in air-cooled motors for automobiles? I am contemplating the purchase of a four-cylinder air-cooled car, recently placed on the market by a Western manufacturer, but am advised with great unanimity from all quarters not to buy an air-cooled car unless I can afford to get a well-known make which has been on the market for a number of years.

Does your experience and information warrant the assumption that the general aversion to air-cooled cars is simply a matter of prejudice, or is it founded from the experience of users of this kind of motor.

Also, if the air-cooled motor is reliable, why are they not in more general use, considering their many advantages?

New York City.

H. L. D.

Your question is one which cannot be fairly treated in a "trade journal," if the answer is to be of a specific character, for good and sufficient reasons. In the first place, it is not possible for the editor to become adequately familiar with the details of construction of any given motor to be able to take the stand and say the motor is not good. Then, it is not the business of a paper to predict. The paper is doing its duty to the trade and to its readers as well when the facts (of interest) are clearly set forth and if the trend is reflected.

It is not plain that there is a general aversion to air-cooled motors. The extent to which air-cooled motors are used in automobiles is quite too broad to enable one to say there is any evidence of aversion. On the other hand, there is evidence of the fact that the motors are quite satisfactory to the class of users who have the good sense to select the kind of motor that accords with the specific requirements. In your case it is a question of determining the specific needs and then you should find a motor which will do the specific work.

Your last question is extremely difficult to cope with and it may be true that the reason why air-cooled motors are not more generally used is the same reason why "grand opera" does not become as common as its merit would seem to indicate.

DISCREPANCY IN HORSEPOWER RATINGS.

Editor THE AUTOMOBILE:

[1,730.]—Below please find a list of a few automobiles showing the corresponding bore and stroke with claimed horsepower:

	Bore.	Stroke.	Horsepower.
Leocomble	4½	4½	38
Great Western.....	4	5	30
Overland	4	4	30
Mitchell	4½	4	28-30
Cadillac	4	4½	30
E-M-F	4	4½	30
Franklin	4	4½	18

You will note especially that the Franklin, which has the same size cylinders as the E-M-F and Cadillac, does not claim near as much horsepower. I have talked with several of the large dealers, but with one exception I have not been able to get any of them to figure out how their car comes to have so much more horsepower than some of their competitors. One dealer was frank enough to admit that very few cars were up to the claims made for them by the manufacturers. If there is a way to figure this out, kindly give it in your answer to the above.

Merriam Park, Minn.

A SUBSCRIBER.

Some of the companies see it in one way and more in another. In some cases it is desired to keep in reserve enough power to render the performance of the cars somewhat better than the promises. In other cases the makers put their best foot forward. There may be cases in which the best foot is artificial. In such cases it is not of necessity in the motors claiming the most power for a given displacement. The 4 1-2 bore will no doubt do the work claimed for it. In fact, it is quite possible for the several cars to perform in the manner as claimed by the makers. What a motor will do is certainly a matter depending upon the manner in which it is designed.

WANTS TO KNOW IF IDEA CAN BE PATENTED.

Editor THE AUTOMOBILE:

[1,731.]—I would like to know if an idea which I have can be patented, and what should be done to secure the same. This is it: To close both ends of piston, as is done in steam engines; this would give two cylinders about the strength of three; and setting the crankshaft at 45 degrees, which would enable the chauffeur to start the machine from the seat. More sparkplugs would be necessary, but this is of little weight by way of increasing the price of the machine, even taking into account the fact that more valves would also have to be furnished.

T. LANDOZ.

Humacaco, P. R.

You can apply for a patent yourself if you have the skill necessary to enable you to make the necessary drawings, and render a description so clear as to enable any one skilled in the art to build the device. If you have not the skill, it will be necessary for you to engage an attorney with a license to practice before the patent office.

From your statements it would seem that you have in mind the fact that the cylinders can be made "double acting" and by so doing increase the number of power strokes in the motor. It may be as you say—it is not patentable, on the ground that it is now common practice in gas engine work, considering engines of the larger sizes. It has not been shown in practice that anything is to be gained in the application of the principle to automobile motors.

WHAT WILL A FAN DO FOR A HOT MOTOR?

Editor THE AUTOMOBILE:

[1,732.]—I have a light runabout that weighs about 1,800 pounds, which is equipped with an air-cooled motor. At times the motor runs very hot. Will a fan, suitably placed in front of each cylinder, abort the difficulty?

P. O. PETERSON.

If the motor runs cool most of the time, or, even a part of the time, it would seem as if you do not look in the right place for the trouble. True, the fans, as you suggest, will help out, but it is probable that the motor runs hot because you do not afford it the uniform set of conditions, such as will afford you a uniform result.

In the first place, a motor will run hot if the spark is retarded and so held. Then, it is important to use an adequate supply of a suitable grade of lubricating oil. On the other hand, if the mixture delivered by the carbureter is rich the motor will heat up. On the whole it would seem as if you will have more to gain by regulating the spark, adjusting the mixture and supplying an adequate quantity of lubrication oil than proceeding in the manner you suggested.

KEROSENE CREEPS IN BEHIND THE CRUST.

Editor THE AUTOMOBILE:

[1,733.]—Kindly let me know what effect kerosene has on carbon; also, what is generally thought of the carbon cleaners now on the market? what effect acetone has on carbon as a cleaner, also kerosene, alcohol and turpentine? I understand that any or all of them used singly will clean carbon from cylinders, etc. Which is the better scheme, of using kerosene or any of the above, injecting it in petcock on top of the cylinders, or putting a petcock in the intake pipe between the carbureter and the cylinders and inject it in there? With the engine running, it will then be sucked into the four-cylinders in the form of a spray or vapor, the same as the gasoline is supposed to be sucked through pipe. Do you think that this is better than the first mentioned, as in that case the liquid kerosene lies on the pistons and is much more liable to leak through rings and dilute the cylinder oil already in the crankcase. Kindly explain how the G.L. economizer works applied to a carbureter. How is this possible to save the consumption of gasoline?

Brooklyn, N. Y.

W. R. N.

The crust in cylinders is not carbon. There is carbon in it. Kerosene has the property of creeping in behind the crust and killing the bond. The result is the crust will fall off of the walls and in small increments it will be swept out of the cylinders. The reports of the performance of carbon removers are so good

that we are persuaded into the belief that they are well worth a fair trial by any one who has trouble with cylinders.

If kerosene is to be used, it should be injected into the cylinders after the motor is shut down, and it should be left there over night or longer if possible. Then it will be necessary to remove the excess of kerosene with such sediment as will come out with it.

Alcohol does not seem to promise much as a remover of crust. Acetone has some value as a solvent. Turpentine is not as good as kerosene. In any case, no matter which of the solvers are used, if they get into the lubricating oil, it is necessary to remove the same, and replace it with new, pure, lubricating oil.

The "economizer" to which you relate is valuable in that it renders the mixture more nearly a permanent gas, and it is the aim to hold to a constant desirable mixture under all changes in speed of the motor.

DEPENDS UPON THE REAL QUALITY OF STEEL.

Editor THE AUTOMOBILE:

[1,734.]—Please answer the following questions: 1. Isn't chrome nickel steel of 125,000 pounds tensile strength suitable for axles and spindles for automobiles? 2. If so, is it better to have rear axles case hardened, and also spindles? 3. Spindles about 13-16 inch, and rear axle 1 inch diameter—are these heavy enough for a car of about 1,100 pounds? 4. I want a two-cylinder, 12-horse-power double opposed engine. How can I make the correct decision on these engines?
SUBSCRIBER.

Galva, Ill.

The fact that the steel is chrome nickel and that the tensile strength is as you say, means very little. If the elongation is, say, 20 per cent in 2 inches, with the tensile strength as given, it will indicate a possible fine grade of steel.

If it is desired to have the spindles case hardened it will be desirable to use steel low in carbon; the carbon should not be above 16 points.

If case hardening is to be resorted to, it may be possible to consider the use of mild steel instead of chrome nickel steel. At all events, care should be exercised to procure a good grade of the same if it is used for the purpose.

If a live rear axle is used, the shaft should be 1 1/4 inch in diameter for the load you state. The fact that the steel is alloyed will not help you out by way of reducing the diameter of the shaft, on the ground that the torsion will not be reduced, and the modulus of elasticity of the chrome nickel steel may not be higher than the modulus for good grades of acid open hearth steel. If the modulus is the same, the amount of material should be the same.

To be able to keep from getting in wrong on the engine, it will be necessary to consider two or three good business principles. In the first place, you must pay enough to cover a good engine; then it is necessary to go to the makers of the kind you want, and you must be able to recognize one when you see it. At all events, do not evince a desire to part with your money; be curious about the engine until you are stalled with information in relation to the same, and fail to buy from the vendor who has not the time to tell you of the qualities of his product.

HOW TO TIME A FOUR-CYLINDER MOTOR.

Editor THE AUTOMOBILE:

[1,735.]—Will you tell how to time a four-cylinder motor with intake valves on one side and exhaust valves on the other? also how to put the timer back in its proper position? H. BUSH.
Schenevus, N. Y.

Put the timer back so that the range of spark advance will be about four-fifths of the total range. In other words, it is necessary to be able to "crank" the motor on a "retarded spark," and the timer should be put back in such a way as to enable you to crank with safety. But it is not a good idea to waste any more of the whole range in the cranking part than is necessary.

In relation to the question of correct timing, THE AUTOMOBILE of November 5, 1908 (page 639), will give you more information than will be possible here in limited space. The fact that all the valves are on one side of the motor will not alter the plan.

MOTOR KNOCKS WHEN THE SPARK IS ADVANCED.

Editor THE AUTOMOBILE:

[1,736.]—In a four-cycle gasoline motor, is the charge of gas, when the spark is advanced, ever fired before the piston reaches high center on the compression stroke, or does it always fire, when the spark is advanced, at the point of highest compression?

Why does a motor knock if the spark is too far advanced?

New York City.

A. B. E.

The mixture will fire when the spark is given if it is inflammable. Generally it is true that the mixture is fired before dead center (under running conditions) and the mixture is so slow burning as to take some time for the same to reach the state of complete combustion. Indeed, it is the case that (with the exhaust manifold off) the flame will "spit" after the exhaust valve is opened. This is but a sign of the fact that the combustion is not completed, even when the piston has traveled the whole stroke.

If the mixture is "quick," it is possible to cause the knock by the early increase in compression which follows ignition before the piston reaches the top of the stroke.

LEAKAGE AROUND THE SPARK PLUGS.

Editor THE AUTOMOBILE:

[1,737.]—The spark plugs and pet cocks on my car set in brass caps which screw into the cylinder head. There is a bad leak of compression around the thread of all these caps. Is there anything which I can put on these threads to make a tight joint—something corresponding to red lead on the thread of a gas or water pipe?

W. T.

Newton Center, Mass.

Take of yellow oxide of lead enough to make a paste for the purpose. Mix the same with glycerine (quite free from water) to form a paste of a good consistency. Use the same directly after mixing and allow it to set. It will set in half an hour, and it will attain great hardness. The glycerine must be free from water to attain the best results; which is not always the case.

BEST HARD LUBRICANT TO USE IN THE TIMER?

Editor THE AUTOMOBILE:

[1,738.]—Would like to ask what kind of a lubricant would you recommend for the inside of a timer? Also, how to clean the inside of an exhaust manifold? I cannot get at the inside with a scraper.

LOWELL S. ELLIS.

Warren, Mass.

A non-acid, non-mobile, hard grease is the best for the purpose. It should be of the "mineral" series; a hydrocarbon, in fact. Write to some of the advertisers of products of this sort; they will be found in the advertising columns of THE AUTOMOBILE.

Use kerosene oil. If you can have the work done by a sand-blast, the process is quicker.

BUT THE CAR WILL BE KNOWN AS THE "TOLEDO."

Editor THE AUTOMOBILE:

[1,739.]—On page 209, issue of January 28, we notice an article on the sale of the Toledo plant of the Pope Motor Car Company. We desire to make two corrections. One is, that the name of the new company will be the Apperson-Toledo Motor Company, but the product will be called the "Toledo," not the Apperson-Toledo, as stated in your article. A correction of your former article will probably avoid some misunderstandings and confusion.

Richard D. Apperson, the head of the syndicate purchasing the new plant, has never been interested before in the automobile business and has no connection whatsoever with anyone at present interested.

THE TOLEDO MOTOR COMPANY,

Toledo, Ohio.

F. C. Gilbert, Sales Manager.

FRANKLIN LAMINATED WOOD FRAME.

Editor THE AUTOMOBILE:

[1,740.]—In looking over your issue of January 21 we note on page 140 you refer to the Franklin wood frame as being armored. The chassis frame of the Franklin car is made of wood, laminated, and is not armored, and by reason of the fact that it is not armored, the shock and vibration which is ordinarily transmitted when steel is used, armored or otherwise, in the sill, is entirely eliminated.

We call this matter to your attention, thinking perhaps you will desire to make correction.

H. H. FRANKLIN MFG. CO.

Syracuse, N. Y.

MID-WINTER GOSSIP OF THE AUTO CLUBS

QUAKERS APPEAL CONTEST BOARD DECISION.

PHILADELPHIA, Jan. 30.—Although recognizing the jurisdiction of the A. A. A. Contest Board in the matter—with reservations—the contest committee of the Quaker City Motor Club does not propose to abide by the decision of the national committee in removing the disqualification imposed upon the Premier entry in the New Year's run, and will go over Mr. Hower's head with an appeal to the executive committee. It will be remembered that Chairman Hower's committee, to which the Premier people carried their case, decided that, in the absence of a specific rule covering the case in the regulations governing the run, the Quakers were not justified in disqualifying the car for having covered the hardest part of the Giant's Despair hill without its passengers, and removed the penalty.

Inasmuch as the A. A. A. had no set rules for the conduct of endurance runs, and in view of the fact that the run was conducted under rules promulgated by the Quakers themselves, a committee of the latter went to New York on January 22 to protest against the A. A. A. Contest Board's decision on the ground that under the circumstances the national body had no jurisdiction in the matter. The Quaker committee's idea was to argue the question of jurisdiction before the A. A. A. Contest Board and to abide by its decision.

The committee, therefore, repaired to New York on the 22d, but Chairman Hower absolutely refused to listen to any argument on the question of jurisdiction. The Quakers considered this action arbitrary, and it is understood that at one point the verbal combat became quite warm, and that the diminutive but doughty chairman ordered G. Douglass Bartlett, the Quaker's counsel, from the room. The latter asked Mr. Hower if the order was made as an individual or as chairman of the committee. The chairman replied that the order was made by him as chairman. Lawyer Bartlett, smothering his rage, turned on his heel and left the room, followed by the other Quaker.

On their return to this city a meeting of the Quaker City Motor Club Contest Committee was immediately called, at which it was unanimously decided to carry the case to a higher court, and the next day a formidable appeal, under no less than 22 heads, was sent to the executive committee, praying that the latter "review this whole matter, including the conduct of the chairman of the Contest Board, who arbitrarily stifled the freedom of speech and of argument on this subject."

The rank and file of the Q. C. M. C. seem to be of the opinion that the treatment of their representatives by the A. A. A. Contest Board, apart from the feeling that they have a good case and should have been given a hearing, was most arbitrary. Even the most conservative among them believe that a back-down now would be cowardly, whereas a patient hearing, followed by a reverse decision, would have been accepted uncomplainingly.

CLEVELAND AFTER GOOD ROADS CONVENTION.

CLEVELAND, Feb. 2.—There is a very fair chance that Cleveland will secure the 1909 Good Roads Convention, the local automobile club and the Chamber of Commerce having united their efforts to land the honor. The automobile club has already guaranteed the \$7,500 necessary, and a number of other cities have withdrawn in favor of the Forest City.

Cincinnati was one of the cities contesting for the honor, but withdrew to give Ohio, represented by Cleveland, a better chance.

The meeting place may have some effect upon the starting point of the 1909 Glidden tour, according to Chairman Hower, who has been in communication with interested parties in this city. If the Cleveland manufacturers send in their entries for the tour early enough, and the convention comes here, the chances will favor Cleveland, although both Detroit and Chicago are making strong bids for the honor.

PITTSBURGH A. C. ACTIVE IN GOOD ROADS WORK.

PITTSBURGH, Jan. 29.—At the invitation of the Automobile Club of Pittsburgh, D. Ward King, of Missouri, and the inventor of the famous King split-log drag, addressed a gathering of about three hundred at the old Monongahela House regarding the maintenance of dirt roads, this afternoon. Secretary Paul C. Wolff, of the club, had sent invitations to the road supervisors and selectmen throughout Allegheny County and to quite a few in the adjoining counties, and the response was most gratifying. William N. Murray, vice-president of the Automobile Club of Pittsburgh, presided in the absence of President Kneeland, others at the speaker's table being County Road Engineer George T. Bramsley and County Commissioners J. K. Campbell and Stephen J. Toole.

Mr. King earnestly impressed himself upon an audience, every member of which was an enthusiast for good roads, but not a few of whom doubted the efficacy of the King drag to help the dirt road.

"Dirt and water make mud any place in this country," said the speaker, "and you folks who can remember when you used horses, as I'm speaking for the Automobile Club of Pittsburgh now, must remember that you will never be through taking care of any kind of a road. I have never placed myself on record as stating that a dirt road cared for with the King drag would be as good as a macadamized road, but out of the 1,700 miles of road in Allegheny County, only about 400 are macadamized at present, so that you will have plenty of time to try out the King drag before they are all converted, and that is all I ask you to do; try it. I have seen many a macadamized road that was not in as good shape as a dirt road properly cared for."

Mr. King spoke for an hour, and a second hour was consumed in answering questions.

Secretary Wolff, of the Automobile Club of Pittsburgh, then reminded his hearers that the chief reason for calling the meeting was to renew the club's offer of \$300 in prizes for the best kept stretches of dirt road during the coming season, this amount being divided into a first prize of \$100, two of \$50, and four of \$25. Last year the club sent out a general letter to every road supervisor in Allegheny County," said Mr. Wolff, "and did not receive a single reply. A second letter to the same effect fared no better. Mr. King has asked you to try the drag and the Automobile Club of Pittsburgh not only asks you to do likewise, but will pay \$5 to every man who will build a King drag and use it but once."

County Road Engineer Bramsley then spoke, offering his services in aid of any of the road supervisors who wished to appeal to him. Anyone who was interested in the cause of good roads could find him at his office at any time, and he would be glad to extend every possible aid. Vice-President William N. Murray of the Automobile Club of Pittsburgh, then thanked the road supervisors for having attended in such large numbers, and a very cordial vote of thanks to the Automobile Club for having called the meeting was passed.

SAN FRANCISCO MOTOR CLUB.

SAN FRANCISCO, Cal., Feb. 1.—The runs and tours committee of the Automobile Dealers' Association has scheduled the first event for the automobile season of 1909. The event has taken the shape of a 200-mile endurance run to be held on February 7. The course is one familiar to every local motorist, being a double century around San Francisco Bay. A time limit of five and a half hours has been set by the committee after a careful examination of the roads had been made.

The San Francisco Motor Club will be asked to handle the event for the dealers, which makes the occasion notable, as this will be the initial bow of the club in such active capacity.



Vol. XX Thursday, February 4, 1909 No. 5

THE CLASS JOURNAL COMPANY

Thirty-ninth Street Building, 231-241 West 39th St. New York City

H. M. SWETLAND, President

EDITORIAL DEPARTMENT

A. G. BATCHELDER, Managing Editor; R. F. KELSEY, Associate Editor; C. B. HAYWARD, Engineering Editor; W. F. BRADLEY, Foreign Representative

BUSINESS DEPARTMENT

A. B. SWETLAND, Business Manager; LOUIS R. SMITH, FRANK B. BARNETT; W. I. RALPH, 1085 Old South Building, Boston, Mass.; C. H. GURNETT; F. W. VAN SICKLEN, 1200 Michigan Ave., Chicago, Ill.; H. H. GILL, Detroit, Mich.; T. B. VAN ALSTYNE, Philadelphia, Pa.

Cable Address - Autoland, New York; Long Distance Telephone - 2046 Bryant, New York

SUBSCRIPTION RATES:

United States and Mexico - One Year, \$2.00; Other Countries in Postal Union, including Canada - One Year, 5.00; To Subscribers—Do not send money by ordinary mail. Remit by Draft, Post-Office or Express Money Order, or Register your letter.

FOREIGN SUBSCRIPTION AGENTS:

ENGLAND:—W. H. Smith & Sons, Ltd., 186 Strand, London, W. C., and all their railroad bookstalls and agencies throughout Great Britain; also in Paris at 248 Rue de Rivoli. FRANCE:—L. Baudry de Saunier, offices of "Omnia," 20 Rue Duret, Avenue de la Grande Armee, Paris. GERMANY:—A. Seydel, Mohrenstrasse 9, Berlin.

Entered at New York, N. Y., as second-class matter. The Automobile is a consolidation of The Automobile (monthly) and the Motor Review (weekly), May, 1902, Dealer and Repairman (monthly), October, 1903 and the Automobile Magazine (monthly), July, 1907.

GROWTH AND STABILITY OF SLIDING GEARS.

Despite all attempts to do away with the sliding gear method of rendering automobile power plants flexible, it has grown and it has prospered. Besides doing the work in a manner quite up to a fitting standard, the sliding gear is proof positive of the fallibility of man, for in all truth no man living will be willing to say anything but that the sliding gear is based upon the most bungling theory of all; if, indeed, it has a theory of a positive character to back it up. The fact of the matter is the sliding gear seems to be the one way that is left, unless it would be more proper to say, it is the one way so far discovered by means of which motors are rendered flexible to a degree sufficient to serve for the purpose beyond the range of the planetary gearset.

True, in the classes of cars so designed as not to require a multiplicity of speed ratios, the planetary set seems to serve the purpose most adequately. When, however, it is necessary to afford more than two speeds ahead, it is the sliding gear that is used, and that it does serve the purpose to a vast extent is self-evident. This is in the face of innumerable predictions to the contrary, and it shows conclusively the fact that sturdy mechanics can make a successful fight.

So it has been all along the line, when reasons could not be evolved, necessities urged, and while there has been considerable work to do over again, it has not been

shown, as yet, that the sliding gear principle of transmitting power is included in the category of temporary expedients. It affords the requisite flexibility, and in view of the advances made in materials, especially in knowledge of the "treatment" which will accentuate the kinetic properties of them, the sliding gear principle has advanced to a seeming permanent place in automobiles, and, strange to relate, in the hearts of users as well.



PATRIOTIC WEST WAITING FOR CHICAGO SHOW.

In examples of patriotism pure and simple, the effete and erudite East is sadly lacking, but as one goes farther and farther West he finds increasing examples of it existing in all its pristine vigor. Along the Mississippi River the examples of it are to be found at every turn, taking as it does the form of local, or perhaps a better word would be sectional, patriotism. Thus the coming Chicago show will display something very much on this order, when thousands who could have attended the New York shows but refrained from so doing in order to further the cause of the national show with all the best features of the other two, will turn out. This rolled-into-one display is looked upon as the only real show. Thus, the inhabitants, with true local pride, stay away from the allurements of Broadway so as to be blown along Michigan avenue. These hustling Westerners will have their usual very good show, will sell a very large number of cars, generally transact a huge volume of business, and probably outdo all former exhibitions in point of attendance in the week intervening between February 6 and 13.



WHAT IS THE TRUE ANSWER?

According to the census of the Department of Agriculture the number of horses in the United States has increased enormously in the last few years, despite the wide use of automobiles. The statistics of the department show as follows:

Jan. 1, 1898: 13,960,911 horses, valued at \$478,362,407. Jan. 1, 1909: 20,640,000 horses valued at \$1,974,052,000.

The increase in value is in part due to the fact that the unit price was \$34.26, January 1, 1898, while the price per horse was figured on a basis of \$95.64, January 1, 1909. The fact remains that the number of horses increased some 7,000,000 in the interim of time. Why? When the automobile began to assert itself, in other words, when it was rendered apparent that the automobile was a practical device, capable of doing the work of goods transportation, the breeders of horses reduced holdings and the actual value of horseflesh fell to a low figure. It was then that the automobile enthusiast swelled out his chest and rent the air with his claims to the effect that animal transportation was bound to fall out of existence. The facts were not all in for the reason that the automobile industry proved incapable of turning out enough automobiles to handle the merchandise of the market, and with a widely growing trade it became necessary to fall back on horses to a vast extent. This year may make for an output to indicate that a considerable increase of the commercial business can be handled.

WHAT PROPOSED NEW JERSEY LAW CONTAINS

TRENTON, N. J., Feb. 2.—Interest centers in the Colgate automobile measure, which amends the present Frelinghuysen law by prescribing that all automobiles to travel in this State must have a plainly audible trumpet signal; must carry exhaust pipes directly parallel to the ground or turning slightly upward; the Commissioner of Motor Vehicles to receive all complaints for violation of the speed laws, the same to be in writing and verified; he must investigate them within 30 days from their receipt, and if in his judgment a case can be made out he can cause a warrant to be sworn out and placed in the hands of a Justice of the Peace for adjudication in the municipality where the alleged violation took place.

Non-residents of this State, when displaying their identification license numbers of other States, are to be allowed to tour in New Jersey for 10 days without taking out a New Jersey license within one year, when they pay a fee of \$1 to the State Commissioner of Motor Vehicles.

The measure forbids the use of a muffler cut-off in cities or towns or within 500 feet of any other vehicle. The speed limit in the open country is changed to 30 miles an hour and exempts drivers from penalties regarding maximum speed limit unless the excessive speed shall be proved to have been continued for at least one mile. Complaint may be made and proved before the State Commissioner of Motor Vehicles upon his conceiving that there be cause after investigation, and within 30 days shall cause the person to be apprehended in a summary manner before a Justice of the Peace or any committing Magistrate in the municipality where the law was violated.

A companion bill to this Colgate automobile regulator is a measure also introduced by him, compelling the placing of lights on all vehicles of any class using the highways from one hour before sundown to one hour after sunrise, this white light to show at least 250 feet. A penalty of \$10 is provided for failure to comply.

ONE SUIT AGAINST THE NEW JERSEY LAW.

The test case commenced last Summer by the touring board of The White Company to test the validity of the New Jersey automobile law, popularly known as the Frelinghuysen law, has now reached the Supreme Court of the State. Judge Reed of that court recently granted a writ of certiorari, thus permitting the case to be argued within the next few weeks. The case has been through the Police Court and the Court of Common Pleas, but neither of these courts undertook to pass upon the constitutional questions involved, but simply ruled on the facts of the case and the working of the statute.

It will be remembered that the case originated with the arrest of R. H. Johnston, in Trenton, because no New Jersey license number was displayed upon his machine. The principal contention of The White Company is that the State of New Jersey has no power to tax a non-resident citizen.

SAVANNAH MAY WANT TO HAVE ANOTHER.

SAVANNAH, Ga., Feb. 1.—The Savannah advertising fund will receive a sum of not less than \$12,500 from the receipts of the Grand Prize and international light car races.

The executive committee of the club held a meeting at the Chamber of Commerce, Friday night, and went over the bills that had been paid and ordered a great many more paid. Bills of all sort of expenses rained down for a time, and it looked as if the fund might be swept away, but finally the storm ceased when the figures had reached a sum a little above \$13,000, and there they stood when adjournment for the evening was taken.

The accounts showed that a little over \$19,000 was received from the sale of grandstand seats. The A. C. A. turned in from seat sales and entrance money, \$7,400; privileges netted \$2,049.65. The railroad sold seats aggregating \$3,000. The total receipts from all sources was not far from \$45,000.

CHICAGO OFFERS SPECIAL CUP FOR GLIDDEN

CHICAGO, Feb. 1.—Formal announcement has been made by the Chicago Motor Club that it has offered a trophy to the A. A. A., to go to the car making the best showing in the consumption of fuel in the annual Glidden tour, which offer has been accepted by Chairman Hower. That official has not as yet outlined his rules regarding the competition for this cup.

So far as the rules for this economy test go, they undoubtedly will be about the same as prevailed in the local 1,000-mile reliability last fall in which the Standard Oil Company trophy was put up and was won by Ray McNamara in a Premier roadster. This was decided under the formula originated by the Chicago Motor Club, in which the result is arrived at by dividing the weight of the car and load as expressed in pounds by the weight of the gasoline consumed in ounces.

SPACES ASSIGNED FOR NEWARK'S SHOW.

NEWARK, N. J., Feb. 1.—With the allotment of spaces for the second annual automobile show to be held in Roseville Armory, February 20 to 27, success is assured, for the present number of applications lack just four of filling all the available space, and



Essex Troop Armory Where Newark Show Will Be Held.

these, too, are of a very high grade. The show will be purely a Newark exhibit, every local concern being represented.

An elaborate musical program is being arranged. Sweet's orchestra has been engaged again this season, and this feature will be particularly attractive.

LATEST FROM NEW YORK LEGISLATIVE MILL.

ALBANY, N. Y., Feb. 3.—Assemblyman Marks, of New York, to-day introduced a bill which looks as though it came fresh from some insurance office, as it provides that every automobile owner on taking a license shall file with the secretary of State a \$10,000 insurance policy to pay all losses and damage claims arising from any one accident, without regard to questions of negligence or contributory negligence. It also provides for filing a similar policy of \$2,000 by chauffeurs to protect for damages to vehicles and for damages for which the owner becomes liable over \$10,000.

AUTOMOBILE ENGINEERS SELECT SECRETARY.

President Henry Hess, under direction of the council, has arranged with Alex. Churchward to become active secretary of the Society of Automobile Engineers. The society is to be congratulated upon securing a well-known engineer of such high standing in the profession to represent it in this capacity. The new secretary will assume the duties by March or April 1, to suit the convenience of the retiring secretary. The society expects to open a permanent office.



Testing Out an Inter-State Over Winter Roads.

TESTING OUT CARS OVER WINTER ROADS.

MUNCIE, Ind., Feb. 1.—In the process of testing cars every opportunity which will impose unusual and gruelling conditions upon the machine is always accepted with alacrity. For this reason the snow storm of last week was welcomed by the automobile manufacturers in this section as affording them additional chances of putting their cars through the hard work required by winter roads. The accompanying photograph is of an Inter-State car, with Chief Engineer Claude E. Cox at the wheel, Sales Manager D. W. Henry beside him, and Lawrence A. Hart in the rumble seat. This party covered the route from Indianapolis to Muncie, a distance of 57 miles, in 2 hours 28 minutes.

PACKARDS HAVE ROUND-THE-YEAR TRY-OUTS.

Winter testing forms a large part of the experimental work of the Packard Motor Car Co. The several experimental cars manufactured each season—a year or more in advance of the regular product—are driven many thousands of miles in hard overland trips by the executives of the company, as well as by Chief Engineer Huff and others. Recently when M. J. Budlong, president of the Packard Motor Car Co., New York, was at the Packard factory, he, in company with President H. B. Joy and S. D. Waldon, general manager, devoted considerable time to hill-climbing experiments on the steepest snow-covered grades in the vicinity of Detroit. These tests were accepted as convincing proof of the hill-climbing ability of a Packard "Thirty" and served to reinforce the tests and demonstrations made over the same hills in the summer time.

No change is made in the Packard car, say its makers, from one season to another until the new feature has been thoroughly tried out under all conditions of traveling and in both Summer and Winter weather. Thus, the construction contains nothing which has not had in actual road work harder and more trying service than it will ever be subjected to.

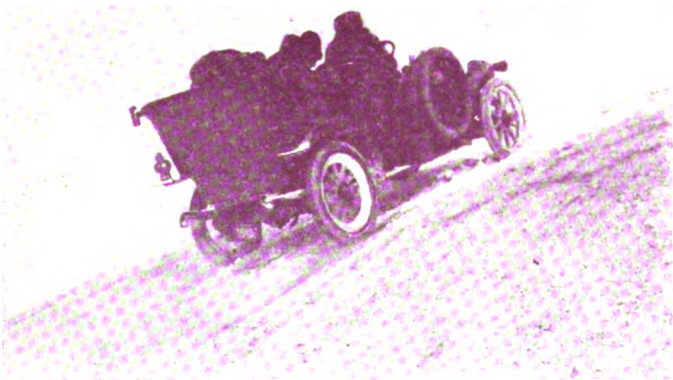

Busy Packardites: President Joy, Manager Waldon, M. J. Budlong.

AUTOMOBILE TYPE MILLING MACHINE.

ROCKFORD, ILL., Feb. 1.—The manufacturer has been more interested in machining processes and machines than the public, but now the latter is showing more interest on the assumption that if the machining processes are not right, the resulting product cannot be right, and inversely correct machine work makes a fine car. The automobile and its parts from the first have required many intricate parts which the ordinary machine tools would not handle. The great number of these special parts to be machined have given rise to the production of the milling machine shown in the accompanying illustration. This the manufacturers, the Ingersoll Milling Machine Company, call the Automobile Type Milling Machine. It is made particularly for milling engine bases and transmission cases for automobiles. It is not only adapted for this, but also for any other work which may be machined on a planer or milling machine. The three spindles have speeds varying from 15 to 120 r.p.m. These are arranged for face mills up to 10 inches in diameter on steel or cast iron, but for aluminum work larger cutters may be used. The machine has capacity of 26 in. horizontally and 24 in. vertically.

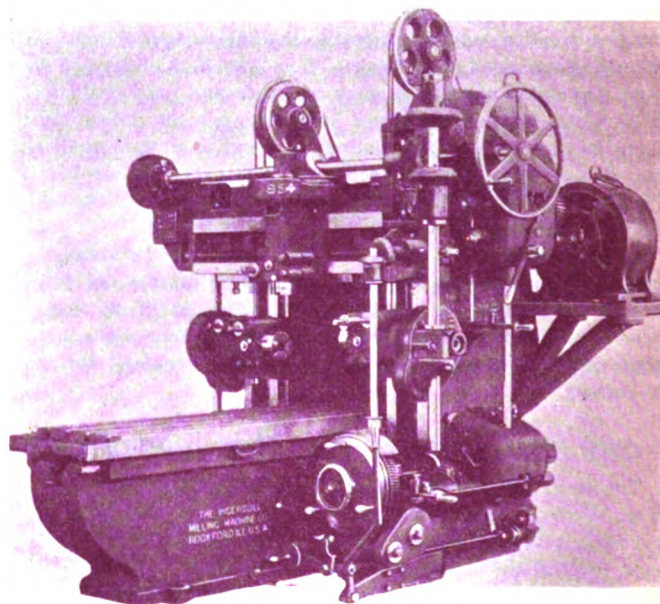

New Automobile Type of Milling Machine.

The motor equipment consists of a 15-horsepower d.c. shunt wound Westinghouse type S motor, which is mounted in the rear of the machine, where it takes up little space and does not interfere with the work nor the operator. The speed changes from 875 to 1,500 r.p.m., are effected by variations in the shunt field by means of a Westinghouse drum type controller, not shown. In addition to this range of speed there are four changes by mechanical means, enabling the cutting speed required by the work to be obtained with exactness and with certainty.

TAFT WILL HAVE HIS AUTO AFTER ALL.

WASHINGTON, D. C., Feb. 2.—After the prolonged Senate debate of the previous week, which resulted in the elimination of the \$12,000 automobile appropriation from the Urgent Deficiency bill, commented upon in these columns, the House to-day made short work of this same item. A very short and spirited debate resulted in an overwhelming vote in favor of insisting upon the retention of this provision in the bill. The vote of 185 to 27 showed very clearly the favorable sentiment, which one representative expressed very well when he said in part: "If it would conduce to the comfort, happiness, and well being of the chief executive, the money would be well expended, not only every four months, but every month in the year." In connection with the Senate's previous opposition, it is notable that the stable appropriation of \$35,000 will be at Mr. Taft's disposal to purchase automobiles if he sees fit, even if the Senate refuses to pass the item.

WRIGHT TRIUMPH IN EUROPE IS COMPLETE

PARIS, Jan. 27.—At a reserved table in the dining hall of the Automobile Club of France five men were united for lunch. It was a private gathering, entirely without ceremony, but one of more than ordinary importance, as was evident from the attention given to it by the maitre d'hotel and the deference of the usually impassible yellow-breeched waiters. The French "Tire King" presided, the position to the right of M. André Michelin being occupied by Wilbur Wright, now "King of the Air," and that to the left by Orville Wright, recently arrived from Dayton. The two remaining seats were filled by Hart O. Berg, European manager of the Wright brothers, and by M. Clauss. When the dessert was served M. Michelin brought forth his surprise in the form of twenty crisp bank notes of one thousand francs each and handed them over to Wilbur Wright, with the remark that he had paid the first portion of his debt for the magnificent performance at Le Mans on the last day of the old year, and hoped to present the work of art very shortly.

Before expressing thanks Wilbur Wright counted out ten of the notes and handed them over to his brother without a word; the two were engaged in the same task, and a victory for the one was a victory for the other.

For seven successive years M. Michelin has engaged himself to hand over a similar amount to the aeronaut fulfilling conditions laid down by an independent committee. The first sum has been won with such a lead on the minimum distance imposed that the donator had reason to suspect that his \$20,000 for a flight from Paris to Clermont-Ferrand would not be allowed to lie in the bank for very long. Wilbur Wright assured him, however, that he would not attempt to win the big prize this year.

"Although we have covered more than half the distance from Paris to Clermont-Ferrand," said he, "there are so many difficulties on this trip that I do not think anybody will attempt it this year. It is not the distance that is the greatest difficulty, for with suitable training it is possible to fly almost any distance; the difficulty is that to reach your city it will be necessary to pass over very varied country, descending into valleys, then mounting to great altitudes, thus meeting with varying currents and wind from every quarter. The ideal for an aviator is to fly in a constant breeze, and to approximate this ideal it will doubtless be necessary to make considerable detours to reach Clermont-Ferrand. Then it will be a difficult matter to climb the sides of the Puy de Dome, the summit of which is nearly 5,000 feet above the sea level; the plan that suggests itself is to keep near the face



of the mountain and climb as a bird of prey does, but even this is not an easy matter."

The Wright brothers' triumph is complete in Europe, for in addition to winning the most important prizes of the year, they have now enrolled one of their formerly important rivals as a pupil. Leon Delagrangé, at one time record man of Europe, has decided to buy a Wright machine, and will take lessons from Wilbur Wright during his stay at Pau. Henry Farman, too, in view of his repeated failures, or only partial successes, has sold his Voisin Frères machine and will make a fresh start with an aeroplane built according to his own ideas.

Wilbur Wright has left Paris for Pau, in the Pyrenees, and will be joined by his brother Orville and his sister, Miss Katherine Wright, in a few days. The next item in their program is the training of the three pupils required under the Lazare Weiller conditions. This work will be undertaken by Wilbur, while Orville will rest and endeavor to recover complete strength under the genial climate of the Franco-Spanish borderland. Six aeroplanes have to be built for the committee, and it is Orville Wright who will supervise the construction. By the end of March or early in April it is believed that all will be finished and the entire party will leave France for America.

An extension of time has been granted by the United States Army Department for the fulfillment of the contract that Orville Wright was engaged in when the unfortunate accident last September laid him low.

In conversation with THE AUTOMOBILE representative, Orville Wright declared that he had full hopes of being able himself to carry out the program. "The doctor did not think I should be able to fly again before the middle of the Summer, but at the rate I am progressing I have every hope of handling a machine at Fort Meyer before the month of June. The conditions are difficult, comprising a speed test of five miles out and five miles home and an endurance test of one hour at a speed of not less than forty miles an hour, each one to be made with a passenger on board. The short speed test is an exceptionally difficult one, for we have to fly over the rough, hilly ground around Fort Meyer, where variations in the direction and force of the wind are frequent. I have such confidence in the machine as to believe that we shall succeed."

Aeronautical conditions are becoming better in every way in Europe, where the scepticism of the earlier time is not now much of a factor, and there is no denying the fact that success depends upon the attitude of all who may influence the situation.

CHATEAULAND NOW WANTS AEROPLANE MEET.

PARIS, Jan. 27.—Anjou, robbed of its Automobile Grand Prix, has abandoned all idea of running a race itself, and will seek fame in the organization of a large aeronautical competition. The subscriptions obtained toward the 100,000 francs subvention for the Automobile Club of France will be returned in their integrity, the French club being asked to meet the expenses incurred in obtaining the money and in preparing for the defunct race. One village on the projected course is so vexed at the loss of the race that it has put in a claim for an indemnity that will doubtless not be forthcoming.

The aeronautical program is at present in an embryo condition, but doubtless the manifestation will develop into an aeroplane race from Angers to Saumur and return, a spherical balloon competition and a demonstration by dirigible balloons. The dates chosen are the last week in September of the present year. The Aero Club of France will associate itself with the district in the organization of the meeting.

WHAT THE AERONAUTICAL FEDERATION DID.

LONDON, Jan. 27.—A prize of \$240,000 for aviation and dirigible balloons has been founded by the International Aeronautical Federation in its meeting here. A gold cup of the value of \$10,000 will be awarded to an aeroplane; money prizes of \$20,000 each will be given to dirigible balloons and flying machines, and a \$10,000 cup will be awarded in each section. The ten prizes of \$20,000 each are to be competed for at intervals of five years. In addition, the sum of \$20,000 will be devoted to the construction of sheds for the competitors in these events. It is suggested that the United States, Germany, Great Britain and France should each contribute \$40,000, Belgium, Spain, Italy and Austria each contributing \$20,000.

Rules have been decided upon for the Gordon Bennett aeroplane race to be held in France this year. The race will take place around a fixed course five to ten kilometers in circumference, the minimum distance traveled to be officially recognized, being fixed at twenty kilometers. Stops may be made during

the progress of the race, the competitors to start off again under their own power and without outside assistance, the winner being the one making the fastest time. The race must take place at a fixed date and at a fixed time.

With reference to the recent friction between the Aero Club of France and the Automobile Club of France, the following proposal by Roger Wallace, on behalf of America, was carried: "The International Federation decides that any affiliated aeronautical club is free to act in its own country and can enter into any arrangement with another organization, but only on condition that it maintains in all its integrity the fundamental statutes of the federation." The situation will be watched with a good deal of interest, and that this, like every other problem, will be solved in a fitting manner, is fully anticipated.

THIS, THE CONGRESS OF A GREAT COUNTRY.

WASHINGTON, Feb. 2.—Having adopted an amendment to the army bill last Saturday, carrying \$500,000 for airships of various types, the House to-day reversed its action and by a vote of 161 to 90 defeated the amendment. The vote on Saturday was in the Committee of the Whole House and the reporting of the bill for final passage to the House itself to-day gave Mr. Tawney his opportunity for renewing his opposition to the measure. There was no debate. Mr. Tawney simply asked that the amendment at issue be voted on separately and the overwhelming vote was taken.

The only hope for the airships now is that the Senate may restore the appropriation and insist upon its amendment in conference. But that is extremely unlikely.

FRANCE MAY HAVE OUTLINED TOO GREAT A TASK

PARIS, Jan. 27.—In her enthusiasm for flying, and eagerness to secure first position in the aeronautical world, France has mapped out for herself a program which is going to lead her into difficulties. The year 1909 is to be given up to flying; aeroplane races are to be so numerous and so exciting that there will be no need whatever to hold automobile speed tests. Monaco has to set the ball rolling with a carnival calling for flights across the blue waters of the Mediterranean, rewarded by cash prizes of \$20,000. The Aero Club of France, the Automobile Club of France, the Anjou District, and a host of others are to have speed tests for machines that navigate the air. The time for action has arrived, and France has awakened to the fact that she has set herself a task she is by no means able to accomplish.

For the soar across Monaco Bay there are nine entries of as many magnificent machines, produced with much scientific skill and lacking in nothing but the ability to fly. The list is headed with three Antoinettes, masterpieces of fine workmanship, which up to the present have only accomplished a couple of miles in the air between them. Breguet has a biplane and a gyroplane, which may have flown, but if so no one but the pilot ever witnessed the performance; Baron de Caters has a Voisin biplane which on one occasion rose from the earth, and Georges Vuitton has a helicoptere which has not yet peered forth into the light of day. Leon Delagrangé is the only aeronaut in the group having a past that would entitle one to believe him capable of fulfilling the Monaco programme. He has put in two machines, one of which he will handle himself, the other being in charge of an assistant still in his apprenticeship. Even Delagrangé will have to make a much more brilliant showing than ever before, his best flight up to the present being 10 1-2 miles, while the Monaco event calls for three flights of over six miles each, starting from a given point, rounding a windy promontory, and returning to the same given point. Quite an undertaking.

Henry Farman, the champion of the French school, has tem-

porarily retired from the fray. A few days ago he sold his Voisin biplane which he had himself transformed into a triplane, and has now taken up the ungrateful task of teaching his constructor how to build an aeroplane. As the constructor is convinced that his machine ought to fly, and Farman believes that he has learned enough during his eighteen months' apprenticeship to build an aeroplane, there is a deadlock, the outcome of which is not easy to foresee.

The only other men who have done more than scutter over the ground are Louis Bleriot and Robert Esnault-Pelterie. The former has produced two new "racers," which might fly if their wheels would stand up long enough to allow them to get into the air. Esnault-Pelterie has shown an ability to fly, but at such widely spaced intervals that he cannot be relied on for a race at a fixed date, assuming he can make good at all.

The failure of the French school makes the American triumph still more striking, for the fact cannot be denied that the only really successful machine at present in existence in France is that owned by Wilbur Wright at Pau. More Wright machines are under construction, and pupils are being trained, so that there is a possibility that the prizes which might otherwise have to remain without winners will be carried off in triumph. The race at Monaco, however, is likely to remain a blank, for Wright is somewhat opposed to taking part in anything of even a slightly sensational nature, and is further so anxious to return to the States that it is doubtful if he could race were the conditions such as suited him.

Before the end of the year there may be a score of Wright machines in commission in France, and if, as the inventor declares, it is not an acrobatic feat to handle them, some of the cash prizes that France has so lavishly created may have to be handed over. It will be a sorry day, however, if 1909, the triumphal year of the aeroplane, is only conspicuous for the success of an American production.



First Appearance of the Smaller Bleriot Monoplane, Fitted with Antoinette Motor, Which Successfully Flew January 20.

ROUGHING IT A LA MOTOR, AWAY FROM ROADS

By MONTGOMERY HALLOWELL.

ARE you one of those blasé old autoists? Have you used up every charming stretch of road within the week-end radius of your town? Have you exhausted all the thrills that the first two or three years of automobile ownership kept shooting into your system? Are you in that just-waiting mood—wondering whether the next new thing to interest you will be anything short of an airship?

Well, here's a new one that will revive every old joy of your early days of autoing.

"Roughing it"—that's the answer.

Seven of us: Major Foster, Page, Fitch, Ayres, Chalmers, Dowling, and myself were at duncheon. I don't know how it started, but before the coffee got to us we had begun to tell hunting yarns. And every man in the party began to feel that crazy longing that no city-bound, asphalt-weary, business-burdened working man ought to feel until vacation time—that longing for the woods and the wild things of nature. The Major was the inspired human being who sprang the idea.

"Getting there and getting back is what kills hunting for us chaps." Page had just said "Here it is Friday noon. From now till Monday morning we could all be out shooting except for one thing—there wouldn't be any shooting. It would be all traveling—out and back again."

The Major carefully put away what was left of his coffee and as carefully set down the cup. He didn't seem to have a thing on his mind.

"Well," he said, casually, "you know," just as if it were nothing at all, "we might do the trick with a car."

The next five minutes developed a lot of things. The Major knew a place somewhere back of Lakewood, where, by starting that night and allowing six hours for sleep, we could be on the birds early the next morning. Fitch suggested making it a camping trip and offered to supply a complete auto camping equipment from tents, air mattresses, sleeping bags and folding stove down to teaspoons with food and every other accessory, all to be so completely folded and stowed as to leave all seats free to carry us with three guests and a guide. Page came to the front with a Chalmers "Forty" and a Chalmers-Detroit "Thirty."

"We'll sleep to-night," said the Major, "at a little place I know, about a hundred and fifty miles from here. I'll 'phone for midnight lunch and beds for nine, also for a guide and dogs. I hope those cars are all right, Page. They'll need to be. And Fitch, be sure to have a couple of axes. We may have to chop down some trees to get the cars through."

This sounded good to me—only I was glad they weren't my cars. Ten of us left Columbus Circle at 8 o'clock. At 1 o'clock we were at the little hotel, an hour beyond Lakewood. I'd like to tell about the fun of that run. But it was just a case of good roads, good cars, a beautiful night and speed.

Next morning the real fun started. With Captain Jenks, our guide in the leading car, it took those blessed cars just fifteen minutes to land us in the very heart of the bird country. Over

deep sandy roads and through the timber—the cars never turned a hair. To have walked it would have taken an hour. Who says that motoring isn't the real way for busy folks to go a hunting? We had only two days and the cars were saving every minute for us for sport.

Then came another novelty to some of us—Fitch's camping layout. To see the Major and Fitch and Dowling transform the rolls of plunder that had been strapped to the running boards into a complete camp in less than ten minutes was better than any mere fire drill I ever saw. Nothing needed to live, move and have your being out of doors was missing; and everything was made to fit into everything else so that not an inch of space was lost in packing.

I started out to tell about "roughing it" and not about the shooting itself; but right here I want to remark that, when it comes to birds, that strip of Jersey woods is good enough for me. When we got back to camp at noon not one of us had had less than a dozen shots.

And that noon-day meal. How Broadway would have stared at it and the way it disappeared.

Another lightning transformation act that would make a hit at Hammerstein's ended in getting every part and parcel of that camping outfit on the cars inside of fifteen minutes and we were off for another kind of shooting.

"I guess this is bad," said Page. "Two kinds of shooting the same day. Major, I would sooner be the father of this new idea of yours than the

winner of the Vanderbilt Cup." Our new destination was to be a certain inlet the Captain knew of on Barnegat Bay where he guaranteed us some good salt water duck shooting. By road it was a two-hour run. But the Captain knew some short cuts. We didn't save much time, but we got the sensations.

For a couple of miles we just wound around, picking our way through the woods with no road in sight. Talk about walking on eggs! That's nothing. Just try a ride in an expensive car through the trackless woods with an eight-inch fall of leaves hiding the holes and stumps. Once the "Forty," which was in the lead, got tight up against it, and, sure enough, the Major's prediction about the axes proved right. Before the car could make a get-away, the Captain had to chop down a couple of six-inch trees.

At the edge of the woods we struck a ploughed field and we began to wish the Captain had given us plans and specifications of his boasted "short cuts." However, the cars didn't seem to mind and finally we came out on a road. It was a welcome sight too—even if it was deep sand. Page knew what his cars would do to that sand, so he threw on the clutch for a little speed.

The sand didn't last long and, for a wonder, we struck a piece of ordinarily good country road. The "Thirty" was loaded almost pound for pound with the "Forty," and when Page opened up on his fourth speed I looked back to see the "Thirty" fade away. But, apparently to the surprise of even Page himself, the



Autoists in Camp in the Woods of Southern New Jersey.

smaller car kept in sight all the way. After a fairly stiff climb of about a mile, we struck the decline leading down to the beach, and, after another couple of miles through the woods, we halted at a spot that the Captain had chosen for our camp-sight for the night.

The short winter afternoon was not yet nearly over and we were in plenty of time to pitch camp and spread out around the inlet before the ducks would be coming in.

For a couple of miles we were strung out along the edges and indentations of the little bay. And pretty soon the guns began to "Bang," "Bang" all over the place. The birds were coming in thick. Everybody was busy and the dogs were beside themselves.

Why—will some one tell me—why stick in the city and vainly wish for sport when it is as easy to have as this?

We had invented a way to crowd a month's vacation into forty-eight hours; but even we couldn't keep it from getting dark and soon the fun had to stop. But after all, which is the more fun—the shooting or the pipe and the talk and the loaf around the camp fire after the day's sport is done?

We found the shore too cold, and again we thanked our lucky stars for the lightning-like camp equipment and the cars. For in less than forty minutes we had picked up our traps and established ourselves again three miles back in the woods.

How good that hunter's supper was! And how unbelievable it seemed as we sat around the fire in the evening, to think that the evening before we had been in the city and that the evening following would find us back in our civilized togs, on asphalt again! How we slept that night! How we hated to crawl out of the warm sleeping bags Sunday morning—even to eat another of those wonderful out-of-door meals! And how we hated to break camp!

But we knew we could do it again—and then again. That was the compensating thought. For we had discovered and demonstrated a new idea—the tabloid outing for busy sportsmen.

The Major, Page, and Fitch were our heroes. The car and the automobile camp equipment had made it all possible.

Below is a list of the stuff Fitch furnished, barring the guns. It is every conceivable thing needed for eleven men for three full days, and all packed to leave room to spare on the cars. The total weight, including food was 203 pounds, the total cost \$135.00.

Article.	Weights.	Price.
2 automobile tents.....	18¾ lbs.	\$24.70
2 dozen 12-in. steel tent pins, per doz.....	4¼ lbs.	.85
2 tubular steel telescopic tent poles.....	3½ lbs.	2.50
8 Fitch sleeping bags, Style "A".....	21 lbs.	30.00
8 No. 1 air beds.....	9 lbs.	
2 three-quarter axes and sheaths.....	3¼ lbs.	2.00
1 No. 8 aluminum cooking outfit for 8 people in leatheroid case, with all accessories.....	15 lbs.	32.75
1 large folding aluminum baker, with pan, bread board, canvas case and two broilers	8 lbs.	7.50
1 folding grate with canvas bag.....	3½ lbs.	2.40
4 No. 3 chairs.....	4½ lbs.	1.50
4 steel folding stools.....	2½ lbs.	.75
2 folding aluminum lanterns.....	7 ozs.	2.00
4 folding wash basins.....	7 ozs.	.85
2 folding pails.....	8 ozs.	.85
2 shot guns and 2 rifles in each car.....		discretionary
2 fishing rods, with reels, lines, hooks, flies, etc.		discretionary
2 folding tables.....	16 lbs.	2.50
1 toilet tent.....	6 lbs.	3.75
2 wall pockets.....	1½ lbs.	2.50
1 No. 2 refrigerator basket.....	9 lbs.	4.00
1 folding safety saw.....	4 ozs.	1.00
2 military night marching compasses on each car.....	7 ozs.	11.25
1 No. 1 medicine case.....	21 ozs.	3.50
1 hypodermic syringe.....	3 ozs.	1.75

All of the above articles were packed in brown waterproof bags, with handles on bottom and sides. In addition to this, foods as per food list below for eight people for one week, packed in brown waterproof nine-inch bag, price, \$125 (each).

	Lbs.		Lbs.
Flour.....	24	Rice.....	6
Corn meal.....	10	Jullenne.....	1
Beans.....	6	Soup tablets.....	½
Erbswurst.....	¾	Evaporated apples.....	2
Bouillon capsules.....	1	Evaporated apricots.....	2
Lentils.....	2	Salt.....	1
Sugar.....	9	Chocolate.....	1
R. baking powder.....	1	Tea.....	1
Coffee.....	2	Bacon.....	6
Butter.....	6	Dried potatoes.....	4
Pork.....	10	Shelled nuts.....	1
Shredded codfish.....	1	Dried eggs.....	1¼
Peerless evaporated milk.....	5	Dried onions.....	¼
Total.....			106¼
		Pepper, spice, mustard—shaker full.	

IN A TOUR FROM SYRACUSE, N. Y., TO PAWNEE, NEB.

WHERE the northwest corner of Pennsylvania reaches out from the rest of the State to touch Lake Erie is a region that the automobile tourist dreads. It is a strip not over 40 miles across, but it is wide enough to cause trouble to the east or west-bound automobilist who attempts to cross it without a Pennsylvania license. To avoid it one would have to make a wide detour around Lake Erie and through Canada.

Just what the Pennsylvania proposition is is explained by George Johnson, of Pawnee, Neb., who, with a party in two Franklin touring cars, recently made a trip of 1,516 miles from Syracuse, N. Y., to his home. He says:

"While in Syracuse we made some inquiries about the routes, and were informed that the law in Pennsylvania was very stringent and that no foreign license would be recognized. Some said that they would not molest autos passing over the State road along the lake, but one man who had made the trip without a Pennsylvania license was held up and fined. The experience cost him \$26. We thought best to pay the State the \$3 tribute money, and we remitted to Harrisburg and had our license sent to Dunkirk, and subsequently we passed over the Pennsylvania roads without being molested."

Mr. Johnson and O. H. Schenck, of Pawnee, had just purchased the automobiles and had gone to the Franklin factory in Syracuse to drive them home. On the 1,500-mile run west they made stops at Geneva, Batavia, Buffalo, Niagara Falls and Fredonia, thence running along the route of the Lake Shore & Michigan Southern Railroad to Willoughby, and then stopping at the cities of Cleveland, Sandusky, Toledo, Swanton, Hammond and Chicago.

Although the run was made without trouble of any sort except one tire puncture, bad roads were encountered in places. "After two days in Chicago," says Mr. Johnson, "we resumed our journey, putting up at La Salle the first night out. Just out of La Salle we encountered exceptionally bad roads. Rain had recently fallen, and the further we went the heavier the roads got. At Rock River we were held up for the ferry."

At Moline the party separated, Mr. Schenck taking his car through by way of Washington, Ia., there to be rejoined by the others in Mr. Johnson's automobile, who had come by way of Rock Island and Muscatine. The reunited party continued by way of Ottumwa.

"While I have always had a pretty good opinion of Iowa and Iowa people," says Mr. Johnson, "I still have the same opinion of Iowa roads; but Iowa roads, especially a strip of 100 miles out of Ottumwa, are about the worst I ever encountered. We felt somewhat relieved on reaching Nebraska City, Neb., for we knew the roads were fair from there to our journey's end"

While the jokesmiths continue to make the farmer the automobilist's foe, these tourists found him quite the contrary. "I wish to say right here that we were royally treated by the farmers along the route, and we certainly appreciated their many kindnesses," is the tribute paid by Mr. Johnson.

Austria intends setting all other nations a good example with the erection of an automobile senate at its higher courts, which is to deal with all legal questions of liability and recompense. This innovation is made by the Ministry of Justice at the instigation of the Austrian A. A.

MITCHELL THE SURVIVOR IN NEW ENGLAND TEST

HARTFORD, CONN., Jan. 28.—A 20-horsepower, four-cylinder Mitchell runabout was the sole survivor in the 156-mile endurance contest from Hartford to Pittsfield and return by way of Springfield, to-day. The time of the Mitchell was 11 hours 52 minutes, and it is estimated that at least 20 miles more than the course described were covered, so that this time is virtually for 170 miles of running. The contest was the outcome of a challenge issued by R. D. & C. O. Britton, local Maxwell agents, to all cars selling at \$1,000 or less.

There were five starters at five-minute intervals; two Mitchells, two Maxwells and one high-wheeled Holsman.

Accidents were numerous from the very start. Smith and his mechanic in No. 1 Mitchell nearly came to grief almost in sight of the start. The passage up Avon mountain was a bit tortuous and necessitated skill in driving. In the vicinity of Canton the Mitchell collided with a telegraph pole, and for a time it looked as if the car was completely out of the running. The mechanic, who had been sitting on the running board, was pounded more or less, but was game and stuck to it. The left steering pivot was badly bent, so much so that the spokes of the wheel barely cleared it. With the wheel badly dished the entire trip was made. The second Mitchell followed the wrong road, and once upon it, in a desire to make up time, halted at a tree and smashed a wheel, which put it out of the contest.

The two Maxwells encountered trouble shortly after the start. The car driven by King stripped a driving pinion and was towed back to Hartford and a new member installed. Later, however, it again came to grief and gave up the contest. The Maxwell was running in hard luck. Macdonald in the other Maxwell was giving a good account of himself when Pine Meadow was reached, and here again the hand of fate was heavy. The car stripped a driving pinion and a complete new rear axle was hurried out from Hartford and again Macdonald started out for the goal. In North Becket, however, the car skidded against a stone wall and a wheel was smashed. The crew spent the night at a farmhouse. A new wheel was shipped.

A high-wheeled Holsman seemed to have the least trouble of all the cars entered. It had a difficult time negotiating Avon mountain in the snow and ice, and as the car was equipped with but improvised chain grips going was tedious. It made a consistent showing until almost into Pittsfield, when a timer gear failed and put it completely out of business.

Smith in the first Mitchell had the lead and held it. Enthusiastic testers, eager to render what help was possible in breaking roads, were humming along nicely. One of them collided with a bridge in Sheffield, and the car was completely wrecked. Smith in the Mitchell almost lost heart as the minutes passed by, and finally when it became apparent that the wrecked tester owned the bridge he took a roundabout route.

From this point on the contest is simply a narration of indomitable nerve on the part of Smith and his mechanic (who was kept up by stimulants) and Mitchell survival. Pittsfield was duly reached after some hard going. The winning crew was dined by the Hotel Wendell, and the house doctor looked over the mechanic, badly shaken up but otherwise all right.

Jacob's Ladder still lay before the winners. Smith was prevailed upon to give up the idea of climbing the noted rise, but could not be argued with. Smith endeavored to secure the services of a guide for the trip over the "Ladder," but the day was cold and the natives did not take seriously to offers of reward. Snow shovels were secured and the car was off. The entire run up the "Ladder" was made on the low gear. The radiator was kept cool with snow when water was not to be had, and time and again it boiled out. The engine, however, worked beautifully. At the top of the "Ladder" the wheels were wound with heavy rope for the descent. It was made without special incident. The run in from Chester to Westfield was hard going,

and snowdrifts had to be eliminated. From this point on the journey, compared with what had already been encountered, was not so hard, though some of it was over the trolley tracks.

The winning Mitchell crew was given a good scare when Springfield was reached. Safe in the assurance, from inquiries along the way, that no other car had passed, the party stopped for a brief respite. The cars from Hartford had run up to escort the winner home, and as Smith got into his car along came King in the little Maxwell. "Where did you come from?" asked Smith. "Just got in," replied King. Needless to say Smith did some tall speculating as to how quick he could get away from King and reach Hartford first, but King then told the real story, and the Mitchell came over the road homeward at a leisurely



Mitchell 28-H.P. Runabout, Winner of Endurance Run.

pace, reaching Hartford at 6:52, after having run 11 hours 52 minutes. The contest was nothing if not noteworthy.

Two trophies were offered for the contest: a handsome silver loving cup from the Hartford Times to the winning car and a copper and pewter loving cup donated by the Post & Lester Company for the car making the nearest best time to eight hours. Mitchell, of course, won them both. All the cars entered except the Holsman were equipped with Hartford tires. Despite the ice and snow and extraordinary rough roads not a single case of tire trouble was reported. The Buick was withdrawn from the contest the night before the start.

A. R. MILLER TO REPRESENT SIMMS IN AMERICA.

Frederick R. Simms, co-inventor and patentee of the Simms system of magneto ignition, recently arrived in this country for the purpose of appointing an American representative of the Simms Magneto Company, Ltd., and also establishing business relations with leading American automobile makers. Mr. Simms has arranged with A. R. Miller to be the American representative in charge of a branch to be located in New York City. Mr. Simms will be remembered as a founder and the first vice-chairman of the Royal Automobile Club of Great Britain and Ireland, and again a founder and the first vice-president of the Society of Motor Manufacturers and Traders. It is not improbable that the noted Britisher will be a visitor at the Chicago show.

TRADE CONDITIONS IN MEXICO CITY.

DAYTON, O., Feb. 1.—Sigmund Krausz, representing the Dayton Motor Car Company, recently returned from Mexico, where he established a Stoddard-Dayton agency. Regarding Mexico City, Mr. Krausz found Mexican dealers in general make the mistake of handling too many makes, thus considerably lessening the chances for the success of any one car. The Stoddard-Dayton



Stoddard-Dayton on Typical Roadway of Back Street in Mexican Hill Town.

agency established in Mexico City will, however, handle exclusively the product of the Dayton Motor Car Company. One of the largest garages is to be secured, and some new features introduced in the remodeling of the quarters, especially in the housing of the customers' cars.

Federico Vedegaray, the newly appointed agent, will have associated with him some men well known among the Mexican motoring public, and an experienced man from the factory will look after the mechanical end of the business.

Mr. Krausz thinks the Mexican capital an ideal automobile town, as far as roads in the city and environs and general police regulations are concerned, and he is convinced that American cars, in spite of the existing prejudice in favor of the French, Italian and German machines, are steadily gaining ground there. He made many trips around Mexico City with interested autoists and the way his Models 9-F and 9-A performed over the hardest roads created a favorable impression.

AUTO EVERY 12 SECONDS.

NEW YORK CITY, Feb. 1.—Claims have long been made that New York is one of the world's greatest automobile centers, and to substantiate this a test was made last Saturday afternoon at the corner of Fifty-seventh street and Broadway. Beginning at 3 o'clock, note was made of every vehicle that passed the corner in question in both directions for the ensuing half hour. In that time, 353 cars are said to have passed up and down "Automobile Row," or an average of an auto for every 12 seconds, while but 75 horse-drawn vehicles passed there during the same period. Conditions were unfavorable for traffic of any kind.

MR. AND MRS. HOVER ARE UNDAUNTED.

NEW YORK, Feb. 3.—Unlike many of the other passengers on the ill-fated *Republic*, which went down off Nantucket before having made more than a few hundred miles on her trip across the Atlantic, Mr. and Mrs. Hover, of Spokane, Wash., who were starting the first European leg of their round-the-world trip in a Maxwell, are not discouraged by this unpleasant occurrence such a short distance from the start, and are making another try at it to-day on the *Adriatic*. The latter vessel is another White Star liner, but is bound for Southampton, from which point the Hovers will go directly to the Riviera, stopping at Nice. This will mean the postponement of the Algerian part of the trip, the change having been made owing to Mrs. Hover's ill-health and the lateness of the season. Mr. Hover's plans were more or less dependent upon his wife's recovery; but he will probably make a start on the Continent first, instead of going to Africa.

Current report had it that the Maxwell touring car in which the Hovers crossed the American continent from Spokane, Wash., to New York, and in which they intended to continue the remainder of their trip round the world, had gone down with the *Republic*. A little investigation proved this to be erroneous, Colonel Pardee, of the local Maxwell-Briscoe branch, being under the impression that the car had not been shipped at all as yet, and that it was still in New York. This was not in exact accord with the facts of the case either, as events proved, for the occasion on which Mr. and Mrs. Hover were photographed in the machine, as shown by the accompanying illustration, was the last in which it appeared in this country. That was a day or two preceding their departure on the *Republic*, and the Maxwell in its crate went out on an Italian freighter, bound for the Mediterranean, less than 24 hours before the unfortunate White Star liner set sail, so that it is now awaiting their arrival at the custom house of some Italian port, instead of being in the hold of a steamer 200 feet or more under water, as has been generally supposed. The losses suffered were confined to their personal effects.



Mr. and Mrs. H. A. Hover in Their Maxwell Prior to Sailing on the "Republic."



How One Santa Claus Adopted Up-to-Date Methods.

M. R. Hutchinson, inventor among other things of the Klaxon warning signal, lives in Summit, N. J. The electrical engineer of his organization, Jonathan Haralson, on Christmas Eve essayed successfully the role of a modern Santa Claus, utilizing Mr. Hutchinson's automobile in the distribution of a tonneau full of scientific toys which might be expected from the laboratory of an inventor. While the innovation shattered the reindeer story quite completely, the youngsters seemed to be as well satisfied with the up-to-date methods of "Old Nick." He covered his rounds much more quickly than with the old reindeer-drawn vehicle.

Proof of Interest in Pierce Arrows.—

In this day of new and novel ideas a brand new one has been sprung recently in connection with the automobile shows. The idea of finding the indications of public interest in the cars took many forms, but the latest consists of looking for footprints, so to speak. As soon as 11 o'clock struck at the close of the recent Madison Square Garden show exhibitors began to move and the heavy burlap carpeting was bared. Then it was possible to gain some idea of the numbers that had visited the spaces of the various manufacturers. Some of the carpets showed scarcely any wear, while at others the wear was very noticeable. This was particularly true at the space occupied by the Pierce Arrow cars, where the carpet was worn through at seven places, four of them being about the door of Louis XVI suburban car. Every seam had been ripped by the thousands who had passed about the exhibit. This fact caused so much comment that an examination was made of other exhibits, and it was found that in no other space in the Garden had the carpet been worn through, although in three others some of the seams had been parted.

New and Larger Production Estimate.—It is a well-known fact, almost a truism, that motor car manufacturers never buy any more tires than are absolutely necessary for their season's output. Looked at in this light, the compiled figures of the tire contracts already placed allow of a newer, yet conservative, estimate of the year's production. Basing his prediction upon the number of tires actually contracted for by the various automobile manufacturers throughout the country, F. S. Firestone, the well-known tire manufacturer, estimates the 1909 automobile production at 72,500 cars. "The effect of this enormous production," added Mr. Firestone, "means a distribution for wages, materials and new tire equipment alone of

more than \$125,000,000. This is an increase of about 50 per cent. over 1908, and will go a long way toward restoring normal conditions to general business."

Six-Cylinder Motor Still Gaining.—

Those autoists and manufacturers who predicted the speedy downfall of the "six" are gaining small comfort from the present situation. Not only is the "six" still gaining in our own country, but abroad as well. That France is becoming enthusiastic over the six-cylinder car is shown by the increasing number of "sixes" exhibited at the Paris Salon. In 1905 only three "sixes" were displayed. In 1906 the number grew to 23, in 1907 to 57, and in 1908 (last December) to 96. Practically every well-known maker in France is producing one or more six-cylinder models. Similarly at the Madison Square Garden show no less than 25 "sixes" were shown, which is 18 per cent. of the total. If the commercial cars were eliminated it would then appear that about one-fourth of the whole number are "sixes."

Old-timer Still at It.—As exemplifying the fact that some of the old-timers were built in a very sturdy fashion and built to last despite the then lack of fine materials, may be noted one Australian user of a car of the "vintage" of 1900. T. P. Williamson, of Yass, New South Wales, has converted into a delivery wagon one of the single-cylinder Wintons that were shipped to Australia in 1900. The nine-year-old motor is declared to be better than ever, Mr. Williamson stating that he gets 15-horsepower, although the original rating was 10-horsepower. This is a noteworthy record, for few cars built nine years ago are even in evidence, to say nothing of running.

Stands High in Home Town.—It is an old and very trite saying that a prophet may lack honor in his own country, but of automobile manufacturers a similar state-

ment would not hold water. Thus the majority of manufacturers lead in their home town or share this lead with another home-maker. Statistics lately compiled in Ohio by the State automobile department show that Cleveland, the home of the Winton car, has more autoists who drive Wintons than any other single make. Cleveland-owned Wintons range from the single-cylinder of 1899 to the "six" of 1909.

A. L. A. M. Hand-Book.—The sixth annual edition of the hand-book is now out, and, besides showing more cars than its predecessors, illustrates and describes the principal models for the coming year by the association members. The press work is excellent; the book, of the same size as heretofore (folio 8vo), being contained in a smart cover. An innovation is a page giving in tabular form the horsepower ratings of the various sized motors, according to the A. L. A. M. formula. The hand-book is sent, as usual, from the A. L. A. M., 7 East Forty-second street, New York City, on receipt of six cents to defray postage.

Big Factory Increase Necessary.—Owing to the great and growing demand for their cars, the Overland Automobile Company has been obliged to rent another factory, which will make the fourth. The latest is a large frame carriage building, which is at present standing idle. It was originally intended to build 1,500 Overland cars for 1909, but with the increased accommodation contracts have already been placed for parts sufficient to build 3,000, with an option on from 500 to 1,000 more. The output for Overland cars alone is already 20 per day, and by the first of February will be up to 25.

Compete with Street Cars.—Out in Pittsburg recently a company that got a "raw" deal from the railway company will start a competing line of automobile buses. It seems the Pittsburgh Railway Company refused to accept the Duquesne Incline Plane Company's transfers, so the latter will compete. April 1 an auto service will be established, running upon a four-minute headway during the rush hours, and but eight minutes apart the rest of the day. Twenty-two passenger buses of a well-known make will be used.

Inventor Will Revolutionize the Industry.—The following news item has been received: The triple-action lightweight motor is no longer a dream, but a reality. Edward van Baerle, of New York City, is now working on a model which he claims, when finished, will drive an automobile without the present transmission or clutch. It will, he thinks, make an ideal aeroplane motor, but probably would not be satisfactory in a motor boat.

Monarch Plugs Have New Factory.—The E. M. Benford Mfg. Co., maker of Monarch spark plugs, has completed its new factory building at Mount Vernon, N. Y., a handsome two-story brick structure, 30 by 125 feet, which is equipped with the most improved machinery for the manufacture of the company's products. Seventy-five men are employed under the direction of David Benford, assisted by M. Foltz as electrical engineer.

Reo Doing a Tremendous Business.—The daily sales of the Reo sales agents amount to nearly fifty a day now, with the prospect of an increase in this. A recent shipment from the factory to a Western agent was probably the largest single shipment ever made from Lansing, which is saying a good deal. This shipment of 18 carloads, containing 108 Reos, went to Wichita, Kansas.

Horses Get Another Setback.—Every day one hears of another case of the horse being supplanted. The latest is concerned

with the "bang tails," for the Crescent City Jockey Club, of New Orleans, after 25 years' successful operation, has decided to liquidate the club's affairs and convert the old race track in an automobile speedway. How are the mighty fallen!

Dolson Plant Now the Home of Motor Trucks.—The former Dolson Automobile Company's factory at Charlotte, Mich., has been sold to a Battle Creek firm, headed by a man named Messmer, and will be reopened at once. The vehicles to be built include a full line of commercial vehicles, notably delivery wagons and beam trucks.

Nadall Rim Wins Again.—In the recent demountable rim contest held in Minneapolis, Minn., by the Minneapolis Automobile Club, the Nadall demountable rim cleaned up the field once more. This winner of the first prize did the complete change in just 30 seconds, followed by Diamond and Fish in that order.

IN AND ABOUT THE AGENCIES.

American Distributing Company, Cleveland, O.—This concern announces that it now handles the output of the Hayes Wheel Company, Jackson, Mich. Formerly it handled the product of the Imperial Wheel Company, of which Mr. Hayes was vice-president and general manager for several years. The American Company also announces that it has no further connection with the product of the "Long Arm" System Company, but anticipates announcing a new connection very shortly.

Brush in Foreign Countries.—The Brush Runabout Company, Detroit, Mich., has under way negotiations with representatives in Chili, Peru, Ecuador, Venezuela, Columbia, Spain, Cuba, Porto Rico, Central America and Mexico. When the prospective arrangements are completed the Brush will have a representative in every country in the world of any importance to the automobile industry with the exception of Russia.

Oakland, Chicago.—The Centaur Motor Company of Buffalo, N. Y., general sales agents for the Oakland Motor Car Company of Pontiac, Mich., has completed arrangements for an agency in Chicago at the old Rainier quarters, 1725 Michigan avenue. Arthur M. Robbins, formerly with the Rainier branch in Chicago, will have charge.

Monarch, Pittsburg.—Among the agencies in the Smoky City is the Empire Automobile Company, who will act as a distributor for the Monarch car in the State of Pennsylvania. Branches have already been established at Uniontown, Tionesta, Oil City, Butler, Scranton and other towns.

New Lozier Headquarters.—The Lozier Motor Company is now located at 1751 Broadway, in the old quarters formerly occupied by the Hol-Tan and Rainier companies. The Lozier company occupies the entire building, necessitated by the growth of its selling operations.

American Simplex, New York City.—W. G. Isbell, Michigan agent for the American Simplex, recently closed a deal for the New York City agency of that car, and has sold his Detroit garage to Ashley Pond, Jr., agent in that city for the Stanley steamer.

Overland, Dallas, Texas.—A distributing branch for the Overland has been opened in Dallas, operated under the name of the Overland Automobile Sales Company, in charge of Mr. Funk, of the Oklahoma Motor Car Company, Oklahoma City.

Renault, Philippine Islands.—Paul Lacroix, general manager of the Renault Frères Selling Branch in America reports that a contract has been closed with Levy Brothers, of Manila, as representatives of Renault cars in the Philippine Islands.

Inter-State, Boston.—The Inter-State car will be hadled in Boston by the S. M. Supplies Company, which has recently organized an automobile department, with V. A. Charles as manager, and opened sales rooms at 22-24 Lincoln street.

Overland, Chicago.—A direct factory branch of the Overland Automobile Company is being operated at 1413 Michigan avenue, under the management of Charley Price.

PERSONAL TRADE MENTION.

Sigmund Krausz, who has been connected with the foreign department of the Dayton Motor Car Company, Dayton, O., has resigned after completing arrangements for Stoddard-Dayton agencies in South America, Cuba and Mexico. On the occasion of his departure from Dayton, O., Mr. Krausz was tendered a farewell banquet, given by the Dayton company, C. G. Stoddard presiding at the function. Mr. Krausz is now looking for another foreign proposition, and can be addressed at 5607 Indiana avenue, Chicago, Ill.

Edward Cannon Bald was recently married in Pittsburg, Pa., to Mrs. Joan Seeley Gilbert, and the announcement reads that after February 15 his home address will be 5710 Baum street, in that city. Mr. Bald is remembered as the old bicycle champion, who held his kingship for several years. The news of his marriage will be read with considerable interest by his numerous friends throughout the entire country. He has automobile trade connections in Pittsburg.

John C. Wetmore, automobile editor of the New York *Evening Mail*, has gone South on a Winter vacation. John R. Eustis, a well-known automobile writer, and formerly in charge of the automobile department of the New York *Globe*, is this week looking after Mr. Wetmore's *Evening Mail* duties.

C. J. Connolly, for many years a well-known bicycle agent in Rochester, N. Y., and later on the traveling force of the Motor Car Equipment Company, has accepted a position with the Mutual Auto Accessories Company, of New York City, and will cover his old territory with a new line of automobile accessories.

"Wally Owen," one of the oldest and best known automobile men, has joined the staff of Fickling & Company, 304 and 306 West Forty-ninth street, and will hereafter take charge of the company's second-hand department, to be opened as a clearing house in New York City for the various automobile firms.

A. B. Corder, senior member of the well-known New York City firm of Corder, Flinn & Toppin, agents for the Acme, sailed for London recently. His purpose is to secure a much larger building there and move the London branch house into it. The business having outgrown the present quarters in that city.

P. C. Chrysler, formerly with the Rainier Motor Car Company, has been appointed manager of city sales for the American Locomotive Company at 1886 Broadway, New York City.

W. S. Gilbreath, formerly of the Pope-Waverley Company, will be a notable addition to the sales department of the Overland Automobile Company.

RECENT BUSINESS CHANGES.

McDowell Bros., Auburn, Ind.—Munich gains one more manufacturing industry by the removal of McDowell Bros., who have been engaged in the manufacture of motor buggies here. A stock company has been organized and the business will be conducted on a much larger scale.

Corder & Flinn, New York City.—The metropolitan agents for Acme cars announce that John L. Toppin has been admitted to the firm, whose cognomen will from now on be changed to Corder, Flinn & Toppin.

Mitchell Automobile Company, Newark, N. J.—This concern, located at 282 Halsey street, has changed its name to the Crawford Automobile Company, and will handle the Crawford.

Mitchell, Cleveland.—The Cleveland agents for the Mitchell, Lucas & Christensen have removed to new quarters at 2139 East Eighteenth street.

Elmore, Cleveland.—The Elmore Motor Car Company will soon remove to its new home at Euclid avenue and East Ninth street.

BUSINESS TROUBLES.

Auto Motor Car Company, Cincinnati.—James H. Ratliff, vice-president, has asked for a receiver on the ground that the majority of stockholders have "fraudulently connived" to turn the assets over to the Sid Black Automobile Company by a "wash" sale. As a result, this \$50,000 concern, he charges, is insolvent.

FRANKLIN ANNUAL MEETING.

SYRACUSE, N. Y., Feb. 1.—The annual meeting of the stockholders of the H. H. Franklin Manufacturing Company was held Thursday last at the company's factory. H. H. Franklin was re-elected president; Giles H. Stilwell, vice-president, and F. A. Barton, secretary and treasurer. The following men were re-elected directors: H. H. Franklin, E. H. Dann, John Wilkinson, Giles H. Stilwell, A. T. Brown, W. C. Lipe and F. A. Barton. J. G. Barker and H. W. Chapin were named as inspectors of election for the next annual meeting.

For the first time the stockholders used the new directors' room in the new office building. The company has entirely completed its new building and every inch of the total floor space of 20,000 square feet is in use. The main office entrance is now in West Marcellus street, a few feet west of Geddes. The new office quarters are ornate, and there is now plenty of room, light, etc., for everybody, including officers, directors and the small army of clerks and stenographers required to care for the concern's big business.

The report of the president, given at this meeting, was filled with interesting data. The year of 1902 was the first twelve-month for the manufacture by the company of motor cars, and in that time thirteen cars were turned out. Now there have been built in one year in excess of 6,000. The employees of the company number 1,600, representing thirty-three trades. With the extensions of the past year, and not counting warehouse space leased for storage purposes, though including the newly leased plant of the Syracuse Bicycle Company, the concern now commands 250,000 square feet of floor space.

During the present trade year sale of cars has been made for shipment to Australia, Russia, Canada, Mexico, Cuba, Porto Rico and Hawaii.

THE AUTOMOBILE

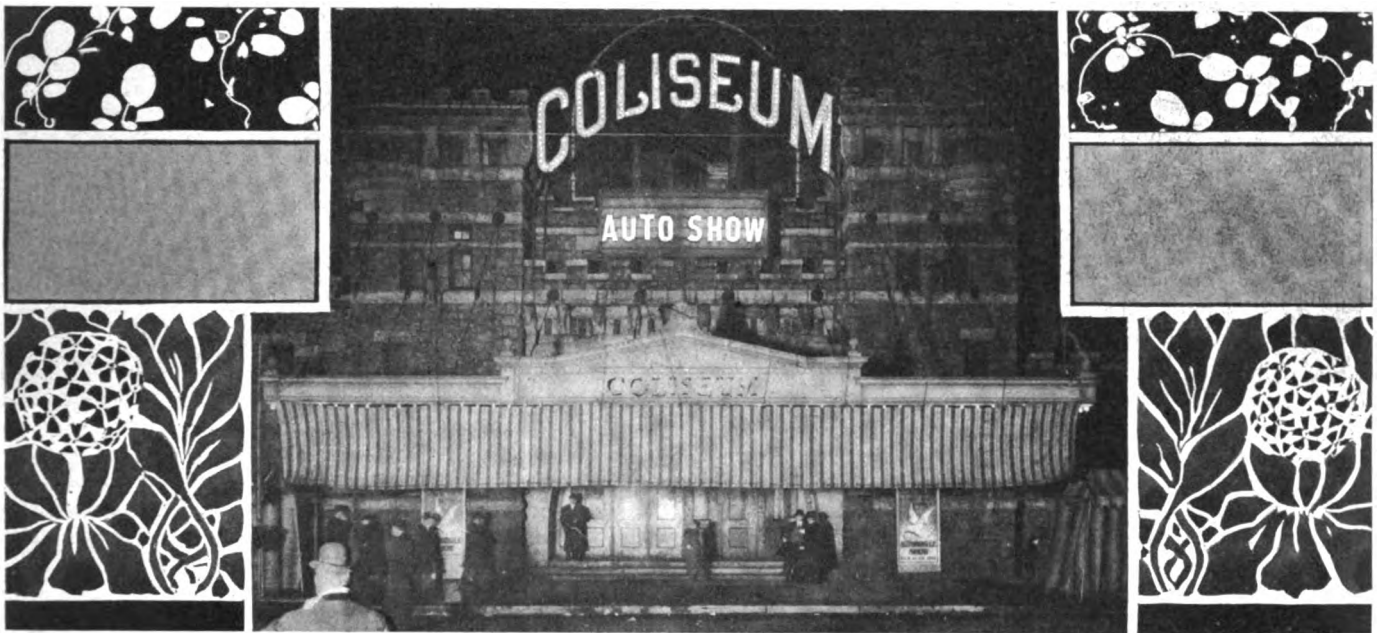

CHICAGO, Feb. 12.—Results are what count. The methods of the East are not always productive out this way, and Broadway isn't the only thoroughfare on which automobiles are displayed and sold. Furthermore, this show of the National Association of Automobile Manufacturers is artistically and completely the superior of either one of the two New York exhibitions, though, it must be said in the same breath that Manager Miles had plenty of material for the rolling of the two displays into a single affair. The job has been well done—most harmoniously accomplished—and the WEST (in capital letters) can truthfully boast that the agent and the individual buyer have an advantage over the East (only one capital) in making 1909 selections in one place instead of on two separate occasions.

There is confident feeling all around, out here, and the large out-of-town attendance figures largely in the premises, for there is undisputed railroad and hotel evidence that people have come many, many miles and from varied directions for the well defined purpose of buying automobiles of the present vintage.

For once, at least, real good weather favored the Saturday opening of the Chicago show. The temperature was above freezing, there was no wind, and the sun shone at intervals. Early visitors who went to the show at the hour of opening—2 o'clock in the afternoon—had a good chance to inspect the exhibits closely before the usual enormous night crowds flocked in after dinner. Eastern tradesmen, however, did not begin to arrive in any number until Monday morning.

To some the decorative scheme might appear to be getting too much attention. The exhibits of cars and chassis are somewhat overshadowed by the massive and elaborate decorations, with their variegated coloring. The view from one side to the other of the main hall is also cut off by the low papier-maché arches, molded and colored in imitation of cast bronze.

Notable absentees in the New York shows of this Winter who have prominent exhibits in the main hall are the Oldsmobile Company, Thomas B. Jeffery & Company, American Locomotive Company and the Bartholomew Company.



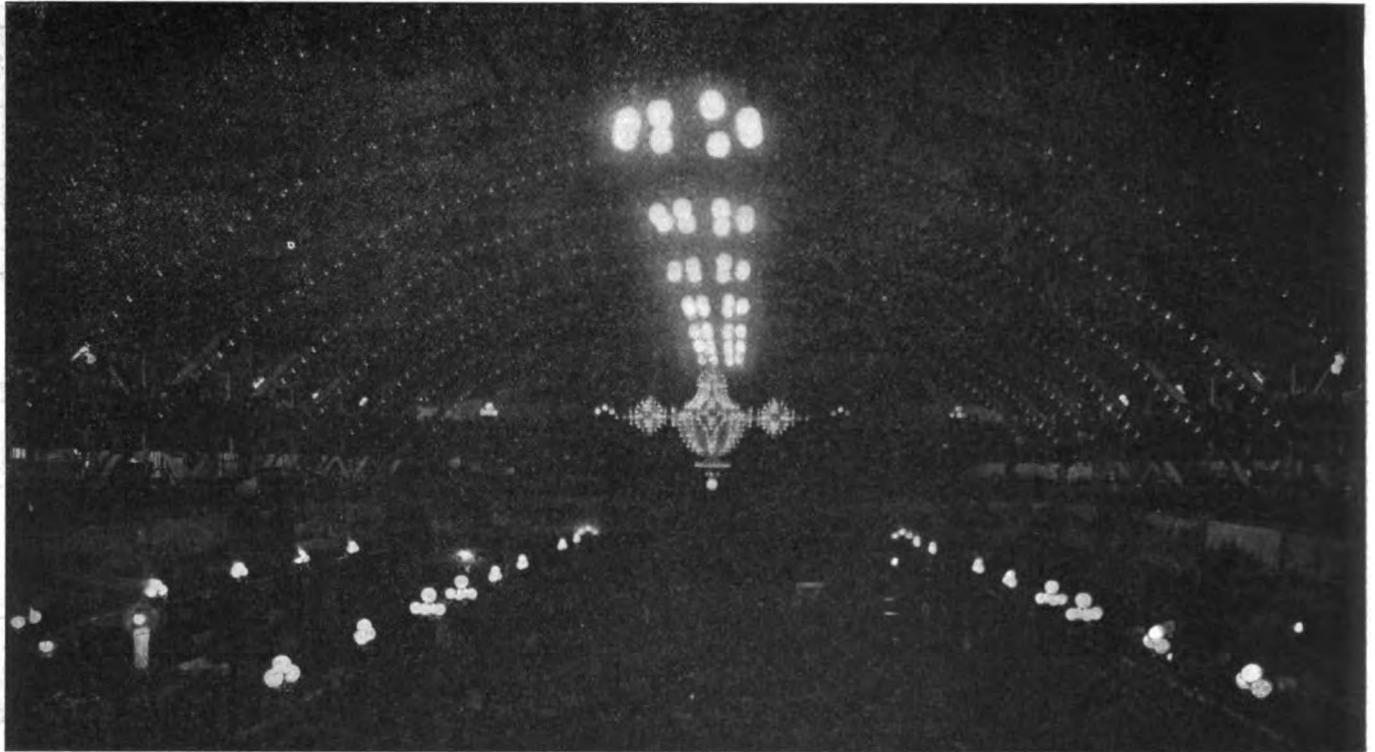

Above the "Blue" of the Car Displays the Decorative Scheme Proclaims Superiority.

There is no commercial vehicle section this year. The old Tattersalls building is unfit for use and badly located, and no other suitable building could be secured within reasonable distance. There are only three exclusive commercial vehicle exhibitors in the show—the Rapid Motor Vehicle Company, Grabowsky Power Wagon Company, and the Randolph Motor Car Company. The last two are located in the Coliseum Annex and the first in the Armory. Besides these, several pleasure car makers, particularly the motor buggy builders, are showing models of light gasoline delivery wagons.

The motorcycle section, which occupies all the central space on the second floor of the Annex, comprises nineteen different makes of machines, both American and foreign, and is the most comprehensive and best arranged exhibition of two-wheelers ever made in this country.

Closed cars for town use are in the decided minority, although Chicago uses many coupé and limousine machines. The prevailing models on display are touring cars, with folding tops, toy tonneaus, four-passenger bodies with a pair of bucket rear seats, and cross-country or high-powered runabout machines with rumble seat.

A dozen makers are showing high-wheeled machines, generally designated as motor buggies. Henceforth, however, the name will be a misnomer, for these machines are already undergoing a change in style. Several builders are fitting special runabout bodies with a third seat in the rear, bodies with true automobile hoods and other styles not borrowed from the carriage trade. In several cases engines are being located in front, sliding gear or planetary change-speed mechanism, differentials, etc., fitted, and other automobile features incorporated. Soon the chief resemblance these machines will bear to buggies will be in the high wheels and solid tires—and the wheels even are in some cases being reduced in diameter to 36 inches.

Were it not for the brilliant decorations, the show would present a somber aspect, for the prevailing finish of the machines is black, with perhaps a 25 per cent. proportion finished in maroon or other dull shades of red. Other colors used are generally of a quiet tone, such as dark green, brown, gray and white. Exceptions that prove the rule are several flaming scarlet machines and a violet-finished and upholstered electric coupé—a bridal model that attracts much attention.

The motor buggy has even acquired the distinction of a place of honor on the main floor of the Coliseum, as a recognition of this type as a permanent style of automobile. The Holsman—first and most consistent make—is found under the gallery against the north wall.

Miniature models of the engines used in their cars are displayed by the Maxwell-Briscoe Company and the Model Automobile Company, maker of the Great Western. These miniatures are only about a foot long, but are perfect working models, and the Great Western model is shown in operation driven by a small electric motor, the use of gasoline in the building being forbidden by the fire department.

The automobile show is a practical school of motoring, and hundreds of men and women—and probably more boys and young men—get a clearer idea of the actual operation of a gas engine and the change-speed and differential gears at the show than they can acquire in any other easy way. Several car exhibitors—as the Dayton Motor Car Company and the Chalmers-Detroit Motor Company—show full sized motors sectioned down through the cylinders to show the action within the cylinders; others show the transmission in operation under a glass top to the gearcase, while parts makers show the steering gears and differentials in a manner to make the action plain.

The Berliet and Fiat are the only foreign cars in the show, and they are located in the Armory.

Here, as at the New York shows, the interest shown by visitors in the exhibits of component parts and accessories in the galleries is very pronounced, so much so that the narrow aisles high up under the steel trusses of the roof are quite inadequate. There is barely room in the aisles for two persons to pass each other under the arches and many a hat and some heads in passing have suffered from unexpected contact with structural steel.

Prize cups are prominent features of a number of the stands. The Vanderbilt silver cup at the Locomobile stand and the Savannah gold cup at the Fiat stand are the largest and most prominent, while the aggregation of cups and trophies won by the Pierce Arrow in endurance, economy, and hill climbing contests, and the collection of race prizes won by the Maxwell cars are attractive features of the Coliseum displays.

So inadequate to the present requirements of a national automobile show at the present time is the Coliseum that in addition

to the Renault, Ford, and P. & S. private displays outside, the Chadwick, American, and Velie are also excluded from the show through lack of space and are being displayed in private sales-rooms: the Chadwick at 1218 Michigan avenue; the American at 1507 Michigan avenue, where the Petrel is also holding open house, and the Velie at the local branch of the Velie Motor Vehicle Company, of Moline, at 1615 Michigan avenue. The Palmer & Singer models are being exhibited for the first time in the West at the Auditorium Hotel on the main floor.

There have been numerous meetings and gatherings during the week. The branch managers and agents of various concerns have met and dined and talked and accomplished various things. The A. M. C. M. A. had its annual meeting; the A. A. A. Executive Committee is holding forth to-day; the makers and importers interested in racing have occupied much time in talking rules and race control; and all around there has been an automobile clearing house for the exchange of innumerable ideas and the discussion of matters requiring up-to-date attention.

SOLVING THE CONTEST SITUATION.

CHICAGO, Feb. 10.—There has been much talk about the control of contests, both racing and otherwise, in the past few days, and this is the way it is sized up on this Wednesday morning:

Beginning last Saturday there were sessions, one after another, of representatives of American concerns and foreign importers interested in contests and racing. The final result is a plan to have what will be termed a Manufacturers' Contest Association, membership on which will be limited to makers producing 50 cars annually and to importers handling 25 cars. This body will cooperate with the Contest Board of the A. A. A., providing the plan is acceptable this afternoon to the representatives of those manufacturers who have agreed to attend a meeting called for the purpose of considering the whole subject.

Next will come the offering of the more or less amended plan

as it will be presented for ratification to-morrow to the executive committee of the A. A. A., which holds a monthly meeting.

The N. A. A. M., the A. M. C. M. A., the A. L. A. M., and the importers will be represented on the Manufacturers' Contest Association, which would figure in the rule-making, granting of sanctions, etc. But the plan may be somewhat altered.

At the meeting which completed the preliminary work were the following: Howard E. Coffin (Chalmers-Detroit), H. O. Smith (Premier), William E. Metzger (E-M-F), Harry Lozier (Lozier), Paul La Croix (Renault), E. R. Hollander (Fiat), George H. Stroud (Apperson), Charles B. Shanks (Stearns), E. P. Chalfant (Association of Licensed Automobile Manufacturers), Alfred Reeves (American Motor Car Manufacturers' Association). A. R. Pardington and F. J. Wagner were also present upon invitation.

SMITH ELECTED PRESIDENT A. M. C. M. A.

CHICAGO, Feb. 10.—H. O. Smith, of the Premier Motor Mfg. Co., at the annual meeting of the American Motor Car Manufacturers' Association, was unanimously elected to the presidency, succeeding Benjamin Briscoe, who declined re-election after having served two terms. The other officers named were: C. G. Stoddard, Dayton Motor Car Company, vice-chairman; S. H. Mora, Mora Motor Car Company, treasurer; G. Vernon Rogers, Mitchell Motor Car Company, secretary, and W. H. Vandervoort, Moline Automobile Company, auditor. These three members of the committee management were re-elected: Charles M. Lewis, Jackson Automobile Company; W. C. Marmon, Nordyke & Marmon Company, and W. H. Vandervoort, Moline Automobile Company. Of course, Alfred Reeves, under whose capable management the association has progressed to a plenteous treasury and forty-two members, will continue as general manager. Both Mr. Briscoe and James Couzens, who was the first chairman of the committee management, will be remembered with souvenirs.

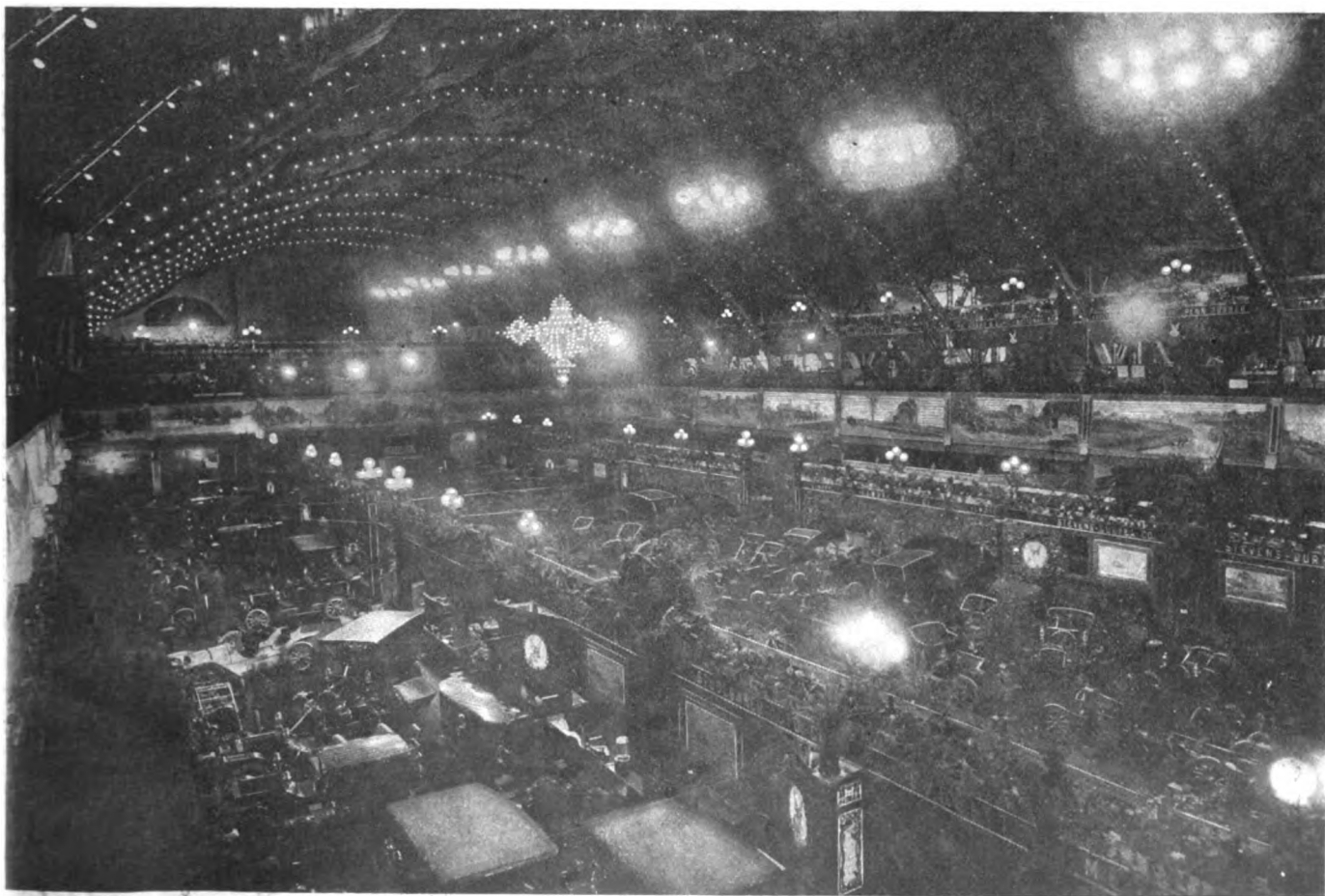

On the Coliseum's Main Floor a Galaxy of Splendid Automobiles Bask in the Milky Way of Lighting.

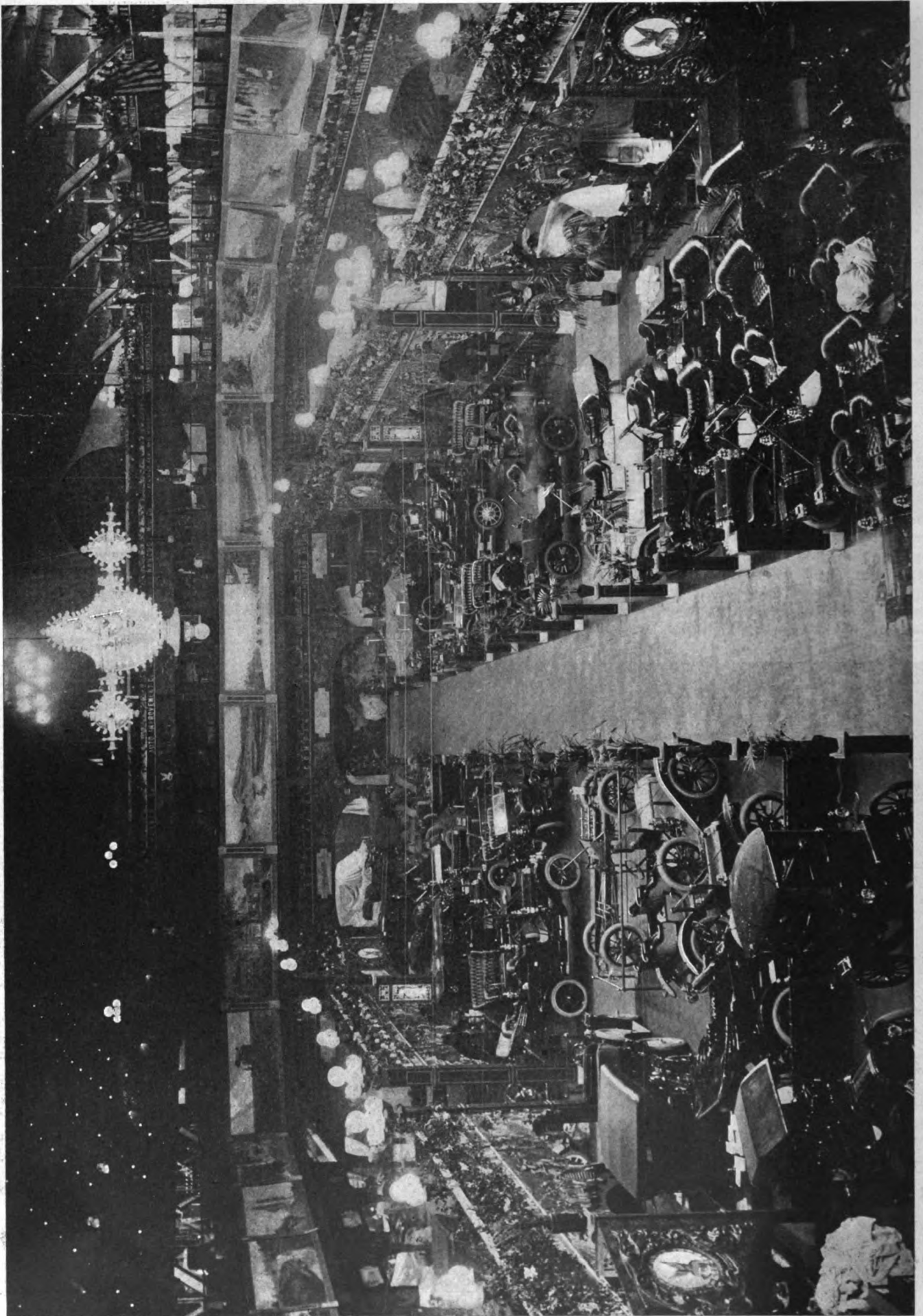

The Retina of the Camera Found Sallent Features of the Landscape and Much to Picture Within the Colliseum's Ample Auditorium.
Photograph by Howe & Arthur, Chicago.

SOMETHING ABOUT THE NEW COMERS

A TOUR of the stands in the Chicago show reveals, besides a few newcomers with interesting exhibits, a fair variety of innovations and departures on the part of long-established concerns. On the whole, however, the seeker for extreme novelty is certain to be disappointed, unless his technical knowledge is so thorough that his interest finds satisfaction in the contemplation of the details and finer points of automobile engineering which escapes the average lay visitor's attention. Those of the old-timers among the motor-wise will seek with perhaps just a shade of regret for the work of the once perennial freak designer.

American Locomotive Company, New York and Chicago, continues to improve on its home-designed product to the extent of far outdistancing the excellent reputation it originally gained by its domestic duplication of a well-known foreign machine. The 1909 "Alco," as the car is now called, is built from stem to stern with the constant idea of making good on the manufacturer's slogan, "It stays new." The cylinders are of imported cast-iron, having a vanadium content, and are said to excel over those of ordinary product in that pitting never occurs in the course of wear, while a polish impossible to other irons is attained through use. Integral cams, make-and-break ignition with Bosch magneto, the extensive use alloy steels and imported bearings, four-speeds, and close engineering attention to detail and finish, are among the hallmarks of high quality that stand forth. The line includes a six-cylinder, 60-horsepower chassis, chain driven; a chain-driven, four-cylinder, 40-horsepower, and a shaft-driven 22-horsepower, with a variety of bodies.

Bartholomew Company, Peoria, Ill., is focusing its 1909 activities upon two models—a touring car and a roadster, both propelled by the same 45-horsepower engine, and containing substantially the same structural details, but differing in price. The rear-axle mounting of the change-speed gear in a unit with the differential housing is employed, with the usual selective operation affording three speeds forward and reverse. High-tension ignition, with magneto extra, is regular equipment. Unusually attractive are the body lines and the unusual harmony of the general design.

Dorris Motor Car Company, St. Louis, adheres to structural features justifying its claim to be called the "car of simplicity." With the radiator off, the camshaft with its bearings is readily removable through the front of the crankcase; with the flywheel and transmission out, the crankshaft comes out rearwardly in a similarly simple manner. The Dorris Company still adheres to

whose vagaries afforded a certain entertainment even while they were a subject for derision. The automobile "game," which once supplied a conglomeration of some of the most fearful and wonderful devices man ever devised, even while it also marked time for a now historic engineering development, is long since dead and in its place has come the automobile "industry," which in its settled conservatism and substantial standing is second to none of the great fields of mankind's business and technical activities. Among those who did not exhibit at either of the New York shows are the following:

its policy of building only one model of chassis—for touring, roadster, limousine, convertible, cab-landaulet, and other bodies. Besides simplicity, extreme accessibility is sought. Both exhaust and inlet valves are contained in removable cages, facilitating regrinding and maintenance. The cams are integral with the camshaft. The motor, clutch and change-speed gear are combined in the now popular unit power plant. The selective sliding-gear transmission affords three speeds forward and the reverse. At-

water-Kent ignition is stock equipment, but magneto is optional for those preferring it. A point is made of the liberal tire equipment, 34 x 4 being used all around.

Emancipator Auto Company, Aurora, Ill., is a newcomer in the low-price field, and is displaying a fully-equipped four-passenger car, with top, lamps, glass front, etc., propelled by a four-cylinder motor, driving by shaft through a two-speed planetary gear. The engine is a double horizontal opposed, an unusual construction,

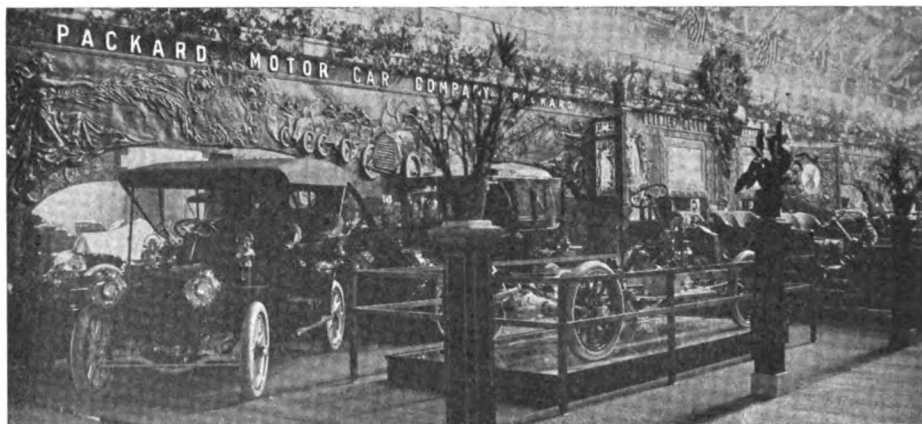

Packard Chassis Is Reflected From a Mirror on the Floor.

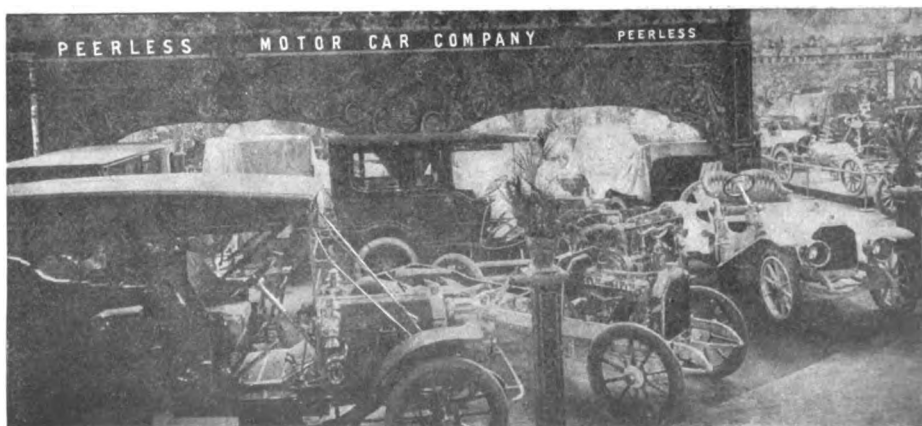

Peerless Chassis In Front of the Louis XVI Limousine.

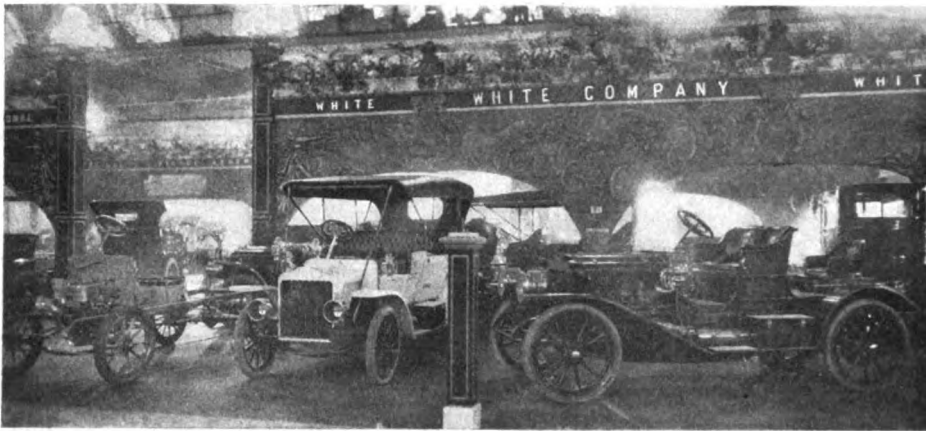

White Steamer with the Roadster Type to Whet Interest.

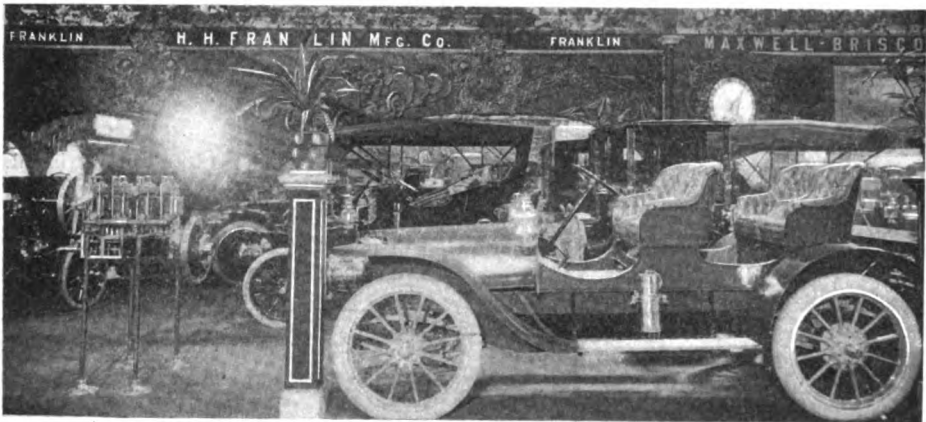

Franklin Air-Cooled Cars Showing Resilient Chassis.

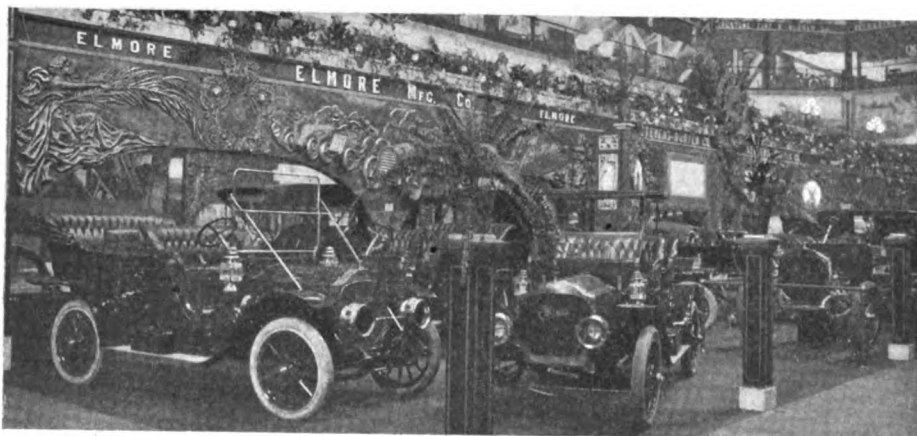

Elmore Two-Cycle Perfection and the Flexibility Entailed.

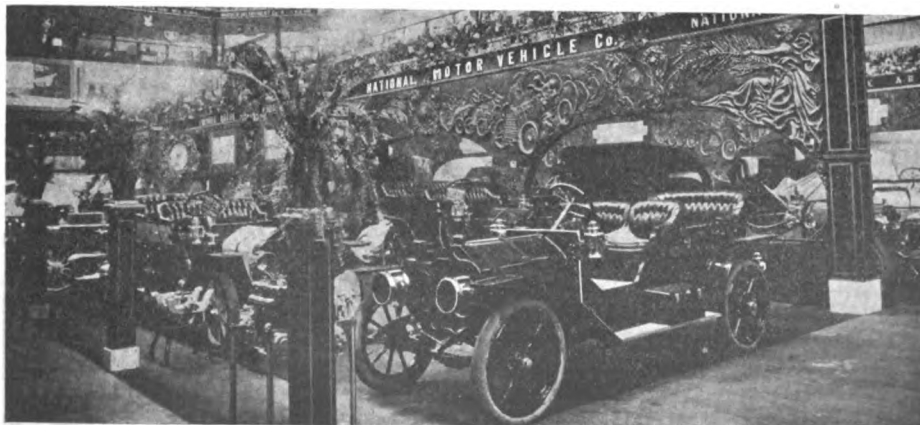

National Cars as Jewels in a Sea of Relief Decorations.

possessed, however, of numerous features of merit. The crankcase, for example, is integral with the cylinders. Besides the touring car are a two-cylinder runabout and a delivery wagon on the runabout chassis. In this way the whole field is covered.

Thos. B. Jeffery & Company, Kenosha, Wis., are showing for 1909 a line that is a center of attraction, especially to the intending purchaser who seeks large, commodious cars of standard design at minimum prices. The Rambler spare wheel attracts especial attention, and the ease with which it can be interchanged, in four minutes, with one of the road wheels does not fail to appeal to the motor-wise who have struggled with roadside repairing of deflated tires. The offset crankshaft of the Rambler motors, placing the connecting rods in most effective position to receive the force of the expanding gases, is another point on which great stress is laid. The large openings to the crankcase, readily permitting connecting-rod adjustment from above, take the eye of those who worship at the shrine of accessibility. Another detail in which Rambler cars excel is the running gear, the spring being particularly ample and well designed to afford comfort and avoid breakage.

Meteor Motor Car Company, Davenport, Ia., is making only one model for 1909—a 50-horsepower, four-cylinder machine, with seven-passenger touring-car body. The change-speed gear departs from standard practice in that the gears are always in mesh, operative pairs being engaged by jaw-clutch systems similar to the external and internal gear meshing whereby the direct drive on high speed is obtained in common types of sliding gears. Final drive is by shaft, to a Timken live rear axle. The Bosch magneto constitutes a part of the ignition system, storage battery being used as auxiliary.

Model Automobile Company, Peru, Ind., is appearing as Western distributors of the Great Western car, which is made in three four-cylinder models, all of standard outline. High-grade construction rather than innovations seems to be the policy behind the design of this machine, so aside from the use of exhaust valves in the cylinder heads and a few other slightly uncommon details, the construction is conservative. Interchangeability of parts is a point that will appeal to the user away from the large centers of population. The leader of the line is a 50-horsepower touring car, from which sizes taper down through the 40-horsepower touring car and the 30-horsepower touring car to a smaller runabout in the process of covering the field.

Olds Motor Works, Lansing, Mich., present an especially striking array of body designs for the prospective customer to choose from. Coupés, limousines, landaulets, regulation touring cars, toy tonneaus, roadsters and "close-coupled" designs, all are regularly catalogued for application to

the several chassis. Magneto ignition, valve-noise silencers, improved circulating pumps, completely protected driving mechanism, and a new live axle design are among the changes in mechanical details.

Owen-Thomas Motor Car Company, Janesville, Wis., is on view with a car fairly bristling with original features. It is a large six-cylinder machine, built with runabout, double roadster and seven-passenger touring bodies, and propelled by a four-cycle engine developing about 50 horsepower. This engine is internally air-cooled by scavenging blasts of air at different points in the cycle, and therefore functions without the use of any cooling ribs or fins whatever. Fuel is supplied by direct injection into the cylinders, and the valves are of an ingenious rotary type. The whole design is particularly interesting in that it would appear to constitute the first public embodiment in metal of ideas originally suggested by Victor Loughhead in a series of articles an "Some Trends of Modern Automobile Design," which appeared in *Motor Age* during the Summer of 1907. An ironbound five-year replacement guarantee is evidence of the faith the manufacturers have in the new construction.

Rider-Lewis Motor Car Company, Muncie, Ind., is one of the few concerns that are specializing in the increasingly popular six-cylinder type, their only model being a 40-horsepower chassis, built with touring car, landaulet, limousine and roadster bodies. Simplicity of construction and light weight secured through the elimination of all surplus metal are the keynotes of the Rider-Lewis idea. Accessibility, too, has been given studied attention. Valve cages, for instance, remove upon the mere loosening of a locking ring. The crankshaft is assembled endwise into the one-piece crankcase. The clutch and clutch mechanism are directly under the footboards to facilitate inspection and adjustment. The change-speed gear is mounted on the rear axle. On the whole the cars of this make belong to the class in which accessibility is booked for first place and this fact coupled with a certain harmony of relation of power to weight renders the cars of more than passing interest. Public interest backs up the judgment of the designers.

Streator Motor Car Company, Streator, Ill., is for 1909 departing from its three seasons' old policy of making but one model, and now presents a considerable variety of cars built on two different chassis. An exhaustive search of the mechanism of both types fails to disclose a single radical detail, but it equally fails to disclose anything not of the soundest and most substantial engineering. The engines are four-cylinder in both chassis, 35-40 horsepower in one and 24 horsepower in the other. In the small car the change gear is built into the rear-axle housing. In the large it is of the standard three-speed selective type, with the usual placing.

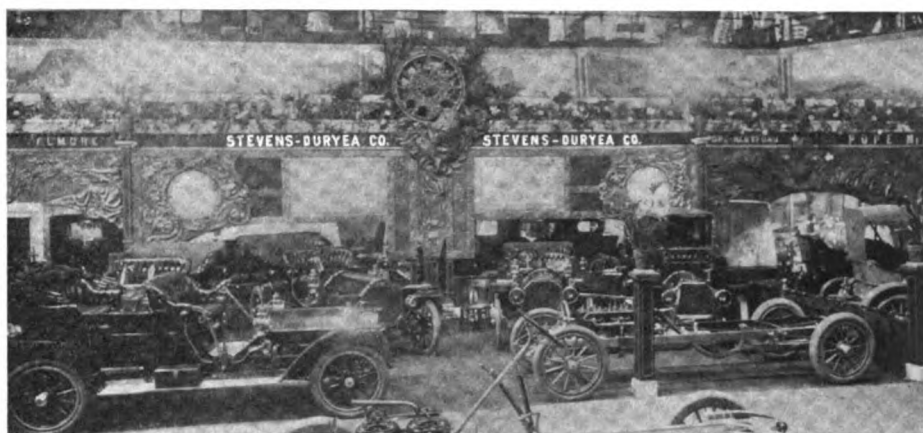

Stevens-Duryea Showing Three-Point Suspension Splendor.

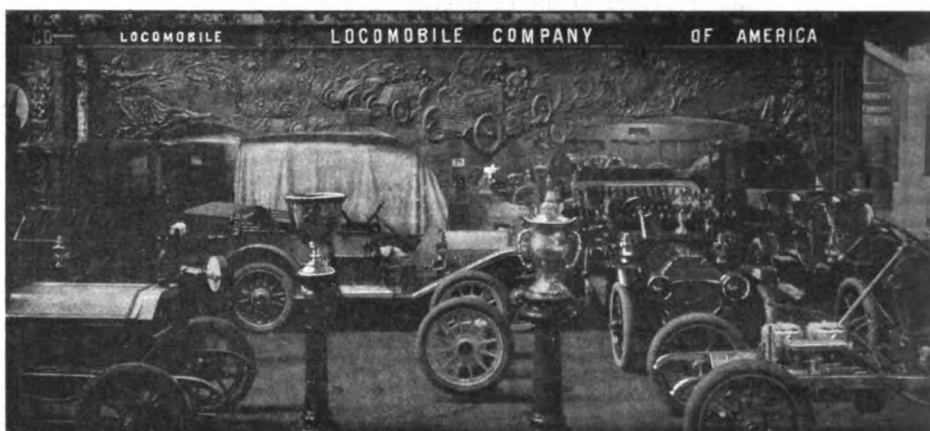

Locomobile with a New Shaft Drive Flexible Chassis.

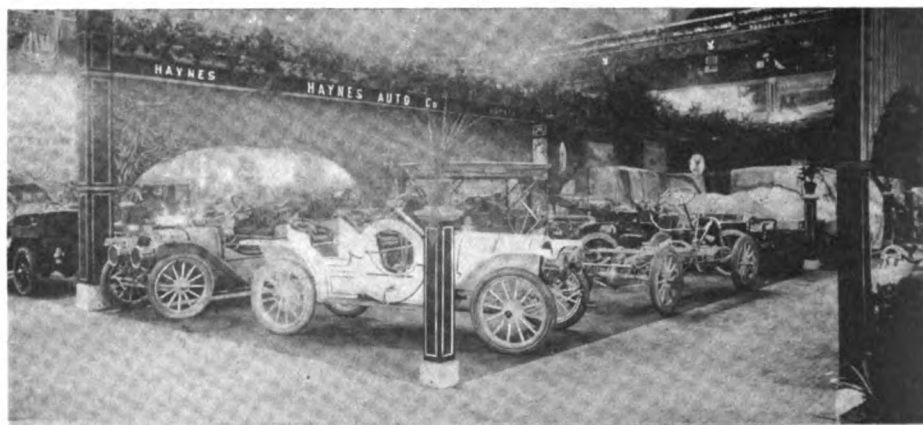

Haynes Cars Built in Alloy and Special Auto-Steel.

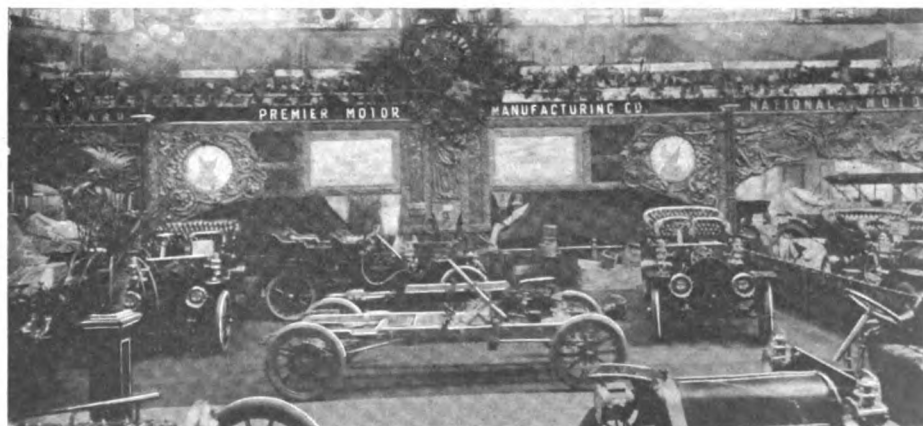

Premier Exhibition of Cars with Multi-Century Ancestors.

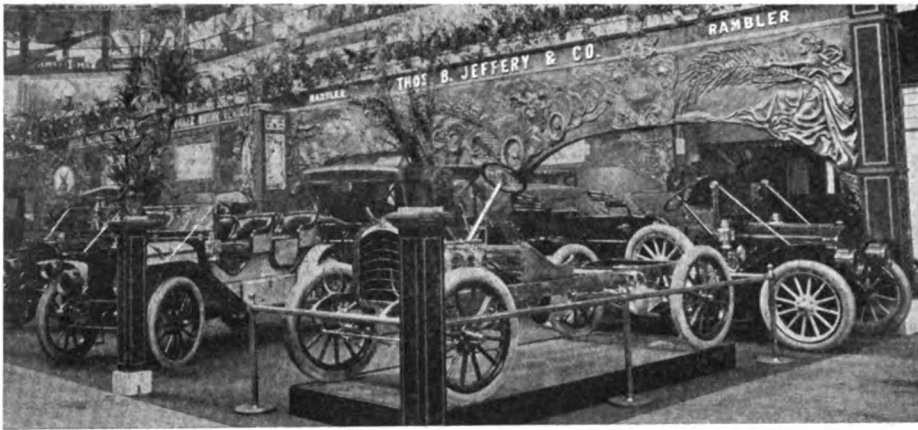

Rambler Chassis in the Foreground Is Elevated Effectively.

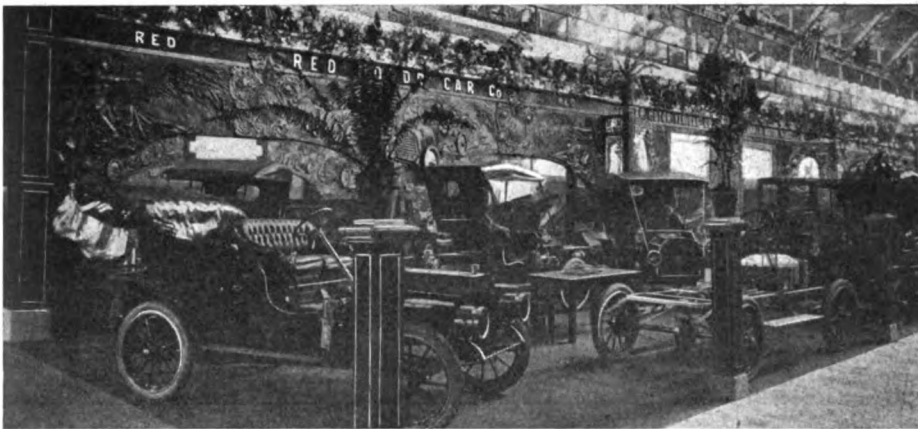

Red Shows a Chassis and Spectators Unflagging Interest.

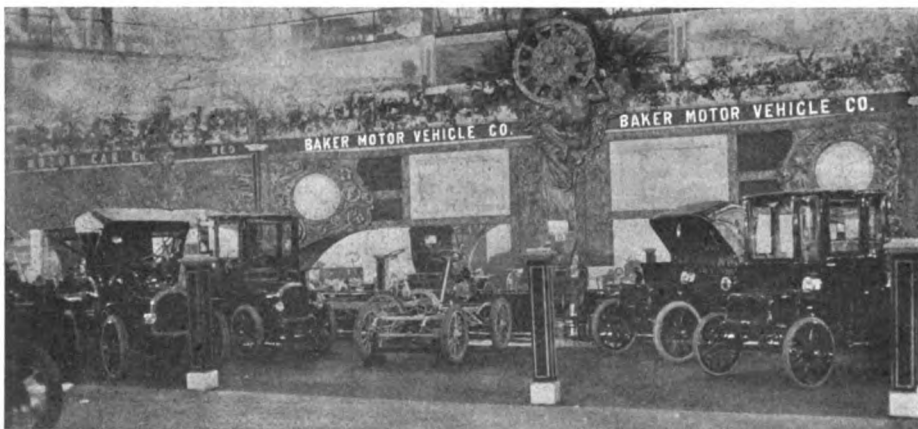

Baker Springs a Surprise in the Electric Chassis.

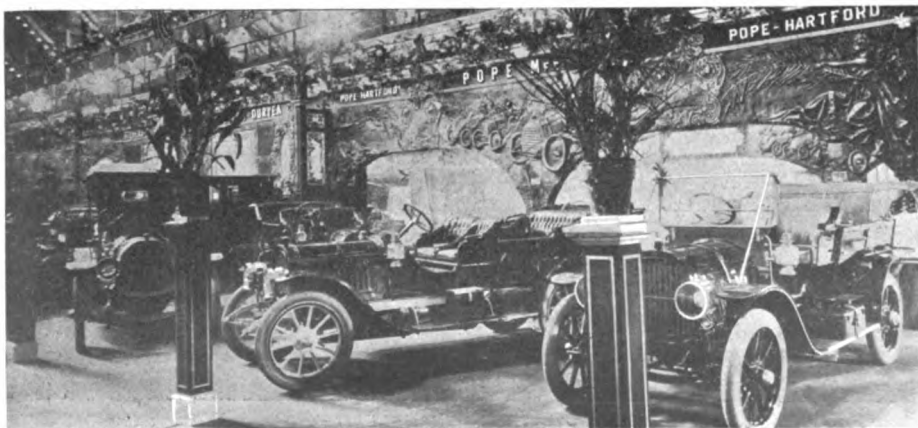

Pope-Hartford Includes Fine Body Work on Standard Cars.

HIGH-WHEELERS IN EVIDENCE.

Ancestors of all automobiles; neglected for a time; these same cars are now regarded as the fitting conclusion from the point of view of cars in which solid tires are at home, and in which stability resides to a marked extent, especially if road conditions are of the order "un-improved," as they are in many sections of the country. But if the cars of high-wheels will make headway under a handicap of roads, it is plain to be seen that on good roads autoists would have nothing to fear.

That the resiliency of high wheels will render solid tires capable has been adequately demonstrated, and that the high-wheel automobile is the favorite of the doctor and the contractor is but fitting proof of the wisdom of the automobile designers who declined to float with the tide which set up on pneumatic tires and rolled along on boulevards. The low price of the high-wheeler renders it the more fitting, and that it has a place in the art is as certain as the industry itself.

The Clark-Hatfield Auto Company, Oshkosh, Wis., make an exceptionally high-grade buggy type vehicle in one model only, sold at a price allowing the finest construction and workmanship. With a two-cylinder, air-cooled 14-horsepower motor, and a weight of only 1,200 pounds, its ability to go "anywhere a horse will go, and then some," will not be successfully disputed. A single-chain drive with ratchet differential constitutes something of a novelty.

The Columbus Buggy Company, Columbus, O., makers of high-wheel delivery wagons and buggies of several seasons' standing, are including in their line for 1909 a more conventional 35-horsepower touring car with pneumatic tires and other approved details, which they name the Firestone-Columbus. They also continue their excellent pneumatic-tired electric coupés, surreys, runabouts, victorias, phaetons.

The W. H. McIntyre Company, South Bend, Ind., is in the field with nine different models of high-wheeled machines. This concerns succeeds the W. H. Kiblinger Company, and is putting up some of the most convincing arguments, both in advertising and in product, that have yet appeared in favor of the advancing big wheeler.

The Mier Carriage and Buggy Company, Ligonier, Ind., puts out two models, both driven by side chains and both fitted with water-cooled, two-cylinder motors of types more nearly resembling standard automobile than high-wheeler practise. One of the engines is horizontal opposed and the other is a twin-cylinder vertical.

The Staver Carriage Company, Chicago, is showing the most powerful buggy-type machine ever exhibited—a four-cylinder, 22-horsepower machine, with 38-inch wheels and a 98-inch wheel-base. The engine is of the four-cylinder type.

CULLED FROM THE ACCESSORY DIVISION

THAT the city by Lake Michigan can boast a Western trade exclusively and inalienably its own, is well demonstrated in the number and importance of the exhibitors who did not display their wares at either of the New York shows. Indeed, no one closely identified with the interests of the trade could afford to be unfamiliar with the novelties to be seen at some of the stands.

Bower Roller Bearing Company, Dayton, O., is a newcomer in the bearing field, but the product of this concern's activities bears every evidence of having attained a quality possible only as the result of high designing ability and prolonged experimental investigation. All of the Bower bearings are of the non-adjustable (except for end thrust) annular type, with the load carried on cylindrical rollers, which are provided, however, with enlarged heads that come into play only to resist end thrust. A special steel alloy containing a percentage of nickel and of extreme hardness and resisting qualities has been developed for this company's use. Finishing is accomplished under water in special grinding machines, and no part passes inspection until it tests to the most extreme accuracy of size and fit. Considerable of a departure in roller bearing manufacture is the production of a line of metric sizes designed to interchange with standard annular ball bearings. Another innovation is a policy of designing to the user's requirements instead of requiring him to use listed sizes.

Firestone Tire & Rubber Co., Akron, Ohio, is showing for the first time its new demountable rim for the side-wire solid tires. Extreme simplicity is the great point of this rim, a locking ring serving to let the tire off in case of its injury, so that it may be as quickly replaced with a new one carried on a similar rim. The Firestone demountable rim for pneumatic tires is made to be used in conjunction with either clincher or quick-detachable tires, and is very similar to the type just described, except for the absence of the side flange. It was this rim with Firestone tires on which the Locomobile won the Fairmount Park race in Philadelphia last October. One advantage is that it permits the use of regular inner tubes, without special valves.

Fulton & Zinke, Chicago, are exhibiting circulating pumps, coils, lamps, generators, carbureters, make-and-break spark plugs, the Churchhill timer, an exceptionally practical looking air cranking device, etc.

The cranking device consists essentially of two semi-circular cylinders, containing single acting pistons arranged to be driven to the end of their travel by air from a tire bottle or other suitable source, controlled by a simple four-way valve that can be manipulated from the dash. One of the cylinders is much larger than the other, and upon it devolves the work of throwing the crankshaft over 180 degrees at a time. The smaller piston retracts the larger, so that the half revolutions can be effected rapidly and repeatedly until the engine starts. The price is not high, attachment is simple, and the field would appear to be wide open for anything apparently so well adapted to do the work. The novel point of the Churchhill timer is provision for adjusting the contact duration to meet the needs of different engines, a feature for which there undoubtedly is some need.

Hancock Mfg. Co., Charlotte, Mich., long recognized as one of the best multi-feed lubricators on the market, the 1909

models are in every way calculated to uphold their established good reputation. Improvements, however, are confined to details rather than extended to general principles, and simplicity of construction and positiveness of operation are ideals which the technically informed will be especially disposed to approve. A new compound tire pump is a side product of the Hancock Company, it being designed to overcome objections existing in types previously in use. By scheming to reduce friction and valve losses to a minimum, it is declared that a greater volume of air can be pumped to a given pressure with less effort than is required for the operation of any other pump made. Moreover, special thought has been devoted to the working out of such details as will insure its remaining in order for the greatest possible period without adjustment, cleaning or repair. This is fortunate since lack of stability and good design is bound to make for more than a little dissatisfaction in this zone of activity.

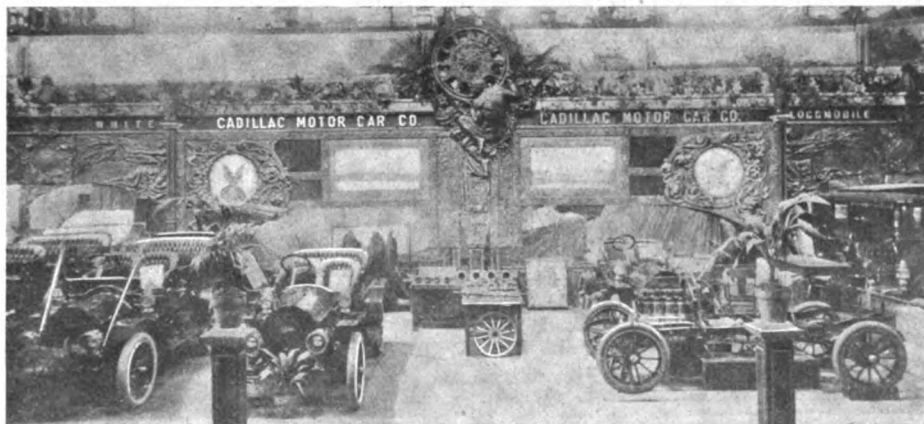

Cadillac with Individual, Copper-Jacketed Cylinders.

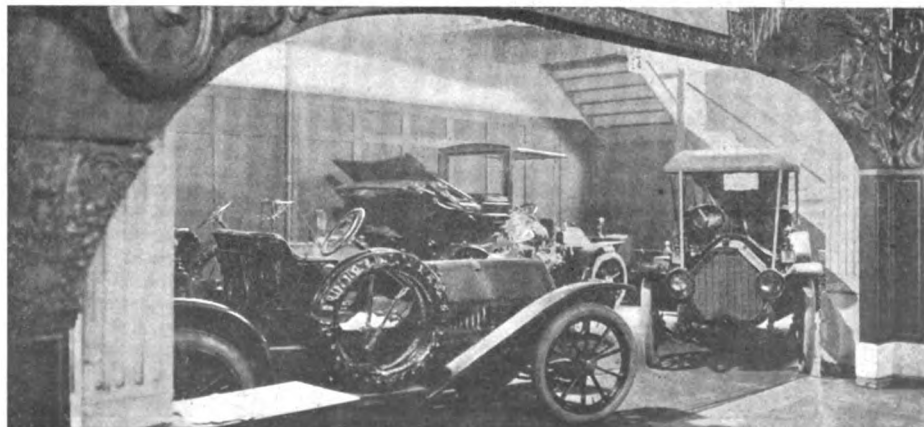

Toledo Chassis in Which Chrome Nickel Steel Abounds.

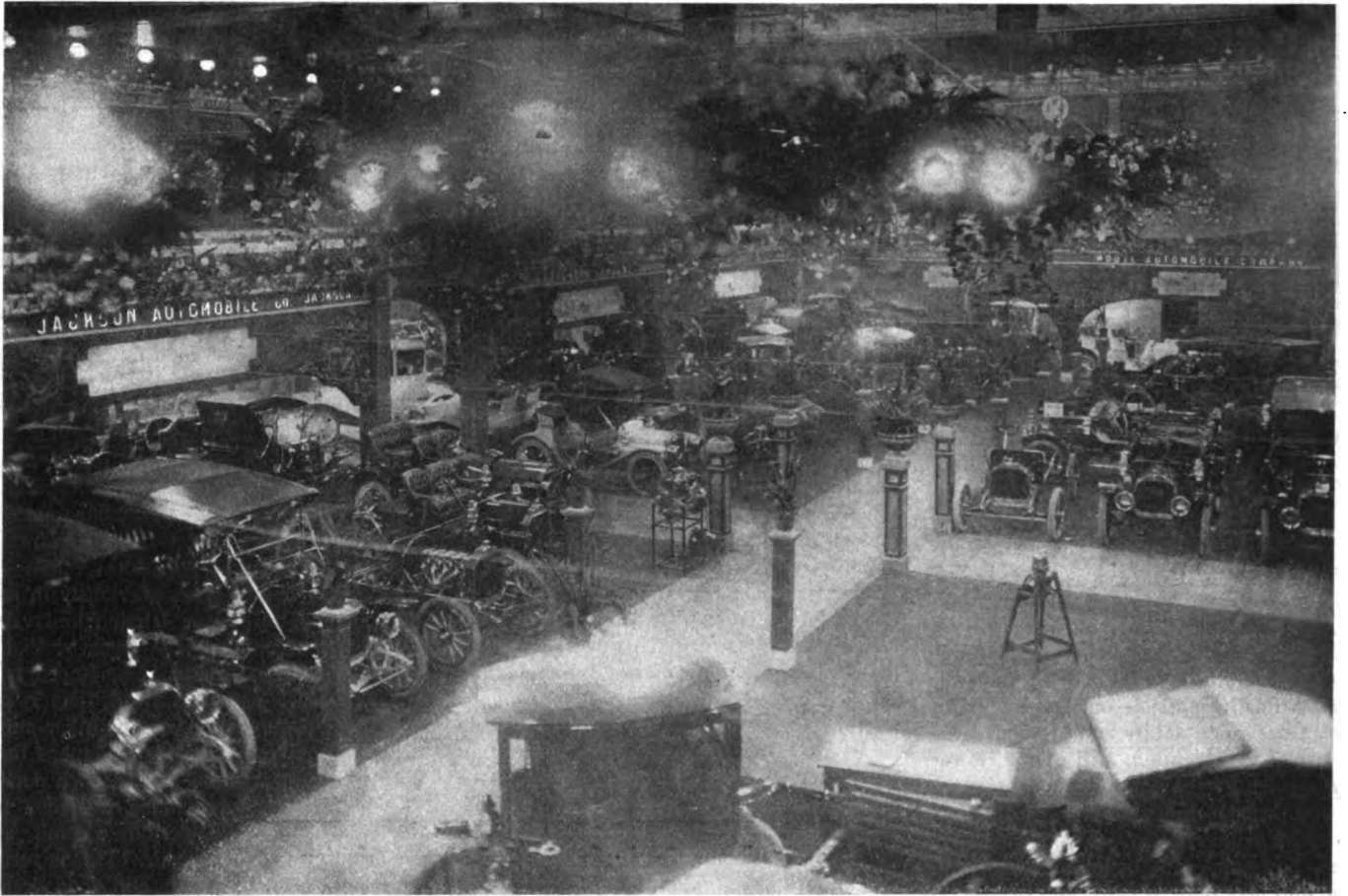

First Regiment Armory, Where Photographing Was Most Difficult and Unsatisfactory.

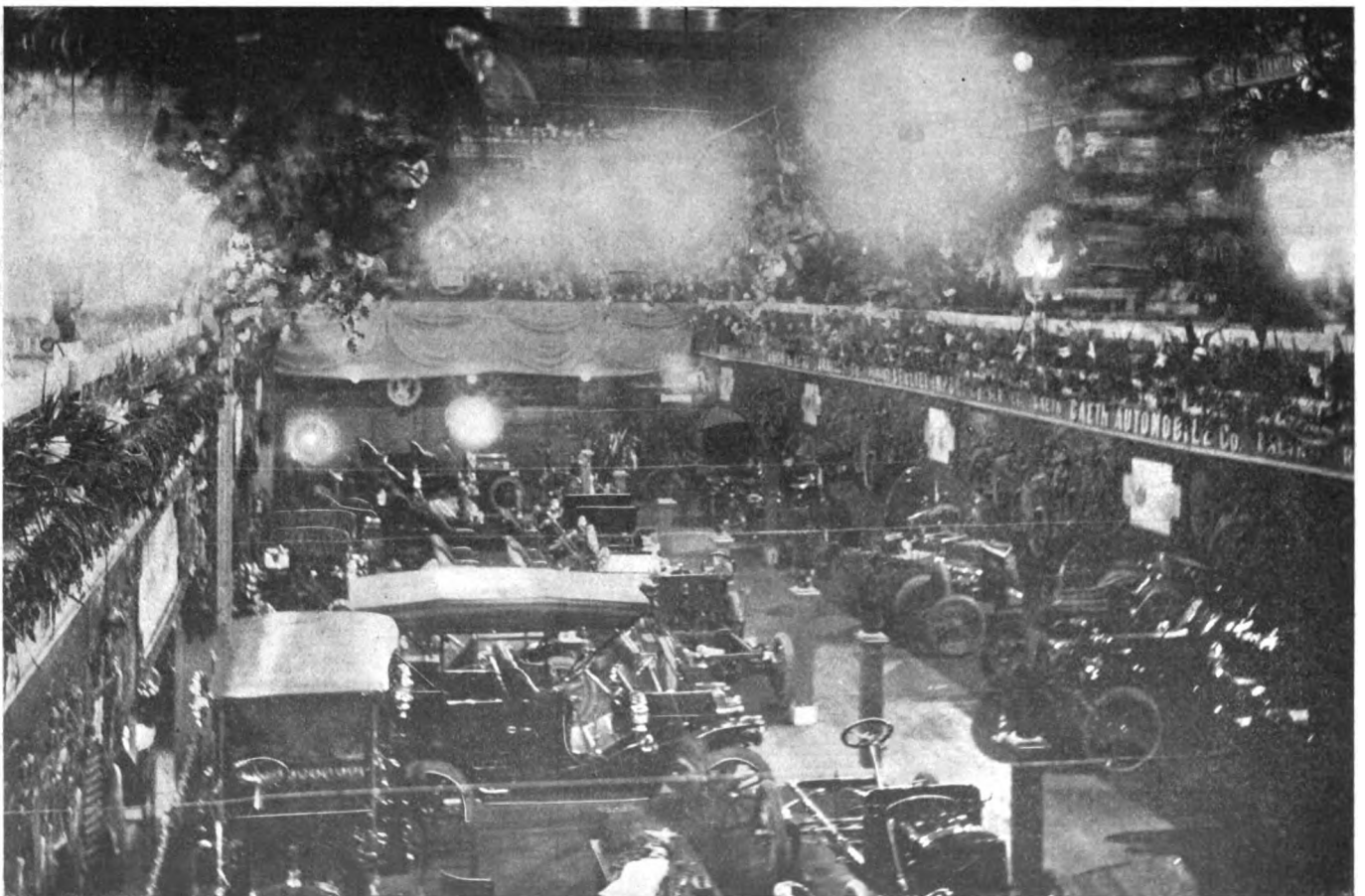

Another General View in the First Regiment Armory From a Somewhat Different Angle.



Imperial Brass Mfg. Co., Chicago, is demonstrating at its stand a new compression coupling for gasoline and oil lines which is of unprecedented simplicity and security. Each normal coupling consists of five parts—a central member, two tapered sleeves and two nuts. The central part is counterbored to receive the pipe ends, and the nuts, each of which contains one of the sleeves, are placed on the pipes before they are entered into the center part. Then, by screwing the nuts up, the tapered members wedge into the pipe in such a manner as to form in it an annular constriction, very slight, but ample to prevent separation and leakage. Besides in the form of plain couplings this connection is regularly furnished in the forms of elbows, tees, check valves, etc., in at least five different sizes. The manufacture of many other small articles in the way of turned and stamped brasswork and the like is the business of this concern, and the display at the stand of many such articles that have been made to customer's orders is most informing.

Long Mfg. Co., Chicago, though the originators of the much-used helically finned radiator tube, has added to its product conventional lines of flat tubes and cellular radiators. These latter are said to be the only ones made that can be repaired with ordinary soldering facilities. An interesting feature of this company's product is the great capacity of some of the truck and rail motor-car radiators it has turned out. A unique distinction enjoyed by its ingenious "spiral-tube" construction has been its use for years in the condensers of the White steam cars, in which the requirements are in some respects materially more severe than in ordinary radiators for gasoline engine cooling. The tables of sizes, capacities, cooling areas, etc., which occupy considerable space in the Long catalogue is a bit of engineering enterprise, the imitation of which is to be commended to competitors. In addition to radiators, hoods and sheet-metal fenders are made by this concern.

Pfanstiehl Electrical Laboratory North Chicago, offers a "fool-proof" vibrator as one of the talking points of this year's Pfanstiehl coils, and if any about a car needs to be fool-proof it certainly will be admitted that this much abused detail is a

foremost candidate. By designing for extreme high speed of the trembler blade, by eliminating movement of the platinum-iridium contact points as a means of adjustment, and by unprecedentedly close relation of condenser capacity, it is made impossible even by the most reckless tinkering to make the current consumption fall lower than 1-4 ampere or rise above 11-4 amperes on closed circuit—equivalent, of course, to much less when the engine is running. An improved lock switch is fitted to each coil box, in which the coils are assembled on the popular unit system. Non-vibrator, marine and motorcycle coils are also manufactured.

Universal Tire Protector Company, Angola, Ind., presents some of the most interesting of the Western devices in the way of ingenious and original solutions of the tire problem. Most radical is its emergency tire sleeve—in a way similar to the old blowout manchons—but it is made of metal-studded chrome leather and provided with a decided novelty in the form of a positive and adjustable mechanical anchorage, constituted of a pair of sheet-metal boxes containing double ratchet devices whereby the straps that hold the sleeve in place can be drawn to any desired tightness. Steel side bars distribute the pull along the sides of the sleeve. Advantages over laced-on sleeves, drawn tight only by subsequent inflation of the tire, are apparent. Moreover, new sleeves can be fitted to the anchorage at lower costs than prevail with laced-on types. Besides their blowout sleeves, this company is in the field with a new metal-studded tire protector, differing from others of its kind chiefly in the provision of mechanical anchorage. By applying it to deflated tire, drawing it up as tightly as possible by the ratchet-edge bands and then inflating the tire, a degree of tension not realizable by the more common method of inflation alone is attained, with consequent laying of the chief bugbear of similar devices—their tendency to work and creep on the tire.

Twentieth Century Motor Car Co., South Bend, Ind., makers of Williams' divided wind shields, are showing a thoroughly standardized product, capable of application to any type of car, and of somewhat unusual merit in that it can be set in three different positions—"down," "straight up" and "forward." The down position is with the upper half of the glass slightly lowered and to the rear of its normal place on top of the lower half, in which condition it permits raising or lowering of a cape hood. Nor does its manipulation require the dismounting of the side lamps. The so-called forward position is a new one, in which both parts of the glass are inclined, the upper slightly ahead of the lower and with an open space between. This gives ventilation, yet prevents the entry of bugs, dust and rain. The straight-up is, of course, the normal position. When the shield is not desired, it can be folded com-

pletely down to a horizontal position forward from the dashboard.

Triple Action Spring Company, Chicago, whose helical springs, in conjunction with scroll attachments have been a standby for several years past, are more added to in styles than changed in principle in this year's product. One new detail, however, is the use of a link in a very ingenious way for the purpose of stopping side motion. It seems well established that springs of this character, properly applied in connection with the stock-plate springs of a car, and correctly proportioned to the work that will devolve upon them, exercise a most marked effect in reducing spring breakage and conducing to ease of riding.

Vivax Storage Battery Company, Chicago, is convincing many of the merits of its excellent line. A feature of the Vivax batteries is the grids and plates, which is of a design exclusive with this concern; and which is so formed as to reduce to a minimum the common tendency for the active material to work out and cause short-circuiting, loss of capacity, etc. Another point upon which stress is laid is the reinforcement of the jars, which are specially strengthened at points most subject to strain. Unusual ingenuity has been expended in working out the details of venting and sealing, and as a final protection against leakage and injury every battery is sold in a paraffine-proofed oak case. Every size up to the 8-volt, 60-ampere hour type is made. Also, an important part of the business is the supplying of any and every combination of cells that can be used in the propulsion of electric vehicles. Another specialty is a novel rheostat charging set. On the whole the "Vivax" stands for real improvement in storage battery work in divers ways, amongst which will be noticed the ease with which the battery can be maintained, and the fact that it is not prone to fail in service, or become difficult to charge, when, in the course of events charging becomes necessary.

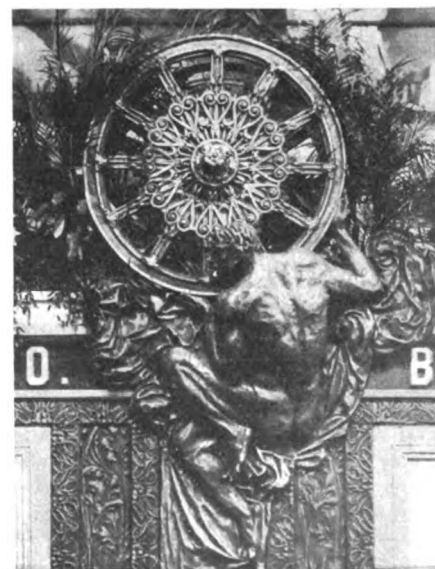

GENERAL GOSSIP OF THE BIG SHOW

Gladiators Attracted the Throngs.—At the Locomobile stand the Vanderbilt Cup winner and the trophy itself proved a pair that commanded attention, while at the Thomas exhibit the interest was no less pronounced in the "Round-the-World" car which put it all over the foreigners in that spectacular event.

Manager Miles Lucky to Have Fest.—A cold that settled in his throat put Manager S. A. Miles more or less out of the running before and during the early part of show week, and as a sequence L. L. Fest, the assistant manager, had to be at the exhibition helm much of the time. As one man remarked, "Miles was lucky to have Fest on the job," for the assistant met the requirements most adequately. At times it required fast going.

Racing Still Attracts.—There is no doubt whatever as to a continued interest in high speed contests. A. R. Pardington of the Long Island Motor Parkway was in evidence in the early part of the show before he went to Mount Clemens for a bit of rest, and the many inquiries aimed at him told a story of this desire by not a few to have some big events in the metropolitan district. "Pardy" answered all queries successfully, and one hopes his optimism will become true in the early spring.

Woods Company's Good Smoker.—Wednesday night the Woods smoker and Dutch luncheon, at the new and completely equipped factory on Calumet avenue, helped to keep many a pleased show participant out of his bed until an early hour. The vaudeville was unusually good. The master of ceremonies was Carl Metzger, who is greatly responsible for the innumerable Woods electrics about the streets of Chicago.

Of Course Reeves Was There.—No matter when or where it may take place there will be always found at any notable automobile event the indomitable and ever-busy Alfred Reeves, whose success with the management of the A. M. C. M. A. is a story known to all automobiling. Mr. Reeves frankly admitted that the Chicago show had won the medal on decorations.

"Van" Selling the Knox.—One of the most visited stands was that of the Knox, the Chicago branch of which is now under the management of N. H. Van Sicklen, veteran of two industries, but until recently always in the publishing field. "Van" takes to the selling of cars as naturally as he did to looking after the business destinies of *Bearings* and later of *Motor Age*, which means that there will be many Knox cars in and about Chicago very soon.

Among Those Present.—The list was a long one of the notables of the industry. For instance, one trio would include "Joe" Tracy, widely known for past racing prowess; Otto Nestman, an early Stevens-Duryea performer and now with its Omaha agency; and "Teddy" Dey, the Pierce pilot of Glidden tour fame.

Maxwellites Have a Dinner.—As usual the Maxwell-Briscoe Company entertained its agents at the show with a dinner, this taking place to-night at the Auditorium. Many were present from some distance.

Route of the Glidden Tour.—This is a question that cannot be answered at present. Chairman F. B. Hower is besieged with delegations and letters. One idea that is finding favor is Chicago to Milwaukee, to Minneapolis-St. Paul, and to

Denver, with a return taking in Kansas City, St. Louis, and Indianapolis. There is much sentiment for a start in Detroit. Whatever the route, there will be heartburnings.

Annual of Chicago's Trade Association.—As a sort of a preliminary to the Chicago show, the Chicago Automobile Trade Association held its third annual banquet Friday night at the Chicago Automobile Club, which was attended by 60 tradesmen, within 10 of the full membership of the association. It wasn't all trade talk at the dinner, though among the speakers being Ira M. Cobe, president of the Chicago Automobile Club; John Farson, ex-president of the Chicago Automobile Club, and Alderman Milton J. Foreman, who also is an enthusiastic autoist. The tradesmen were represented in the talkfest by Thomas J.

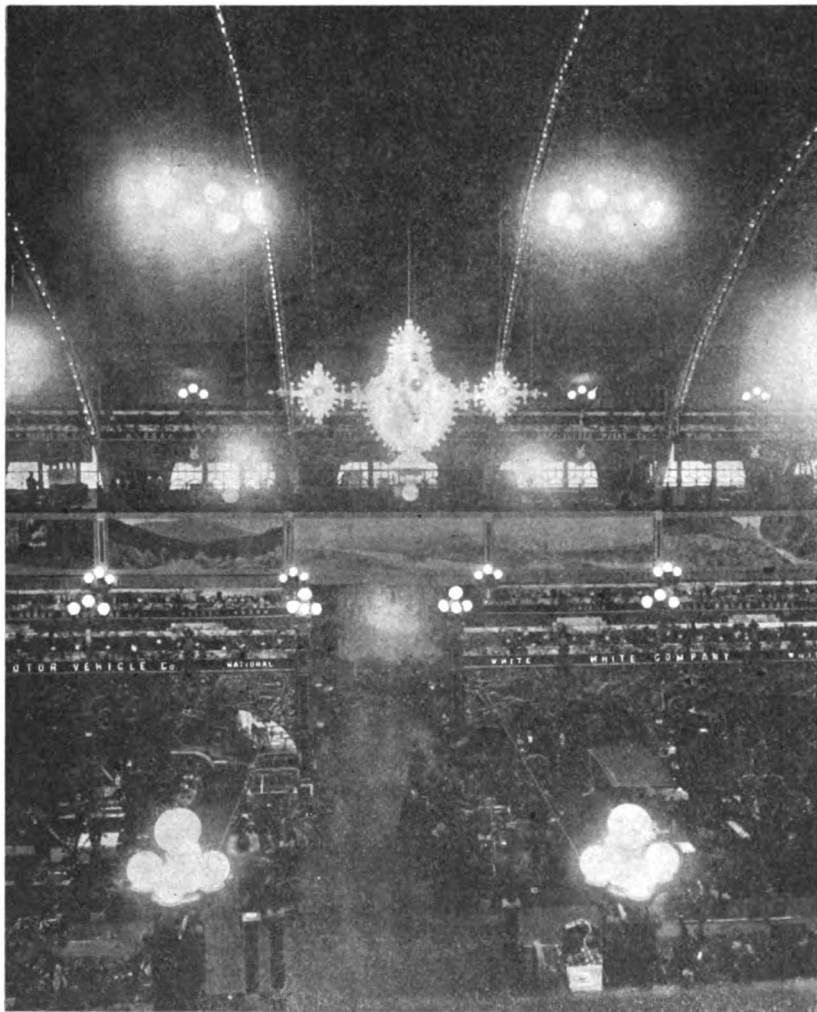

Where the Central Lateral Aisle Divides the Coliseum.

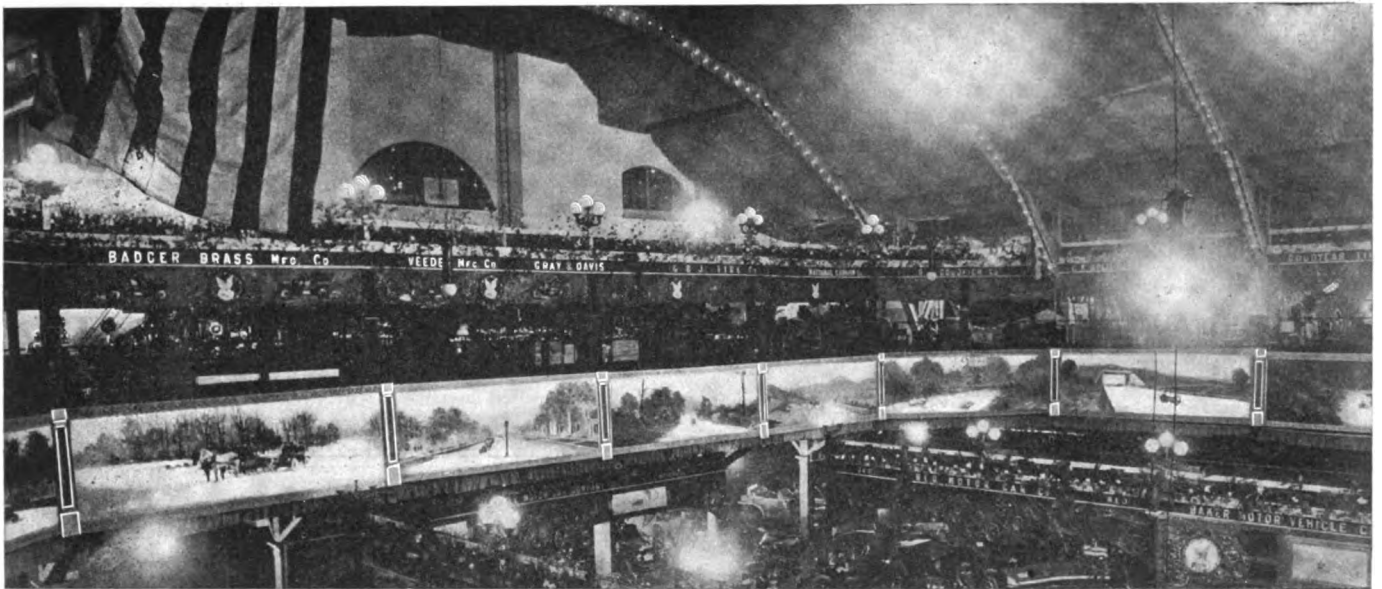

Where the Accessory Exhibits Were Located in the Coliseum Mid Flag-Draped Galleries.

Hay, the Ford branch manager; Ralph Temple, the Jackson agent; Charles E. Gregory, representing the taxicab interests, and Joseph F. Gunther, of the Apperson agency. Walter Githens, president of the trade association, was toastmaster. The affair was given added importance by the announcement of Mr. Cobe of his tender to the A. A. A. of a trophy for the national stock chassis race. Alderman Foreman made a witty speech, in which he declared the motor car was revolutionizing the world and told how strong it was with the city administration. Speaking of road racing, he declared he was greatly interested in it; that he saw lots of road racing right on Michigan avenue.

Moline Farmer's Interchangeable.—The Moline Automobile Company, of East Moline, Ills., has designed and built a car particularly for the farmer. This is the new Moline Model H, which sells for \$1,500. It has a road clearance of 14 inches, when equipped with a double side-chain drive, and has a detachable tonneau, making the rear deck available for carrying purposes when the seats are removed. "The farmers of the Middle West have not been slow to realize the value of such a car," says

W. H. Vandervoort, sales-manager of the Moline Company, "and we are having a splendid success with the new Model H. For city use, we equip the same car with a shaft drive. 'The Automobile on the Farm' is the title of a booklet describing the machine in detail, which we have been sending out broadcast." In addition to its complete line at the Coliseum, the Moline Company will hold an overflow show at its Chicago salesrooms, 1220 Michigan avenue.

One of the Latest Franklin Ideas.—One interior-driven motor car is to be shown by the Franklin Company among its 1909 models. This is an 18-horsepower brougham, built upon the same chassis as the Franklin touring car of the same power. It is an adaptation of the doctor's closed carriage and is made to suit those people who insist upon the comfort and protection of a closed carriage and who yet want to do their own driving. It carries two people. The finish is in Franklin standard colors. The trimming of the interior is of goatskin with blue broad lace. The appointments are simple, as this class of motor car is made to specially meet the requirements of the business and profes-

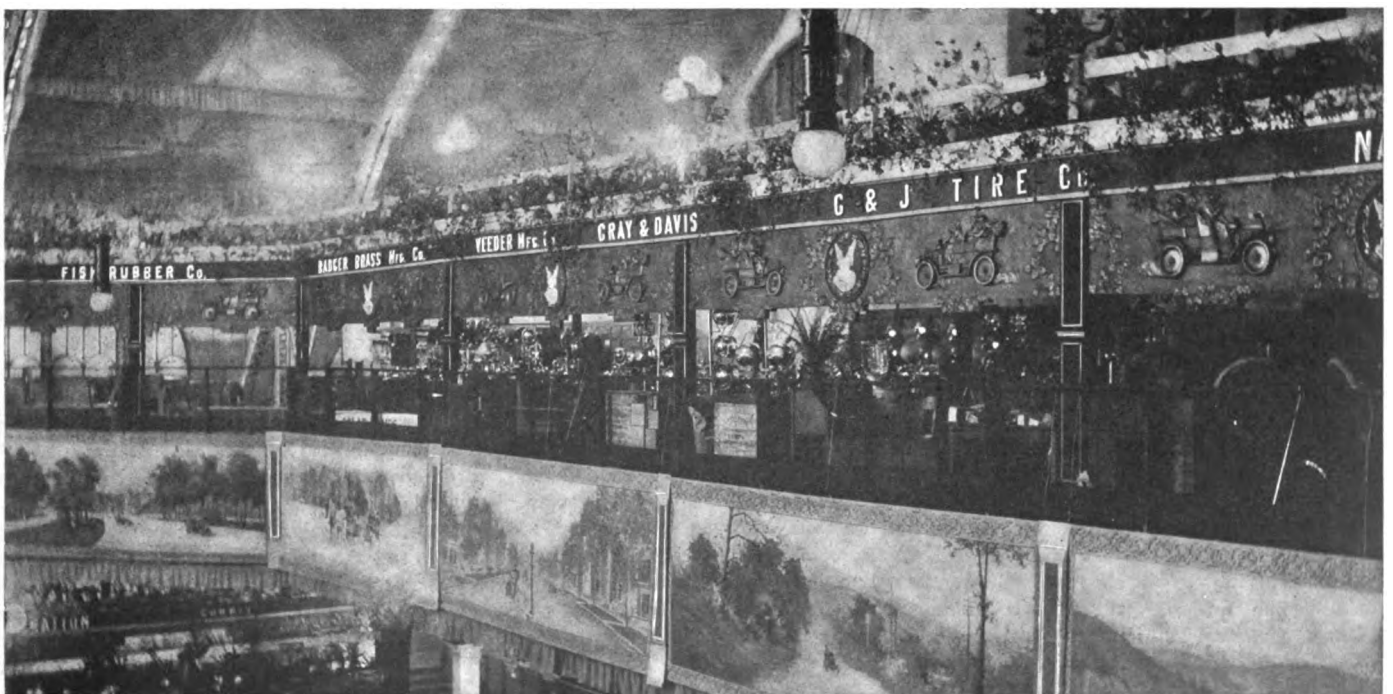

Mural Decorations Waylaid the Eye Approaching the Galleries Where the Accessory Displays Were Massed.

sional man, and the need is for good service under hard usage. There is a small front extension of the top, affording protection when the car is being driven with the front window partly open, and this in addition protects the glass during severe storms. All the glass frames are made to either fold up or drop into grooves. These frames are of mahogany of natural finish. The mudguards are of the conventional long curved pattern. A rear guard is made with the wing on the inside to thoroughly protect the body. The use of an ample chassis permits provision at the rear for a good sized receptacle.

DETROIT AUTO SHOW OPENS NEXT WEEK.

DETROIT, Feb. 8.—Next Monday evening Detroit's "biggest little" automobile show will be thrown open to the public, and local enthusiasts will be given their first opportunity to inspect all the new models under one roof. The members of the Detroit Automobile Dealers' Association, who organized the show, say that the time-honored term "biggest little" no longer expresses the situation accurately. In proof that the show is not little, they assert that there will be upward of 200 cars on the two floors of the Wayne Casino, in addition to the latest in commercial vehicles and motorcycles.

The scheme of decorations includes the conversion of the lower floor into a Venetian garden, where hundreds of canaries will provide music, in addition to a large orchestra. More than a score of immense landscape paintings will form the background. The list of exhibitors follows:

Automobile Dealers.—American Electric Auto Co.; Anderson Carriage Co.; Ashley Pond, Jr.; J. H. Brady Auto Co.; Brush Runabout Co.; Buick Motor Co.; Cadillac Motor Car Co.; Cartercar Co., Pontiac, Mich.; Coombs & Gilmour; Everitt-Metzger-Flanders Co.; C. B. Fear Auto Co.; Ford Motor Co.; Grant Bros.; Hupp Motor Co.; W. G. Isbell; J. B. McIntosh; Maxwell-Briscoe-McLeod Co.; Wm. Neuman & Co.; Olds Motor Works; Postal & Doherty; Rapid Motor Vehicle Co., Pontiac, Mich.; Rumsey Electric Co.; J. P. Schneider; Seidler-Miner Automobile Co.; Seitz Auto & Transmission Co.; Standard Auto Co.; H. H. Thorpe; Winton Motor Carriage Co.

Accessory Dealers.—Auto Accessories Manufacturing Co.; Auto Equipment Co.; H. W. Brown; Gemmer Manufacturing Co.; General Sales Co.; Gisholt Machine Co., Madison, Wis.; H. W. Johns-Manville Co.; Fred Kicherer; Martin Meler & Co.; W. E. Metzger; Michigan Storage Battery Co.; Miller Storage Battery Co.; Modern Machinery and Engineering Co., Cleveland, Ohio; New Process Steel Co., Marshall, Mich.; Rochford Mfg. Co., Chicago, Ill.; J. B. Trossell; United States Spare Wheel Co.; Wm. E. Wandersee; Wayne Chemical Co.; Westinghouse Co.

MILWAUKEE SHOW MAKES PREPARATIONS.

MILWAUKEE, Wis., Feb. 8.—The first annual show of the Milwaukee Automobile Club will be held in the Hippodrome from March 11 to 13, and the club members are waxing very enthusiastic over the plans. Clarke S. Drake, president of the club, has been appointed general manager and is carrying the arrangements along at a pace that will insure results.

The main floor of the big building will be used for exhibits of cars and the galleries for accessories, parts and tires. Each exhibitor must show at least two cars or chassis for the space assigned him. Allotments will be made by drawing on February 15. The club will furnish all signs and decorations, to insure uniformity and a harmonious scheme.

MONTREAL CLUB TO HOLD AUTOMOBILE SHOW.

MONTREAL, CAN., Feb. 8.—Although it has generally been understood that there would be only one automobile show in Canada this year, and that in Toronto, the Automobile Club of Canada at its meeting last Saturday arranged to hold another show some time in April. It is considered that the date of the Toronto show is entirely too early. The club has also invited the mayors of the municipalities along the Lake Shore road to a meeting next Thursday, at which they will consider how to avoid any inconvenience from the use of automobiles on the driveway.

NEWARK SHOW IN THE FOREGROUND.

NEWARK, N. J., Feb. 8.—In view of the large list of the most representative companies who have signaled a willingness to render support to the enterprise, and in further view of the fact that every one in Newark is awakening to the fact that the industry is thoroughly represented there, it will come as no surprise to the well informed of the industry to learn that the entire available space has been assigned, barring room for a couple of cars and some accessories.

The undertaking is a big one, and in view of the fact that opening night is less than two weeks away, it is plain to be seen that a little "ginger" will have to be injected into the workers, a supply of which is bound to rest in the maw of the management, evidences of which are bound up in energy which is spilled lavishly in every direction savoring of good.

There will be so many "special nights" that the opening and closing nights may be the only regular sessions. At all events, the present outlook includes "Essex Troop" night, New Jersey Automobile and Motor Club night, etc., and enthusiasm runs high, particularly in view of the splendid display which is all that can happen in view of the list of exhibitors as they are here given.

Concern.	Car.
The White Co.	White.
Ellis Motor Car Co.	Pierce-Arrow.
Paddock-Zuel Motor Car Co.	Chalmers-Detroit.
Motor Car Co. of New Jersey.	Cadillac.
H. J. Koehler.	E. M. F.
J. W. Mason.	Maxwell.
Greene Motor Car Co.	Locomobile.
Carl H. Page & Co.	Peerless.
F. L. C. Martin Auto Co.	Mitchell.
O'Neil Motor Car Co.	Reo and Premier.
D. B. Dunham & Son.	Auto bodies.
Brush-McLaren Motor Co.	Brush.
Weldon & Bauer Co.	National and Kissel Kar.
Cordner, Flinn & Toppin.	Acme.
Overland Motor Car Co. of N. J.	Overland.
Crawford Auto Co.	Crawford.
Oldsmobile Co. of New York.	Oldsmobile.
Rickey Machine Co.	Marmon.
A. G. Spalding & Bros.	Stevens-Duryea.
Rambler Auto Co. of N. J.	Rambler.
Atlantic Motor Car Co. of N. J.	Stoddard-Dayton.
J. M. Quinby & Co.	Isotta and Pennsylvania.

ACCESSORIES.

Concern.	Address.
The National Oil and Supply Co.	Harrison.
The Adolph Karl & Co.	Permanit.
Union Battery Co.	Belleville.
N. Y. Auto Top and Supply Co.	Newark.
Empire Tire and Supply Co.	Newark.
Electrical Maintenance and Repair Co.	Newark.
Perfection Wrench Co.	Portchester, N. Y.
H. J. Koehler Sporting Goods Co.	Newark.
Orange Machine Co.	Orange.
W. S. Sheppard.	Newark.
Dayton Rubber Manufacturing Co.	New York.
B. F. Howard, Motorcycles.	Verona.
Standard Oil Co.	Newark.
Standard Leather Washer Mfg. Co.	Newark.
Hydro Carbob and Machine Co.	Newark.
Auto Tire and Repair Co.	Newark.
Welsh Grape Juice Co.	New York.
Ennis Rubber Manufacturing Co.	Newark.

INDIANAPOLIS DEALERS' WEEK, MARCH 22-28.

INDIANAPOLIS, IND., Feb. 8.—Plans for the largest celebration automobile men have ever had in the city are being arranged by the Automobile Club of Indiana. The Indianapolis Automobile Trade Association, under whose auspices such affairs were formerly conducted, was recently consolidated with the club.

An opening week will be observed from March 22-28, and during the week a number of interesting events will take place. These will include a parade on the opening day of the week, in which owners, dealers and manufacturers will participate. On following days will be given a banquet, endurance contests, novelty races and a hill climb.

Throughout the week each dealer will exhibit 1909 models in his own establishment, and the show rooms will be attractively decorated. The committee making arrangements for the week is composed of F. I. Willis, of the Hearsey-Willis Company; Frank Moore, of the Fisher Automobile Company; B. W. Twyman, of the Motor Car Sales Company; D. B. Sullivan, of the Sullivan Automobile Company, and Cecil E. Gibson, of the Gibson Automobile Company.

TECHNICAL ADVANTAGES OF UNDERSLUNG CHASSIS

By CHAS. E. DURYEY, TECHNICAL EXPERT, A. M. C. M. A.

ONE of the "stylish" features of the earlier types of autos was the high position of the body and riders, but as the purchasers became better acquainted with the speeds possible by the new vehicle, they saw the advantage of low center of gravity, and makers have been each year catering more and more to the demand for low-built rigs. The ability of the vehicle and the comfort of the passengers are both increased in many respects by low mounting, although, of course, some other desirable features are lost. The low vehicle is safer and less likely to overturn as the result of a skid or in case of running into a ditch, curb, etc. It offers less wind resistance and so is more pleasant to ride in at speed. On roads that are not perfect the side swaying is less because of the lessened radius, which adds very materially to the comfort of the passengers. The strains on the wheels in turning or on sloping roads are less. Mounting and dismounting are handier and easier. With no horse in front and continuous guards from one end to the other and one

a great number of the frames of the chasses are dropped or curved, so as to be low between the wheels while rising high over the rear axle or from in front of the rear axle to the full rear. This type of frame is found on the American Simplex, the Midland, the Marmon, the Mora, the Moon, the National, the Pennsylvania, the Regal, the Pullman and the Welch cars in some or all of their models.

Natural Advantages of the Underslung Frame.—On the American cars the problem is worked out to the fullest by carrying the frame under the axles and springs, producing what is undoubtedly the lowest center of gravity vehicle in the automobile trade. There is, of course, no mechanical reason against such hanging, and the spring action cannot be other than excellent. The added comfort and safety at speed must be very evident and the style of the workmanship as well as the originality of design make this departure well worthy of study. As the needs of the various types of buyers become better known

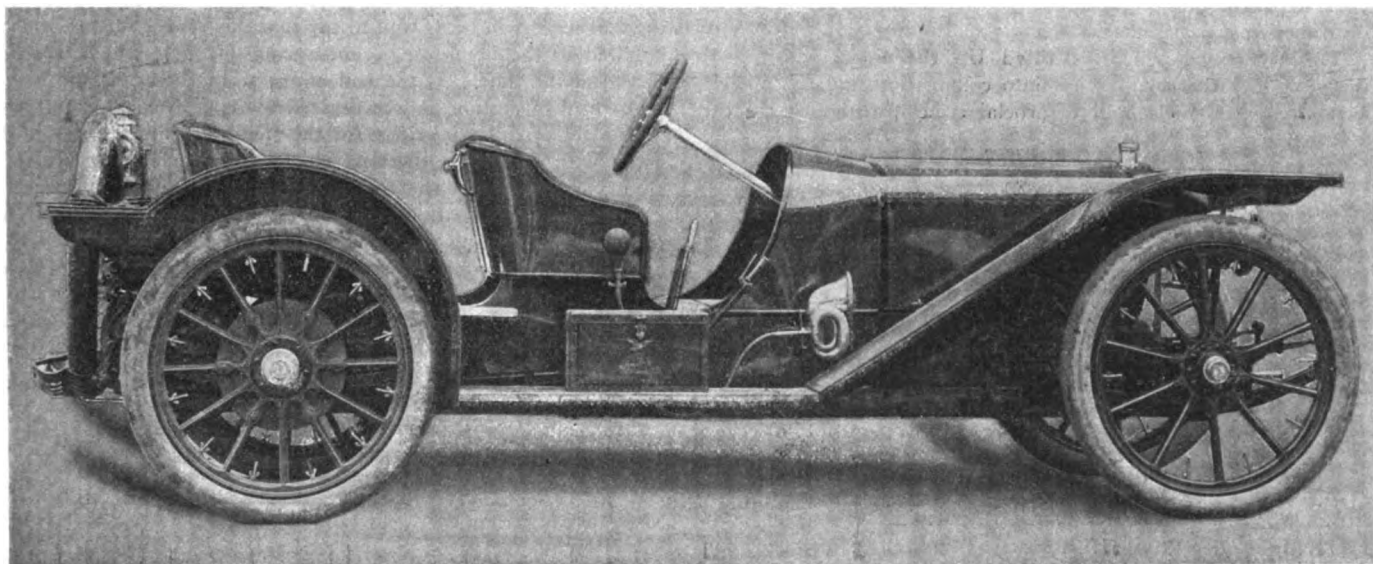

American Roadster, Showing the Underslung Frame Construction with Wheel Diameters for Adequate Road Clearance.

side to the opposite, there is no need to sit high to escape the mud and other undesirable things found near the ground. With high speed there is no need to take the other fellow's dust very long, so even this reason for sitting high is absent. The ability to see is less and the appearance is not so impressive, but these decidedly horsey features are small loss compared with the many gains.

Low Center of Gravity Desirable.—For years low center of gravity with these advantages has been advocated by leaders, but makers found it difficult to comply fully. The complicated mechanism of the past required all the room available under the floor of the vehicle, and it seemed easier to mount the passengers high than to adapt the motors to the proffered low body arrangement. With the moving of the motors to the front the one great obstacle has been eliminated and the conventional auto now has its floor but little above the crankshaft level of the motor. The steady increase in wheel sizes had its effect also, for axles must have room to rise, and until the foreign makers set the pace American makers were many against changes of frame which would permit low carrying of the passengers and also large wheels.

Merit, being immortal, finally won, and to-day we find practically all makers of the larger and speedier vehicles using 36-inch wheels, while some like the Gaeth and the American Traveler have wheels as large as 38 and 40 inches. To permit this practice

to the makers and to the buyers themselves, special features securing valuable results not secured by the average type of construction will become more common, and makers will gain for themselves a class of followers by this specialization that will take their product without the necessity of keen competition, as must result if the market for average goods is overfilled.

Not only are autos designed with fewer parts, but the parts are better protected from the mud and dust, so the low-hung chassis is not objectionable, while as roads become better each year the necessity for clearance is becoming less. Racing autos have long been built on these lines and the builders who copy them are but following the lessons taught on the track and course.

AERONAUTICAL NOTES FROM GERMANY.

BERLIN, Feb. 1.—Two new German airships are rapidly nearing completion, the one being the work of the celebrated Duerkopp firm and fitted with two motors, while the other is being built by the well-known engineer, Dr. Huth, on the three-decker principle. Trials will be made with both early in the Spring.

The vicinity of Zurich will be the start of the next Aero Gordon Bennett event, which the Swiss Aero Club now has to arrange. Entries for the race, which will take place about the end of September, close on March 15.

CONCLUSIVE EVIDENCE OF AUTOMOBILE ECONOMY

29,000 miles at a cost of \$90 is the upkeep record of one automobile and it is probably one of the most interesting facts which ever come to the surface. In view of the fact that the earlier records of cost of maintenance were sometimes quite high, and in further view of the proneness of men to mention the things which impress them most, it generally happens that the cars which went about their business failed to receive mention, while the cars which run up a repair bill were mentioned in song and story time and again.

When an authentic record such as this is open to inspection then it belongs to the class of incidents which entitles it to space—nay, preferred space, which in a newspaper is reserved for the matters that compel respect. In this case W. L. Lewis pleaded guilty to having engaged a good chauffeur for his Thomas car—a regular stock four-cylinder sixty—and that he would know something about the cost of maintenance it was his custom to “count the cost.” That the chauffeur, A. Douglass, did influence the situation in favor of good performance merely goes to show that the cost of a good chauffeur is by way of insurance of the character which weighs heavily in favor.

Twelve Thousand Miles Piled Up the First Season.—In the year 1907 the car was put into commission and the mileage as above given made bold to proclaim the qualities of the car,

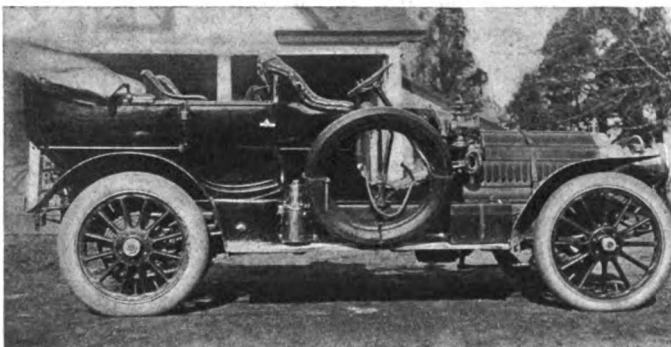

W. L. Lewis's 60-H.P. Thomas Always Ready to Run.

especially in view of the fact that each additional day lent confidence, and of service interruptions there was none, while the cost, as it was computed at the end of the season's service went to cover “precautions” to a large extent, although it is true that prudence dictated that the motor bearings be adjusted for slight wear, then it was desired to retain the noiseless performance of the car which was done at the expense of a new set of sprockets; moreover, in going over the car very carefully it was considered that the front wheel bearings were slack and replaced.

With the season over, the chauffeur went over the car with the care born of much skill and a desire to distinguish himself from the class of men who pretend to be competent, but who fail to make good, with the result that the motor was carefully overhauled, the cylinders were cleaned out, valves ground to a tight seat, oiling system overhauled, piping gone over, etc., thus rendering the motor as “sweet” running as the day it came from the maker. Likewise, the clutch was treated, not that it absolutely required attention, but the chauffeur went into the matter in a way to prove that it really does pay to have a good man, even at the cost. With the transmission up to a fitting standard, the car as a whole as clean as a whistle, the first year of service footed, in point of cost, up to the following:

SUMMARY OF FIRST YEAR'S COST OF REPAIRS.

New set of sprockets.....	\$30
Front wheel roller bearings.....	10
Total	\$40

Considering the fact that the first year's service was largely in the winter time (the winter of 1908), it will be rendered quite plain that the cost was very low, indeed, and it was expected that

something by way of an increase would be rendered manifest within the distance of travel of a few thousand miles when the car was put back to work in the Summer of 1908.

Seventeen Thousand Miles Was Made the Second Season.—Despite the arduous service of the first year the car exhibited rare touring qualities during the last year, in which the mileage exceeded the first year by 5,000 miles, and at the close of the season it was decided to give the car the benefit of a good overhauling, which the chauffeur undertook and carried it to a successful termination. The same man did all the work from the start, and it is interesting to note that in making repairs, while he did replace parts much the worse for wear, the fact remains that he made adjustments rather than replacements in nine cases out of ten, thus showing that it is not necessary to go to great expense in many cases, if only the chauffeur is competent.

With an idea of showing the extent of the service it will be pointed out that the brake drums on the rear road wheels had to be turned down (trued up), because of the amount of work the brakes were suffered to do in the 29,000 miles travel. Before going farther it will be as well to say that this same arduous service resulted in the breakage of one spring (front), which was replaced at the time. At the end of the second year, as the result of careful inspection, it was decided to replace parts as follows:

One set of roller bearings for the steering gear in order to do away with some lost motion, which is so undesirable, even if slight, as to warrant the cost of doing away with it.

One set of camshaft bearings in order to bring the motor up to the sweet running condition which obtained at the start.

One pump gear, which was considered below a fitting standard, but not of necessity gone.

All the replacements of the second season run into costs as follows:

SUMMARY OF THE SECOND YEAR'S COST OF REPAIRS.

Front spring	\$18
Roller bearings, camshaft bearings and pump gear.....	30
Extra spring clips.....	2
Total	\$50

RECAPITULATION OF ALL COSTS FOR 29,000 MILES.

Paid out during first year.....	\$40
Paid out during second year.....	50
Paid out total.....	\$90

It will be observed that the whole performance showed that the car did not get into serious trouble at any time, and it is true as well that the repairs made could be far more expensive in the absence of a man who saved the situation. The incidental costs of running the car were very fair, indeed, in that besides \$0.0031 per mile, cost of repairs, the gasoline bill was on a basis of 11 to 12 miles per gallon, while the lubricating oil bill footed up on a basis of 150 to 160 miles per gallon. On a few occasions the lubricating bill fell off to 200 miles per gallon, but the average was as above given.

The question of the tires is one which will have to be dealt with in a general way, but it is fair to say that the front tires run fully 5,000 miles, while the rear tires lasted for 4,000 miles at least. The rear tires were made to do additional duty by re-treading, and the tire repairs were well attended to in the main. On the whole, it is fair to say that much of the good performance was due to the fact that “a stitch in time saves nine” and the chauffeur was alive to the fact.

As a fair indication of the system used in connection with the up-keep of the car it is only necessary to relate that the connecting rods were examined and taken up, if necessary, every 5,000 miles, while the valves were ground in every 6,000 miles, and the brakebands received attention every 7,000 miles, and so on. There was a set time for the performance of each of the duties, and while it was not always necessary to do work, it was considered desirable to examine into the condition which obtained and by so doing ascertain if aught was awry.

TREND IN TRANSMISSION PRACTICE

By Thos. J. Fay

Chapter II

UNDER the circumstances, if carbon steel is to be used of grades higher in carbon than the composition which will admit of case-hardening, the carbon must be high enough to engender the requisite surface hardness as the result of quenching and tempering, in the absence of the carbonizing process. That the carbon must be much above the point as above given for cementing steel is assured, an illustration of which was given.

Without going into the question of the results due to further heat treatment, at this time, it is to point out that the safe limit for carbon content is fairly represented in the range given, and if the steel as shown in the test is in the best state to which it can be reduced, from the point of view of "normal steel," or if there is a certain uniformity of degrees of superiority, then it is plain that the difference as between carbon low enough to allow of "cementation" and the highest carbon content recorded above does not afford a sufficient difference to render it clear that any other mode of heat treatment will suffice for the purpose, considering carbon steel.

By cementing (in a suitable manner) the steel of the lower carbon, including the specimens, numbers 1 and 2 would be of such strength as to serve for gears, whereas none of the products given would develop strength up to the requirements as the result of any other form of heat treatment. On the other hand, with the carbon content above that given in specimen number 2, a crystalline structure would follow the cementing process to a certain extent in every case, and to a marked extent in enough cases to spell failure for the users of the steel.

It is especially noticeable that in steel with the carbon content between 20 and about 28 points, crystalline structures develop in the cementing process, especially if the steel is basic, more particularly if it is Bessemer as well. Why this is so can be explained to a fair degree of satisfaction, but this is not the time to launch into the broad question of the differences in the several qualities of the respective grades of steel.

In the steel as given in the tables above, it is plain that it is a fairly pure product in the main, excepting that the manganese is quite high, which accounts for the strength in some measure. It is not the purpose here to claim that the composition as given is absolutely the best to be had for gears, but it has the value of having been selected by a metallurgist of recognized ability, for test purposes. With a view to a better understanding of the manner in which the products given were referred to, and used in the tests by W. F. Harboard, it will be desirable to quote from the paper, as read by him, as follows:

"So many methods of testing steel by impact have been suggested by engineers during the last few years that it has become a matter of importance to investigate the value of these tests as compared with the ordinary tensile tests which in the past it has been customary to rely upon largely, and also to compare the better-known methods of impact testing with each other to see which gives the most concordant results.

"The experiments recorded in this paper were undertaken (1) to compare the results obtained by different methods of impact testing; (2) to see whether such tests detected any irregularity in steel not revealed by the ordinary tensile tests, and to what extent they were in agreement with the latter.

"With this object in view three very high-class Sheffield steels were originally selected, and are referred to as 'Standard steels,' but as the work proceeded it was considered desirable to include a

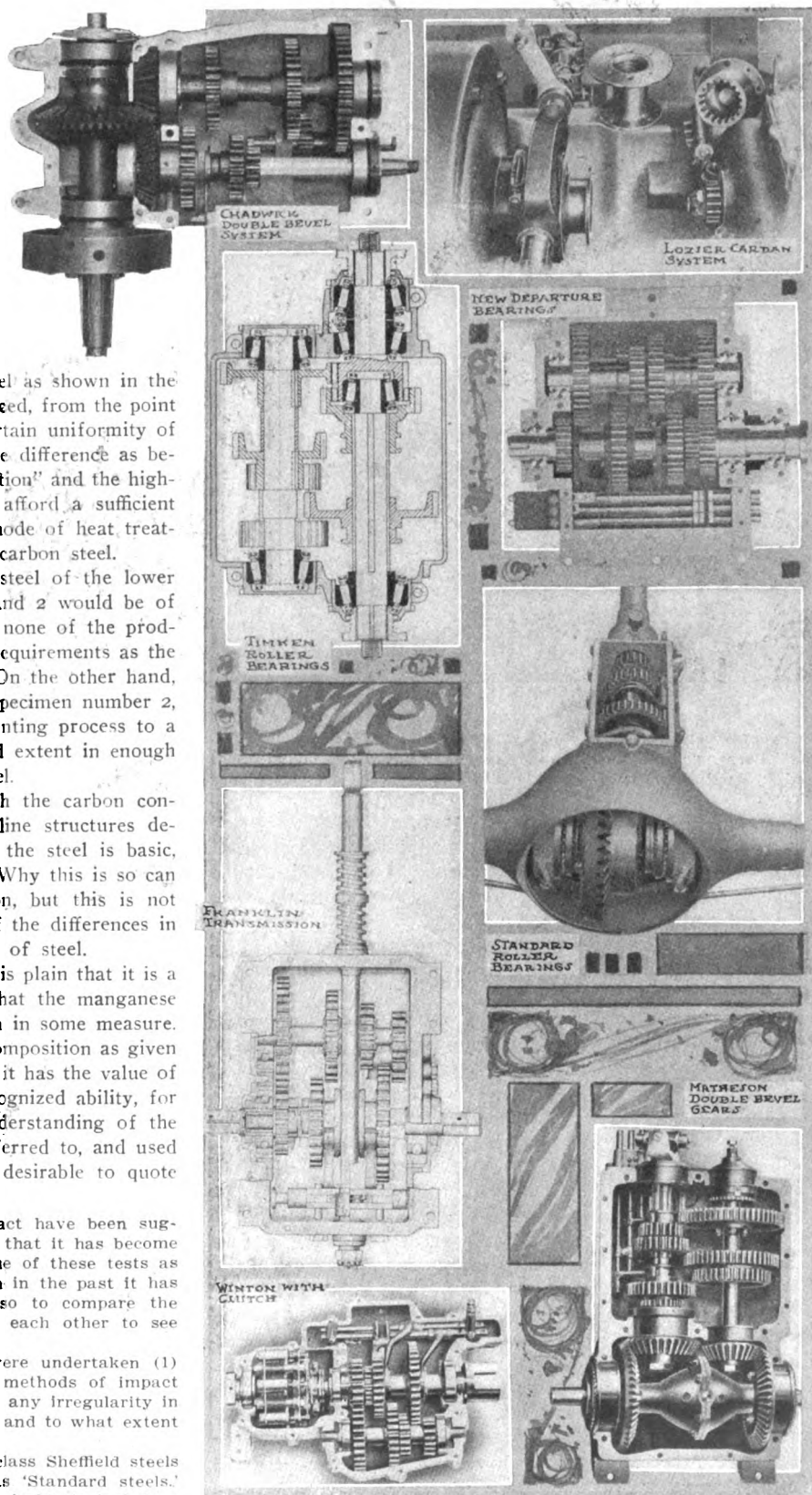

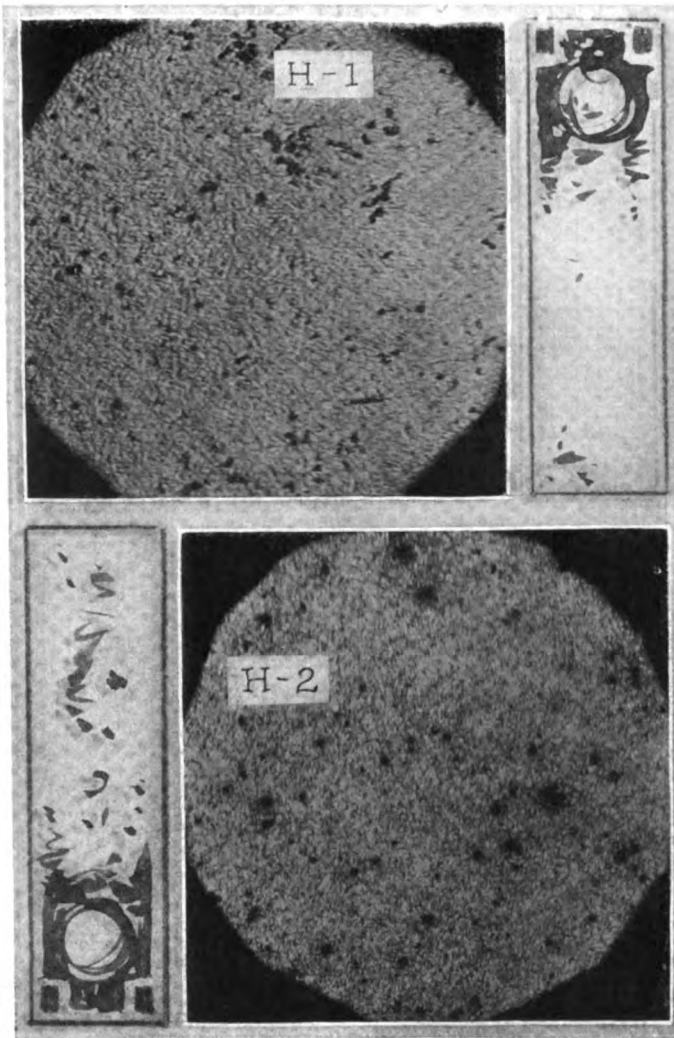

series of steels made by the Acid Bessemer, Acid Open-Hearth, Basic Bessemer and Basic Open-Hearth processes, so that all steels used by engineers for structural and railway work could be considered.

The acid open-hearth steel as referred to in this discussion was selected for the purpose of determining as to the mode of fixing the effect of "impact" induced in divers way, and that the steel is a fair selection can be taken for granted. In this connection it may be well to point out that "clash gears" are subject to impact to a vast extent, moreover bending moments are predominant to an extent which oftentimes makes for a near approach to the elastic limit.

There is no doubt of the ability of carbon steel, low in carbon (cemented), to serve well for the purpose, if the material is of the acid open-hearth genera, well fabricated, or if the steel is of the crucible process, and comes from "cut" or "cement bars," not of the basic process. If Bessemer steel is used in the crucible charge it is extremely difficult to see wherein the resultant crucible steel is to take rank with acid open-hearth steel, if the composition of the same is low in the metalloids and otherwise unsuited to the work to be done.

In general, according to the methods of reasoning as here utilized, there are two prime considerations: (a) the steel, no matter what the composition, should be from selected ore and scrap, reduced by the acid process; (b) the carbon content should be such as to render the "cementing process" necessary and practicable. These prime considerations take into account the use of the steel in gears, to be used as sliding gears, in automobile work. When opportunity affords, it will be the aim to show that tests are frequently quite unreliable, especially shock or impact tests, whereas none who have had wide experience will be willing to assert that increasing carbon will have any other

effect than to decrease ductility, which is most undesirable.

Referring to a long series of carefully conducted tests, using all the known methods of ascertaining the shock ability of special and commercial steels, Harbord ended by saying: "The results cannot be regarded as anything but most unsatisfactory, as there can be no question that as the percentage of carbon increases the ductility decreases." There are many cases of record in which attempts have been made to render inferior carbon steel suitable for use in exacting work. That such attempts have been followed by any very good results has not been shown, yet ever so many have been deceived by the fact that the failures were not flat, or at their expense.

In the automobile zone of activity, involving sliding gears, success has followed the use of "acid" steel, low in carbon, cemented; or low in carbon (alloyed) and cemented in some cases. In other instances it was possible to take advantage of other than the cementing process, through the use of alloys such as would engender the requisite hardness, holding the carbon content low enough to eliminate the ills of carbon to any marked extent. If it were possible to give the exact early history of the development of transmission gears, it is believed that history would disclose a vast percentage of the failures as the direct result of the conditions as follows: (a) the use of basic steel, high in carbon, heat treated to engender further rigidity; (b) the use of alloy steel, in which the same basic faults would be found, and in which the "elongation" is, say, 2 inches, fell below

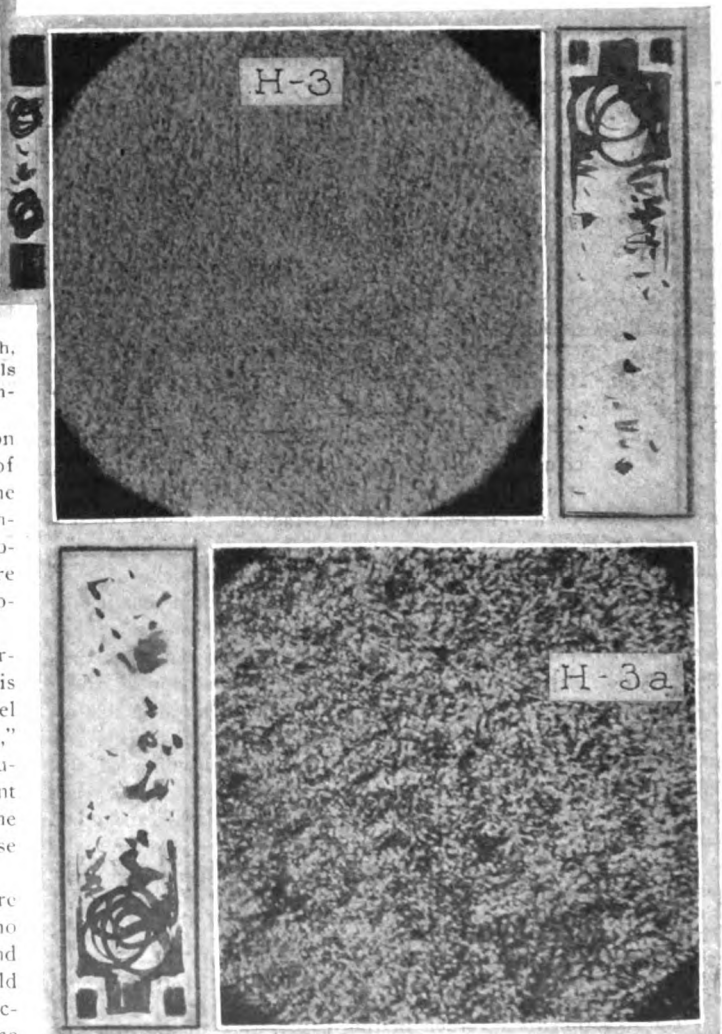

10 per cent. after heat treatment. This question of the heat treatment is one which must be considered from two points of view, for if the steel is cemented and the core is found to hold the requisite qualities, then it is assured that the hard shell is

not at the expense of the dynamic ability of the steel as a whole. If, on the other hand, as a result of quenching and subsequently tempering, the steel evinces a marked falling off in the elongation, it is quite likely that the dynamic life will be short, and in gear work it would be just as well to tool steel, in which failure is assured if it is put into gears.

In the earlier days of the automobile, when it was not well understood that cemented mild steel gears would well serve the purpose, tool steel was used to quite some extent, and the result was a crop of failures which could not be accounted for, although the fact is that some of the steel cost as much as one dollar a pound. It is easy enough, then, to account for the fact that the transmission gearsets as they obtain at the present time can cost very much less than ever before.

Relative Advantages of Alloy Steel Products.

From what has been said it might be thought that alloy steel is not desirable or necessary in work of this character. On the other hand, it is a fact that a vast number of the examples of gearsets used and illustrated in this article are made up with alloy steel gears. They serve so well as to render them above discussion, unless to point out the presence of quality residing within them.

It is the problem of the designer to determine the section of the members, after having decided upon the materials which are to be used. Generally, it is the practice to select the materials, ascertain their characteristics as a result of careful tests under the several conditions likely to obtain in actual practice. By way of illustrating the situation it will be enough to give just such a set of tests as would enable a designer to determine the limiting values of the products in a given service.

It is certainly not necessary to use the same grade of material in all the gears of a transmission system, as, for illustration, the "master gears" do not clash, and they would not have to be of alloy steel of a fine grade, even in the cases using alloy steel for the clash gears. The great gain in recent times was made through the appropriateness of selection, and through the suitable treatment of the steel used in the several parts, considering the service. As a further indication of the extent to which materials can be spread out it is to consider the arduous service of the low-speed pinion in which the material cannot be too good. On the other hand what would be the use of using such fine material in the mate to the pinion? If the pinion with perhaps 14 teeth will do the work, using a given material, it is assured that the mate, with say 39 teeth, would last for ages using the same material. It is said to be desirable to have all the parts of a car last for an equally long time; certainly it is not necessary to have the parts which are easy to design last for an unnecessarily long time at the cost of materials better than would be necessary, on the ground of harmony.

Buyers of cars will not be able to see why some considerable headway has been made in recent times in divers ways, for the reason that it is not plain (on the surface) that matters such as these did receive a due measure of attention. On the other hand, it is plain to be seen that improvements were wrought.

Materials Do Not Have to Be of Some One Grade.

There is no need to use some one grade of steel all through a transmission system, although all the steel used can be low enough in carbon to assure ability to sustain under impact, which phenomena is bound to be present in transmission work to a marked degree. One of the strong points to be made in this article is that the ability of steel to sustain under impact is decreased as the carbon content is increased, and it is urged that alloying be resorted to if strength in excess of that which resides in carbon steel is wanted. This is not to say that carbon should abound in the alloy steel; on the other hand, for kinetic work, it is firmly believed that adding carbon under conditions involving alloys, defeats the aim, if it is desired to attain strength in "diagonal" work. In any case, entirely aside from what will come of the presence of carbon in quantity, if steel is alloyed,

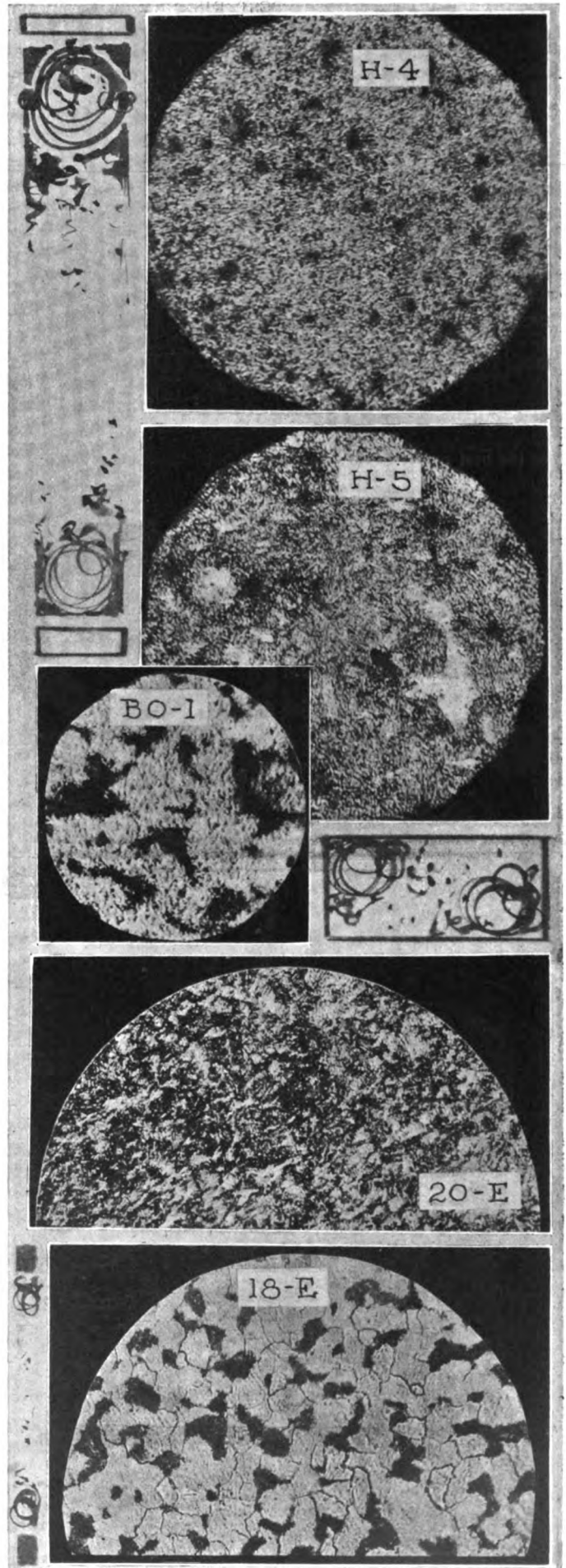

TEST RECORD AS USED BY DESIGNERS OF AUTOMOBILES.

SPECIFICATION	Tensile strength per Sq. In. in Tons	Elastic Limit Tons per sq. in.	Elongation in 2 Inches. Per cent	Contraction. Per cent.	RESISTANCE TO DROP TESTS FREMONT TUP	
					Nicked Test Bars Foot Lbs.	Plain Test Bars Foot Lbs.
BCH Natural state	24 to 25	14 to 16	28 to 33	65 to 70	231 to 325	
BCH Tempered and annealed	25 " 28	18 " 19	30 " 35	75 " 80	231 " 325	
RHB Natural state	32 " 35	16 " 18	22 " 25	60 " 65	144 " 217	
RHB Tempered and annealed	33 " 36	18 " 19	25 " 26	65 " 75	144 " 253	
GDH Natural state	38 " 41	22 " 24	20 " 23	58 " 65	108 " 181	397 to 433
GDH Tempered and annealed	39 " 43	24 " 27	25 " 28	65 " 70	108 " 181	397 to 433
HVD Natural state	48 " 51	29 " 32	12 " 15	45 " 50		217 " 253
HVD Tempered and annealed	52 " 54	32 " 35	15 " 18	55 " 60		217 " 253
PLH Fibrous iron	25 " 27	13 " 14	25 " 30	50 " 60	181 " 217	
PLH Annealed	48 " 51	38 " 41	15 " 20	65 " 70	108 " 181	Bend without breaking under a blow of 433 foot lbs.
BNC Tempered and annealed	57 " 60	51 " 54	15 " 18	60 " 65	108 " 181	181 to 217
BNC Tempered in oil	86 " 92	76 " 83	12 " 15	50 " 60	36 " 72	289 " 361
BNC Annealed	60 " 64	51 " 54	12 " 15	55 " 60	87 " 144	289 " 361
BND Tempered and annealed	70 " 73	64 " 67	10 " 13	45 " 50	87 " 144	
BND Tempered in oil	121 " 127	114 " 121	2 " 4	20 " 25	Will not bend or break under a blow of 433 foot lbs.	

NOTE.—The steel as given in this table is that as used in many of the best makes of cars, in which kinetic ability is pronounced.

the fact remains that more skill is required to deliver the best results in the presence of carbon than is the case when the steel is very low in the same.

Data in Relation to the Table of Steel Values.

In the table the limits are given in such a way as to enable the designer to take into account the maximum possible result if the steel is properly treated, and the minimum likely result in average good practice. No reference is made to "cementing" results, in view of the fact that in a cemented section the core should show about the same as is here given for tempering and annealing—the shell should be glass hard.

Referring again to the table, it is to note that the materials belong to the classes as follows:

BCH = Special carbon steel in which the carbon is under 10 points, but in which the manganese is quite high (above 0.80) and the metalloids are very low indeed. This steel is especially for parts to be cemented.

RHB = A grade of carbon steel in which the carbon does not exceed 16 points and holds above 10 points. This is a true "cementing" steel, in which the effect of carbon up to that due to 16 points should be taken into account. In this steel it is desirable to hold the metalloids at a low ebb and the manganese should be quite high.

CDH = Steel of the nickel genera, in which the carbon ranges between 18 and 20 points, and the steel is suitable for use in the die (drop) forged state.

HVD = A high carbon (45 points) steel to be used in a limited way in parts not subjected to shock to an extent requiring the use of materials of a highly kinetic character.

PLH = Fibrous iron (puddle iron), which is the iron of the wagon maker in the past. This material is used for many purposes in a good class of automobiles, even for gears and axles (cemented), in which the carbon is as low as 4 points.

BNC = Chrome nickel steel, in which the carbon and manganese are low, and in which the metalloids are very low indeed.

BND = Another grade of chrome nickel steel, in which the manganese is quite high, and in which the carbon is a little higher than in BNC.

With information such as this before the designer it is easy to predict that the product will be harmonious, if it can be said that the "purchasing" representatives will procure the same material for the parts later on. It is possible under such circumstances to take into account the matter of the design as it relates to "notched" (nicked) bars as they perform in the "Fremont" test, and it is also easy to ascertain the dynamic responsibility of the parts such as will not suffer as a matter of design from the point of view of the notched bar. Irregular designs should be regarded in the light of "notched" bars; the performance in practice will be very much in the same way.

(To be continued.)



TRUE STORY OF THE AUTOMOBILE TIRE

By H. S. FIRESTONE, PRESIDENT FIRESTONE TIRE AND RUBBER COMPANY.

EVERY practical automobilist knows that the pleasure or discomfort of an auto ride depends largely upon the tires, but how many of them know anything about the "life story" of these scapegoats of motordom? It is a story of immense human effort in the crude rubber forest and the cotton field—a chapter, not only of interest to the automobilist, but to the average citizen as well.



Native Tapping Wild Rubber Tree.

Civilization first heard of rubber in Herrera's account of the second voyage of Columbus in the year 1493, where he speaks of elastic balls made by the natives from the gum of a tree.

The first authentic account of its practical use was recorded in 1745 by the leader of a French Governmental expedition returning from South America who reported that the natives secured from the juice of a tree a certain gum which was very elastic, impervious to water and used in making bottles, shoes and squirt guns.

Thirty years later it was introduced to commerce when an Englishman brought from Assam, India, a soft spongy substance which would erase lead pencil marks and which afterwards became known as India rubber.

Many primitive uses were found for this wonderful gum, but owing to

its susceptibility to changes of temperature, which rendered it sticky and more or less fluid, rubber did not come into its own until early in the last century. At that time it was discovered after a great deal of experiment, that by mixing sulphur with crude rubber and subjecting it to a high degree of heat, these former deficiencies were eliminated and a material was produced which was both tough and elastic, and would retain those properties under varying temperatures. This process of curing was called vulcanization and is the basis of rubber making to-day.

So great has been the development of rubber manufacture since that time that its products now exceed a value of five hundred million dollars annually.

Contrary to the popular impression rubber gum is not derived from the sap. It is secured from a milky juice or *latex* which is found only in the bark. This *latex* contains a substance known as caoutchouc (the active principle of rubber), together with certain albuminoids, resins, etc., which upon the evaporation of moisture coagulate, forming a thick, spongy substance. The percentage of caoutchouc, in proportion to other ingredients contained in the *latex*, determines the quality of the rubber.

The regions from which rubber gum is secured form an irregular belt in the tropics and sub-tropics extending around the earth, the quality procured varying greatly according to the species of plant, the soil and the climate. Great quantities are produced in Africa, Mexico, Ceylon and the Malay Islands, but the most de-

sirable rubber for resiliency and wear resistance is secured from a tree found in the Amazon River district, South America. This rubber is known as Para, the name being derived from its chief city of export. It not only contains as high as 95 per cent. of caoutchouc, but the methods used by the natives in preparing it for market are so much superior that it is selected in preference to all others for the manufacture of the best automobile tires.

Rubber gathering in the Amazon River district is a hazardous and difficult undertaking. The supply comes from wild trees scattered throughout dense forests, to which paths must be cut through the tangled and luxuriant undergrowth. Even then, the trees can only be reached during three to five months of the year, as throughout the wet season the forests are completely inundated. The climate is so unhealthy that white men cannot do this work and it is necessary to rely upon the native blacks, who at best are undependable and lazy. Their reluctance to join rubber gathering expeditions can readily be understood when it is remembered that out of a season's expedition perhaps only half will return alive.

When a rubber tree is found the native gatherer cuts a series of gashes into the bark with his machete, encircling the tree from the ground up, as high as he can reach. Cups are fastened to catch the *latex* as it oozes out. When a sufficient quantity is collected it is removed to the temporary hut where a dense smoke-producing fire is made of certain nuts and palm leaves. Then taking his wooden paddle the native dips it into the *latex* and holds it over the fire, turning it round and round until the *latex* coagulates. As soon as it is hard a new layer of *latex* is added and coagulated as before. This process is continued until the mass has grown too large for handling, when the paddle is taken out and the rubber set aside for export. In this form it is known as a ham or biscuit of Para. The process of coagulation and fumigation with these specially selected nuts and leaves prevents decay and adds to the life and wear resistance of the manufactured product.

Tapping the trees for rubber does not necessarily destroy them, nor is it believed to materially shorten their life; but unfortunately many thousands of trees are annually rendered useless by careless and improper methods. Although the source of crude rubber gum is practically inexhaustible, the limited native labor supply and the difficulties encountered up to the time of marketing it have tended to keep down the supply and maintain a high

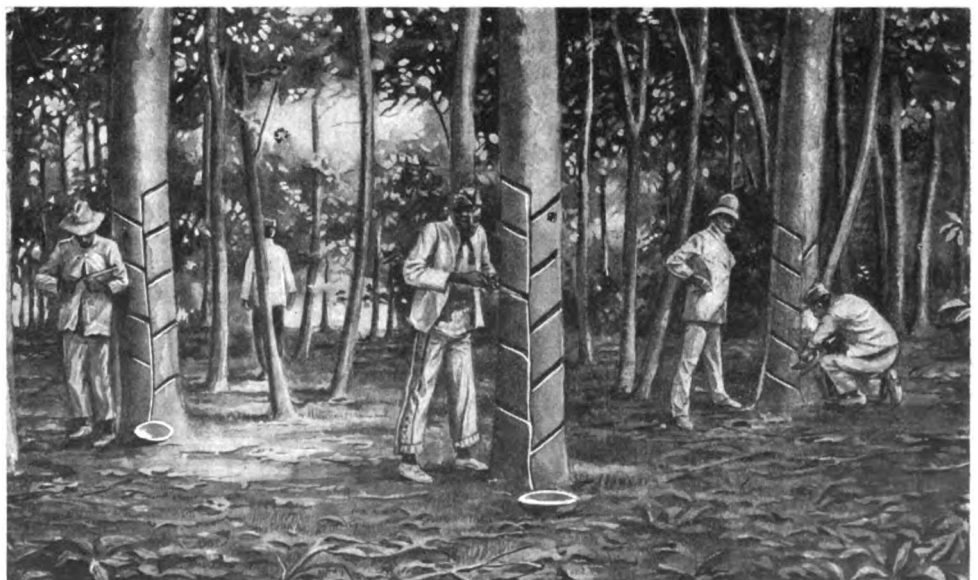

Tapping Trees on a Plantation Where Cultivation Has Made Progress.

cost of production. The output has been increasing steadily, but has not yet been able to keep pace with the enormously increasing demand for manufacturing purposes.

In order to obviate the difficulties encountered in gathering wild rubber and facilitate production, artificial cultivation has been resorted to in various localities. Scores of millions of dollars have been lost in ventures of this character, many of them merely wild-cat promoted schemes. It is estimated now, however, that there are 300,000 acres of rubber plantations in Ceylon and the Malay region and 100,000 acres elsewhere, principally in Mexico, some of which have already started to yield and promise handsome returns to investors.

In other localities rubber is collected and coagulated by a variety of methods. Africa, for instance, produces quantities of rubber from various species of vines, roots and even grasses which are destroyed in order to secure the *latex*, but which are rapidly replaced by new growth. These rubbers are designated by many different names, chiefly from their locality or the name of the native tribe gathering them. The methods of coagulation are very crude: some by evaporation, some by plant acids and others

patents have come to nought, and that most of the men embarking in the business have failed to succeed. The development of the rubber tire has been the survival of the fittest, and the outlook is in favor of a continuation of this same compound.

ELECTRIC AND GASOLINE WILL NOT COMPETE.

CLEVELAND, Feb. 8.—Gasoline and electric cars do not compete in any sense of the word, according to Hayden Eames, general manager of the Studebaker Automobile Company. Mr. Eames says: "Each is designed for a different purpose and far from being rivals, they are for the most part allies. The electric is the city car par excellence. As a substitute for the touring car it is a failure. Its sphere is bounded by the area of the paved streets. Nor is the common idea that the scope of the electric is confined to ladies' use correct. On the contrary, while it is the only type of motor vehicle a lady ever should drive, because of its simplicity, lack of complications and immaculateness, yet its larger field is in the everyday service of the business man. Few people realize how rapidly rubber is ground off tires on a heavy touring car by the frequent releasing of the clutch, changing of gears, effort of stopping and starting, and the still more wicked grinding consequent on turning sharply to avoid or to circumvent street cars and wagons. Now, the electric is free from all this. It starts gradually and stops with small effort because its speed is at no time great.

"One of the factors that have retarded a proper understanding of the electric was the facility or means for charging the batteries home. To maintain a car at a garage costs about \$30 per month, and there is the inconvenience of having to telephone for it and sending it back for recharging. This condition no longer obtains. The rectifier has revolutionized all that. This device, for transforming the ordinary electric current and automatically recharging the batteries, can be set up in your own barn or garage, and the total cost of maintaining a good electric will cost less than \$6 a month, tires and everything included. Say \$10 a month, year in and year out, to cover the price of renewal of batteries, repairs and current cost. In cities where rates for current are low it will average \$7 per month."

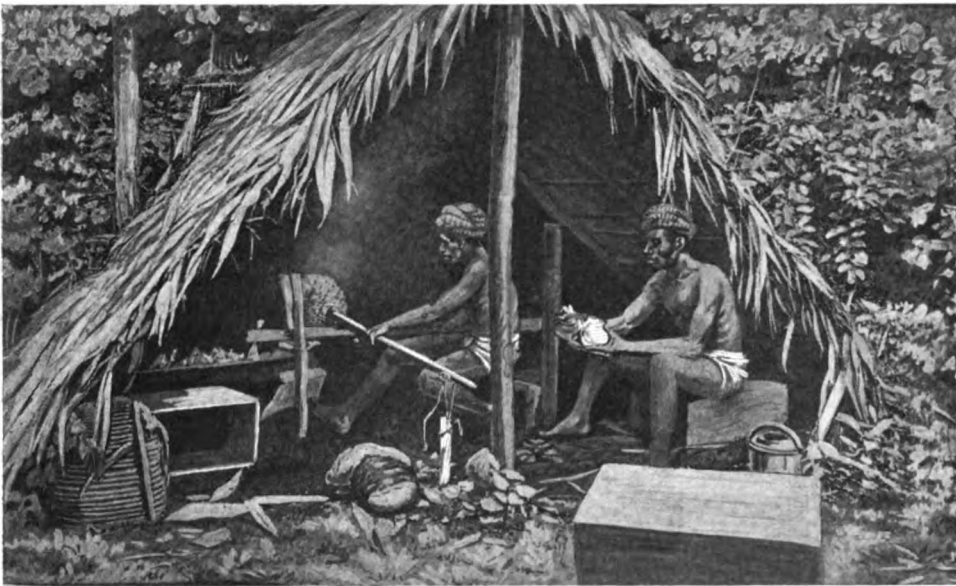

Smoking Process to Render the Rubber Immune During Shipment.

by smearing over the bodies of the natives. The proportion of caoutchouc in some of these rubbers runs as low as 60 per cent., but each has its own particular place in the general manufacturing field.

Next to rubber the most important material in a pneumatic tire is the fabric which gives form and rigidity to the tire. Extensive experiments have been made with all textiles to secure a fabric, which in the finished condition will combine best with rubber, be unaffected by the chemical action in manufacture and demonstrate the greatest strength. Silk and linen show great strength, but when combined with rubber will not produce the results which can be obtained from cotton. There are many grades of cotton, the best of which is long staple Sea Island. It is erroneously supposed that this cotton grows exclusively on islands off the coast of South Carolina, but, in fact, only the seed comes from these islands, the supply being grown on the mainland. The next best cotton comes from Egypt, which grade for grade, is estimated to average about 20 per cent. less strong than Sea Island.

There has been a great amount of thought, time and money devoted to the combination of rubber and fabric into a successful pneumatic tire and develop it to its present stage of perfection. The scope of this expenditure is well illustrated by the fact that 1,641 patents have been issued in the United States since the first one, May 8, 1847, to say nothing of the numerous patents on solid and cushion tires. It is needless to say that many of these

DAME RUMOR BUSY WITH E. M. F. COMPANY.

DETROIT, Feb. 8.—The latest rumor has it that William Metzger has quit the E. M. F. Company. Last week the rumor coupled the selfsame item with Mr. Flanders, while the week before the same report was made relative to Mr. Everitt. According to the latter, the affairs of the concern have been the cause of much discussion among competitors, but as this is by way of free advertising to which a denial simply adds, the officers mentioned really do not mind it. In fact, as Mr. Everitt put it: "Seems as if some person interested in bringing about the dissolution of the 'All Star Cast' invented the yarn before the consolidation was actually effected and ever since, at frequent intervals." Continuing, Mr. Everitt said: "But now you tell me Bill Metzger has quit—or was it me this time? Well, if you ever hear again that Bill is out, let me know confidentially and I'll give him another job. He can have the same old one back again, because a concern that is producing 12,000 cars a year needs a mighty good sales manager, and I believe Metzger is the best in the world."

In the meantime, E. M. F. cars are taking like "hot cakes."

LETTERS INTERESTING AND INSTRUCTIVE

THE BEARINGS ARE MADE VERY MUCH LONGER.

Editor THE AUTOMOBILE:

[1,741.]—In letter number 1,714, of January 28, the subject matter makes me think. I have a two-cycle motor (horizontal) which gives me lubrication trouble in connection with the crank. Oil will not stay in the crankcase, but works back to the combustion chamber, thus destroying the balance of the mixture. There is a drip cup placed to feed oil to the crankcase through the intake, and if gasoline destroys the qualities of the lubricating oil, the question is: how is the crankshaft to be lubricated?

Does a two-cycle engine require a special carbureter?

Would it be safe to put a check-valve between the carbureter and the crankcase to keep "back-firing" out of the carbureter?

Belton, S. C.

G. D. ROGERS.

In your case it would seem as if the trouble is due to the fact that lubricating oil (in excess) seeps through, by the piston, and destroys the integrity of the mixture, as well as "fouling" the spark-plugs. This would happen in the case, as you cite it, whether or not the motor is two or four-cycle.

In two-cycle motors, in general, means are provided for adequately oiling the crankshaft, and the bearings are made very long, to serve as packing for the crankcase compression, with the result that lubrication does not have to be profuse. Then, it is a fact that the gasoline vapor, which is really what has to be dealt with, is not the same as liquid gasoline in the lubrication oil.

A check-valve is usually placed between the carbureter and the crankcase to entrap the compression, unless the carbureter is so designed as to accomplish the purpose. Back-firing is due to the fact that the mixture is not with the right proportion of air to gasoline. If you will provide a means of holding a crankcase compression, and then adjust the carbureter so the mixture will be in accord with the needs of the motor, it is believed that your troubles will be materially reduced.

A shield of sheet iron over the ends of the cylinders (with a slot in it for the connecting rod to play in) will prevent the lubricating oil from going by, even if the shield is not so very tight. Your troubles will largely disappear if you will get up a crankcase compression, and prevent the lubricating oil from passing into the combustion chamber. A good carbureter is desirable, but it does not of necessity have to be especially designed for two-cycle work.

THE BEST PRACTICE IN BATTERY CONNECTIONS.

Editor THE AUTOMOBILE:

[1,742.]—I have nine cells of battery and I want to know if it is not better to arrange them in series-parallel rather than in series. If they are in series, and if the circuit opens at any point, then it is plain that the whole battery is put out of action. What is the matter with the idea of series-parallel wiring, in which it would appear that the battery will not be shut down if the circuit opens at some one point?

New York City.

F. H. THOMPSON.

Your arrangement of three series of three cells of battery affords you the electromotive force of three cells of battery, and the ampere rate of flow of current of three cells of battery in parallel. It would be the same thing were you to buy three big cells of battery, each one of which to have the capacity of three of the small cells, such as you might put in series-parallel. If the voltage due to three cells of battery is high enough (which is probably not the case, in view of the fact that you show dry-cells), you can proceed as you suggest, but three big cells of battery would be superior for the purpose, since then you would have many less connections to watch. Two series of four good-sized cells would be better for the purpose, unless it is that the coil you use is one requiring a higher voltage than that resultant of the use of four cells of dry battery. In the case of the two sets of four cells of battery it would be better to use one as the working set and the other for emergency purposes. It is true that good cells of battery will deteriorate if they are connected to cells that are run down.

IMPACT RELATION OF VARIOUS STEELS.

Editor THE AUTOMOBILE:

[1,743.]—Since automobile parts are subject to impact to a great extent, the question is: What is the relative value of the several generic types of steel? In other words, is Bessemer steel so very much inferior, and is acid open-hearth steel better than basic open-hearth product? Then, there is the question of carbon content to take into account; what can be said to indicate with some force of clearness the true situation?

New York City.

PLUMBAGO.

The questions asked might be cleared up in a volume of many pages, in so far as the knowledge on the subject is capable of inviting clearness. In such limited space as this it may be well to trust to a diagram or chart, showing the relations. Just such a diagram is the one to be found in the paper by F. W. Harboard, read before the Institute of Mechanical Engineers (English) November 20, 1908. This chart is reproduced here, in which (a) increasing carbon indicates decreased impact ability; (b) basic Bessemer steel has the least ability; (c) basic open-hearth steel

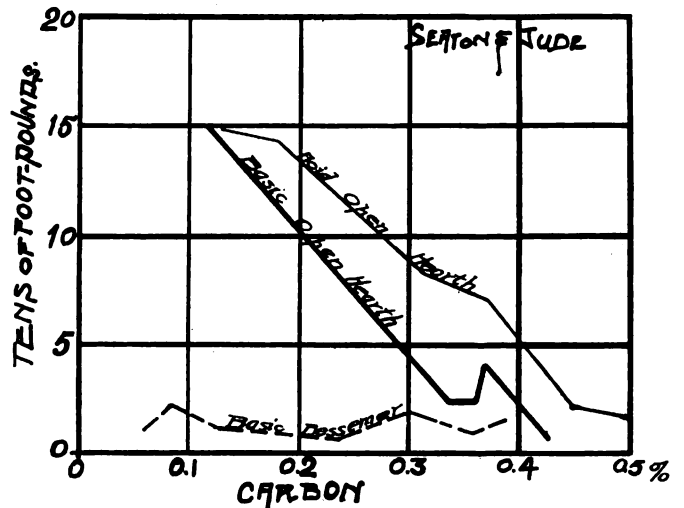

Curves Showing Impact Ability of Steel Products.

stands next to the lowest; (d) acid open-hearth stands the highest of the three. In view of the information afforded by the chart it is plain that acid open-hearth steel low in carbon is the steel to use (considering carbon steel) if the impact ability is to be a maximum. In this discussion crucible steel is not involved. Nor is the acid Bessemer product taken into account. The conclusions here reached are in good accord with the general facts, hence the chart is corroborative, and it has the virtue of being in full accord with the latest advices in relation to this important matter.

HOUSE MOVERS USE WOODEN ROLLERS.

Editor THE AUTOMOBILE:

[1,744.]—I note under the heading "Letters Interesting and Instructive," No. 1,714, January 28, that you make the statement that lubricating oil is ruined if diluted with kerosene or gasoline. This is a most natural assumption, but cannot be a fact inasmuch as I used for two weeks last summer a motor boat driven by a two-cylinder, two-cycle, two-port motor, having a bore and stroke of 5 inches x 5 1-2 inches and rated at 8 horsepower, which depended for lubrication of the crank pin, wrist pin and piston solely upon lubricating oil mixed with the gasoline in the tank and entering the crankcase via the carbureter. The motor turned at 800 revolutions per minute, and did not overheat during a five-hour full-speed run. This method of lubrication was not accomplished at the expense of other necessary features, as the pistons fitted tightly enough to show a compression of 60 pounds on a compression gauge when turned over by hand. Two pints of cylinder oil were mixed with each five gallons of gasoline. By this letter I do not wish to go on record as advocating this makeshift method of lubrication, as the scheme would not work at all with a four-cycle engine, and

doubtless interfered with the efficiency of the two-cycle, but the fact is it lubricated.

Dorchester, Mass.

FRANK P. HAWKINS.

In your case it is plain that the gasoline was provided with lubricating properties to some extent, but it cannot be shown by you that the whole constituted a "lubricant" in the sense of the word as taken when serious work is to be done.

It is not plain that the cycles have to be lubricated, and to whatever extent the gasoline with lubricating oil will serve as a lubricant it will so serve in a two or in a four-cycle motor. Gasoline is absolutely not a lubricant, nor is kerosene. It is a fact also that lubricating oil in which either of these liquids is mixed will lose its ability to sustain under pressure. The fact that you ran a two-cycle motor for two weeks using gasoline in which some lubricating oil was dumped proves nothing. There are instances of record showing that bearings have run for years on water. The bearings were so big in proportion to the work that the pressure was not enough to cause seizing provided the heat was absorbed by a non-lubricating liquid; in this case, water.

SEPARATORS IN HESS-BRIGHT BALL BEARINGS.

Editor THE AUTOMOBILE:

[1,745.]—We are pleased to see the notice you have given our bearing on page 956 of your issue of December 31. At the same time we regret that an error has crept into this description, since

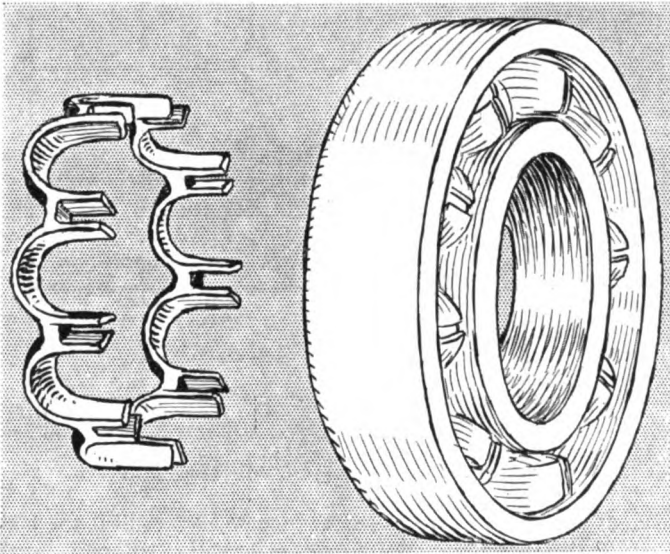

Spacers in Modern Hess-Bright Ball Bearings.

the separator you are describing as being made in halves must be that of some other make of bearing. Our separator is not made in halves; it is a single, high-grade bronze casting, with pockets milled out to a slightly larger sphere than the balls. This separator is inserted and after it is in place the projecting prongs are bent over in a die so that the balls are practically entirely enclosed.

We are sending you by mail a separator, as well as a completed bearing with the separator in place. From the above description you can readily see the actual construction.

We should very much appreciate it were you to give this correction space and were you to show an illustration by your sketch artist to make the matter clear.

Philadelphia, Pa.

HESS-BRIGHT MFG. Co.

Annular ball-bearings of the "silent type" have been put out in divers ways, with separators, as springs, etc., and the plan, on the whole, has been of the greatest value in automobile work. If the balls cannot come into contact with each other it is true that noise will be aborted, and since there is no occasion for having a full complement of balls it is the practice to turn out "silent" ball bearings with separators to aid in the process.

The illustration given is of the Hess-Bright annular type, showing the separator in place, which separator is a bronze member suitably fashioned for the purpose, which has the shape as shown above before it is inserted into place. When the separator is placed, in the process of assembling the ball bearings, it is then subjected to a bending process.

FLEXIBLE SHAFT WANTED FOR A SPEEDOMETER.

Editor THE AUTOMOBILE:

[1,746.]—Will you please inform me through the medium of "Letters Interesting and Instructive" where I can obtain a flexible spring shaft for a Lea speedometer? I understand that they are not manufactured any longer, and I can find no one who can inform me as to repair parts. Can you tell me if the Duryea rotary valve achieved any success, and kindly tell me in what issue of "The Automobile" I can find description of same? Have nearly two years' issue, and know I have that particular one, but cannot find it.

When are you going to place those excellent articles of T. J. Fay before us in book form? They should meet with ready sales.

Chicago, Ill.

E. A. MARTENS.

Every supply house of any pretence will be able to procure for you the very flexible shaft you seem to want.

The Duryea rotary valve was looked upon as a good success. Confer by mail with Charles E. Duryea, Reading, Pa.

No date can be fixed for the publication, in book form, of the articles by Thomas J. Fay.

TO IMPROVE GRADES OF BABBITT.

Editor THE AUTOMOBILE:

[1,747.]—I understand that ordinary grades of Babbitt can be so much improved as to eliminate the main objection. You tell so many things, it is possible you can cast light upon this subject also.

Binghamton, N. Y.

XENTH.

If the inferior grades of Babbitt are melted in a crucible (a cast-iron pot will do) and if tin is added until the metal is rendered quite brittle, when in the solid state, it will then be fairly good as a bearing metal. Keep the surface of the molten mass covered with charcoal in the powder form to prevent loss of metal and to render the process healthy. The fumes of lead are not safe to inhale.

BECOMES DINGY AND DIFFICULT TO RESTORE.

Editor THE AUTOMOBILE:

[1,748.]—Is there any way to clean carbide burners after they are reduced to a state of corrosion?

What will remove the dingy appearance of celluloid?

Florence, S. C.

M. A. W.

It is believed that the crust is an insoluble carbide, and it is true that in the removal of the carbide the metal will be reduced.

Celluloid becomes opaque in time and, in view of its low price, to replace it would seem to be the wise course.

PHASES OF AUTOMOBILE LAWS TO CONSIDER.

Editor THE AUTOMOBILE:

[1,749.]—In reference to your article entitled "Efforts Toward Uniform Automobile Laws," I wish to call your attention to Sec. 6, Subdivision 3, the latter half of which reads, "and if traveling in the same direction, use reasonable caution in thereafter passing such horse or animal, providing that in case such horse or animal appears badly frightened or the person operating such vehicle is requested so to do, such person shall cause the motor of such vehicle to cease running so long as it shall be reasonably necessary to prevent accident and insure the safety of others." If I understand this correctly, it means that if an automobile driver is driving in the same direction as the horse and the animal appears frightened, the automobile driver shall be obliged to stop his engine. How is this driver going to pass the horse? I believe that in that respect the laws of the State of Wisconsin cannot be improved upon, which read as follows: "Every person operating an automobile or other similar motor vehicle upon or along any public highway shall upon a signal by putting up the hand or other sign of distress, made by a person riding or driving a horse or horses, which are frightened, cause such automobile or other similar motor vehicle to stop, unless a movement forward is necessary to avoid accident or injury, and upon request shall stop all motor power until such horse or horses are under control; and shall, if requested, assist such person or persons to pass such automobile or other similar motor vehicle in safety. All motor power shall be stopped on any automobile or other similar motor vehicle while left unattended on the public highway." I have seen many times when a horse, on account of fright, will begin to back the buggy around and in almost every case the automobilist has had a very narrow escape if it had not been for him moving out of the way, which he would not be able to do in case his engine were shut down.

I also believe that in a case like this, where the engine is down, the automobilist should be exempt from any liability on account of collision.

Phillips, Wis.

ARTHUR BEYER.

1909 Speedwell

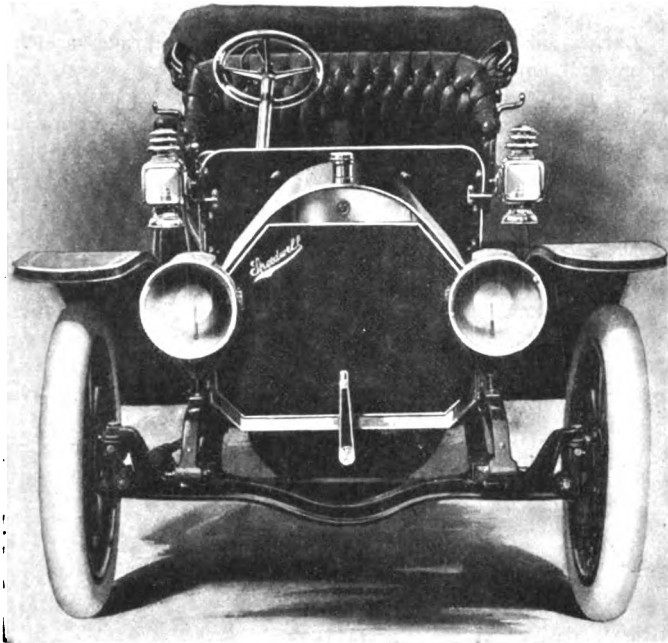

End on the Radiator Looks Very Artistic.

SIMPLICITY which lends itself to economy is the keynote of the Speedwell Motor Car Company, of this city, makers of the Speedwell, a moderate-priced car. So far is this idea carried that the manufacturers, now entering upon their third year, feel safe in the statement, "The Speedwell price (\$2,500) is the highest price that should be paid for the best motor car built." At this price, too, the product is all that can be desired in the way of material, workmanship and accessories.

Thus, taking up the details, the motor is found to be of 40 horsepower rating, but actually capable of delivering 50. The cylinders are cast individually, in the belief that cylinders so cast are more uniform than larger, more complicated castings could possibly be. The valves located on the side are operated from a single camshaft. The bore of the cylinders is 4.3-4 inches and the stroke 5 inches, and the cylinders, pistons, piston rings, crankshaft and all working parts are accurately ground. The valves are very large, of nickel steel, and operate entirely without noise. The power plant is completely self-contained with an adjustable ball-bearing fan which is mounted on the front, the commutator being on top of the engine and very accessible. Following modern practice, the crankshaft is offset from the center line of the cylinders, reducing cylinder wear, lessening vibration and increasing the efficiency of the motor.

Well Worked-out Lubrication.—The lubricating system is very well thought out, there being but a single place on the entire engine to introduce oil. Three gallons of oil are introduced through this receiving part, which passes directly to the sub-base of the engine. In the commutator shaft column is a pump, the duplicate of the water pump, which pumps the oil to the engine in large quantities, which tends to wash and

keep it clean, the oil in turn overflowing and passing down through a filter to the sub-base again, the process to be repeated. This gives an excess of oil at all times for lubricating purposes, yet as the oil cannot accumulate in the upper base the spark plugs of the Speedwell car are never fouled.

The carbureter is of the very latest automatic type with a hot-water jacket. By means of this jacket the gas is kept at a constant temperature throughout the year, and the fuel system is therefore not affected by heat or cold, or by dry or moist atmosphere, or other weather conditions.

Double ignition is provided, using two sets of spark plugs, one system being entirely independent of the other. The battery supplies the spark coil and one set of plugs, and the Bosch magneto supplies the other set of plugs, and in the event of accident to one system the other system is entirely independent.

The cooling of the engine is taken care of by a genuine square-tube honeycomb radiator which is very efficient. This, together with the direct-driven gear pump, makes a frequent supply of fresh water unnecessary.

The motor is controlled by spark and throttle levers on top of the steering wheel. In addition, an auxiliary air inlet between the carbureter and the motor is provided which is operated by a foot pedal. At extreme high speed, or when great power is necessary, this auxiliary air inlet can be opened gradually by the foot pedal, thus giving to the engine the maximum amount of air it will take. The extra power obtained by this device is surprising and it is a great feature for those who wish high speed and powerful hill-climbing abilities.

The clutch, which is interposed between the engine and transmission, is of the cone type, leather faced. A very large square section spring may be adjusted externally, the thrust of it being well taken care of by ball thrust bearings. The shifter, in addition, runs upon ball bearings, so that there is very little opportunity in the entire clutch mechanism for wear. The universal joint between the clutch and transmission is a combination of a slip joint with a universal. It is of very stout construction, completely housed in to exclude dirt, and well provided for in the matter of lubrication.

An Improved Transmission.—The transmission shows many new and valuable improvements which are mostly by way of minor details of design or construction, but which are invaluable in the more severe daily use. Thus in the single matter of leakage of oil or grease out of the bushings in the case, much lubricant is lost and money wasted. On the gearbox of this car a stuffing box is provided for both ends of the driving shaft which entirely eliminates any grease or oil escaping, a common fault of nearly all cars. The telescoping or driving shaft is provided with a long and very efficient roller bearing. Both shafts

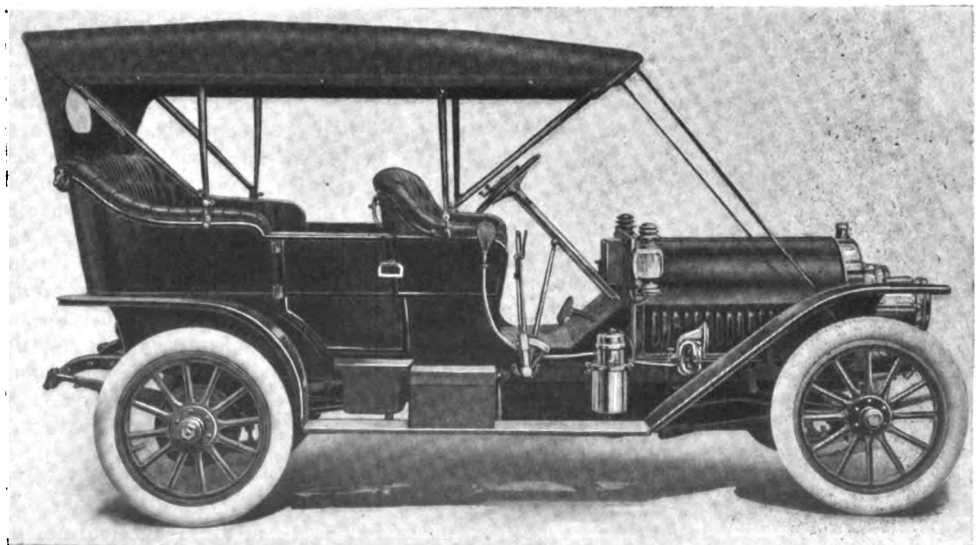

Side View, Depicting Wide Entrance and Absence of Obstruction.



Rear Axle in One Piece of Drawn Steel.

are themselves mounted on large Timken roller bearings. The construction of the driving shaft follows the very latest practice, having the keys milled integral with the shaft for the sliding gears. This permits a greater cross section of metal to be used as compared with former constructions of a square shaft, and it also adds strength. The gears and shafts are formed from a special alloy of vanadium steel, and both gears and shafts are hardened and accurately ground. The transmission is of the selective type with three speeds forward and reverse. The direct drive is on the third or high speed. All gears are of special gear alloy, containing vanadium as the principal constituent. This material, it is well known, is unexcelled for this use, although its excessive cost hinders the use in any but the highest priced cars. Three gear ratios are provided and the purchaser is given the option of 2 1-2 to 1, 3 to 1 or 3 1-2 to 1.

Axles Show Careful Designing.—The front axle is a one-piece drop forging of I-beam section, which, after being finished, is given a special heat treatment. A special feature of this axle is the fact that the steering heads themselves as well as the wheel spindles revolve on large Timken roller bearings. This makes steering easy, and the wear slight.

The rear axle is of the full floating type, the floating axles themselves carrying no weight whatever, the weight of the car being carried on the outside of the tubing. The floating axles are also heat treated. The housing for the rear axle is one piece drawn steel which is very symmetrical and is built entirely without the use of strut rods, rivets or brazing. The differential, the bevel gears and all the bearings are mounted on a frame which can be quickly withdrawn for inspection from this pressed steel housing. This new axle is the most wonderful example of the diemaker's art. The arrangement of the parts is such that all adjustments may be made from the outside, which is a little refinement that old drivers can testify to the sterling worth of.

The liberal, one might almost say excessive, use of roller bearings will be at once remarked. Inasmuch as published fig-

ures give the consumption of power for plain bearings as 2 per cent. and of rollers as 1-4 of 1 per cent., it may be seen at once what a great saving this liberal use of them effects. In fact, it is equivalent to a much more powerful engine in that the power delivered to the rear wheels is increased by just such a percentage for every roller bearing used.

Large, Liberal Brakes Are Provided.—The brakes are very large and powerful and are double on each rear wheel, being 2 1-2 inches wide by 14 inches in diameter, both brakes being equalized. It is thus possible to load the car heavier on one side than on the other and still have both brakes operate alike, a great preventive of skidding.

The steering gear is very large and substantial and is of the worm and complete gear type. This gear may be revolved at four different points, bringing into operation four different sets of teeth. This makes, in reality, four different steering gears in one, and should even outlast the car. It is adjustable for every move. Its bearings are very large and all the parts are hardened and ground. The steering wheel is an aluminum web, the wood being laminated on the rim. The touring car and limousine types have a 16-inch wheel and the roadster 18-inch wheels. The advantages of this unit construction of steering wheel, rim and spider over the usual practice of attaching the rim by means of three or four small screws cannot be overestimated. In

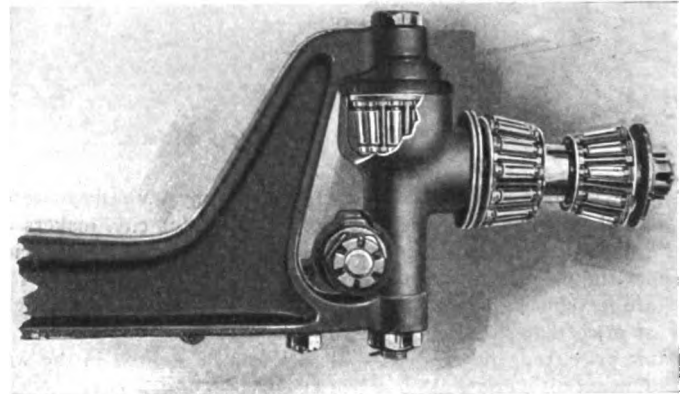

Front Axle with Timken Roller Bearing Knuckles.

case of trouble, where the utmost dependence upon the steering arrangement is necessary, the driver will always have complete confidence in this member, knowing that there are no wood screws to work out, leaving the bare rim in the hands of the astonished driver.

The wheels are 34 by 4-inch all around except in the limousines and seven-passenger cars, in which case the size of the tires are increased. The wheelbase is 120 inches and the tread 56 inches.

The car is built in three different types: touring cars for five and seven passengers, limousines, roadsters with single or double rumbles or with military seats and with a baby tonneau body. The springs are of an exceptionally fine quality and are double heat treated and oil tempered.

The front and rear springs are both of the now-popular long, flat, semi-elliptic type, the former being shackled at the rear and through the frame. Rebound clips are fitted on both and full provision is made for oiling.

The body lines are straight, and the long extended fenders give a somewhat low, racy appearance. The bodywork is of a high order, as is also the painting.

The car is completely equipped with two gas lights, generator, two side lamps, tail lamp, horn, jack, tool kit, tire repair kit, tire pump, battery, battery box, Bosch magneto, robe rail and foot rail.

The price, \$2,500, includes the extras mentioned above, but the top shown in the side view of the touring car is an extra, listed at \$125. So, too, are the extra revolving seats in the tonneau, two in number, which with 4 1-2-inch tires all round, for the man who wants larger tires, list at \$100—that is, \$100 for both.

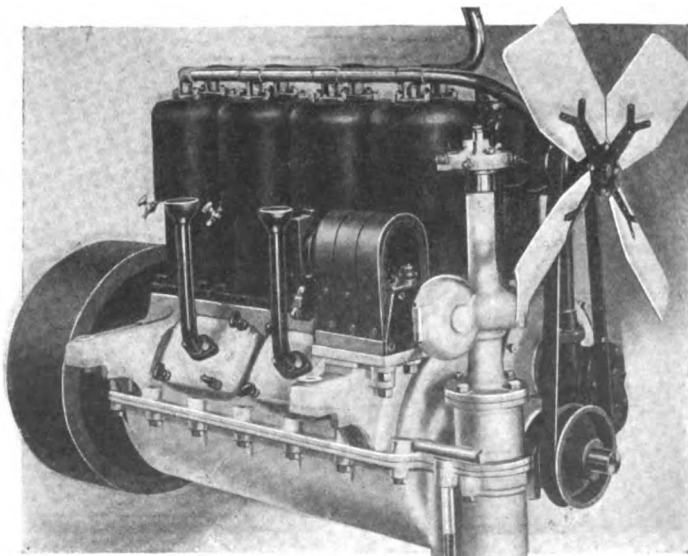

Individual Cylinder Motor with Magneto.

CALIFORNIA ALIVE TO THE NEED OF HIGHWAYS

SAN FRANCISCO, CAL., Feb. 1.—At the State Legislature, now convening at Sacramento, much discussion and rather heated debate has taken place with regard to the good roads movement. Two propositions were made; the first, being backed by the Governor, was the proposal to issue bonds to the amount of \$18,000,000 for a great system of State highways. The Association of Good Roads proposed that the State should assume control and maintenance of such parts of the roads built by the counties as would be accepted by the State as part of the system. The great point of controversy threatened to be whether a State commission or the State Engineer and his advisory board should have the handling of the matter. The association wanted a commission.

The Governor stated that he wanted no more commissions, and for a little while it looked like a war. After a conference it was decided that each side should draw up their bill and they should be presented. The Governor, in speaking to the members of the association, expressed himself as follows:

"I want to co-operate with the committee from your association in framing a bill so that it will create a concrete State road system and provide for its future maintenance, but we must come together on this subject. When the counties issue bonds and build roads that are a part of the State system we will provide that such roads are to be maintained by the State. But I do not like the tentative bill presented by the executive committee of the association. It was drawn by men not familiar with legislation, as was evidenced by the provision for nine-year terms of office, when our law limits the term of officials to four years, unless otherwise provided in the constitution. I don't like the provision for a commission of three members, each at a salary of \$3,600 a year. I want the work of supervising centered in the State Engineer's office. When I get \$3,600 a year to pay a man I want to get an expert from Washington, who has been brought up on road building and knows every scientific detail of it. I want to put that expert out on the road and make him work with his coat off; then, if he doesn't make good, off comes his head. But if I have a commission on my hands, I cannot remove its members at will. If they don't make good I am saddled with them for four years. So I want the supervision of the road building centered in the State Engineer's office, where it can be under experts. Then, again, in the association's tentative bill is a provision that would saddle the State with a whole lot of county roads that have nothing to do with a State system. I want arterial roads running down the valleys from one county seat to another, with branches to cities and towns of importance and connections in the necessary places." This clearly showed the chief executive's opinion.

On the other hand, the association, through its secretary, said:

"The State Engineer's office is too busy with river work, harbor work and the work of supervising State buildings to give the requisite time to road building. In other States the best results have been secured through a commission, and we want a commission of the best road men in the State."

The chairman of the commission stated that public sentiment was so aroused in the matter of good roads that it would force the appointment of good commissioners and hold the commission up to its work. A committee of the association called on Attorney-General Webb and talked over road matters. The Attorney-General advised them to get together with the Governor and

agree on a bill. This was done and the committeemen saw that there was merit in the Governor's views and agreed to abandon their contention for a commission. They have agreed to pull in the same harness, and the Governor will offer two bills, one to submit to the voters of the State the proposition to bond the State for \$18,000,000 for the construction of a system of highways, and the other to provide for a survey of the proposed system of highways. The Governor realized that if every effort is centered on the bonding proposition there will be little road work done until two years hence, when the proposition of bonding is submitted, and, in the event of the bonds being defeated, road work would get a terrible setback. To enable the counties to go ahead with their plans, the proposal has been made to survey the State and define the roads that will constitute the main State highway. With these defined, the counties may then proceed with the improvement of the roads that will act as feeders, so that when the State system is constructed the county system will be complete

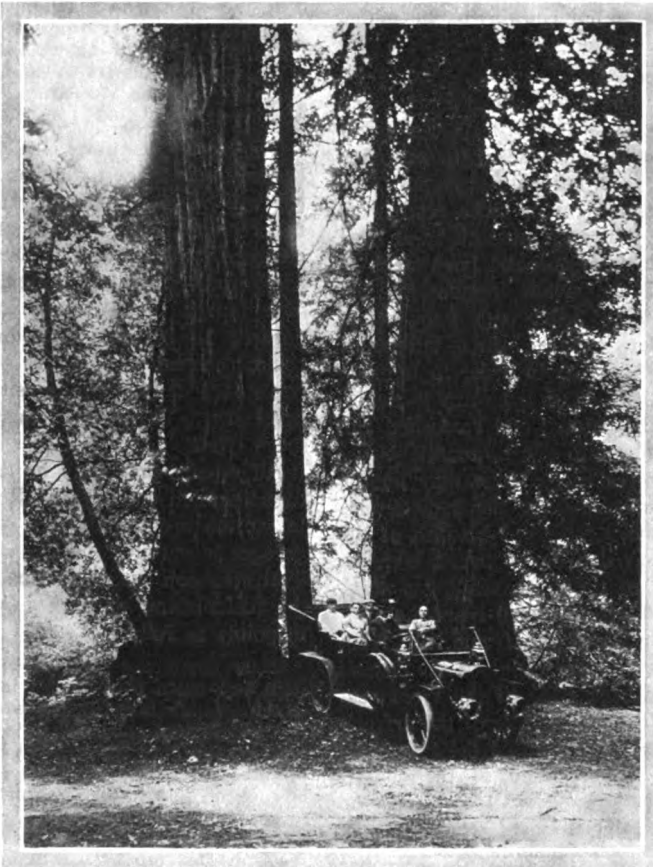

Among the Giant Redwoods of Marin County, Cal.

and fit in. Definite action and the adoption of the bills have not been decided upon, but good work is being done and there is little doubt of the outcome.

MICHIGAN SUPERVISORS FAVOR STATE LICENSE.

LANSING, MICH., Feb. 6.—The State Supervisors' Association, which is holding a convention in this city, has gone on record as favoring a law requiring automobile owners to pay a State license of \$10, the fund thus collected to be used for the construction of good roads. The supervisors were of the opinion that automobiles do more damage to the roads than any other vehicle.

Resolutions were adopted endorsing the State Highway Department, as conducted by Commissioner Earle, who has lately been the target for considerable criticism at the hands of the farmers' clubs and others, so much so that there has been considerable talk of abolishing the office altogether. Just what the future holds in store remains to be seen, but it is a fair inference that nothing drastic will happen.

PRINCE HENRY TOUR UNDER PRECISE CONDITIONS

BERLIN, Feb. 1.—Rules for Prince Henry tour (1909), which is the event superseding the "Herkomer," will take place from the date of weighing in June 9, next, to the 19th of the same month, and it is interesting to note the manner in which freaks are debarred from the contest. The following rules, which will govern during the contest, were formulated by the Imperial Automobile Club, Berlin; Austrian Automobile Club, Vienna; Hungarian Automobile Club, Buda Pesth, and Bavarian Automobile Club, Munich, as the product of careful deliberation, having in view the fact that the contest is to be deprived of all racing tendencies, hence a reliability run under carefully devised rules, quite completely given as follows:

Open to four and six-cylinder vehicles, whose frames are placed over the axle, of from 7 to 28-horsepower, as calculated on the following basis:

$$P.S. = 0.007 i d^2 \sqrt{S^3}$$

i = number of cylinders, d = bore, S = stroke, all in centimeters, $P.S.$ being German for H.P. The cars must be at the close of the first list of entries in the possession and use of the entrants, all of whom must be members of internationally recognized or German affiliated clubs, or of Austrian motor clubs recognized by the Austrian Automobile Club. The cars must all be at least four-seated, with double side entrance and doors, have steps of full length, and must fulfill all the police regulations for street and traffic. They must all be fitted with two brakes acting independently of each other, exhaust, three lamps, of which the one must be attached to the rear in order to light up the Prince Henry number, reverse, hill climb drag and a single-toned signal. The cars must also be painted and varnished and have four mudguards of at least 200 millimeters breadth, measured horizontally to the length of the car. These may not be displaceable. The minimum measurements for the body are as follows: Breadth of the front seats, 1,140 mm.; breadth of the rear seats, 1,200 mm.; both measured from outward edge to outward edge of the body; height of the front seats, 750 mm.; height of the rear seats, 800 mm.; both measured from the middle of the motor over the upper edge of the frame, i.e., from the upper edge of the seats back to the upper edge of the chassis frame. The distance from the top back edge of the front seat to that of the rear seat, measured from the middle of the driver's seat, must be 1,100 millimeters. The back wall of the rear seats must be closed throughout. The lowest point of the chassis must be at least 150 mm. above the ground. All cars must be fitted with a speedometer, and no advertisement whatever may be attached to the vehicles.

The minimum total weight of the cars, expressed in kilograms, will be calculated according to the formula:

$$G k g = 147^2 \sqrt{P.S.} - 6.5 + 646.$$

The horsepower ($P.S.$) being the same as above. The weight will be calculated exclusive of spare tires, inner tubes, fuel (petrol, water, oil), with empty tool case, and with oil in the motor and gear. In order to render the weighing-in easier, the cars may come to the scales with oil, water and petrol in the reservoirs; this will be calculated at 60 kilograms per car. The minimum weight of the body has been fixed at 15 per cent. of the total for each car. The body, which must be made of wood or metal, comprises all mudguards and their fittings, steps and their attachments, toolbox on the steps with tools, luggage rack, lamps, single-toned signal and tire holder. No lightening of the weight may take place during the trial.

Only petrol (gasoline) of a specific gravity of .680 upwards, benzol, alcohol and petroleum and their mixtures may be used as fuel. All additions are strictly forbidden. All cars may be driven only by members of the above-mentioned corporations, who receive no recompense for their driving.

Entries must be made by the owner at the headquarters of the promoting clubs on a filled-out form, enclosing the fee of

500 marks (\$125). This fee comprises the liability insurance for damages to persons up to 500,000 marks, with 100 per cent. for damages to goods up to 10,000 marks, with 90 per cent. as well as insurance of the cars against fire in the various garages during the whole tour. A factory certificate as to the cylinder dimensions must accompany the entries. Entries close on April 1, at 6 P.M. Entries at double fees are accepted until May 1, 6 P.M.

The tour takes place from June 10 to 18, with the weighing-in at Berlin on June 9. The route runs:

Thursday, June 10—Berlin-Breslau, first speed trial.

Friday, June 11—Breslau-Tatra Lomnicz, or Tatra Fiered.

Saturday, June 12—Tatra Lomnicz-Buda Pesth.

Sunday, June 13—Rest and exhibition.

Monday, June 14,—Buda Pesth-Vienna.

Tuesday, June 15—Rest and exhibition.

Wednesday, June 16—Vienna-Salzburg.

Thursday, June 17—Salzburg-Munich, second speed trial. Finish at Munich.

The start takes place once for all as fixed by the executive, the car with the biggest horsepower (No. 1) going off first. Every car will be accompanied by an official observer; every car must be occupied throughout by at least three grown-up persons, inclusive of the observer. During the speed trials the cars must carry four grown-up passengers, or 70 kilos of ballast in lieu of a fourth. The driver can hand the control of his car temporarily to his chauffeur, or a person nominated, before the commencement of the tour. This may not be longer than for two hours daily, if indisposition does not render a longer term necessary. The driver must steer his car personally in the speed trials.

All repairs may only be carried out by the driver, chauffeur or nominated passengers. Repairs during the time the vehicle is in motion are prohibited. All repairs also at the various daily garages may only be made with the material carried on the car. Transgression means disqualification, the only exception being the replenishing of tires and tubes. The awards will be made in points as follows:

Every commenced minute of an involuntary stay will be debited with two-tenths points. An involuntary stay is every stay during which a repair is made, the whole of the time being calculated from the stopping of the car to its continuing. Repairs of the speedometers may only be made at the various stations during the sixty minutes before the start given over to repairs and replenishments of fuel, oil and water. No debit points will be given for damages to speedometers.

Further, every commenced minute over the time allowed before the start for repairing will be debited two-tenths points; arriving late at the start from other causes than this will also be debited with two-tenths points. Tube defects from the garage to the start will not be reckoned. Changing of tires, as well as repairs or mending of tires, will only be punishable with one-tenth points each, regardless of time. Every alteration of the tires, especially fitting of enclosures or bandages, will be looked upon as a repair. Every change of the detachable rims will be debited with one-tenth point. Tube changes will not be reckoned. Replenishments of cooling and brake water after the start will be debited with five-tenths points each time. Fuel and oil necessary for the day must be carried in the car in extra tanks, as no official petrol and lunch stations will be available. Lubrication of the driving chain is, excepting the automatic working, only permitted once during the day; further lubrication of the driving chains, as well as of the motor and car—excepting through fitted tubes—is forbidden during the day; transgression will be punished with one-tenth of a point.

Two speed trials take place on the level during the tour. These will be calculated on a basis not yet published in such wise, that each car, according to whether it exceeds the speed fixed for it as normal or not, receives for every commenced one-tenth per cent. in the first trial one-hundredth point, and in the second speed trial two-hundredths point in credit or debit marks. The three credit points mentioned above will not be taken into consideration in the awards for the special speed prizes. Special provision is made in case of a "draw."

INTERNATIONAL AERONAUTICAL EXPOSITION ASSURED

PARIS, Feb. 3.—There will doubtless be an international aeronautical exposition in Paris during the year 1910, with the French Government as its backer and promoter. The initiative in the matter has been taken by the Ministry of Public Works which, with Minister Leon Barthou at its head, has shown considerable enthusiasm for aerial navigation, and has already succeeded in obtaining a Government subvention of \$20,000 for the encouragement of flying.

At an early meeting of Parliament the following resolution will be brought forward to be voted upon: "The Chamber of Deputies invites the Government to organize a national and international exhibition of aerial locomotion in all its forms during the year 1910." If, as is very generally believed, the resolution meets with the approval of Parliament, work will be begun at once on preparations for the first exhibition the world has ever seen in which aerial vessels occupied all the space.

The Esplanade des Invalides, on which the last two commercial motor shows were held, and which was the scene of a portion of the 1900 World's Fair, has been seized upon as a suitable site. For an indoor exhibition only the position is doubtless perfect, for it is but two minutes from the Champs Elysees, and as conveniently reached from all parts of Paris as is the lower end of Central Park from different portions of New York City. To

give the exposition its full measure of interest, it will be necessary, however, to provide for open-air experiments by aeroplanes and dirigible balloons, and for this purpose the Invalides is not ideal.

Issy-les-Moulineaux, which is just on the city borders, would give all the space necessary for flying, and as the Galerie des Machines has to be pulled down this year it is suggested that it should be transplanted to this ground in preparation for the aeronautical exposition. The hall is the largest in the world, there being sufficient space under its vast glass roof to house a score full-sized dirigibles and more than a hundred aeroplanes. An alternative site can be found at Bagatelle, on the borders of the Bois de Boulogne, and a few minutes from Longchamps race-course, where Santos-Dumont made the first public flight in Europe, and where Delagrange, Bleriot and other pioneers first learned to fly. The setting is a pretty one; the area is sufficient to allow of the construction of the necessary hall, while leaving all the space required for starting dirigible balloons and aeroplanes for demonstration flights and competitions. The only objection at present is that means of transport are somewhat limited. The choice of a ground, however, will be one of the least of the difficulties that the Government will have to meet, there being in addition to these three positions, several others which many cities would consider adequate for the circumstances.

NATIONAL BALLOON RACE STARTS, INDIANAPOLIS, JUNE 5

WITH the breaking up of Winter in this country the Aero Club of America is looking forward to a greatly renewed activity among the American aspirants for aerial honors. A long list of prizes has been announced, which will be competed for under the auspices of the club, some of the more prominent are: the President's Prize, consisting of \$1,000; the "Scientific American" Trophy; The Michelin Prize of \$4,000, The Gordon Bennet Aviation Cup, the Fulton Flight Contest for \$10,000, and the National Balloon Race. The Fulton Contest for the New York "World" Prize will take place during the Hudson Fulton Celebration, and it is hoped that it will be the forerunner of many similar prizes offered in the future under the auspices of the Aero Club.

The national balloon race will start from Indianapolis, Ind., on Saturday, June 5, according to an announcement recently made by the president of the Aero Club. The details will be managed by the Indiana Aero Club, which has just been organ-

ized and has applied for affiliation with the Aero Club of America. The entry fee is \$25, which will be returned to all who start. The contestants are limited to official pilots of the club, of which there are now 17, but before the entries close, on May 1, this number will undoubtedly be increased. The prize will be a gold cup valued at \$1,000, and additional prizes will probably be offered for the second and third men. Under the international rules the contest is limited to balloons of a maximum capacity of 77,000 cubic feet.

At the recent meeting of the directors, Cortlandt F. Bishop was re-elected president of the club, and arrangements for the third annual banquet, to take place in March, were rushed under way. By that time it is hoped that the fund for the medals to be given to the Wright Brothers in recognition of their services to the cause of aviation, will be completed and the time for presentation determined upon. Thus will the activities partake of interesting variations on a broadening basis.

Y. M. C. A TO START AERONAUTIC SCHOOL.

The West Side Y. M. C. A., of New York City, is making plans for an experimental course in aero science, beginning February 15, and if sufficient interest is aroused in the subject the association will open in the Fall of 1909, or possibly earlier, a school to train men for positions as aerial chauffeurs and engineers. The experiment will take the form of a series of free lectures on aeronautics by well-known aeronauts. The first lecturer will be Winthrop M. Scarritt, member of the Aero Club and former president of the A. C. A. He will speak on "The Experiences of a Tenderfoot in the Clouds." On March 1 Augustus Post, of the Aero Club, will speak on "The Practical Side of Aeronautics," and on March 8 Wilbur R. Kimball will discuss "the Practicability of Flight." Taking things as a whole it is plain to be seen that aerial navigation has taken a hold on the public and from all accounts there will be more than spectators as the product of the interest displayed. Recruits should enlist in the service, which has already rewarded the most daring of the aeronautic students so mightily.

AERONAUTIC SOCIETY CHOOSES OFFICERS.

At the annual meeting of the Aeronautical Society, held in the rooms of the Automobile Club of America, plans were discussed for the coming contests at Morris Park race track grounds, to be held some time in May. The following officers were elected for 1909: President, Lee S. Burrige; vice-presidents, Louis R. Adams, William J. Hammer, and Roger B. Whitman; secretary, Wilbur R. Kimball; treasurer, Dr. William Green; directors, Orrel A. Parker, C. B. Levy, Ernest La Rue Jones, A. C. Triaca, Riley B. Scott and Dr. Julian P. Thomas.

NEXT BRITISH AERONAUTIC EXHIBITION.

LONDON, Feb. 6.—The Society of Motor Manufacturers and Traders, in conjunction with the Aero Club, will hold an aeronautic exhibition at Olympia from March 19 to 27. Aeroplanes or models will be given space free of charge, and sufficient entries have been received already to insure a successful and interesting show.

THE AUTOMOBILE

Vol. XX Thursday, February 11, 1909 No. 6

THE CLASS JOURNAL COMPANY

Thirty-ninth Street Building, 231-241 West 39th St.
New York City

H. M. SWETLAND, President

EDITORIAL DEPARTMENT

A. G. BATCHELDER, Managing Editor
R. F. KELSEY, Associate Editor C. B. HAYWARD, Engineering Editor
W. F. BRADLEY, Foreign Representative

BUSINESS DEPARTMENT

A. B. SWETLAND, Business Manager
LOUIS R. SMITH FRANK B. BARNETT
W. L. RALPH, 1085 Old South Building, Boston, Mass.
C. H. GURNETT } 1200 Michigan Ave., Chicago, Ill.
F. W. VAN SICKLEN }
E. H. GILL, Detroit, Mich.
T. B. VAN ALSTYNE, Philadelphia, Pa.

Cable Address - - - - - Autland, New York
Long Distance Telephone - - - - - 2046 Bryant, New York

SUBSCRIPTION RATES:

United States and Mexico - - - - - One Year, \$3.00
Other Countries in Postal Union, including Canada - - - - - One Year, 5.00
To Subscribers—Do not send money by ordinary mail. Remit by Draft,
Post-Office or Express Money Order, or Registrar your letter.

FOREIGN SUBSCRIPTION AGENTS:

ENGLAND:—W. H. Smith & Sons, Ltd., 186 Strand, London, W. C., and all their
railroad bookstalls and agencies throughout Great Britain; also in Paris
at 248 Rue de Rivoli.
FRANCE:—L. Baudry de Saunier, offices of "Omnia," 20 Rue Duret, Avenue
de la Grande Armee, Paris.
GERMANY:—A. Seydel, Mohrenstrasse 9, Berlin.

Entered at New York, N. Y., as second-class matter.
The Automobile is a consolidation of The Automobile (monthly) and the Motor
Review (weekly), May, 1902, Dealer and Repairman (monthly), October, 1903
and the Automobile Magazine (monthly), July, 1907.

COMBINED EFFORT IN THE MIDDLE WEST.

Automobile activity in the West is now centered in the Chicago show, which opened under the most favorable auspices, illustrating again the fact that "in union there is strength." Never before, in the history of trackless mechanical transportation, did so many cars mass under one roof, there to proclaim to all the world the fact that the automobile is a power in the land. Nor can it be said that even veterans fully realized just what it meant to assemble the makes of cars which go to represent the industry which compelled the exchange of \$467,000,000 within a single year—the last year, to be sure.

In the year to come it is variously estimated that some 80,000 automobiles will be sent out as the agents of the industry; out into the world, in which they must show worth in a manner as never before, and it is well worth risking the prediction, in effect, that these same cars will proclaim in sonorous voice that dreams do come true, and the echo which took seed in the Chicago show will come back within a year with augmented results.



TAKING INTO ACCOUNT THE MATERIALS.

Static ability was once the main criterion rather with the idea that kinetic properties could be reflected to an adequate extent. Kinetic requirements proved the undoing of the earlier theory with the result that the

hunt for materials of a kinetic character has been strenuous, uninterrupted, and through divers channels. From the old methods of reflecting kinetic qualities to alloy steel, in the search for materials pronouncedly superior in "diagonal" work, was a long way, midst thorns bearing the scent of roses, due to the mode of procedure in which "the wish was father to the thought."

The thought was that price was a good indication of quality, and the makers of the materials were perfectly willing to allow the same thought to propagate and spread to the remotest corners, and to swell the "tide." That the scheme will not hold water is rendered apparent from the fact that the best results come from the use of "cementing" steel in which carbon is low—very low indeed; alloying if rigidity is to be intensified; holding to the plan in which kinetic ability is foremost, in any event.

Recent investigations disclosed the glaring fact that none of the "impact" tests in vogue tell the truth, the whole truth, and nothing but the truth; they do disclose the important fact that with increasing carbon impact ability decreases. This is a discovery of such great importance that it should be "branded" in the memory of designers with a "hot iron," particularly in view of the fact that lowering the carbon in the steel increases the melting temperature of the same, and the furnace linings last for a length of time far less, thus accounting for the "influences" in favor of steel with a carbon content above the best requirement. That the carbon content should hold below the point at which hardness will follow quenching from cementing temperatures is assured, for then the core of a cemented section will be ductile, and dynamic, while the surface will be rendered hard as glass, due to cementation, in which carbon abounds in the surface layer sufficiently to deprive the steel of the ferrite excess; interjecting cementite instead, which later condition affords assurance of glass-hardness on the surface while the soft core lends stability to the project as a whole.



WHAT PROPORTION SHOULD THE BODY BE?

Among the rules formulated for the running of the Prince Henry tour this year is to be found one imposing a minimum weight on the body to be used. When the impossible freaks of construction that passed as touring cars in last year's event are recalled, the reason for the rule will be evident. This new rule stipulates that the body must represent at least 15 per cent. of the total weight of the machine, and it raises a question of general interest. Without attempting to fathom the processes by which this arbitrary limitation was fixed, let us see what 15 per cent means. In the case of the light touring car that weighs but 2,500 pounds, all on, this would call for 375 pounds of body. Take a 60-horsepower machine exceeding 4,000 pounds, and practically none of that power falls below this figure with a touring body, it would mean that at least 600 pounds of the total would have to reside in the body. Whether it be possible to carry out such a limitation as this and make it equitable in practice where the entries comprise a diversity of types, ranging from small and light powered cars up to the heaviest machines, remains to be seen.

\$1,000,000 SUBSCRIBED FOR THE MOTOR PARKWAY

NEW capital to the extent of \$1,000,000 has been placed at the disposal of the treasury of the Long Island Motor Parkway during the past week. Four of the best known financial magnates in the United States have subscribed for bonds to the above amount, and the money is now available, to be used in the resumption of construction work on the Parkway as soon as the frost is out of the ground. Three of the four men who have showed their confidence in the project in such a substantial manner are J. Pierrepont Morgan, William K. Vanderbilt, Sr., and H. B. Hollins, of the Wall street banking house of H. B. Hollins & Co. The bonds draw four per cent. interest, and are issued as an addition to the former issue of \$500,000.

The officials of the Parkway have decided to change the route of the course so that it will now terminate on the northern shore on Long Island, within half a mile of Little Neck station. The right of way has been secured, and the change, besides doing away with the numerous grade crossings, called for on the original route, will bring the Parkway into direct communication with the new Blackwell's Island bridge, which has a special roadway for automobiles.

The completion of the work, which is now insured by the new capital, will prove of great value both to the individual automobilist and to the trade, and the well wishers of the enterprise will be glad to know that the project will soon take shape.

COBE OFFERS CUP FOR WESTERN ROAD RACE

CHICAGO, Feb. 9.—Ira M. Cobe, president of the Chicago Automobile Club, has tendered to the American Automobile Association a trophy to be contested for annually in a national stock chassis road race. Mr. Cobe announced his gift at the annual banquet of the Chicago Automobile Trade Association in the course of his speech on "Road Racing in the West," in which he declared that the West is no longer a way station, but has become an important factor in things motoring. The trophy was given at the suggestion of President Hotchkiss, of the A. A. A. No formal announcement has yet been made of its acceptance by the national association, on account of a slight mistake in the deed of gift.

At first Mr. Cobe wished it to be a strictly Western proposition, while the A. A. A. desired to distribute its favors by holding the race in a different section of the country each year. As matters stand now, it has been agreed that the trophy shall be contested for in the West for the first two years on a course within fifty miles of Chicago. The Chicago Automobile Club has a suitable course in mind and has taken the preliminary steps toward securing it. The Governor of Indiana will be asked to permit the use of the militia to guard the course.

The proposed circuit is within fifty miles of Chicago and can be reached by automobile over fine roads, most of which are macadam. Crown Point, a town in Lake County of considerable importance, is on the course, and there are excellent railroad facilities for transporting spectators. There is only one other town on the circuit—Lowell, a village of about 1,000 inhabitants. Here it will be necessary to establish a control; otherwise, there are few flaws to be found. There are no railroad crossings; on the back stretch a ten-mile straightaway will permit high speeds. The course is approximately 22 miles long, and although there are a few bad turns, fast time can be made on the stretches.

Before the echo of Mr. Cobe's speech had died away, N. H. Van Sicklen, the new Chicago branch manager of the Knox, made the first tentative entry. It is his intention to put in either a 40 or a 50-horsepower model, whichever will be eligible under the rules adopted for the contest. Western manufacturers are showing a keen interest in the proposed race, and it is believed that if the race is run here in Indiana there will be little difficulty in securing twenty-five or thirty entries, not only from Western makers but from those of the East as well.

NO RACE THIS YEAR IN ITALY.

PARIS, Feb. 3.—There will be no racing cars this year on the fast Bologna course, where last September Felice Nazarro put up a new world's record for long-distance speeding. As the result of the decision of the Automobile Club of France to kill the Grand Prix, it is impossible for the Italian body to get entries for a race under similar rules, and the inevitable course has been taken of postponing the speed event until 1910. There are hopes of being able to get on foot an aeronautical demonstration with \$20,000 in prizes, but at the present time there are more prizes than flyers, and it is doubtful if the Italians can fill their entry list sufficient to justify the holding of the event.

Belgium, which was to have held a race this year under Grand Prix rules, has not yet announced its decision, but it is understood that as the result of the combine by French makers against speed events there will be no attempt to carry the programme through. High-powered automobile speeding is therefore dead throughout Europe for the year 1909.

SAVANNAH WANTS MORE AUTO RACES.

SAVANNAH, GA., Feb. 8.—At a meeting held by the Savannah Automobile Club and the officers of the militia it was decided that Savannah would put in a bid for the next Grand Prize or for any other large race which may be in prospect. The military has promised to lend its aid again, and with the remembrance of its excellent work Savannah expects to make a strong showing.

HOTCHKISS FOR INSURANCE COMMISSIONER.

ALBANY, N. Y., Feb. 9.—The latest news from the executive mansion chronicles the appointment by Governor Hughes of William H. Hotchkiss, of Buffalo, for State Superintendent of Insurance. This appointment was sent to the Senate on Monday and was referred to the proper committee, which will act upon it at an early date. The interest of the automobile world in this appointment lies in the fact that Mr. Hotchkiss is president of the American Automobile Association, past president of the New York State Automobile Association and of the Automobile Club of Buffalo. He is also author of the motor vehicle law of the State of New York, which has been copied by other States.

Mr. Hotchkiss has signified his intention of accepting the appointment, which came to him unsolicited as a result of a long personal friendship with the Governor.

PARKWAY RELEASED FROM BONDS.

MINEOLA, L. I., Feb. 8. —Upon the payment to-day of \$10,000 following closely upon a recent payment of \$5,000, the Motor Parkway Company was released by the Nassau County Board of Supervisors from its \$25,000 bond. This was put up before the sweepstakes and Vanderbilt Cup races last fall as a liability fund to insure payment for damages to roads or for any accidents. The small payment covered the expense of the deputy sheriff who guarded the road, while the large amount to-day is to defray the cost of oiling the roads and other expenses incurred.

NATIONAL ROADS BILL THAT APPROPRIATES \$50,000,000

WASHINGTON, D. C., Feb. 6.—A number of good roads bills have been introduced in Congress during the past few weeks, but one of the most interesting is that of Representative Sturgiss, which provides for the creation of a national highways commission and for the construction, improvement and maintenance of public highways, in co-operation with the several States.

The proposed commission is to consist of three commissioners, to be appointed by the President of the United States, and they shall have a practical knowledge of road building and construction. They shall serve for a term of six years each. It will be the duty of the proposed commission to take into consideration, formulate and adopt such plans for the improvement, construction and maintenance of such public highways as shall promote and facilitate interstate commerce and the postal service.

The commission is empowered to institute condemnation proceedings for the acquirement of any land, right of way, or material needed to maintain, operate and prosecute highway improvements.

The bill carries with it an appropriation of \$50,000,000 for the purpose of carrying out its provisions. The sum of not less than \$500,000 out of such appropriation shall be expended in each State at the rate of not less than \$100,000 a year. The \$50,000,000 appropriation shall be available at the rate of \$10,000,000 a year during the years 1909 to 1913, inclusive. However, no part of this appropriation shall be expended in any State until an equal sum of money shall be appropriated and set apart by said State for highway improvement. Authority is given the Secretary of War to detail an engineer officer of the army to aid the commission in its work.

VANDERBILT CUP COMMISSION SUED.

NEW YORK CITY, Feb. 8.—Jefferson deMont Thompson, chairman, and Frank G. Webb, vice-chairman, of the Vanderbilt Cup Commission were served on February 5 with a summons in an action to recover \$500, representing part payment on account of the entrance fee paid to the Vanderbilt Cup Commission by the Mora Motor Car Company, of Newark, N. Y. Senator William W. Armstrong, attorney for the plaintiff, has made all the members of the Vanderbilt Commission parties defendant to the suit, although the two mentioned were the only ones served.

Speaking of this suit, W. W. Burke, manager of the Mora New York branch, said: "When the entry blanks were issued for the 1908 Vanderbilt Cup race, the first entry was made by the Mora Motor Car Company, in the belief that the race would be an international one, as in previous years. The company sent its check for \$500, being part payment of the fee of \$1,000, specified for each starter. Then came the clash with the A. C. A., and for a time it looked as if the race would be abandoned, owing to the Cup Commission not adopting the rules formulated by the Congress of European Automobile Clubs. Under this uncertain atmosphere the Mora Motor Car Company decided not to go ahead with their special racing car, and demanded the return of their \$500."

Referring to the other side of the matter, Mr. Thompson says the suit will be contested on the ground that all conditions for the race were fulfilled by the commission. "We received the entry from the Mora company on May 25," said Mr. Thompson. "The entry was treated seriously and arrangements were made with the Mora as a prospective starter. It was not until September 24 that we were notified that the company had not been able to finish the car and desired to withdraw. Very naturally the commission declined to return the money. The proviso that half the fee must accompany the entry and would be forfeited in the failure to take part in the race was made to prevent just such happenings. Were we to have made conditions that did not include early payment of part of the entry fee, we would have been flooded with entries from concerns that had no intention of competing and desirous simply of obtaining what prestige might accrue to prospective contestants."

CONNECTICUT ENDURANCE RUN THIS SPRING.

HARTFORD, CONN., Feb. 8.—At the last meeting of the Automobile Club of Hartford it was voted to hold an endurance run in May, and although the time is yet quite distant plans for the event are already being made out. Several routes have been suggested. One that seems feasible is from Hartford, through New London, Providence and Worcester and return by way of Springfield. The dealers are said to favor a run of about three hundred miles, to be covered in one day.

FIVE NEW BILLS PROPOSED IN NEW YORK.

ALBANY, N. Y., Feb. 6.—Five bills amending the present New York automobile laws have been introduced by Assemblyman Robinson at the request of the law committee of the Automobile Club of America. The first deals with the exemption of owners licensed in another State. As the law now stands, a New Yorker may take out a New Jersey license and not register at all in New York, with considerable pecuniary saving to himself and a corresponding loss to the New York treasury. The amendment would confine the exemption to non-resident owners.

Another bill would abolish speed limits of a specific number of miles an hour, and instead make everybody on the highways responsible for the maintenance of a rate of speed reasonable and proper under the circumstances. It is modeled on the law at present so satisfactory in Connecticut. All fines and penalties are to be paid over to the Secretary of State to be used for the maintenance of the roads. Local magistrates will be compelled to account for fines and to turn them into the treasury, instead of putting them into their own pockets. The Penal Code is amended by providing that taking out automobiles without the consent of the owner—"joy-riding," to use the vernacular—shall be considered larceny, and making any tampering with an automobile without the consent of the owner a misdemeanor. That some such laws will pass looks like a certainty, the wisdom of which is reflected in the experiences of the past, more particularly in view of the splendid results which followed the adoption of sane laws in other states; notably Connecticut.

ANOTHER EFFORT AT FEDERAL REGISTRATION.

WASHINGTON, D. C., Feb. 8.—Representative Olcott, of New York, has jumped into the limelight by introducing a bill in Congress regulating the operation of motor vehicles within the District of Columbia and the territories of the United States and while regularly engaged in interstate or foreign commerce or the postal service. It is understood the A. C. A. is behind the bill.

Regarding registration, the bill provides that no person shall, after 90 days following the day on which the proposed law takes effect, operate any motor vehicle unless it shall have been registered by filing with the Secretary of Commerce and Labor at Washington, D. C., a statement containing the name and address of such owner, a brief description of the machine, including the name of the maker, the number affixed by the maker, the style of the car, the character of the motive power, and the horsepower of the car. A filing fee of \$2 is required.

A motor car manufacturer or dealer may register one vehicle of each style or type manufactured or dealt in.

It should be understood that this proposed law has no chance whatever of securing any attention during the present session of Congress.

CHIT-CHAT FROM THE CLUB CENTERS

LONG ISLAND A. C. PREPARED FOR BUSY SEASON.

BROOKLYN, N. Y., Feb. 8.—At a special meeting of the board of governors, held recently, the president of the Long Island Automobile Club appointed the following committees: Law and legislation, Wm. Payson Richardson, chairman; Hon. Eugene M. Travis, Charles C. Cluff, A. A. Hovell and Herbert G. Andrews; entertainment, Edwin Melvin, chairman, W. C. Colson and Louis T. Weiss; technical, Louis T. Weiss, chairman, and F. G. Jahn; membership, Allen C. Alderman, chairman, W. L. Webster and Wm. G. Morrissey; contest, A. R. Pardington, chairman; auditing, J. H. Emanuel, Jr., chairman, W. H. Caldwell and W. L. Webster; garage, Wm. Schimpf, Frank G. Webb, Herbert G. Andrews, Charles C. Cluff and W. H. Caldwell; good roads, Charles Jerome Edwards, chairman, Cleveland Litchfield and Robert Magaw. Wm. Payson Richardson was nominated as the club's representative to the New York State Automobile Association.

These appointees are all well-known enthusiasts identified with the club, but probably the greatest achievement in the history of the club was the passage of the Cypress Hills Cemetery bill, authorizing a parkway from King's to Queen's county. This work was done by the law and legislation committee, under the guidance of Mr. Richardson, who is reappointed in recognition of the good work of the past year.

BRIDGEPORT CLUB IN FLOURISHING CONDITION.

BRIDGEPORT, CONN., Feb. 8.—As a result of the campaign instituted by President Sperry, of the Automobile Club of Bridgeport, to not only increase the present membership but to arouse interest among many of the present members, the recent meeting of the board of directors marked the increasing of the roll by 50 new names. This brings the total up to about 225 with brilliant prospects of passing the 300 mark during the summer season.

As indicative of the renewed life infused into some of the members, over 200 with their friends were present at the smoker given at The Stratfield. The program, consisting of moving pictures of the Savannah and Briarcliff races, some vaudeville stunts by artists from Poole's Theater and a buffet lunch served by the hotel management. Arrangements have been made with the management of this new hotel to hold club meetings there.

At the last meeting of the board of governors, chairman Ralph M. Sperry of the contest committee was authorized to begin preparations for the four annual hill climb to be held on the morning of Decoration Day. The place has not yet been definitely decided upon, but it will be either Sport Hill in Easton or Snake Hill in Mill Plain.

PROPOSED MOTOR CLUB MAKES HEADWAY.

BOSTON, Feb. 8.—Last week when the tentative meeting of prominent members of the automobile fraternity was held with the idea of advancing the proposed new organization, L. R. Speare, president of the Bay State Automobile Club, clearly depicted the fact that just the facilities which the new organization would have to provide awaited but fitting use under conditions involving that strength which unity always signifies, and he further stated that if the present officers of the club fell under the ban, they would gladly make way for agreeable successors. The meeting of the charter members of the new organization, comprising some 50 prominent names, fell in with the plan as suggested by F. S. Corlew and the name of the new organization is to be the Boston Motor Club. The committee on rules and by-laws was appointed and is made up of W. A. Thibodeau, chairman; C. E. Fay, J. B. Sullivan, Jr., F. S. Corlew and Arthur P. Teel. The committee on club quarters was named, and consists of W. A. Shafer, chairman; F. H. Ayres and R. R. Ross.

QUAKER CITY AUTOISTS HAVE ELECTION.

PHILADELPHIA, Feb. 8.—The annual election of the Quaker City Motor Club last Tuesday night was the closest in the history of that hustling organization. After a stirring campaign the present president, P. D. Folwell, was beaten out for re-election, by a small margin, by L. D. Berger. The new president is also the presiding genius of the Motor Shop, which formerly handled the Stearns and Oldsmobile, the latter car, however, now being represented here through a branch house. M. E. Brigham for first vice-president; G. Douglass Bartlett for second vice-president; A. T. Stewart for treasurer, and Harry C. Harbach for secretary, were unopposed. There was a counterpart of the presidential contest in the fight for places on the board of directors, of the twenty-six nominees the following being elected: Fred C. Dunlap, R. E. Ross, G. H. Gantert, J. R. Overpeck, W. D. Donnelly, E. H. Lewis, Richard Sellers, A. T. James, and Max R. Greene.

After the pools closed at 8 o'clock there was a stag smoker and luncheon in the banquet hall. The majority of the out-of-town tradesmen and lay visitors who were in town to attend the automobile show were among the numerous guests.

Rumors have been prevalent hereabouts for the past fortnight that a sizeable clique in the club were not satisfied with its management, claiming that the trade element, being in entire control, subordinated the social features to the advancement of their own particular ends. At the same time the publicity committee of the Century Club, which was formerly the Century Wheelmen, the crack local organization during the cycling boom days, began to ring the changes on their intention of transforming their organization, which is now strictly a social club, into an automobile club. While no open defection has as yet materialized, the Q. C. M. C. officials have thought the matter sufficiently serious to come out in a statement denying the rumor and challenging the production of the list of members (said to be 35 in number) who were contemplating resigning.

The rumor, even if unfounded, will in all likelihood make the Quakers bestir themselves and take the initial steps toward establishing a home of their own.

NORRISTOWN CLUB'S SECOND ANNUAL RUN.

NORRISTOWN, PA., Feb. 8.—The second annual endurance run of the Norristown Automobile Club will take place on dates yet to be selected in the latter part of April. It will be a two-day affair, and although no objective point has been positively decided upon, it is almost certain that Sunbury will be selected. This would make a round trip of about 300 miles. While the roundabout route via Harrisburg would furnish the better going, that by way of Shamokin is more direct. A compromise may be effected by going one route and returning by way of the other.

At last week's meeting the following officers were placed in nomination: President, John H. Rex; vice-president, Isaac M. Smith; treasurer, Lewis E. Taubel; secretary, William B. Hart; assistant secretary, Earl Wentz.

GERMANTOWN A. C. HOLDS ANNUAL BANQUET.

PHILADELPHIA, Feb. 8.—One hundred and four members and guests sat down at the annual banquet of the Automobile Club of Germantown last Saturday night. Bright lights in professional and business life, besides many prominent automobilists, were present. President Robert P. Hooper acted as toastmaster, and among those who responded to toasts were E. T. Stotesbury, Senator D. Webster Grim, of Bucks county; Senator William C. Sproul, of Chester; Charles T. Terry and F. H. Elliott, representing the A. A. A.; Paul C. Wolff, of Pittsburg; Powell Evans, president, and F. Boyer Davis, secretary, of the Automobile Club of Philadelphia; W. N. Glasgow, L. P. Wright, Harrison Townsend and James F. Hope.

SKY WARS SEEN THROUGH MAXIM'S EYES.

Hudson Maxim, in a well-put talk, at the Automobile Club of America, New York City, delivered on the night of February 9, made the point that Congress should appropriate \$5,000,000 for "aeronautics" instead of balking at a paltry \$500,000. It was "aeronautic night" at the A. C. A. and the meeting developed wide interest, which was of a character to indicate that the world is moving faster than Congress seems to appreciate, and as Hudson Maxim aptly put it: "Congressmen look upon the United States as a sort of a big raft bound to float along in the current of prosperity somehow." But the climax of Mr. Maxim's keenness lent zest to the whole discussion when he said, "they (Congress) believe that one's interest, like charity, should begin at home, and thus it is that we have more real statecraft than we have statecraft."

Representative Butler Ames, of Massachusetts, whose work in the aeronautical line has attracted wide attention, in his reply to Mr. Maxim, said: "All that has been said about the necessity for making preparation in this country for meeting the fleets from the skies is true, but as a member of Congress I am not willing yet to say that we shall not have an appropriation this year. There is still a chance in the Senate, and I hope and believe that before the session ends we shall have the full appropriation and in future years much more."

MAXWELL GETS NEW FACTORY AT TARRYTOWN.

TARRYTOWN, N. Y., Feb. 8.—Rumor has been current several weeks that the Maxwell-Briscoe Motor Company, of this city, has been trying to get control of the Ingersoll-Rand-Drill works here. Official confirmation of the report comes from Secretary F. D. Dorman, of the Maxwell-Briscoe Motor Company, who, when asked in regard to the facts, said: "Yes, it is true we have leased the Rand Drill Works to take care of our overflow. Our business has grown so fast that we have utilized nearly all of our available space, and it was impossible to put up new buildings on the premises fast enough. We will take possession immediately."

Locally, the acquisition of the drill works is considered a great thing for Tarrytown. As the Maxwell-Briscoe people employ about 1,000 men at Tarrytown alone, with a pay roll averaging \$12,000 weekly, this, is simply another step in the company's policy of expansion, which adds additional factory space to the present chain of three factories. For 1909, the combined output of the Maxwell factories will approximate 12,000 cars. For 1910, with the increased facilities just obtained, the present plans call for an output of about 20,000 Maxwells. Superintendent Pretz has already started a gang of men at work in the new building, which is proof of how sorely the additional space was needed.

NEW JERSEY LICENSES TRANSFERABLE.

TRENTON, N. J., Feb. 8.—As the result of an application by A. B. LeMassena, local agent of the Department of Motor Vehicles of New Jersey, at Newark, regarding the legality of transferring a number pad from a car which had been in its owner's possession but a day or two, and had never been used, to another machine, subsequently acquired, Commissioner J. B. R. Smith has made a general ruling which reverses his former stand on this point. Hitherto, Commissioner Smith has held that a license, when once issued, should not be transferred from the car to which it was originally given. If an owner sold his car he could also sell his license, the transfer being validated by the payment of a fee of \$1 to any State auto agent, this construction being put upon the Jersey law immediately following its adoption in 1907. Under the new ruling, upon payment of a transfer fee of \$1, it will be possible to use the old license pad upon the newly acquired machine. Commissioner Smith has devised a special form of transfer card, with which the agencies are being supplied as fast as the State printers can turn them out. These call for practically the same information.

FRANKLINS WILL DO SERVICE IN PITTSBURGH.

Taxicab service is of a character such as to demand the consideration of designers to an extent far in excess of that usual to automobiles in general, for the reason that the service is continuous, on streets of every character, under the charge of chauffeurs of no great skill. The cars must stand in the street, in the cold of winter, for hours at a time, and economy of fuel as well as maintenance of machinery indicates that the motor should be brought to rest whenever possible.

If air-cooling is taken advantage of, it is then that the cold weather is more of an aid than a detriment; at all events the weather will not effect the service which can be rendered, and the cost of upkeep of the machinery will be lowered since the life of a machine can be counted in revolutions of the rotative members of the same. True, the thermal efficiency of a motor is dependent upon a dozen of considerations, and again, the life of the same is not so low that counting the revolutions of the rotative members becomes as a necessity. Even so, it is desirable to count all the influences and eliminate as many as possible of the negative quantities.

It will come as no surprise then to learn that the "Franklin" air-cooled motor is to be used at Pittsburgh; a location demanding every consideration from the point of view of inclement

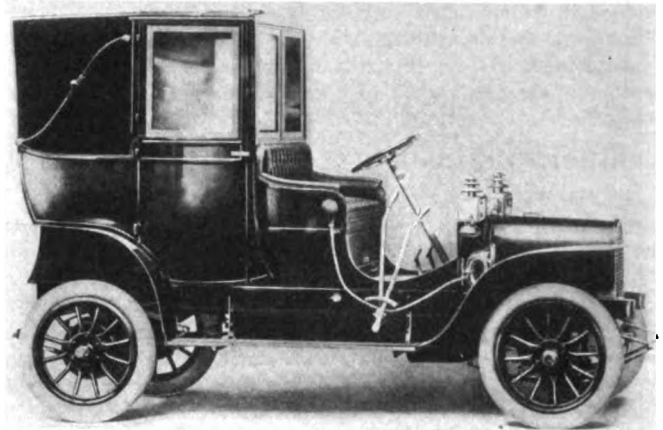

Franklin Air-Cooled Straight Front Landaulet.

weather, to say nothing of the steep ascents and in divers ways; roads which demand more than a little consideration at the hands of designers of automobiles to be used in that locality. The illustration here afforded is of the new Franklin taxicab as it will be used at Pittsburgh, twenty of which are to be put into service next month.

The body of the cab is of the "landaulet" type; the top folds back, and in every way the design favors stability coupled with style and an inviting air. The exterior finish is in Quaker green, and the interior is in dust-proof light cloth and leather. The chauffeur's seat is in green leather, and by way of some contrast the green of the body is relieved by molding and underbody work in black.

The chassis frame is of laminated wood (usual Franklin practice), noted for its strength, lightness, and the fact that resiliency is present in the frame to a marked extent. This is a question which may not be quite well understood by many on the ground that wood is not so much used in automobile work, and in the earlier days, when laminating was not resorted to the defects of the wood were to be feared. In the Franklin plan (in which the frame is laminated) the well-known qualities of wood can be taken advantage of without in the least fearing that a defect in the wood will develop to the detriment of the car. In other ways the new car is on a basis which is bound to make the record of performance in Pittsburgh an epoch-making event.

The air-cooled motor is of the well-known Franklin make, using "concentric valves," and the usual Franklin means of wiping away the heat, water or other liquids failing to play a part.

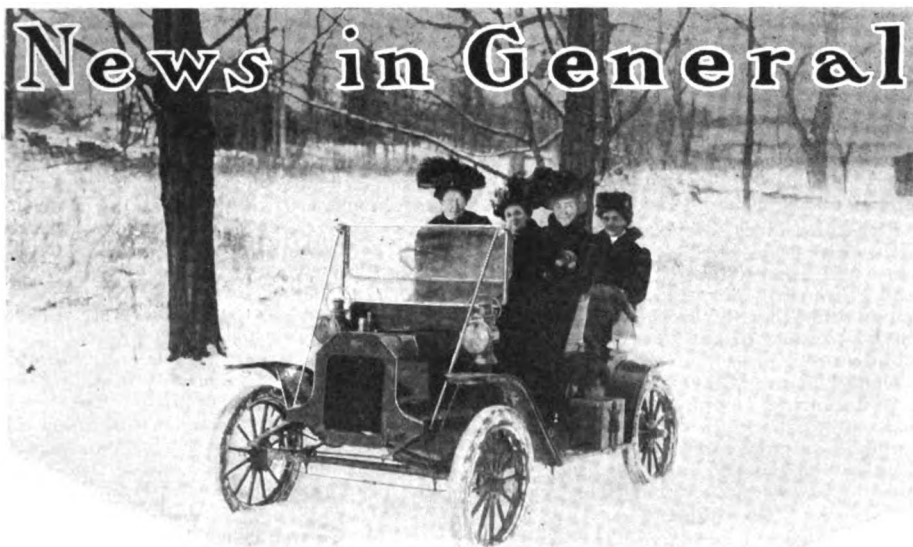

Mrs. J. W. Gogarn in Her Boon Companion Reo Model G.

The owner has driven this car over 3,000 miles over the roughest roads, and finished "perfect" in the late "Long Island Mechanical Efficiency" wrangle. Mrs. V. V. Board, Mrs. G. G. Williams, and Mrs. E. J. Kincaid make up the rest of the "winter scene" on this occasion.

Michelin's Views on the Care of Tires.

—A very large proportion of autoists habitually carry spare shoes with them, or at least have one or two spare shoes in their locker at the garage. In speaking of the care of shoes, M. Michelin says: "A casing which is not in use must be carefully kept away from light and heat. It is preferable to keep it in a place which is cool, without being damp, as dampness is bad for rubber casings, even for those which are being used, although they are less sensitive to light and heat than tires kept in one place. Spare shoes should never be permitted to lie on the ground, or on cement floor, but should be protected by a curtain and must be carefully kept away from any fat substance. Casings in use require more care, as the shoe is constantly receiving numerous small cuts from its contact with the ground. These are sometimes almost invisible and others are large enough for the driver to see, but so small as to be neglected. They open the door to dampness and foreign bodies, which are certain to injure the tire. Dampness rots the lining and invites blow-outs, which are also caused by dust being forced through a slight cut in the tire or by the entrance of small particles of ground which become bunched together beneath the outer rubber. The result is the accumulation of a hard body which cuts one ply of fabric after another until the casing explodes. It is, therefore, necessary to pay close attention to these cuts, and in case of Michelin tires to cure them with Michelin Mastic. This closes up many cuts which would otherwise become serious wounds, and a little attention of this sort will lengthen their life very materially, and will procure a length of tire life which will surprise the owner.

Pierce School Plans for 1909.—Announcement has been made to all dealers in Pierce Arrow cars of the plans for the 1909 school of instruction conducted by the Pierce Arrow Motor Car Company, of Buffalo. The plans for the present year are far more comprehensive than any the company has made heretofore, and include not only classes for chauffeurs and garage men, but also a special period during May for owners exclusively and one during April for colored men. The classes begin February 15 and each one lasts two weeks.

Expert mechanics are in charge of the work of instruction, which consists of detail lessons regarding the car, its assembly, maintenance and driving. The time between May 3 and May 22 has been set aside for the instruction of owners who intend to drive their own cars, and the work of the instructors during that time will be devoted entirely to them. The class of colored men will open on April 5 and close April 17, and during that period the school work will be for them altogether.

National After 10,000-Mile Record.

Early in May or June the National Motor Vehicle Company, of Indianapolis, Ind., will go after a record, which is nothing more or less than an attempt to do 1,000 miles every day for ten consecutive days. This trial will be made possible by the new two-mile motor speedway track, which has been promised for completion early in May. The trial will be made with a single car, of course, and will be under official observation. The grind will go night and day for 240 hours, with tire repairs or repairs of any kind to be made in running time. The National people feel fairly confident of reaching the record of 10,000 miles in ten days, since some years ago they made a world's record of 1,094 3-16 miles in 24 hours. If the effort is successful, it will certainly be a striking demonstration of the sturdiness of the car, for this would mean the terrific clip of 50 or more miles per hour kept up for 10,000 miles. Four different crews will be used in relays for the trial.

"Grease vs. Oil."—An attractive brochure is printed by the Keystone Lubricating Company, Philadelphia, bearing the above title and containing instructive comparisons of the efficiency of the two great types of lubricant that are used to grease the wheels of industry. Some of the inner reasons for the extensive use of the liquid lubricant, oil, at the present day, are interestingly explained; and the evolution of Keystone grease, stated to be a pure, natural product, free from the harmful ingredients and objectionable features, are convincingly set forth. A feature of the argument for Keystone grease as an ideal lubricant at minimum first cost and operating cost, is an account of exhaustive tests made by the head chemist of William

Cramp & Sons, the Philadelphia shipbuilders, on the chemical constitution and mechanical and anti-friction qualities of the product. This booklet, of which many thousands have been printed and distributed, may be obtained gratis on application to the home office of the company, or to any of its agencies.

Wonderful Tire Mileage.—As a slight indication of the wonderful increase in tire building, is cited the case of an Indiana autoist, who in a roadster got a wonderful mileage out of his tires. Forty thousand eight hundred and seventy-two miles on one set of tires with no trouble beyond two punctures, is the record claimed by J. L. Martin, of Fowler, Ind. They are the largest figures for a single set of its product ever reported to the Diamond Rubber Company, but analysis appears to verify them. Looking into the matter brought out the fact that Mr. Martin made the mileage reported within a period of 18 months, according to the record kept by a reliable speedometer. The owner, being in the windmill business, drove constantly in his daily work, in addition to evening and Sunday driving for pleasure. His own estimate, aside from the speedometer figures, place his average daily running at 75 to 100 miles.

Cadillac Gets Another World's Record.

—Up in Detroit they are not satisfied to have the greatest number of factories and the most employees, the largest output, and all that sort of thing, but now must needs make factory production records for the whole world to gape at. The Cadillac Company recently did themselves proud when 74 complete cars were turned out and shipped in a single day. This sounds simple, but reducing it to minutes, this means a car every 12 minutes for 16 consecutive hours. This record-breaking feat was made necessary by the unusual pressure brought to bear by the selling agents, all of whom are calling for cars and more cars. The Chicago dealer incidentally made another world's record when 225 orders were sent in in one day. It behooves manufacturers to sit up and take notice now, or the Cadillac'll get 'em!

Fire Company Adopts Simplex.

—A big deal in automobile chasses was put through in New York City recently when the American-La France Fire Engine Company, of Elmira, N. Y., contracted to take a good sized portion of the Simplex Automobile Company's output. The Elmira concern is the largest in the country manufacturing fire-fighting apparatus, making about 80 per cent. of all the fire engines produced to-day. After much investigation, the company decided that the 50-horsepower Simplex was best adapted to fire department requirements, combining as it does strength, power, speed, and flexibility of manipulation, with standing-up qualities. These chasses are to be fitted with regular chemical fire engine equipment, and in years to come will doubtless save much property from destruction.

More Up-to-Date Sales Methods.

—One of the pronounced tendencies of the day is the matter of changes in selling methods, all firms attempting to keep right up to the minute in this respect. The Gabriel Horn Mfg. Company, Cleveland, O., has just made a very important change in its sales methods. Heretofore it has sold its products not only to manufacturers, jobbers and dealers, but to individual users as well. Now it is thought more economical to make shipments in quantities direct to its own representatives, and this has made it wise to establish exclusive agencies in all the cities of the country. All sales hereafter will be made

through these agents, who will be responsible for seeing that Gabriel products are properly put on cars and work to the owner's satisfaction.

Can't Buy a Second-Hand P. & S.—According to the Palmer & Singer Mfg. Company, of New York City, two so-called bargain hunters trying to buy Palmer & Singer "Four-Forty" limousines at a reduced price were unable to do so. The list price of \$5,000 was more than they cared to pay, and they made an earnest effort to find other "Four-Forty" owners in order to buy their cars second-hand. They easily enough obtained the names of a number of "Four-forty" owners under the plea of wishing to ask them how their cars were performing, and it gladdened the hearts of the sales force that every owner refused to sell his car on any terms whatsoever. The two purchasers, utterly unable to get "Four-Forty" cars in the second-hand market, returned to the big Broadway house and purchased new cars.

Races on the Coast.—The first automobile race of the year will be a double century endurance contest around the San Francisco Bay. This will be held on February 7, the first car leaving Golden Gate and Van Ness avenues at 6:30 A.M. The checking points will be at Oakland, San José and Garden City. Thirteen cars have already entered, including three Buicks, two Tourists, one Auburn, one Rambler, one Reo, a Stoddard-Dayton, a Mitchell, an Oakland, an E-M-F and a Studebaker. The roads are in such condition that an all-day job is expected by the competing drivers.

Philadelphia Salesmen Dine.—To show his appreciation of the efforts of the hard-working sales force of the Auto Sales Corporation, of Philadelphia, President Percy Neel, of that concern, last Thursday night banqueted them at the Cedar Park Driving Club. Bert Maucher, "Bill" Street, Ralph Cook, George Brooks, L. S. Julien, Bert King, Albert Kirk, Roy Hagerling, Ed. Burnshaw, J. B. Dickson, Morris Penrose and others were on hand, although a sudden illness prevented the attendance of President Neel.

Smashed Denver Record.—The automobile road record from Denver to Colorado Springs was broken recently by Wesley Smith, driving a 6-70 Thomas Flyer. The old record, 1 hr. 58 min., was held by Harold Brinkler. Smith's new mark of 1:50:32 clips 7½ minutes off of this. The announcement of this feat has stirred up a lot of excitement, and it is understood that Brinkler will immediately go after the new mark.

Monthly Meeting of A. S. M. E.—The next monthly meeting of the American Society of Mechanical Engineers will be held in New York City February 23, the fourth Tuesday of the month, instead of the second Tuesday, as usual. The subject of the evening's discussion will be "Safety Valves," a brief paper by Frederic H. Whyte, mechanical engineer of the New York Central Railroad lines.

Factory Proposed in Savannah.—One of the results of Savannah's Grand Prize race may be seen in the recently announced formation of a company to go into the business of automobile manufacturing. C. P. Henderson, one of those interested, will soon leave Savannah on a tour of the South to find what type of car is most desired there. It is hoped to have the factory in operation by the end of this year.

Banquet for Hartford Dealers.—The Allyn House, Hartford, will be the scene of a good time on Tuesday evening of show week, when the Hartford Automobile Dealers' Association will hold its annual banquet in the Automobile Club quarters.

IN AND ABOUT THE AGENCIES.

Hoyt Electrical Works, New York City.—A complete stock of the electrical instruments manufactured by the Hoyt Electrical Instrument Works, of Penacook, N. H., will hereafter be found in New York City at 1931 Broadway, where a branch office, in charge of R. V. Suttcliffe, as manager, has been opened.

Firestone Tires, Cleveland.—On March 1 the Firestone Tire and Rubber Company will open a branch office in Cleveland. For this purpose the company is remodeling the storerooms at 1918-1922 Euclid avenue, in the heart of the automobile row.

Nadall Rims, Cleveland.—The Nadall Manufacturing Company, of Chicago, makers of demountable rims of that name, have appointed Way, Mitchell & Company its Cleveland agents. Their address is 1120 Euclid avenue.

Columbia, Pittsburg, Pa.—Dr. R. E. Dinger, president of the Central Automobile Company, has returned from the New York shows with the news of his appointment as agent for the Columbia line.

Palmer & Singer, Philadelphia.—William and Charles Miller, 441 North Broad street Philadelphia, have been appointed agents for the Palmer & Singer for the Quaker City and adjacent territory.

Franklin, Oakland, Cal.—The Consolidated Motor Car Company, which has the San Francisco Franklin agency, has established a branch at Telegraph avenue and Twenty-second street, Oakland.

Hoffecker, Cleveland.—The Hoffecker Company, speedometer manufacturers, has opened a local branch at Euclid avenue and East Nineteenth street, with J. E. Strater as local manager.

Rauch & Lang, Milwaukee.—Welch Brothers Motor Car Company, Seventh and Grand avenues, Milwaukee, have added the R. & L. electric to its line of cars, which is headed by Packard.

Nadall Rims, Canada.—The Dominion Auto Company, Ltd., of Toronto and Montreal, Canada, has taken over the sole rights of the Nadall demountable rim, on a royalty basis.

Stearns, San Francisco.—C. S. Richardson, manager of the Reliance Automobile Company, has just closed a deal whereby his firm gets the agency for the Stearns.

Moon, Providence, R. I.—C. M. Linton, who has the Jackson and Welch agencies here, has added the Moon to his list.

Jackson, Minneapolis, Minn.—The La Crosse Implement Company has been appointed agent for the Jackson car.

Kisselkar, Newark, N. J.—Welden & Bauer have been appointed State agents for the Kisselkar.

Elmore, Spokane.—Smith & Rockwell have taken the local agency for the Elmore.

RECENT BUSINESS CHANGES.

Levi & Hipple Motor Company, Chicago, has removed from the Wabash avenue site to 1467-69 Michigan avenue, where the new models of the Lozier, Autocar and Chalmers-Detroit lines are now on exhibition.

Kellogg Mfg. Co., Rochester, N. Y.—This is the new name of the Wray Pump & Register Company, well known to the trade as manufacturers of auto pumps and registers under the Kellogg patents.

Supplementary Spiral Spring Company, New York City, has removed to 215 West Fiftieth street, just off of Broadway.

PERSONAL TRADE MENTION.

Jesse Froehlich, treasurer of the Times Square Automobile Company and managing director of the Benz Auto Import Company of America, sailed for Europe on the *Mauretania* February 3, and will visit the Benz Motor Works at Mannheim, Germany, to arrange for an immediate shipment of Benz cars. It is an interesting fact that on January 30 Mr. Froehlich sold three Benz cars personally in one day, one being to Herman Ridder, proprietor of the New York *Staats-Zeitung* and president of the Publishers' Association of New York.

Marcus I. Brock has been appointed manager of the Thomas Motor Cab Company, which is fastened by the E. R. Thomas Motor Company, of Buffalo. He is well known in the trade, having been sales manager of the Autocar Company and prior to that time assistant general manager of the A. L. A. M.

F. M. Germane has been promoted to assistant general manager of the Standard Roller Bearing Company, of Philadelphia, his former place as sales manager being filled by T. J. Heller. F. W. Lawrence has also been appointed Western representative, with headquarters in Chicago.

A. R. Pardington, vice-president and general manager of the Long Island Motor Parkway, Inc., has gone to a sanatorium at Mt. Clemens, Mich., to take the rest cure. He will return to New York in time to superintend work on the parkway.

V. M. Palmer has accepted the position of chief engineer with the Selden Motor Vehicle Company, of Rochester, N. Y. He was formerly with the Pope Mfg. Co. at the Hagerstown works.

Louis E. Elmer, the Hartford, Conn., agent for the Ford, who has been confined to the hospital for some time, is now able to be about a little each day. His many friends will be gratified to learn of his improvement in health.

Thomas W. Henderson, manager of the Detroit Winton branch, was married to Miss Maud Nicol Hawley, of that city, recently. Mr. and Mrs. Henderson are now in the East on their bridal tour.

E. V. Stratton has succeeded Frank Yergler as manager of the Philadelphia branch of the Studebaker Company. Mr. Stratton was formerly sales agent for that company in New York State.

H. Nelson Dunbar has accepted the position of sales manager with the Gabriel Horn Mfg. Co., of Cleveland. He was formerly with the Packard Motor Car Company, of Detroit.

George Daley, a well-known Philadelphia automobile writer, has joined the sales force of J. C. Bartlett, who recently took on the Quaker City agency for Woods electric vehicles.

Francis H. Warwick, formerly of New York City, has been placed in charge of the sales department of the Colburn Automobile Company, Denver, Col.

DEATH OF S. R. BALL.

S. R. Ball, head of the famous decorating firm of S. R. Ball & Co., New York City, died very suddenly at his home on February 9. This concern has made a specialty of show decorations and have been responsible for the fine appearance of the Grand Central Palace and Madison Square Garden automobile shows for many years back, as well as numerous other automobile shows in Philadelphia, Pittsburg, Kansas City and elsewhere. He will be missed by a host of friends and business associates.

INFORMATION FOR AUTO USERS

"Rist-Fit" and "Ventilated" Gloves.— Comfortable and classy automobile gloves for all seasons characterize the output of the Morrison-Ricker Mfg. Co., of Grinnell, Ia., and "Rist-Fit" and "Ventilated" gloves have become popular and

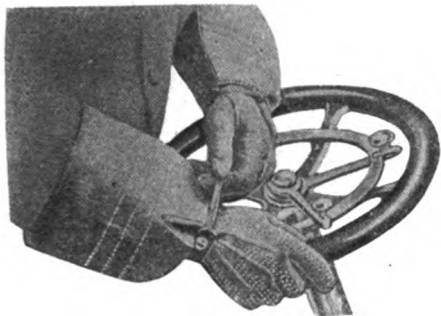

ADJUSTING THE "RIST-FIT" GLOVE.

well known the country over. One type of glove has a smooth strap leather cuff made from choice "Reindeer" and black colt skin of highest wearing quality, and another has a dignified gold initial in Old English. The "Rist-Fit" is a patented device which allows the glove to be drawn snugly at the wrist, keeping the cuff up and excluding dirt, snow, etc. Its application is shown in the illustration. The Morrison-Ricker Company also makes one-fingered mittens for winter use, which are finding much favor with some drivers.

The gloves for winter use are wool lined, lamb lined, and squirrel lined. Those for spring and summer are unlined or silk lined, and have the "Ventilated" back, which consists of rows of tiny perforations too small to admit dust, but which will allow air to enter and keep the hands cool and dry.

Hill's Automobile Specialties.—The Hill Dryer Company, of Worcester, Mass., announces in its catalogue No. 9 an exceptional list of specialties for the automobile which will appeal to the discriminating buyer. These specialties are of the nature of drip pans, waste cans, gasoline measures and funnels. The first mentioned is a drip pan which instead of being turned in at the rim is



HILL'S COMBINED MEASURE AND FUNNEL.

turned outward, and rolled in such a manner that the seam comes on the under side of the pan. This method leaves no cracks around the edge of the top of the pan that are necessary to patch with solder in order to make it water-tight. It is made in two sizes. In oily waste cans the company make two styles, the full, round type in three sizes, and a special half-round type in one

size, all of which are fitted with special self-closing covers.

A combined measure and funnel, the design of which is shown in the illustration, made of extra heavy tin, is made in four sizes, and fitted with fine brass strainers at a slight additional cost. A special line of funnels, suitable for the automobilist is also manufactured, in various designs to meet requirements. All of these funnels are fitted with fine brass strainers and movable hoops to hold chamois when chamois is used to

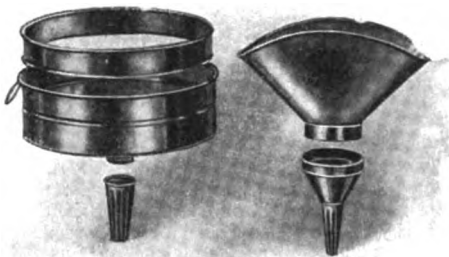

HILL'S FLAT FUNNELS—TWO STYLES.

separate any water that may be present in the gasoline. It is interesting to note that the shape of the funnel is elliptic, thus affording the exact shape of "spilling" liquid, and reducing the space required in the other plane.

Steering-Wheel Grip.—Wet and rainy weather prevailing just at present should stir up a considerable interest in the matter of steering-wheel grips. One of the best of these is the Alpha, made by Parker, Stearns & Company, New York City. This has a roughened tread, if it

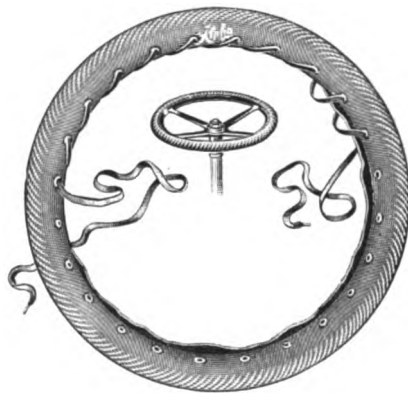

ALPHA STEERING WHEEL GRIP.

may be so called, and is made of rubber, either black or red being optional. The inside portion is open and provided with eyelet holes, so that it may be laced up tight. When this is done a roughened surface, upon which the hands will never slip, is assured at all times regardless of weather. In the interest of safety every machine should have something of this nature added to its equipment where the original steering wheel had a smooth surface.

Don't Lie Down in Grease.—For the benefit of garage men and others who have of a necessity to lie down underneath a car while working on the mechanism, the Portland Garage Company,

Portland, Me., makers of the Repairman's Couch, send this message: "Don't lie down in grease or oil." This couch is made very low and light, and runs on casters, so that it may be utilized under any car anywhere. The head-rest por-

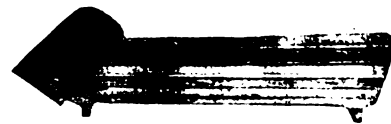

PORTLAND REPAIRMAN'S COUCH.

tion is adjustable, so that the position of the head may be varied to work to the best advantage. The body of the couch is fabric but tightly stretched so as to be springy and easy to lie upon. The head rest, on the other hand, is upholstered so as to be unusually comfortable. In fact, it is almost possible to imagine that after the long use of this, the men might get to like working under the cars.

New Holley Carbureter.—After eight months of constant experimenting, G. M. Holley, of the Holley Brothers Company, Detroit, determined to his satisfaction the exact amount of gasoline and air required by a motor under all conditions of speed and load, and found the following chief essentials: A high vacuum around the nozzle for starting; a perfectly uniform mixture at all speeds, except hill climbing with wide open throttle; no limit as to motor speeds, and a device that would maintain all conditions constant. The accompanying illustration shows a sectional view of a carbureter that has been developed by the Holley Brothers Company to fulfil these conditions. The regulation type of concentric float chamber is employed, but the needle is made adjustable for raising or lowering the gasoline level. The mixing device consists of a taper needle for admitting gasoline *A*, sliding in the taper nozzle *B*, surrounded by the small strangling tube *C*, the needle *A* being con-

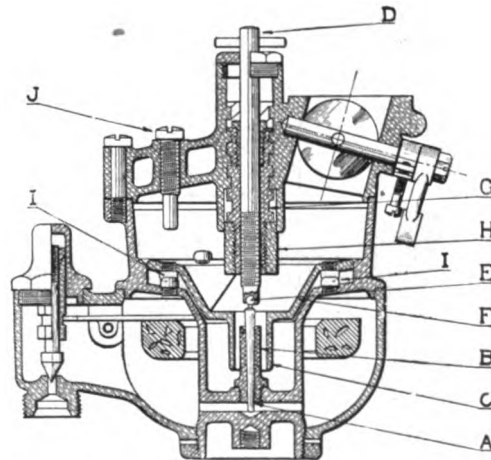

SECTION VIEW OF HOLLEY CARBURETER.

nected to the adjusting rod *D* by the ball joint *E*, which eliminates side thrust and wear in the nozzle *B*. The air valve consists of the strangling tube *C*, and the taper and flanged body *F*, the coarse threaded screw *G* being fastened to the air valve at *H*. The rod *A* and the valve *F* move together, according to the requirements of the motor. *I-I* are bottom stops; *J* is the upper stop. It will be apparent from an inspection of the sectional view in connection with the above description that known quantities are being dealt with

in making adjustments, and once the proportions of the taper needle and the air valve are right they will stay so for good. No springs being employed, conditions in the carbureter remain constant.

New Style of Brass Auto Horn.—The Automobile Supply Manufacturing Company, Brooklyn, N. Y., has added another style of horn to its line for the coming season. The latest Nonpareil horn, as



THE LATEST NONPAREIL HORN.

shown in the illustration, is distinctly novel in design and has a far-reaching, deep, penetrating tone. Letters patent No. 39,746 were issued to the inventor, Louis Rubes, on this horn on January 5 of the present year. Mr. Rubes is the president of the above-named company, and six years ago he started the business with a working force of seven men, since which time it has grown to such an extent that now 246 men are employed, and, besides the Emerson Place and Classon Avenue plants in Brooklyn, a new factory, located at 220-224 Traftle Place, that city, has been added to meet the demand. At the present time the company is turning out 3,000 horns a week. The new horn illustrated above is meeting favor with the trade and bids fair to be one of the most popular sellers among the company's productions.

Patterson Wireless Dry Battery Holder System.—The great ease with which incandescent lamps are screwed into sockets is only equaled by the permanence of the connections and the fact that the electrical contact is good and secure. This same facility is afforded in the Patterson system of assembling dry batteries as used



PATTERSON BATTERY BOXES E AND F.

in ignition systems on automobiles, and it is plain to be seen that the same method allows of the quick alteration of the relations of the cells of battery, enabling the motorist to take advantage of (a) all the cells in series for the maximum voltage, (b) multiple series connections of sets of four cells in such a way as to realize the voltage of four cells and the added capacity of sets of four, as eight, twelve and so

on. The system comprises a substantial moulded composition (rubber) plate, in which is incorporated the component members of the screw tops on the respective cells. The receptacles for the cells are so devised and arranged as to enable a "dead" cell to be removed without opening the circuit. Then, there is an entire absence of wires and other loose details which every autoist regards as a nuisance. It is also a fact that the cells of battery are held in secure and rigid relation by the "plate," with the result that the cells are not chafed, which is beside the fact that inter-cell leakage is prevented in the same way. The sets of battery come in several selections as to size. With substantial and ornamental cases the appearance is up to a high standard of art and utility. Stanley & Patterson, 23 Murray street, New York City, are the manufacturers of the Patterson "wireless," and the reward for business acumen is by way of a large list of satisfied customers, ever expanding.

Vehicle Top Support.—"It is the little things that count." In other words, they count for comfort and satisfaction if they are right, and in the case of top supports it is assured annoyance in the absence of a suitable design, since broken bows in-

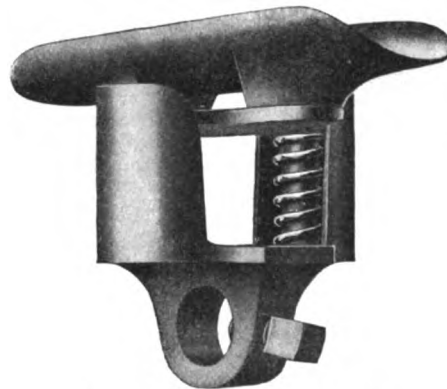

MORAN'S VEHICLE TOP SUPPORT.

terfere with the results. Stephen J. Moran, of Cambridge, Mass., makes a top support (patented) which is here illustrated, and, as will be seen at a glance, it has merit as its companion.

A Wrench for Unhandy Places.—About the meanest situation for a man to find himself in is with a nut to tighten and to have a wrench which for some reason or other cannot be used to tighten it. To cater to this business and to make a wrench that can be used anywhere, the Lowell Wrench Company, of Worcester, Mass., has produced the "Multo" auto-wrench. This has several features worthy of individual mention, thus it is a ratchet arrangement. This allows of tightening up nuts in a situation where the swing of the handle is limited. Another idea is that it is a socket arrangement, fourteen sockets being provided to accommodate the ordinary range of nuts. This is sold in a neat box with the fourteen sockets and the ratchet handle, the wrench being sold only with the unbroken set of sockets. The illustration shows a "ghost" view of the tool box with the ratchet and full set of sockets.

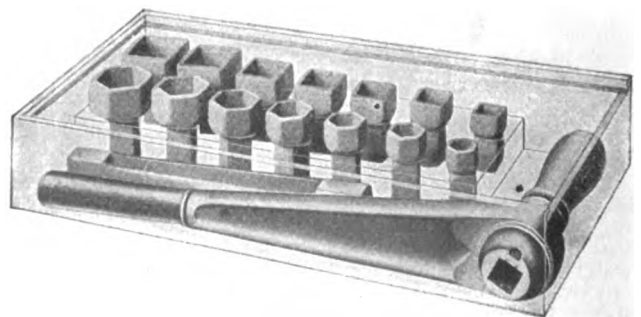

MULTO AUTOWRENCH COMPLETE IN BOX.

New Timken Roller Bearing Axle.—In line with the constant improvement in rear axle construction is the latest product of the Timken Roller Bearing Axle Company shown herewith. The axle proper is a one-piece pressed steel member of smooth

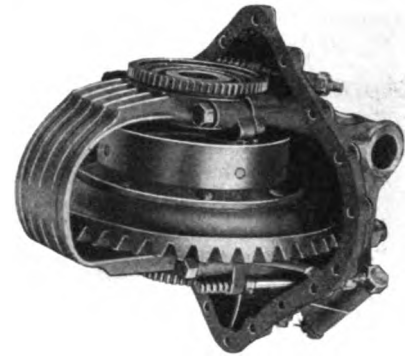

TIMKEN DIFFERENTIAL AND BEVEL CARRIER.

and regular outline. The gradually diverging lines of the tubes between the hubs and the central differential case does away with the angles and joints always found in the built-up types. The differential and bevel gear carrier is a compact unit that can be removed bodily from the axle housing without taking down the axle or disturbing brakes, hubs, or bearings. It is anchored to the front of the case. All bearings can be adjusted from the outside by means of worms. The brakes are internal and external on the rear hubs, 14 inches in diameter by 2 1-2 inches wide. The construction

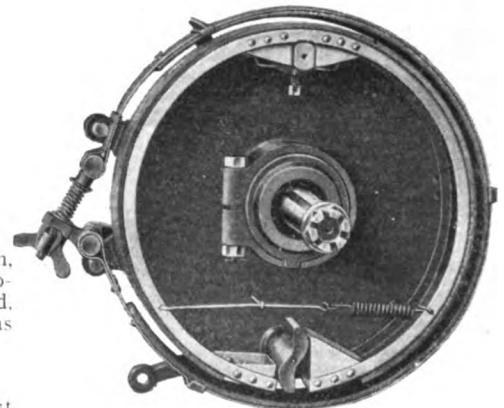

INTERNAL AND EXTERNAL BRAKES.

has been greatly simplified and the number of parts reduced to the minimum. The axle will be made in floating and non-floating types for cars weighing up to 3,000 pounds empty and of 45 horsepower or less. With this form of construction of few parts and simple, the weight is reduced to a minimum without any corresponding sacrifice of strength.

THE AUTOMOBILE

DETROIT HAS A NOTABLY ARTISTIC SHOW

DETROIT, Feb. 17.—Once each year the Detroit Automobile Dealers' Association and local manufacturers tear themselves away from the strenuous task of supplying the rest of the country with cars long enough to demonstrate what a real automobile show is like. They're at it this week, and the pace set is one that will compel would-be competitors to throw in their high speed and then trail along in the rear. Frankly stated, there is no second to Detroit in the matter of appearances. New York's two shows were imposing affairs, as shows go. Chicago's exhibition, in spite of being overdone in some respects, was up to the usual high standard. But none of the three equalled in an artistic way the standard set by the Detroit association at its second annual show, held in the Wayne Casino.

This may seem like an extravagant statement, but it isn't. When Manager E. LeRoy Pelletier was associated with Fred Thompson back in those days that the Pan-American Exposition was in the making, he was given a valuable schooling in the advantage of "dressing up" an exhibit. He has been watching automobile shows ever since, and noting wherein they fell short from the viewpoint of the spectator. Pelletier was brimful of ideas when appointed manager of the local dealers' show a year ago, and in spite of the handicap attendant upon the inadequate quarters in which it was held managed to furnish surprises that long remained pleasant memories, in addition to making the show a financial success.

This year he was again given carte blanche, and with more than twice the space ever before at the command of the local show has provided a revelation. The first thing Pelletier did was to engage the services of Edward Wagner, a sculptor who won distinction with his work at the Pan-American Exposition. Wagner is a Detroit, and put his heart into the task mapped out. The result is apparent.

Expense was no object. It was the understanding that if necessary \$10,000 might be spent for decorations. It was, too. As a matter of fact, when the show was thrown open to the public more than \$11,000 had been expended in preparations. It is well worth every dollar it cost, though. In

planning the exhibition the Detroit Association was not figuring on profits. It wanted to impress on Detroiters and the country at large what the automobile industry meant to the city—and it has succeeded most convincingly and at the same time artistically.

Both floors of the Wayne Casino have been utilized, and so cleverly have the arrangements been planned that one surprise follows another until the climax is reached on the second floor. Entering the Casino, visitors pass into the section set apart for accessories. Never lending themselves well to a harmonious arrangement, it has nevertheless been possible to place them so they show to good advantage in their segregation.

A few steps further on there bursts upon the spectator's view a scene that causes him to gasp with admiration. Stretching away seemingly for a half mile is a vista amid which the highly finished motor cars are singularly at home. Extending from one end to the other of the great hall is lattice work hiding much of the ceiling, and extending down the sides at regular intervals. Twined through this lattice is Southern smilax in profusion, giving an impression of midsummer in marked contrast to the season. The side walls are given over to great paintings representing scenes familiar to local motorists.

Down the hall extend four rows of latticed pillars, the centers of which are formed of colored glass with electric lights enclosed. Thousands of colored electric bulbs are strung about the ceiling and along the sides, and scores of cages containing canaries hidden among the smilax add to the summery effect.

On the second floor Sculptor Wagner was given a free hand to work out the ideas evolved by Manager Pelletier and himself, and the effect is highly pleasing. At the outset Manager Pelletier's cunning in planning illusionary effects is shown. Up a dead black staircase the visitors pass, and are suddenly confronted by heroic sized figures in staff depicting "The Spirit of the Automobile." Seated at the wheel of a car, the lower part of which is enveloped in dust, sits a man bare to the waist. Beside him sits a woman holding in her outstretched hand the palm of victory, while just ahead speeds an American eagle. The surprise is



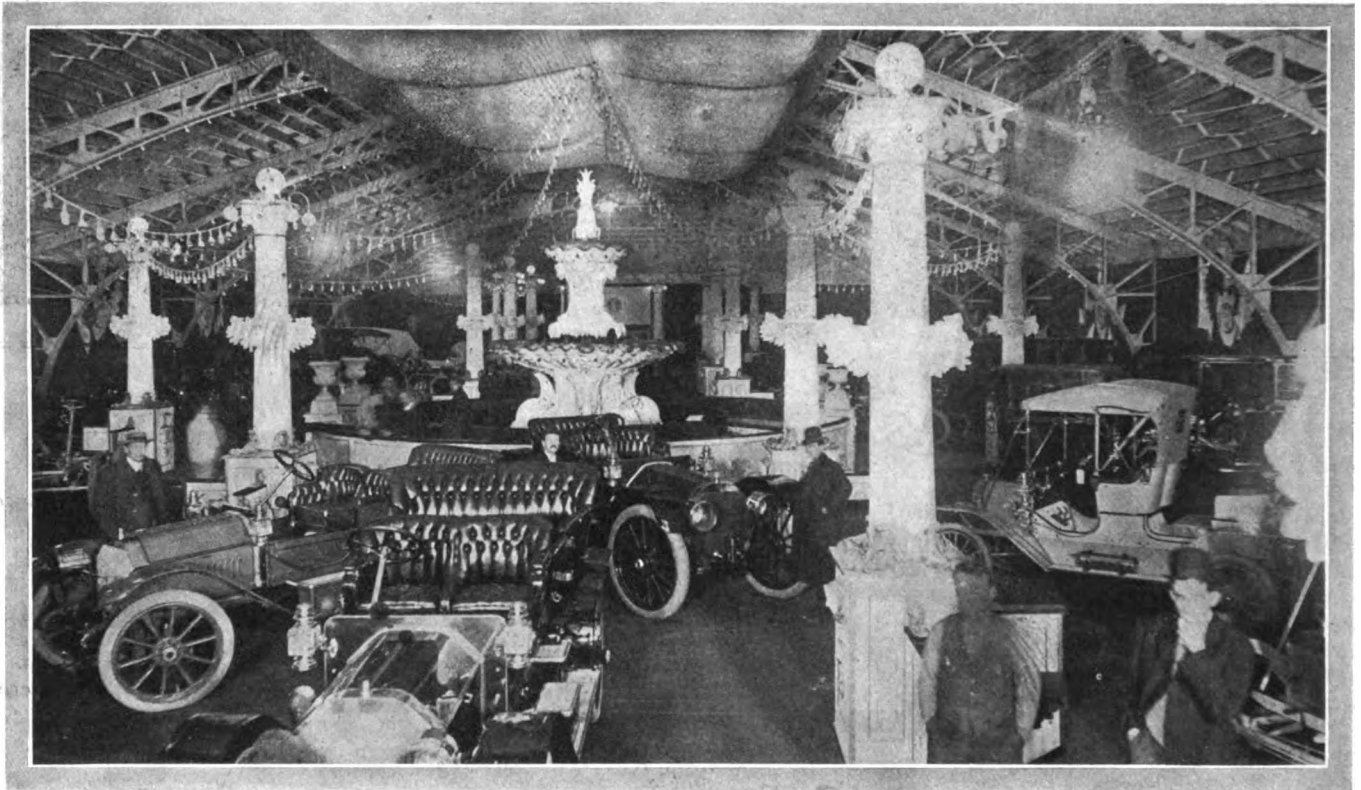

General View of the Detroit Automobile Dealers' Association's Artistic Show.

complete, but it is only incidental to the general arrangement. In the center of the great auditorium rises a thirty-foot fountain of staff, twenty-seven feet in diameter at the base. The upper basin is supported by a half dozen merman chauffeurs, faces set, muscles rigid, hands grasping steering wheels. Surrounding the fountain is an enclosure fifty feet in diameter, bearing at regular intervals the head and shoulders of a motoring girl done in staff. Here the thoughtfulness of these in charge of the show is evidenced, for the enclosure is designed as a resting place for the fair sex, upholstered seats extending entirely around the inside of the circle.

All the standard makes whose names have been familiar in the motoring world for years are much in evidence, comparison with the same cars of a few years since providing an interesting object lesson on the development of the industry since its inception. There are men among those present, too, who witnessed the birth of the industry, chief of them being Henry Ford, Detroit's pioneer automobile maker.

Accessories manufacturers are here in large numbers and are quartered at the west end of the main floor. The commercial vehicles are also housed in this section and are attracting much attention, as is the exhibit of motorcycles.

In spite of inclement weather the opening night witnessed a rush that made it difficult to handle the crowds even with the provision made. Every night has been a repetition of the opener and dealers are elated. Actual sales exceed all previous years, day for day, by a large margin, and from the inquiries made it is apparent that great numbers of Detroiters are in a hurrying mood.

Detroit Has Outdoor Show Idea.

One of the interesting bits of news coming out of this week's show has to do with making Detroit not only the automobile manufacturing center of the country, but the sales center as well. While those back of the movement decline to go into details, the general outline of the plan is to hold an automobile show and carnival in Detroit next August, at which time all the new models will be shown under conditions that are impossible at this season of the year. August is the month tentatively selected, and the State Fair Grounds the place where this novel exhibition will be held. The grounds are easy of access and there is one of

the fastest mile tracks in the country upon which to demonstrate.

Michigan produces 60 per cent. of the automobiles made in America, representing 50 per cent. of the value of this country's output. Millions of dollars are invested in plants, and tens of thousands of men are given employment in the manufacture of motor cars. In Detroit alone 50,000 automobiles will be made this year. Why, then, argue those back of the plan for a mid-summer exhibit here, should Detroit manufacturers be compelled to exhibit hundreds of miles from home at a time when agencies have been placed and every energy is being directed to filling orders.

Detroit and Michigan manufacturers who have been sounded on the proposition are enthusiastic. Detroiters who are just beginning to realize what the automobile and allied industries mean to the city are for it. The Detroit Automobile Dealers' Association, which has shown the rest of the country what a real show is like, is a unit in favor of the undertaking, realizing that it would mean the bringing to Detroit for a week of 10,000 to 12,000 agents and automobile enthusiasts, and give the city even greater prestige than it now enjoys.

List of Firms Exhibiting Cars.

The following is a complete list of firms in the Detroit association exhibiting. This, however, does not represent the full line of cars, as several of these concerns handle four and five different makes, while almost without exception two lines are represented:

E. M. F. Co.	Seldler-Miner Co.
Rapid Motor Vehicle Co.	Anderson Carriage Co.
Cartercar Co.	Ford Motor Co.
J. B. McIntosh Auto Co.	Brush Runabout Co.
Rumsey Electric Co.	Olds Motor Works.
Maxwell-Briscoe-McLeod Co.	J. H. Brady Auto Co.
American Electric Auto Co.	Winton Motor Co.
Grant Bros.	J. P. Schneider.
Regal Motor Car Co.	W. S. Isbell.
Wm. F. V. Neumann Co.	Bulck Motor Co.
Coombs & Gilmour.	Standard Auto Co.
Cadillac Motor Car Co.	

This list does not include the power wagons or accessories manufacturers and dealers, of whom there are many.

For the success of this year's show, in addition to their own efforts, the Detroit Automobile Dealers' Association can thank Manager Pelletier, and George Lane, president; John P. Schneider, vice-president; Robert K. Davis, secretary, and J. H. Brady, treasurer, who have worked untiringly for the good of the cause.

ST. LOUIS SHOW HAS BLIZZARD BEGINNING

ST. LOUIS, Feb. 15.—Struggling with a blizzard of no mean proportions, the exhibitors at the third annual show of the St. Louis Manufacturers' and Dealers' Association had some difficulty in getting their cars to the Coliseum in time for the opening to-night, but were in the end successful. In spite of the difficulties of transportation and of walking in the streets, a goodly number of automobile enthusiasts were present, and were immensely pleased with what they saw.

This, the first show held in St. Louis under the management of a committee from the Manufacturers' and Dealers' Association, might be classed with the greater of the minor shows, although it is the first time that a St. Louis exhibition has merited the classification. Approximately 130 cars are displayed by some forty exhibitors. The figures are more than double those of last year or the year before, when the show was held at the Jai Alai Building in the West End.

A large part of the show—at least nearly 30 carloads of automobiles—came from the Chicago show. Nineteen of these cars came by fast freight in an automobile special. Six more were sent by a special express running on passenger schedule, and one car was attached to a regular passenger train. The distribution of these machines at the Coliseum began as early as Sunday afternoon, and by Monday morning early the cars in the 19-car load shipment began to arrive at the Coliseum and at the same time snow began to fall, which had increased by night to a blizzard. If there had been any motor trucks available for the transportation of the automobiles from the freight yards to the Coliseum there would probably have been no difficulty, but most of the machines were hauled by horse-drawn wagons which had trouble with the snow. To overcome the difficulty many of the machines were dismounted from the sluggish wagons and run under their own power.

The only car shown here for the first time was the Frayer-Miller, which did not appear at either of the New York shows or the Chicago show. Besides several pleasure cars, a Frayer-Miller truck without body was exhibited.

The local dealers, some of them handling several makes of cars, exhibited as best they could and were in nearly every case ably assisted by their factories. The several local manufacturers, including the Moon Motor Car Company and the Dorris Motor Car Company, gave about the same exhibits that they had at the Chicago show, although the Moon was slightly limited for space here. It is said that the Moon cars that were to have been brought back from Chicago were sold at the Chicago show by a new agent demanding immediate deliveries, and the St. Louis exhibit had to make up from cars in stock at the factory.

To have the decorations complete, Chairman John J. Behen and acting manager, Lloyd Rickert, worked all through Saturday night and Sunday without sleep, but the result was worthy of their trouble. The illumination was particularly good—as it not always is at auto shows.

Besides the attraction of the 1909 cars, many of them shown in St. Louis for the first time, the management provided motion pictures of the Savannah Grand Prize Race and the Grand Prix at Dieppe. At one end of the auditorium the mammoth Gabriel horn was played, while at the opposite end of the building a large band helped to make things lively.

A large list of cars never exhibited in St. Louis before were on view, including the following: Darby and Victor, made in St. Louis; Stoddard-Dayton, Mitchell, Overland, Atlas, Woods (electric), Oakland, Franklin, Rambler, E-M-F, Studebaker (gasoline), Jackson, Regal, Stanley (steamer), Detroit (electric), Marmon, Chalmers-Detroit, Cadillac and Frayer-Miller. The

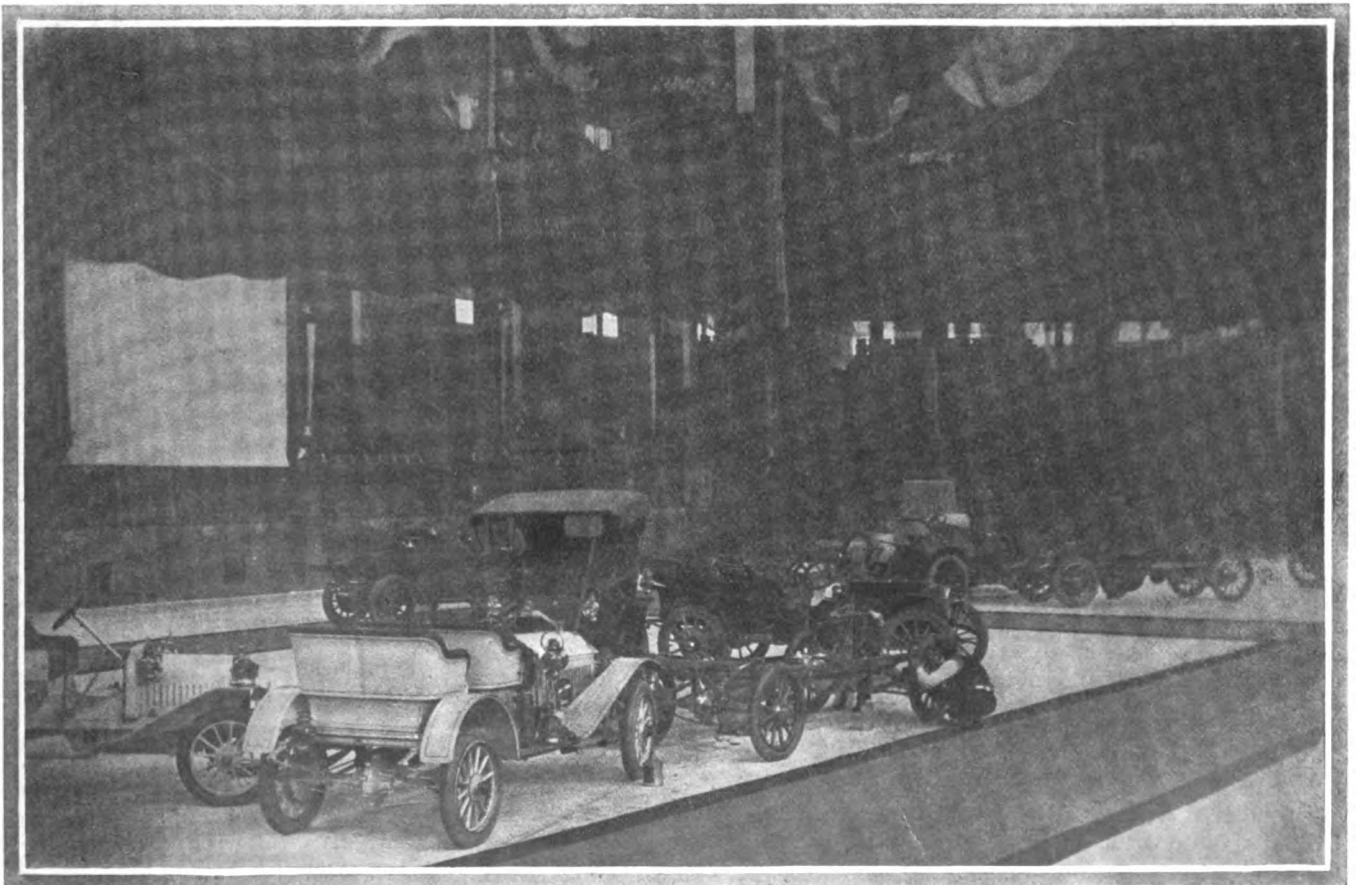

Installing the Exhibits of the St. Louis Automobile Show in the Big Coliseum.

Locomobile and Apperson cars, handled by the Capen Motor Car Company, were exhibited at the Hotel Jefferson.

The complete list of exhibitors follows:

MAIN FLOOR.	Dorris Motor Car Co.
Peper Automobile Co.	ANNEX.
Moon Motor Car Co.	Henderson-Willis Wld. Cut. Co.
Union Electric Car Co.	J. Curtis Barcus.
John Deere Plow Co.	Olds Motor Works.
South Side Automobile Co.	Phillips Automobile Co.
Park Automobile Co.	Woods M. V. Co., W. C. Lewis.
Victor Automobile Mfg. Co.	Darby Motor Car Co.
Doyle-Curran Motor Car Co.	Felix R. Chaudet.
Weber Implement Co.	Hurck Motor & Cycle Co.
Delmar Motor Car Co.	Vehicle Top & Supply Co.
Swingley Motor Car Co.	Success Auto-Buggy Mfg. Co.
Bagnell Automobile Co.	Dorris Motor Car Co.
Van Automobile Co.	T. B. Jeffrey & Co.
Maxwell-Briscoe M. V. Co.	Electric Auto & Battery Co.
C. F. & J. R. Brown.	ACCESSORIES
Mississippi Valley A. Co.	Behen-Faught M. C. Equip. Co.
Colonial Automobile Co.	Phoenix Auto Supply Co.
Bulck Motor Co.	Tamm Oil Refining Co.
Halsey Automobile Co.	West St. Louis Mach. & Tool Co.
Western Automobile Co.	T. L. Horn Trunk Co.
Ford Motor Co.	Traveler's Insurance Co.

BUFFALO SPORTSMEN'S SHOW PLANS.

BUFFALO, Feb. 15.—Under the auspices of the Buffalo Launch Club and the management of Dai H. Lewis, the Annual Power Boat and Sportsmen's Show, which will be held for a week beginning with March 8, is promised to Buffalonians as a "spectacular revel, replete with many amusement features." Manager Lewis has placed no limit upon the expense necessary to make it a success and has embodied many new points in decorations, equipment and in the quality of the exhibits.

In the matter of decorations, he will "provide a perfume effect by lavish use of hothouse flowers, a forest effect of trees in staff, with a wild animal and ornithological display in their branches, and an electrical effect which will throw a brilliant dazzle over all," according to Dai. Many applications for space have been received.

BLUE BOOKS FOR 1909 WILL MEET ALL REQUIREMENTS

THE assurance with which various clubs, leagues, and associations prognosticate future usefulness and unblushingly appropriate what has been done by others, is paralleled only by a vivid and optimistic imagination of the temperature of the tide undulating under the serene and soliciting sunshine of the month of May, which invitingly says, "Come in; the water is warm."

For the information of the tourist who may not desire to personally test the temperature of the ebb and flow of these multitudinous tides promulgated solely for his benefit, but incidentally to sustain an ebbing financial situation, an accurate and timely thermometer should be a valuable instrument.

Whatever is of assistance to the automobile tourist, whether of public or private origin, is to be commended, but he must not be misled either by the promise of doing in a day what requires months of laborious effort or by captious criticism of what has already been accomplished to the satisfaction of many thousands of automobilists.

Even "The Official Automobile Blue Book" did not at first contemplate the enormity of the undertaking when, several years ago, its publishers began the work of authentic road directions, and, while equipped with every facility and enjoying the co-operation of every club and thousands of motorists, it was still found necessary to travel by automobiles equipped with editors experienced in writing road directions and expert draftsmen with ready pencil to sketch intricate places from which hundreds of outline maps could assist the descriptive text.

The "Blue Book" began its work in 1903, since which time it has been issued annually, no expense having been spared to make each succeeding edition complete, authentic, and timely

ALL READY FOR NEWARK'S SHOW.

NEWARK, N. J., Feb. 16.—Everything is ready for the opening of Newark's Second Automobile Show in the Essex Troop Armory on Saturday. Workmen have been engaged all week in the laying of the floor, and the decorators have practically finished draping the armory building in the National colors. Every inch of floor space has been taken, and the show will be a very representative one. There will be about thirty different makes of cars on exhibition, and included in the list will be the Acme, Brush, Cadillac, Chalmers-Detroit, Ford, Crawford, Fiat, E. M. F., Grout, Jackson, Isotta, Kissel-Kar, Locomobile, Marmon, Maxwell, Mitchell, National, Oldsmobile, Overland, Pennsylvania, Pierce-Arrow, Peerless, Premier, Rambler, Regal, Reo, Stevens-Duryea, Stoddard-Dayton and White.

There will be about 75 or 80 cars on view during the week, aside from a complete line of accessory exhibits. An elaborate program has been arranged for the week, which will include music every afternoon and evening and a moving picture exhibition every night.

The show will be opened by George E. Reeve, president of the Newark Board of Trade, who will deliver an address from the balcony of the armory building at 8 o'clock Saturday night. This address, which will open Newark's biggest and best automobile show, will for that reason be of absorbing interest to those present. It is expected that society will turn out "en masse."

Wednesday night will be set aside for the New Jersey National Guard and will be termed "Troop Night." Thursday night will be "Club Night," and the show will be attended by members of the various automobile clubs of New Jersey. On Friday night the show will be attended by the New Jersey automobile dealers. There will be several meetings of automobile clubs during the week, the most important of which will be that of the Associated Automobile Clubs of New Jersey, which will be held at the show on Thursday evening, when legislative matters will be discussed.

as to the modifying conditions of each season. The 1909 edition, the first section of which is now on the press, will consist of four volumes, covering respectively (1) New England, reaching into New York State; (2) New York, reaching the Middle West; (3) New Jersey, Pennsylvania, and the South; (4) Chicago and the Middle West, comprising 2,642 pages of text, assisted by 700 outline maps, all strictly originally constructed and executed. The text, besides carefully prepared directions from notes made from an automobile on the spot, contains largely cyclometer reading of distances and useful information of reliable hotels, garages, and matter of general interest. Upwards of 100,000 miles covering main trunk lines have been thus accurately recorded, with changes from year to year covering local conditions, until the "Blue Book" work has become the recognized authority in all localities east of the Mississippi and has unwittingly formed the groundwork of many club touring sections dependent on it for its information, and numerous imitating competitors, who copied even the errors it contained.

Meantime the "Blue Book," unheralded by flaming prognostication or competitive organization, is *per se* a wholesome supply of authentic information for tourists in the territory covered, which is available to the public generally, without red tape or trapping, as a strictly private enterprise on a basis of minimum expense for actual service rendered.

While the "Blue Book" does not predict its future or cast a horoscope for others, it is proud of the work it has already accomplished, and is fully satisfied that its efforts have been and will be appreciated. The "Blue Book" series come from the Class Journal Company, 231 West Thirty-ninth street, New York, and 1200 Michigan avenue, Chicago.

CHICAGO'S SHOW RESULTS IN PLENTY SELLING

CHICAGO, Feb. 13.—The big Chicago Show which to-night came to a conclusion supplied a total of business done never before equaled by an automobile exhibition in this metropolis of the West. Of course, figures of all kinds are current in regard to the sales accomplished, but a conservative estimate of the grand total involved in cars purchased directly or indirectly as a result of the show would reach a mark not far from two million dollars.

"It is my judgment that the sales averaged ten cars for each exhibitor," said Manager S. A. Miles, "although it is impossible as yet to give anything like definite figures."

In the matter of attendance something close to one hundred thousand people undoubtedly passed the entrance doors of the Coliseum and First Regiment Armory. A study of the throngs that attended made apparent the fact that many had come from quite a distance in order to get a look at the 1909 products of both licensed and unlicensed manufacturers.

That a national show of this character is satisfactory to the average buyer was plainly apparent. It has been suggested in regard to New York another year that one show follow immediately upon the heels of the other, and perhaps be held in the same building. This plan would permit people to attend the last few days of the first show and also attend the succeeding exhibition. Much comment in favor of such a plan has been heard in Chicago, and it is not improbable that something of the sort may be arranged. This would permit accessory makers to exhibit at both shows with lesser expense and greater convenience to themselves. It is understood that efforts along this line have been discussed.

Among other subjects considered at the two days' conference of the traffic managers of automobile factories during the Chicago Show was the question of suitable freight cars for automobiles. The facilities of the railroads are being taxed more and more

by the increasing output of the automobile industry and the traffic managers of the respective lines are anxious to provide freight cars that will secure for them a portion of this attractive business.

General Traffic Manager J. S. Marvin, of the National Association of Automobile Manufacturers, presided at the meeting, and pointed out the necessity of arriving at a uniform recommendation to the railroads so that the new freight cars built for this purpose would suit the requirements of all factories. The meeting recommended the double side-door plan of box car, which gives an opening ten feet in width and nine feet or more in height, placed diagonally opposite each other in the car. Such doors permit the loading of the largest machines. For double-decking purposes, that is, the loading of an extra tier of machines above those on floor, car should also have one end door ten feet square. This double-decking is accomplished by means of a skeleton work of timbers, and the plan is coming into favor for shipments of the smaller class of machines long distances, where the freight rates are high and where the minimum weight charged by the railroads is considerably in excess of the actual weight that can be loaded on the floor of the car only.

It was found impossible to recommend at the present time any one length of freight cars, owing to the fact that the railroad companies in the different parts of the country have conflicting rules as to minimum weights on cars of different lengths. For shipments to the Pacific Coast 50-foot cars are in demand. Other sections of the country 36-foot cars are favored, owing to the fact that a penalty in the shape of higher minimum weights is assessed by the railroads on longer cars.

An arrangement of particular interest to the Pacific Coast trade was effected whereby G. F. Detrick, chairman of the Automobile Trade Association of San Francisco, will, in connection with similar trade associations in other Pacific Coast cities, act as the Pacific Coast branch of the National Associa-



Thomas 6-70 Flyer, Midwinter Record, Denver to

Chicago; Distance, 1,400 Miles; Running Time, 114 Hours.

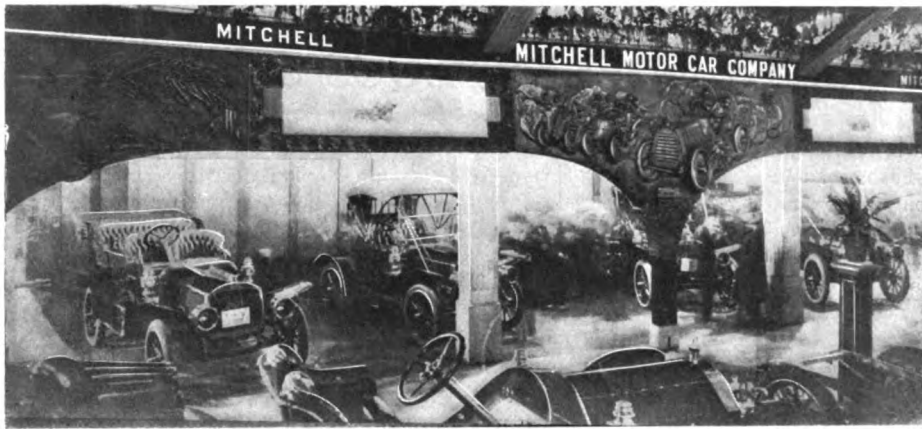

Mitchell Thirty, with Magneto Ignition, in the Foreground.



Pennsylvania with a Model D-25 Selective Three-Speed Shaft Drive.

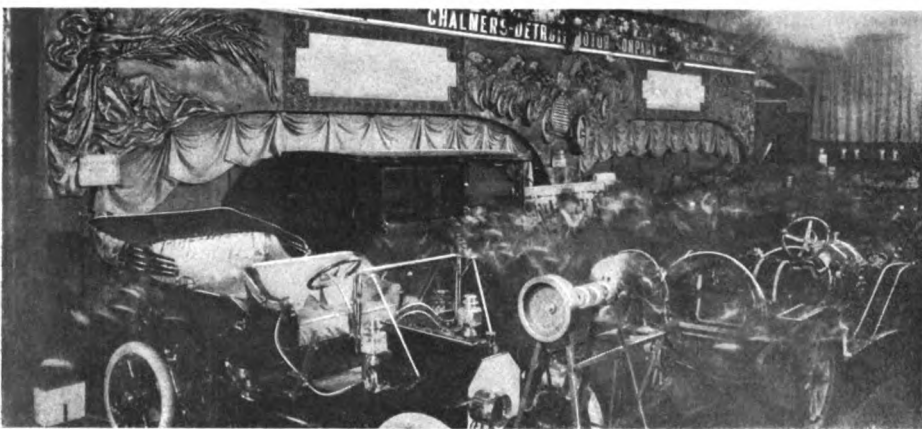

Chalmers-Detroit Thirty with En Bloc Cylinders.



Oakland Thirty Roadster with Thermo-Syphon System of Cooling.

tion's traffic department. It is expected that this arrangement will result in bettering the shipping conditions as they now exist with respect to that territory.

Record Run of a Thomas.

The Thomas people made considerable capital out of the finish of the Denver-Chicago record run of Wesley Smith, who wound up his trip at the Coliseum at 8:10 o'clock Wednesday night. Smith had smashed the Denver-Colorado Springs record in a Thomas six, cutting eight minutes off the old mark, and, enthusiastic over this, he decided to try for a mid-winter mark to the Chicago show. He left Denver at 1:15 o'clock Wednesday afternoon, February 3, being accompanied by A. E. Blanchard from the Thomas factory, James McDonald, a mechanic, and two newspaper men. The roads were in frightful condition because of the frozen mud, but by 9 o'clock Thursday night the car had reached Julesburg, Col. Omaha was made by 6 o'clock Saturday night. The Iowa roads were worse than the ones in Colorado. The gumbo mud forced the crew to work for hours at a time with block and tackle to get through. At one place the car broke through the ice crossing a river and it took twelve hours to get it out.

"From this point on it was even worse," said Smith, in describing the run. "Instead of getting better, the roads became worse, and when we reached the Illinois line we struck the terrible blizzard of the 7th and 8th. The intense cold and driving sleet forced us to seek shelter for the first time or perish with the cold. We arrived at Morrison, Ill., at 12 o'clock February 8, but after stopping a few moments we again took to the road and managed to reach Sterling, where we were compelled to rest. Leaving at a late hour Wednesday, we bucked the snow drifts and managed to reach the Coliseum at 8:10 o'clock.

"The total distance between the two cities is about 1,400 miles, which we made in 114 hours actual running time. We were in bed only two nights, the balance of the time taking turns sleeping in the tonneau. We came through without a replacement. Our car is a 70-horsepower six-cylinder, and was completely equipped except that we had no top.

"This car and driver also hold the record between Los Angeles and Goldfield, Nev., of 20 hours, but the trip from Denver was the hardest it has ever made because of the road conditions. We covered some of the distance that will be on the Glidden tour route next summer if it goes to Denver, but if dry weather favors the tourists there should be little of the trouble that was experienced in midwinter. We also tried some of the rules proposed for the transcontinental race, that of sleeping in the tonneau, and found that it could at least be done successfully, but there was little rest secured. The fact that it took three days to cross the State of Illinois alone is an illustration of the difficulties encountered.

APPERSON IGNITION PATENTS.

By VICTOR LOUGHEED.

CHICAGO, Feb. 15.—There was much talk during the Chicago show concerning the Apperson patents on double ignition, which are claimed by the Apperson interests to cover basically every possible system in which two or more spark plugs are used. It is not claimed that the dual ignition systems, in which appears one set of plugs in combination with a double current source, infringe, but that some sort of a fight on the others is in the air can scarcely be doubted. Already a number of manufacturers admit having received infringement notices while the Apperson people stoutly and openly defend their position.

Among the very considerable numbers of offenders there is a variety of attitudes. Some of the more timid appear secretly worried to such an extent that it will not be surprising if in the near future several manufacturers that had decided double ignition to be good should decide on second thought that the simpler system is better after all, and revert to it forthwith. Others preserve a non-committal attitude to the extent of flatly refusing to discuss or opionate on the subject. And, finally, very numerous indeed are those who discount the claims of the Kokomo pioneer and declare that they are waiting for him to attempt his worst. Bartholomew, for example, builder of the Glide, exhibited a three-cylinder casting made by him for Charles E. Duryea in 1894, in which appears provision for jump spark in addition to the regulation make-and-break ignition used on the stock machines produced by the Reading man. Duryea himself is outspoken in his opinion that the Apperson device was too long anticipated to be made the subject of a valid patent, while there are even those who whisper that a search of European stationary-engine practice will reveal double-ignition employed as early as twenty years ago. Patent sharps, too, suggest that the Apperson claim only purports to cover simultaneous ignition at two or more points within a cylinder, and, therefore, has no bearing on the mere provision of double systems adapted to use in alternation rather than in conjunction.

It at least admits of no doubt, should the courts sustain the Apperson claims, that a very fat slice of automobile profits for a while will trend Kokomoward, until back royalties are settled and ignition systems reorganized. This is sufficiently evident from a consideration of the threatened infringers, whose numbers and standing as strongly attest the popularity of double ignition as their more or less outspoken disapproval attests the unpopularity of the attempt to monopolize it.

In the Stoddard-Dayton cars one side of the system derives its current from a Bosch high-tension magneto, while the other secures it from a six-volt storage battery, worked in conjunction with a standard multi-vibrator coil of well-known make.



Atlas Two-Cycle Model F is Fitted with Atwater-Kent Ignition.

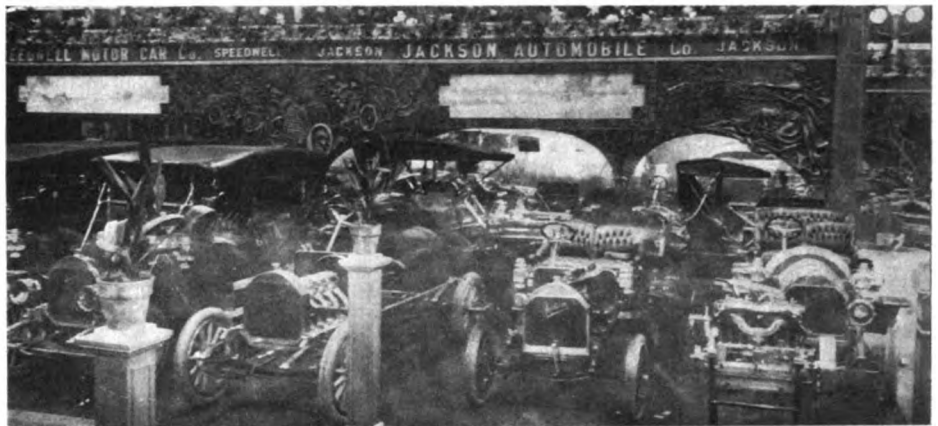

Jackson Model H is the Center of Interest, Especially the Roadster.



A Sea of Originality with a Runabout to Whet the Interest.

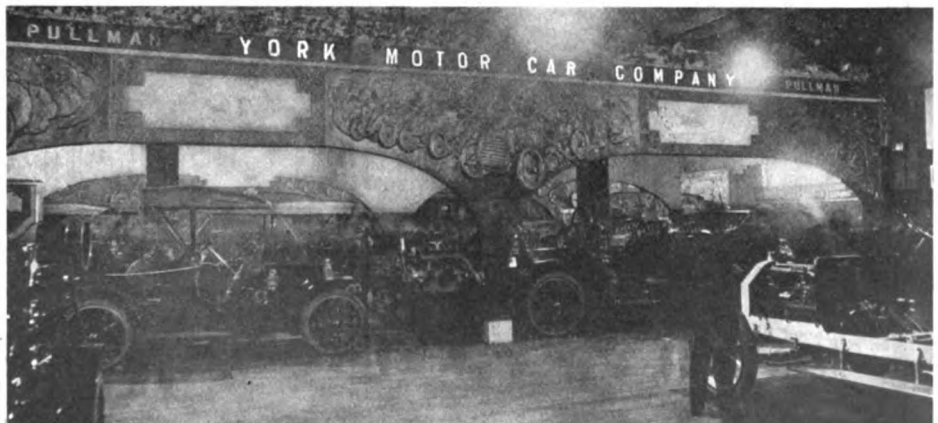

Pullman Model L with Selective Three-Speed Geared Roadster.

The same system is used in some of the Rambler models, except that a Splitdorf single coil with master vibrator is employed, and that the eight plugs are in the eight valve caps.

Another example of the same general type appears in the Oldsmobile, in which the Bosch magneto and six-volt storage battery are in combination with a multi-vibrator Heinze coil, with the plugs through the valve caps.

The big Austin cars employ a Splitdorf magneto, and, on the battery side, six dry cells with a Splitdorf master-vibrator coil. The spark plugs pass directly through the cylinder heads.

Special interest attaches to the Haynes scheme, this car being turned out by Apperson's former associate. Moreover, in the particular feature in question it practically duplicates the Apperson, Bosch high-tension magneto, six-volt storage battery, and two plugs paired through each intake valve cap being the details in common. In the Haynes, however, a single coil with master vibrator is favored.

Pierce cars have one set of plugs in the cylinder tops and one in the inlet valve chambers, with Bosch high-tension magneto on one side of the system and six-volt storage battery on the other. Separate vibrators in the Autocoil pattern are used.

The Premier construction involves primarily the Bosch low-tension magneto with the mechanical make-and-break through the inlet valve caps. The alternative system, worked from a six-volt storage battery through a Pittsfield distributor and single coil, connects to plugs in the sides of the inlet-valve chambers.

Bosch high-tension storage battery, and Splitdorf coil tell most of the Bartholomew story. The eight plugs are in the eight valve caps. The two systems can be used together.

In the Corbin cars, the purchaser is offered the alternative of Bosch high-tension or low-tension magnetos and plugs, with a six-volt storage for the battery system, in conjunction with a Connecticut multi-vibrator coil. Each plug is in a valve cap.

The Knox is the same as the preceding, except that the low-tension option is not given.

In the Lozier, the eight plugs are in the eight valve caps, with a Connecticut master-vibrator coil on the battery side. Otherwise the specifications are the same as in the other high-tension Bosch and six-volt storage battery systems.

Bosch, Eisemann, Splitdorf, or Dow at the extra price is the range of options in high-tension magnetos offered by the Cadillac people in their new model. The regular equipment, on the battery side, is six-volt storage, with Jacobson & Brandow multi-vibrator coil. Plugs are in the valve caps.

A storage battery with Leavitt distributor and Bosch high-tension magneto constitute the combination approved by the National. Plugs are in valve caps.

The two-cylinder American Simplex is the first of its type to appear with duplicate ignition. Bosch high-tension magneto, six-

volt storage battery, Heinze multi-vibrator coil, and plugs through the cylinder heads constitute essential specifications.

Stevens-Duryea uses Bosch and storage battery in combination with multi-vibrator Pittsfield and Connecticut coils, the plugs being in the valve caps.

A double system of rather unusual but of some years' standing is the combination of dry cells and Bosch high-tension magneto in the Thomas cars. The Atwater-Kent device keeps down current consumption on the battery side. The plugs are in the valve caps.

The rechristened Toledo cars tie to the all but invariable Bosch high-tension magneto and six-volt storage battery. The coil is Splitdorf multi-vibrator, and plugs are through cylinder walls.

Dependence mainly on the Bosch high-tension system is evident in the big Stearns model, in which the alternative Connecticut multi-vibrator coil takes its current from dry cells. The plugs are slanted together in pairs in the inlet valve caps.

The Welch ignition is the same as that of the Toledo, except that the Connecticut multi-vibrator coil is offered as an option, and the plugs are close together in the cylinder heads.

Similar to the foregoing is the Pullman system, except that in the coil is the Connecticut master vibrator. The magneto plugs are in the cylinder heads and battery plugs in inlet valve caps.

The plugs each in a valve cap, the use of dry instead of storage cells, and the fitment of a Pittsfield multi-vibrator coil are the only important differences between the Speedwell and the preceding ignition system.

Lambert cars carry the Remy magneto, six-volt storage battery, and Kingston multi-vibrator coil. The plugs are in the valve caps.

The Mora scheme is the same as that of the Speedwell, with the substitution of storage for dry battery.

Moline ignition differs from that of the Speedwell only in that the Pittsfield master vibrator coil is provided.

The Halliday cars are equipped like the Moline, except that the Pfanstiehl multi-vibrator is on the dashboard end.

In the six-cylinder engines of the Fort Pitt Motor people, a Connecticut six-vibrator coil with six-volt storage battery is on one side and the Bosch high-tension on the other. Plugs are paired in inlet valve caps.

Another "six" is the Ricketts with U. & H. magneto, dry cells, master vibrator, and plugs in opposite sides of the cylinders.

Only the 50-horsepower car of the Marmon line qualifies in the double ignition class. It has Bosch high-tension magneto, dry cells, Heinze multi-vibrator coil, and two plugs in each inlet valve cap.

The Auburn arrangement almost duplicates the foregoing, but the plugs are distributed one to the valve cap, and a six-volt storage battery is preferred to the dry cells.



Three Characteristic Accessory Stands that Attracted Much Attention at the Chicago Show.

TREND IN TRANSMISSION PRACTICE

By Thos. J. Fay

Chapter III

IT is not enough to have in hand physical properties of the steel if it is true that the results are to be of the greatest possible magnitude. The steel should be investigated from the several points of view and an attempt should be made to locate the limits of utility very definitely. As a good aid to the process it is well to heat treat the steel in divers ways, and if a microscope is not available, have photomicrographs taken of the steel under the several conditions. If the steel can be viewed under a microscope at about 350 diameters, it will be possible to arrive at a very substantial conclusion as to the respective physical characteristics of the structure.

In this class of work, as in everything, it is pretty nearly sure that if the steel looks good it is good. It will be shown in this article that the structure of the steel changes as the heat treatment is altered, and an attempt will be made to illustrate the fact that it is the structure that looks close and uniform under the microscope that is the structure to depend upon in general practice. The only reason for thus entering into this phase of the subject is to assure the interested reader of the fact that it will be unnecessary to hesitate to take an interest in this phase of the subject, giving as a reason the fact that it is rather deep water.

Closer acquaintance with the appearance of structures will come in time, and as the structure unfolds to the eye of experience the story will broaden and the benefits will multiply. In the meantime there is no denying the fact that the benefits that will follow even crude attempts are well worth while. Take, for illustration, the photomicrograph H-5, which is of chrome nickel steel, and it is plain to be seen that the structure would hold out little promise by way of shock ability. Compare this structure with H-4 of the same material, and it will be seen that in H-4 there is no indication of the whitish zones characteristic of "burnt" steel.

Both of these specimens were of the same material, both were treated in the same way, but the specimen H-4 was carefully heat treated, while the specimen H-5 was allowed far too much liberty in the process, and it was reduced to the level of no value, in that it was "burnt." Both of the specimens belong to the brand of chrome nickel steel marked BND in the table of steel products to set before the designer. The notched bar test of this steel in the treated state, with a structure as shown in H-4, was given as 360 foot-pounds (Fremont). The same steel "burnt," as shown in H-5, would not be worth recording. Under these circumstances it is plain to be seen that it is not the steel which indicates failure in many cases.

Indeed, it is quite true in this class of work that failure is very frequently due to wrong treatment of the steel. On the other hand, there is something to be said of steel which is too easily depreciated in the process. Steel should stand a certain amount of irregularity in treatment, and it should bend to a "corrective" retreatment to a fair extent. If steel is overheated it should be reannealed, and in the reannealing process it should be possible to restore the structure, as a rule.

With a view to showing the extent to which annealing will render the structure close and of a uniform texture, the photomicrograph H-3 is given. But if the steel is annealed, in the absence of the tempering process the structure will look as it does in H-2. On the other hand, if the steel is tempered and not annealed it will take on the structure as seen in H-3a, if the normal steel looks as it does in the view H-1. All the photomicrographs as above given are of chrome nickel steel of the grade BND in the table of the products as given.

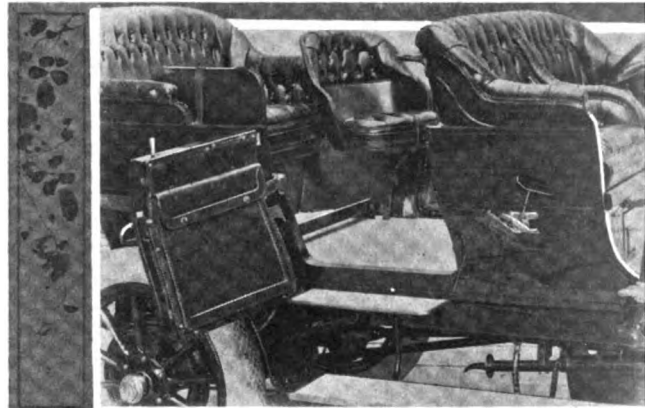

PIERCE-ARROW
WITH UNOBSTRUCTED
WIDE ENTRANCE

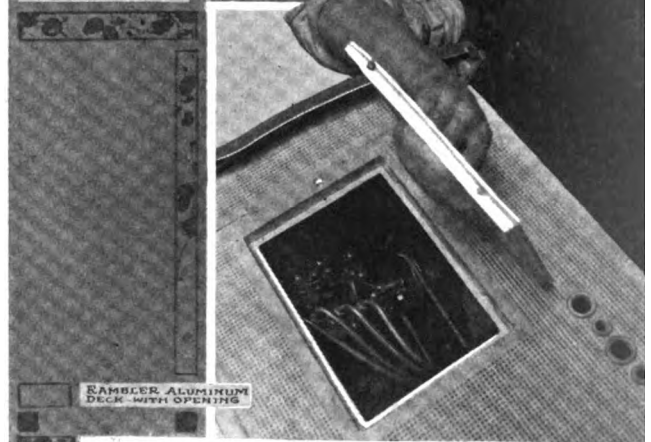

SAMBLER ALUMINUM
DECK WITH OPENING

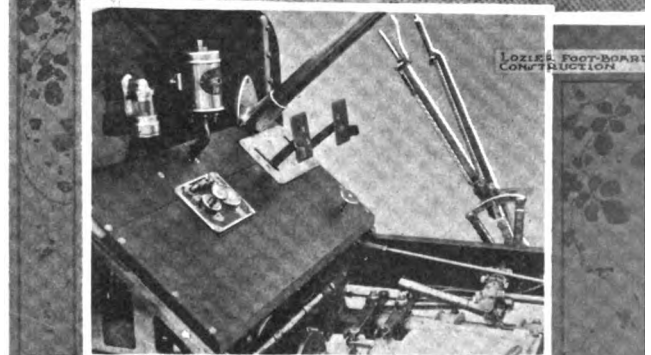

LOZEE FOOTBOARD
CONSTRUCTION

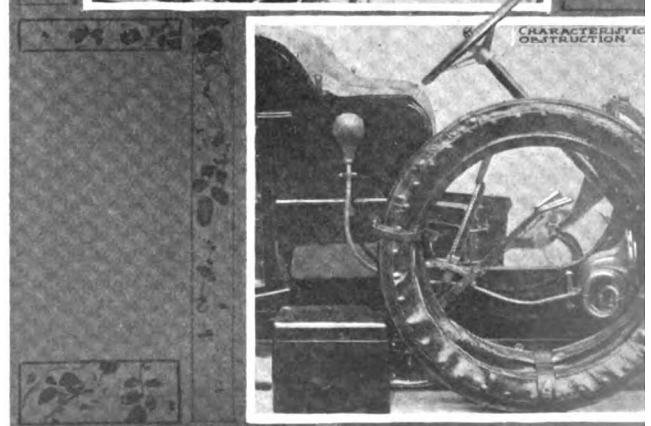

CHARACTERISTIC
CONSTRUCTION

Of the BND products, H-1 was magnified to 580 diameters and the remaining products of the same brand were magnified to 350 diameters. The photomicrographs are somewhat better than the average, due in a large measure to the fine quality of the steel. The steel is used for gears of the highest grade, in which the faces of the gears can be as low as 3-4 inch, considering a 30-horsepower transmission gear set, and the low-speed pinion, six pitch, 14 teeth.

In the same fashion it is possible to know the appearance of all the grades of steel and to know as well the condition in which the material resides. It is necessary to know this in order to fix upon the treatment to give the steel in any given case. Indeed, it is not always possible to procure material from the mill and assume that it is in the "normal" state. Then there is the question of what constitutes normal steel. Some mills send the steel out as rolled, more anneal, but the annealing temperature is not always the same, nor is it true that the product is always rolled to the same limiting temperatures.

By way of indicating the extent to which steel changes in structure, as a result of changes in composition, the photomicrographs as follows are offered: 18-E is a chome vanadium steel,

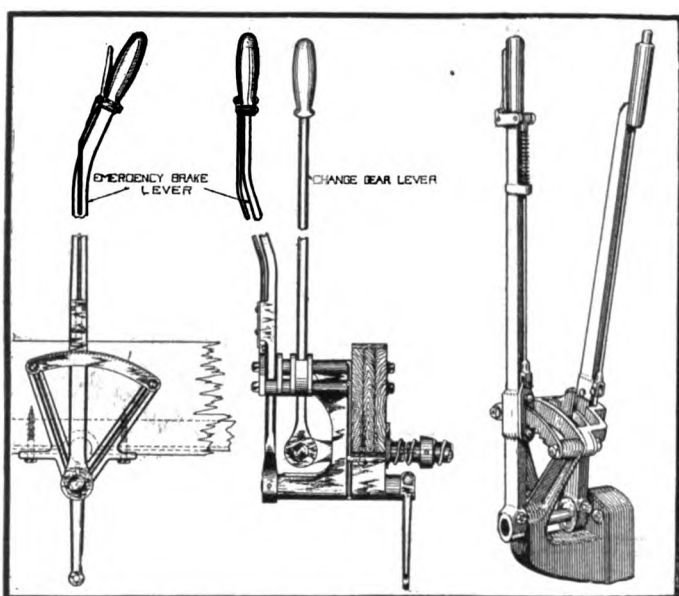

Fig. 15—Franklin Brakes and Change Gear Control.

Fig. 16—Characteristic Side Lever System.

with 16 points of carbon, low in vanadium and chromium, made by the basic open-hearth process, magnified to 350 diameters, after deeply etching and vertical illumination. The steel is in the normal state, and, with a view to showing the result of cementing, the core of a cemented section is given in 20-E, after quenching 850 degrees centigrade.

Just to show the contrast, it will be possible to give a photomicrograph, BO-1, of a specimen of 25 carbon basic open-hearth steel, the same in the annealed state. This steel is magnified to 250 diameters and was annealed from 800 degrees centigrade. It is of no value in gear work of any sort, such as should go into automobiles, and a comparison with some of the other products is enough to indicate the fact.

Importance of Straight-Line Levers and Linkages.

With suitable materials at hand the next question is to contend against all eccentric features of design, not only in the levers and in the linkages, but throughout the transmission system. It is quite out of the question to expect even fair results if all the lever rods are with crooks in them; the quality cars of the present time are noted for clean straight designs, and history, as it relates to cars which failed to come up to the best requirements, records the fact that no attention was paid to this important matter. A strut or a strain member will do its best

work if the same is straight, in the plane of the strains and free from all diagonal tendencies. That it is possible to avoid interferences is proven by the large number of cars on the market in which every lever, rod, and relating member is straight and true, barring the crankshaft in the motor, which, of course, has to be capable of performing the reciprocating functions.

A curve in a lever marks the point at which the load will concentrate, hence the point at which deformation will be first noticed. Economy in the use of metal, for a given factor of safety, demands that the designs be straight-line; this is even more important than the question of the metal, for the reason that the modulus of elasticity is no higher in good than it is in inferior steel, as a rule. If parts are not straight, it is then that torsional strains will have to be handled, and under these conditions the question of the modulus of elasticity has to be taken into account to a serious extent.

If torsion and bending moments are present—and they will be in many cases—if straight-line designing is not practiced, the need for good steel is due to the bending moments, and the quantity required will be increased in view of the combined moments. The argument is vastly in favor of straight-line designing, even at the expense of redesigning a car just to realize the safety which such designs carry in them as inherent properties. The fact that torsional work brings into play the question of the modulus of elasticity as a requisite in the process of design, and the further fact that the modulus is not higher in superior steel, is no good excuse for using the inferior steel, on the ground that the dynamic life of the steel is the factor to emphasize, and this life is not pronounced in the steel of inferior quality.

Noise Is Due to Vibrations and Loose Fits.

Distinguishing between a sound that does not grate upon the ear and what is called noise, is to point out that noise is due to more than the fact that lost motion may be present. If gears do not run on the pitch line, or, if they are not cut accurately, noise will be due to these facts. On the other hand, if the same gears are shaped like a bell, they will accentuate all noise tendencies to a marked degree, and to avoid the noise, it is necessary to keep away from the bell-like shape. That gears will "squeal," if the pitch-line velocity is high, is well known, and while some cars are designed with the pitch-line velocity of the gears in the transmission as high as 1,600 feet per minute, the fact remains that 1,000 feet per minute is the maximum for that performance which is classed as noiseless.

Noise is also due to the fact that the gearcase is thin in many cases. If a noiseless performance is desired, it is necessary to use enough metal to assure a slow rate of vibration, and on this account it is a matter of small moment; the fact remaining that aluminum is stronger when cast thin, than when the walls are thick. The fact that aluminum is light renders its use in quantity sufficient desirable and by taking advantage of this idea it is possible to abort the noise due to a high rate of vibration in the gearcase, and for that matter, in the motor case as well.

Plain bearings always did have the property requisite for noiseless performance, and when ball and roller bearings came into vogue it was directly ascertained that some noise crept in. In recent times, the use of "silent" types of ball bearings reduced this tendency to a marked degree, and since roller bearings are spaced, they are not offenders to any great extent. Under the circumstances it is a fact that the bearings should not be a source of noise, and they certainly are to be preferred to plain bearings for the reasons as follows:

- (a) They are more easily lubricated.
- (b) They will not so quickly get into trouble if the lubrication fails.
- (c) Less energy is absorbed in the bearings, hence the mechanical efficiency is increased.
- (d) The weight of the system is decreased in view of the fact that the housings do not have to be so long.

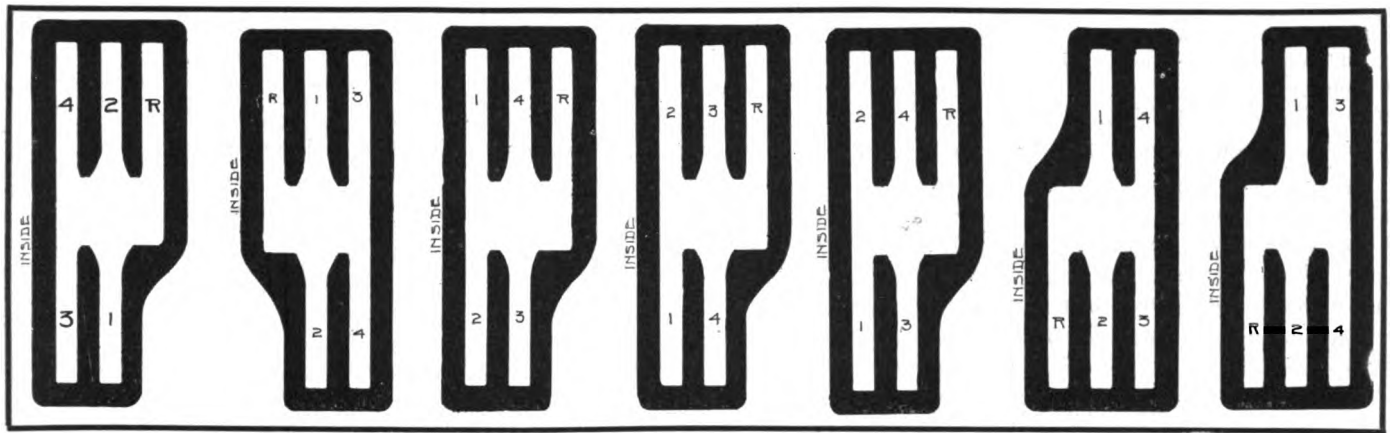

Fig. 1. Fig. 2. Fig. 3. Fig. 4. Fig. 5. Fig. 6. Fig. 7.

Types of Four-Speed Selectors as Used on Prominent American Automobiles, Showing Wide Variation.

(Fig. 1) Lozier Model G; (Fig. 2) Peerless and Stearns; (Fig. 3) Studebaker; (Fig. 4) Lozier Model H; (Fig. 5) Matheson; (Fig. 6) Toledo; (Fig. 7) Simplex.

(e) Alignment is of less importance if ball or roller bearings are used, although this is no recommendation in favor of disregarding the correct alignment of the bearings.

Some Features of Selective Types of Gearsets.

Selective types of gears have the advantage of the progressive plan in one particular, in that the gears do not have to be arranged so that they will "clash" in both directions. As a result the effective face of the selective gears is more, since the face must be reduced enough to bring about easy engagement (through the good office of a wedge-shaped contour) which must be on both engaging faces in the progressive gears.

In other respects selective types of gears differ to some extent, as, for illustration, the skill of the operator must be such as to enable him to determine the proper gear to slide in the train in order not to place the motor at a disadvantage. This is a feature which does not have to be considered in connection with progressive gearsets on the count that the gears are shifted progressively and the shifts correspond to the car speed.

The question of the gear ratio is the same in both types of gears for the reason that the conditions to be satisfied are the same. Just what the gear ratio should be is a matter which depends upon the several conditions as:

- (a) The speed of the motor as it relates to the attainable speed of the car.
- (b) The ultimate speed of the car.
- (c) The rate at which acceleration is to be engendered.
- (d) The design of the motor, taking into account the torque curve of the same.
- (e) The degree of harmony of the several relations.
- (f) The competence of tires used.

In a general way it is considered that the sliding gears (assuming three speeds ahead) should be geometrically related in the manner as follows:

MILES PER HOUR			In a four-speed transmission the third speed would be as follows:
First.	Second.	Third.	
5	10	20	15
6	12	24	18
7	14	28	21
8	16	32	24
9	18	36	27
10	20	40	30
11	22	44	33
12	24	48	36
15	30	60	45
20	40	80	60
25	50	100	75

NOTE.—With four speeds the geometrical relation of the three-speed system would be retained and the fourth speed would be interjected between the second and the third of the three-speed system, so that the third speed would become the fourth, in a four-speed system.

If the power of the motor is barely sufficient for the purpose, it is plain that the second speed should be nearer the third speed, and the practice, in general, is to favor the motor in this way. On the other hand, if the motor is of adequate power, it is then that the second speed can be in the geometrical relation, and this is an advantage on very bad roads, in that the low gear is so advantageously related as to afford adequate advantage under the most severe conditions, while the second gear will be high enough to handle quite bad roads at a fair speed in miles per hour of the car. The bevel drive can have several ratios, depending upon circumstances. The ratio is as follows:

- (a) 3 to 1 in light roadster work.
- (b) 3½ to 1 in light touring car work.
- (c) 4 to 1 in heavy touring car work.

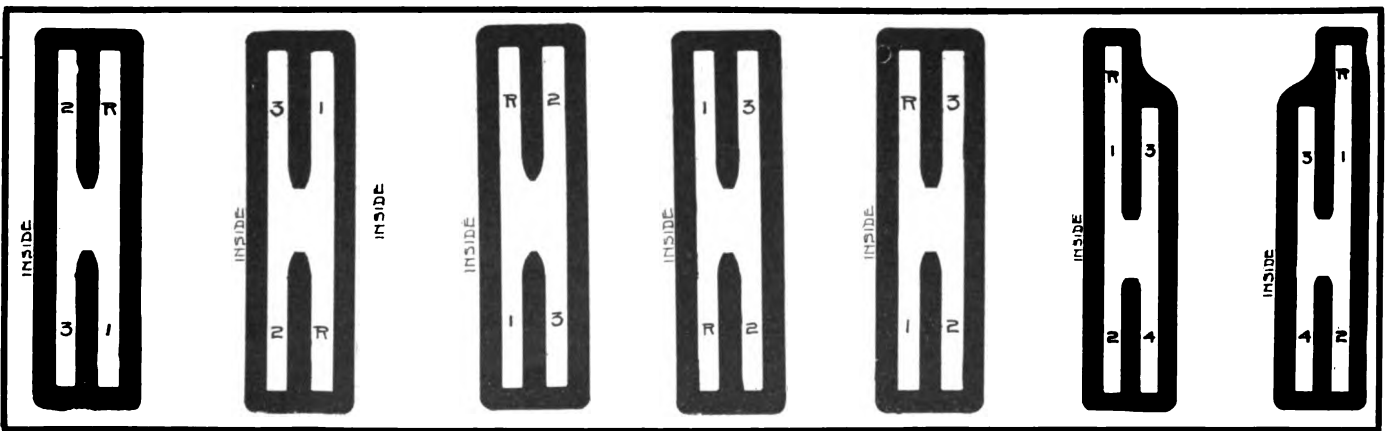

Fig. 8. Fig. 9. Fig. 10. Fig. 11. Fig. 12. Fig. 13. Fig. 14.

Types of Three-Speed Selectors as Used on Prominent American Automobiles, in the Greatest Proportion.

(Fig. 8) Franklin; (Fig. 9) Columbia and Corbin; (Fig. 10) Apperson, Cadillac, Elmore, Knox, Oldsmobile, Walter, Winton and Thomas; (Fig. 11) Oldsmobile Models X and M; (Fig. 12) Buick Model 5; (Fig. 13) Locomobile; (Fig. 14) Thomas.

In publishing the cuts credit must be given to Coker F. Clarkson, of the A.L.A.M., for them.

In the given cases, account is taken of the fact that the power of the motor is barely adequate for the purpose; if the power is in considerable excess then it is possible to alter the bevel gear ratio to suit.

Transmission Gear Ratio in Practice.

This question is one which is best handled in many cases, by stating just what is current in good examples of automobiles; the following is true in one well-known make of car, in which the gear-set affords four speeds and reverse:

WITH MOTOR RUNNING 1,000 REVOLUTIONS PER MINUTE.

Low speed, 15.11 miles per hour of the car;
2d speed, 23.52 miles per hour of the car;
3d speed, 36.64 miles per hour of the car;
High speed, 51.13 miles per hour of the car;
Reverse, 9.94 miles per hour of the car.

Some Questions of Design of Sliding Gears.

Referring to Fig. 17, the cross-section indicates symmetry, in that the web is centrally located, and the thickness of the web (J) approximates that of the flange (I) so that the warping in heat treating will be within allowable limits, if the gears are "nested" properly during the carbonizing process. The thickness of the flange (I) is equal to the value of the "addenda," which is half the difference between OD and PD, in which OD = the

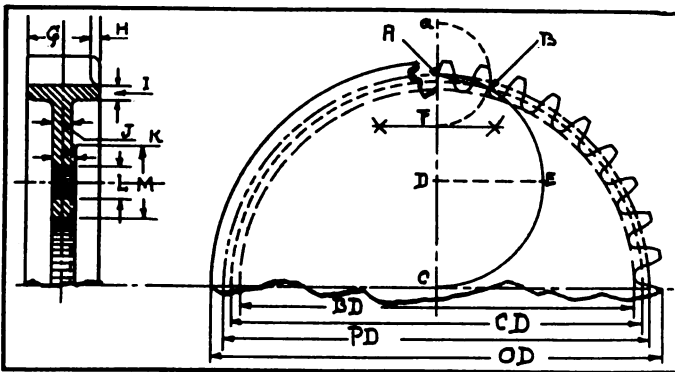

Fig. 17—Design of Square-Cut Sliding Gears.

outside diameter and $PD =$ the pitch diameter. In the old standard machine designing, using cast iron for the most part, it was the practice to make the depth (I) equal to the whole depth of the tooth. In automobile work this depth would far exceed the allowable, for the reason that the "fly-wheel" effect of the gears would exceed the desirable value; indeed, it is the aim to keep down this effect as far as possible. On the other hand, alloy steel, or, "cemented" carbon steel, assures all the strength required under the circumstances in which transmission gears play a very important part.

The question of the shape of the teeth is one which has to be given some attention in view of the importance of the work, and since gears in American car work are of the "involute" genera, which seems to serve well the purpose, it will be the aim here to discuss them. Referring again to Fig. 17, the diameter of the base circle (CD) becomes of importance if it is desired to lay out the teeth of the gears, which, however, is not a matter of great practical importance, in view of the fact that it is not necessary to do so, as a rule. On the other hand, it may become necessary, on occasions, and the manner of approximating the same will serve for the purpose.

Knowing the radius of the pitch circle, CA, the half of which becomes the radius of the circle DE, the axis of which is at D. Taking in turn, half the distance DE as the radius of the arc of the circle FBA, the axis of which is at A, when this radius AB will serve to approximate the addenda curvature of the teeth, provided the axis is on the base circle CD, which bisects the arc of the circle FBA, at the point B. The radius CB then is the radius of the base circle and if this system of

circular arcs is used, the involute may be approximated, in so far as it will be necessary, in view of more exact methods of arriving at the magnitudes of the important dimensions, in the following manner:

Some General Formulæ of Involute Gear Teeth.

Considering teeth of the same pitch, if the gears are meshed in such a way that the pitch-circles touch, it is then that the respective diameters are proportional to the number of teeth in the respective gear wheels. The pitch-diameter then is of the greatest importance, and that gears should perform in a noiseless manner it is desirable to so mesh them as to have them ride on the pitch circle. On the other hand, if the gears are machined and then hardened, the dimensions will not be the same after hardening as before, and the mesh will have to be in view of this fact. The exact allowance to make in view of the "swelling" tendency is difficult to state, and the writer, in his work, preferred to measure the meshing gears in a machine designed for the purpose with the result that allowances as follows would seem to be in accord with the requirements:

Pinion.	Gear.	Allowance.
14 teeth.	28 teeth.	.004 inch.
18 teeth.	49 teeth.	.008 inch.

These allowances will indicate somewhat the idea, and it is a fact that the exact allowance will depend upon several conditions as:

- The dimensions of the gears and mates.
- The quality of the steel.
- The carbon content.
- The time taken in the carbonizing process.
- The effectiveness of the quench.
- Warping is a matter which has to be taken into account separately.

Deformation Due to the Heat-Treating Process.

If the gears are symmetrical in shape, and if the material is of a uniform quality, it is then that the manner of handling the product in the process (heat-treating) will have to do with the extent of deformation, more than anything else. If the gears are to be casehardened they should be nested in conjunction with soft iron blanks in such a way as to expose the teeth to the carbonizing process, in which position they should be bolted into rigid relation, with the iron blanks so fashioned as to serve as a backing to pull against. The nest so devised will then slip into the case (of cast iron) big enough to hold the nest of gears and allow for carbonizing material all around the nest of gears. When the gears, so nested, are carbonized, they may be quickly and deftly lifted out of the case and quenched in such a way as to assure that the teeth will have the benefit of the process, while the clamping will serve to abort warping to a vast extent. The gears will be hardened on the surfaces desired to be hard, and they will remain soft on the surfaces which do not have to be hard, but which should have kinetic ability to the greatest possible extent.

This is a matter which has to do with the sizes of the gears and, under the circumstances it is proper to refer to this phase of the question at the time of taking up the question of sizes of gears, from the designers point of view. Some designers have tried to overcome the ills of "swelling" by allowing for the difference in the machining process, and they have had the cutters made in such a way as to fashion the teeth to compensate for the swelling. The idea has some meat in it, but satisfaction does not seem to reside in the scheme, on the count that it demands the use of special cutters, which are difficult to procure, on the one hand, and likely to vary, on the other.

In the subsequent annealing process it will be well to allow the gears to stay in the clamped position for the reason that the same device that will abort warping in the carbonizing and quenching process will also serve in the subsequent annealing process. The object of annealing is to render the structure kinetic.

(To be continued.)

NEW AND NOVEL DESIGNS IN FRENCH MOTORS

By W. F. BRADLEY.

PARIS, Feb. 10.—The task was undertaken by a French constructor more than a year ago of producing a four-cylinder engine of 2.3 by 3.9 inches bore—practically 8-10 horsepower—which should be of such small dimensions that it could be put in the place of any single or two-cylinder engine of 6 to 10-horsepower that has ever been built. The difficulty was, of course, to reduce the overall length, and to reduce it in a greater measure than is possible by a bloc casting and the abolition of

placed at 180 degrees in relation one to the other. The crankshaft is a built-up one formed of three interior flywheels united by two nickel steel connecting rods forming crank pins. The crankshaft is practically of the type made familiar in the De Dion one-lungers and other vertical engines. There is nothing really original in this, the built-up crankshaft having been employed for years on small motors, with very satisfactory results, while having the additional advantage of being very cheaply constructed. As on the single cylinder motor mentioned, the whole is carried on short ~~short~~ shafts projecting through each end of the crankcase. This latter is divided vertically, being formed of two practically equal parts united by horizontal bolts, as on the majority of vertical single cylinder engines.

It has been stated that two connecting rods are attached to each of the two crankpins. In the usual type of V engine this has frequently led to complications and unsatisfactory solutions. Here one of the connecting rods (A in the illustration) has a forked end; the other (B) is of the ordinary type. A rather thick sleeve (C in the illustration) is forced onto the crankpin, and bears on it for its whole length. The connecting rod B is attached to the center of this sleeve, thus obtaining a bearing on the whole length of the crankpin. The connecting rod A, on the other hand, having a forked end, fits round the head of B, also bearing on the total length of the crankpin.

As will be seen from the illustration, two cylinders forming a pair are inclined outward, the inclination being 7 1-2 degrees from the vertical. On reaching the end of their downward stroke the two pistons forming a pair approach one another, and would come into contact were arrangements not made to prevent this. The disposition consists of cutting away a portion of one of the cylinders only, shown at *e* in the illustration. This loss of material can have no ill effect on the engine, for when under

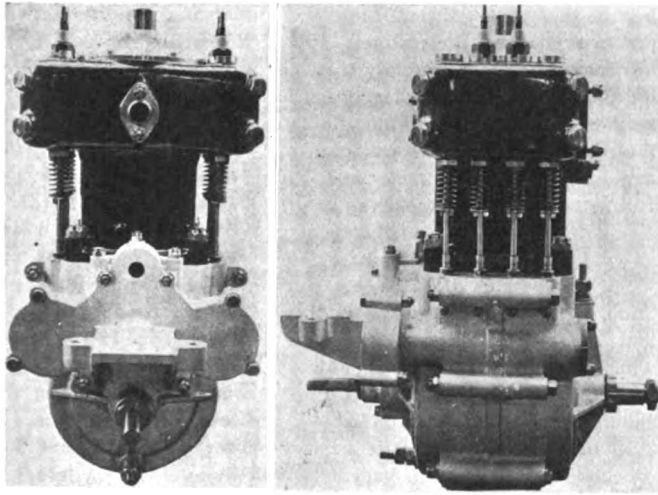

Front and Side Views of Aries Four-Cylinder Motor.

Showing magneto platform, valves and spark plugs down each side in head. The four cylinders occupy same overall length as a standard two-cylinder. The cylinders are slightly in V, thus obtaining a motor which, it is maintained, occupies no more space than a two or four-cylinder of the same power. Note vertical division of the crank case in the side view.

the central bearing for the crankshaft.

The engine has now been presented by the Aries Company and is certainly of such compact design that viewed from a distance it might be mistaken for a single or a two-cylinder motor. As there has been no distinct departure from the principles adopted and found satisfactory in the construction of vertical engines, the novelty may be accepted as one that will give satisfaction in the rough school of daily work.

The Aries motor consists of two pairs of cylinders slightly in V, but unlike the more familiar type of V engine the casting is in one piece. The two cylinders together forming the V have their pistons connected up to the same pin of the crankshaft; there are thus as many throws as there are sets of cylinders. In this case it is, obviously, a two-throw crankshaft that is employed, with the throws

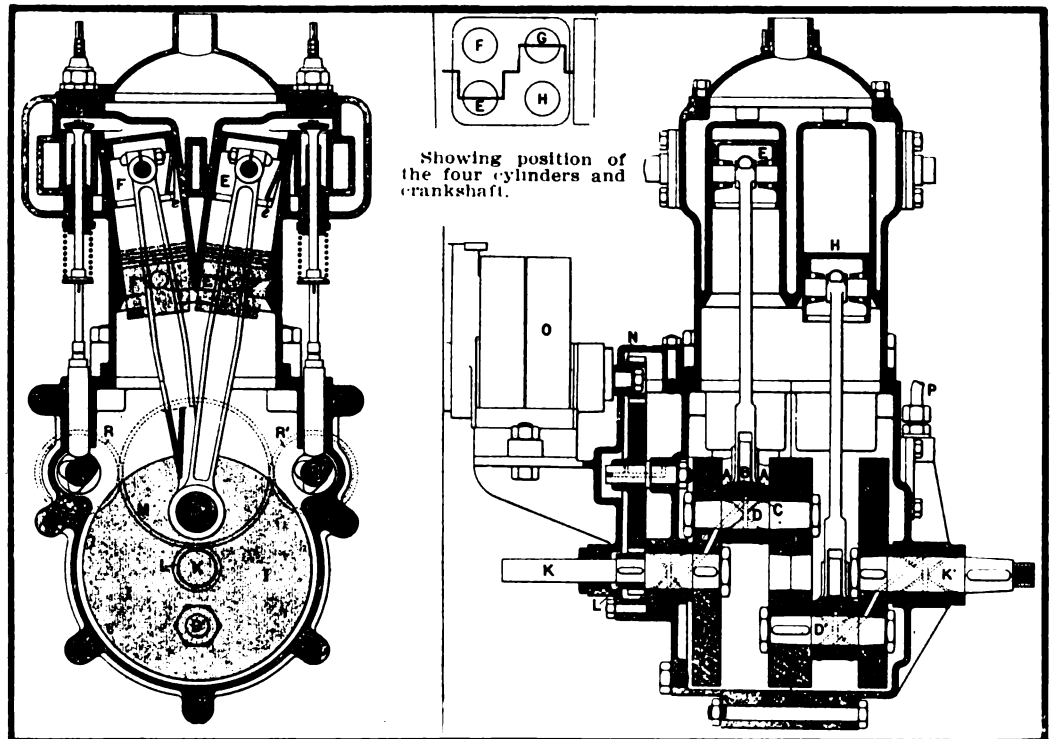

Front and Side View Cross Section of the Aries Four-Cylinder Motor.

Front View—DD, crank pins for two pistons. EEEF, pistons. I, internal flywheel. K, crankshaft. LM, timing gears. QQ, cams. RR, camshaft gears. E, cut away portion of piston.

Side View—A, connecting rod end of piston E. B, connecting rod end of piston F. C, sleeve. D, crankpin receiving two connecting rods. EH, pistons. IJI, interior flywheels. KK, crankshaft. LM, timing gears. N, magneto gearing. O, magneto. P, lubricating oil piping.

pressure it is the opposite face (F in the cut), which is bearing on the cylinder wall by reason of the thrust of the explosion. It will be noticed, however, that the opposite piston E has been cut away also; this, however, is merely to make the pistons interchangeable, there being nothing to clear at this point.

In London taxicab work there are two explosions at 180 degrees, then at 540 degrees, the irregularity being overcome by the use of balance weights. In the Aries the explosions occur at the following intervals:

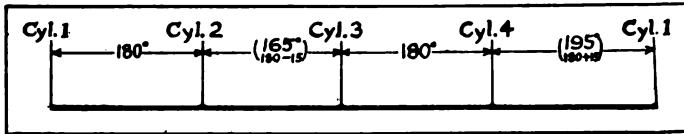

Intervals Separating Four Explosions, Aries Motor.

which is obviously a considerable improvement on the two-cylinder, now recognized, however, as almost perfect in balance.

While the regularity of firing is practically equal to that of a standard four-cylinder motor, the equilibrium of the moving parts is the same, for when two cylinders ascend two others descend.

Other portions of the engine do not particularly call for attention, for the reason that they do not depart from standard lines of construction. The valves, mechanically operated, are of necessity on opposite sides of the engine.

The Korwin & Rebikoff Three-Cycle Motor.

A three-cycle motor has been produced. Like the two-cycle engine, it gives an explosion for every revolution of the crankshaft, without, however, the imperfect scavenging of the spent gases which is the principal objection now raised against this type of engine. The discharge of the exhaust, indeed, on this engine is as perfect as on a motor devoting an entire stroke for each of the four operations.

Imagine a vertical cylinder with the usual type of piston and the addition of an auxiliary piston, which, at the commencement of the power stroke is stationed in the head and above the spark plug. This auxiliary piston, with its face turned downward, or toward the face of the main piston, is indicated by R in Fig. 1. During two-thirds of the power stroke it remains immobile in the cylinder head, but as the main piston uncovers the exhaust port K near the end of the stroke, the upper auxiliary piston commences a rapid downward movement, driving out the

spent gases. The descent has opened the automatic valve b in the cylinder head, with the result that while the piston is on the one side driving out spent gases on the other it is drawing in a fresh charge.

When the main piston has descended just below the exhaust port, the auxiliary piston is nearing the end of its stroke. The two almost meet midway in the port opening, coming so close together that practically every particle of gas is expelled through the open port. The upstroke commences, the upper auxiliary piston moving more rapidly than the lower main one. The automatic intake valve b naturally closes as soon as the end of the downward stroke is reached, and it is now the automatic valve a, placed in the secondary piston, which is drawn off its seat, allowing the gas to pass through into the combustion chamber between the two faces of the pistons. Piston R reaches the end of the upstroke much more rapidly than piston Q, which latter, following up, compresses the charge that has been admitted through the automatic inlet valve. Thus, on returning to upper dead center, the piston is ready to start again on a downward power stroke, explosion, exhaust, intake and compression having been performed during two strokes only of the piston, and that with as complete an expulsion of the spent gases as can be obtained with an engine occupying an entire stroke for the four operations.

Such is the idea of Engineers Korwin and Rebikoff. The operation of the auxiliary piston is obtained by the connecting rod C and levers G G P and n, shown in the diagrams. In the engine which has been constructed, however, and which has proved its worth in service, the control of the secondary piston is, for mechanical reason, made from above, the levers being on the outside of the crankcase. It is an easy matter, with an engine built on these lines, to obtain varying power by admitting a larger or greater amount of gas into the combustion chamber. All that is necessary is to arrest the upward motion of the auxiliary piston, thus allowing only a portion of the charge to pass through the piston inlet valve, the remainder being uncompressed in the head of the cylinder. This has been done on the experimental engine constructed by making provision for instantaneous change of the length of the exterior commanding levers.

A detail worth noting is that the auxiliary piston has no need of rings. During the intake the speed of the auxiliary piston being one and a half times greater than that of the main piston, the burnt gases are rapidly ejected without being able to pass the auxiliary. During the power stroke the auxiliary piston being in the cylinder head is not under any pressure, and does not communicate pressure to the levers by which it is operated.

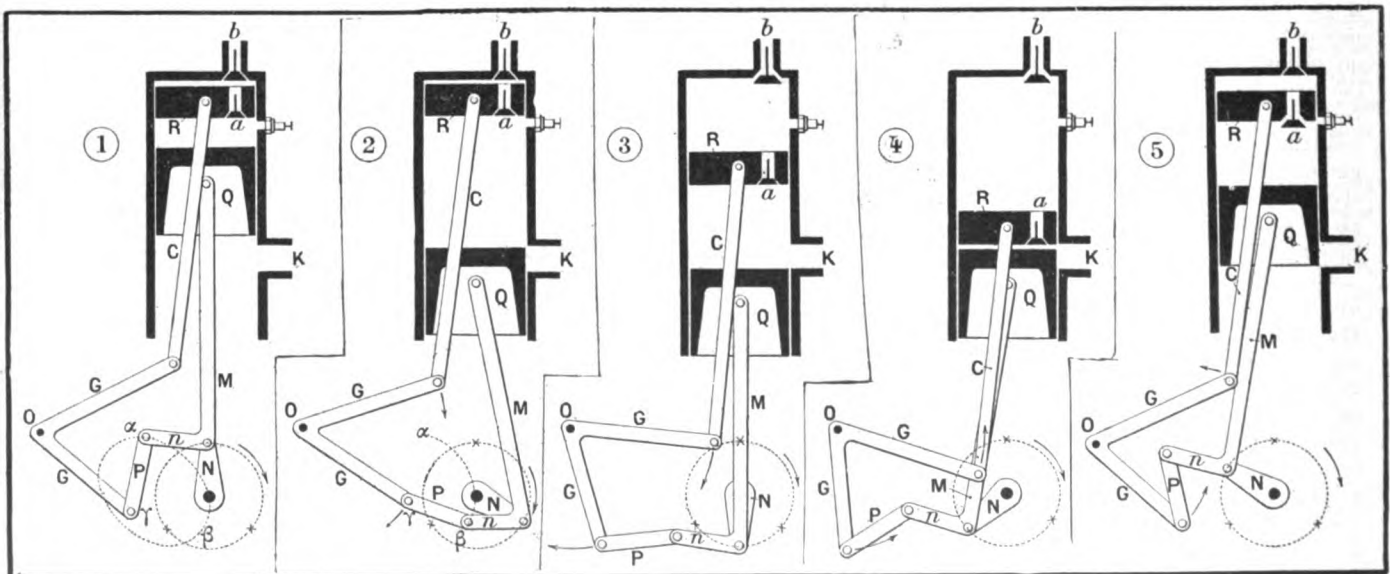

Fig. 1.

Fig. 2.

Fig. 3.

Fig. 4.

Fig. 5.

Sectional Plans Showing Operation of Korwin & Rebikoff Three-Cycle Motor.

(Fig. 1)—Commencement of power stroke. (Fig. 2)—End of power stroke. (Fig. 3)—Middle of second cycle, auxiliary piston commences its downward stroke, and aspirates through automatic valve "b." (Fig. 4)—End of the second cycle; spent charge has been expelled and intake is completed. (Fig. 5)—Middle of third cycle; compression, the gas passing through automatic valve "a" into combustion chamber.

MODERN TREND OF DESIGN IN MOTOR BRAKES

By LAWRENCE WHITCOMB AND THOS. J. FAY, MEMBERS SOCIETY OF AUTOMOBILE ENGINEERS.

UNDER ordinary circumstances it is well understood that in the braking operation, taking into account the instantaneous value of the initial effort as measured in negative torque values, foots up so high as to engender what would be easily termed excessive torsional values in a shaft, the ability of which would be adequate from the point of view of the "normal" positive (mean) torque of the motor. In view of the fact that it is possible to so design brakes as to defeat this excess initial effort, provided the machine members are equal to the occasion, as measured in terms of the work put upon the members by the clutch, it is possible to regard the ability of a suitable clutch as the measure

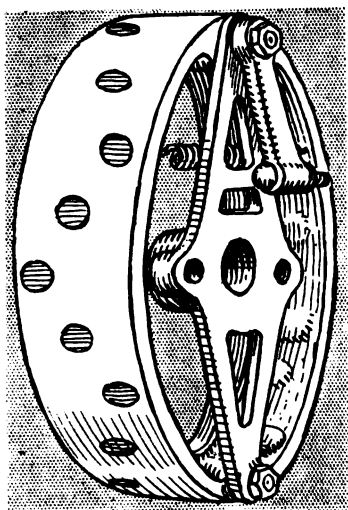

Cork Inserts in Brake-Shoe.

of the ability of the brakes, and in some measure, at any rate, the plan here will be to discuss the brakes along such lines. The other side of the question takes into account the question of the disposal of heat, at such a rate as to enable the brakes to work for a time so long that the increase in heat (in the absence of some means of disposing of the same) would defeat the project. In the meantime it is assured that no set of brakes would be able to accomplish the task within the limits as measured by the ability of the clutch, in the absence of design features taking into account

the amount of energy which can be dissipated while the car is at high speed; which is when the greatest amount of work can be done in the shortest time, hence the time when an effort must be made to absorb the energy; it is the time, however, when it is necessary to guard against excesses by way of "fierce" action.

It is not always the materials of which shoes are made that counts for utility. If the shoes do not cling to the surfaces they will be of no great value, no matter what the quality may be, and if the mechanical means is defective, then it is a fair inference that the performance will be bad in spite of the use of "cork inserts" or whatever the surfaces of the shoes may be.

Product of the Initial Effort.

If the operator presses with a force of, say, 100 pounds, and the lever advantage is on a basis of ten to one it is plain that the members at the end of the linkage will have to sustain under 1,000 pounds. It is not uncommon to see the mechanism so poorly devised as to "give" when the pressure is thus applied and multiplied, and it is no stretch of the imagination to conclude that the multiplication of pressure as theoretically deduced is a long way from the truth. On the other hand, it is unfortunately a fact that the pressure, if it produces a distortion, will have the effect of producing variations in pressure that will end in excessive surface contact at points in the shoes.

The surfaces thus compelled to take more than a fair share of the pressure will wear the most, and so quickly as to bring about acute brake trouble. When brakes are at this stage it will be the natural thing to "adjust" them to new contact, but the original trouble will still be present and the uneven pressure will again wear away the spot of contact, quickly, as before. Such brakes will be called of no great value, and the materials will

be condemned as of no use for the purpose when, as a matter of fact, it is the weakling structure that is at the bottom of the whole trouble.

Internal shoes, unless they are of good section and enough strength to maintain their shape, will surely deform just enough to bring about the uneven surface pressure as before outlined, while "band" types must either be very supple so that they will evenly hug the surfaces or they must be rigid in the extreme, in which event it is important to apply the pressure in such a way as to make the axis of pressure the axis of rotation of the drum. This is rarely the case, and with rigid bands it is to court two classes of trouble, at least. In the first place, the bearing pressures will be so lopsided as to cause the bearings to degenerate. Did anyone ever take into account the fact that a pressure which wears out a good bearing will play havoc with a brakeshoe for the same reason?

Influences That Demand Time in Stopping a Car.

If a car is traveling at a low rate of speed, say, 20 miles per hour, the time factor is not a serious matter for then the tire contact is unaffected by the rate of speed to an extent such as will need be taken into account. On the other hand, it is not when cars are going at this low rate of speed that brakes are of the greatest importance and even poorly constructed brakes might be made to serve the purpose.

But when a car is going very fast it is then that the brakes begin to show their qualities, if the brakes are really in possession of qualities to any great extent. As a car speeds up the ground contact of the road wheels becomes more uncertain and the brakes are more prone to fail. The curve given shows that the coefficient of friction falls away quite rapidly as the speed is increased, and the result is that the brakes work at a great disadvantage under conditions of high speed.

It is at the higher speeds, just when brakes become valuable possessions, that the indifferent kind fail in service, not because they will not apply the requisite pressure, but for the reason that the pressure is brusquely applied, if it will be permissible to use such a term to express the condition. When the road contact is uncertain or reduced to quite a low point it is easy enough to see that any sudden application of the pressure will engender skidding, after which the brakes are of little or no value.

At such a time it is essential to have a time factor, and as the shoes contact it is necessary that they "give" a little before the pressure becomes pronounced. Were rubber of a nature to withstand the temperature it would be good for the purpose, because it would "give" with the application of pressure and the necessary time factor would be realized. Once the shoes contact firmly, if in the meantime the road wheels do not skid, then pressure can be added with a considerable force without any fear of causing skidding.

Any material, then, which will allow the shoes to contact gently at first and firmly within a short distance of shoe travel after contact is established will do the work that brakes have to do, within the limits of ability, taking into account the coefficient of friction of the material under the several speeds of rubbing during the process of slowing a car from a high speed to a dead stop.

In this process there are two prime conditions aside from the fact that establishing the working condition during the interim of initial contact is a delicate process that may upset the whole performance. The two conditions are: (a) the coefficient of friction at high rubbing velocity, and (b) the coefficient of friction at low rubbing velocities. They are not the same and the result is that no single set of materials will give all the results desired. But this alone is not of great importance provided the material used will engage well and serve at the higher speeds.

* Paper read at the December, 1908, meeting of the Society of Automobile Engineers, held in New York City.

Metal to metal will not do this, even approximately. The result is skidding will ensue with metal to metal. If skidding does not ensue it will be on account of bad initial contact and the materials will abrade in the process which spells short life of the shoes. This is due to the fact that the materials chatter and in some measure serve to prolong the time of making the contact. During this interval the metals are scored, and later as the contact is more firmly made, the loosened metal is detached.

The material that will engage softly and slow the car down to a point where metal to metal contact is a practical possibility is the material that will abort skidding and protect the metals from undue wear. Cork alone will not serve the purpose any more than will any other soft material. What is wanted is the cork to a limited extent only, and this to be followed by metal-to-metal contact as a final operation.

Conditions Favorable to Cork.

Under such conditions the cork will do the engaging and abort skidding while, as the pressure is increased, the cork will press more and more until it recedes into its sockets, when, the speed will have fallen off and metal-to-metal contact will take hold under conditions that will measure success. But it will only be so if a car is arrested from a high speed. From ordinary speeds the cork alone will do all the work and the brakes will act softly and with certainty. This is due to the fact that the effort required to stop a car from a low speed is little in comparison with the effort at a high speed, and it is only under high-speed conditions that brakes so designed will be tested to the metal-to-metal limit.

In nearly every treatise on the subject the situation is handled on a basis of a constant coefficient of friction which is far from the true state of affairs. It follows that brakes do not serve well under certain conditions, even though they might do very well, indeed, under demonstrating conditions in the park at a speed of from 20 to 30 miles per hour with good roads. What to take into account is the moment of friction, as it obtains at all speeds, and try, by some means, to arrive at a constant or nearly constant moment of friction for a constant moment of pressure. This is not quite possible because there is no material that will quite fill the bill, but cork in the insert form comes very near to a complete performance.

When a car is going fast it naturally covers the maximum distance in a given time. It is at such a time that the effectiveness of the brakes will be (a) not worth taking into account if the materials used for the facing will not take hold; (b) the car will be brought to a stop in a short distance if the materials will act during the time the drum is rotating at a high speed.

Under these conditions everything depends upon the ability of the materials during the time the brake drum velocity is high. If materials of a high coefficient will engage at a high speed, then it is plain that just when the car is covering the most ground it will be arrested in its flight to the greatest extent. This is the time when the mass has stored in it the greatest amount of energy, but it is also the time when the energy will be absorbed at the highest rate if it is true that the brakes can be made to work efficiently. This is also the time when the shoes will be damaged if the engagement is not smooth. It will be smooth if a compressible material is used in conjunction with a final metal-to-metal contact.

Clutches and Brakes Compared.

The very clutch, on which so much time is spent, is the exact device that will serve perfectly for brakes. The earnest attempts made to give life to clutches are wanted in connection with brakes. The reasoning for the one is good for the other, and any reasoning that is a fallacy for clutches is a fallacy for brakes. The argument in favor of brakes on the rear wheels to avoid shock to the transmission is weak, unless it is an admission that the same transmission is damaged by the clutch. If the clutch will hold while the motor slips the wheels, the brakes can do no more. If the brakes would unduly shock the transmission system, so would the clutch. The car that will not stand

up with brakes on the propeller shaft will go to rack equally fast, because the clutch will furnish the very same destructive effect complained of in connection with the brakes.

The clutch is operated with great frequency, whereas the brakes are used to stop a car, or to frequently slow down, if the driver is more or less incompetent. At all events, it is the clutch, as a rule, that will do the most damage to a weak car, not forgetting that the motor is the prime source of the power. From a view to showing what it means to have the brakes on the traction wheels instead of upon the propeller shaft, or some other shaft back of the clutch, rotating at a speed higher than the traction wheels, a concrete example may be set down as follows:

Assume a 12-inch brake drum under two sets of conditions as follows: 1. On the propeller shaft making four times as many revolutions per minute as the rear wheels; 2, on the rear wheels at one-fourth the speed of that of the propeller shaft.

Pull in pounds on the periphery of the drum in a given case will be equal to:

$$P = \frac{H.P. \times 33,000 \times Q}{2\pi R S}$$

When

P = pull in pounds on the periphery of the drum;

$H.P.$ = the actual delivered horsepower of the motor;

Q = the efficiency of the transmission;

R = radius of the drum in feet;

S = angular velocity in revolutions per minute.

For a case involving a 25-horsepower motor at 1,500 revolutions per minute we have:

Case One.

$$P = \frac{25 \times 33,000 \times .70}{6.28 \times .5 \times 1,500} = 122 +$$

Case Two.

$$P = \frac{12.5 \times 33,000 \times .70}{6.28 \times .5 \times 375} \times 2 = 490$$

In other words, a brake system on the higher speed shaft will balance the ability of the motor under the conditions named, if a pull is exerted equal to about 122 pounds on a drum 12 inches in diameter. If the two drums are used on the rear wheels, assuming an equal division of work, the pull on the main rod will have to be four times the pull for case one, because the speed is one fourth and all the remaining conditions are equal in both cases. Back of the compensating device the effort will be divided by two, and the pull on the respective traction wheel drums will then be 244 pounds approximately, for the case in hand. If the pull on the periphery of the high-speed brake drum is all that can be afforded, then it is plain that the greater pull required on the traction wheel drums will not be available. If the pull required for the lower speed—traction wheel—drums can be allowed, the problem resolves itself into the question of the relative virtues of speed versus pull.

Relative Virtues of Speed and Power.

The effectiveness would be proportional to pressure on the periphery, on the one hand, and to speed upon the other were the coefficient of friction to remain constant for all speeds of slipping, and for all materials, which is not the case. On the other hand, the higher the speed the quicker the action for any material that will prove efficient as the speed increases. In these points we have the reasons for success in some cases and failures in others.

Designers who do succeed consider the abilities of the materials they use, under the conditions of use. Some fail through imitating designs that work, as respects materials, but not under the same conditions, as respects pressure and speed of rubbing.

The abstract coefficient of friction as determined in a laboratory is as far from the true facts, in practice, as it is possible to go. If the materials are pulled over the face of a platen at a low speed, under a given load, for a given area of bearing, the respective materials will perform in proportion to their respec-

tive abilities to cling to the platen surface. The coefficient so obtained affords no clew as to the effect of speed, although it is possible to plot a curve for pressure by the simple expedient of changing the weight for a given area. These coefficients are good, as far as they go, but they do not go far enough to serve the purpose sought, with the result that brakes work, or they do not, merely depending upon the speed of rubbing when pressure is applied for any given material. It makes no difference what the material is, since there is no single genera of material of which we have knowledge that will work under conditions of a constant coefficient of friction, under all conditions of speed.

Composite Shoes Required.

The conditions in practice require the use of two classes of material in the shoes, as follows:

A, A material that will "bite" upon contact at high rubbing velocities; B, a material that will supplant the high-speed clinging material when the speed falls off, and pressure must be increased to continue the effort to a successful climax.

Some six or seven years ago, when cork was at first considered seriously for clutches, Mr. Fay, then executive engineer for the C. W. Hunt Company, decided that cork—if it was good for the purpose—might be used exclusively and instead of an insert, made shoes of pressed cork and tried them out under very exacting conditions of service. The experiment was an indifferent success for the good reason that unsupported cork "crawled" out from under the pressure. It took time to unravel the mystery, and it was ultimately ascertained that too much cork was worse than none at all. Brakes must have shoes that stand up to the pressure, because the mechanism is so closely linked that an excessive increase in the length of the band results in exhausting the travel of the linkage. If a drum, say, 12 inches in diameter, is lined with a material that compresses 1-16 inch the condition will be as follows:

$$3.1416 \times 12 = 37.6992 \text{ inches cir.}$$

$$3.1416 \times 11.78 = 37.3065 \text{ or } .3927 \text{ inch difference.}$$

This increase of .392 inches in the length of the band, is more than the take-up will allow in addition to the normal clearance, and the band will then not constrict adequately for the purpose. Increasing diameters of drums increases the trouble, since the length of the band is equal to:

$$2\pi R = \pi D,$$

when R and D = radius and diameter, respectively.

It is easy to see why all cork failed in service. It fell away from the pressure and the take-up reached the limits of available effective sweep. Beyond this point lies an unbroken series of reasons why the cork should be used as an insert, viz.:

A, the cork is not a good conductor of heat, and if it is inserted in metal, the heat will be spread out over the metal surfaces and be radiated from the cork as a result. The cork then will get no hotter than the metal.

B, the cork will grab at a high speed and will snub motion—relative—up to the limit of its ability.

C, when the pressure conquers the rigidity of cork, the inserts will compress in their sockets, without loss of ability up to its limit, since it will contact just the same—not unlike a compressed spring—and present about the same face area as before it is "flushed";

D, when the metal faces contact they do so under high pressure and lowered speed, hence under effective conditions for metal, and it will then grab on as well and render assistance to the receding corks. In these phenomena, we see the reasons why a dual condition of the brake shoe media will best serve the ends to be sought.

Wipe the Heat from the Surfaces.

In motors, to keep them cool, we arrange to wipe the heat off of the hot surfaces, and we use a liquid for the purpose, as water, or glycerine and water, etc. The specific heat of the liquid is brought into play and by keeping the liquid churned, or circulating, we bring cool splashes of the liquid up to replace the heat-laden portions fast enough to absorb all the heat and maintain a constant temperature. If we can wipe the heat off of the hot surfaces of the motor cylinder head, we can duplicate the process in connection with the brakes. We did not think it so easy without resorting to waterjackets, and most of us refuse to add to the freezing zones. Oil did not seem to lend itself to the process, since in the past the problem was to keep oil away from brakeshoe surfaces, but clutches submerged in oil do work. So will brakes. They will work in conjunction with cork inserts on a moderate pressure, or they will work anyway if the pressure is high enough to drive the oil out from between the faces and let the metals contact. It is best to avoid these high pressures if we can, and if cork is the product that will wipe the oil off of the faces—just as a rubber mop wipes water off of plate glass—and allow of friction contact, cork has a property that lends itself nobly to the task to be performed.

Coefficient of Friction of Cork.

The coefficient of friction of cork on oiled faces is higher than that of leather, as it is ordinarily found in cone clutches. It is high enough then to assure working qualities under pressure and low enough to abort structural impossibilities. The oil bath will serve to wipe away the heat and distribute it over the radiating surfaces of the housing. The one remaining factor is

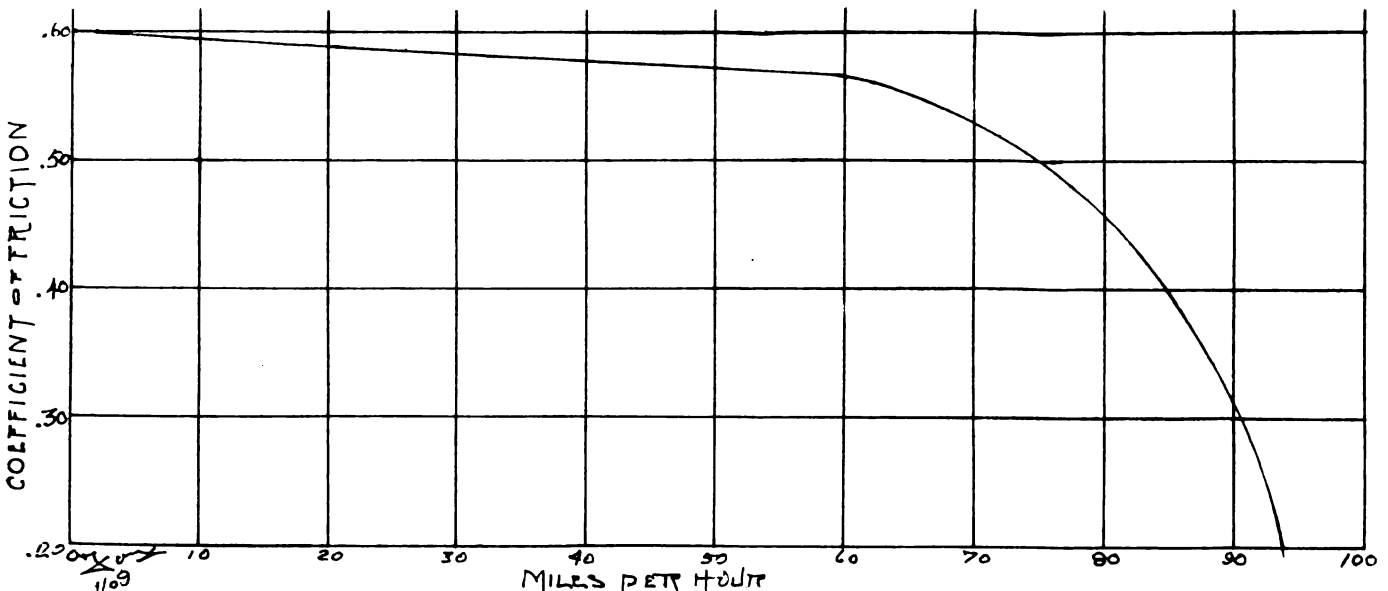

Curve Showing How the Coefficient of Friction Changes, on a Given Road, as Speed Increases.

that of providing enough surface to dispel the heat. The emissivity of roughened black surfaces, as iron housings, for oil baths, with the car in motion, as will be the case with brakes on cars, may be set down as at the rate of 10 watts per square inch, within the allowable increase in temperature for the materials used. The surface then to radiate the heat must be sufficient to dissipate energy at a rate equal to snubbing a car on a grade, for some time, and taking the electrical equivalent of a horsepower, a means is at once afforded for fixing upon the requisite surface.

A Simple Concrete Application.

The simple process of stopping a car does not involve this problem, since the body of oil in the bath would have to be heated and that would have to be at the expense of time. In descending a grade the speed of a car would probably be low—say, ten miles per hour—and with the clutch free, thus putting it up to the brakes. Assuming that the friction of the car would total 30 per cent., weight would enter into the problem.

10 miles per hour = 880 feet per minute;
 880/5 = 176 feet fall per minute;
 = vertical drop per minute;
 car weighs, say, 3,000 pounds, and a gradient of one in five;
 3,000 × 176 = 528,000 foot pounds;

from which take 30 × 880 = 26,400; leaves 501,600 foot-pounds;

hence, $\frac{501,600}{33,000} = 15.2 \text{ H.P.};$
 15.2 × .70 = 10.6 H.P. to be dissipated in heat over the surfaces;

and $\frac{10.6 \times 746}{10} = 791$ square inches of oil bath housing-surface required to dissipate the heat on a basis of 10 watts per square inch. This is not impossible.

This is on a basis of a draw-bar pull of 20 pounds per ton mile, which is a fair average figure, although some tests made some time ago showed 70 watts per 1,000 pounds—rate of expenditure—for a 3,000 pound car, would foot up to:

70 × 3 = 210 watts;
 210 × 10 = 2,100;
 2,100/746 = 2.8 H.P.;
 2.8 × 33,000 = 92,400 foot-pounds per minute.

If the car—outside of the transmission losses—will retard on a bases of 92,400 pounds per minute, when doing 10 miles per hours, instead of 26,400 foot-pounds, then the surface of the drum housing will need be less. In this we have a factor of safety which may be allowed to stand.

Retarded by "Horizontal Component."

A car descending is retarded by the "horizontal component," and if the brakes are on the remote end of the transmission, by the "mechanical component."

The same car—motor cut off by the clutch—will be impelled by the "gravitational component." Since the brakes will be arbitrarily set to control the speed, the gravitational component will be equal to the energy of position residing in the car. In this

case the car is said to drop—down grade $\frac{880 \text{ feet}}{5} = 176 \text{ feet}$

per minute. The energy of position is $176 \times 3,000 = 528,000$ foot-pounds, from which the two negative components must be taken, leaving the energy that must be absorbed and dissipated by the brakes, which was found to be 10.6 horsepower, reduced to watts for convenience.

The pressure on a brake drum—pull in pounds at the periphery—would be, for the case in point:

$$P = \frac{10.6 \times 33,000}{6.28 \times .5 \times 45} = 246 \text{ pounds};$$

and were the emergency brakes required to do the work, considering a four to one gear ratio, the pull on each one would be: $246 \times 2 = 492$ pounds, considering all brakes as of 12 inches in diameter. In the cases involving brake-drums of greater diameter,

examples of which are now quite common, the situation becomes much more favorable, except that it must be remembered that the "take-up" will have to be more carefully regulated, for reasons which will be obvious.

An Emergency Condition Portrayed.

In this we see the greater need of brakes than would follow the previous condition in which the torque of the motor was taken as a guide, but a gradient of one to five is most unusual, and the double set of brakes would about correct the discrepancy, were all the brakes of equal competence. There is one other way to take care of this condition; that is, place the emergency brakes on the clutchshaft and gear down so that the clutchshaft would be rotating at a considerably higher speed than that due to a direct drive. The losses in transmission would also help out. At all events it is possible to maintain the first contention in which the 12-inch drum would have to sustain a peripheral pull of 122 pounds.

Ability Is Proportional.

But the ability is proportional to the pull on the periphery, and the life is proportional to the contact area in square inches for a given material and peripheral pull. If we allow that the projected area will equal the contact area, then for a drum of 12 inches in diameter, with shoes 2 inches wide, the projected area will be:

$$12 \times 2 = 24 \text{ square inches.}$$

If it is safe to work on a basis of 10 pounds per square inch,

$$24 \times 10 = 240 \text{ pounds};$$

and since this pressure will be against the periphery, it will be resolved as a tangential effort and become the pull *P* in the formula

$$P = \frac{\text{H.P.} \times 33,000}{2\pi R S} = \text{pull in pounds};$$

when, *R* and *S* = radius in feet and speed in revolutions per minute, respectively. The next question is: Will some other pressure per square inch be better? We will endeavor to answer this by some further tests.

Illustrating the Point.

If we assume that bronze on steel will be the basis from which to judge of relative values, it will be necessary to fix upon the coefficient of friction of the basic products first. This, for several pressures at low speeds, will be as follows:

Pounds per square inch:				
2	4	6	8	10
Coefficient of friction:				
.14	.14	.14	.14	.14

In other words, the coefficient is constant up to the point of seizing. After this point is reached the friction follows no law.

If, on the other hand, 20 per cent. of the bronze shoe surface is of cork—in the shape of inserts—using 3-4-inch corks in sockets 1-2 inches apart, center to center, the coefficient will be as follows:

Pounds per square inch:				
2	4	6	8	10
Coefficient of friction:				
.35	.35	.35	.327	.293

In this we see the increase in value for decreasing pressure with a direct proportion below 6 pounds per square inch, and at about 5 pounds per square inch the coefficient is at its maximum.

On the other hand, oil will not squeeze out—excepting under the cork, where it is mopped off—at such low pressures, and if the pressure is applied to an extent that will cause the cork to recede to the flush, the oil film on the metal-to-metal contact will defeat the further increase in clutching ability, provided the metal surface is the remaining 80 per cent., allowing 20 per cent. for cork. The theoretically correct shoe, then, will present but little metal-to-metal surface and an easy oil channel.

LETTERS INTERESTING AND INSTRUCTIVE

DOUBLE TAXATION, STATE AND CITY.

Editor THE AUTOMOBILE:

[1,750.]—Will you be kind enough to advise me on the above subject, as follows: If, in addition to the tax paid by all automobile owners in their own State for license to use their machine on public highway, the town in which a man lives assesses his automobile as part of his personal property, similar to that of his home (and horses, etc.), is this not a case of double taxation; and is there not a reason to protest against it? No road tax is assessed on horse and wagon.

J. F. B.

New York City.

You are not subjected to double taxation, for the following reasons:

First: The registration fee for your automobile which you pay to the Secretary of State is not a tax on property, but a license fee imposed to defray the expenses of the motor vehicle department in registering machines, issuing licenses and doing such other things as are required by law.

Second: Since the registration fee is not a tax on your automobile as property based upon value, it necessarily follows that, for the State as a municipality, to levy a tax on your automobile as property, is not taxing you twice for the same thing and in the same manner, or subjecting you to double taxation.

Third: Fees paid for registering an automobile, provided the fees are reasonable and are in amount no more than necessary to defray the expense of issuing the license and registering the machine, also maintaining the motor vehicle department, are properly imposed under the police powers of the State. By requiring the registration of machines, an identification system is established, for the detection of offenders against the law and the safety of the public.

Fourth: If the registration fees are unreasonable in amount, the excess is a tax upon either the automobile as property or the privilege of using it, in both of which cases the tax is illegal.

Fifth: Provided the registration fees are unreasonable, it is not double taxation for a municipality to assess a tax against an automobile upon which the unreasonable registration fee has been paid, because double taxation presupposes an existing legal tax.

These questions are now being litigated in New Jersey in a case testing the automobile law of that State. A decision is expected soon from the Supreme Court which will be of vast importance. It is claimed that the annual registration fees for automobiles in New Jersey are excessive and consequently illegal.

The fees required by the State of Connecticut for registering automobiles are not so high as required in the State of New Jersey, still they are larger than demanded in New York. In the latter State the fee is \$2, and it need be paid but once. Whether the Connecticut fees are illegal because excessive, depends upon whether there is a material surplus left after deducting the motor vehicle department's expenses. It is merely a case of subtracting the expenses from the income. If there is a substantial balance, it is revenue, it is a tax, and it is illegal, because, since it is a tax, it is not imposed according to valuation as required by constitutional provision.

OXYGEN AND NITROGEN IN AIR BY VOLUME.

Editor THE AUTOMOBILE:

[1,751.]—Will you please state the relation of nitrogen to oxygen in atmospheric air, under a pressure of one atmosphere, and at a temperature of 60 degrees Fahrenheit?

Jersey City, N. J.

ALEXANDER.

(a) To find the quantity of nitrogen, by volume, in atmospheric air, corresponding to one volume of oxygen, proceed as follows:

$$N = O \times 3.770992 \dots \dots \dots (1)$$

(b) To find the quantity of oxygen, by volume, corresponding to one volume of nitrogen, proceed as follows:

$$O = N \times 0.265182 \dots \dots \dots (2)$$

Volume changes with temperature; which must be considered.

QUITE AN UNDERTAKING, TO BE SURE.

Editor THE AUTOMOBILE:

[1,752.]—I am a subscriber to "The Automobile" and so I refer to you to answer the following questions:

I am making an induction coil and want to use 40 No. 16 double cotton-covered magneto wire for the secondary winding. I would like to know if you could tell me what size wire I could use for the primary winding, and what voltage to use for the best results. Could you give me any idea what diameter the flanges should be and what diameter core I should have. The coil will be 16 inches long.

San Rafael, Cal.

F. W. ORPIN.

There is very little that you say which would enable one to aid you on a basis of much safety from the point of view of result of a character such as would take rank with good coils to be had on the open market. The leakage factor will be enormous if the core is as long as you suggest, and the diameter of the core should bear some relation to the length to compensate in some measure for the great length. On the other hand, if the diameter of the core is great, it is then that the length of the mean turn will be overmuch and the number of turns for a given resistance will be relatively few. No flange at all would suit the case, it is believed, for then it would be right to taper off the windings as they approach the ends of the core. The end windings probably will do but little good, anyway, and tapering down at the ends will enable the winder to accomplish the task with greater ease, unless it is that the winding is done on a machine. Probably the primary wire should be about 16 to 18 B. W. G. and the secondary winding should be between 36 and 38 B. W. G. for the secondary if the coil is to be used in automobile ignition work. On the other hand, it would be well to reduce the length of the core if the coil is to be used for automobile ignition service. As to the core, it is possible that one inch in diameter would do.

GEARS HAVE TO BE MESHED PROPERLY.

Editor THE AUTOMOBILE:

[1,753.]—Will you please tell me through "Letters Interesting and Instructive" how to time the half time gears properly on a double-opposed motor when the large wheel is in the lower part of the crankcase under the crankshaft? Also tell me if an engine will run at all if the gears are not properly meshed. How can I overcome the grinding or churning noise made by the water pump on this engine? Will grease do it? If so, what kind?

South Braintree, Mass.

SUBSCRIBER.

The location of the half-time gear is merely incidental. The timing must be in accord with the fact that the valves must open and close in a way to perform the functions efficiently. If the gear is so placed as to render the mechanical work difficult it is then that more skill must be brought to bear on the task. In the meantime it is necessary to so mesh the gears that the valves will open and close relative to the piston travel in the manner as follows:

- (a) Exhaust opens 3-8 inches of piston travel before center.
- (b) Exhaust closes 1-16 inch of piston travel by center.
- (c) Inlet opens 1-16 inch of piston travel by center.
- (d) Inlet closes 1-4 inch of piston travel by center.
- (e) Maximum spark advance, 33 degrees before center.
- (f) Maximum spark retard, 7 degrees beyond center.

In the case (a) the exhaust opens before center on the power stroke; in the case (b) the exhaust closes by center on the suction stroke; in the case (c) the inlet opens coincident with the closing of the exhaust; in the case (d) the inlet closes by center on the compression stroke.

In relation to the timing as given, it is fair to say that in actual practice all sorts of deviations are made from the relations as given, and it is possible to argue in favor of them all. As a matter of fact, much depends upon the area of valves as it relates to the area of the cylinders and each specific case must be given attention on a basis, taking into account the details. Then it is a fact that the speed of the motor must be considered,

and since speed and compression must be taken into account simultaneously, it is evident that the problem can be multi-sided.

In a general way the timing as above set down will afford good results. The best way, perhaps, to mesh the gears for the right cam position is to shift the camshaft gear as it relates to its mate. The mechanical construction will have to be considered in this connection. A length of wire inserted into the priming cock of the cylinder head will serve as a depth gauge. The piston travel can be marked off with good accuracy in this way, and it is more definite than taking into account the angle of the timing as it may be marked off on the flywheel.

If the water pump grinds it is crying for grease, assuming the surfaces are not cut. The makers of grease for lubricating purposes will fill your order for the right quality upon request. If the pump is of the "gear" kind, and if the speed is high, it will make a little noise anyway.

OUTLINES OF A VERY SIMPLE CAR.

Editor THE AUTOMOBILE:

[1,754.]—As an interested reader of your journal, I would like to ask why a car outlined as below would not be a desirable car to build and own, by reason of its extreme simplicity.

First, use a three-cylinder two-cycle motor, cranks at 120 degrees, crankshaft offset, air-cooled by gear driven blower and cases around each cylinder, balance wheel at each end of crankshaft to aid in steady running; the same gear that drives the blower to drive the timer, and a force feed oiler to care for engine lubrication; all other parts oiled by local cups. Incorporate in rear flywheel a low tension magneto with coils on dash.

Second, use a friction transmission with differential on jackshaft and an enclosed silent chain running in oil both to each rear wheel; brake surfaces and sprockets integral on each rear wheel; all wheels and jackshaft, ball or roller bearings.

Third, control on left side; at least 32-inch wheels, and car of medium weight and power and speed; any type of body.

I am not an engineer and know nothing of the technical difficulties involved, but from a layman's point of view this car would have what would seem to be the simplest of all engines to build and care for and the simplest of transmissions. The engine would have the torque of a six-cylinder four-cycle engine, but all valves, springs, cams, rods, side shafts, pump, and connections, radiator and water are done away with in one stroke; also the extra moving parts for a separate magneto are saved.

I have seen it stated in the "Scientific American" (presumably unbiased) that a properly designed friction transmission was more efficient than an equally well designed sliding gear. Assuming them to be equal (I do not know that they are), with the friction transmission you eliminate from your car clutch, gearbox, sliding gears, universal joints, shaft, bevel gears, and the heavy and complicated divided rear axle, and substitute a transmission that is simple, light, cheap and fool-proof together with the strong, light, solid rear axle. Enclosed silent chain should be noiseless and should not stretch and ought to run easier than gears—at least it was my experience with many makes of bicycles that the chain-driven ones ran the easier. By reason of the steady pull of its engine and the innumerable speed combinations that friction transmission permits, this car ought to be very flexible. In view of the relatively few moving parts to make, the initial cost of the car should be low and yet enable a manufacturer to use the best of material and workmanship, its life should be long and its upkeep slight, and for the owner who must look after his own car there would seem to be the minimum of moving parts to watch in the machine outlined. It seems to me that every step taken in the direction of simplicity, so long as efficiency is not reduced, is a step in accordance with good sense and the tendency of the times.

I am an Elmore owner and a believer in the two-cycle principle, and also believe that when the two-cycle engine has reached the present perfection of the four-cycle, it will drive the latter from all but special fields. If you have your gas and spark a two-cycle engine can't help but go. Would the car I have outlined be practicable? Would it meet my expectations as to life, ease of operation, flexibility, low price, general every-day use and roadability.

Mineola, N. Y.

"TWO-CYCLE."

It would be interesting to note the performance of a car such as you outline; Ford uses the magneto in the flywheel; one flywheel will do quite as well as two; the blower idea is now used; the dashboard might well be clean; two-cycle, air-cooling is used to some extent; friction drives seem to be good; left-hand drive is used on the Ford; it would be up to you to make good.

You say "medium weight, power and speed; the engine would

have the torque of a six-cylinder, four-cycle motor." That is the question: would it?

Your plea for simplicity is to be commended; the two-cycle motor you name is water-cooled, and it is not with a friction drive. In mechanical work it seems that conclusions in the absence of an actual trial are worth but little; it follows that jumping at conclusions oftentimes leads to mechanical indigestion. It is suggested that you, in your desire for simplicity, reach conclusions which have not been proven by the facts thus far, and it will be inconsistent here to make the same mistake. If you have the time, skill, patience and money to pay the piper you might be able to make good.

CRUST ON SURFACES OF COMBUSTION CHAMBER.

Editor THE AUTOMOBILE:

[1,755.]—I have a couple of questions I should like to ask:

1. Do you know if the chemical carbon removers advertised will remove the carbon from the cylinders almost as well as scraping by hand, yet with absolutely no injury to the surrounding metal parts in the cylinder?

2. I wish to have the foot accelerator to the gas throttle to a two-cylinder 1906 touring car changed to a stationary gas throttle as in all the late cars, and also to keep the accelerator in addition if possible. Do you know what would be the cheapest, best and most feasible way for having this done?

3. In the same car, which has a rear axle of the pin and key style, we have continual trouble with the pins breaking, especially on one side, where on one-half of the side of the keyway in the hub, the keyway is sheared away, i.e., partially broken. Do you think if we only had a new hub put on it would remedy matters? Also, my garage man says that although the pin may be broken (not the key which runs horizontal to the axle) there is practically no danger of the wheel coming off, as part of the broken pin always sticks through where the hub and axle join. Is this true that with a broken pin there is practically no danger of the wheel coming off?

4. The head of the muffler on the same car is broken in. As it has been on the car for over two years, I presume there is more or less back pressure. Hence I think a new muffler is needed. Do you consider a new muffler is the best and cheapest to put on again, or would you advise some other kind of muffler, and why? Is there any back pressure exerted by the mufflers, and do you consider that they muffle the sound as well as possible?

Pawling, N. Y.

RONALD R. KELSEY.

The chemical carbon remover would save you much work and some cost; it probably will do the removing quickly and well. You must take into account the fact that all the crust is not carbon, and it is not possible to guarantee that the time required to clean the cylinders will be the same in each case. With the cylinders once cleaned out, you will be able to keep them so by the systematic use of the decarbonizer. No complaints have ever been made such as will indicate that the decarbonizer will "etch" the cylinder walls.

You probably would save money by having the company furnish you with the necessary parts by means of which you would be enabled to bring about a reform of the carburetion.

The fact that the pin breaks is assurance to you that the key is not tightly fitted. It is dangerous to run a car when the rear wheels are threatening to come off, even if it is a fact that they do not come off very often. The one right way is to have the keys fitted "tight"—as tight as possible. The average man is not capable of doing the work. When the keys are driven home see to it that they are free from oil, and clean out the keyway as well. The new muffler of the same make as the car should serve for you. Some back-pressure is to be expected; not enough to cause you over-much annoyance.

NOISE IS DUE TO INACCURACIES.

Editor THE AUTOMOBILE:

[1,756.]—Despite the greatest care, I am unable to make gears for the transmission system so that noise will be reduced sufficiently for the demands; I know that some transmissions are quite noiseless, and I want to know how the feat is accomplished. In my judgment much of the noise is in the gears; why should it be there when I take the greatest care, use the best cutters the market affords, and cut the gears as accurately as possible?

New York City.

FOREMAN.

In the first place, you "use the best cutters the market affords." This is a sure sign of failure because the market affords

cutters for gears in which the error is admitted, in that they are approximately correct, since they are designed for a range of teeth rather than for a fixed number of teeth. A cutter to be absolutely accurate must be designed for the exact number of teeth in the gear-wheel to be cut. While the error is not great and the makers of machines in general consider the results "good enough," the fact remains that the error makes for noise, in a transmission gear case, in which thin walls accentuate the noise, however little it may be.

If accurate cutters are provided and the teeth are cut accurately, which depends upon the accuracy of the "dividing-head," on the one hand, and the sharpness, speed and feed of the cutter, on the other, provided the temperature of the material on the gear is not altered in the process, the result will be good if it can be claimed that the gears will run on the pitch-line when they are in place; nor must the spindles be limber.

If the gears are hardened it is plain that something will have to be done to compensate for the "swelling" tendency, and if the centers are changed (which is the superior way) care must be exercised to avoid an excess. Then there is the question of the sliding gears. If they are loose on the sleeve, and they will have to be if the shaft is long or if the sleeve itself is long, especially if the shaft is small and if a "broached" (square) hole in the gear sleeve is depended upon for the purpose. If the shaft is of considerable diameter, so that it will not spring, and if (instead of a square) the shaft is spline with six shoulders, against which the pressure will come, it is possible to consider a close sliding fit (with a short sleeve) and then the gears will mesh on the pitch-line, or so close to it as to assure nearly noiseless performance, provided the pitch-line velocity is little more than 1,000 feet per minute as an outside figure.

With all these matters carefully attended to, the remaining questions will be by way of good "silent" ball or roller bearings, and a shell (case) so thick that it will not serve as a "sounding-board" unless to a slight extent, which fault can be leveled by the use of a hard mineral grease, which will serve for the triple purpose: (a) serve as a lubricant for the gears, (b) dampen the noise, the volume that will follow if all the above precautions are observed, (c) serve as a protection for the metal parts, as against rust and other etching media; barring the presence of acids, etc., in the lubricant itself.

CARBON DECREASES IMPACT ABILITY.

Editor THE AUTOMOBILE:

[1,757.]—While I feel confident of the fact that carbon in steel is at the expense of the ability of the same to sustain under conditions involving impact, the fact remains that steel manifests notable peculiarities which would stand some discussion. Why is the steel B N D, as given by Mr. Fay, of high impact ability and at the same time low in elongation (per cent. in two inches), carbon decreases the elongation, and here is a case in which steel is high in impact qualities, and low in elongation; what is the explanation?

Staten Island, New York.

J. F. O'D.

The steel as referred to by you is low in carbon (about 20 points), and it seems that the impact ability is lowered by the presence of carbon, rather than as the direct result of a low elongation. This phenomenon has been noticed many times, and if the steel is low in carbon, from ores and scrap originally low in metalloids, reduced in an acid-hearth, the strength can be increased enormously, at the expense of the elongation, in the heat-treating process (aided by alloys), and the fact that the elongation may be low (relatively) will not be a sign that the impact ability is low.

ARCHIMEDES DISCOVERED THE PRINCIPLE.

Editor THE AUTOMOBILE:

[1,758.]—Will you go back to first principles and explain the action of a float in a carbureter?

Camden, N. J.

JUST-PURCHASED-A-NEW-CAR.

The "Principle of Archimedes" is concisely stated as follows: "A body submerged in a liquid appears to lose a part of its own weight, the amount lost being equivalent to the weight of an equal bulk of the liquid."

If, then, the body weighs less than the weight of liquid it would displace were it of the same specific gravity as the liquid, the "buoyancy" of the body would be as the difference in weight. It is this buoyancy which is taken advantage of, in that the float submerges partially, and as the gasoline raises in the bowl the float is resisted, in that the valve mechanism retards the float and the valve is closed by the pressure due to the buoyancy of the float.

IT HAS THE LOOKS OF POLISHED BRASS.

Editor THE AUTOMOBILE:

[1,759.]—I would like to know why, in the development of the automobile, the flexible tube connecting the hand bulb with the horn, still persists in writhing its tortuous course along the outside of the car, collecting dirt, preventing proper washing of the body and supplying additional brass work to be constantly polished? Are there known objections to permanent internal piping, with simple outlets at the bulb and horn for attaching same?

Very truly yours,

F. W. FERGUSON.

New York.

If the internal piping is properly done it will serve the purpose, and if the objections named go for dissatisfaction it is easy to eliminate the flexible tube on the outside. So many like the appearance of the polished brass on the exterior that a ready sale is assured and, after all, the vendors of the commodity are governed wholly by the fact that good business results. Then, there is the fact that the device does work extremely well, and utility does lend enchantment.

NEW FAN FOR A FRANKLIN CAR.

Editor THE AUTOMOBILE:

[1,760.]—Can you give me a diagram and show what material will be needed to put a fan on a 1904 air-cooled, four-cylinder Franklin automobile? A great many owners have put them on, and as I have one I would like to do so. I do not wish to use a gear unless I have to.

New York City.

FLUSHING.

It might be well to consult the maker of the car; just the information wanted will probably result.

MUST SET SPRINGS HIGHER THAN USUAL.

Editor THE AUTOMOBILE:

[1,761.]—I notice a correspondent has a runabout on which the springs are too stiff, except when he adds a rear seat with a 400-pound load. His problem, which is to make the car ride easy with and without extra load, is an old one. It can only be solved approximately. Supplementary coils, to make the springs ride easy with the light load, would probably make them too easy under the added weight. Lighter springs with "helper" plates, or "bumper" coils are used in delivery wagons, but seem hardly suitable to a pleasure vehicle.

In the nature of a compromise, I suggest the following: As the springs are now too strong for a single seat, they should be lightened so as to balance the car, say to a capacity of about 100 pounds per inch depression. This is what suits the average run-about. The extra weight of 400 pounds, if directly over the axle, would depress the springs two inches, therefore they must be set that much higher than usual. Thus we shall have springs easy enough for the light load, while the additional strength for 400 pounds of extra load will be gained from the two inches of further depression.

This, of course, will make the car stand high behind under the light load, or low under the heavy load, or a little of both. This is the case with his present springs though in a lesser degree.

Chicago.

WM. H. TUTHILL.

OVERLAND CYLINDER MEASUREMENTS.

Editor THE AUTOMOBILE:

[1,762.]—In your February 4 issue, under "Discrepancy in Horsepower Ratings," No. 1,730, in comparing motor sizes the stroke of the Overland motor is given as four inches. Again in the New York show issue of THE AUTOMOBILE and the same issue of "Motor Age," of Chicago, the stroke of the Overland is given in the list of specifications as four inches. As an owner of an Overland "30" to which the above refers, I beg to correct through your columns this misstatement, as the size of these cylinders is 4x4½, bore and stroke. I think your subscriber will find that most four-cylinder motors of this size on the market are rated at 30 horsepower, at a given engine speed.

Ashland, Ohio.

C. A. HOFFMAN.

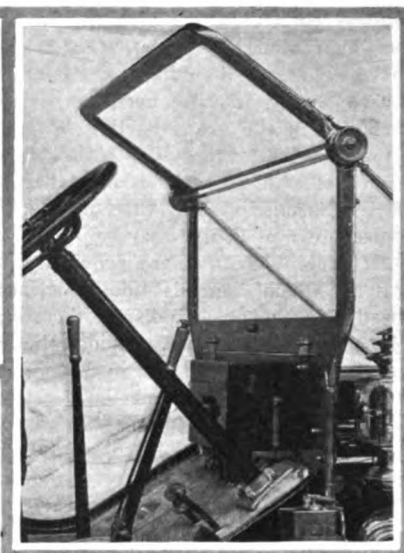
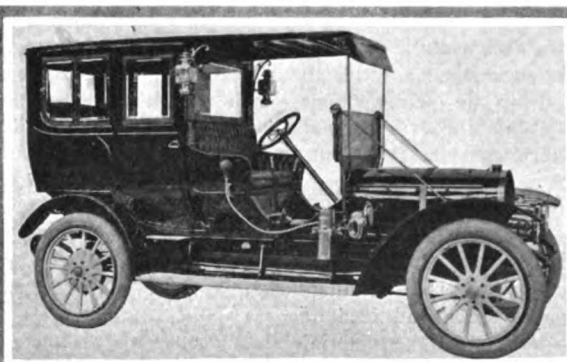
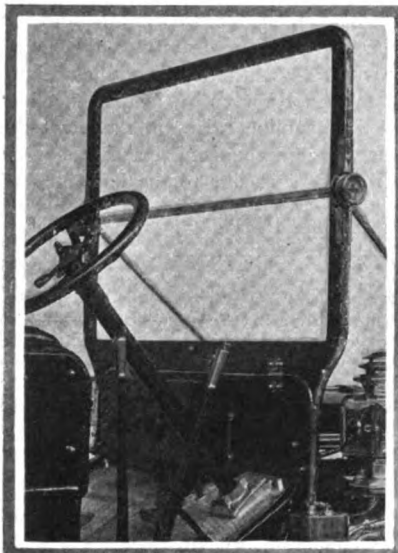

RAMBLER MAKES ITS WINDSHIELD.

In order that the windshield, which has become such a universal equipment on automobiles, shall harmonize

with the general finish of the car, Thos. B. Jeffery & Company have decided to make their own shields for Rambler cars. The illustrations show the shield fitted to the new Rambler limousine with the upper half in three different positions. The shield is of heavy plate glass, with mahogany frame bound with brass, both of which match the finish of the dashboard. Stiff brass rods extending from the middle of the shield to the front of the bonnet insure that the frame will be stiff enough to practically eliminate vibration. An individual feature of the shield

is the ability to locate the upper movable section at any desired angle, two large hand-operated clamps holding the glass in place. The wind is prevented from getting through at the joint, when the shield is raised, by a brass fixture.

The limousine, which is the highest priced as well as the highest grade Rambler product, is shown in the central illustration. This is in the nature of a new departure for the company, being the first production of an enclosed body, but the fine wood-working facilities, together with the long experience on finely built and finished touring bodies, have simply paved the way for this culmination of the body builders' art.

ize with the general finish of the car, Thos. B. Jeffery & Company have decided to make their own shields for Rambler cars. The illustrations show the shield fitted to the new Rambler limousine with the upper half in three different positions. The shield is of heavy plate glass, with mahogany frame bound with brass, both of which match the finish of the dashboard. Stiff brass rods extending from the middle of the shield to the front of the bonnet insure that the frame will be stiff enough to practically eliminate vibration. An individual feature of the shield

REVOLUTIONARY IDEA IN SPARE WHEELS.

MARSHALL, MINN., Feb. 8.—The recent great and growing interest in quick detachable tires and later in spare wheels has stimulated inventors to work along these lines. One of the inventors who has an apparently meritorious idea is Dr. A. D. Hard,

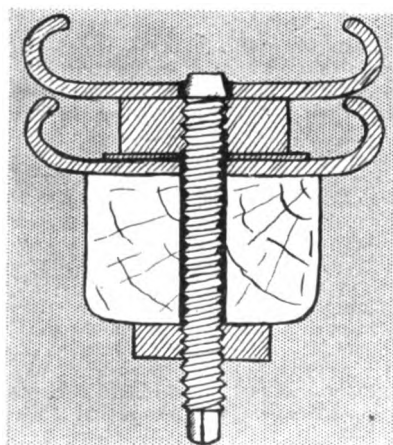

Cross Section Hard Spare Wheel.

of this city. He has patents pending on a device for fastening independent rims to wheels. A series of bolts occupying the lug and valve holes of the ordinary clincher rim as used in practice, and felloe, held in position by two nuts, one of which is adjusted to the space between the rims. The illustration shows a cross-section of an independent clincher rim held upon a common clincher rim by this device. The bolts resist sidewise stress and prevent the independent rim creeping. No bolt heads or nuts project. By its use cushion or solid tires may be quickly and securely attached to clincher wheels, and the diameter of the wheel is kept the same. This preserves the speed ratio, does not derange the speedometer, and permits of return to pneumatic tires at will. By carrying a cushion tire on an independent rim, the ready mounted tire can always be depended upon. Another use is to attach clincher rims to Fisk wheels. It only requires holes in the Fisk wheels to securely fasten clincher pneumatics. Another use is to secure to the clincher wheels tires which are larger in diameter than the former tires. Thus, it enables higher speed, or gives heavier tires, which wear longer. It is a very simple device, consisting for a common-sized twelve-spoke wheel of six bolts and twelve nuts.

HERE'S ANOTHER WONDERFUL INVENTION.

GRAND RAPIDS, MICH., Feb. 8.—A recent invention of a local genius is of interest to automobilists, because it is applicable to electric searchlight, side light, and other lights. When so used it will require no wires, no attention, and cost nothing to operate.

Philip Young, an electrical engineer of this city, has discovered a method of supplying power to electric lights and motors without the use of wiring. His first experiments, which covered a period of two years, have been in the production of light. In this he has been successful, and lately has also produced current for a one-half horsepower motor.

The new lamp does not contain a storage battery, nor a dynamo, but generates its own electricity. The construction is amazingly simple. The base is a small cone-shaped contrivance, to which is screwed a regulation incandescent lamp. The electricity is generated inside the cone, which is only four inches high and an inch and a half in diameter. Inside this cone is a magnet cylinder which is covered on the outside much like an armature, and within which is a hard, white composition, the secret of the invention. It resembles carbon, only it is white instead of black. This composition in contact with the magnet creates the heat and produces light. It has a voltage of 110. The product will be placed on the market very soon by J. W. York & Son, manufacturers of band instruments.

The inventor has had one of the lamps in his home burning constantly since November 24. The members of the family say they use it as they would a lantern. It burns in any position. It is estimated that the lamp will burn for nearly a year.

It is the intention of the inventor to adapt it not only to ordinary electric lighting, but to automobile and other headlights, and to the running of motors.

The Imperial Automobile Club and the German Society of Motor Manufacturers and Traders have resolved to hold a combined motor boat and aeronautic exhibition in Berlin next year from March 1 to April 10. The industry will back up the promoters to the fullest extent and the primary arrangements have already commenced.

NEW YORK CITY CARNIVAL WEEK PLANS ARE MADE

ANOTHER week of festivities in automobile trade circles in New York City, made an annual affair after the phenomenal success attending the first one last year, is now being arranged by the automobile carnival committee of the New York Automobile Trade Association, which held its first meeting recently to outline plans. It was decided that the week from April 5 to 10 should be the one set aside for the celebration—one which will contain more elaborate and extensive features than the initial attempt and be concluded by a day instead of a night parade. The enthusiasm shown at the meeting presages success for the carnival, and the support of the whole trade is promised.

The affair last year was one of the most enlivening events in trade circles ever conducted, thousands of persons taking part,

and hundreds of thousands coming from neighboring cities and towns to see the parades, decorations, cars themselves and contests. The crowds on the streets and the general spirit exhibited all over the city were evidences of the importance of the events, but it has been felt that many more would have taken part in the big parade of decorated cars if it were held at day. As it was, the length of the parade was exceedingly great, and some of the features of illumination were made possible by the darkness, but from present indications the greater preference for daylight affairs will offset this.

Another meeting of the committee will be held at an early date, when more of the details will be considered and further plans mapped out.

HERRESHOFF MAKES ITS METROPOLITAN DEBUT

THAT New York City awaited with interest the arrival of an entirely new production was well shown this week upon the appearance from Detroit of the first of the new Herreshoff touring cars, now being exhibited by Harry S. Houpt in the Rhinelander Building. A car which follows well-recognized lines of construction, with improvements claimed by the designer and makers, in both chassis and body, was what was seen by the many enthusiasts who have been following the progress of the car through the manufacturing stages as told by the pen of Advertising Manager West.

For many weeks the cars have been under way in the factory and tested on the roads so that it is expected from now on there will be a steady flow of the finished product to New York and other cities. For the moment however interest has centered in the advance guard, and the great number of people who have visited Mr. Houpt's new quarters have shown enthusiasm over it.

A four-cylinder motor rated at 24 horsepower, but which in brake tests is said to have developed 30, furnishes the power, with inlet and exhaust manifolds and a carbureter which were especially designed for it, and valve lifts, crankshaft and camshaft arrangements which show considerable ingenuity. The motor, clutch and three forward speed-selective sliding-gear transmission are an integral part. The power is transmitted by shaft to the live rear axle in a direct line, and with a gear ratio adapted to a maximum speed of from 45 to 50 miles per hour.

The car was designed primarily as a light machine of good class, suitable for owners of large, heavy cars in saving the

latter from the wear and tear of use in cities, as well as for extended use by others in country touring and all-around work. Its light weight tends to lower tire expense and cost of operation, while at the same time ample power and effective springs make it suitable for use out of town and on any kind of roads. According to the statements of the designer, Charles Herreshoff, added efficiency at the rear wheels is obtained by a better co-relating of the component parts than in many machines of size and selling price of this one.

By virtue of improved design the motor, which is built by the American and British Company at Bridgeport, Conn., greater potential ability has been secured from a given cylinder volume than usual, and careful attention to the same principles was followed in making the other parts of the car. The contracts made by the Herreshoff Motor Company, of Detroit, with the firms furnishing materials call for the same quality as are employed in the best American and foreign machines. Many of the manufacturing processes are carried on in the new factory.

In body equipment the car compares favorably with any of its size, giving ample seating capacity for five persons, the front seat being divided, and all upholstered in fine grain leather. Curved and enclosed fenders protect the passengers from flying mud and dirt. It is planned to produce about 1000 of these machines for the 1909 season, 200 of which are intended for New York City alone, while almost the entire output will be marketed in the East. The Middle, New England and Central States are included in this, and the West will not be taken up until 1910.

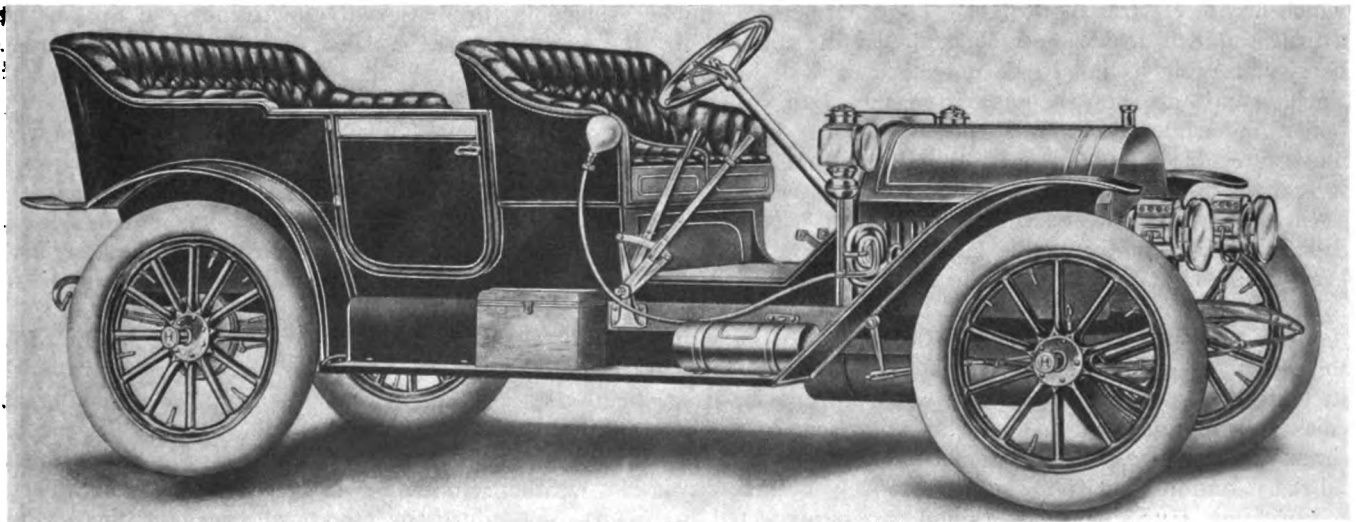

Herreshoff 24-H.P. Touring Car, with Straight-Line Shaft Drive and High-Duty Herreshoff Motor.



Vol. XX Thursday, February 18, 1909 No. 7

THE CLASS JOURNAL COMPANY

Thirty-ninth Street Building, 231-241 West 39th St. New York City

H. M. SWETLAND, President

EDITORIAL DEPARTMENT

A. G. BATCHELDER, Managing Editor; R. F. KELSEY, Associate Editor; C. B. HAYWARD, Engineering Editor; W. F. BRADLEY, Foreign Representative

BUSINESS DEPARTMENT

A. B. SWETLAND, Business Manager; LOUIS R. SMITH, FRANK B. BARNETT, W. I. RALPH, 1085 Old South Building, Boston, Mass.; C. H. GURNETT, F. W. VAN SICKLEN, 1200 Michigan Ave., Chicago, Ill.; H. H. GILL, Detroit, Mich.; T. B. VAN ALSTYNE, Philadelphia, Pa.

Cable Address - Autoland, New York; Long Distance Telephone - 2046 Bryant, New York

SUBSCRIPTION RATES:

United States and Mexico - One Year, \$3.00; Other Countries in Postal Union, including Canada - One Year, \$5.00; To Subscribers - Do not send money by ordinary mail. Remit by Draft, Post-Office or Express Money Order, or Register your letter.

FOREIGN SUBSCRIPTION AGENTS:

ENGLAND: - W. H. Smith & Sons, Ltd., 186 Strand, London, W. C., and all their railroad bookstalls and agencies throughout Great Britain; also in Paris at 248 Rue de Rivoli. FRANCE: - L. Baudry de Saunier, offices of "Omnia," 20 Rue Duret, Avenue de la Grande Armees, Paris. GERMANY: - A. Seydel, Mohrenstrasse 9, Berlin.

Entered at New York, N. Y., as second-class matter. The Automobile is a consolidation of The Automobile (monthly) and the Motor Review (weekly), May, 1902, Dealer and Repairman (monthly), October, 1903 and the Automobile Magazine (monthly), July, 1907.

SILENT PERFORMANCE NOW NECESSARY.

Automobiles were once quite up to the scratch from the point of view of noise; all the kinds of noises possible in machines emanated from the bowels of some of the earlier types of cars. As it is at the present time, cars must perform noiselessly to be regarded as up to a fitting standard. In this connection it becomes necessary to define what will be regarded as noise relative to sounds which do not class as discordant. That motors will emit a little sound is to be expected, and that the sound can be so agreeable as not to be noticeable is well known. Such sounds are not as noise from the point of view taken, and while absolutely silent performance would be most agreeable, the fact remains that such performance is scarcely to be expected.

In the meantime it is assured that noise is wholly un-called for, and many are the automobiles to be seen at every hand in which harmony is so entwined as to resolve all sounds into the class called agreeable. That modern transmission construction has a lot to do with this noiseless performance is assured, and the reasons lie in better material, more accurately proportioned parts, thicker walls, and micrometer fits; taking into account limits of tolerance, which automatically compensate for all the variations that follow in the footsteps of necessity - since it is true that no workman can be expected to arrive at the point - on the road called excellence, so very

far that a one-inch plug will go into a one-inch hole.

Gears are now so well made that they will run on the pitch-line, despite the fact that they have to be heat-treated after they are machined; the teeth are so nicely fashioned that they "mesh" to a nicety, and the surfaces roll on each other almost to the entire exclusion of shock, jar, or rubbing. Bearings now do justice to the fine work which prevails throughout the rest of the system, and the spindles are short, of great rigidity, and of such fine material that "flexure" is reduced to the point below which its presence makes for noise. The end is that transmissions are efficient, and they will last for a long time; life and efficiency are as companions.

If healthy conditions can be regarded as present in a new car, it is the duty of the purchaser to make the residence in the car so inviting as to prolong the visit for the greatest possible length of time. Better yet, to make the conditions so happy as to render the home - if such it may be called - permanent. It is a simple process; noise, and what it entails, will never dispossess silent performance in a car that is well oiled, and in which the "silt" of the road is not invited, even for a temporary sojourn.



COMMERCIALS WORK IN BAD WEATHER.

A little slippery weather, of which the past two weeks have afforded a few striking examples, serves well to emphasize the advantages of the commercial power wagon over the horse in respect to tractive effort and reliability. A common sight, when the streets are icy, is a horse slipping, slipping, all over the pavement unable to get a secure footing. Almost as common is the sight of a crowd collected in the middle of the street around a wagon, denoting that a horse has fallen to the pavement. The power wagon, on the other hand, to which the streets all look alike, glides by the fallen horse with its perplexed driver and the advising crowd just as if there were no such thing as ice and snow. One can almost imagine the latter as it passed the horse saying with a snort, "competition, humph"! On these days, so common in a hard Winter, the effective radius of the horse is reduced to about ten miles; that is, that distance would constitute a day's work. On the other hand, there is no diminution of the truck's effective radius.

Then, in the matter of effectiveness, in the one case, the animal must be treated with extreme care; one might almost say "like a baby," else accident or death may result, meaning delay and a consequent heavy expense for a new horse. With the machine, however, no babying tactics are necessary; a day's work is the same, weather or no weather. The heavier loads carried and the great improvements in commercial vehicle tires have so increased the effective tractive effort as to make the vehicles practically independent of road conditions.

With the coming of hot weather, the scenes of distress are repeated with the same poor hard-worked brute as the chief actor once again. So looking at it from all points of view, it would appear as if the commercial vehicle has the advantage in cold weather, in hot weather, and, of course, in moderate weather; in short, the advantage is at all times in the gasoline-driven machine.

RACING CONTROL IS NOW UNDER A REVISED PLAN

HARMONY in the automobile racing situation seems to be a well-nigh accomplished fact in this country, a condition which has been a stranger to American contest circles for many long months, and all this was secured as a result of a number of meetings held in Chicago during the show.

While the Contest Board of the A. A. A. will have matters in charge, with power to grant sanctions, in all of its actions it will be, more or less, advised by a committee representing the Association of Licensed Automobile Manufacturers, the American Motor Car Manufacturers' Association, and the Importers' Automobile Salon.

The movement which has culminated in this amicable agreement is not a new one and has been slowly attaining importance for some time. In January, during the Madison Square Garden Show, a number of manufacturers met and decided to form a Manufacturers' Contest Association at Chicago; and this was done, membership being limited to makers who have built fifty or more cars, and importers who have brought a like number to this country, although non-members will still be eligible to compete in events. The organization was completed by electing Benjamin Briscoe, of the Maxwell-Briscoe Motor Company, as president; W. E. Metzger, of the E. M. F. Company, as secretary-treasurer; Russell A. Field, of New York, as his assistant, and Howard E. Coffin, of the Chalmers-Detroit Company, as chairman of the committee on rules.

Of the twenty-five members constituting this body, the following five were selected, with Mr. Coffin, to act as an executive committee: Elmer Apperson, Apperson; George Weidley, Premier; Paul LaCroix, Renault; A. L. Riker, Locomobile, and one other yet to be announced. It was then that a committee was appointed which should confer with the A. A. A., and this was composed of Howard E. Coffin, Alfred Reeves, of the A. M. C. M. A.; E. P. Chalfant, of the A. L. A. M., and E. R. Hollander, representing the importers.

At the same time the Executive Committee of the A. A. A. was preparing to meet the manufacturers half way by authorizing the appointment of a committee to confer with them and composed of F. B. Hower, L. R. Speare, Powell Evans, and F. H. Elliott. This body, together with those from the M. C. A., composed the court which took up the matter of a joint and harmonious action in controlling automobile contests in America, on road and track, and the questions discussed were those which have been bothering autoists all over this country and have even affected the makers in Europe. Supporters of the A. A. A. have at times seen reason to criticize, but at the same time have

realized that the only solution of the problem could be through a national body vested with complete but advised authority.

The result has been satisfactory so far, and with men who are thoroughly familiar with the conditions, discussing and arranging them, it is felt by those most vitally interested that a staple condition will be obtained. The manufacturers have made it plain that they do not wish to become identified with the promotion of the contests, but at the same time that they should be consulted, that they desire to have the number of races limited, and both the races and endurance runs supervised in regard to rules and other regulations. The A. A. A. committee has reported favorably upon the arrangement whereby it should have control of these affairs with an advisory board from the M. C. A., and it is assured that on March 2 this will be ratified at the meeting of the executive committee of the A. A. A. in New York.

Of premier importance to makers was the proviso adopted that all rules for contests of a certain year must be published by September 1 of the preceding year, thus those for 1910 events will be given out next Fall, and at the same time this makes the rules adopted for this season's contests and already considered remain in force. One point which was brought up was the attitude of the A. A. A. toward racing on one-mile tracks, a practice which it has recently refused to sanction, and this difficulty has been overcome by the recommendation that the national body again sanction these meets, but with the understanding that some representative of the Contest Board must be in attendance.

Still another phase to be considered was that of the term "international," which will be so defined that a promoter cannot dodge the issue of obtaining a sanction by simply enlisting a few foreign cars and then calling the meet an international one. It is the general opinion that whatever differences of opinion have arisen in the past among the various motoring organizations as to the status of this term will not be reopened.

This condition of racing affairs is one that will undoubtedly be of great benefit to the industry, to the sport, and to the realization that there must be a national governing body, and that if the latter has been open to criticism in the past, that fact does not give a reason for belittling the necessity for it.

The Contest Board of the A. A. A. is composed of Frank B. Hower, chairman; Frank G. Webb and A. L. McMurtry, and the Advisory Board, A. L. Reeves, E. P. Chalfant and E. R. Hollander. Some autoists feel that it would perhaps be better to have a separate board for speed races, leaving touring contests under the control of the present body, but at present the existing arrangement seems to be the program.

TRANS-CONTINENTAL CONTEST TO SEATTLE FAIR

A TRANS-CONTINENTAL endurance run from New York City to Seattle on account of the Alaska-Yukon-Pacific Exposition, which opens in that city on June 1, is the latest competition proposal in autoing. From the interest already taken in the event it may become a real cross-country race with a goodly number of foreign and American entries. The trophy presented by M. Robert Guggenheim, valued at \$2,000, gives this title to the contest: "An International Contest for the M. Robert Guggenheim Trans-Continental Trophy and Cash Prizes, under the auspices of the Alaska-Yukon-Pacific Exposition and of the Seattle Automobile Association."

John Kane Mills and T. Francis Moore, of New York City, have been given charge of the affair, and for two months they have been working upon routes, rules and plans in general, and on Monday evening of this week the latter member of the firm started for Seattle with the tentative rules and regulations in his pocket. With the directors of the exposition these will be taken

up in detail and a definite understanding made as to the conduct of the contest.

Starting either on May 15, as desired by the Westerners, or on June 1, as suggested by the New Yorkers, it is generally thought that the winner will take about twenty days to make the run across the country over a route about 3,900 miles in length, with few rules, few checking places and in many cases far enough away from railroads so that the cars will be competing under touring conditions. As proposed, the route taken will lead the cars from New York City to Albany, Buffalo, Cleveland, Chicago, Clinton, Ia., Dennison, Neb., Omaha, North Platte, Cheyenne, Wyo., Granger, Pocatello, Montpelier, Boise, Burns, Salem, Portland and into Seattle. The only new part of the course will be that west of Granger, nearly all of the others having been covered in previous contests.

Already five foreign car entries are promised, with famous touring drivers slated to appear on American soil to try again to

make a better showing than in the last race across the United States. American cars are assured by both makers and dealers, and the dates proposed will be such as to cause no conflict with the annual tour for the Glidden Trophy, which usually starts the second week in July.

Of rules there are few, advisedly so because the contestants will not travel in numbers, and the ones gotten up must be sanctioned by the Seattle people before being given out. It is known, however, that it will be a case of first into Seattle to win the trophy and \$2,000 in cash, with enough intermediate checking stations to prove that the cars have been driven over certain routes. A list of hotels will be compiled at which the night and day clerks will be the official checkers. No observers will be carried, and the cars can be rebuilt if necessary, except in the case of the frame, which is considered the car's foundation.

The rule which has caused widespread comment, however, is that although drivers may be changed or relayed, yet they cannot leave the car in which they started, and when tired and

sleepy must fall back into the tonneau to get their rest. Of trophies and prizes there are enough to satisfy those who qualify, the winner getting \$2,000 besides the trophy; the second car taking \$1,500; the third, \$1,000; the fourth, \$750, and the fifth securing \$350. In case an amateur does not wish to take cash, plate may be substituted.

There is time enough before the start for such a thorough discussion of the points that it is expected that all will be clear and well arranged and there is extended interest even at present hinging over the rules. It has been suggested that to eliminate somewhat the grind upon the participants that at least two stops of twenty-four hours each shall be included, one at Chicago and the other at Cheyenne.

Just how this race will affect the one planned by the *New York Times*, to start for San Francisco on the fourth of July, is not known, some thinking that perhaps the one contest will do for both and that a second one would not be attempted, others thinking that perhaps both might be combined on the earlier date.

FOUR PERFECT SCORES IN ROCHESTER MID-WINTER RUN

ROCHESTER, N. Y., Feb. 15.—Of the sixteen cars entered in the Rochester Automobile Club's first annual mid-winter endurance run, four finished without a single demerit charged against them. Of these, two were in Class A and two in Class B. A source of great local pride is the fact that three of the four to go perfect were born and brought up in Rochester, so to speak.

To put it mildly, the weather conditions were fierce. The drifts encountered were fully as bad as those which the New York-to-Paris racers ran into just a year ago, the snow being fully four feet deep in places. The wind, a 40-mile gale, blew right into their faces for half of the trip. Not a few of the drivers had fingers or toes frozen, while all of them were bundled up so that movement of any sort was unpleasant. In one case this was the cause of a demerit, as Driver Davis of No. 1 Gaeth ran into a snowbank and while trying to throw the clutch his feet became entangled in the robe and the engine stalled. This cost him one point.

All of the starters reached Buffalo except two, but the road beyond that city was the scene of the first and only serious accident. This happened to No. 9, Selden, driven by Hector Caramella, which was going at a fair clip towards Rochester when, upon rounding a curve, another car was overtaken. Not having time to bring his machine to a stop, Caramella drove up an embankment at the side of the road. This caused the car to turn turtle, throwing the occupants out.

No. 7, Selden, driven by Charles Young, set out at the start to go over the route as quickly as possible, and was promptly disqualified for speeding. Young arrived in Buffalo two hours ahead of the pacemaking car and promptly started back. He finished over five hours ahead of the bunch. The result of the contest was that two cars finished with perfect scores in both classes. These are No. 5, Selden, driven by W. C. Barry, Jr., and No. 10, Gearless, driven by F. C. Shannon, in Class A; No. 6, Selden, driven by Henry Selden, and No. 15, Cadillac, with Richard Guyer at the wheel carried off the honors in Class B.

The club officials have announced that some day next week the double tie will be run off to determine the possessors of the silver cups. This run-off will probably take place over a different route than the contest, but this route has not yet been announced.

These were the participating cars:

Number	Car	Entrant	Driver	Result
5 A	Selden	W. C. Barry, Jr.	W. C. Barry, Jr.	Perfect
10 A	Gearless	Gearless Co.	F. C. Shannon	Perfect
6 B	Selden	H. R. Selden	H. R. Selden	Perfect
15 B	Cadillac	Mabbett & Betts	R. Guyer	Perfect
1	Gaeth	Outbout & Henry	O. W. Davis	1 Point
3	Cadillac	Mabbett & Betts	H. Pye	1 Point
2	Cadillac	Mabbett & Betts	Betts
4	Oakland	L. B. Kirkpatrick	Mercler
11	Buick	C. L. Whiting	C. L. Whiting
13	E-M-F	Peck & Brooks	Peck
14		Peck & Brooks	Brooks
7	Selden	Geo. B. Selden	C. Young	Out for speeding
9	Selden	Selden Co.	H. Caramella	Out—overturned
12	Buick	C. L. Whiting		Out

FLORIDA'S 1909 BEACH RACES.

New events and classifications have been prepared for the annual races on the Florida beach, which will be run this year at Daytona from March 23 to 26, under the patronage of the Florida East Coast Automobile Association and promoted by the Motor Contest Association, Inc., of which Senator W. J. Morgan is manager. Price and piston displacement have been used to divide the cars in the longest of the events. Twenty-two races altogether have been scheduled, of which only ten are for autos, the others being for motorcycles, bicycles and aeroplanes.

At 200 miles each are the Florida stock car and piston displacement races, with first, second and third moneys in each and an additional one for the driver doing best in both. The regular race for the Minneapolis trophy will be held, as will also that for the Two-mile-a-minute Speed Crown and the mile time trials for the Sir Thomas Dewar trophy. An international free-for-all at one, five and ten miles; a Southern price and horsepower handicap; a Vanderbilt Cup competitors' race, and an invitation match race for George Robertson, Louis Strang, Herbert Lytle, Ralph De Palma and other noted drivers complete the list.

NATIONAL'S THOUSAND A DAY.

INDIANAPOLIS, IND., Feb. 16.—The National Motor Vehicle Co. has come to the front with a brand new proposition in automobile circles. One thousand miles a day for ten days is the modest feat the company will attempt some time in May or June.

Arrangements have already been completed to have the event on the track of the Indianapolis Motor Speedway Co., which is now being built, and will be completed some time between May 15 and June 1. The 1,000 miles a day for ten days event will be among the first on the speedway.

WANTED: A BRIARCLIFF QUORUM.

NEW YORK, Feb. 16.—Lack of a quorum to-day prevented, for the second time, a meeting of the manufacturers' committee in charge of the Briarcliff race, and again it was postponed, this time until next Monday, when it is hoped that all the members will have returned from Chicago and attend. In the meantime, as the date desired for holding the contest approaches, the probability of securing acceptable rules diminishes.

CLUB GOSSIP FROM FAR AND NEAR

OLD BICYCLE CLUB BECOMES NEW AUTO BODY.

PHILADELPHIA, Feb. 15.—On Friday evening last, at its handsome home, 1606 North Broad street, there was effected a reorganization of the Century Club (formerly the Century Wheelmen), whereby, by the addition of a half-hundred new motoring members to the score or more already on the rolls, the famous old organization will seek future fame under the title of the Century Automobile Club.

Something less than a decade ago the Centuryites had a strong automobiling element in their membership—so strong, indeed, as to warrant the officials in transforming the club's huge wheelroom into an up-to-date club garage. Two or three years later, with the formation of the local automobile clubs, Century's motoring element drifted away, and the bowling craze having just about that time hit the city, the club management effected another transformation in the erstwhile wheelroom by installing four up-to-date alleys, and the Century Club (the "Wheelmen" having been discarded some years before) pursued a quiet existence as a social club.

Always wide awake, the Centurians some time ago saw an opportunity of injecting new life into their organization by offering inducements to local motorists to join them. The principal one of these was the club house itself, the only other autoing organization in the city having one being the Germantown Automobile Club.

In announcing its future policy, a prominent official of the club said that endurance runs, hill climbs and other contests would be promoted by the club at suitable intervals, but that it would be the primary object of the contest committee—which, by the way, is to include only men not connected with the trade—to formulate a set of rules which will give the private owner a chance with the entrant who is in the trade, and who, therefore, has an undue advantage over the "layman." This will be brought about by making separate classes for private owners and trade members. To insure absolute justice in the contest committee's decisions, a rule will be formulated to debar from service on the committee, for the time being, any owner who may have entered a car in the run or hill climb or other event than *en tapis*. This radical rule will, it is hoped by the Centurians, effectually prevent the bickerings, protests and heartburnings which have invariably followed the contests promoted locally heretofore.

NON-OWNERS MAY JOIN A. C. A.

NEW YORK CITY, Feb. 15.—A new class of membership has been adopted by the Automobile Club of America for persons interested in automobiles but not owners of them. This will be known as "Clubroom membership," with the privileges of the assembly, grill, billiard and general social rooms and the library, but without those necessary to owners of cars, such as the garage facilities, touring information and maps.

The new class is limited to 100, and will allow those elected to it to enjoy the benefits of the luncheons, lectures and entertainments given by the club. There is no initiation fee attached, and the annual dues are \$25.

CHATTANOOGA PLANS CARNIVAL.

CHATTANOOGA, TENN., Feb. 15.—Under the auspices of the Automobile Club of Chattanooga a carnival will be held on March 16, 17 and 18. A hill climb will take place on Lookout Mountain, and speed contests on a mile track at Olympia Park. Three cups for the latter have been offered, one by the Chattanooga Automobile Club, one by the chamber of commerce, and the third by the Patten Hotel. The trophy for the Lookout Mountain climb has not been decided upon. The danger of the latter course has been lessened lately by the placing of heavy fences at danger points.

ILLINOIS STATE ASSOCIATION REJUVENATED.

CHICAGO, Feb. 15.—The effort to rejuvenate the Illinois State Automobile Association has been successful, a new set of officers being elected and an active campaign planned. L. E. Meyers, of the Chicago Automobile Club, was re-elected president of the State associations, while George W. Ehrhart, of Decatur, was chosen first vice-president; R. A. Whitney, of Peoria, is the new second vice-president, and E. W. McCready, of Chicago, third vice-president. F. H. Trego, secretary of the Chicago Motor Club, will officiate in the same capacity in the State association, while John Farson will look after the finances. Directors chosen were A. J. Olson, Woodstock; R. H. Colby, Aurora; R. A. Baker, Springfield; W. H. Van Dervoort, Moline; J. C. Dickerman, Rockford; David Beecroft, E. Lewis Kuhns, Joseph F. Gunther and Sidney S. Gorham, Chicago.

Committees appointed were as follows: Revision of by-laws, F. H. Trego, E. W. McCready and S. S. Gorham; State reorganization, George W. Ehrhart, R. A. Whitney, R. A. Baker, J. C. Dickerman and H. Tucker; trade affiliations, Henry Paulman, E. Q. Corder, Edward Rowen and David Beecroft; finance, P. J. McKenna, W. Hildreth and H. Paulman. The work of the association for the coming year will be along the line of securing favorable legislation for motorists, co-operation in the improvement of the State roads, signboarding, the securing of discounts on motor car supplies for members and uniform laws for the central West.

HARTFORD CLUB TO HOLD SPRING RUN.

HARTFORD, CONN., Feb. 15.—Four stages of fifty miles each, making a total of 200 miles, will be the distance to be covered by the contestants in the endurance run which will be held by the Automobile Club of Hartford on May 22, with Hartford the starting and finishing point of each lap, and roads in various directions being chosen as the routes. This was decided at a meeting of the club when plans for the contest were brought up. The idea of having the competing cars pass through Hartford as many times as possible was a popular one.

The first lap will be from the start to New Britain, Meriden and Farmington back to Hartford, a route which will give the cars some climbing over the Southington Mountain. The second stage is to the east, over some rough roads, through Manchester, Hazardville and Windsor; the third is down the Connecticut Valley to Middletown, Portland, Glastonbury and back to Hartford. The final lap will take in Bloomfield, Granby, New Hartford, Canton and over the Talcott Mountain to the finish. There will be three classes for cars: Class A, for cars costing less than \$1,500; Class B, for those costing from \$1,500 to \$3,000, and Class C, for those costing more than \$3,000. There will be cups for first and second place in each class.

Time penalties will be figured at one point for each minute lost, and gasoline engines must be kept running except at the noon control. Stops for tire trouble and for traffic will not cause penalties if motors are kept running, and the time will be added to the schedule by the observer. For any breakage or deformation of springs, spring hangers, frames or axles there will be a penalty of 60 points for each part.

SAVANNAHIANS TO DINE JACKSONVILLIANS.

SAVANNAH, GA., Feb. 15.—On Washington's Birthday the Savannah Automobile Club will give an oyster roast at King's Ferry. This place connects Savannah with Bryan county, and to it is one of the most beautiful roads in the State of Georgia. The Automobile Club of Jacksonville will be invited, and so will be Governor Hoke Smith and Governor-elect Joe Brown. From the Savannah club will be Frank C. Battey, R. M. Hull, Mayor George W. Tiedeman and Harvey Granger.



Governor Magoon Uses Franklin Car in Final Cuban Inspection.

White Plows White Snow.—The record-breaking snowfall in Milwaukee last week furnished ample opportunity for Milwaukee dealers to demonstrate the worth of the motor car as a winter vehicle. D. W. Stewart, manager of the White Co.'s Milwaukee branch, and the Hokanson Automobile Co., agents for the White Steam car at Madison, Wis., the state capital, took full advantage of the snow and pushed through drifts that horses and street cars could not buck. In Milwaukee a White steamer pulled the plow that cleared off the snow on all walks in the plant of the Schlitz Brewing Co. At Madison the White made a trip from the garage to the car barns of the street railway company without a hitch and while all street cars were tied up by drifts.

Far Western Drivers Will Climb Hills.—One of the greatest events of the year on the Pacific Coast is the annual Pasadena-Altadena hill climb. This will be held on Washington's birthday, which is a few weeks earlier than last year, the change being made on account of the rainy weather of previous years. Nine classes have been listed, differing as to price, and one special for the four fastest cars in the other nine events. The latter was won last year by Apperson in 1 min. 36¼ sec., and Edgar Apperson himself will be on hand to drive the "Jackrabbit" this year.

Want Oldest Electric.—Two prominent historical museums of this country are now endeavoring to secure from the Baker Motor Vehicle Company for permanent ownership, the Baker electric which has the honor of being the first of its kind built in this country. This car is wanted to add to collections of the first cars made, to contrast with those of the present time as showing the advance made in methods of road locomotion and it will undoubtedly be donated. This electric is said to be a fine type to contrast with the modern beautifully finished machines because of its century-old and general thrown-together appearance.

New Tire From Trenton.—The United and Globe Rubber Manufacturing Company, of Trenton, N. J., has gone into the field of automobile tire manufacturing with a pneumatic tire which will

hear that name. A section of the firm's factory has been set apart for the necessary machinery, vulcanizers, etc. John S. Broughton, secretary and general manager, as well as Watson H. Linburg and Welling G. Sickel, other members of the firm, have had their cars equipped with experimental tires for some time to give them road tests and have found them to be highly satisfactory.

Pittsburg Buys a Pierce Arrow.—The city of Pittsburg is now the owner of an automobile. The purchase has just been made by the department of public safety, bureau of police, the choice being a Pierce-Arrow of 40 horsepower. It is the intention to use the car principally for riot and emergency calls. To that end dash cabinets have been arranged to carry revolvers and handcuffs, while heavy holsters, large enough to hold three high-power rifles, are attached to the back of the front seat. On the running boards are two large-size fire extinguishers.

The Goodrich Girl for 1909.—Adele is the Goodrich girl for 1909; "messenger, advocate, sweet persuader, reminder—and withal a rare, wistful, restful companion—just the sort for a man to take into his confidence," is the manner in which her sponsors describe her. Adele is the girl of the poster that the B. F. Goodrich Company, Akron, O., is sending out for the year 1909, in accordance with the now long-honored custom of this company. The Goodrich girl has become as famous as the Goodrich rubber products.

Trenton Dealers Organize.—Automobile tradesmen in the Jersey capital have organized the Trenton Automobile Dealers' Association with the following officers: President, R. C. Manning; vice-president, U. G. King, and secretary-treasurer, John L. Brock. A committee on automobile exhibit is composed of S. E. Kaufman, Walter Slack and Harry Stout. The coming show was taken up for discussion and this committee will have it in charge. Sixty cars are expected to be shown.

Packard Warehouse in Long Island City.—Extensive plans for a nine-story warehouse to be built in Long Island City for the Packard Motor Car Com-

pany of New York City, have been made by architects Albert Kahn and E. Wilby, of Detroit. The building will be used to relieve the congestion at the New York house, and in it will be room for storing cars for future delivery, repair shops, body building, and repairing departments.

Wagner-Field Company.—Automobile advertising and publicity handlers, has found larger quarters necessary to accommodate a growing business and has moved into offices on the first floor of the Thoroughfare building at 1777 Broadway, New York City. M. Worth Colwell has joined the literary forces, and Burr Edwards Giffon, formerly with the Bates Advertising Agency, has taken charge of the art department.

Change in Sales Methods.—The "Long-Arm" System Company, of Cleveland, announces that dating from February 15, 1909, the sale of its products will be conducted by the company direct. This change is made with a view to getting clearer business understanding and closer engineering touch with customers. Correspondence relating to all matters should be addressed direct to the company.

Studebaker Officers Unchanged.—The Studebaker Automobile Company at its annual meeting re-elected its present officers for the ensuing year. They are: Col. George M. Studebaker, president; Nelson J. Riley, vice-president; Clement Studebaker, Jr., secretary; Charles A. Carlisle, purchasing agent; Hayden Eames, Cleveland, general manager.

PERSONAL TRADE MENTION.

E. T. Birdsall has resumed his practice as a consulting engineer in New York City, opening offices at 41 West 63d street, and intends to make a specialty of the design and operation of commercial vehicles. He will also design gasoline engines for all purposes, make tests and appraisals. An automobile brokerage department has been opened for the benefit of prospective purchasers either of new or second-hand cars, expert advice being given. Mr. Birdsall has now had ten years of experience in the automobile manufacturing field and twenty-two in general engineering.

W. McKean White, formerly a Philadelphia automobile writer, has joined the editorial staff of THE AUTOMOBILE. Mr. White has been handling the automobile news for the *Evening Times* of Philadelphia since the Glidden Tour of 1908, previous to which for two years he had charge of similar work on the Philadelphia Press. Before entering the news field he was connected with the automobile trade in sales capacity, starting with Martin & Hart, at that time the Philadelphia agent for the Thomas and Cadillac in 1905, and later being with J. Hervey Nichols, the agent in Denver for the Winton and formerly the Oldsmobile.

Walter C. White at Show.—Walter C. White, the second vice-president of the White Company, in visiting the Chicago Show made his first appearance since his accident last spring at Cincinnati. Six months of residence in hospitals followed that, but he has fully recovered and is again in charge of the selling part of the White business. His arrival at the show was the beginning of an impromptu reception at the White exhibit.

Charles S. Monson has been secured by Gray and Davis of Amesbury, Mass., to act as western sales manager. Mr.

Monson has been the manager of the Detroit G. and J. Tire Company's branch for the past three years, previous to which he was with the Hartford Rubber Works for about four years and from 1893 to 1900 was salesman and superintendent of agencies for the Gormully & Jeffery Manufacturing Company.

A. R. Pardington, vice-president and general manager of the Long Island Motor Parkway, Inc., has accepted the chairmanship of the automobile committee of the Queensboro Bridge celebration, which is to take place during the week of June 12-18. An elaborate program of special interest to automobilists will be arranged, and a large attendance is already assured.

E. Roger Stearns, formerly manager of the Buffalo branch of the Ford Motor Company, has become assistant to N. A. Hawkins at the Detroit factory. Mr. Hawkins will assume many of the duties of vice-president James Couzens, who is going to do some pleasure traveling in this country and abroad during the next six months.

M. B. Leahy, formerly assistant manager of the Buffalo branch of the Ford Motor Company, has succeeded to the managership through the transferring to Detroit of E. Roger Stearns. Mr. Leahy's promotion comes in line with conscientious and faithful service and is well merited.

R. A. McNeilly, who has been connected with the Pope Manufacturing Company of Hartford, Conn., for the past five years, has resigned from that concern and in the future will be connected with the Boston branch of the Rambler Automobile Company.

Alfred Reeves, James Couzens and D. J. Post.—This trio left on Wednesday for a "rest" round of the Florida resorts, intending to go South as far as Miami and catch sharks and other denizens of the deep.

Edgar E. Mason, who has been connected with the Oakland, Cal., branch of the Auto Vehicle Company, has been appointed manager of the San Francisco branch of the Durocar Manufacturing Company.

George Jordan is now the manager of the Cameron branch in New York City, located at 231 West Fifty-fourth street.

DINNER GIVEN BY WOODS.

CHICAGO, Feb. 15.—On the top floor of its new factory, where a dining room and vaudeville stage had been installed, the Woods Motor Vehicle Company last Wednesday evening gave a dinner and entertainment to a number of the visiting tradesmen and press representatives. It was conveniently held after the show had closed for the evening and when artists from leading theaters could be present. Woods electric batteries furnished a brilliant illumination. Among those present were the following: H. S. Firestone and R. J. Firestone, president and sales manager, respectively, of the Firestone Tire and Rubber Company; H. Harmon, of the solid tire department of the Diamond Rubber Company; G. H. Atkins, manager of the Electric Storage Battery Company, and William Neath, engineer of the same concern; W. H. Mason and E. P. Rowan, of the Hartford Rubber Works; C. E. Whitney, of the Whitney Chain Company; Courtland Cramp, of the Cramp Shipbuilding Company; L. M. Wainwright, J. W. Sprag and W. P. Culver, of the Diamond Chain Company; C. F. Van Sicklen, William Shepard, H. A. Goddard, and representatives of the daily and trade papers.

GENERAL MOTORS SEEKS SITE.

LANSING, Mich., Feb. 15.—The General Motors Company, the recently formed New Jersey corporation, is seeking a location for a plant for the manufacture of gasoline engines. C. R. Hathway, of Detroit, treasurer of the company, has just addressed a letter to the Lansing Business Men's Association, asking for proposals and information regarding taxes, lighting, power, water and other facilities, stating that the company will need about 100 acres of land.

IN AND ABOUT THE AGENCIES.

Studebaker, Baltimore.—Dixon C. Walker, one of the best-known members of the Automobile Club of Maryland, has just closed a deal for the local agency of the Studebaker electric and gasoline cars. Following this up Mr. Walker leased, late Saturday afternoon from the American Ice Company, the site at 1917-19 North Charles street.

Goodyear, Boston.—So great has been the increase in the business handled by the Boston branch of the Goodyear Tire & Rubber Company that enlarged space has been necessary. This led to the purchase of a lot and the erection of a large five-story building, which has now been occupied.

American, Hartford, Conn.—R. D. & C. O. Britton have added the American roadster to their line now comprising the Maxwell and the Stoddard-Dayton. This is the first time that the western car has been represented in this city.

Peerless, Olds and Apperson, Pasadena, Cal.—Harry D. Pyle, of the Central Garage has announced that his firm has taken the agency in Pasadena for the Peerless, Apperson and Oldsmobile lines exclusively.

Babcock Electric, Rochester, N. Y.—A new firm known as the Gable-Hill Company has taken the agency for the Babcock electric carriages. They will also carry on a general repair and jobbing business.

Gaeth and Chalfante, Baltimore.—The Gaeth and Chalfante cars are being sold in this city by F. W. Sandruck, who has been given the agencies. Mr. Sandruck is located at 915 North Howard street.

Haynes, Evansville, Ind.—The local agency for the Haynes automobile has been taken by H. R. Fullenwider, in connection with the Richmond and Auburn cars, which he is now handling.

Mitchell, Newark.—The newest Newark news note is that the newly formed Martin Automobile Company will handle the Mitchell. The DeCamp garage has been taken over and will be refitted.

Reo, Baltimore.—The local agency for the Reo car has been placed with "Little Joe" Weisenfeld, the sporting goods man of this city. The Reo salesrooms are situated on Hanover street.

Chalmers-Detroit, Houston, Tex.—A new automobile firm, Burton & Johnson, has leased quarters at 812 Farnin street, and will have the agency for the Chalmers-Detroit car.

American, Trenton, N. J.—The American Motor Car Company of Indianapolis, Ind., has appointed J. Chauncey Van Horn local agent for the American line of cars.

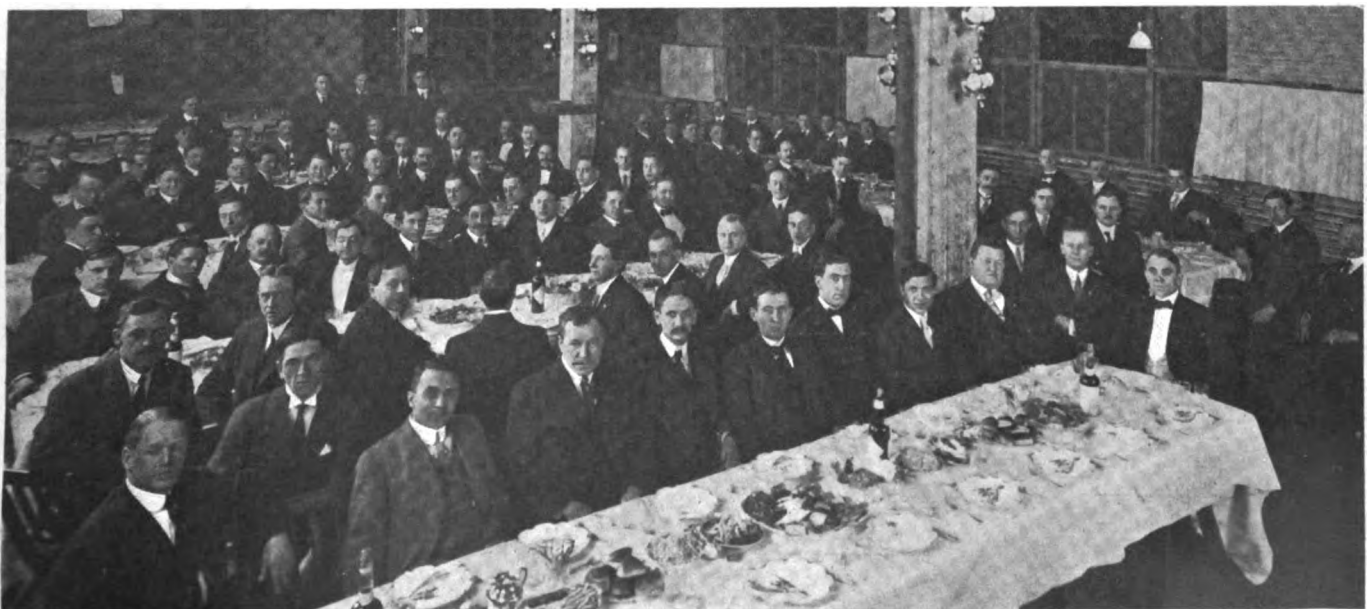

Dinner on the Top Floor of the Woods Motor Vehicle Company's Factory, to Visiting Tradesmen and Pressmen.

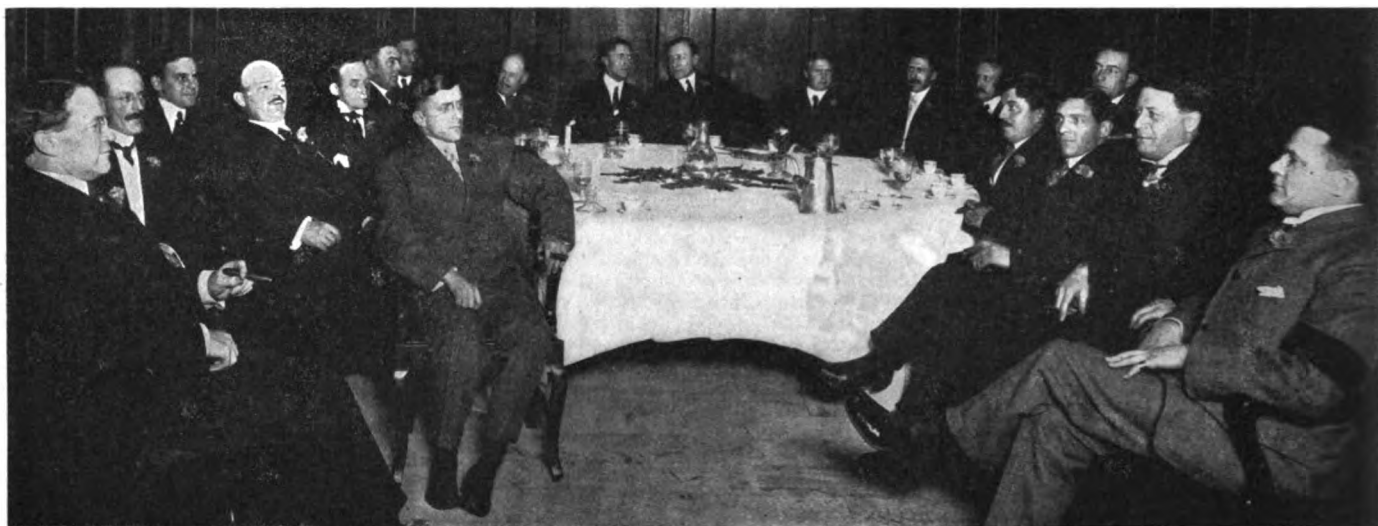

Executive and Selling Force of the Excelsior Supply Company, Enjoying Dinner at Chicago Athletic Association.

Rambler, Dallas, Tex.—The Rambler Automobile Company has established Southern headquarters in Dallas, having built a three-story building at a cost of \$75,000.

Kisselkar, Newark, N. J.—The Weldon & Bauer Company has taken the agency for the Kisselkar, which will be handled in this territory in connection with the National.

Rambler, Baltimore.—The Auto Equipment Company, Madison, near North avenue, announces that it has closed for the local agency of the Rambler car.

Maxwell and Stoddard-Dayton, Utica, N. Y.—The Oneida Square Motor Car Company has been appointed agents for the Maxwell and Stoddard-Dayton cars.

Pullman, Boston, Mass.—W. A. Shafer, proprietor of the Crown Motor Car Company, has taken the agency for the Pullman car.

Acme, Chicago.—The George L. Schofield Company has been appointed local agent for the Acme car, made in Reading, Pa.

Studebaker, Philadelphia.—E. Z. Stratton has just assumed charge of the Studebaker branch at 330 North Broad street.

Pullman, Trenton, N. J.—Harry J. Stout has taken the agency for the York, Pa., product in Trenton and vicinity.

Nadall, San Francisco.—The Phoenix Rubber Company has been appointed agent for the Nadall demountable tire.

FISK DINED ITS ARMY.

The Fisk Rubber Company gave during the Chicago show a banquet at the Auditorium Hotel to its agents and branch managers. A novel feature was a set of miniature Fisk bolted-on and removable tires constructed of candy. President H. T. Dunn presided, and the occasion was one long to be remembered.

MAXWELL-BRISCOE ENTERTAIN

The Maxwell-Briscoe Company entertained its army of agents during the Chicago show with a big banquet, which was well attended and at which Maxwell enthusiasm was rampant. Both Benjamin Briscoe and J. D. Maxwell addressed the dealers, and it was no fault of theirs if every man present did not understand the Maxwell car and the Maxwell policy before the end of the evening.

EXCELSIORS HAVE DINNER.

CHICAGO, Feb. 15.—Taking advantage of the presence at the Chicago show of the traveling representatives of the Excelsior Supply Company, F. C. Robie entertained the executive and sales forces of the company at a dinner at the Chicago Athletic Association. The local representatives were:

H. N. Kirk, sales manager of the auto-cycle department; C. C. Boynton, manager of the automobile supply department; F. B. Hart, manager advertising; H. W. Cooper, in charge of the retail selling branch, and F. W. Suter, C. H. McCormick, J. W. Grossmith, E. W. Doliver, H. H. Dewey, of the city sales force.

The traveling representatives present were: F. A. Skinner, of the Pacific Coast; Gideon Haynes, of the Rocky Mountain district; V. B. Mearns, of the "Corn Belt"; J. B. Morrow, of the "Corn Juice" districts, and Fred Wiel, Harry Svensgaard, F. Y. Horn and Jake Meyers, who between them cover the rest of the automobile world.

G. T. Briggs and N. A. Minister represented the factory sales corporation.

The dinner followed an enthusiastic meeting at which prices and policies for the coming year were discussed.



Maxwell-Briscoe Motor Company Dinner, Given at Auditorium Hotel, Chicago, to Maxwell Agents.

INFORMATION FOR AUTO USERS.

New Gilbert Specialties.—Two new specialties which will interest autoists because of their simplicity and utility are noticed in the advance catalog for 1909, just issued by the Gilbert Manufacturing Company, New Haven, Conn. One of these is the Gilbert pocket tool case, designed to fit flat in the hip pocket. The tools consist of a high-grade oxidized bicycle wrench, baby



GILBERT GAS TANK KEY AND BOTTLE OPENER.

screw driver and combination cutting pliers. The case is of neat design and made of chrome leather. The other article is a very convenient commodity—a gas tank key, with bottle opener attachment. It can be carried on a key ring, and either end is always ready for business. This specialty is furnished in malleable iron, with oxidized copper finish, or in bronze, nickel plated.

Gemmer Steering Gears.—During the coming season the Gemmer Manufacturing Company, Detroit, will produce a very largely increased number of its Model K steering gear, the details of which are shown by the accompanying illustration. This is of the worm and segment type, a ball-thrust bearing being placed above and below the worm to take all strain in the plane of its axis. The ratio is 5½ to 1, a quadruple thread, with a 2-inch lead, being employed, while the teeth of the sector are of 6 pitch. One complete turn of the hand wheel gives a throw of 65 degrees at the steering lever. Instead of being integral

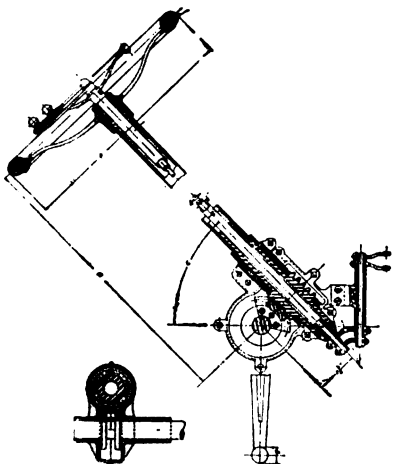

MODEL K GEMMER STEERING GEAR.

with its support, the sector is made separately. All wearing parts are hardened and ground to an accurate fit, and, as a liberal amount of bearing surface has been allowed in every case, there should be little need for adjustment. The control levers are placed on the usual stationary sector over the wheel, the rods passing through the column and terminating in small bevels, meshing with similar pinions on an upright attached to the housing of the gear. This housing is cylindrical in form, and,

as the gear is very compact, it takes very little room. The hand wheel consists of an aluminum spider carrying a mahogany rim, different diameter wheels being made to order. The Model K Gemmer steering gear has been specified on a number of well-known American cars for the coming season.

Simplicity the Keynote of Genesee Tires.—Prominent in the list of mechanical clincher tires which may be quickly removed and replaced in an emergency or otherwise is the Genesee. This tire, made by Thomas D. Buick Company, Flint, Mich., has a natural wedge lock which holds it very firmly in place when inflated. If the tire becomes deflated, on the other hand, so that this natural wedging effect would not obtain, it is still held by means of a

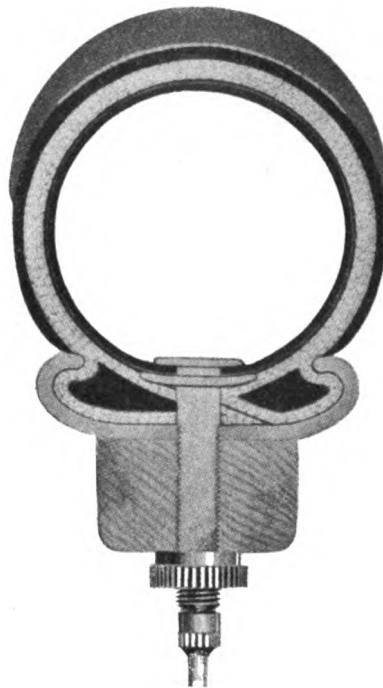

CROSS SECTION GENESEETIRE.

mechanical lock, the valve of the inner tube passing through the wedge-shaped base of the shoe in such a manner as to form a perfect lock. The portion of the latter passing through the felloe is of an enlarged diameter, threaded. A nut pulls it down tight, this being milled for the fingers or pliers to grip upon. The wedging effect, previously spoken of, is obtained by parting the base of the tire, not as usual in the middle, but along a diagonal. Then, each side of the base, with its bead, runs out to a sharp point, when viewed in cross section. In position, these diagonally-parted ends overlap one another, and the inner tube as it is inflated presses upon the upper surface of them at the point of overlapping, thus forcing them apart and jamming them tightly into place against the clincher rim.

The entire absence of lugs, bolts, or anything else of this nature making as it does for simplicity, is an excellent feature. This is augmented by the manufacturers' guarantee, which extends over 5,000 miles of service. If there was any doubt in the user's mind, the latter feature should convince. This concern manufactures other automobile accessories, among which may be mentioned Mobilene sheet packing for

packing all forms of joints, such as gear cases, crank cases, etc., and Genesee lubricating oil, Hi-Lo brand. This is a light-bodied oil for all the year use.

Joyce-Cridland Motor Truck Jack.—It comes as a sad shock to an autoist on the road to discover that no jack is at hand with which to take the weight off the car when it is necessary to do tire repairs. Or, if a jack is at hand and it is the kind which fails to satisfy, it is then

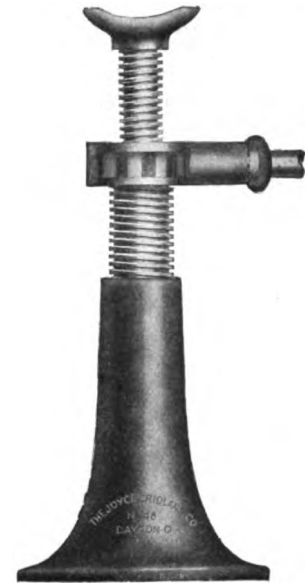

JOYCE-CRIDLAND MOTOR TRUCK JACK.

that the autoist will have to test his temper, and serve as a jack substitute. In view of the fair price at which a Joyce-Cridland can be purchased, it would seem as if the autoist who has to personally supplant an inferior jack becomes a "poor John." The Joyce-Cridland as here illustrated is a screw jack, and more, it has a high lift, and when it is all in it is short enough to stand under. Besides being a screw jack, which stands for ability, this jack is also of the quick return kind. The Joyce-Cridland jacks are made at Dayton, O., and handled in New York City by W. M. Briggs, at 136 Liberty street.

Swinging Coil for Curved Dash.—A coil made especially for use on low dashes with curved tops has been placed upon the market by W. H. Leland & Company, Worcester, Mass., the essen-

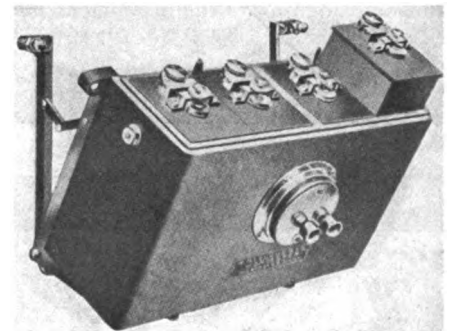

WORCESTER SWINGING SPARK COIL.

tial feature of which is its mounting. Swinging brackets are so arranged that they are not in evidence until needed, when the whole four-unit coil can be

swung forward and any units removed without disturbing the underneath wiring. On runabouts and other cars with low dashes this is valuable, while on all cars it can be used advantageously because when the coil box is pulled forward it exposes the commutator wire connections at the back. There is a concealed micrometer adjustment for varying the tension of the vibrator spring, which adjustment is independent of that of the platinum points and reduces the liability of excessive current consumption. The design of the coil is claimed to eliminate buckling and can be used in connection with magneto.

Benford's Monarch Timer.—This new timer, the product of the E. M. Benford Mfg. Co., Mt. Vernon, N. Y., is placed upon the market only after a long and severe test in actual service. It was developed by a practical, experienced mechanic, and its details and working parts are guaranteed by its makers to be absolutely correct and reliable and to be constructed of the best materials that can be found for the purpose. It is so designed that the electrical contacts, terminals and parts are not only well in-

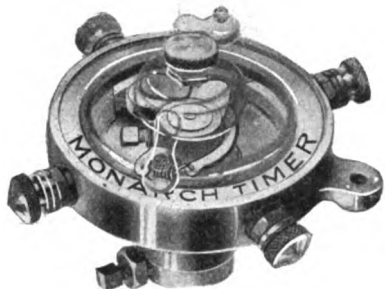

THE NEW MONARCH TIMER.

sulated, but they are sturdy. The shell is tight, sufficiently to assure that grease will stay in and dirt will not get in. The timing is precise because the means afforded are of a character to assure the very precision which is necessary to a motor of a plurality of cylinders.

Connecticut Pocket Meter for 1909.—The Connecticut Telephone and Electric Co., Inc., of Meriden, Conn., has just placed on the market its new type 1909 dead-beat meter for testing batteries. These instruments have many improvements of note over the 1908 style. A new etched metal dial now replaces the paper card dial which is universally used for this purpose, and this dial is not only a handsome addition to the instrument, but adds greatly to its accuracy, also doing

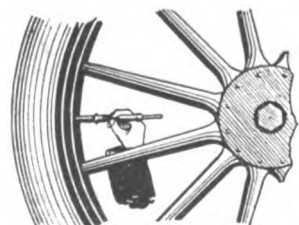

TWITCHELL TIRE GAUGE, OPEN, SHUT, AND APPLIED.

away with the common trouble of warping and bulging out, which causes the pointer to stick in taking a reading. The entire interior construction has been changed and is now made up on the deadbeat principle. A new type of pointer construction has also been added. The Connecticut Company is making a great many different styles of pocket battery



CONNECTICUT DEAD-BEAT METER.

meters. The volt ammeter is really two instruments in one, the voltage side being used for testing storage batteries, each cell of which should be tested individually, and should show 2.5 volts after the battery is fully charged and still charging. If they show less than 1.7 volts they should be recharged. A storage battery on open circuit when fully charged should show between 2 and 2.2 volts. The ampere side is used for testing the condition of dry batteries, each cell of which should be tested separately, and if any cell shows less than 6 amperes it should be replaced with a new one. This new type of instrument is a worthy addition to the already large line of high-grade Connecticut products.

Twitchell Tire Gauge.—A tire gauge, which is only three and a half inches long, can be carried in the vest pocket and applied at any time, will be a welcome innovation to many automobilists who have been suffering from tire trouble due to insufficient inflation. This description applies to the Twitchell gauge, the invention of C. R. Twitchell, of Los Angeles, Cal., and perfected and controlled by the W. D. Newerf Company, of the same city. The gauge is designed

to screw on the valve of the tire, after the cap has been removed; this automatically presses back the plunger of the valve. The air pressure is then indicated on a graduated scale which slides out through the other end of the gauge. Ordinarily the automobile user guesses at his tire pressure, and almost invariably the pressure is too low. His tires, time and patience, also his pocketbook, suffer accordingly. The illustration shows the Twitchell gauge closed, extended and applied to a tire. It can be applied in two seconds and the registration is instantaneous, and guaranteed by the makers to be correct. The W. D. New-

erf Rubber Company is arranging to put the Twitchell gauge on the market all over the country from coast to coast.

Many Styles of Caloris Bottles.—The great demand for the Caloris bottles which will keep liquids cold in the hottest weather, or hot in the coldest days, without the use of heat or fire, has become so large that the Caloris Manufacturing Company, of Philadelphia, is now putting upon the market several styles of bottles. In addition to those covered with metal and those covered by wicker, a new type of leather covered bottles is being sold known as the "Sterilo" Caloris bottle. This one is arranged so that the glass bottle can be taken from its case and be sterilized, a feature which is very important when used in connection with sickness. Inasmuch as the case is well padded, however, it is also useful where handled very roughly.



CALORIS BOTTLES AND CASE.

There has been perhaps no invention in recent years which has proven such a boon to tourists and others who are out of doors very much or are away from places where hot or cold refreshments may be obtained. Motoring is one of these enjoyments where such is the case, and it is rather seldom now that a party goes upon a long tour without a Caloris equipment. In leather cases two or more bottles can be carried at the same time with as many different liquids. In the new metal covered bottles the bottom is detachable, so that it, too, can be easily taken apart for cleaning, while a spring bowl and leather cushion protect the glass from possible breakage.

Lincoln Folding Wind Shield.—The Bi-Motor Equipment Company, 177 Portland street, Boston, has brought out an attractive line of wind shields under this name. They are made of French

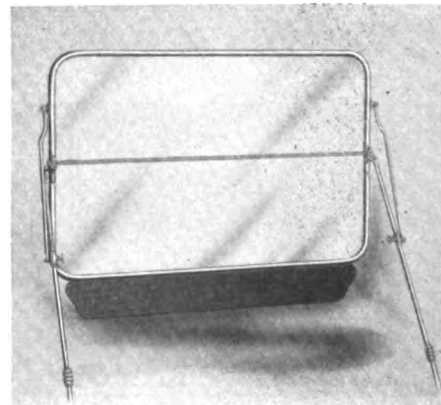

LINCOLN FOLDING WIND SHIELD.

plate glass, set in polished brass tubing, with mahogany baseboards. The folding device is claimed to be "so simple that a child can operate it." The shield is guaranteed in every particular, and will fit any make of car. The same company also makes, at a slightly higher price, the "Portland" divided drop shield.

THE AUTOMOBILE



MANY an automobile tourist begins his Italian round at Naples, after having debarked his automobile at that port. A bee-line north covers the best and most characteristic Italian itinerary, and a detour here and there, as from Naples to Amalfi, from Rome to Subiaco, from Florence to Vallambrossa, and from Padua to Mestre, for Venice, gives quite all the variety that the hurried traveler usually has time for. It is not knowing Italy down to the ground, but one finishes the round with a nodding acquaintance with many things he hitherto knew not of. This is particularly true if the journey is completed—so far as Italy is concerned—by the crossing of the region of the Italian lakes and entering Switzerland over the Simplon, or France by Mont Cenis or the Petit Saint Bernard.

The detour from Naples south to Sorrento, Amalfi and Salerno, via Torre del Greco and Castellamare, is over about the only deservedly good road in south Italy, and even it is sadly cut up, dusty and stony, depending largely upon the season of the year as to its goodness or badness. A hundred and fifty kilometers out and back covers the distance, and the itinerary embraces the most romantic and historic succession of kilometers in all Italy.

Herculaneum, Pompeii, Sorrento, a boat ride to Capri, and then Amalfi and Salerno can all be done in a day by the owner of a swift automobile—that is, provided he does not want to spend a week or a month on the same trip. Lunch may best be taken en route where fancy wills, Pompeii will be too early and Amalfi too late; Sorrento will, perhaps, be the most likely place to take refreshment, say the Hotel Vittorio.

The road from Naples north to Rome

follows the old Appian Way from Capua to the Eternal City. Straight through the Campagna runs the old Roman highway, due in the first instance to the genius and energy of Appius Claudius. It is not a "good road," as we who know the "good roads" of France will recognize, but it is direct and fairly flat for the whole 227 kilometers of its length, though not by any means does it pass through the most idyllic and attractive part of the Italian countryside.

Caserta and its Palazzo Reale, Capua with its memories of its fall to Hannibal, Cassino with its Monte, its Rocca and its Amphitheater, and Valmontone and Ceprano are the chief places of interest en route until one comes up with the Alban Hills and suburban Rome itself. There are two alternatives to the direct road from Naples to Rome. One follows the coast line as near as may be, a poor, mean road, but interesting because of the unexploited little towns through which it passes; the other branches off from the Appian Way at Frosinone, eighty kilometers before Rome is reached, and enters the capital via Subiaco and Tivoli.

To any one with a liking for the unconventional, the latter road especially is recommended. We did it, and were the happier for it, though we had never heard of any other automobilist who had made the detour, perhaps thirty kilometers more than by the direct road. This is the charm of Italy—to get away from the beaten track and the crowds of convention and every day humdrum.

The road from Frosinone to Subiaco rises from 180 meters to 958 meters in twenty kilometers, but the average of the grade is slight. From Frosinone to Rome the direct road runs at a normal



Bologna's Picturesque Skyscraper.

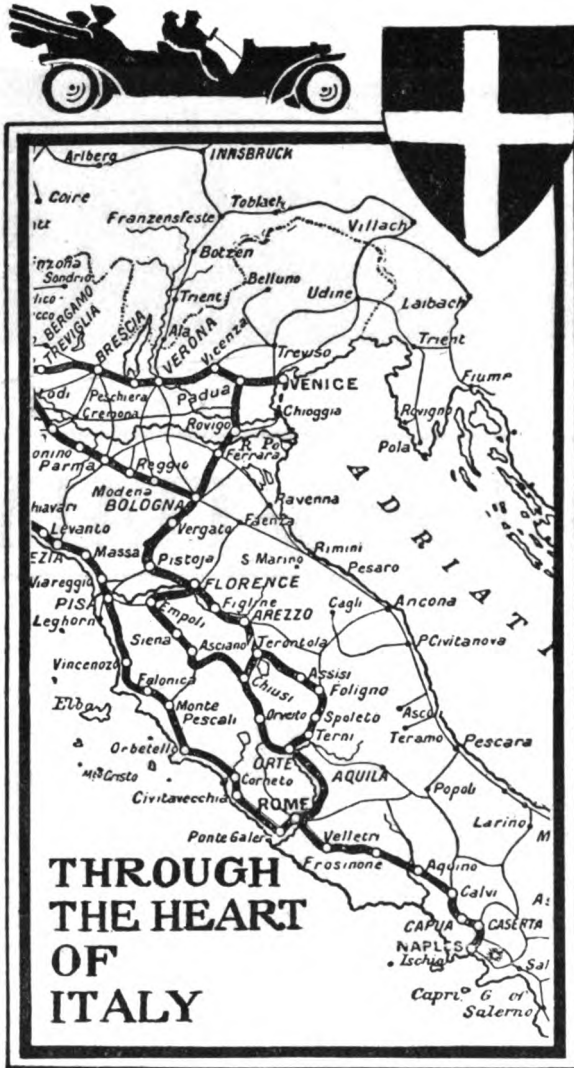

stones which draw trade to the padrone's *tavola rotunda*. Some day, perhaps, art nouveau ideas will take root and branch under this modest roof tree, and then your arrival will be telegraphed to the journals of Rome and Paris as "en passage à la Pernice"—and then prices will go still higher—and then the partridge might as well be killed; it will die an early death soon after.

From Subiaco to Rome via Tivoli is an easy afternoon run. Rome is all things to all men and women, but it is nothing much for the automobilist, save for an excursion out on the Campagna, past the Circus, the Tombs and the ruins of the Aqueduct. Beyond this there is little for your chauffeur to occupy himself with while you are doing the guide book round save to hang around the nearest café and drink "*paleale*" and "*wheesky*" with others of his kind. All drink-purveying establishments in the stranger's Rome sell these liquids, though of dubious brands and invariably at outrageous prices. A chauffeur is a nuisance anyway; he is doubly so at Rome. The only thing he can interpret is the bill of fare; you have to count up his washing for him when it comes home from the laundry, and like as not he will make you pay for the pieces that have been lost. After Rome, a day, a week or a lifetime, you take the road again, north across Etruria via the *Viae Aurelia*.

The choice of roads from Rome to Florence is bewildering. You may go by Terni, Spoleto and Perugia, or by Viterbo, Orvieto and Siena, or by half a dozen other routes, each appealing in its own special way. You may not do all of them, though, without quadrupling the time necessary for one, more,

elevation of 250 meters. At Subiaco is a country inn which must be a near relative, in point of age, with the castle on the height above its rooftop. It is called "La Pernice"—"The Partridge"—and is typical of its class throughout central Italy, though in no sense an up-to-date tourist establishment, but much better than anything of a similar order in England or America. We have to come to these effete lands like Italy and France and Spain for some things; how to cook a chicken and make a salad, for instance.

The proprietor and the cook at Subiaco's "La Pernice" have learned their business and practice it well. The marvel is that they were able to learn anything in such a dull place as this little hill-town of mid-Italy. Four or five francs a day buys the best the inn has. What could one want more? It is said the Subiaco's inns used to have a flat rate of two and a half francs a day all in, but that happy time has passed. In the trail of the artist folk who originally exploited Subiaco now come occasional tourists by rail and road, and again by automobile, in twos, sixes and dozens in a day. And prices are soaring upwards—for the automobilist, at any rate; if you are an artist, the magic of your white umbrella gains you a very substantial discount off regular charges. Even the Italian landlord has an eye for business, if he has no business system. He is no robber, though; he leaves that to his smiling servants, with their everlasting itching palm which calls loudly *buona mano* whenever one is in sight.

All the attractions of "La Pernice" are on the table; the table itself, the chairs and even the crockery would hardly pass muster on an emigrant ship.

The art gallery of "La Pernice," the sketches left behind by several generations of artists, is a thing to see and marvel at. The works of art are beyond price; indeed, they are the lode-

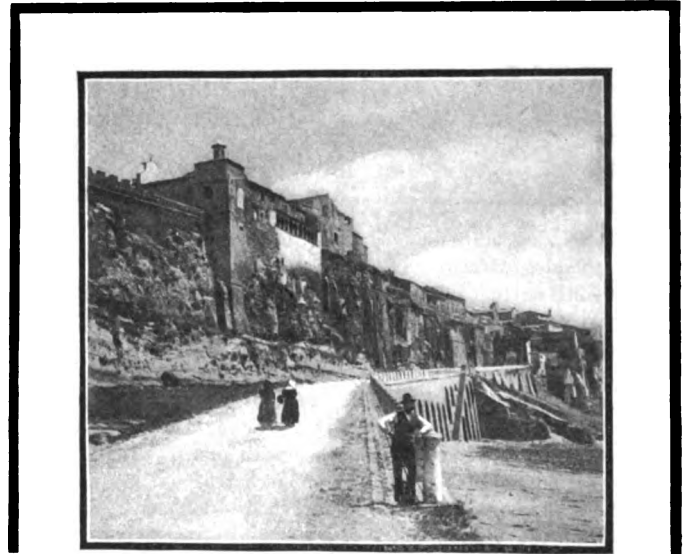

ORVIETO—LA PORETTA

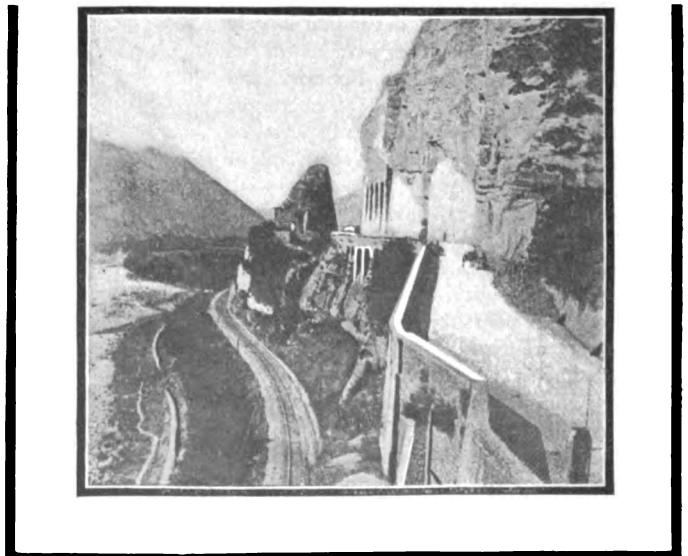

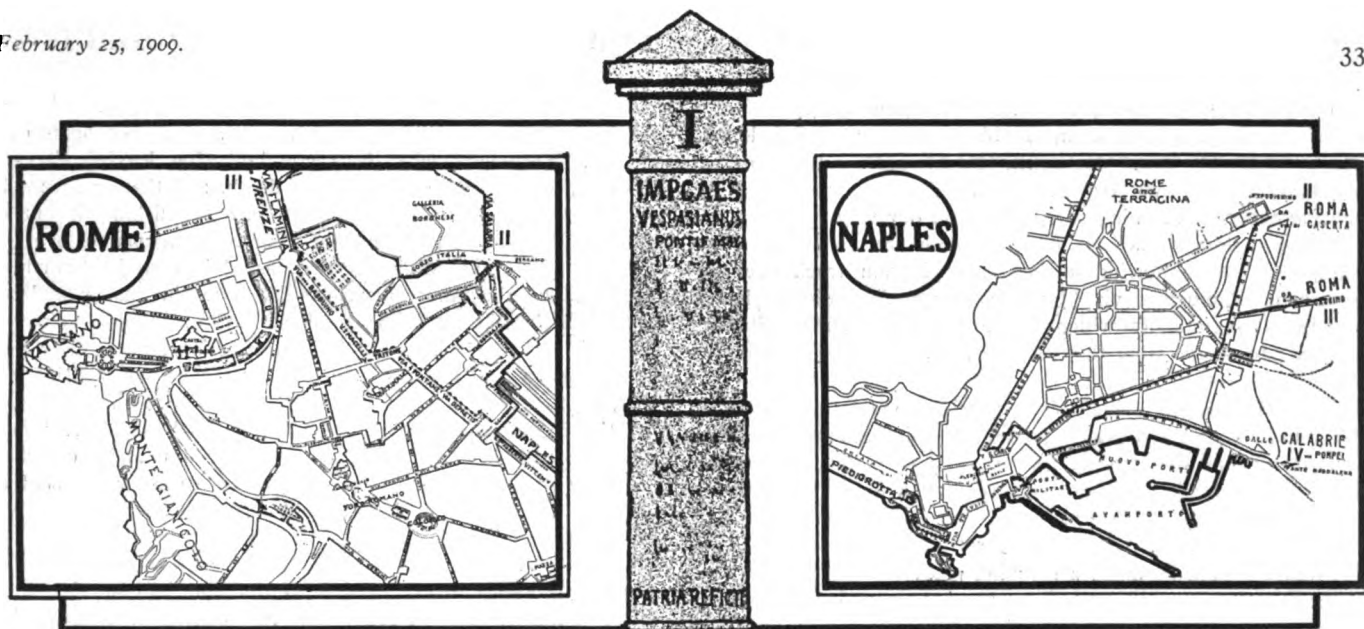

Rome's Golden Milestone.

perhaps, than you have at your disposal. This is said advisedly, considering the average person's proclivities and desires for getting on. The fault of the automobile as a touring proposition is that its capabilities are so great that it has got us all hypnotized into doing a hundred, two hundred, five hundred kilometers in a day, when we should be better off by far if we did half that, or even less.

Three days in Italy, from Naples to Como, and then Switzerland, has been too often the itinerary of the hurried traveler. Naples-Rome and Rome-Florence, then, are bound to be covered at full speed and on a bee-line. What matters it that San Gimignano and its towers lie but a dozen kilometers off the main road from Siena to Florence? One lunched at Rome; he must dine at Florence, and only stop at Siena because of the need of filling his tanks with benzina.

Three hundred kilometers between Rome and Florence have been done before now between meals. One had much better make two days of it and, above all, stop at Viterbo, Orvieto, Siena, San Gimignano and Volterra. The hills will pull your speed down some, anyway. The country north from Rome is not as flat as was the Campagna. There is one bit, at Radicofani, between Siena and Viterbo, that rises four hundred and fifty meters in nine kilometers, and another just below Viterbo which takes a flight of five hundred meters in air in ten kilometers.

If one comes north via Perugia he will remember that city as well for its hotel as for its "sights." The chief rest house for travelers at Perugia is the Grand Palace Hotel. Its name lately anglicized. It has been considerably improved, doubtless, since the seventies of the last century, when a traveler wrote that in spite of the fact that it had one day sheltered sovereigns, popes, cardinals and princes, it was an unlovely and incapable establishment indeed. Now it is truly enough an up-to-date hotel—as nearly up to date as an Italian hotel can be in a city of twenty thousand inhabitants. It has a garage, the pleasing custom of serving *vin comptis* at table d'hote (this even if you be an inexperienced traveler in Italy) and of further allowing you a discount of ten per cent. for having bestowed your patronage upon it, though for this you have to give proof of your adherence to either the French or Italian Touring Clubs.

So much, then, for the changes which are coming to pass in Italy. They were needed, doubtless, but come they have, and are still coming. The automobile has done it.

Florence, in good weather, is easy getting in and out of; in bad weather it's a slough. The shady groves of Vallambrossa are at its doors and Fiesole nearer still. Each is a classic excursion to be made while at Florence. Hotels at Florence are of the tourist kind and unappealing from most, if not all, points of view. There is a whole battery of them along the

Lung' Arno, and they are all as like as peas in their mediocrity—canned peas. The best thing of its kind in Florence in the hotel line is the Hotel Porta Rossa, in the very center of the city, just back of the Strozzi Palace. It is a sleepy, rambling, dingy old hotel, but not unclean, and the food is remarkably good, though remarkably Italian. This is one of the things that one comes to Italy for, or ought to be. You lodge your automobile in the stable with the railway bus and its equines for a franc a night. The other hotels chiefly haven't garages, and that of the F.I.A.T. concern is a mile away from the center of things.

To Bologna via La Futa Pass is 102 kilometers. The road lies through the heart of Tuscany, and is accordingly lovely, but considerably less so than that via Prato, Pistoja and the Pass of La Poretta. The latter lengthens the route by twenty odd kilometers, but is the easier, as fifty kilometers of the direct road run up hill.

All through this region one eats and drinks of the best of country fare, with nothing imitative of England, France or Germany, as in the cities and big towns. If a simple lunch of bread and cheese and salad and good Chianti is wanted, any wayside *osteria* will give you as good as any palace hotel in existence, no matter what may be the difference in price. One perforce, too, has to be content with this occasionally in Italy, if unforeseen circumstances keep him longer en route than he anticipated once and again.

On one occasion we were in just that position, and spent eighteen hours at Barberino di Mugello and fared well indeed at the Scudi di Francia, though the village is not marked on many maps and in no guide books we had ever seen. We just



happened there by chance, and stopped long enough to lift off a cylinder and put it back again—nothing serious, though it looked bad at first. The local blacksmith lent his aid for the best part of six hours for two francs, and the drug store supplied the *benzina* the next morning to speed us on our way.

Bologna was reached at dusk through the frowning Porta Saragossa, and following a long line of tram track over interminable kilometers via "Greater Bologna." Bologna has a couple of skyscrapers which would put New York's Flatiron Building to shame were they side by side. The photograph tells the story.

From Bologna to Ferrara is forty-six kilometers of straight, flat, uninteresting roadway. In sunlight its esthetic qualities improve, but all the same to Ferrara, and to Padua, seventy-five kilometers beyond, it is hardly more than a dyke road running between swamps and morasses, a land half aquatic and half terrestrial, wrenched from the very sea itself ages ago.

Ferrara should be made a stopping place for the sake of contemplating its old castello, where the beauty and gayety-loving court of the d'Estes dominated the whole esthetic life of Italy in Renaissance days. You can take the opportunity, too, of lunching at the Albergo Europa, which is very, very good indeed—and they will make no distinction as to price or fare whether you come on foot or in a "Sixty," say half a dollar, *vino compreso*.

If you *will* rush things, and won't stop at Ferrara, you may skip it by passing the Strada di Circonvallazione, joining up with the Padua road on the other side of the city. You are grateful for this, knowing that you have avoided the busy traffic of the center and the possibility of losing an hour.

Almost immediately after Ferrara, perhaps three kilometers beyond, you come to the little town of Portelagascoro and plunge precipitately, almost before you realize it, into the midst of a great market house or *loggia* of some sort. You inquire for the Strada di Padova, and they tell you that this is it. You keep on through this gloomy tunnel of a street for a hundred meters or more, when suddenly the sharpest right-angled turn you ever met with is directly before you. It descends like the side of a house, a slimy, muddy, ill-kept back alley of a road—really

the Strada di grande Comunicazione of these parts. It now takes an even stiffer plunge and crosses a bridge of boats over the Po. Keep your wits about you just after leaving Ferrara, or you will meet with an untimely death, and there will not be enough left of your automobile to pay for fishing it out of the river and ship back home for your heirs to quarrel over.

Rovigo, Este and Monselice are passed in turn just north of Ferrara, and the landscape aspect improves in quality and appeal, though still all is flat and miasmatic. Padua is lovely from all points of view, and the entrance is monumentally fine. The Albergo Stella d'Oro has all needful accommodation for men, women and automobiles. One eats well in the *ristorante*, but the Italian officer at the next table eats better. He knows what to order and you don't. He gets the best and most characteristic fare and you get poor imitations of the roast beef of old England and a thin watery soup when what you wanted was spaghetti, ravioli and a coteletto di vitello.

It is 38 kilometers to Venice, or rather Mestre, a place of 10,000 inhabitants, great railway affairs and innumerable automobile garages. Of the latter the Auto-Garage Internazionale is perhaps the best. You may not approach Venice in your automobile nearer than Mestre. From there you may take the train over the stone arches of the six-kilometer bridge, or better still, hire a gondola for a dollar at the very door of your garage and make your entry to the City of the Lagoons in that fashion.

From Mestre to Vienna one's road lies via Udine, Pontebba-Villach and the Semmering Pass, between 500 and 600 kilometers. To Innsbruck via Cadore-Tolbac and the Brenner Pass it is about 300 kilometers. Westward through the Italian Lakes and to Switzerland via the Simplon or the Saint Gotthard is approximately 500 kilometers and to France via Susa and the Petit Saint Bernard or via Susa and Mont Cenis, say, 600 kilometers.

A QUICK ROUND SOUTH FROM NAPLES.

Naples—Portici.....	4.8	Kilometers
Resina—Herculaneum.....	6.3	"
Torre del Greco.....	9.4	"
Torre Anunziata.....	16.6	"
Castellamare.....	24.5	"
Sorrento.....	42.9	"
Meta—Positano.....	59.8	"
Amalfi.....	70.1	"
Salerno.....	94.7	"
Naples.....	144.6	"

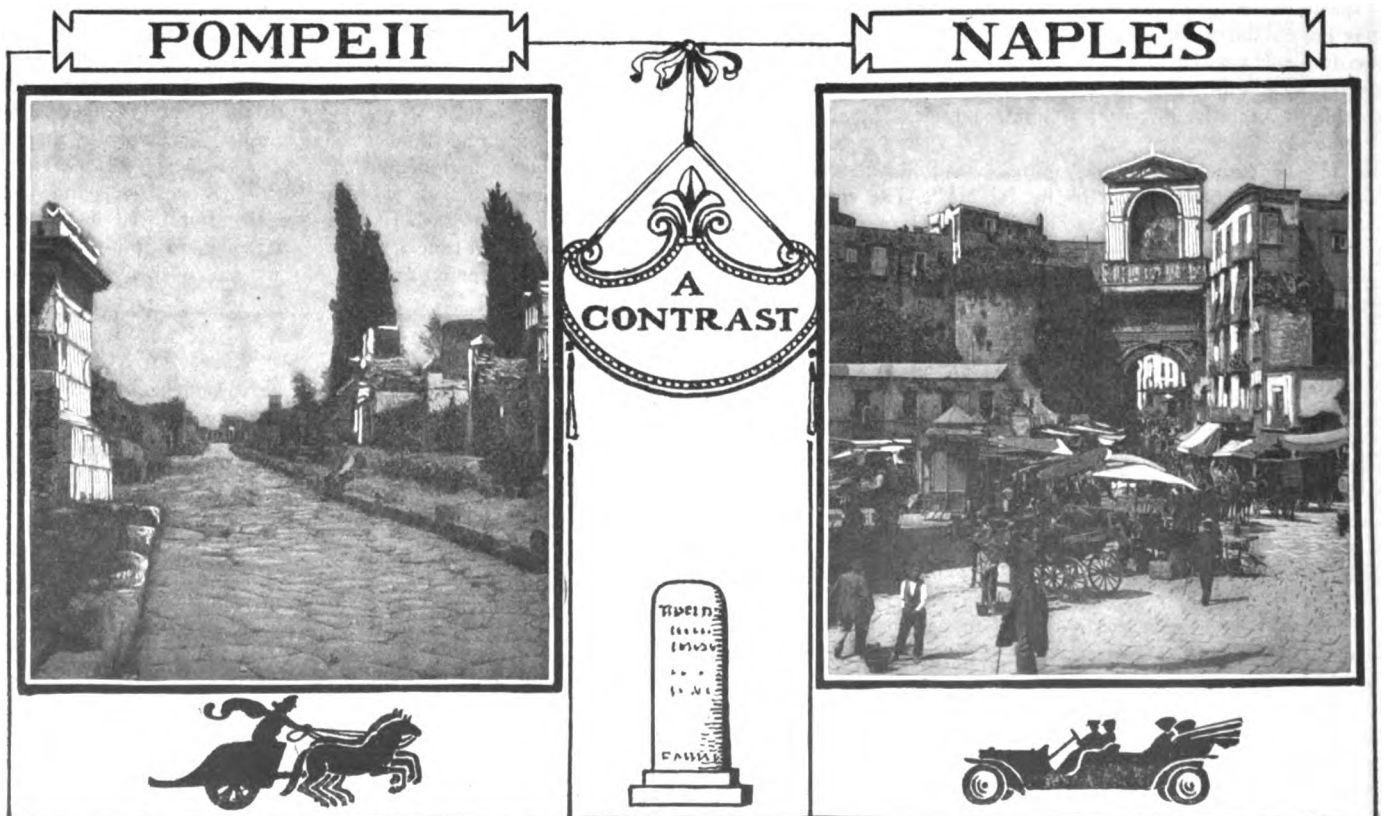

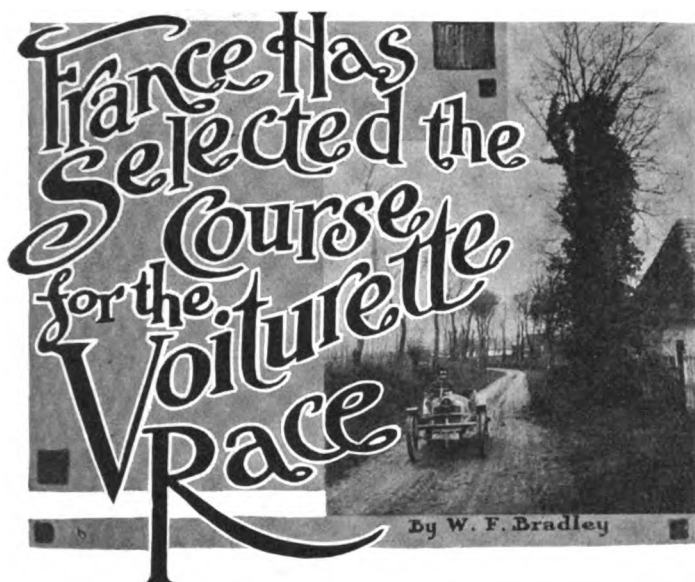

PARIS, Feb. 20.—Boulogne-sur-Mer has been fixed upon as the scene of the French voiturette race, the only pure-speed contest to be held in France this year. A triangular course, bearing a very strong resemblance to that of Dieppe, but only measuring 25 miles round, has been selected on account of its varied nature, comprising excellent straightaways and grades that the little cars will not be able to rush. Starting from the outskirts of the town, high up on the cliffs overlooking the sea, the cars will run first of all over an undulating national road of excellent surface and having a straightaway of nearly seven miles, where the highest possible speeds can be attained. At the end of the first triangle the cars will have to make a sharp turn through the village of Alincthun, the run to Desvres being over a very winding road. At Desvres a sharp turn to the right, followed by an easier one to the left, then an abrupt grade of 12 to 13 per cent., that will call for the use of a low gear and all the power that the engine can develop. From Desvres to Baincthun there is a succession of switchbacks of a very accentuated nature, all of which can be tackled without great difficulty by reason of the great impetus gained on the descent. Three miles before the Boulogne corner of the course there is a mile hill with a grade of 9 per cent. that will severely test the cars, for, owing to a turn at the bottom, it will be necessary to climb it from a standing start.

The race, which will be run on Sunday, June 20, promises to have about 60 starters, among them being a greater proportion of foreigners than ever before.

France will be represented by Sizaire-Naudin, Delage, Peugeot, Alcyon and other less known makes.

England, which has never before taken part in a voiturette race, has promised to send over a formidable group, comprising Humber, Vulcan, Adams, Star, B.S.A. and N.S.U.

Austria will put in three Laurin-Klement cars.

Germany will send three Adler and three N.A.I.

Switzerland will provide a Martini team.

Italy will bring forth three of Lancia's small cars and a team of Isotta-Fraschinis.

There is every probability of America being represented in the race.

National colors are: America, white body, red chassis; France, blue; German, white; England, red; Italy, green; Belgium, yellow; Switzerland, yellow body, blue chassis.

The modification in the rules regarding cylinder area is doubtless responsible for the increased foreign entries. Formerly bore was limited and stroke left unfettered. This produced an exceptionally long stroke engine, last year's single-cylinder winner having a bore of 3.9 inches and a stroke of 9 4/5 inches. It is now considered that the efficiency of a long stroke engine has been fully demonstrated, no technician being found to maintain that engines of equal bore, but varying in stroke, are of the same

power. Thus, though the long stroke is still encouraged, bore is not rigorously limited.

For a single-cylinder engine it is permitted to increase the bore above 100 millimeters (3.94 inches) to a maximum of 120 (4.72 inches) on condition that the stroke is decreased in proportion. Starting from 100 by 250 (3.94 by 9.84) bore and stroke, the former may be increased to 120 (4.72) on condition that the latter is decreased to 120 millimeters, the stroke being stipulated for each millimeter bore from 100 to 120. The same applies to multiple cylinder engines.

FRANCE HAS 43,550 AUTOS IN USE.

PARIS, Feb. 20.—France possesses a total of 43,550 automobiles in active service. The number seems small compared with the 83,000 claimed to exist in England, but from this latter figure a considerable deduction should be made for double declaration owing to change of ownership. The French figures are obtained from the annual declarations of owners for taxation purposes. Cars in course of manufacture, in stock ready for sale, out of service through old age or accident, are naturally not declared by their respective owners, for declaration means taxation. Thus the French figures, taken on February 1, 1909, apply only to cars on the road or ready to be put on the road, and totally exclude double declarations.

Paris is responsible for 7,400 automobiles, and in this respect is a long way ahead of any other city in France. The rest of the Department of the Seine claims 1,950 automobiles, and is followed by the Rhone district, comprising the manufacturing city of Lyons, with 1,765 autos. Other districts having more than a thousand automobiles are Alpes Maritimes, Bouches du Rhone, North, Rhone and Seine et Oise. Corsica is at the end of the list with only 10 automobiles. Motorcycles are not included.

FRANCE TO TEST SMALL COMMERCIAL CARS.

PARIS, Feb. 18.—Small commercial vehicles will be put to the test over the rough roads in the neighborhood of Paris from April 22 to 30. The test, which is a repetition of the one held last October, is provided for the lighter type of delivery automobiles, taxicabs, hotel and station omnibuses and motorcycles with a luggage carrying capacity. The distinctive feature of the trial is the use of various fuels, comprising gasoline, White Spirit, carbureted alcohol and benzol. As the same course is followed on each of the eight days devoted to running, it will be possible to make close comparisons between the relative cost and efficiency of the different fuels, as well as comparisons between the vehicles using them. Regularity of running is essential to qualify, but the basis of classification will be economy in fuel and lubricating oil. The total distance to be covered is about 100 miles a day.

All the patents, models and manufacturing rights of the Voisin aeroplanes at Paris-Billancourt have been acquired by August Euler, of Frankfort-on-the-Main, who will erect a factory on a very large scale in that city.

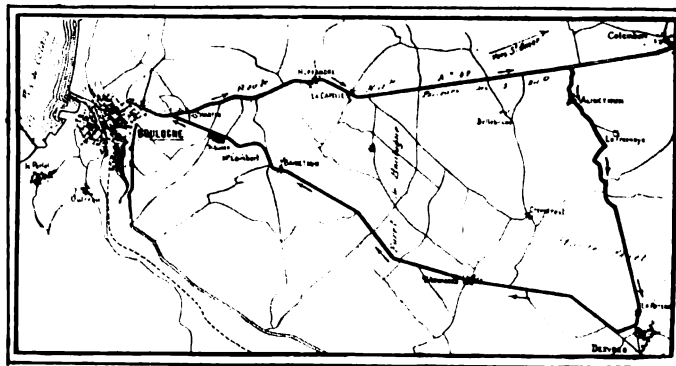

Map of Course Selected for French Voiturette Race.

Motoring Afloat Continues to Develop



PAU, FRANCE, Feb. 20.—The work of training pupils to handle the Wright aeroplane has begun on the Long Pont aerodrome, on the outskirts of the city. Wilbur Wright, in accordance with his usual custom, first flew over the ground alone at a very low altitude, made a further flight at an increased height, then took his pupil, Paul Tissandier, for a short skimming trip. The contract calls for three pilots trained to handle the machine perfectly, the three men chosen being Paul Tissandier, Comte de Lambert, and Ernest Zens. There are a number of others, however, who have given orders for Wright machines and are anxious to be trained by the American pilot.

Wright declares that the ground at Pau is perfection. Even at this time of the year there is very little wind, and with an open plain extending for nearly thirty miles, it should be possible to make some record flights. Wilbur Wright, however, is more anxious to finish his work in France than to make further experiments, and it is doubtful if he will for the present attempt more than the training of his pupils. It is now absolutely certain that Wilbur Wright will not attempt to win the Monaco prize of \$15,000, though two of his machines may be entered for the event before the end of March. M. Michel Clémenceau, the selling agent of the French syndicate formed to exploit the Wright patents in France, states that he will have two machines ready in time, and that Comte de Lambert will pilot one, and that he will steer the other himself. It remains to be seen whether two men who have never yet driven an aeroplane can become sufficiently expert in one month to make the flight across the four miles of water as required by the Monaco rules. If this can be done it will be a distinct triumph for the Wright system, for it will prove that the superiority is in the machine, and not in a specially skilled pilot.

Fournier's Début in Aeronautics.

PARIS, Feb. 20.—Henry Fournier, ex-racing cyclist, motor-cyclist, and automobile-race driver, with the winning of Paris-Bordeaux and Paris-Berlin among his records, has now joined the ranks of the aeronauts. Flying machine "Henry Fournier No. 1" has just received its last coat of varnish and is waiting for its power plant at the Voisin Frères factory, near Paris. It is a biplane type of machine, in all essentials similar to the one handled by Henry Farman and Delagrangé last year. Fournier, who is looking after the power plant himself, intends to fit a four-cylinder Itala motor developing not less than 50 horsepower, and only differing from those used on cars by a little paring away of unnecessary metal. It is his opinion that better results can be obtained by a reliable and comparatively heavy type of engine than by a featherweight mechanism only fit for short spells of power producing.

Henry Fournier has just left Paris for Turin, to be present at the final test on the bench of his aeronautical engine. If this is satisfactory it will be fitted to the aeroplane at once and trial flights made within a few days. If everything works satisfactorily, Fournier intends to compete for the Monaco prize, the last date for which is March 24. Should, however, his apprenticeship in the flying school not be completed by this time, it is his intention to fit himself and the machine for all the most important flying-machine races to be held in Europe this year, including the Gordon Bennett race, the Aero Club Grand Prix, and the Rheims carnival.

Unlike the Farman aeroplane, the Fournier flyer will not have its propeller mounted direct on the engine shaft, but will make use of a reducing gear, which will give a propeller speed of

about 1,000 revolutions a minute. The weight of the motor, complete with oil, water and all accessories, will not be less than 440 pounds. Fournier himself is decidedly a heavyweight compared with Farman, Wright, Delagrangé, and Santos-Dumont, and now turns the scale at 207 pounds. Thus when the biplane leaves the ground it will doubtless have the record of weight lifting. Fournier is convinced that his own weight and that of his engine will not hinder him from making long flights.

Farman to Build for Himself.

PARIS, Feb. 20.—After flying for nearly two years with machines of other men's construction, Henry Farman has decided to build for himself, and according to his own ideas. Two aeroplanes are now on the stocks, one of them being a biplane in which the principal modification is an increase of the distance between the bearing surfaces from 58 to 78 inches, with a view to obtaining greater sustaining power. The front elevation plane will be thrown out a little further than usual, and will be made larger in order to give more power. Winglets may be fitted, and the rear planes may be built with flexing tips. If this is done, the rear rudder will be abolished. The second aeroplane will be of an entirely different type, the forward equalizer being abolished, and the wing tips made flexible as in the Wright machine. The rear bearing surfaces will be cellular, as on the present machine, but will have a variable inclination at the will of the operator. Farman has completed arrangements for a number of these machines.

Rheims to Have Aeroplane Meet.

PARIS, Feb. 20.—Rheims, the old cathedral city in the East, has become enthusiastic over the aeroplane, since Henry Farman fluttered down on its outskirts, and now announces an aeronautical week for the last days of August, or the opening days of September. The old city, in addition to its famed cathedral and champagne cellars, possesses vast plains all around it, the extent of which can be gathered from the fact that in 1901 a review of 150,000 troops was held before the Czar of Russia and masses of spectators. It is on this land, known as the Bethany plain, that it is intended to hold the aeroplane races with a minimum prize list of \$30,000.

There will be separate classes for big-bearing surface, slow-speed flyers of the multiplane-plan type, and for high-speed monoplanes, each type being tested for speed and endurance, for high flying, and for performances with passengers on board. The local committee responsible for the raising of funds to hold the races, has secured the co-operation of the Mixed Aerial Commission—a body composed of members of the Aero and Automobile Clubs of France and of the National Aerial League—and will doubtless produce really competitive events. The races will be within the reach of all the leading aeroplanists, the committee being more anxious to obtain twenty machines, each capable of flying ten miles, than a single aeroplane with an ability to cover 100 miles. Thus unlike some of the aeroplane "races" projected in France, and which are in reality disguised publicity schemes, there should be real sport at Rheims.

By the end of August at least twenty Wright machines should be in the hands of capable pilots; thus although the American pilot himself may not be there, an opportunity will be afforded of matching this type of machine against the best that France can produce. This alone should be sufficient to draw enormous crowds of spectators. The nature of the ground will allow a course about eight miles.

TREND IN TRANSMISSION PRACTICE

By Thos. J. Fay

Chapter IV

IN automobile work diametral pitch of teeth, as used, ranges between 4 and 10, as 4, 6, 8 and 10; it is not usual to adapt the odd numbers as 5, 7 and 9, although 5 pitch is used to some extent. Above 8 pitch, it is rarely that the teeth are used, excepting in planetary gearsets, when 8 pitch abounds to quite some extent. In sliding-gear sets 6 pitch is the most used, and that this is a good selection is assured, on the ground that the strength is adequate for the purpose, and the teeth do not make a noise excepting in the cases in which the pitch-line velocity in feet per minute is above 1000.

Relation of Diametral to Circular Pitch.

Diametral Pitch.	Circular Pitch.
4.....	785
6.....	524
8.....	393
10.....	314

For other concrete dimensions the formula is as follows:

$$(1) \text{ Circular pitch} = \frac{\pi \times \text{pitch diameter}}{\text{number of teeth}} = \frac{\pi}{\text{diametral pitch}}$$

$$(2) \text{ Diametral pitch} = \frac{\text{number of teeth}}{\text{pitch diameter}} = \frac{\pi}{\text{circular pitch}}$$

$$(3) \text{ Pitch diameter} = \frac{\text{number of teeth}}{\text{diametral pitch}}$$

If internal gears are to be used, it will be well to remember that "doctoring" will be avoided if the pinion has less teeth than the internal gear by at least twelve. In all gear work it is much to the point to avoid undercutting, which is a matter of using enough teeth in the pinion. As a general rule it is not considered good practice to use less than 14 teeth in the low-gear pinion of a transmission gear set. There is one other point which will save the embryo designer sleepless nights, i. e., in planetary work, if there is a sun and planet in one radial plane, all gears must have an even number of teeth.

In the selection of gears, which becomes a necessity, in order to establish a suitable ratio between the motor and the road wheels, it is generally possible to fix upon such a number of teeth as to avoid fractional dimensions of the pitch diameter. This is not a grave necessity, yet even so it is just as well to have even relations, in possible cases.

As to the width of teeth, little can be said by way of establishing a standard. All the attempts at fixing upon the width (face of gear) has led to nothing thus far, largely because the practice has failed to demonstrate that "rock-bottom" has been reached, either as respects the quality of material or the life in service, under well-defined conditions. In some cases gears have been made for automobile gearsets less than 1/2-inch face, for 6 pitch, as the greatest width, using a 30-horsepower motor, in cars of the touring class. These gears served very well indeed, and in other cases with gears 2 inches face, the life was short.

That hard material must be used if the face is narrow seems to be good reasoning; on the other hand, it is generally considered that the teeth do not contact all along the face, and if this is so, what is the gain if the face is wide? That there is a gain if the "flywheel effect" is kept down is assured, and it does seem as if the life of narrow-faced gears is, on the whole, better than if the face is wide. The average designer adapts



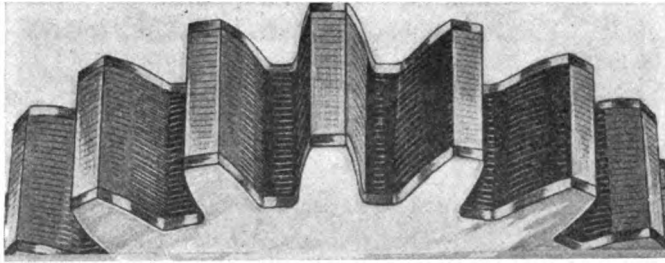

Fig. 18—Example of rawhide, shrouded involute teeth gear.

what he calls a happy medium, and in doing so shows lack of originality on the one hand, and a certain conservatism on the other.

That the old practice of machine designers bears any relation to the true situation, is not believed, unless cast-iron gears are used for the purpose, and it is assured that they would fail in automobile service, just as would gears of fine material fail, were the old methods of design (cast-iron methods) coupled with good material; in the later case the failure would be due to "inertia" rather than to the inferior material.

Proportions of Teeth of Gear Wheels.

This is a phase of the subject which has been the mark for designers for many years. The present trend is in favor of values as follows:

P = diametral pitch in these cases.

- (4) Whole depth of tooth..... = 2.157 | P
- (5) Addendum (depth of tooth above pitch line).. = 1 | P
- (6) Working depth of tooth..... = 2 | P
- (7) Dedendum (depth of tooth below pitch line).. = 1.157 | P
- (8) Clearance at root..... = 0.157 | P
- (9) Thickness of tooth..... = 1.57 | P
- (10) Width of space..... = 1.63 | P
- (11) Backlash = 0.6 | P

There are what is called short-tooth gears, and it is claimed by the advocates of short teeth that the strength of the gears so devised will average some 25 per cent higher than that due to the form as above outlined. The short-tooth form, as devised by C. W. Hunt, is probably the best known. Cutters have to be special, and it is a question if the game is worth the candle. On the other hand, the "stub-tooth" gear is now used, in which the base section of the tooth is greater, and the manner of cutting takes into account the principle of the gear shaper rather than the use of fixed cutters. Of course, the angle changes, in the stub tooth, as compared with the regular involute.

Speaking again of the face of teeth, considering the pitch, it is to point out that the rigidity of the spindle is something to take into account and in this connection it is plain that the rigidity depends upon the length to a vast extent, and the length in turn will be far longer for the progressive form than for the selective type of gear. If the spindle is not rigid, it is then plain that the face of the teeth of the gears will contact at a point only, and the face is of no value unless to afford strength of the tooth to resist bending. As against bending, the best guarantee

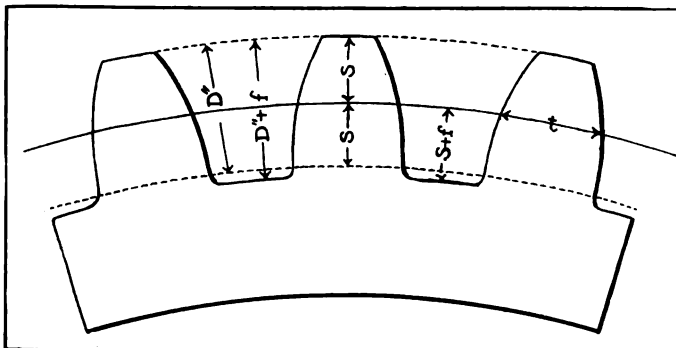

Fig. 19—Used in connection with gear formula for the metric pitch.

is good material, and with a view to defeating other ills, it is best to keep the weight and the diameter low—very low indeed.

For a pair of gear wheels the general formula is usually given as follows, and it will be repeated here as a matter of completeness:

Formula for a Pair of Gear Wheels.

- (12) $b = 2aP;$
- (13) $N = \frac{nv}{V};$
- (14) $n = \frac{NV}{v};$
- (15) $N = \frac{bv}{v + V};$
- (16) $n = \frac{bV}{v + V};$
- (17) $n = \frac{P D' V}{v};$
- (18) $v = \frac{P D' V}{n};$
- (19) $v = \frac{N V}{n};$
- (20) $V = \frac{nv}{N};$
- (21) $D' = \frac{2aV}{v + V};$
- (22) $D = \frac{2a(N + 2)}{b};$
- (23) $d = \frac{2a(n + 2)}{b};$
- (24) $a = \frac{b}{2P};$
- (25) $a = \frac{D + d'}{2};$
- (26) $d' = \frac{2aV}{v + V};$

In which,

P = diametral pitch (the number of teeth per inch of the pitch-diameter).

D' = pitch diameter in inches (of the large wheel).

D = whole diameter in inches (of the large wheel).

N = number of teeth (on the large wheel).

V = velocity (of the large wheel).

d' = pitch diameter in inches (of the small wheel).

d = whole diameter in inches (of the small wheel).

n = number of teeth (on the small wheel).

v = velocity (of the small wheel).

a = center distance in inches of the two wheels.

b = sum of the teeth in the two wheels.

t = thickness of tooth in inches on the pitch circle.

s = subdenda.

D' = working depth of tooth in inches.

f = bottom clearance of tooth (allows for radius) in inches.

D' + f = whole depth of tooth in inches.

P' = circular pitch = center to center distance of teeth, measured on the pitch circle, in inches.

Formulae Used in Metric Pitch Gear Designing.—In many of the cars, notably of the foreign design, gears are designed along lines, taking into account the "metric pitch," in which the "module" is equal to the dimension marked "S" (see Fig. 19), which is the distance from the pitch line to the bottom line of the tooth. In foreign gear work, the further difference is by way of "stub-teeth" in many cases, which to be sure, is a modification of the "involute." The module is given in millimeters, and it follows that all the other dimensions should be in the same units. In many of the foreign cars, as they come to America, the practice (considering the gears in the transmission) is to use gears of a pitch equal to the 4 module. This pitch is equal to 6.35 diametral pitch in the English system.

In general in this work, the module is equal to the pitch diameter in millimeters, divided by the number of teeth in the gear. In the same way it is possible to say that the pitch diame-

ter of a gear in millimeters equals the module multiplied by the number of teeth, and in a comprehensive way, the general formulæ of the metric gear system can be set down as follows:

- Let,
 M = module in millimeters;
 D' = pitch diameter in millimeters, of the gear;
 D = whole diameter, in millimeters, of the gear;
 N = number of teeth in the gear;
 D'' = working depth in millimeters, of the teeth of the gear;
 t = thickness in millimeters, of teeth on the pitch line;
 f = bottom clearance, in millimeters, of the teeth of the gear;

then,

$$(27) M = \frac{D'}{N} = \frac{D}{N + 2};$$

$$(28) D' = NM$$

$$(29) D = (N + 2) M$$

$$(30) N = \frac{D'}{M} = \frac{D}{M} - 2;$$

$$(31) D'' = 2 M$$

$$(32) t = M 1.5708;$$

$$(33) f = \frac{M 1.5708}{10} = 0.157 M.$$

The question of relative advantages of gears cut in accord with the metric system as compared with the best American practice is an idea depending upon whether or not the whole car is designed in one way or the other. If all the rest of a car is in compliance with the metric system, it is then good practice to use the same system for the gears. The involute form of cutter for metric work is now to be had in stock from Brown & Sharp Mfg. Co., and such other firms as cater to the class of trade using the metric system.

Bevel and Miter Gear Work.—It is now considered that well-cut bevel or miter gears are not only strong, but they are noiseless performers as well. In the early days of the automobile the several questions in relation to this class of gears were not given the attention they deserved and the results were below a fitting standard. As the result of more exacting requirements, gear shapers were brought out, and the end is that "fixed cutters" are now little used for the purpose if it is desired to afford noiseless performance.

It is well understood that bevel gears produced with fixed cutters are not theoretically correct; they cannot be, for the reason that the curve in the teeth, when they are properly formed, changes constantly, from one end of the tooth to the other. Fixed cutters cannot, of course, conform to the changing requirement, and as a result, gears produced by fixed cutters are not accurate, and the difference is enough to produce noise, which is the phenomenon to be avoided.

The Angle of Pressure or Obliquity Must Be Considered.—In bevel gear work in particular it seems to be a fact that the old standard angle of obliquity makes for noise. In this connection, it may be well to say that in spur gears the same question is sometimes given attention. The old angle (as originally brought out by Professor Willis, some fifty years ago) was 14 1-2 degrees, while in the most modern work the angle of obliquity is over 20 degrees, and in some cases of good results, this angle was fixed at 22 1-2 degrees.

It is true, to be sure, that the spindles (shafts) should be more rigid on the ground that, with the higher angle, the gears crowd more than if the angle is 14 1-2 degrees. This is but a detail which can well be cared for in the design, whereas, noise due to the angle of obliquity cannot be cared for at all. With the fine materials to be had at the present time there is no use in having the face of the gears so very wide; the wider the face, the greater the chance of having trouble from the point of view of noise.

In any event, it is not well to have pinions with a small number of teeth, and this is even more to be considered in connection with bevel gears than will be the case if the gears are square cut. There is no good reason for having less than 18 teeth in the pinion of bevel drives, and it is an advantage by

way of a reduction of noise to maintain the statue of the bevel drive as follows:

- (a) Keep the pitch-line velocity below 1,000 feet per minute;
- (b) Use pinions with more than 14 teeth;
- (c) Adopt an angle of obliquity of more than 20 degrees;
- (d) Design with a view to symmetry of section;
- (e) Fashion the teeth to the theoretical shape;
- (f) Mesh the gears to run on the pitch line;
- (g) Support the thrust so rigidly that the gears will not spread away from each other; if they do, it is equal to setting them off of the pitch line;
- (h) profuse lubrication is essential to noiseless performance;
- (i) use thrust bearings which can be adjusted while the gears are in motion; it will then be possible to adjust the meshing members by sound; absence of noise will indicate that the gears are rolling on the pitch-line;
- (j) make the case strong enough to take the thrust; have the walls thick enough to vibrate at a low rate; the sound will be less noticeable;

Formulæ Used in the Designing of Bevel and Miter Gears.

There are divers ways of approaching the matter in hand, and it is more a question of getting used to some one way than than it is of the virtue of any one scheme. At all events, if the de-

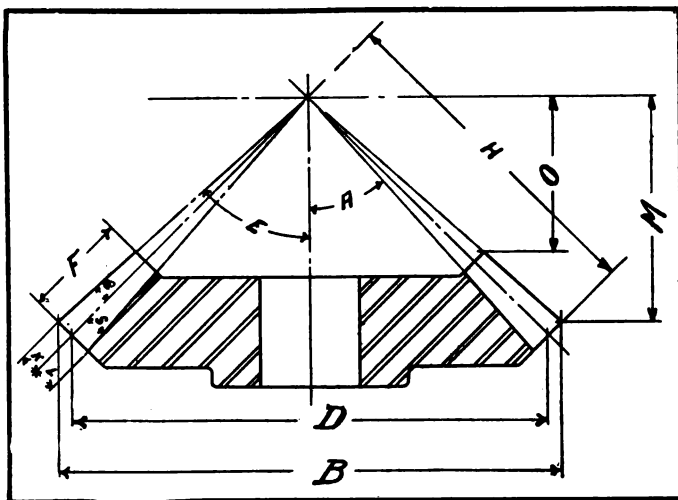

Fig. 20—Diagram of a miter gear for use in connection with formulæ of the same.

signer does not furnish all the means by which the machinist can proceed it is assured that the work will not come out in first-class shape, on the count that what the designers cannot reduce to practice the machinist cannot guess at, and deliver all the cardinal virtues with success. The formulæ, as follows, will scarcely require further explanation; they are used in the haunts of designers; they are of no value outside:

Formulæ for Miter Gears.

P = Circular Pitch; N = No. of Teeth.

- (34) $D = \frac{NP}{\pi} = .3183 NP;$
- (35) $B = D + (.6366 P \sin. 45^\circ) = D + .4497 P;$
- (36) $A = 45^\circ - S;$
- (37) $\text{TANG } S = \frac{L}{H} = \frac{.368 P}{D \times .7071} = .5204 \frac{P}{D};$
- (38) $E = 45^\circ + C;$
- (39) $\text{TANG } C = \frac{K}{H} = \frac{.3183 P}{D \times .7071} = .4501 \frac{P}{D};$
- (40) $M = \frac{D}{2} - (\sin. 45^\circ \times .3183 P) = \frac{D}{2} - .2250 P;$
- (41) $O = M - (F \cos E);$
- (42) $H = D \times .7071;$
- (43) $L = .368 P;$
- (44) $K = .3183 P.$

NOTE.—The letters used in the formulæ for the miter gears are explained in Fig. 20. All dimensions are in inches, and in view of the clearness of the figure it will not be advantageous to complicate the situation further.

Miter gears are not much used in automobile work on the count that in the bevel drive it is generally the case that the ratio is not unity. It is true, however, that in some makes of motors the miter gear design has a resting place, and in such cases it is the custom to use a good grade of carbon steel, as a rule, the same to be quite low in carbon, of the acid open-hearth genera. and case-hardened. In other cases, with a view to noiselessness, it is the practice to use alloy steel in the normal state in order to avoid the deformation which is so prone to follow heat-treatment of any sort. This is especially the case when the parts to be treated are in the shape of bevel gears. The reason for using alloy steel in the cases in which heat-treating is avoided is with the view of securing hardness and strength sufficient for the needs. In a few cases which came under the observation of the author the nature of the work was not well considered, and the untreated miter gears of soft carbon steel failed to take kindly to

Characteristic Bevel Gear Work.—The diagrammatic cut, Fig. 21, in conjunction with the formulæ of the bevel gear set, will serve in the ordinary course of events, provided the details under which the gears have to serve are taken into account. In this class of work as it relates to automobiles it is generally the case that the gears are used in conjunction with sliding gears to make the right-angle drive, and advantage of the opportunity is taken to reduce speed, using the bevel gear set for the purpose. In this service the torque is maximum and the gears have to do all the work required to drive the car; it is also a fact that the "working" brakes (in many cases) transmit through the bevel drive. It follows, therefore, that the bevel drive must be capable of sustaining under severe service and conditions that are not so very good from the point of view of weak parts.

In view of the fact that the bevel drive is in cramped space, it is difficult to afford long distances between the sustaining bearings, and unless the work is well done it is assured that the gear-set will be pinched in the process, and it is noise which will follow. True, bevel gears can be rendered quite noiseless if they are well cut and provided they are set to run on the pitch-line, assuming that the housing is so strong as not to deform under pressure, allowing that the bearings are capable of doing all the work, part of which is as a thrust.

This question of the thrust load is difficult to handle, in view of the extent of the same, and in further view of the fact that the distance between the bearings is short, as before stated. Then it is true that but slight displacement will be enough to allow noise to creep in, and it is this noise which is to be aborted at any cost. The time has passed when autoists will be satisfied with cars merely because they will run; they must perform in a noiseless manner as well. To assure noiseless performance the bevel drive must be devised, taking into account the fact that the thrust does introduce disconcerting details, under the circumstances.

Materials Used in Bevel Gears.—While it is true that bevel gears do not "clash" and do not have to withstand the resultant shock load, the fact remains that the materials to use should be of a character such as will sustain under very severe conditions. Case-hardened steel is much used in this class of work, and if it is of a good grade it will do the work in a manner to leave little to be desired. On the other hand, in gears such as are subject to a double process in heat-treatment, warping becomes the more pronounced, and on this account some designers prefer to use alloy steel in which the carbon content is so related to the alloys as to bring about hardness as a result of quenching without having to resort to the cementing process.

As an illustration of materials such as would serve for this class of work and be hard enough for the purpose in the absence of a cementing process, reference may be had to the following:

Carbon.	Chromium.	Nickel.	Man-ganese.	Silicon.	Sulphur.	Phos-phorus.
.35	.66	3.50	.40	.20	0.28	0.25

It is also possible to use steel somewhat as above, with nickel as low as 2 per cent., increasing manganese somewhat.

It is also practicable to take into account the use of nickel steel in which the carbon should be very low if the steel is to be cemented. Some makers prefer to employ this same grade of steel high in carbon, and hardness is attained through the quenching process in the absence of cementing, while an attempt is made to impart dynamic ability in the subsequent annealing process.

If vanadium is taken into account it is the idea to limit the percentage of the same in the composition to less than .15 per cent., on the ground that the performance of materials in which this element enters is far from good when the element assumes greater proportions. This is especially so in parts to be cemented, and it is enough of a factor to be taken into account, no matter what the heat-treatment may be.

If any alloy steel is used it must be considered that such products are difficult to machine and more difficult to handle in the gear-shaper. On this account many makers prefer to rely on the use of "cementing" carbon steel, in which, as before stated, the carbon content should be held below 16 points.

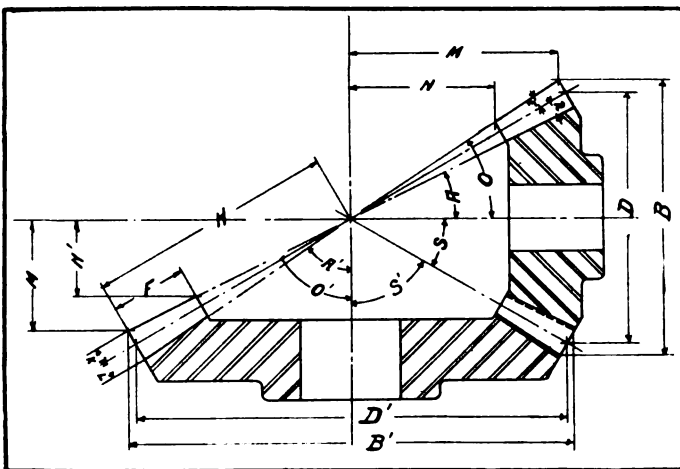

Fig. 21—Diagrammatic Layout of Bevel Gear Set.

the rather peculiar service. It will be remembered that the torque is far from constant; the cam pressure is of an intermittent nature, and that the maximum pressure is a little high and must be allowed for if the life of the gears is long.

Formulæ for Bevel Gears.

Y = No. of Teeth in Pinion; Y' = No. of Teeth in Gear; P = Circular Pitch.

- (45) $D = \frac{Y P}{\pi} = .3183 Y P;$
- (46) $TANG S = \frac{Y}{Y'} = \frac{D}{D'};$
- (47) $B = D + (.6366 P \cos S);$
- (48) $TANG E = \frac{.3183 P}{H} = \frac{K}{H} = \frac{2 \cos S'}{Y};$
- (49) $TANG R = \frac{.368 P}{H} = \frac{L}{H} = \frac{2.3122 \cos S'}{Y};$
- (50) $O = S + E;$
- (51) $A = S - R;$
- (52) $M = \frac{D'}{2} - (.3183 P \sin S);$
- (53) $N = M - F \cos O;$
- (54) $D' = \frac{Y' P}{\pi} = .3183 Y' P;$
- (55) $S' = 90^\circ - S;$
- (56) $B' = D' + (.6366 P \cos S');$
- (57) $N' = M' - F \cos O';$
- (58) $M' = \frac{D'}{2} - (.3183 P \sin S');$
- (59) $H = \frac{D}{2 \cos S'};$
- (60) $K = .3183 P;$
- (61) $L = .368 P;$
- (62) $O' = S' + E;$
- (63) $A' = S' - R.$

NOTE.—The letters used in the formulæ of the bevel gears will be found in Fig. 21, there afforded for the purpose of rendering the formulæ as clear as possible; the dimensions are all in inches.

REVOLVING TYPE OF TWO-CYCLE MOTOR

INSTEAD of using a fan to force air over heated surfaces of the cylinders of a motor, one idea is to force the air through the motor through the air, and in this way produce the maximum cooling effect in the absence of any special device for the purpose, as a fan. When a car is making about 20 miles per hour it is quite well understood that the amount of air displaced by the car in its transit is that which will cool the motor. This has small bearing upon the case unless to make the point that the motor as shown is so designed that the heated surfaces of the cylinders cut through the air at the rate of about one mile per minute; the amount of air which sweeps by the cylinders is therefore more than the amount which is looked upon as necessary for the purpose, if it can be assured that the air is allowed to brush the heat off of the interior surfaces of the cylinders, as it should be able to do.

In view of this expectation it is the idea in this case to not only do away with water, but to resort to the two-stroke-cycle principle as well. It is well understood that in the motor of this type there is the advantage of double the number of power strokes, and if any means can be devised so that the impulses can be given the same vigor as in the four-cycle motor, double the power will follow, considering a given cylinder diameter and a given stroke. To accomplish all these things is something of a job, but it is the task of N. O. Allyn, of Hiram, O., who has worked along these lines until now he has something to show by way of a motor, the performance of which looks so promising that he proposes to see more of it. In this motor the use of a flywheel is not necessary, since the moving mass is adequate

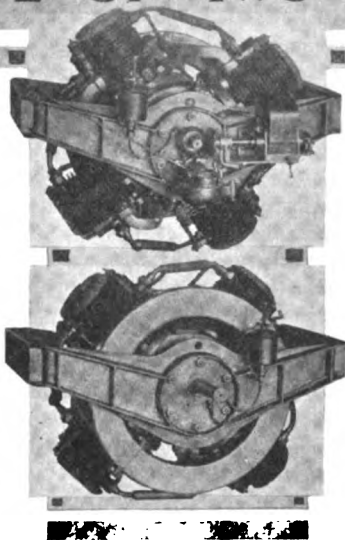

for the purpose for which a flywheel is generally used in conventional work.

The illustrations here afforded will show at a glance the exterior details of the motor, and, as will be noted, the power is that due to the use of four cylinders, each of which has a bore of $4\frac{1}{2}$ in., with a 4-in. stroke. The motor, according to the designer, makes 900 revolutions per minute, and at that speed develops 33 hp. It is claimed that in repeated tests in duration equal to three hours in each case, the cooling was effective and the power maintained with indications of excellent stability.

The ignition is by means of a high-tension magneto in the absence of a battery and coil; the manner of gearing the magneto is shown to be a bevel drive located at the side of the frame, and in a position to be examined at

will. The carbureter is also located on the frame in a position near the magneto, and on the whole, despite the fact that the cylinders rotate, the parts are accessible.

The frame is somewhat heavy, as would be expected, in view of the load, and that this is a detail which the inventor proposes to treat with is assured. The piping between the cylinders is nicely done; account is taken of the centrifugal force, and the kinetic balance of the rotating mass is well cared for, which means that all the parts are machined to size. Symmetry is aimed at, and care has been exercised in the assembling of the parts.

Locally, this motor has been the cause of considerable interest, and that local capital will be interested is assured, rather with the hope, perhaps, that in time the plan will prove to be as good as it looks, taking into account the splendid performance reported, despite the disappointments which always attend a first model.

MORGAN TRUCK HAS ORIGINAL FEATURES.

WORCESTER, MASS., Feb. 22.—The new truck recently produced by Ralph L. Morgan, of this city, bids fair to take a high rank in the automobile world. This is the result of several years' labor on the part of Mr. Morgan, and possesses many original features. The biggest claims made for it are in the line of simplicity, in which respect it is said to be a model for others to copy, all superfluous, unnecessary or complicated parts having been eliminated.

Rated at five tons nominal load the parts are proportioned for a 40 per cent. overload despite which fact the weight of the car light is kept down to 7000 pounds. The features of the truck which differ from the normal car are the differential lock, pressed-steel wheels, extra high clearance, unusually large and powerful brakes, 24-inch steering wheel, chrome nickel-steel gears in the all-spur gear planetary transmission.

The motor is of the four-cylinder, four-cycle vertical type, of 5-inch bore and 5-inch stroke. To decrease the length of the whole vehicle, the wheelbase and consequently the effective turning radius, the driver has been placed over the engine. The first trucks produced have seen hard service in and about Worcester in the past year, one of them hauling 333,000 pounds of steel and wire in a five days' test. Another hard tryout was the hauling of four tons a distance of 146 miles in thirteen hours. Normally geared to twelve miles per hour on the low speed under full load, the car has been able, so it is said, to climb a 16-per cent. grade with ease, and to perform under severe conditions quite in keeping with exacting commercial requirements.

MOTOR-DRIVEN VS. HORSE-DRAWN TRAFFIC.

NORRISTOWN, PA., Feb. 22.—Two parallel roads, built of the same material, one for the use of horse-drawn vehicles and the other for automobiles, to study the general effect of the two classes upon the surface, a plan that has often been advocated but rarely, if ever, tried, will probably be the result of the speech made by former Assemblyman John H. Rex last Thursday evening before the road supervisors of Montgomery County.

Mr. Rex had been invited to speak upon the subject of taxing automobiles to maintain the improved highways, and his talk was novel and interesting, and he advocated some measures that were recognized as fair to all. Among them would be a tax upon both autoists and horse drivers, according to the damage done by each as shown by the proposed test; another would be a different set of taxes for cars with a wide touring radius as distinguished from those doing duty in any one place.

BRITISH DISCOVER NEW TOOL STEEL.

Alloy steel is of such great importance to the automobile maker that the most recent discovery now being heralded in the papers is entitled to "space." In automobile work "tungsten steel" has been relied upon as the mainstay for fashioning parts of alloy steel, and the present claim is to the effect that the new tool steel is superior to anything ever before known for the purpose. Prof. Arnold of the Sheffield University, England, in his discussion of the discovery lends stability to the claims. The exact nature of the new steel is not disclosed.

MERCURY RECTIFIERS FOR CHARGING BATTERIES

GENERALLY speaking, to charge an ignition battery is to waste much of the energy in the process because the charging circuit, if it is that of the regular service from the street, will be of a far higher electromotive force than the counter electromotive force of the battery, with the result that a dead resistance has to be inserted in order to regulate the charge, for the battery would be destroyed in the absence of some suitable device. That is, assuming a direct current is used. With an alternating current it would not be feasible to charge a battery at all, for the reason that the charging would be as the algebraic sum of two forces in a zero equation. This is true in the absence of some device which is capable of rectifying the alternating current, which device should at the same time render the current acceptable in point of electromotive force.

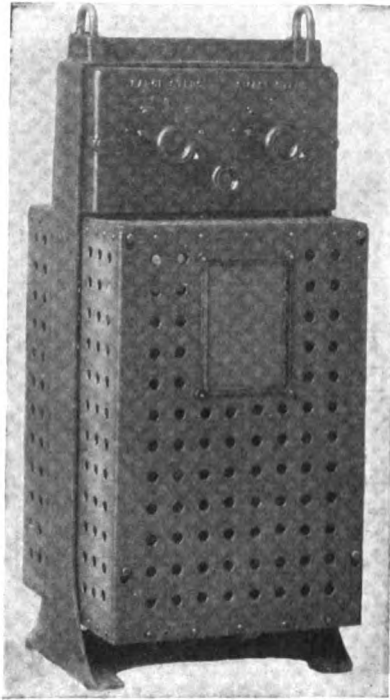

Type A Mercury Rectifier for Charging Vehicle Batteries.

In many places, however, the alternating current will be available where the direct current cannot be obtained, for the reason that "static transformers" used in connection with the alternating current make it possible to transmit the current at a high electromotive force, and step-down the voltage when it is desired to use the current for lighting, power or charging purposes. The loss in transmission, considering an electrical circuit, is directly proportional to the length of the circuit and inversely proportional to the sectional area of the conductor (copper wire). Since the direct current cannot be transformed (in the absence of a rotary transformer), the alternating current possesses an enormous advantage.

Mercury Rectifiers Render Alternating Current Potent.—Taking into account the fact that an ignition battery with, say, three cells of secondary batteries in series, has a maximum charging potential difference of 7.8 volts, to which should be added the drop in volts in the system, making the total not more than 10 volts maximum, it is plain to be seen that a rectifier should be so designed as to enable the same to work on a lighting circuit, the voltage of which is generally 115 volts. Besides acting as a step-down transformer, it is necessary to rectify the alternating wave. This is the function of the mercury rectifier, one of which is here illustrated (see Type E Westinghouse ignition battery rectifier), of convenient size, and in which there are no rotating members.

The Type E Westinghouse rectifier is made especially for rectifying alternating currents to be used in sparking battery charging. It is small, since the capacity does not have to be great in view of the size of the battery, and it is mounted on a panel in such a way as to afford all the advantages of a self-contained unit. The Type E unit is in principle the same as the Type A Westinghouse rectifier, which has greater capacity for larger work. In both cases the efficiency is high, which is fortunately an advantage of the mercury method, and the life is long, so that

the cost of upkeep is nominal. In the plan there is nothing to take into account from the danger point of view, for the rectifier is provided with all the protecting devices dictated by experience and a high regard for utility in the absence of drawbacks of every character.

Purpose of the Type A Rectifier.—In many cases it is desired to charge batteries for vehicle work, in which the batteries are large in proportion to ignition batteries, and for this purpose the Type A mercury rectifier is adapted. It is of a capacity to handle the largest battery used in vehicle service, which takes into account 44 cells, each of which, on charge, demands 2.6 volts (maximum) for a correct charge. The result is that the rectifier must deliver $44 \times 2.6 = 114.4$ volts, not including the loss in the system. On the whole, it requires a system affording an adequate current at about 220 volts electromotive force, and the Type A rectifier is intended to care for this. It also is a self-contained, and on account of its high efficiency is looked upon as a very desirable equipment for the purpose.

There is one more point to be considered—battery, in any given case it must be charged on a basis to maintain the temperature within limits, and means must be provided to prevent overheating it. These rectifiers are almost automatic, and they are devised to enable a novice to do the work. If a battery comes in "hot" the charging current must be limited to suit the lowered counter electromotive force, which is one of the manifestations of the heated condition of the battery. There is the question of a full corrective charge to be considered, and means are provided such as will enable the operator to taper off the charging current at will in full accord with the exacting needs of the occasion.

Increased Range of Utility of Electrics.—Because the mercury rectifier will do the work for which it is devised it is of great importance to the industry, for it affords the advantages of being enabled to utilize the alternating current in charging. Nearly every hamlet in the land is provided with an alternating current lighting plant, and as a result every hamlet may be a center of electric vehicle activity, since the batteries can be readily charged by the use of the alternating current rectifier. In private service there is nothing more in keeping with the needs for comfort and convenience than a garage in the yard of a residence.

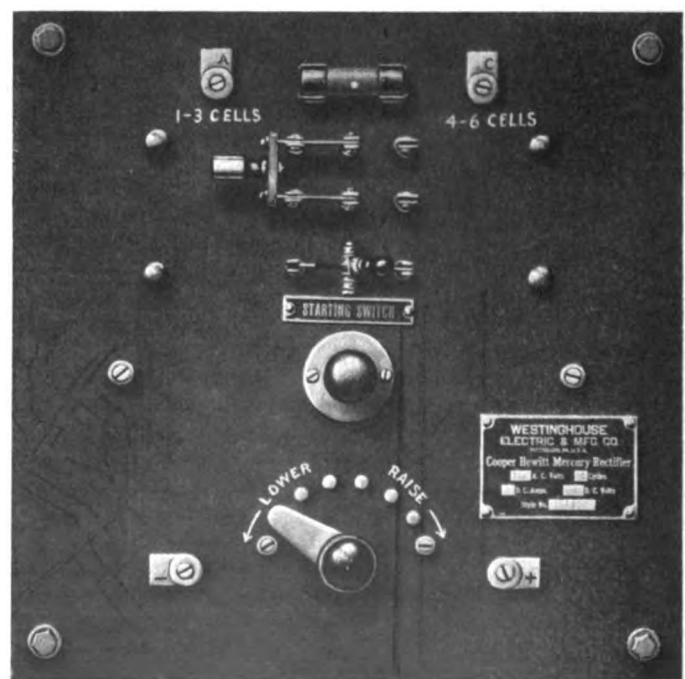

Type E Mercury Rectifier for Charging Ignition Batteries.

TEN YEARS' PROGRESS IN MAGNETO IGNITION*

By J. A. WILLIAMS, PRESIDENT OF THE K-W IGNITION COMPANY, CLEVELAND

IT is an indisputable fact that the gas and gasoline engine of to-day, as far as the engine itself is concerned, is practically perfect, and is not susceptible of further great improvement.

There remain, however, two very important functions of the gasoline engine which, when developed up to a stage as perfect as the engine, will make the internal combustion meter not only the most economical, from a technical and commercial standpoint, but the most reliable source of power extant. These two functions, are those of ignition and carburetion. I have chosen for my subject, ignition. Not that it is of greater importance than carburetion, for they are equally important to the successful operation of the engine, but as I have devoted years to the study of ignition, I feel more competent to discuss it.

Hot Tube the First Type of Ignition.—The first type of ignition which achieved any commercial success was the hot-tube type, which has been superseded by electric ignition, either of the make and break or jump-spark type. The former is more commonly used on large and slower-running engines, while the jump-spark type is more applicable to smaller-powered, higher-velocity engines. The reason for this is, that the mechanical circuit-breaking mechanism for make-and-break ignition is extremely difficult to make of sufficiently small size and light weight as to render it positive at very high speeds.

The jump-spark system of ignition is capable of being successfully operated at very high speeds, as the problems in it are more of an electrical, than a mechanical nature. In other words, the difference between the two has been aptly defined as follows: The make-and-break is complicated mechanically, but simple electrically, and the jump-spark, simple mechanically, but complicated electrically. As to virtue, both are good, and as far as I have ever been able to ascertain, equally good, provided that the apparatus and mechanism employed are of a substantial and satisfactory nature. In either system, the two most important factors to be borne in mind are the creation of a spark that is intensely hot and the proper timing of it.

On make-and-break ignition the spark which is created is composed of what is termed, dynamic electricity, the heat value of which is estimated by multiplying the voltage across the terminals of the arc, by the amperes of current flowing through the spark. The product is the heat units expressed in watts. Now, this same law applies to the estimation of the heat units of the jump spark, provided that the jump-spark is composed of dynamic instead of static electricity. A great many sparks that are used in jump-spark work are static instead of dynamic. The static spark makes a snappy sound, but will only indifferently ignite the charge, whereas a jump-spark that is composed of dynamic electricity, has a reddish appearance, does not have a snappy sound and is intensely hot.

Coils Produce Two Kinds of Sparks.—The spark coils that produce either a dynamic or a static jump-spark look alike, but the defects which make a static spark are: First, that its windings are improperly proportioned to each other, and to its condenser capacity; and, second, through dampness in the insulation of the coil, producing a leakage, which forms a partial internal short circuit in the secondary winding, the result of which neutralizes the self-inductance of the primary winding, consequently permitting the condenser discharge to oscillate at enormous frequencies through the primary winding. This sets up a static current of high voltage and frequency in the secondary winding.

A properly designed and constructed spark coil should simply act as a transformer to transform low-voltage dynamic current into high-voltage dynamic current, but where there are faults in the design or construction of the coil, which permit high fre-

quencies to come into play, it delivers from its secondary winding, static instead of dynamic current. In the design and construction of the spark coil, the object should be to keep down the frequency of oscillation to just as low a point as possible, so as to get just as pure a dynamic current out of the secondary as possible. A static spark is composed almost entirely of high frequency, high voltage, with no appreciable amperage or volume, consequently it has not sufficient heat units.

Which Spark Gives Most Power?—There is no doubt that the majority of jump-spark coils in use to-day are not delivering pure dynamic sparks, but largely static sparks. This feature calls to mind the much-discussed question as to which of the two sparks, make-and-break, or jump-spark, give to an engine the more power. Some have said make-and-break, and some, jump-spark. No doubt when a good make-and-break spark is compared with a poor or static jump-spark, the evidence is all in favor of the make-and-break spark, but in reality if a good hot, dynamic current, jump-spark is compared with the same character of current in a make-and-break spark, there will be found no difference in the power developed by the engine with either of the two systems of ignition. The power given to the engine, therefore, does not depend upon what system of electric ignition it has, but entirely upon the current used.

In make-and-break ignition, there is no way to make a static spark, consequently all are dynamic, but in jump-spark ignition, with cheaply constructed coils, the majority of the sparks in use, are static, and consequently very low in heat units.

The timing should be so arranged that the engine will receive the full force of the explosion at its dead-center position or immediately thereafter, as in this position the mixture is at its highest point of compression, and occupies the smallest space. The spark, however, should occur slightly before this, the amount in advance depending, first, upon the character of the mixture, its homogeneity and chemical composition; and, second, upon the heat of the spark. For instance, take a mixture that is either of an improper proportion or that is poorly mixed, and it will require more spark advance than a mixture of proper proportions that is homogeneous and well mixed, or a weak spark will require considerably more advance to light any mixture than will a hot spark.

Hot Spark Creates Complete Combustion.—This is one reason why a hot spark gives more power than a weak spark, and is the principal reason, for the hot spark does not start combustion until the compression stroke is nearly or entirely completed and it propagates through the charge more rapidly, thus creating complete combustion when the gas is compressed in its smallest volume, consequently raising it to a higher temperature, giving a greater thrust to the piston and maintaining its thrust at greater pressure through the entire power stroke.

In multiple cylinder engines, the timing of the spark must be exact. In other words, there must be synchronism or equal time between the occurrence of the spark in the different cylinders. In further explanation, the spark must occur at exactly the same point on the crank-shaft circle for every cylinder. Let us take for example a three-cylinder engine; should the explosion occur at exact dead center, in cylinder 1, 20 degrees before dead center in 2, and 20 degrees after dead center in 3, you would have only one cylinder giving its full quota of power, namely, cylinder 1. Cylinder 2 would spend part of its power trying to reverse the engine while cylinder 3 would fall 20 degrees short of giving a full-power stroke. This example is by no means a common condition, but it seems to be the rule rather than an exception.

With make-and-break ignition on multiple-cylinder engines, it is hard to maintain exact synchronism, owing to the wearing of

* Paper read before the National Gas and Gasoline Engine Trades Association at Chicago, February 9, 1909.

the ignitor points and circuit-breaking mechanism. With jump-spark ignition, where the timer segments are equally spaced, and where a master vibrator is employed to break the circuit for all the coils, no such difficulty is encountered, but exact synchronism is established, and maintained all of the time between all of the cylinders. Where a master vibrator is not employed, it is difficult to adjust the vibrators of the different coils so as to get exact synchronism. It is possible, however, to build coils which will synchronize without a master vibrator. In other words, coils which are auto-synchronous, no matter how their vibrators are adjusted.

The Two Sources of Current.—There are two sources of electric current for ignition. One is the magneto, which generates a current by mechanical means, the other is a battery, which generates current by chemical means. There are three types of magneto ignition. The most recent type is the inductor type of magneto which has no moving wires, commutators or brushes, and which generates a sine wave of alternating current. The second is a dynamo type, has a commutator, brushes and a drum-wound armature, also has a permanent magnetic field. This type is merely a dynamo with permanent magnets instead of electromagnets for its field. The third is an alternating-current magneto which is equipped with its own circuit breaker and distributor, and is commonly called a high-tension magneto. This type is also often made with a circuit breaker, distributor and a primary winding on it, which operates on a coil, external to the magneto. It is a low-tension magneto, but is frequently incorrectly called a high-tension magneto.

In this article we will refer to magneto ignition as used on the make-and-break system of ignition, and on the jump-spark system of ignition where a timer and vibrating spark coil are used. The magneto system is, of course, more expensive in first cost, but if a properly designed magneto is used, there is no appreciable maintenance charge. If batteries are used, while the first cost is lower, the maintenance charge begins with the starting up of the engine and never stops as long as the engine is in use.

Ignitors Last Indefinitely.—On make-and-break ignition there is a very decided reason for using magneto over battery ignition, for with a properly designed magneto, the ignitor points in the cylinder of the engine last indefinitely, and may be made of very cheap material, such as steel, or German silver, for the voltage which the magneto delivers is sufficiently high to overcome any ordinary resistance, such as oxidized or dirty points, whereas the ordinary battery which only delivers from four to six volts for make-and-break ignition, requires clean contact points of a metal which will not oxidize.

The dynamo type of magneto which has a commutator, brushes and governor, and which operates through means of the ordinary kick coil, just as batteries do, is no better in this respect than batteries. The proper type to use for make-and-break ignition is the inductor type, which requires no coil, as the winding on the magneto itself acts as a kick coil, so that when the circuit is broken, the voltage across the ignitor points will range very close to seven hundred volts, according to winding of the magneto and its speed, although the amperage will be small.

Voltage Very Low with Batteries.—With battery or ordinary dynamo-type magneto, the first voltage, that is, the one used in charging the primary or kick coil, is necessarily extremely low, from four to six volts, and the voltage across the points when they break is about sixty volts. Now, assuming that both sparks have the same amount of energy, the one from battery or dynamo type of magneto would have ten times the current and ten times the destructive effect upon the ignitor points of the engine than would the inductor type of magneto. It is not voltage that burns out points, but it is the amperage.

The inductor-type magnetos that I am most familiar with have a primary voltage of about 70 volts, which is ample to go through any set of ignitor points, no matter how burned, pitted or oxidized they may be, and as this is multiplied about ten times by the breaking apart of the ignitor points, there is about 700 volts with a consequently small amount of amperage thrown

across the ignitor points as they separate. An additional advantage of the inductor type of magneto over the dynamo type for make-and-break ignition is, that the former can be positively gear driven at crank-shaft speed for engines of one, two and four cylinders, and at one and one-half times crank-shaft speed, for engines of three and six cylinders. The inductor type has the further advantage of passing current through the ignitor points in a very much smaller interval of time than a battery or dynamo type can charge a primary coil, therefore the circuit-breaking mechanism on the engine can be so constructed as to close the circuit for a very small interval of time, thereby taking up a lot of the lag in the circuit-breaking mechanism.

Now, when using a primary or kick coil with battery or dynamo-type magneto, it takes such a long time for the primary coil to become charged with current that the circuit-breaking mechanism on the engine has to keep the contact points together for a considerable period of time in order to charge the coil, and then when the tripping mechanism operates, the circuit breaker has to swing through a long arc of its travel before it breaks the contacts apart, thus causing a considerable lag in the circuit breaker. The inductor-type magneto permits of the use of a circuit breaker for make-and-break spark which will operate the engine at engine speeds fully as high as any jump-spark system could operate under.

Coil Is the Most Important Factor.—In jump-spark ignition the most important factor in the apparatus is the spark coil, which looks very simple, but there is enough electrical science employed in the construction of one to fill volumes in describing it. All that we can say about it here is that it must be so designed and built as to produce a dynamic instead of a static spark. It must have a very quick time constant, permitting it to operate on timers of very short segments, thus economizing battery current. Furthermore, it should have a vibrator constructed with reference to the time constant of the coil and so constructed that a careless user could not possibly adjust the vibrators so as to make the coil take more current than its insulation would withstand.

Soft platinum points should not be used, but an alloy of such a percentage of iridium and platinum as will permit a very hard and dense point and one which will not weld itself together as soon as it heats up. It must be borne in mind that pure platinum is a very soft, and spongy metal, and will weld together at extremely low temperatures, while iridio-platinum contact points require a very much higher temperature before they will weld. In the construction of spark coils the very best of insulating materials should be employed, and after the windings are made, they should be pumped out in a hot vacuum, thus exhausting all of the air and moisture. They should then be impregnated while under vacuum with a dielectric of heat-and-moisture-resisting qualities, thus preventing all electrical discharges and leakage between its turns and layers.

This method of treating coils is quite recent, and is by no means as yet universal among the various coil builders. If spark coils were all built properly with the proper kind of windings, the proper kind of vibrators used, and the coils used in connection with the proper kind of timers, that is, timers which do not have an unnecessarily long period of contact, it would be found that the battery consumption could be reduced very materially.

Inductor Magneto Gives a Hotter Spark.—As to source of current for jump-spark ignition; two kinds of magnetos may be employed, or battery ignition. The inductor-type alternating-current magneto, the voltage of which increases directly as the engine speed increases, gives a much hotter spark at normal rates of engine speed than either the dynamo type of magneto with governor, and which has a fixed voltage owing to its having a fixed speed controlled by governor, or a battery which we know has a fixed and non-increaseable voltage.

The reason that increased voltage is required as the engine increases in speed is because the timer contact points in passing over each other rapidly do not come into as intimate electrical contact with each other as when the engine is running slow.

LETTERS INTERESTING AND INSTRUCTIVE

TIME RATE OF EXPLOSION OF ACETYLENE.

Editor THE AUTOMOBILE:

[1,763.]—Since acetylene is an explosive of more than ordinary ability the question is, why is it not adopted for use in automobile work in view of the fact that gasoline is becoming more costly, as time, and it is possible that more power would follow the use of acetylene, considering a given cylinder displacement?

Deep River, Conn.

PAMPER.

Acetylene would prove the more expensive of the two. Enough "carbide" is not available to do the work. Mechanically, there is the question of the time in which the acetylene will explode, relative to the time required for gasoline. It is generally considered that acetylene is five times faster than gasoline, and the question is, would not this fact lead to mechanical complications? Acetylene is regarded as suitable for use in fuel mixtures in which gasoline will play a part, and in time, as the fuel problem becomes more acute, acetylene is bound to be utilized, to some extent, at any rate.

If acetylene is capable of exploding five times faster than gasoline it would look as if the question of timing would have to receive more than a little attention, and the compression would have to be very closely regulated. On the whole, it may be that acetylene has not been fairly dealt with in that it has been experimented with but little, probably under conditions which might satisfy the characteristics of gasoline, rather than acetylene. That an increase in power would follow the use of acetylene is probably true, assuming that the mechanical device could be perfected in such a way as to assure results in conformity with the energy in the acetylene; the mixture would be about 3.28 times more powerful than mixtures of gasoline and air.

WET MULTIPLE DISC CLUTCHES.

Editor THE AUTOMOBILE:

[1,764.]—I have a car in which the discs are not lubricated and while the clutch works (when it is in good order) the point is that it does not last long enough to suit me; it could be made to hold oil, with but little work, and the question of the lubricant to use is uppermost in my mind; what is the best practice?

Chicago, Ill.

DRY DISC CLUTCH.

The coefficient of friction will be lowered, and if the clutch, with the same number of discs and the same pressure, is rendered "wet," it may not then possess the requisite negative torque. The clutch oil can be half and half light lubrication oil and kerosene oil. If the surfaces are small and the heat generated is enough to run up the temperature to the "flash point" of the oil, it is then that a fire will have to be quenched. If the space is adequate, it is possible to maintain the coefficient of friction, despite the use of oil, by taking advantage of the qualities which reside in "cork inserts." If the clutch will hold, then the heat will not run up to a point such as will approach the flash-point of the oil and the question of a fire will not have to be taken into account.

WHAT IS THE FASTEST MOTORCYCLE TIME?

Editor THE AUTOMOBILE:

[1,765.]—Kindly tell me in "Letters Interesting and Instructive" if a motorcycle ever attained a speed of 135 miles per hour.

Washington, D. C.

H. T. CHITTENDEN.

The fastest time recorded as having been made upon a motorcycle is that of a mile in 44 2/5 seconds, a speed of 81.08 miles per hour, made by William Wray on a Peugeot on the Florida beach. This, however, is not recognized by the Federation of American Motorcyclists as a record, because Wray was using a machine with more than 61 cubic inches cylinder displacement, rated at 14 horsepower. The recognized record for the straightaway is 46 2/5 seconds, a speed of 77.58 miles per hour, made by G. H. Curtiss on a Curtiss. The circular track record is 54 seconds, a speed of 66.66 miles per hour, held by Fred Huyck, using an Indian.

SEVERAL THERMOMETER SCALES COMPARED.

Editor THE AUTOMOBILE:

[1,766.]—I do not understand the relation between the several thermometer scales in use and I will be glad to have you enlighten me on the subject; it is possible that others are in the same fix.

Portland, Me.

ICE COLD.

Equivalents of temperature scales are quite easy to reduce if the matter is given but a moment's thought. There are three scales in common use: (a) Celsius, (b) Reaumur, (c) Fahrenheit; they relate to each other as follows:

The melting point of ice equals:

Celsius degrees.	Reaumur degrees	Fahrenheit degrees
0	0	32

The boiling point of water equals:

Celsius degrees.	Reaumur degrees	Fahrenheit degrees
100	80	212

(a) To change from Fahrenheit to Celsius:

$$\text{Celsius degrees} = \frac{(\text{Fahrenheit} - 32) \times 5}{9}$$

(b) To change from Celsius to Fahrenheit degrees:

$$\text{Fahrenheit degrees} = \frac{(\text{Celsius degrees} \times 9)}{5} + 32$$

(c) To change from Fahrenheit to Reaumur degrees:

$$\text{Reaumur degrees} = \frac{(\text{Fahrenheit degrees} - 32) \times 4}{9}$$

(d) To change from Reaumur to Fahrenheit degrees:

$$\text{Fahrenheit degrees} = \frac{(\text{Reaumur degrees} \times 9)}{4} + 32$$

The scale Celsius is sometimes called "centigrade"; it is much used in scientific work and it has the advantage of dividing the scale into 100 equal parts, with magnitudes quite up to the requirements as respects utility.

A DIVERGENCE FROM SCOPE OF SUBJECT.

Editor THE AUTOMOBILE:

[1,767.]—I wish to take exception to a statement you make in the February 11 issue of "The Automobile," since I believe the statement to be partial or due to insufficient knowledge on your part of the subject of ball bearings. You say: "If the balls cannot come into contact with each other it is true that noise will be aborted, and since there is no occasion for having a full complement of balls it is the practice to turn out 'silent' ball bearings with separators to aid in the process."

It is possible in but few cases to completely fill the space between two concentric rings with balls so that usually there is left a space not occupied by balls. The result is that in a ball bearing running dry every time a ball is carried over in the direction in which it is moving it bumps the ball in front of it, producing a slight click; if the speed of the rotating shaft is sufficiently great, these clicks follow one another with sufficient rapidity to produce a continuous sound or hum. However, ball bearings are usually lubricated with a light or medium grease, the viscosity of which is great enough to prevent the balls from dropping over. In this case the sound is no longer heard and it is a misstatement of facts to say that the full bearing is not as silent as the cage bearing. In fact, the full type bearing under these conditions is the more silent, as will be shown.

In a full bearing the balls do not press against one another, except sometimes with their own weight, but this is negligible. Between every two balls there is a point contact, and, since the pressure is practically zero, the friction between the balls is negligible and the sound due to the rubbing of the balls against one another is inappreciable. With a cage bearing, there is likewise little if any pressure between the balls and the cages, but the balls now have a surface contact instead of a point contact and the sound due to the rubbing of the balls against the walls of the cages, although very slight, is greater than with a full bearing. It should be remarked, however, that in either case the sound is so

slight that no reasonable objection could be held against either type of bearing as a noise producer.

Are not all cup and cone bearings of the full type? No complaint, so far as I know, has ever been made that these bearings are noisy. Further, it may be of interest to many automobile manufacturers in this country to know that most French cars are equipped with full bearings. Has complaint been made that these bearings are noisy?

The statement that there is no occasion for a full complement of balls, as well as the statement that full bearings are not used to cover a multitude of desires on the part of ball bearing manufacturers to make a full bearing without any filling slots. And the inability of these manufacturers to do this has been used as a pretext for stating that a full complement of balls is not required. Why not? Will a bearing with four balls in it carry as much load as one with twenty balls of the same size? Let us take for example two bearings having similar grooves or races and balls of the same diameter and made of the same material. The carrying capacities of these bearings will be directly proportional to the number of balls in each race. As a concrete case, if a cage bearing has six balls and a carrying capacity of 1,000 pounds, a full bearing of the same dimensions having, say, twelve balls, will carry 2,000 pounds. Doesn't this mean a better distribution of the load and consequent longer life of the bearing? Why, then, is there no occasion for a full complement of balls?

One can readily understand that a full bearing without a filling slot has certain advantages which cannot be claimed for a full bearing that has such a slot. A radial bearing should not, under any circumstances, whether made with or without a filling slot, be used to carry a thrust load. This applies particularly to bearings carrying great loads at comparatively low speeds. However, designers persist in using radial bearings to carry thrust loads, and it remains to ameliorate conditions until, by education, these designers are convinced that excessive thrust loads should be carried by thrust bearings. When a radial bearing having a filling slot is subjected to end thrust, the balls are pinched at the slot resulting in rapid wear to both balls and races. In a bearing without a filling slot pinching of the balls cannot occur.

When a radial bearing is subjected to a radial load only a few of the balls carry the load, but when such a bearing is subjected to thrust load, this load is carried by all the balls, and the greater the number of balls the greater is the thrust-carrying capacity of the bearing; in other words, other conditions being the same, the greater the number of balls the better the bearing. Then, why do you say there is no occasion for a full complement of balls?

New York City.

ASHER GOLDEN.

There is no occasion for having a full complement of balls, if the bearings without a full complement are properly selected. There is no law against having a full complement; they are to be had in the open market. Nowhere in the letter you referred to is the full type discussed at all.

There is small occasion for discussing what will happen in the absence of lubrication. All makers of bearings recommend the use of lubricating oil.

As respects the "foreign practice," no doubt the American makers will greatly appreciate the information you so kindly offer.

You say, "if a cage bearing has six balls and a carrying capacity of 1,000 pounds, a full bearing of the same dimensions having, say, twelve balls, will carry 2,000 pounds." You show utter lack of knowledge of the subject in thus attempting to maintain that a ball bearing increases in ability in direct proportion to the number of balls used.

What you say about thrust loads on radial types of bearings is so foreign to the practices of the day, and of the years back, that force is conspicuous for its absence. If you are right, many builders of automobiles should be willing to pay you a large sum to act for them as nurse.

Don't know why you go to so much trouble to tell how "annular" ball bearings should be built to fit them to work under thrust loads, if they are not to be used for the purpose.

You say that with cages the balls have a surface contact and that sound will follow as a result of rubbing of the balls against the walls. When next you take up the subject, kindly tell us what the oil is for—if the pressure is slight; if the surfaces are oiled, how will the balls squeeze the oil out from between the surfaces?

It is quite useless to discuss the question of what ball bearings to use in slow speed work, in view of the fact that in automobiles the speed is high.

USE A SLIDING GEAR FOR A HEAVY AUTO.

Editor THE AUTOMOBILE:

[1,768.]—I am about to assemble a four-passenger roadster which will have a four-cylinder motor rated at 23-30-horsepower. The car will weigh, when complete, without passengers, 1,800 pounds; will it be practicable to use a planetary gear? If not, why not?

Atlantic Highlands, N. J.

SUBSCRIBER.

The car you outline is well within the class called "touring," and should have a sliding-gear transmission with three forward speeds. The reason for this lies in the fact that the motor does not possess the ability to deliver torque on a fitting basis at low speed, and it is torque which must take the place of speed. With a three-speed transmission set it will be possible to run the motor at a speed fast enough to realize power to an adequate extent, and the gear ratio can be adjusted to a point such as will enable you to enjoy that wide range of flexibility so desirable on bad roads in particular.

THE AUTOMOBILE CALENDAR.

AMERICAN.

- Mar. 1-6.....Buffalo, Convention Hall, Annual Show, Automobile Club of Buffalo. D. H. Lewis, Secretary.
- Mar. 6-13.....Boston, Mechanics Building, Seventh Annual Automobile Show, Boston Automobile Dealers' Association. C. I. Campbell, Manager, 5 Park Square.
- Mar. 8-13.....Kansas City, Kansas City Automobile Dealers' Association Show.
- Mar. 8-14.....Portland, Ore., First Annual Automobile and Sportsman's Show, Portland Automobile Club. W. F. Lipman, Secretary.
- Mar. 11-13.....Milwaukee, Wis., Hippodrome, First Annual Show of Milwaukee Automobile Club.
- Mar. 13-20.....Minneapolis, Minn., National Guard Armory, Second Annual Show, Minneapolis Automobile Show Association. F. E. Murphy, Secretary.
- Mar. 15-20.....Rochester, N. Y., Convention Hall, Annual Show, Rochester Automobile Dealers' Association. Charles J. Moran, Exhibition Manager.
- Mar. 22-27.....Toledo, O., Coliseum, Annual Automobile Show, Toledo Automobile Dealers' Association.
- Mar. 27-Apr. 3.....Pittsburg, Duquesne Garden, Automobile Show, Pittsburg Automobile Dealers' Association.

Races, Hill-climbs, Etc.

- Mar. 5-12.....Palm Beach, Fla., Lake Worth, Fifth Annual Regatta. Palm Beach Power Boat Association.
- Mar. 23-26.....Daytona, Fla., Seventh Annual Florida Beach Races, Florida East Coast Automobile Association. New York Representative, W. J. Morgan, Thoroughfare Building.
- Mar. 24-27.....Syracuse, N. Y., State Armory, Automobile Show, Syracuse Automobile Dealers' Association.
- April 5-10.....New York City, Carnival Week, New York Automobile Trade Association.
- April 10.....New York City, Fort George Hill, Second Semi-Annual Hill Climb of New York Automobile Trade Association.
- April 27-30.....Detroit, Mich., Four-Day Endurance Run, Detroit Automobile Dealers' Association.
- June 11-12.....New York City, Two-Day Mountain Tour and Reliability Contest to Catskill, N. Y., and Return, New York Automobile Trade Association.

FOREIGN.

Races, Hill-climbs, Etc.

- Mar. 31-Apr. 14.....Monaco, Italy, Annual Motor Boat Regatta and Championships.
- May 2.....Sicily, Targa Florio, Automobile Club of Italy.
- May 26.....Russia, Moscow—St. Petersburg Race.
- June 10-18.....Germany, Prince Henry Cup Competition.
- June 14-19.....Scotland, Scottish Reliability Trials.
- June 20.....France, Boulogne-sur-Mer Course, French Volturette Race, auspices of "L'Auto."
- July 13-17.....Belgium, Ostead Automobile Race Week.
- Sept. 5.....France, Mont Venteoux Hill Climb.
- Sept. 11-19.....Italy, Bologna, Florio Cup Race, Automobile Club Bologna.
- Sept. 19.....Austria, Semmering Hill Climb.

WHAT IS GOING ON IN CLUBDOM'S REALM

BOSTON'S BIG CLUB IS REORGANIZING.

BOSTON, Feb. 20.—If present plans are carried out Boston will have a new motoring organization, larger and stronger than any that now exists. It will be brought about by the amalgamation of the Bay State Automobile Association and the Boston Motor Club, the organization of which was begun a few weeks ago, but has now been halted because of the larger project. Many of the parties interested in the Boston Motor Club are former members of the Bay State, having resigned recently on account of differences of opinion regarding the management of the association.

Realizing that it would be impossible for the Bay State to continue to hold its important position in the motoring world with a diminished membership, and that less could be accomplished for the cause of motoring by two small clubs than by one large one, the directors of the Bay State made overtures to the organizers of the Boston Motor Club looking toward an amalgamation.

The result of these overtures was an agreement between committees of the two clubs to organize a new and third club, which shall include the members of the Bay State and the Boston Motor Club. After the new club is organized the others will go out of existence and the new organization, with a new name to be decided upon later, will occupy the clubrooms of the Bay State Automobile Association. This plan has been ratified by the Boston Motor Club promoters, and it will shortly come before the members of the Bay State. If it is accepted and goes through, it is believed that Boston will have one of the best motoring clubs in the country, and one that will worthily uphold the dignity and prestige of the Hub and the Bay State.

NEW HOUSE FOR LONG ISLANDERS.

BROOKLYN, N. Y., Feb. 22.—Fronting on Prospect Park Plaza, at 918 and 920 Union Street, a four-story building, well suited for the needs of automobilists, has been secured for the new clubhouse of the Long Island Automobile Club and will be occupied at an early date, according to a special announcement made by the Board of Governors. The building will easily accommodate 150 cars, with a large elevator for carrying them to the various floors or to the basement for storage, cleaning or to the top floor for repairing. A fully equipped shop is at hand, with all the necessary machinery to enable owners to do their own work, if desired, upon their machines. The clubrooms will be located upon the second floor, with a fine view of the Plaza, and will be arranged and furnished very shortly.

The committees for the ensuing year have been appointed and their chairmen are as follows: Law and Legislation, W. P. Richardson; House and Entertainment, Edwin Melvin; Auditing, J. H. Emanuel; Garage, William Schimpf; Membership, A. C. Alderman; Contest, A. R. Pardington; Technical, Louis T. Weiss; Good Roads, C. J. Edwards.

SCHEME OF ONE CLUB'S ENDURANCE ROUTE.

NORRISTOWN, PA., Feb. 22.—The local automobile club has such a variety of opinions as to the best route for the two-day endurance run it proposes to hold next May that it has adopted a novel scheme to reach a decision. At a smoker in its new clubhouse next Thursday evening, to which all the prominent owners and tradesmen in Norristown, Philadelphia, Lancaster, Reading and other nearby cities have been invited, all will be invited to express their opinions in the matter. That unique organization of Philadelphia automobile writers, "The Shock Absorbers," will come up from Philadelphia.

A. C. A. TO REPEAT DINNER DANCE.

NEW YORK, Feb. 22.—Owing to the very evident success of its first dinner dance, held on the evening of February 17, the Automobile Club of America has decided to repeat the affair in the near future. The attendance of some 160 persons at the first, and their pleasure, was such as to cause the chairman of the entertainment committee, Orrel A. Parker, to announce that similar events will be put upon the programme. At the first one, the first, also, when ladies took a prominent part in a social function held by the club, the dinner was held in the grillroom and was entirely informal, there being no speeches. The dance itself was held in the big ballroom later in the evening, and this arrangement met with universal favor. The second affair is to be held at a date to be announced soon.

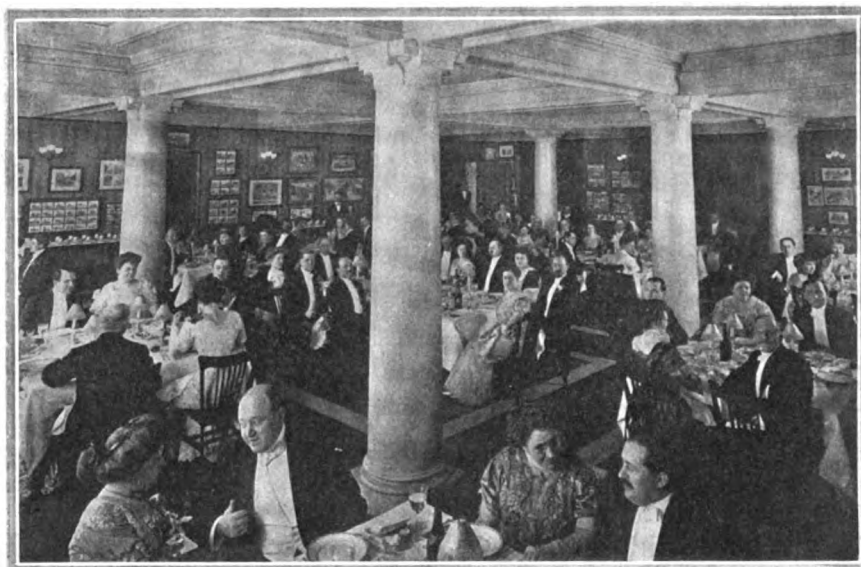

Where the Diners Assembled in the Grillroom of the A. C. A.

DETROIT MAY HAVE ANOTHER CLUB.

DETROIT, Feb. 22.—Detroit is to have a new automobile club, if present plans materialize. The pioneer organization locally is the Detroit Automobile Club. During the Summer, there is always something doing at the Pine Lake clubhouse, thirty miles from Detroit, but in Winter everything lies dormant.

The proposed organization will be built along broader lines, corresponding to similar ones in Buffalo, Cleveland, Rochester and elsewhere. Every automobile owner in Wayne county is eligible, and any motorist outside the county can become an associate member. Headquarters will be established in one of the downtown hotels, club rooms maintained, and the organization, which promises to enter the field with not less than 500 members, will take an active part in framing legislation for motorists and in the advancement of the good roads cause.

ADDITIONS TO PENNSYLVANIA FEDERATION.

PITTSBURG, Feb. 22.—Two new clubs have been added to the Pennsylvania Motor Federation within the past month. They are the Automobile Club of Du Bois, of which J. H. Fulford is secretary, and the Beaver Valley Motor Club, of Beaver Falls, whose secretary is J. A. Snyder.



Vol. XX Thursday, February 25, 1909 No. 8

THE CLASS JOURNAL COMPANY

Thirty-ninth Street Building, 231-241 West 39th St. New York City

H. M. SWETLAND, President

EDITORIAL DEPARTMENT

A. G. BATCHELDER, Managing Editor; R. F. KELSEY, Associate Editor; C. B. HAYWARD, Engineering Editor; W. F. BRADLEY, Foreign Representative

BUSINESS DEPARTMENT

A. B. SWETLAND, Business Manager; LOUIS R. SMITH, FRANK B. BARNETT; W. I. RALPH, 1035 Old South Building, Boston, Mass.; C. H. GURNETT, 1900 Michigan Ave., Chicago, Ill.; F. W. VAN SICKLEN, H. H. GILL, Detroit, Mich.; T. B. VAN ALSTYNE, Philadelphia, Pa.

Cable Address - Autoland, New York; Long Distance Telephones - 2046 Bryant, New York

SUBSCRIPTION RATES:

United States and Mexico - One Year, \$3.00; Other Countries in Postal Union, including Canada - One Year, 5.00; To Subscribers—Do not send money by ordinary mail. Remit by Draft, Post-Office or Express Money Order, or Register your letter.

FOREIGN SUBSCRIPTION AGENTS:

ENGLAND:—W. H. Smith & Sons, Ltd., 186 Strand, London, W. C., and all their railroad bookstalls and agencies throughout Great Britain; also in Paris at 248 Rue de Rivoli. FRANCE:—L. Baudry de Saunier, offices of "Omnia," 20 Rue Duret, Avenue de la Grande Armees, Paris. GERMANY:—A. Seydel, Mohrenstrasse 9, Berlin.

Entered at New York, N. Y., as second-class matter. The Automobile is a consolidation of The Automobile (monthly) and the Motor Review (weekly), May, 1902, Dealer and Repairman (monthly), October, 1903 and the Automobile Magazine (monthly), July, 1907.

LEGISLATORS WITH NARROW VISIONS.

Strange things are sometimes said by worthy legislators in the Congress of these United States at Washington. How forcibly has this been impressed upon the public at large recently through the animated discussions as to whether or not the President-elect shall be allowed to ride in comfort in the tonneau of a big touring car or be made to use the old method of horse-drawn transport. Yet it is a fact that the advisability of allowing automobiles to supersede horses in the White House stables was seriously questioned. That has been, at last, permitted, but still the subject of automobiles crops up, and still some of the members of that venerable body, the Senate, are prone to show either narrowness of vision or what little they know by telling all they know.

The present session has been remarkable for the amount of time devoted to the discussions of automobile matters, and it has developed that the automobile has more friends than enemies under the great white dome. The last debate was an interesting one between Senators Tillman and Bailey, occurring when the salary for a District of Columbia official, as a member of an "automobile board," was discussed. Senator Tillman stated that he favored the automobile, but thought that the police should be made more strictly to enforce existing speed regulations. Imagine the answer from Senator Bailey: "I am frank to say that I do not believe there is progress in commercial or political conduct that substitutes factory

products for those of the farm. I protest against the government still further accelerating this. * * * It is the intention of the President-elect to discard horses and substitute the automobile, and then everybody will want to imitate the President, thus depriving the farmers of a valuable customer for one of the necessary products of the farm."

Senator Tillman's rebuttal was to the point, saying that his colleague's position was untenable and that he was mistaken in his dread of the effect of automobiles on rural life, without taking into consideration that they are parts of the progress of the world in locomotion.

If Senator Bailey fears that growth of the automobile industry will deaden that of raising horses, it is wondered what he said when gasoline engines were substituted for the old treadmill, or what in answer to the fact that the use of automobiles is taking more real money, in cash and bills, out into the country than any other step in the progress of the nation.



PRICE OF STEEL HAS SMALL BEARING.

Taking into account the distribution of the several items which enter into the cost of automobiles it is to be noted that steel represents no more than one-tenth of the whole cost, providing the steel used is of the finest grade the market affords. On the face of it, a cut of even 20 per cent. in the price of steel would only amount to 2 per cent. in the cost of a car; hence it is plain that the automobile industry is only passably interested in the present "slash."

In a well-built automobile it is the labor that counts, and it is on the labor that the general expenses must be computed. In a general way the manner of fixing the cost involves items and mode of procedure as follows:

- (a) Labor, plus fixed charges.....54 per cent. (b) Material, plus cost of handling.....16 per cent. (c) Advertising, selling, delivering.....20 per cent. (d) Profit to the maker.....10 per cent.

In the item (c) is the profit to the "agency," and in the item (b) is the cost of the accessories as usually furnished by outside makers, thus involving a separate profit.

Even a cursory examination of the situation, taking into account the fact that the steel must be a small proportion of the total cost of a car, leads to a conclusion in which it will be impossible to see wherein a cut in steel can have any material, direct bearing upon the cost of automobiles, unless in the long run competition among the steel makers will result in an enhanced quality of the product, which, however, is a separate question.

What the automobile industry wants is an increased mileage of "good roads." There is the South to "tap"; the wide, wide West is crying to be opened up, and in our own East roads are much wanted. It will be many years before the question of the price of steel will have any substantial bearing upon the situation. In the meantime one good road, say from Atlanta, Ga., to Washington, D. C., would sell more cars than can be turned out in the plant of the greatest producer in the land at the present time in twelve months, under pressure such as would assure a "fat" lighting bill. Plainly, then, the automobile industry is not acutely interested in the price of steel, nor is this to be construed as indicating that "robber" prices should be paid for quality. In the meantime the agitation for good roads should go on because it is the great main question.

A WHITE FOR THE WHITE HOUSE.

NEW YORK, Feb. 22.—Ever since it was learned that autos would be used by the coming Chief Executive of the nation and would supersede the equines in the White House—no longer stables, now to be a garage—there has been considerable competition among the various manufacturers, and G. W. Bennett, Eastern manager of the White Company, is receiving the congratulations of his friends at his success in obtaining an order from President-elect Taft for a White car for his own use. The United States coat of arms is artistically painted on each of the doors, and the color choice is a little unusual, being a harmonious blend of subdued greens. The car has left the factory en route for Washington and will be delivered to the White House some time during the present week. Mr. Taft has been using the White cars in a number of cities he has visited.

The White Company is considerably gratified at the further endorsement by the United States of the White car, as the Eastern branch has recently delivered a White limousine to Gen. J. Franklin Bell, chief of staff, and a Model "M," seven-passenger White touring car to the War Department.

ATLANTA WANTS ROAD FROM WASHINGTON.

ATLANTA, GA., Feb. 22.—A good highway, stretching in a generally direct line of 700 miles, from Atlanta to Washington, D. C., kept up by the several counties in the various States through which the roads would pass, is now the subject of promotion on the part of the Good Roads Club of Georgia. The need of better roads is keenly felt throughout the South, and it is felt that if a good beginning is made that the work will rapidly progress.

The idea is to get each county to round up, roll and ditch one of its existing roads from border to border, and as soon as possible to chart, macadamize or otherwise permanently improve it. This action would give a through route from this city to the national capital, and the roads chosen in each county must be nearly in a direct line with the straight line between the two points. Several of the counties already have fine macadam roads, but it is probable that much of the distance would have the ordinary dirt surface for some time rolled and scraped with the wood drag.

The movement is backed by farmers and autoists alike, and with the co-operation of the organizations in the other States should meet with great success.

E-M-F SELECTED AS GLIDDEN PATHFINDER.

BUFFALO, Feb. 22.—Although the course for the 1909 tour of the American Automobile Association for the Glidden trophy has not as yet been publicly indicated, the first step toward definitely deciding just where the cars will be sent has been the selection of the E-M-F 30 as the official pathfinder for the route of the coming contest. Bids for this privilege were opened on February 16, and the Everitt-Metzger-Flanders Company was the highest bidder, its offer being accepted by the Contest Board of the A. A. A., of which Frank B. Hower, of this city, is chairman.

It is understood that Dai H. Lewis will be sent out earlier than usual this year because the western roads will permit it, but the probable route will not be announced for fear that hotelkeepers and others en route will be influenced to raise their rates.

HOTCHKISS TACKLES HIS HARD JOB.

ALBANY, N. Y., Feb. 18.—William H. Hotchkiss to-day assumed his new duties as State superintendent of insurance, taking the oath of office in the Secretary of State's office. Mr. Hotchkiss is the well-known president of the American Automobile Association, though it is among the possibilities that he may decide to relinquish that position because his new duties will call for most conscientious attention.

Mr. Hotchkiss was elected to the A. A. A. presidency in December last for the third time, and his administration has proven very successful.

A PIERCE-ARROW FOR WHITE HOUSE.

BUFFALO, Feb. 22.—Considerable self-congratulation has been indulged in, in this city, by leading business men during the past four days over the announcement that a Pierce-Arrow car will be included in the equipment of the White House garage, for the use of President-elect Taft and his family. A contract has just been signed by officials of the federal government and the Pierce-Arrow Motor Car Company by which a six-cylinder 48-horsepower suburban car will be delivered at Washington as soon as it can be finished. So far this is the only enclosed car which has been purchased for the use of the chief executive.

The main color of the car will be royal blue, with the door panels a rich russet and a single narrow strip of the same color following the lines of the moulding. Emblazoned upon the doors will be a facsimile of the great seal of the United States. The interior of the machine will be upholstered with blue broadcloth, and the fittings will be in the same style as those used in all Pierce suburban cars. This is true also of the exterior finishings, and it is expected that within a few days the car will be on its way to the White House for use at the inauguration.

PACKARD FOREIGN TOURING PLANS.

PARIS, Feb. 20.—After a brief visit to headquarters at Detroit, Manager H. D. Wilson has just returned to Paris and taken up duties at the new Packard branch at 177 Boulevard Pereire. The new offices of the Packard European touring department are centrally situated within two-minutes' run of the Avenue de la Grande Armée, the automobile avenue of Paris. Manager Wilson declares that arrangements have been made for carrying in stock all necessary parts of new and old models of Packard touring cars; thus any Packard part which may be required while touring in Europe can be forwarded within an hour of receipt of telegram. The call for parts is not great, the sales by no means sufficing to pay the expenses of the office. It is a great convenience to tourists, however, to be able to obtain spares for an American car in Europe, just as quickly as if the car had its home on this side of the Atlantic.

A record number of tourists is expected this year, and the information department has been revised and brought up to date to meet the demands which will doubtless be made upon it.

CARRIAGE CONCERN TURNS TO TRUCKS.

YORK, PA., Feb. 22.—Despite the fact that the York Carriage Company's plant is running overtime on orders for carriages, the company recently closed a contract for a new building, which will be used exclusively for the manufacture of commercial vehicles. This will be 200 feet in length by 50 feet wide and two stories high, but provision will be made for more stories in the future. The building will be of brick and ready for occupancy the first of May. The members of the company are convinced of the growing demand for power vehicles, and, although the carriage works will be continued, the commercial end will be pushed to the limit. Experts have been busy for some time on the design, but the details have not been announced. At the start employment will be given to over 100 men.

TRYING TO REVIVE BROOKLANDS.

LONDON, ENG., Feb. 22.—The first race meeting at the Brooklands track, which has just been announced, will be of interest to Americans because of the new track projected in Indiana, the latter being more or less of a copy of the famous oval.

The race meet announced will last two days and, coming as it does during Easter week, the sixteen events carded are expected to draw well. In the list of events two innovations are noticed, namely, the abandonment of the standard classes and the limit placed upon the stroke of the motor in three of the races. The latter will be watched very closely to see if it will have as much effect upon the industry as did last year's Four Inch Race.

NEW JERSEY'S SHOW IS ATTRACTING THOUSANDS

NEWARK, N. J., Feb. 24.—In the Essex Troop Armory, on Roseville Avenue, what answers as the automobile show of the State of New Jersey most successfully opened on Saturday night, had another bumper crowd on Washington's Birthday and has now settled down to a substantial daily attendance containing interested and willing buyers of cars.

It was George E. Reeve, president of the Newark Board of Trade, who "officially opened" the show in a very apropos speech, which pleasingly contained optimistic facts of the industry.

There are on exhibition some 75 cars, represented by 30 dealers, the list comprising top-notchers and the most reasonably priced cars produced. One new face in metropolitan showing is the Oldsmobile, the Newark agent of which displays, among other models, the latest one listing at \$1,200.

The decorations are of a very pleasing but simple nature, consisting principally of bunting, covering the rafters and draping

Considerable attention is given to the medium-priced cars, thus reflecting the modern tendency. Although the few larger and consequently higher priced machines attract their quota of people, the smaller cars are in the majority as far as mere numbers are concerned. Of these, in turn, by far the greater number come in the so-called "\$1,500 class," which would include all those listing at between \$1,250 and \$1,750.

The steam division is monopolized, as usual, by the White Company, which has one of the most prominent spaces as well as one of the largest. Here three of the latest model steamers receive much attention.

The Ellis Motor Car Company, the Pierce-Arrow agents in Newark, have the only car enclosed by a railing. This is one of the smaller Pierce-Arrow sizes, with a natty runabout body.

Motorcycles are not on view in any great quantity, owing to the smallness of the space available for them, but the few shown

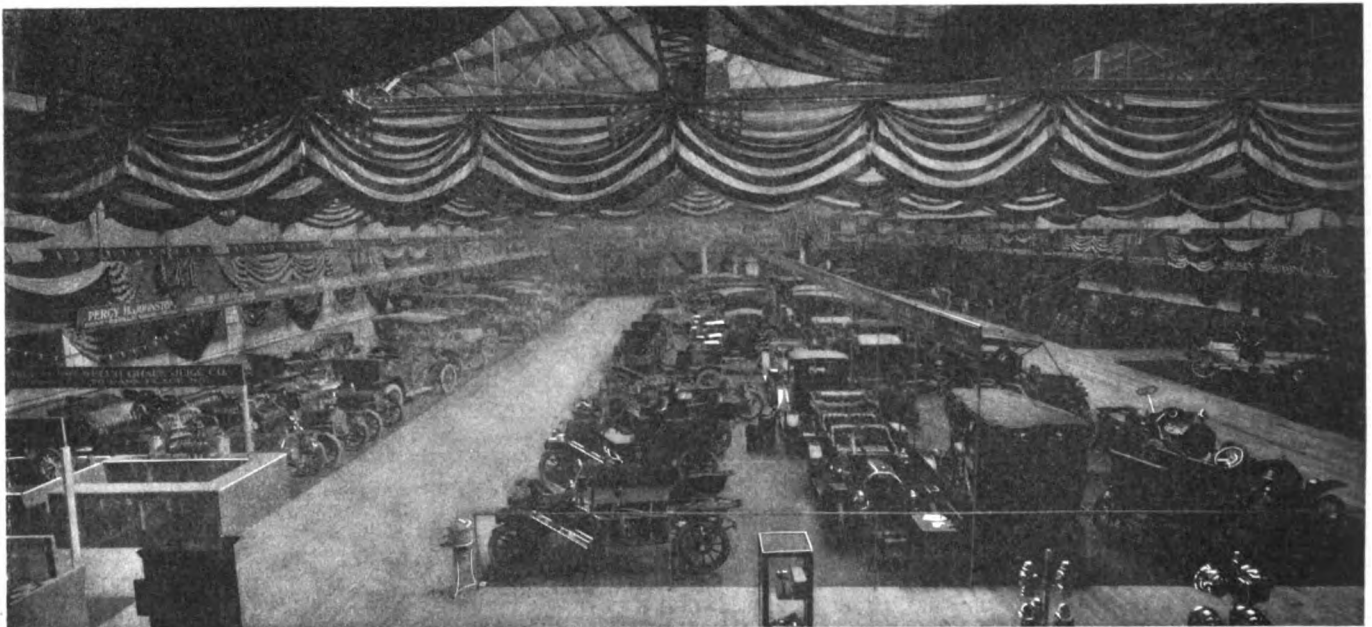

Broad, Roomy Aisles, Plenty of Space and Simple Decorations Characterize the Newark Automobile Show.

the balcony. In addition, a myriad of American flags, well scattered around, lent a patriotic air, as was very appropriate on Washington's Birthday. The show spaces themselves are the acme of simplicity, gaudy and glittering trappings being conspicuously absent.

This show, one of the very best of the smaller local shows, is conducted by the New Jersey Automobile and Motor Club and the New Jersey Automobile Trade Association. The committee in charge consists of George W. Paddock, president, and W. H. Ellis, secretary for the dealers, and Paul E. Heller, president, and H. A. Bonnell for the club. The latter has direct charge of the exhibition as general manager, and considerable credit is due to him and his capable assistants for their able efforts, which resulted in the work being completed so that the exposition was not only finished, but also opened on time, often unusual in the automobile show realm, and as pleasing as unusual.

Although spoken of as the second annual exhibition, this actually is the third that has been held. The first of these, however, was not an exclusive show, but simply a corner of a sportsman's display given up to a few automobiles. It is well to mention right here that the tail wagged the dog, so to speak, in that this little corner attracted more attention than the rest of the exposition. Since then the show has been a separate as well as an annual affair, held in a separate building.

win enough notice to more than make up for this. The growing popularity of this form of motive power, shown so plainly at other shows, is in evidence here, and each one of the few exhibitors is surrounded by a small but enthusiastic crowd at all times.

While the throng present at the opening was mostly a curious one, subsequently a great deal of serious business was done, so that all of the exhibitors express themselves as very well pleased with the amount of business being transacted, both on the opening night and thereafter. Many sales are being made, one peculiar fact about the first sale of the show being that it came at 4 o'clock in the afternoon, about three hours before the show actually opened. Thereafter sales followed steadily, and the demonstrating cars outside were kept busy at all times.

One feature of the show is the moving picture exhibit. Promptly at 10 o'clock the lights are turned out and an excellent series of pictures shown, including the Vanderbilt Cup, Savannah Grand Prize and other famous races.

The attendance has been excellent thus far, and, aided by special night programs on Wednesday, Thursday and Friday, the show bids fair to make a record that future shows may try for.

Several very important meetings are scheduled for the Thursday "club" night, when legislative and other important matters will be discussed by representatives of the Associated Automobile Clubs of New Jersey.

One of the exhibits attracting much attention is that of the Rickey Machine Company, East Orange, N. J., which is now directed by Mrs. Rickey, who has successfully continued the business since her husband was killed over a year ago in an automobile accident. Mrs. Rickey is thoroughly competent mechanically, and she has effected the sale of many Marmon cars in Newark and the surrounding country.

Herewith is the list of car exhibitors:

- Acme—Cordner, Flinn & Topplin, 76th street and B'way, New York.
- Brush—Brush-McLaren Motor Co., 47 William street, Newark.
- Cadillac—Motor Car Co. of N. J., 291 Halsey street, Newark.
- Chalmers-Detroit—Paddock-Zusi Motor Car Co., 215 Clinton avenue, Newark.
- Crawford—Mitchell Automobile Co., 282 Halsey street, Newark.
- E. M. F. (30)—H. J. Koehler Sporting Goods Co., 845 Broad street, Newark.
- Ford—Essex Auto Co., Inc., 518 Broad street, Newark.
- Flat—Flat Automobile Co., F. L. Apgar, Manager, Newark.
- Grout—P. H. Johnston, 9-11 Hill street, Newark.
- Isotta-Fraschini—J. M. Quinby & Co., 21-39 Division street, Newark.
- Jackson—Essex Auto Co., Inc., 518 Broad street, Newark.
- Kissel-Kar—Weldon & Bauer Co., 200-202 Halsey street, Newark.
- Locomobile—The Green Motor Car Co., 90 Washington street, Newark.
- Marmon—Rickey Machine Co., 92 Eaton place, East Orange.
- Maxwell—J. W. Mason, 350-352 Halsey street, Newark.
- Middleby—Middleby Auto Co. of N. J., 457 Washington street, Newark.
- Mitchell—Martin Auto Co., 284 Halsey street, Newark.
- National—Weldon & Bauer Co., 200-202 Halsey street, Newark.
- Oldsmobile—Oldsmobile Co. of New York, 88 Washington street, Newark.
- Overland—Overland Motor Car Co. of N. J., 16 Railroad place, East Orange.
- Peerless—Carl H. Page & Co., 237 Halsey street, Newark.
- Pennsylvania—J. M. Quinby & Co., 21-39 Division street, Newark.
- Pierce-Arrow—Ellis Motor Car Co., 124-126 Washington street, Newark.
- Premier—O'Neill Motor Car Co., 55 Bank street, Newark.
- Rambler—Rambler Automobile Co. of New Jersey, Newark.
- Regal—P. H. Johnston, 9-11 Hill street, Newark.
- Reo—O'Neill Motor Car Co., 55 Bank street, Newark.
- Stevens-Duryea—A. G. Spalding & Bros., 29 West 42d street, New York.
- Stoddard-Dayton—Atlantic M. C. Co. of N. J., 228-230 Halsey street, Newark.
- White Steamer—The White Co., 494 Main street, East Orange.

NEW YORK CARNIVAL PLANS MATURING.

Marked progress in the plans for the annual automobile carnival of the New York Automobile Trade Association, has been the result of active work during the past week of the committee in charge and the liberal support of the trade, financially as well as otherwise, has been secured. There was less of the preliminary work to be done this year because the ideas are generally understood and appreciated. Subscriptions to the fund for covering expenses have been in order and a number have been received, enough to show that the tradesmen are going to stand back of the committee. Further meetings of the committee will be held at short intervals until the festive week arrives, when all subjects of importance will be considered, to insure readiness at the proper time.

The increase of registration of automobiles at Albany after the festivities of last Spring has been considered as a conclusive proof of the value of such an event to stimulate interest not only in the city but also in the surrounding country and the consequent sale of cars. This is shown by figures secured from Albany, where previous to the 1908 carnival there had been a large decrease in the number of autos registered each month over that of the same months in 1907. After the carnival the increase is shown in figures which have spoken for themselves.

Month.	1907.	1908.	Increase or Decrease.
January	547	497	50 decrease
February	501	396	105 decrease
March	1,138	992	146 decrease
April	2,147	1,785	362 decrease
May	2,160	2,102	58 decrease
June	1,963	2,398	435 increase
July	1,662	1,868	206 increase
August	1,176	1,400	224 increase
September	907	1,313	406 increase
October	799	1,118	319 increase
November	600	761	161 increase
December	367	783	415 increase



Mrs. Rickey Presides Over the Marmon Exhibit.

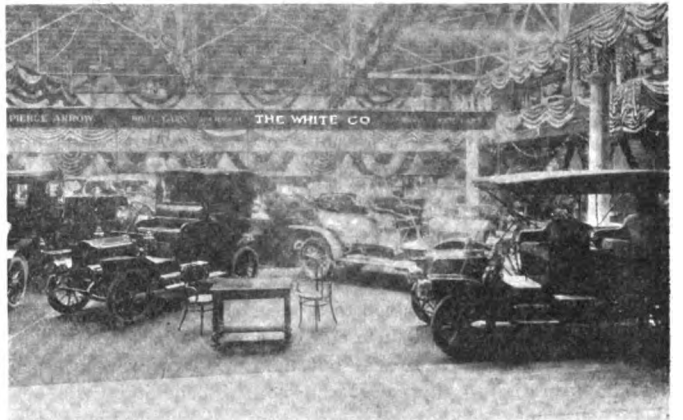

White Holds Forth at an Advantageous Corner.

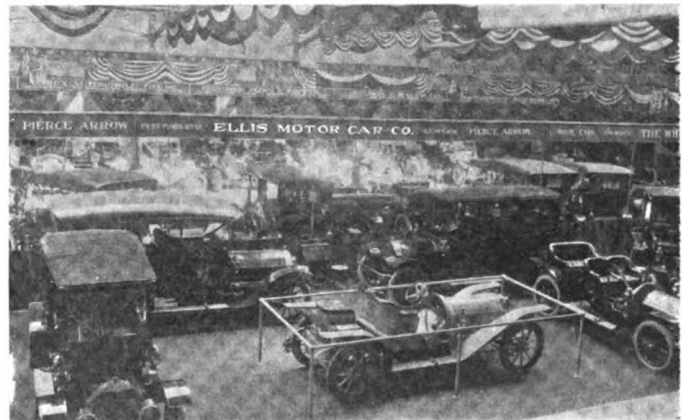

Ellis Gives the Honor Place to Pierce Runabout.

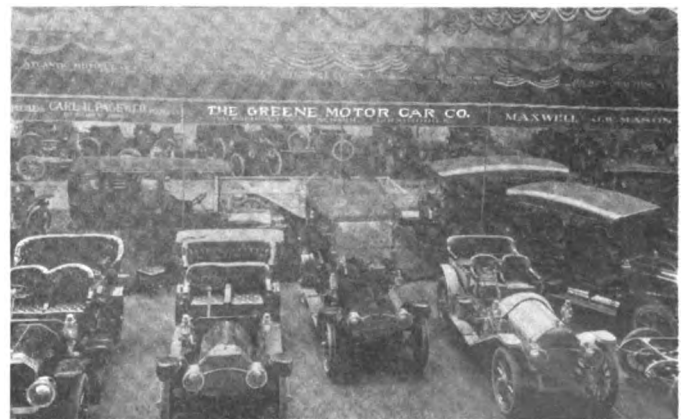

Representative Trio: Peerless, Locomobile, and Maxwell.



What a Famous Sculptor Conceived to Represent "The Spirit of Motoring."

This artistic effort, at the entrance to the Detroit Automobile Show, was set against a black background, and brilliantly illuminated. It is a work of art by Sculptor Wagner, and attracted so much attention that it is to be modeled in wax by the artist, and reproduced in gold by the Detroit newspapers and offered as a trophy for reliability contests.

FROM WHICH CAME "THE SPIRIT OF MOTORING"

By E. LE ROY PELLETIER.

DETROIT, Feb. 20.—When Sculptor Wagner, at the suggestion of the writer, essayed to model a group to typify "The Spirit of Motoring" he had little else on which to base a conception than the bare title. It was but natural therefore that the artist should fall into the common error of believing that the racing river—the sporting side of motoring—was typical of the industry. So, in his first miniature clay model the central figure was a racing chauffeur—low browed—the type of fellow who as a factory tester exhibits certain "dare devil" qualities, and as a consequence is given a chance at a race of greater or less importance. The kind of man who risks his life—because it is the only thing worth while he has to risk. It is his one chance to rise from the obscurity to which, save for accident, he is destined. If he wins he will be famous—fleeting though the fame may be. If he loses—well, he is still a \$3-a-day mechanic.

It wasn't Wagner's fault entirely that he had accepted this type of person as the personification of motoring. Every artist who has furnished figures for automobile shows has made the same mistake. I had given Wagner but a faint idea of what was in my own mind—and that idea was very faint in itself. Besides, an artist of Wagner's reputation and standing could hardly be expected to take so brief an event as a one-week automobile show very seriously. I felt sure the assignment was more or less of a joke to him.

But, artist like, he was visibly hurt and indignant when, on seeing his first model, I exclaimed, "Oh, no—no—that won't do at all." Then seeing I had been too brash, I continued in a milder tone, "It wasn't a racing driver I had in mind; not a figure steering a car, but one who is directing the destinies of an industry."

"Industry?" exclaimed Wagner. "Why, then, the idea of speed?"

"Because the automobile industry is the highest speed industry, the most spectacular commercial proposition the world has ever seen. Fortunes are made in a year—or lost as quickly. The failures are due to incompetence, but the successes are not accidental. Let this group represent something more serious; something of vastly greater consequence than all the dare devil drivers in the world."

Wagner had already modeled various types of drivers—all excellent. Supporting the upper basin of the fountain were heads typical of the foreign drivers, who, seated round a table, four or five of them together, the night before a race, each wagers with

the others that he will be killed on the following day. The wagers constitute a pot which, in the event of one of the party being killed, will go to his widow or family. On the bases of the columns he had given us another type of driver—the type whose skill consists of a certain negative appreciation of the dangers he risks—who has a meteoric career of a season and ends a heap of broken bones in a hospital—or just ends.

"Detroit is the center of the world of motordom," I continued. It became so, not by chance, but because there happened to be here certain men of wonderful manufacturing and commercial ability—men who could drive a business at a terrific speed, keeping always just ahead of a demand that was mushroom like in growth, yet never dare devil, never for a moment reckless or taking undue chances, though to the uninitiated wayfarer it might appear so. Our character has a firm grip on the wheel; on his brow sets intelligence; his eye is so clear that it sees farther into the future than most, and he is ready for anything that may appear in the road beyond the next blind turn. It may be a strike in the factory; or a financial panic such as a year ago cancelled thousands of orders. Overworking his capital to expand his young business, he yet must convince his bankers that he is steering a safe course. He must have speed, else would he soon be outstripped by his competitors in their chariots racing for fortune. But he drives not so much with daring as determination; steers not so much with his hands as with his head. The type of character I have in mind is—"

"Enough! I have it—I have it!" exclaimed the artist as one inspired. Grasping the miniature model he had formed, he dashed it into the mass of moist clay at his feet and feverishly began to model, as a child makes mud pies, another, the original of the group which has been so much admired during the week.

From that moment Wagner worked, not for his stipend, but for the love of the work. He is a true artist and he had an inspiration. It is from such material masterpieces are made. And it is not too much to say that this is a masterpiece. Destined originally for a brief life of six days, the group has created so much comment and been so highly commended by eminent authorities that the Publishers' Association of Detroit has decreed that it shall not perish with the show, but that Wagner shall reproduce it in miniature in the form of a gold trophy to be presented to the Detroit Auto Dealers' Association for their next reliability contest.

CONNECTICUT'S SHOW HELD IN HARTFORD

HARTFORD, CONN., Feb. 22.—Housed in the Armory of the First Company of the Governor's Foot Guard, with more brilliant and lavish decorations than ever before as a setting, strings of electric lights that throw a pleasing glow over the great hall, an electric fountain which spurts tiny jets of perfumed water into the air, and with all arrangements so completed that it was a perfected exhibition when it was ready to open, the second annual automobile show of the Hartford Automobile Dealers' Association was begun here on last Saturday evening, with twenty-three makes of automobiles, represented by thirteen different exhibitors.

When at 8 o'clock on that evening the doors were thrown wide, there had already gathered a large crowd, and when the interior was seen it was the general opinion that the promise of the show committee, F. W. Dart, S. A. Miner and E. G. Biddle, that it would give an event of which Hartford might be proud, had been lived up to, and this city feels that it has an attraction worthy of a metropolis.

The showing of cars is excellent and, considering the available space, very good use has been made of it. In fact, the same cars could be well displayed in a hall three times as large. Some of the best cars of the country are here gathered and the exhibition is representative. A few newcomers make their initial bow to the public and all, save for two or three, are shown on the ground floor and the stage. A large aisle runs through the center of the hall. To the right on entering is the exhibit of the Miner Garage Company, with the Pierce-Arrow, Knox and

Buick. The Knox is shown in two models, a red runabout and a silver gray touring car. The Pierce is also well displayed. On the opposite side of the aisle is the Mitchell exhibit, with the battered winner of the Hartford to Pittsfield endurance run of a few weeks ago. A runabout and two touring models are displayed. In the basement is another car of the same make fitted with a 'bus body for the Allyn House. The Thomas Flyer rubs elbows with the Mitchell and is present in several natty models in fours and sixes. A feature of the Thomas contingent is the six-seventy model, the largest in the show. The Thomas, Oldsmobile, Waverly electric, E-M-F and White steamer are shown by the Palace Auto Station Company.

Across the aisle the Packard 30 is shown in touring, landaulet and runabout types, natty and trim and much admired. Brown, Thomson & Company display the Packards as well as the Cadillacs and Stevens-Duryea. The Cadillac 30 polished chassis is a great drawing card. The Stevens models of fours and sixes are shown to good advantage. The Packard, Stevens and Cadillac exhibit is one of the most comprehensive of the show. Opposite the dark blue Packard 30 runabout is the low-hung American road in its glistening coat of white paint. This is the first appearance of the American, shown with the Maxwell and Stoddard-Dayton by R. D. & C. O. Britton. The Maxwell is shown in the \$500 models as well as larger powers, and the setting is very effective. The Stoddard-Dayton looks classy, and the crowd looks it over thoroughly. On the elevated stage the Ford is shown in two models.

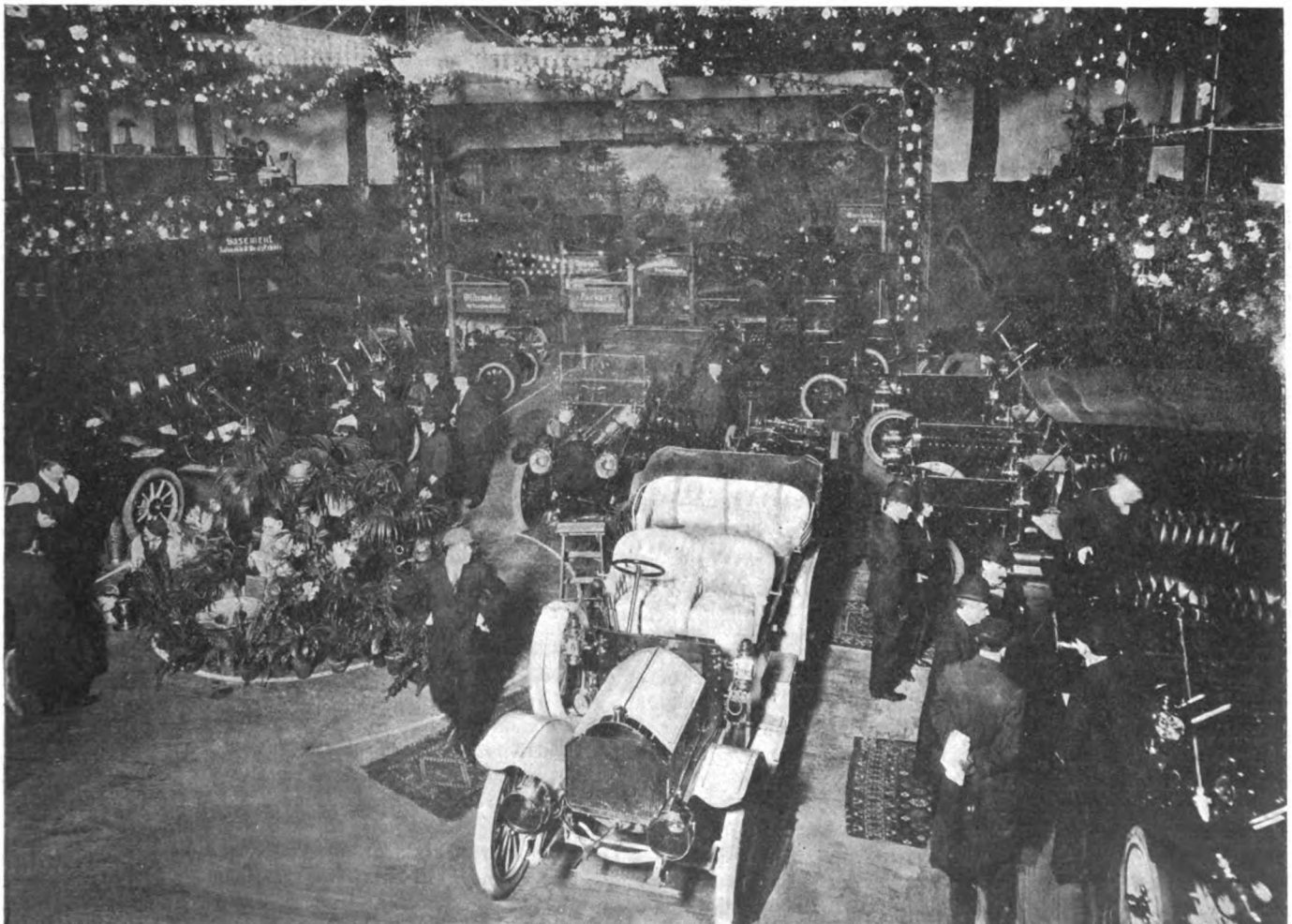

The Display of the Hartford Automobile Dealers' Association Had an Effective Setting in the Foot Guard Armory.

At the other end of the stage are shown two Overland runabouts. The Overland is popular in this city, and the local representative has sold many. To the right of the main entrance, in a side room by itself, is the Rambler exhibit. Two models are shown, and the Rambler in its short stay has become known as the car with the spare wheel. C. P. Rockwell and W. J. Wall, of the Boston branch, are at the show. The Rambler is not at present represented in this city. To the left of the entrance, adjoining the Mitchell space, is that of the two-cycle Elmore, a car which is becoming more favorably known each season here. Three models are shown, including a landaulet. In a room off the main hall the Franklin is shown in three models, the sole air-cooler here and a make that has many admirers. In the basement the Stanley steamer runabout is shown by W. J. Hickmott, Jr. This and the White are the only steam models shown. There are many steam enthusiasts in this city at this time, and naturally they look to cars of this class when they enter the hall. The White is shown in a touring model painted a dark red, with a big, roomy body. The Jackson is shown in two models by A. E. Lazzaro, for the first time in this locality.

A new car of local manufacture, the McCue-Hartford, is shown in a runabout model, and it looks to be a proposition that would have to be reckoned with on the road. The Jewel, another newcomer, is shown by J. A. Wood in two models, Stanhopes. The Simplex and Palmer and Singer were to have been shown by T. Dudley Riggs, but unfortunately Mr. Riggs could not secure his cars in time for the exhibition. The Atlas was to have been shown, but was unable to get cars through in time.

The show will continue until next Saturday evening. On

Thursday evening the Dealers' Association will hold a banquet at the Allyn House at which Governor Lilley and Mayor Hooker are expected to be present. This is the list of exhibitors:

Palace Automobile Station Company, Thomas Flyer, Oldsmobile, E.-M.-F., White Steamer and Waverly Electric.
Miner Garage Company, Pierce Arrow, Knox and Buick.
R. D. & C. O. Britton, American Roadster, Maxwell and Stoddard-Dayton.
Brown, Thomas & Co., Packard, Stevens-Duryea, Cadillac.
Capitol City Auto Company, Mitchell.
Dunbar & Mansir, Elmore.
Elmer Automobile Company, Ford.
W. J. Hickmott, Jr., Stanley Steamer.
Thomas B. Jeffery & Company, Boston, Rambler.
McCue Company, McCue-Hartford.
A. W. Peard, Overland.
J. A. Wood, Jewel.
A. E. Lazzaro, Jackson.

Ætna Life Insurance Company, liability insurance.
Travelers' Insurance Company, liability insurance.
Alling Rubber Company, tires, tubes, etc.
Fairbanks Company, marine motors.
A. L. Foster & Company, motoring apparel.
The G. W. Fuller Company, trunks, bags and trunk racks.
Hartford Auto Parts Company, auto parts.
Hartford Mill Supply Company, supplies.
Hartford Times.
George S. Maslen, Indian motorcycles.
Perfection Wrench Company, wrenches.
James Pullar & Company, motor-car metal and wood bodies.
Post & Lester Company, tires, tubes and accessories.
Tracey, Robinson & Williams Company, marine motor supplies.
Smith, Worthington Company, motoring accessories.

BUFFALO SHOW WILL BE ELECTRICALLY BRILLIANT

BUFFALO, Feb. 22.—Buffalo's automobile show, which will open March 2 and continue for a week, promises to eclipse anything of the kind ever attempted before in this city. It will be the first show given exclusively under the auspices of the Automobile Club of Buffalo and may be the last so conducted, since W. C. Jaynes, president of the local trade association, has hired Convention Hall for another year with the avowed object of holding next year's show under the auspices of the association. And since it is admitted that there is not room for two shows, the Automobile Club knows that there will be opposition to its conducting the 1910 exhibition.

The determination to make the coming one excel everything before, and worthy of the largest club of resident members of the A. A. A., has stimulated the management to produce results. The decorations are the most elaborate ever attempted in the city, scarlet and gold being the dominant colors. The hall will be illuminated with 5,000 incandescent lamps in the ceiling, divided into twelve squares. Lack of space will limit the show to about one-third of the exhibitors who applied.

The list of exhibitors numbers 40 and includes the following: Centaur Motor Company, Austin Lyman Company, Fargo Electric Carriage Company, Meyer's Carriage & Wagon Company, Brunn & Company, The George N. Pierce Company, John W. Frey, Kane Motor Supply Company, Louis Engel, Jr., Ralph E. Brown Motor Car Company, Brunn Carriage Manufacturing Company, W. R. Densmore, J. A. Cramer, F. G. Crone, C. H. Bicalky, Knoll & Tuereon, C. E. Miller, Theo. P. Meinhard, F. Z. Phelps, E. H. McCormack & Sons, Harry P. Brainard, American Motor Truck Company, Leo Wertheimer, Poppenberg Motor Car Company, E. E. Denniston & Company, Maxwell-Briscoe Buffalo Company, Frank C. Garvin, Dixon Bros., Iroquois Rubber Company, E. R. Thomas Motor Company, Buick Motor Company, Mason B. Hatch, Buffalo Automobile Garage, Buffalo Automobile Exchange, Babcock Electric Carriage Company, Co-Operative Motor Car Company, National Welding & Manufacturing Company, Jaynes Auto Supply Company, Class Journal Company, H. D. Taylor & Company, W. F. Polson.

SYRACUSE PLANS AN AUTO SHOW IN MARCH

SYRACUSE, N. Y., Feb. 22.—Preparation for an automobile show to be held during the last week in March, probably under the active guidance of Dai Lewis, of Buffalo, is the result of the formation in this city last week of the Syracuse Automobile Dealers' Association and a number of meetings which have been held to consider matters of local importance.

Opening on Wednesday, March 24, and continuing until Saturday evening, in the State Armory, with space available for all local dealers and any others in the western part of the State, is the plan which has been decided upon. Mr. Lewis has been invited to come to Syracuse to take charge of the arrangements after he has finished with the Buffalo affair.

The trade association has been formed to hold several annual automobile events—the show, a hill climb, an endurance run, and some races on the Fair Grounds track, in addition to giving an organization which will endeavor to aid auto affairs in all lines of activity. The officers as elected are: President, C. Arthur Benjamin; vice-president, H. D. Van Brunt; secretary, M. W. Kerr; treasurer, H. L. Conde, and C. H. Norris to act as a fifth member in forming an executive committee.

The charter members are: M. W. Kerr, Buick; C. A. Benjamin, Packard and E-M-F; H. D. Van Brunt, Oldsmobile; Genesee Motor Car Company; Taxicab Garage Company; Amos-Pierce Company; Leon Coude, Brush; and George Wilcox, Mora.

CLEVELAND'S SHOW IS A RIOT OF COLOR

CLEVELAND, Feb. 22.—The 1909 automobile season opened in this city to-night, when the seventh annual show made its bow to the citizens of Northern Ohio. Yet one building being unable to hold all the machines, the Locomobile, Babcock electric and Regal representatives are giving an overflow show in the Hollenden Hotel, while the Mora, Reo, Premier and Overland people are holding private shows in their own salesrooms.

The Central Armory, where the show is being held, is dressed in a manner never before attempted. A riot of color greets the eye, for the general effect is that of an Italian garden, with thousands of flowers twined here, there and everywhere. Bowers of roses, illuminated with colored incandescents, are on every side, with a faint aroma of natural flowers scented the air. At each end of the huge building is an electric fountain, where water plays over hundreds of lights, constantly changing their color. A huge searchlight flashes forth from each corner of the building, shifting back and forth, picking out brilliant dashes of color. The effect produced is something unrivalled in automobile shows in this country. Whether it is not too elaborate is another question, but at any rate the decorations have caused so much stir locally that the attendance bids fair to exceed that of any previous year by many thousands for the week. A few of the exhibitors claim that the attention of the crowd will be paid principally to the beauty of the show and not to the machines.

Cleveland is one of the best retail fields in the country, and local tradesmen are hustling for business this year as never before. Many purchasers have held off giving their final order until the show, while many buyers from nearby towns come into the city with the agents to make final decisions. Considerable business in the moderate-priced car class is done by the State representatives, so that the Cleveland show is something more than a mere local exhibition.

There are many new cars in the local field this year, the increase being more than usual. Among others, the Babcock electric, Locomobile, Pierce-Arrow, Woods, Waverly and Detroit electrics, the Regal, Pope-Toledo, American Simplex, Midland, E-M-F and Cameron made their formal debut this week, while it is expected that one or two other agencies will be placed during

show week. One of the features of the show is the large number of electrics shown. Not all could secure space at the show proper, so private exhibitions are very common. Cleveland ranks as the leading city in the country for electrics, and it is not surprising to see a great influx of these graceful cars. There are now eight makes sold here, namely, the Baker, Rauch & Lang, Broc, Columbus, Babcock, Woods, Waverly and Detroit. The first three are manufactured in this city. All except the Woods and Babcock are being exhibited at the show, the others in their own salesrooms.

The following is the list of the exhibitors:

The Auto Shop Co.....	Thomas and Selden.
Buick Motor Co.....	Buick.
Barger Automobile Co.....	Cadillac.
Broc Carriage & Wagon Co.....	Broc electric.
Cameron Auto Co.....	Cameron.
Commercial Car Co.....	Pope-Toledo.
Chisholm & Phillips Auto. Co.....	Stevens-Duryea.
Crawford Motor Co.....	Jackson.
Detroit Electric Co.....	Detroit electric.
Elmore Motor Car Co.....	Elmore and Waverly electric.
Ford Motor Co.....	Ford.
Gaeth Automobile Co.....	Gaeth.
Hall Bros.....	Cartecar and Plymouth.
Lucas & Christenson.....	Mitchell.
Jewel Motor Car Co.....	Jewel.
Harry S. Moore.....	Stoddard-Dayton and Brush.
Maxwell-Briscoe Motor Co.....	Maxwell.
Oldsmobile Co.....	Oldsmobile.
Peerless Motor Car Co.....	Peerless.
Pullman Motor Car Co.....	Pullman.
Price Bros. Carriage Co.....	Baker electric.
Reese Motor Car Co.....	Royal, Corbin, and Columbus electric.
Rambler Automobile Co.....	Rambler.
Rauch & Lang Carriage Co.....	Rauch & Lang electric.
Standard Automobile Co.....	Packard and Franklin.
Studebaker Automobile Co.....	Studebaker and E-M-F.
Charles B. Shanks Co.....	Chalmers-Detroit and Stearns.
Winton Motor Car Co.....	Winton.
Wingle Motor Car Co.....	American Simplex and Midland.
The White Co.....	White.

In the local retail trade a number of new agencies have been placed. The Western Reserve Motor Car Company was organized to handle the Pierce-Arrow, Knox and Woods electric. The Elmore Motor Car Company has taken the Waverly electric agency; Stahl, Hoffman & Company that of the Locomobile; the Commercial Motor Car Company to sell Pope-Toledo, and the Wingle Motor Car Company to sell the American Simplex and the Midland.

BIG FRENCH MAKERS WILL OPPOSE ANNUAL SHOW

PARIS, Feb. 20.—French constructors, or at any rate, the élite of them, are opposed to an annual automobile exhibition. The Automobile Club, the small constructors, tire makers, accessory manufacturers and dealers are in favor of continuing the show in the Grand Palais. Hence, if not exactly a war, at any rate a state of dispute. With the object of strengthening their position, the anti-show men recently visited London to attempt to convince John Bull that his Olympia show was a vain thing and should either be abolished altogether or held on every other year, alternating with the necessary evil in Paris. But automobile John Bull has an idea that if the Paris Salon were abolished London would become the motor mart of Europe, and while he sympathized with the Frenchman, he gave him no hope whatever that his show would be closed down.

In face of this set-back the French constructors conferred and came to the decision that not only would they still oppose the Paris Salon, but they would band themselves into an association sacred to big, anti-show constructors, where it would be impossible for the tire potentates and host of accessory men to outvote them.

The situation at present is, therefore, that 60 per cent. of the French constructors, comprising all the large world-famed firms, are opposed to sending any of their products to the Grand Palais; the club, backed up by small makers and accessory interests, is determined to continue a display that has always been a source of

profit. The club will go ahead with its show, which will doubtless be held at the end of November and the beginning of December, in the Grand Palais. Deprived of the big constructors, they will admit aeroplane and dirigible balloon manufacturers, motor boats, commercial vehicles, cycles and all accessories.

A mixed show of this nature can be made a success, though of course it will have nothing of the éclat of some previous exhibitions. The aeroplane section alone is sufficiently powerful to fill nearly one-half the hall, and the rest of the space will be none too large for the automobiles, accessories, etc., which will ask admittance. Probably, in view of the determination of the club to hold the Salon despite the opposition of the big makers, these latter will be obliged to climb down and ask to be taken in also. It is practically certain that a certain number of them will break away if the show is persisted in, for the bond under which they have placed themselves is not one that is likely to be upheld by law.

It is interesting to note that the anti-show group is also the anti-racing party; but, while the big manufacturers monopolize the Racing Board, they only form a fraction of the club committee dealing with the Salon, and are also in a minority on the Manufacturers' Association, which unites with the club for the holding of the show. This explains why, after killing the Grand Prix with the utmost ease, it is somewhat difficult to stifle the annual Salon.

DENVER HAD A BIG SHOW SUCCESS

DENVER, Feb. 22.—In the great Auditorium, large enough to hold the biggest conventions and giving space for over 150 automobiles, for three days of last week, Tuesday, Wednesday and Thursday, Denver's annual automobile show was held under the most auspicious circumstances, both from viewpoints of attendance and the general interest worked up through the city and surrounding country by it. This year marked the entrance of the Denver Motor Club into the field as a promoter of an automobile exhibition, and those who participated by having exhibits or by attending gave voice to opinion that the event was surely a great success.

Of the 56 exhibitors, 27 were dealers in automobiles, while the remaining ones handled accessories or special exhibits. One

and Frayer-Miller, and at the right the Moon and Rauch & Lang Electric.

Proceeding to the center aisle, on the left was the Cadillac and opposite it the Fritchle electric, then the Ford, the Packard, the Maxwell, Buick and others. The whole floor was divided into two sizes of spaces, a large and a small, the large ones being taken to show the Mitchell, Rambler, Stevens-Duryea, Pierce, Chalmers-Detroit, Jackson, Matheson, Stoddard-Dayton, Cadillac, Studebaker and E-M-F, and the Thomas, Oldsmobile and Columbus electric. Smaller spaces were occupied by the Velie, Welch, Colburn, Maxwell, Apperson, Packard, Buick, Overland, Baker, Ford and Fritchle representatives.

The Studebaker Company was the only one showing a com-

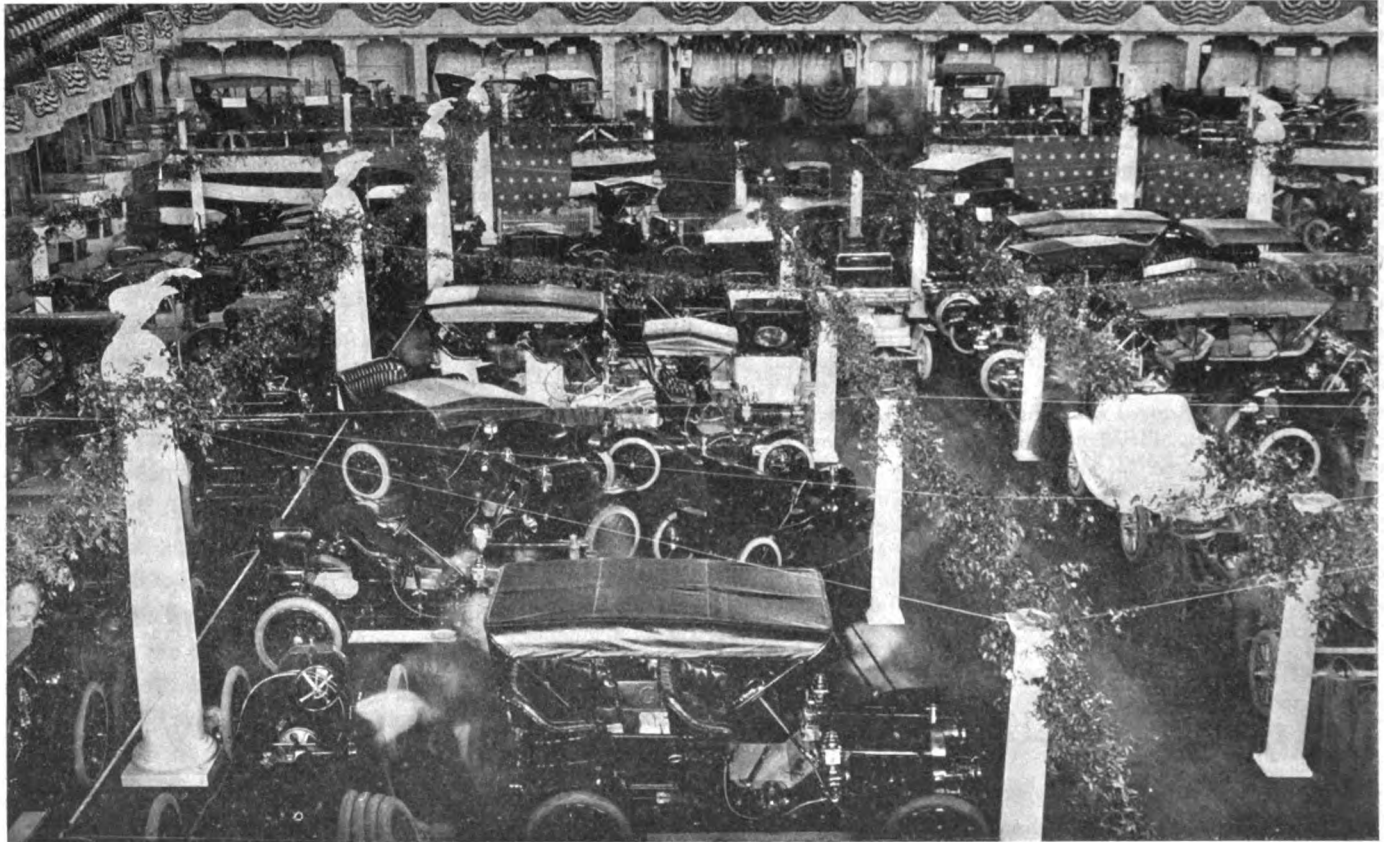

Denver's Great Auditorium Supplied a Commodious Building for the Motor Club's First Show.

hundred and fifty cars were on the floor and represented 39 different makes. Fifteen thousand square feet of floor space was available for use in the main section, and a hallway, extending around the entire building, and 15 feet wide, gave additional room, not only for exhibitors, but also for a wide aisle.

A beautiful decorative scheme was worked out by Denver artists, so that the whole building was transformed into a bower of novel and striking nature, forming a gorgeous setting for the big and little cars and making a contrast between the beautiful colors more pronounced. A prominent band gave concerts in the afternoons and evenings, with soloists to lend additional interest.

On entering the big hall the passageways took the visitors first through the boxes, where were accessory exhibits, and then out into the main hall itself. At the right of the entrance were the models of the new Reo cars, both single and double cylinders, fitted with runabout and touring bodies, and on the left was the space containing the Oakland and the Kissel Kar. In the same tier, at the right and beyond the Reo, were the Dorris

commercial vehicle. In an annex there were shown the White, Midland, Speedwell, Sterling, Model and Victor. A number of motorcycles were shown by local dealers, while among the accessories shown were articles for every conceivable want of an autoist.

Social events marked the week of the show, banquets and smokers being held by club members, some of which were booster meetings for the show. These made the affair almost a social and society event and added greatly to the success attendant upon it.

The Denver Aero Club prepared a special exhibit, the huge tube for the Cage aeroplane being completed in time to have it suspended from the dome of the Auditorium, overhanging the main floor, so that it was seen from all parts of the house. On Thursday evening, the final session of the show, an airship flight was made by George Uber, a Denver engineer, with an airship of his own invention. Denver claims the distinction of having the largest number of automobiles in proportion to its population of all the cities of the country.



FOLLOWING a custom in the best regulated households, coupled with the opening of a number of new buildings and the vacating of others, spring house cleaning along the metropolitan automobile row this year has accounted for a number of changes in location, in equipment and in general appearances. There has been a tendency toward moving uptown along Broadway or of taking up quarters on intersecting streets just off the main thoroughfare, and as it is still early in the extensive selling season it is to be expected that still more alterations in the row will happen later.

An important cause of a number of removals has been the opening of a large, splendidly planned building erected just for the automobile business on the block extending from Sixty-fourth to Sixty-fifth Streets, on Broadway, with all manner of conveniences for the successful handling of the trade, and as soon as it was opened a number of concerns took up space there. This at the same time emptied a number of other places lower down the row and other concerns moved in to fill the vacancies.

Still another building was opened at Sixty-eighth and Broadway and was promptly occupied by automobile agencies and the general trade. Both these new buildings are suitable for the use to which they have been put, especially the large one lower down the row. It was so built that there are entrances for cars on both of the numbered streets, and a runway extends through at the rear of the offices and show rooms, with large sliding door entrances to them. Two big elevators carry the machines to upper floors, where practically the same plan has been carried out of having the various sales rooms connected by a wide hallway. Passenger elevators are in the front of the building for use in reaching the upper floors.

One of the first concerns to take rooms in this structure was the Maxwell-Briscoe Company, under the direction of Col. K. C. Pardee, which took the two large quarters on the first floor at the upper corner, so that there is room for offices, plenty for show space and a large room for storing new cars for delivery or for use as a garage for the demonstrating cars of the company. Col. Pardee has already moved in from his former location on West Fifty-ninth, near Columbus Circle. The official numbers of the Maxwell branch are 1930 and 1932 Broadway, and as yet no one has engaged the vacated building. When the importers of the C. G. V., in short for Charron, Girardot et Voigt, moved into the building, taking office rooms on the first floor at the Sixty-fourth Street side, and with nearly the whole fifth floor for show, garage and storage purposes, they vacated their former offices between Sixtieth and Sixty-first, and the Morgan & Wright branch took that. The C. G. V. cars are for a time being shown in the corner room of the first floor, but this is only temporary.

Under the management of George Jordan, the Cameron Car Company's branch was opened at No. 1928, just above the entrance to the passenger elevator hallway and next to the Maxwell branch, in a large, rectangular-shaped room. On the other, lower, side of the elevators the Atlas branch took a position, under the management of L. F. Johnson, having moved from No. 1876 Broadway, and now having headquarters similar to those of the Cameron. Both are well and favorably located.

Since the Grand Central Palace show the National cars have been represented in this city by a direct factory branch, with W. C. Toertner as manager, and headquarters were taken at No. 1922, near the Sixty-fourth Street side of the new structure. A number of the newest models of this Indianapolis concern are in the show rooms. On one of the upper floors the Allen Auto Specialty Company is located, completing the list of the present occupants of the building, but it is well understood that as there is considerable room still available a number of the tradesmen are looking at space both on the ground and upper floors. The site is good, and the vacancies will be rapidly filled.

Further up the row, at Sixty-eighth, Harry S. Houpt is about to open his show room and offices for the sale of the Herreshoff, and later the Houpt cars, but pending alterations the cars are being shown in the Hotel Marie Antoinette and the offices are divided between Mr. Houpt's headquarters for the sale of Thomas cars and the new office space. With him in this building are the recently opened factory branch of the Speedwell Motor Car Company, with John Tugby as manager, and the selling branch for Dow tire tubes.

Previous to the move of the C. G. V. Import Company and the subsequent transfer of the Morgan & Wright tire makers' branch to the former C. G. V. place of business at 1849 Broadway, these tires had been represented in a building a few doors off Broadway, on Forty-seventh street, but the necessity for more space required that a change be made and the branch was moved further uptown.

Of distinct importance will be the change soon to be made by the Lozier Motor Company, which, although it moves but a block, will have a building of its own and nearly four or five times as much space as it now occupies. At present it is located at the corner of Fifty-fifth Street and Broadway, in a building which is large, but so subdivided that the Lozier interests get but a small portion of it. There are four floors and a basement, but the area of each is not sufficient to make a large whole. When the Rainier Company gave up its building one square above, at Fifty-sixth, the Lozier Company took it. The five floors and basement are so much larger in size that the firm will have plenty of space, for it is more than a factory branch or a selling agency, for it is really the general office and head of the factory and its extended interests.

The general offices of the Lozier Company, with its factory at Plattsburg, will have the entire third floor of the new building, with private offices for the members of the firm and space for the selling and clerical forces. The first and second floors will be set apart for sales and show rooms, with plenty of room for new cars of all models and body style, and at the rear of the first floor will be room for the desks of the retail selling force. The basement will be used as a garage for the demonstrating cars of the company, the fourth floor given over to the second-hand department and the fifth and top floor to the shop and stock room. By the first week of March the renovated building will be occupied, and it is understood that the Buick branch, which is also cramped for space in the same building with the Lozier at present, will consolidate the whole building as its own branch.



Coyote Catching in Colorado with a Stevens-Duryea.

CHASING THE COYOTE WITH AN AUTO.

In all automobiledom there is no more enthusiastic hunter than C. C. Hildebrand, sales manager of the Stevens-Duryea Company, who finds time between selling cars to enjoy his favorite sport. Recently Mr. Hildebrand was in Colorado, and with a party which included Mr. Maxwell, of the Felker Automobile Company, George McGuire, and Mr. Petrie, owner of a pack of grayhounds, drove some 18 miles out of Denver in pursuit of coyotes. In this manner "Hilde" tells the result:

"The first coyote we got within 150 yards of by encircling around it, not driving directly toward it, for this will scare them, and then we opened the tonneau door and let the four dogs out. Then we tried to keep up with the car, at times going 30 miles an hour. To say it was exciting, is putting it mildly. The dogs caught the coyote and stretched him out like a blanket, and we had quite a time breaking them loose. We then waited a few moments to give the coyote a chance to catch his breath, and then turned him loose to have another race, at the same time trying to get a photograph of dogs and coyote on the move. When the picture was developed all it showed was an open prairie and the coyote in the air, his hind legs forward and his front legs between backwards, with no dogs in sight. He pretty nearly got away from us, but we finally caught and skinned him. We caught two more within an hour and a half. The usual method of hunting coyotes is with a horse, so you can imagine how very exciting it is when you are driving in a car at 30 miles an hour over the open prairie, bumping over prairie dog hills and badger holes."

A FAIR DAY'S WORK FOR A FAIR DAY'S PAY.

That a taxicab comes under the rule is a fair assumption, and it is reasonable to consider that a first-class car will do more and better work for the "fare" than will be the outcome if the car is below a certain standard. In England the question is being agitated quite some; the question of the "tariff" considering the quality of the car, in any given case, and S. F. Edge, whose habit of pointedly discussing automobile subjects, takes a hack at the project in the manner, as follows:

1. There should be cheaper fares than at present for single-cylinder cabs and possibly two-cylinders, and the present fares should apply only to four or more cylinder vehicles.
2. Each type of vehicle should be clearly indicated by large figure in front of bonnet, showing number of cylinders.
3. That every taxicab should be painted the same color. I believe post-office red would be the best.
4. That each separate company should be marked with some clear distinguishing mark so that the cabs of the different companies could be identified by would-be fares.

CALIFORNIA AUTOING IN FLOODTIME.

STOCKTON, CAL., Feb. 15—The people of California have long been appreciative of the automobile, but not until this Winter have they fully appreciated it as a life boat. Not in forty years has California had such a flood as has been experienced this Winter. In many sections the land was inundated, and the streets of a number of cities and towns were veritable canals. The rise of the water was so rapid that it was often necessary for those in the towns to send automobiles out into the surrounding country to provide a means of escape for the people whose homes were located in outlying districts. Live stock often stood up to the body in the swirling water, a great deal of which was extremely cold; it being the snow from the hills, which had melted and run into the rivers and creeks.

Stockton was probably the city that suffered the most from the flood. With a population of 21,000, it is sixty-three miles northeast of San Francisco, at the head of the Stockton channel, which is a wide and deep arm of the San Joaquin river. The city is termed the "Slough City" on account of the tendency to marshland of the country outside the main portion of town. The business of the section consists chiefly in furnishing supplies to the farmers of the San Joaquin valley, and in the shipment of wheat, wool and mining produce. It also has a number of iron foundries, tanneries and various manufacturers, as it is considered a good harbor, and the steamers are able in the Winter and Spring to navigate 200 miles above the city.

On one side of Stockton is the channel, while a creek flows along the boundary line on the other side. This Winter both streams became so swollen that the river broke through the levees and the creeks overflowed, making the city navigable by little else than boats. It was here that the motor car came to the rescue. Day and night it was used to transfer people and property to higher and dryer quarters.

The accompanying photographs show C. Skinner, of Stockton, in his Mitchell runabout. Mr. Skinner was almost constantly in his car plowing through the water up to the bed of the vehicle in many places. He says his car served faithfully, and did its share toward the alleviation of such suffering as was caused by exposure to the cold and dampness, even in several cases just arriving in time to rescue persons in the greatest danger of drowning. Care had to be exercised, of course, to prevent water from reaching the carbureter or the ignition system. Both were protected somewhat, for the occasion, by use of waterproofing.

Stockton has always, or for sometime passed, felt very favorably toward the motor car and has a goodly number of vehicles in her city, but it is stated that since the experiences of these last few days, the sympathy of everyone is to advance the popularity of the automobile.



Mr. Skinner Rescuing Flood Sufferers in His Mitchell.

NEW ORLEANS RACE MEET SUPPLIES SOME SPORT

NEW ORLEANS, Feb. 22.—Ralph DePalma in his Fiat Cyclone, Mrs. Joan Newton Cuneo in the Knox Giant, and Robert Burman in his underhung special Buick were the star performers in the three days of automobile racing held in this city on Saturday, yesterday, and to-day, upon a one-mile circular track, in connection with the annual Mardi Gras celebration. Records for 10 and 100 miles were broken and fast time made by these three, with George Robertson in a Simplex, Louis Strang in an Isotta, and "Jimmy" Ryall in a Matheson as runners-up.

Although there were few entries for the various events, that drawback was made up in the quality of those who were here and in the time which they recorded. The track was in perfect condition and the attendance was splendid, averaging 10,000 on each of the three days. There was a noticeable lack of accidents, although Ryall was in one serious mix-up, in a short distance event on Sunday, when he steered slightly too wide at the beginning of the turn into the stretch, and, losing control of his big Matheson, flying along at a mile-a-minute rate, crashed through the fence. The car was demolished and it was considered remarkable that Ryall and his mechanic escaped without injuries that were worth mentioning.

The meet opened auspiciously on Saturday, when DePalma lowered the record of 9:12 3-5 for 10 miles, held by Barney Oldfield, to 9:11 2-5, in a handicap race where he defeated five competitors, although he started on scratch with a minute to make up. Ryall was second, 50 seconds behind, and George Robertson third. Mrs. Cuneo then took the center of interest as she flew around the circuit in the big Knox car, and lowered her own five-mile time, the record for women drivers, from 6:04 3-5 to 5:05 2-5. Mrs. Cuneo showed great skill in taking the turns at high speed, and for the first 18 miles of the 50-mile race, the feature of the day, she kept up to the flying Fiat. The 50-mile race was won by DePalma in 51:37 4-5, with Mrs. Cuneo a minute behind, and Robertson third.

On Sunday, Burman made his world record run in the 100-mile free-for-all, lowering the record of 1:53:21 4-5 held by Clemens in a National in 1905, to 1:42:39 2-5. The breaking of this record alone would have drawn great importance to the race meet. The other events of the day were at short distances and relatively unimportant. Mrs. Cuneo lowered the women's one-mile record to 1:00 1-5, better by 2 1-5 seconds than the previous record.

To-day, the last of the speed carnival, was featured by another 50-mile event, which was won by DePalma again, his time being even faster than on Saturday, 49:52 2-5. Mrs. Cuneo

drove her Knox five miles in 5:05, a new mark for women drivers. The summaries of the important races are as follows:

Saturday, February 20.

FREE-FOR-ALL, MILE TRIAL FOR WORLD'S RECORD.		
1. Flat Cyclone	De Palma	:54 1-4
2. Matheson	Ryall	1:01
3. Simplex	Robertson	1:01 3-5
4. Knox-Giant	Mrs. Cuneo	1:02 1-5
50 MILES, FREE FOR ALL.		
1. Flat Cyclone	De Palma	51:37 4-5
2. Knox-Giant	Mrs. Cuneo	52:40 3-5
3. Simplex	Burman	
10 MILES, FREE FOR ALL.		
1. Flat Cyclone	De Palma	9:11 2-5
2. Simplex	Robertson	
3. Isotta	Strang	

Sunday, February 21.

10 MILES, FREE FOR ALL.		
1. Flat Cyclone	De Palma	10:03 2-5
2. Simplex	Robertson	10:06
3. Buick	Burman	
10 MILES, OPEN TO ALL STOCK CARS.		
1. Knox-Giant	Mrs. Cuneo	10:12 1-5
2. Packard	Donnelly	
100 MILES, OPEN TO STOCK CARS.		
1. Buick	Burman	1:42:39 2-5
2. Robertson	Simplex	

Monday, February 22.

5 MILES, FREE FOR ALL, STOCK CARS.		
1. Buick	Burman	5:40
2. Jackson	Scheffler	
5 MILES, FREE FOR ALL, STOCK CARS.		
1. Simplex	Robertson	5:07
2. Buick	Burman	
3. Knox-Giant	Mrs. Cuneo	
5 MILES, STOCK CARS, AMATEUR DRIVERS.		
1. Knox-Giant	Mrs. Cuneo	5:15 2-5
2. Packard	Donnelly	
3. Jackson	Scheffler	
10-MILE HANDICAP, FREE FOR ALL.		
1. Flat Cyclone	De Palma	9:12 1-5
2. Knox-Giant	Mrs. Cuneo	
3. Simplex	Robertson	
4. Isotta	Strang	
5. Buick	Burman	
50 MILES, FREE FOR ALL.		
1. Flat Cyclone	De Palma	49:52 2-5
2. Isotta	Strang	
3. Simplex	Robertson	

APPERSON WINS ON PACIFIC COAST.

LOS ANGELES, Feb. 22.—An Apperson Jack Rabbit was the star performer to-day in the Pasadena-Altadena hill climb, one of the most important automobile events held on the Pacific Coast, making the fastest time of the day and defeating Barney Oldfield in his Stearns by five seconds. The mile and four-tenths climb, with a grade averaging 11 per cent., was covered by the winner in 1:24 from a standing start.

ACTIVITIES OF NEW YORK TRADE ASSOCIATION

VARIOUS activities that will have a tendency toward enlivening New York trade circles with something different from the regular business lines, and at the same time be of great benefit to the sales departments of the concerns, are being planned by the New York Automobile Trade Association. A hill climb on the Fort George hill, a week of carnival festivities and a two-day endurance run to the Catskill Mountains.

The hill climb has been scheduled for April 10 and will take the place of the event which had to be postponed from last Fall, with the same rules and regulations in effect, the classification probably to be by price and also by horsepower. June 11 and 12 have been considered as the best dates for a repetition of the successful touring contest of last Fall, when the cars were driven down to Montauk Point and back, giving the members and their friends not only a pleasant tour and a view of the wild and yet beautiful end of the island, but also a touch of real seasickness.

To avoid the necessity of camping out upon a steamer, it has been suggested that Catskill would be a favorable terminus of the first day's run this year, going to the mountains along the west shore of the Hudson and on the second day, leaving in the early morning, crossing over to the eastern shore and thence to the Berkshires, reaching New York City that afternoon or early evening. This would give the cars a strenuous test and the contestants a beautiful trip. President Eveland has appointed Charles P. Skinner, of the Mitchell Motor Car Company, the chairman of a committee to formulate the rules and to plan the itinerary.

At a meeting to be held this afternoon at the offices of the Trade Association the present official garage storage rates for automobiles, and the sale price of gasoline, oil and labor, which have been successfully maintained since October 1, 1906, will be revised to meet present changing conditions. The Pope-Hartford Auto Company has been elected a member of the association.



New Building of Miner Garage Company, Hartford, Conn.

Hartford, Conn.—One of the finest salesrooms and garages in the country for a city of its size is that of the Miner Garage Company, dealers in Pierce-Arrow cars. Instead of being adapted from a structure originally built for some other purpose, this building was constructed primarily for the automobile business. A separate entrance and exit are provided for cars, and at the rear of the sales and display rooms there is an unique feature, an entrance for women who wish to see the cars on the floor. Surmounting one corner of the structure is a double, upright electric garage sign. As is characteristic of the buildings of almost all dealers in Pierce-Arrow cars this one has a look of permanency and of being especially fitted for the purpose for which it is employed.

Baltimore, Md.—A two-story garage, the design of which will represent an old English inn, is to be erected at the southwest corner of North Avenue and Lovegrove Alley for the Auto Outing Company, of which George W. Eisenhauer is president. The lot has a front of 39 feet on North Avenue and extends back 175 feet. Reinforced concrete will be the material used for the construction of the garage. The company has just recently closed negotiations for the agencies of the Palmer-Singer, Simplex and other cars.

Bridgeport, Conn.—The Aston Motor Car Company, formerly of 1185 State street, has recently taken possession of its new concrete garage at 1125 State street. The new quarters are 100 feet in depth, with 60 feet frontage, furnishing floor space for about 40 cars. In the rear is an up-to-date machine shop, where a few cars are assembled for local patronage.

Waterbury, Conn.—The Rambler garage, of which H. M. Turrell is manager, expects to take possession on April 1 of a new garage and repair shop located just above the present quarters at 17 Jefferson street. The new building will be of brick, two stories in height, 50 feet across the front and 100 feet deep.

Lambertville, N. J.—A full line of accessories will be carried by O. A. Burd & Son, who will also handle the American Mors car. This concern has opened one of the largest and best equipped garages in the State of New Jersey. The repair shop is in the hands of competent mechanics.

Raleigh, N. C.—F. H. Brewer, Franklin dealer, has formed the Carolina Garage & Machine Company, which is erecting a two-story building. It is intended to make the structure one of the best equipped garage buildings in the South. The entire lower floor will be used as a showroom.

Philadelphia.—The newest garage in the city has been opened by Frederick K. Mears at 4525-4527 Springfield avenue, where he has moved from Regent street, near Forty-seventh, retaining the trade name of the Regent Garage. A large elevator gives access to upper floors.

Scranton, Pa.—The Standard Motor Car Company's new garage building in Forrest and Dupont courts has been started, ground having been broken.

South Bend, Ind.—The Otis Motor Car Company, Franklin dealers, will build a garage and salesroom, 20 by 80, in the heart of the business district.

Detroit.—W. G. Isbell has sold his garage at 730-732 Woodward avenue, but will retain the American Simplex agency quarters in the same block, at No. 742.

Nashville, Tenn.—The Tennessee Automobile Company, located at Twelfth avenue and Broadway, has opened one of the largest and most complete garages in the South.

Detroit.—J. P. Schneider's new garage building at Woodward avenue and Bagg street is complete, and will be occupied immediately, the old building on Jefferson avenue being vacated.

Cleveland.—A two-story garage will be erected facing East Sixty-sixth street for the Babcock Electric Company, of Buffalo, N. Y. This will be a fireproof structure, to cost \$40,000.

El Paso, Texas.—The new building at 324 Texas street, in the heart of the city, has been occupied by the P. L. Abel Cycle Company. This company handles the Franklin, and in the new place will have a floor space 30 by 125 feet.

Cumberland, Md.—The Windsor Garage Company has been incorporated under the laws of Maryland; capital, \$5,000. Directors are J. C. Powell, F. E. Perrin and W. O. Cole, all of Cumberland. The company is erecting a garage and will do repairing.

Detroit.—A recently organized firm, composed of A. J. Mandel, A. G. Zeller and C. Zeller, will do a general storage and repair business, as well as dealing in second-hand autos, at 10 Selden avenue, under the name of the Economy Auto Garage.

Charlotte, N. C.—The large garage now being built by Osmond L. Barringer on Eighth street will be a noteworthy addition to the automobile facilities of this section. This is 50 by 180 feet in size, and the building will be strictly up to date.

New York City.—A newcomer in the taxicab ranks is the Parkway Garage Company, of Central Park West and 110th street, with the Royal Blue Service. This is so called because the cars used, of the Thomas make, are finished in a beautiful blue color known as Royal blue. This was a special finish, which the company designated in purchasing the car, the upholstering being carried out to match. This service, for which the usual metropolitan rates obtain, will be conducted from the company's garage at the above address, at which place cabs are always kept ready and in waiting. Located, as it is, up in the fashionable district, a good business should result. For new users of cabs the company gives the following protective advice, observe: (a) That the flag on the taximeter is lowered at the beginning of the service and not before; (b) that the flag is maintained in that position during the service; (c) that the flag is properly brought to "payment" position at the conclusion of the service.



Parkway Garage, at 110th Street, New York City.



One of Washington's Old Headquarters.

S. H. Hansbrough, President of the Shenandoah National Bank, Winchester, Va., with wife, daughter and son, in front of General Washington's old headquarters, occupied in 1755 by the Father of His Country, and one of the many historical spots in that section of the country. Mr. Hansbrough is an enthusiastic Rambler owner.

"Magneto" Sims on Six-cylinders.—Frederick G. Sims, of London, a pioneer automobile builder and well known in this country as the maker of the Sims-Bosch magneto, was a recent visitor at the Winton plant in Cleveland. Mr. Sims has organized an airship exhibition to be held at Olympia in March. Among the exhibits will be his own airship, propelled by a six-cylinder gasoline motor. "The British automobile trade is not as active as could be desired," said Mr. Sims. "Among the makers of big cars about the only ones who are keeping busy are the six-cylinder manufacturers. British people who have the means to get good cars find the six the only type worth buying. I am a six-cylinder enthusiast myself and look to see six motors in almost universal use, in little cars as well as big ones."

Receiver's Report Shows Big Cash Balance.—The report of Henry W. Nuckols and Halsey M. Barrett, receivers of the Electric Vehicle Company, Hartford, Conn., for the month of January has been duly filed with the Superior Court. Cash sales are noted as being \$25,713.72 and purchases amount to \$31,095.85. Cash was collected on the receiver's account to the amount of \$25,354.15, while from the Selden patent royalties was realized the sum of \$101,206.68. Under the head of disbursements the A. L. A. M. is credited with having been paid \$40,701.71 by the receivers. The cash balance foots up \$173,936.45.

Hartford Parts Company Moves to Larger Quarters.—So great has been the demand for its universal joints that the Hartford Auto Parts Company has found it necessary to move to larger quarters. The company has leased the west wing of the Colt's patent firearms factory, at No. 80 Huyshope avenue, and is now busily engaged in moving to this new location. The latter will give the company four times as much space as formerly occupied. Thus the new building will allow the installation of such additional machinery as the rapidly increasing business has made necessary.

A Firm That Did Not Overcharge.—The Winkley Company of Detroit, manu-

facturers of oiling devices, is showing with pardonable pride a letter received from D. W. Carter, assistant secretary of the State Mutual Life Assurance Company, of Worcester, Mass., in regard to the price of a certain small device which the Detroit firm sold for eight cents. Mr. Carter writes in part: "It is a pleasure to find a concern which does not impose on the autoist. A local dealer wanted a dollar for the same thing."

Large Commercial Car Shipment.—Four carloads of commercial cars in one shipment from the factory in Buffalo of the Auto-Car Manufacturing Company is considered by the officials to be one of the largest shipments of its kind on record. A number of the machines were three-ton, six-cylinder, 60-horsepower cars, all being sent to the Boston agents, Abbott & Miller. F. C. Lindoerfer, the general sales manager, has returned to the factory from an extended Eastern trip.

Billings & Spencer Company Election.—At the annual meeting of the Billings & Spencer Company, held in Hartford, Conn., recently, the following board of directors was re-elected: C. E. Billings, F. C. Billings, C. M. Spencer, L. H. Holt, Silas Chapman, Jr., E. H. Stocker and L. D. Parker. At a subsequent meeting of the board of directors the following officers were re-elected: President and general manager, C. E. Billings; vice-president and superintendent, F. C. Billings; treasurer, L. H. Holt.

OBITUARY.

Russell Drisko, one of the best known men in the automobile trade in Boston, died on Thursday of last week at his home in that city. Mr. Drisko at one time handled the Mors in Boston, and after that was connected with the late F. F. Randall in the sale of Stevens-Duryeas. More recently he had the management of the Boston store of the Bay State Forty, and later on was for a short time in charge of the Grout factory at Orange, Mass. After leaving there he had charge of the Boston branch of the Jones Speedometer Co.

BOSTON TRADE CHANGES.

BOSTON, Feb. 20.—Two interesting trade changes were announced to-day. One of these is the placing of the Stearns agency, formerly held in Boston by Morgan B. Kent, with J. H. MacAlman, the Columbia agent and president of the Boston Dealers' Association. Mr. MacAlman will continue also as agent for the Columbia, but he has taken additional quarters at No. 889 Boylston street. There his salesroom will be located, but he will retain his garage and repair shop on Stanhope street. Mr. MacAlman is one of the veterans in the trade, dating back twelve years. He was manager of the Locomobile branch up to a few years ago, when he took charge of the Electric Vehicle Company's branch. Since that branch was discontinued he has sold Columbia cars.

The other new agency is for the Mora, which is to be handled here by the G. H. Proctor Supply Company, at No. 25 Irving street.

IN AND ABOUT THE AGENCIES.

Fiat, Philadelphia.—Louis J. Bergdoll has taken over the agency for this city and surrounding territory of the Fiat cars, thus displacing the former branch of the Fiat Automobile Company. The branch has really been moved to Chicago to take charge of the interests there, and with a well established trade in the Quaker City was hardly needed according to the policies of the importers. Mr. Bergdoll will personally manage the sales of these cars at the corner of Broad and Vine Streets, in one of his new buildings. At present the American Locomotive, Oakland and Rauch & Lang are also sold there.

Stevens-Duryea, Philadelphia.—Besides their new garage and salesrooms at Nos. 202-204 North Broad street, A. G. Spalding & Bros., Philadelphia agents of the Stevens-Duryea, will hereafter use the concern's general sporting goods store at No. 1210 Chestnut street as an additional salesroom. J. F. Grey is in charge of the latter, while F. W. Eveland will manage the Broad street establishment.

Continental Opens Chicago Branch.—On account of a large amount of business which is handled in Chicago, the Continental Caoutchouc Company of New York has opened a branch in that city. This is the third branch established, the others being in San Francisco and Detroit, the general sales trade of the country being handled by distributing agents.



Lozler's New Broadway Location.



Atwood-Castle Stand at Chicago Show.

First Foreigner in Baltimore.—The first foreign car to be exhibited at any show in Baltimore is the Renault. The Stoddard-Dayton Baltimore Auto Company, Leo Shaab, manager, has just closed a deal for the agency. This is also the first and only foreign car that has ever had an agency in that city.

Welch, New York City.—An agency for the Welch cars will be opened in this city by Welch & Forrester, who will take possession of the salesroom on Broadway, near Sixty-third Street. A. R. Welch, who is at present the manager of the Welch Motor Car Company, is to be of the firm.

Palmer-Singer, Philadelphia.—From now on the Palmer & Singer Company's line will be represented in Philadelphia, the agency having been secured by William and Charles Miller, at No. 441 N. Broad Street.

Stewart & Clark, Detroit.—A branch office has been opened at No. 697 Woodward avenue, where the Detroit trade will be handled in the future. This office will be in charge of C. E. Brelsford.

E. M. F., New Ulm, Minn.—The Albrecht Motor Car Company has been organized to operate a large garage and to handle the E. M. F. 30 in the local territory.

PERSONAL TRADE MENTION.

J. L. Sternberg has severed his connection with the Everett-Metzger-Flanders Company and has gone into the retail business at 119 East Second street,

Wichita, Kan., with a branch store at Enid, Okla. Mr. Sternberg was for several years with the Northern Motor Car Company of Detroit, and in his new enterprise will be associated with M. L. Arnold and C. S. McClellan, of Enid, Okla., who have already taken on the agency of the Inter-State car, made at Muncie, Ind., and expect to close for other agencies in the near future. The concern will operate under the name of J. L. Sternberg & Co. at both Wichita and Enid.

C. E. Brelsford, for several years past Detroit manager for the Witherbee Igniter Company, has resigned and accepted a position with the Stewart & Clark Mfg. Company as Detroit manager, and will locate on Jefferson avenue in the near future, exact location to be announced later.

Charles C. Craig, long identified with the automobile trade and well known all over the United States, has been engaged by the Haynes Automobile Company as special traveling representative, and will cover the Western territory in the interests of the Haynes Company.

C. Klug, who has been connected with the main office of the Witherbee Igniter Company of New York for some years past, has been appointed manager of the Detroit branch, vice C. E. Brelsford, resigned. Mr. Klug is now at headquarters at 220 Jefferson avenue, Detroit.

Fred. G. Browning, for many years prominently identified with the factory and the Autocar Company's business at Ardmore, Pa., has been transferred to the management of the company's Philadelphia branch at 249 North Broad street.

Alexander Winton, president of the Winton Motor Carriage Company, accompanied by Mrs. Winton, sailed from New York on the Lusitania February 15 for a six weeks' visit to England and Scotland.

Louis Mansbach, for many years of the firm of Isaac Mansbach & Company, of Philadelphia, is now connected with the sales forces of the German Benz car. at the Benz headquarters in New York City.

Harry T. Clinton, until recently the manager of the branch of the Fiat Automobile Company in Philadelphia, has moved his headquarters to Chicago, where he will have charge of the Fiat branch there.

Ezra Kirk, one of the well-known figures in the automobile industry, has taken the Western sales managership for the



How Michellins Were Shown at Chicago.

Herreshoff car, manufactured and marketed by the Harry S. Hought Company.

Evans Church has been appointed manager of the Philadelphia branch of the Eastern selling district of the White Company, taking the place of Max Greene.

WAIL OF THE SALESMAN.

Everybody works but the factory
They sit around all day;
Always writing letters—
"Expect to ship," they say.

Customers keep on calling—
New stories we must tell;
Everybody works at the factory,
Yes they do, like —!

E. T. B.

LEAR RECEIVER TEMPORARY.

SPRINGFIELD, O., Feb. 22.—In order to be better able to increase its capital, and as a temporary measure, the Oscar Lear Automobile Company, manufacturer of Frayer-Miller automobiles, has had a receiver appointed to take charge of the business affairs of the concern. Realizing that more capital was necessary in order to carry on the business on more progressive lines than before, this step was determined upon. The application states that the assets of the company are \$308,000 and the liabilities are \$144,140. The capital stock is \$300,000. The receiver appointed is highly satisfactory to the officers and stockholders of the company, and it is predicted that within a short time the concern will be in a better position than at any previous time.



Four White Steam Taxicabs Purchased by Matt De Freest, One of the Largest Liverymen in Albany, N. Y.

THE AUTOMOBILE

BOSTON, March 4.—Boston's automobile show, the last of the series of exhibitions of national consequence, the snapper of the whip that brings the buying public into line and sends them scurrying off for the last lap of the race for the new models, will open next Saturday evening in Mechanics Building, the great structure on Huntington avenue that has been the scene of so many successful automobile shows in the past. This is the seventh annual show conducted by the Boston Automobile Dealers' Association under the management of Chester I. Campbell, and there is every indication that it will exceed its predecessors in size and in results. Practically every inch of space has been sold to exhibitors of motor vehicles, or the things that go with them, and that means that the show will be the largest of its kind in the country. Year after year it has been necessary, in order to keep step with the growth of the industry, to gain more space. First, the show spread to every part of the building, then the motor boats were crowded out, and this year, in order to satisfy the demands of prospective exhibitors, Manager Campbell has been obliged to dispossess the restaurant and instead of a feast for the inner man there will be provided in Talbot Hall a feast for the eyes, in the form of new automobiles.

It is to the Boston show that all Yankee land looks for the latest ideas in automobiles. Some Bostonians, and a few of the dealers in the smaller cities, go over to the national shows in New York; the smaller shows, such as those in Hartford, Portland, and other places satisfy a certain local need, but the New Englanders who are really interested in the automobile and its accessories flock to the Boston show, for they know from experience that they will find there practically everything that has been exhibited elsewhere,

and usually a number of novelties which first make their appearance in Boston. At this show, as in Chicago, there are no distinctions of licensed or unlicensed, or previous condition of nationality, and all machines are exhibited here on an equal basis. Thus the visitor has the only opportunity in this part of the

country to see domestic and foreign, licensed, unlicensed and independents together.

The Boston show is par excellence a retail exposition. It is not intended as a place for the meeting of manufacturers and agents, for by the middle of March practically all the agencies and sub-agencies have been placed. Nevertheless, there is usually some business of this sort transacted. Primarily, however, the Boston show is a place where the local dealers and the manufacturers rub elbows with the owners and owners-to-be, and sales are made just as in the salesrooms. Of perhaps more importance than the actual sales is the interest which the show creates just before the opening of the riding season. This is just the right time for a retail show, and the Boston dealers believe that their exhibition does more good to the trade by the stimulation of interest among the public than in any other way.

There are more than four hundred exhibitors this year in the Boston show, a larger number than at any previous exhibition. For show purposes the exhibition space in the great building has been divided into eight departments. Department A includes the main floor of the grand hall, devoted exclusively to the exhibits of

pleasure cars, with a few for the trade and daily publications interested in motoring. Department B is the main floor of exhibition hall, adjoining the grand hall, and this also is set aside exclusively for pleasure vehicles. Department C is the basement under the grand hall and in this section most of the com-



**BOSTON
AUTOMOBILE
SHOW**

**MECHANICS BLD'G.
BOSTON
MARCH 6 - 13**

mercial vehicles will be shown, though there will be some exhibits of sundries and of cars for which no space could be found on the upper floors. Department D is the basement under the exhibition hall with motor cycles and their sundries. Department E is in the first balcony of the grand hall, and it is in this part of the building that many of the tire manufacturers have secured spaces, as well as manufacturers of lamps and other accessories. Departments F and G are also devoted to the exhibition of accessories, while Talbot Hall is to be used for an overflow exhibition of automobiles. Departments F, G and Talbot Hall are on the upper floor over Exhibition Hall.

The Boston Automobile Dealers' Association long ago took the initiative in the uniform decoration of Mechanics Building, on the occasion of the automobile show, and it has made some notable successes in the way of decorations. The New England apple orchard of a few years ago and the more recent Italian garden are well remembered. For this year Manager Campbell has departed somewhat from his former practise in that the show building will represent an interior rather than an out-door scene. For months the decorators have been at work preparing the mass of materials that make up the decorations, and since the first of this week hundreds of men have been busily engaged putting in place the setting for the 1909 crop of automobiles. That the decorative effect will be fully up to the standard of Boston shows is the promise of the management.

Exhibition Hall, as it is being arranged, has been appropriately termed the "hall of arches." Over all the aisles there are being put in place great arches which will be illuminated with thousands of electric lights. Nearly one hundred arches are to be used in this hall. The great posts which support the upper floor of Exhibition Hall have been entirely concealed and made into artistic pillars with bases of green onyx marble. At the top of the marble pillars have been placed ivorized plaster capitals, and from these spring the arches which span the aisles and extend longitudinally down the sides. The arches are highly decorative with corner beads of raised plastic ornaments. At the crowns of the arches are placed escutcheons and the wide soffits or undersides of the arches are to be studded with incandescent electric lamps, each set in a decorative rosette. The square ceilings produced by the arrangement of the arches are being covered with sunbursts of materials in colors harmonizing with the general decorative scheme. In the center of each sunburst depends an electric chandelier, which, with the incandescent lamps, makes the archway exceedingly brilliant. The side walls and detached posts in Exhibition Hall have been covered with material in old gold and green, harmonizing well with the rest of the decorations. Panelling of gold moulding on the side walls adds to the effectiveness of the general scene. The stairways leading to the upper floor from Exhibition Hall are covered with the green onyx material to resemble onyx marble stairways. On the flooring of the exhibition spaces is laid a green covering.

In Grand Hall the piece de resistance of the decorative scheme is the stage. This immense span, with its great proscenium arch, is a difficult proposition for the decorator, but in this instance the treatment has been extremely successful. On either side of the stage great pilasters of plaster have been erected. These are modelled in the form of decorative panels with green onyx and ivorized plaster bases. Upon each panel in high relief is a modelled female figure representing the "genus of progress." Each figure holds aloft in both hands flaming torches in which cunningly concealed electric lights flash out as the torches revolve.

Immediately above the heads of the genii are placed the numerals, "1909," set out in incandescent lamps. A specially designed and painted curtain is draped from the top of the proscenium arch and this hangs in graceful folds covering not only the top of the stage but the sides beyond the pilasters and making a very pleasing effect. In connection with this curtain electric lamps are used in profusion, great cables of them extending along the edge of the folds and a fringe depending from the edges. Several thousand incandescent bulbs are used in this work alone. The top of the stage has been covered. The side stairways and the central approach to the stage are treated in green onyx and the stage front is covered.

The band stand is located in the center of the Grand Hall, and is raised to the balcony level. It has a decorative canopy above and is surrounded by a scroll work railing. The balcony fronts have been covered with an ivory shaded background, over which has been draped green foliage and flower decorations, entwined with veri-colored electric lamps. The great beams which support the roof have been concealed and here electricity is used with great extravagance for purposes of illumination and decoration. To divide the exhibition spaces a special fence has been designed, consisting of a wooden scroll of pierced work with varnished railings. At the aisle ends of each dividing fence are artistic corner posts, from which rise the standards supporting the signs. The signs this year are a novelty and quite different from anything used in other shows. They consist of wrought iron standards artistically fashioned, with an oval frame at the top, in which is placed the sign of the exhibitor. The background of the sign is green onyx and the letters are black and edged with gold. The signs are exceedingly neat, and the abandonment of the old-fashioned long sign adds to the commodious effect of the hall. There are no arches in the Grand Hall, so there is nothing to interrupt the view. At the same time the spaces are divided so that there will be no confusion.

In the basement less elaborate decorations are possible than on the floor above, for decorations that are too heavy interfere with the exhibitors. Nevertheless, the basement has been suitably decorated, the bare side-walls and posts being hidden, and just enough decoration given the ceiling to conceal the beams. The decorative scheme in the base-

ment harmonizes with that of the main floors, the general color scheme being green and ivory. In the balconies the same signs and dividing fences are used as on the main floor.

In speaking of the decorative scheme for the show, taken in its entirety, Manager Campbell says: "We have always taken especial pride in setting the pace for other shows all over the country in this particular respect, and one can always find the influence of our decorations in subsequent exhibitions in other cities. It has become a fact that the public has become so accustomed to having its annual feasts of automobiles in attractive, original and really magnificent settings that the standard must necessarily be one not only of general beauty, but of architectural excellence.

"We studied for a considerable time as to how we could so change the appearance of the halls here to make them better than anything ever seen here before, and we feel that, to a large degree, we have been successful, so that it is without trepidation that we will throw open the doors. The cars for exhibition purposes have been arriving steadily for several days, some having come direct from Chicago, and we also expect that when the public is admitted to the show that it will be a complete one."

The Prevailing Genus



THE LIST OF EXHIBITORS

CARS FOR PLEASURE AND COMMERCIAL USES.

Acme—Boston Motor Co., 43 Columbus ave.
A-K—Allen-Kingston Motor Car Co., 387 Boylston st.
American—American Auto Co., 16 Columbus ave.
Apperson—Fred. S. Smith, 38 Columbus ave.
Atlas—South End Motor Car Co., 24 E. Concord st.
Austin—Austin Automobile Co., Grand Rapids, Mich.
Autocar—Fred. S. Smith, 38 Columbus ave.
Autocar Trucks—Autocar Equipment Co., Buffalo, N. Y.
Bailey—S. R. Bailey & Co., Amesbury, Mass.
Baker—A. F. Neale, 10 Columbus ave.
Berliet—Park Square Auto Station, Park sq.
Brush—South End Motor Car Co., 24 E. Concord st.
Buick—Buick Motor Co., Park sq.
Cadillac—Alvin T. Fuller, Park sq.
Chadwick—Curtis-Hawkins Co., 218 Elliot st.
Chalmers-Detroit—Whitten-Gilmore Co., 907 Boylston st.
Chase—Chase Motor Truck Co., Syracuse, N. Y.
Columbia—J. H. MacAlman, 74 Stanhope st.
Columbus—Algonquin Motor Car Co., 97 Massachusetts ave.
DeLuxe—Kissel Kar Kompany, 741 Boylston st.
Detroit—Anderson Carriage Co., Detroit, Mich.
EMF—Studebaker Brothers of New York, 1020 Boylston st.
Flat—Flat Automobile Co., New York City.
Ford—Ford Motor Co., 147 Columbus ave.
Franklin—Franklin Automobile Co., 671 Boylston st.
Framer-Miller—D. P. Nichols & Co., 116 W. Brookline st.
General Trucks—General Vehicle Co., 84 State st.
Gilde—Crown Motor Car Co., Park sq.
Gramm-Logan—Gramm-Logan Motor Car Co., Bowling Green, O.
Grout—Henry F. Farrow, 94 Massachusetts ave.
Gyroscope—George H. Lowe, 11 Park sq.
Holsman—General Auto Co., 10 Columbus ave.
Hotchkiss—Hotchkiss Import Co., New York City.
Hupmobile—Hupmobile Motor Car Co., Detroit, Mich.
Inter-State—S. M. Supply Co., 22 Lincoln st.
Jackson—Jackson Automobile Co., Jackson, Mich.
Jewel—Jewel Motor Car Co., Massillon, O.
KisselKar—Kissel Kar Kompany, 741 Boylston st.
Knox—Reed-Underhill Co., 222 Columbus ave.
Lambert—Chas. A. Eaton, 64 Pembroke st.
Lancia—Hol-Tan Co., 66 Hereford st.
Locomobile—Locomobile Co. of America, 400 Newbury st.
Marmon—F. E. Wing, 12 Columbus ave.
Matheson—Matheson Auto Co., New York City.
Maxwell—Maxwell-Briscoe-Boston Co., 121 Massachusetts ave.
McCue—McCue Co., Hartford, Conn.
Mitchell—W. M. Jenkins & Co., 286 Columbus ave.
Mora—Mora Motor Car Co., Newark, N. Y.
Napier—Napier Motor Co. of America, Jamaica Plains, Mass.
National—Linscott Motor Co., 163 Columbus ave.
Oakland—Oakland Motor Car Co., Buffalo, N. Y.
Oldsmobile—Algonquin Motor Car Co., 97 Massachusetts ave.
Overland—Linscott Motor Co., 163 Columbus ave.
Packard—Alvin T. Fuller, Park sq.
Palmer-Singer—Palmer & Singer, 1620 Broadway, New York.
Panhard—Panhard & Levassor, 901 Boylston st.
Peerless—Peerless Motor Co., 174 Columbus ave.
Pennsylvania—George H. Lowe, 11 Park sq.
Pierce-Arrow—J. W. Maguire Co., 754 Boylston st.
Pittsburg—Stanley Webster Co., 1024 Boylston st.
Pittsburg Six—Fort Pitt Motor Mfg. Co., New Kensington, Pa.
Pixley—G. H. Pixley Co., 239 Columbus ave.
Pope Hartford—Dodge Motor Vehicle Co., 25 Irvington st.
Pope Waverley—Dodge Motor Vehicle Co., 25 Irvington st.
Premier—Premier Boston Depot, 1008 Boylston st.
Pullman—York Motor Car Co., York, Pa.
Rambler—Thomas B. Jeffery & Co., 73 Massachusetts ave.
Rapid—Butler Motor Car Co., 12 Harcourt st.
Regal—George H. Lowe, 11 Park sq.
Reo—Linscott Motor Co., 163 Columbus ave.
Royal Tourist—George J. Dunham, 182 Columbus ave.
Sampson—Alden Sampson Mfg. Co., Pittsfield, Mass.
Schacht—Schacht Mfg. Co., Cincinnati, O.
Simplex—Palmer & Singer, New York City.
Simplex (American)—American Simplex Co., Boston, Mass.
Speedwell—Curtis-Hawkins Co., 218 Elliot st.
Stanley—Stanley Motor Carriage Co., Newton, Mass.
Stearns—J. H. MacAlman, 74 Stanhope st.
Stevens-Duryea—J. W. Bowman & Co., 911 Boylston st.
Stoddard-Dayton—Park Square Auto Station, Park sq.
Studebaker—Studebaker Brothers, 1020 Boylston st.
Thomas—Whitten-Gilmore Co., 907 Boylston st.
Welch—Welch Motor Car Co., 733 Boylston st.
White—White Co., 320 Newbury st.
Winton—Winton Motor Carriage Co., 148 Berkeley st.

MOTORCYCLES.

Crouch—Crouch Motor Co., Stoneham, Mass.
Curtiss—G. H. Curtiss Mfg. Co., Hammondsport, N. Y.
Excelsior—Excelsior Supply Co., Chicago.
F. N.—Ovington Motor Co., New York City.
Greyhound—Auto-Bi Co., Buffalo, N. Y.
Harley-Davidson—Harley-Davidson Motor Co., Milwaukee, Wis.
Indian—Hendee Mfg. Co., Springfield, Mass.
Merkel-Light—Merkel-Light Motor Co., Pottstown, Pa.
Midget Bi-Car—Walton Motor Co., Lynbrook, N. Y.
M. M.—American Motor Car Co., Brockton, Mass.
New Era—New Era Gas Engine Co., Dayton, O.
N. S. U.—N. S. U. Motor Co., New York City.
Pierce—Pierce Cycle Co., Buffalo, N. Y.
Reliance—Reliance Motor Cycle Co., Owego, N. Y.
R-S—Reading Standard Co., Reading, Pa.
Thor—Aurora Automatic Machinery Co., Aurora, Ill.
Yale—Consolidated Mfg. Co., Toledo, O.

MAGNETOS AND TIMERS.

Atwater-Kent Mfg. Co., Philadelphia.
Champion Ignition Co., Flint, Mich.
Heinze Electric Co., Lowell, Mass.
Hoyt Electrical Instrument Co., Penacook, N. H.
K. W. Ignition Co., Cleveland.
Lavalette & Co., New York City.
Leland & Co., W. H., Worcester, Mass.
Monitor Mfg. Co., 6 Pelham st.
Pittsfield Spark Coil Co., Dalton, Mass.
Spiltdorf, C. F., New York City.
Witherbee Igniter Co., New York City.

TIRES.

Ajax-Grieb Rubber Co., 15 Park sq.
Atlas Rubber Co., Buffalo, N. Y.
Batavia Rubber Co., Batavia, N. Y.
B. F. Goodrich Co., Akron, O.
Boston Tire & Rubber Co., 184 Friend st.
Commonwealth Rubber Co., Reading, Mass.
Continental Caoutchouc Co., New York City.
Diamond Rubber Co., Akron, O.
Dow Tire Co., New York City.
Empire Auto Tire Co., Trenton, N. J.
Firestone Tire & Rubber Co., Akron, O.
Fisk Rubber Co., Chicopee Falls, Mass.
Goodyear Tire Co., Akron, O.
G & J Tire Co., Indianapolis, Ind.
Hartford Rubber Works Co., Hartford, Conn.
Michelin Tire Co., Milltown, N. J.
Morgan & Wright, Detroit, Mich.
Pennsylvania Rubber Co., Jeanette, Pa.
Republic Rubber Co., Youngstown, O.
Rutherford Rubber Co., Rutherford, N. J.
Shawmut Tire Co., 97 Bedford st.
Swinehart Clincher Tire Co., Akron, O.

TIRE ACCESSORIES.

Auto Tire Inflating Co., Brooklyn, N. Y.
Hopewell Bros., 42 Osborne st.
Leather Tire Goods Co., Newton Upper Falls, Mass.
Teel Mfg. Co., Medford, Mass.
Voorhees Rubber Mfg. Co., Jersey City, N. J.
Zeglan Bullet Proof Cloth Co., Chicago.

BATTERIES.

American Storage Battery Co., 8 Congress st.
 Burn Battery Co., Boston, Mass.
 Eastern Carbon Works, Jersey City, N. J.
 Electric Storage Battery Co., Philadelphia.
 National Carbon Co., Cleveland, O.
 Vesta Accumulator Co., Chicago.
 Witherbee Igniter Co., New York City.

COILS AND GENERAL IGNITION.

Champion Ignition Co., Flint, Mich.
 Heinze Electric Co., Lowell, Mass.
 Hoyt Electrical Instrument Co., Penacook, N. H.
 Leland & Co., W. H., Worcester, Mass.
 Pettingell-Andrews Co., Pearl st and Atlantic ave.
 Pittsfield Spark Coil Co., Dalton, Mass.
 Splittorf, C. F., New York City.

LUBRICANTS AND LUBRICATORS.

Columbia Lubricants Co., New York City.
 Dixon Crucible Co., John Hancock Building.
 Eagle Oil & Supply Co., 104 Broad st.
 Harris Oil Co., Providence, R. I.
 Havoline Oil Co., 749 Boylston st.
 Haws, George A., New York City.
 Kellom & Co., Philadelphia.
 Keystone Lubricating Co., Philadelphia.
 N. Y. & N. J. Lubricants Co., New York City.
 Randall-Falchney Co., Causeway st.
 Robinson & Son Co., Wm. C., 44 Commercial st.
 Underhay Oil Co., 77 Batterymarch st.
 Vacuum Oil Co., Rochester, N. Y.
 White & Bagley Co., Worcester, Mass.
 Young & Kimball, 111 Purchase st.

SHOCK ABSORBERS AND RUNNING GEAR.

American Stepney Spare Wheel Co., New York City.
 Flentje, Ernest, Cambridge, Mass.
 Gabriel Horn Mfg. Co., Cleveland.
 Hartford Suspension Co., Jersey City, N. J.
 Kilgore Mfg. Co., 585 Boylston st.
 Sager Co., J. H., Rochester, N. Y.
 Whitney Mfg. Co., Hartford, Conn.

SPEEDOMETERS.

Auto Improvement Co., 319 Columbus ave.
 Hoeffcker Co., 222 Elliot st.
 Jones Speedometer Co., New York City.
 Jones, Wm. Herbert, 147 Columbus ave.
 Loring Auto Appliance Co., New York City.
 Parker Mfg. Co., Roxbury, Mass.
 Veeder Mfg. Co., Hartford, Conn.
 Warner Instrument Co., 925 Boylston st.

PUMPS, MUFFLERS AND HORNS.

Compressed Air Power Co., 35 Congress st.
 Gabriel Horn Mfg. Co., Cleveland.
 Nightingale Whistle Mfg. Co., New York City.
 Randall-Falchney Co., Causeway st.

MATERIALS.

Cramp Ship & Engine Co., Philadelphia.
 Dover Stamping & Mfg. Co., 385 Putnam ave.
 Federal Mfg. Co., Lowell, Mass.
 Lebanon Steel Casting Co., Lebanon, Pa.
 National Tube Co., New York City.
 Standard Welding Co., Cleveland.
 Worcester Pressed Steel Co., Worcester, Mass.

CARBURETERS AND GAS TANKS.

Allen Fire Dept. Supply Co., Providence, R. I.
 Boston Auto Gage Co., 8 Waltham st.
 Bowser & Co., S. F., 255 Atlantic ave.
 Gilbert & Barker Mfg. Co., 17 Pearl st.
 Sexton Can Co., 2 Hartford st.
 Stromberg Motor Devices Co., 319 Columbus ave.

LAMPS.

Atwood Mfg. Co., Amesbury, Mass.
 Gray & Davis, Amesbury, Mass.

SHIELDS, TOPS, AND BODY MOUNTINGS.

Allen Auto Specialty Co., New York City.
 Badger & Sons Co., E. B., 63 Pitts st.
 Bi-Motor Equipment Co., 177 Portland st.
 Chase & Co., L. C., 89 Franklin st.
 Columbia Tire & Top Co., 97 Haverhill st.
 Hillman Auto Supply Co., 446 Tremont st.
 Hume Carriage Co., 66 Stanhope st.
 Moran, S. J., 322 Main st.
 Murray & Co., P. A., Newton, Mass.
 Pantasote Co., New York City.
 Polson, W. F., Buffalo, N. Y.
 Waugh & Co., Chas., Cambridge, Mass.

WRENCHES AND OTHER TOOLS.

Coates Clipper Co., Worcester, Mass.
 Coes Wrench Co., Worcester, Mass.
 Norton Grinding Co., Worcester, Mass.
 Oliver Mfg. Co., Chicago.
 Perfection Wrench Co., Port Chester, N. Y.
 Smith Co., Wm. J., New Haven, Conn.
 Sterling Hardware Co., New York City.
 Walden Mfg. Co., Worcester, Mass.
 Wilkinson & Co., A. J., 184 Washington st.

IN GENERAL.

Aetna Life Ins. Co., 4 Liberty sq.
 Allen & Son, M. W., 27 Columbus ave.
 Angler Co., 735 Boylston st.
 Boyd, F. Shirley, 889 Boylston st.
 Byrne, Thomas W., 8 Doane st.
 Chanler & Farquhar Co., 36 Federal st.
 Colgan Co., J. W., Sudbury st.
 Connell, W. J., 36 Columbus ave.
 Couch & Seeley, 10 Thatcher st.
 Coward, J. D., 222 Elliot st.
 Downing, C. J., New York City.
 Empire Sales Co., New York City.
 Forbes, Walter J., 220 Congress st.
 Ford Co., Percy, 226 Columbus ave.
 Goppelt, Fred. A., Waterbury, Conn.
 Gordon Auto Supply Co., 1024 Boylston st.
 Harriman Bros., 303 Exchange st.
 Harvey Co., Arthur C., 374 Congress st.
 Kidder, Chas. W., Stoneham, Mass.
 Knapp-Greenwood Co., Farmington, Mass.
 Maryland Casualty Co., 75 Kilby st.
 Miller, Chas. E., 97 Reade st.
 Moore-Smith Co., 250 Devonshire st.
 Nuggey Polish Co., New York City.
 Post & Lester Co., 821 Boylston st.
 Russell Co., T. F., 105 Summer st.
 Salman & Co., John A., 17 Bromfield st.
 Springfield Portland Construction Co., Springfield, Mass.
 Travelers' Insurance Co., Hartford, Conn.
 Twin Elm Spring Co., Lexington, Mass.
 Walker Lithographing Co., 221 High st.
 Ward & Sons, Edgar T., 23 Purchase st.
 Winestock Mfg. Co., Perkinsville, Vt.

ENDURANCE RUN FROM NEW YORK TO BOSTON SHOW

THAT New York automobile circles welcome a chance for a run to Boston has been shown by the fact that, to date, there are twelve entries promised by tradesmen and private owners to Mills & Moores, who have been given charge of the first spring endurance contest. The Chester I. Campbell trophy has been donated by L. H. Perlman, the New York Welch agent, who is the present holder of it, with the suggestion that it be put up for annual competition, to be won twice to be retained. Two Franklin cars, two Loziers, and one each of the following

have been listed: Haynes, Stearns, Renault, Züst, Mora, White, Thomas and Acme. It is confidently expected that many more than this will start from Columbus Circle on next Thursday morning, March 11. R. H. Johnston of the White Company, will precede the contestants and pilot them from Worcester into Boston, while members of the various local clubs will show the way through New Haven, Hartford, and Worcester. The cars will run on a twenty mile an hour schedule, and will be required to check at a number of places en route.



BOSTON, March 4.—No section of the country possesses so much wealth in proportion to area as New England; no group of six States has such good roads, and in few parts of the world can the traveler enjoy such a variety of scenery in comparatively a short journey. It is no wonder, therefore, that this northeast corner of the nation attracts motorists from far and wide, and that its people were first to take up the automobile.

Primarily New England is not an automobile manufacturing center; there are a few factories and they produce some of the best cars, but the main interest of New England in automobiles is as a consumer rather than a producer. In Massachusetts alone there are some 18,000 cars. Probably in the other five States there are at least as many more, and during the Summer months thousands of machines from every part of the union use the New England roads. The White Mountains, the Maine coast, the Berkshires and Cape Cod are accustomed to the registration tags of Illinois and Indiana, of Pennsylvania and of New Jersey and other places more remote. Over the main thoroughfares there is a tremendous traffic of pneumatic-tired vehicles. That New England appreciates the value of autoing cannot be denied and that it is trying to make things pleasant for the motorist also is true. Massachusetts was one of the very first States to adopt a motor vehicle law, and it was upon the statute of 1903 that many of the laws passed in other States have been based, though some of the copies have been far less lenient toward the motorist than the original. And from year to year, often at the request of the autoists themselves, the law has been changed until it is regarded as one of the fairest statutes of the kind in existence. Some of the other States have gone further than Massachusetts. Connecticut has a new law, and in some respects a better one; Rhode Island has a more liberal speed limit, and the laws of New Hampshire and Maine excel in some points. But taken as a whole, the New England States have been fair to motorists in the past in the matter of laws. Now they are considering a further step in the adoption of a uniform law. Such a law has been drafted and is before the law-making bodies in several States. If it is generally adopted, New England will set the rest of the country another example and tourists by motor car will appreciate the advantage of being able to travel from one State into another without being under the necessity of familiarizing themselves with a new code of laws and rules every time a boundary line is crossed.

But New England is doing much more for the automobilist than providing fair and uniform laws; it is giving him what is far more important, the best roads in America. Here again Massachusetts leads. The old Bay State has something like 700 miles of scientifically built, smooth macadam highways stretching from one end to the other of the commonwealth and connecting all the important centers of population. And this Spring, when one little stretch of State highway near the famous Jacob's Ladder, in the Berkshires, is finished, a motorist may enter Massachusetts at its westerly end and may travel its whole length to Boston almost without leaving the delightful macadam road. New Hampshire has taken up the good-roads movement since automobiles began to throng its highways. So far it has worked in a small way, building pieces of road here and there with the co-operation of the local authorities. But the Granite State is

now proposing to branch out on a larger scale, by constructing three trunk lines of State highway over the routes most traveled by motorists. One of these will begin at Portsmouth and extend up through the Ossipees and through the Crawford Notch of the White Mountains. The second will be through the Merrimac Valley, taking in the important cities of Nashua, Manchester and Concord. The third route will be that of the "Ideal tour," up through the Connecticut Valley. Maine has not yet felt the demand for good roads as strongly as some of the other States, but the strength of motoring is growing in the Pine Tree State, as indicated by the vigorous shows that have been held in Portland and in Bangor, and there is little doubt that soon there will be improved roads along the main lines of vehicular traffic. Vermont also has felt the necessity of catering to the growing number of citizens and visitors who use the modern method of travel, and Rhode Island has done much in providing roads.

Connecticut is constantly extending its macadam highways, and disputes with Massachusetts for supremacy in having the most complete system. So far all the New England States have been working along lines of their own, suiting their road building to local needs, but now it is seriously proposed that they work in unison to provide a series of through trunk routes, so as to give autoists continuous good roads from one State into another. Thus, it may not be so very far in the future when the visiting motorist may have the best of highways, from the time he reaches the western boundary lines of Connecticut or Massachusetts, until he reaches his destination at a Maine seaside resort, or a White or Green Mountain retreat. There is just one shadow on this fair picture of New England as the motorist's Utopia, for the best of roads, no matter how well constructed, wear out under heavy traffic and, it is claimed by some, more rapidly under the swiftly moving and heavy motor cars than under horses and horse-drawn vehicles. Authorities argue that, in order that they may enjoy the sport, motorists must have good roads, but if they have them, and aid in wearing them out they should contribute toward their restoration. Therefore, there is a very strong movement, in several of the New England States, toward increasing the tax that is imposed on automobiles under the name of a registration fee. The most popular method of doing this is the graded horsepower tax included in the proposed uniform law.

Automobiles have been sold so long and in such quantities in the New England States that it would seem almost as if the buying power of the public must be exhausted, or that everybody of means must be supplied, but the contrary seems to be the case. It would be hard to find a dealer who does not predict that 1909 will be the biggest year yet. Trade has been good all through the Winter, and there is every prospect that it will hold good throughout the Spring. Many a dealer, who took a liberal allotment of cars last Summer, has been clamoring at the factory for more to satisfy his customers, and people who visit the Boston show with their minds made up to buy some popular model and with money in their pockets will find that the very best they can get is a late May or a June delivery. One prominent Boston dealer, who has the larger part of New England as his territory, will go into the show with more than 400 cars actually sold this season. Good business is not in isolated cases, but

is to be found all along the line and the demand is from all parts of New England. Few of the dealers in the best known cars have had as many enclosed cars as they could have sold during the Winter months, and they now find themselves in much the same position in respect to the more popular types of touring cars. It does not seem to matter much, this year, whether a dealer has a \$4,000 car or one at \$500—the demand is strong.

There are, naturally, more customers for the low-priced than

for the high-priced cars. If anything, the touring car is the more popular model this year, purchasers apparently caring less for the roadster than they did when it was more of a novelty, and the newest four-seated rigs have not caught on with very much promise of popularity. It is surprising, say Boston dealers, whose operations extend all over New England, the number of machines the smaller cities and the country districts are taking this season. The demand outside the large cities is very heavy.

SOME PREVIOUS HISTORY OF BOSTON SHOWS

BOSTON, March 4.—The exhibition of motor vehicles and their accessories, which will be opened in Mechanics' Building on Saturday evening, is called the seventh annual Boston automobile show, under the auspices of the Boston Automobile Dealers' Association. This is a correct statement, so far as it goes, for the dealers' association was organized in 1902 and held its first show the following year. But in giving the impression that Boston automobile shows date back only seven years it is incorrect, for the first exhibition of automobiles in Boston took place in 1898, eleven years ago, and it was held in Mechanics' Building, where the present show is housed.

The 1898 exhibition was a sort of side-show of the Mechanics' Fair, an industrial exposition held usually every three years by the Massachusetts Charitable Mechanics' Association. The main floors of the building were occupied with displays of all sorts of machinery and apparatus of various sorts, but down in one corner of the basement, in a space not larger than is occupied now by any of a dozen large concerns, was the "horseless carriage" exhibit. The display was visited by many people and the Massachusetts Charitable Mechanics' Association offered prizes aggregating \$1,100 for automobile events one afternoon during the fair at the Charles River bicycle track, then in its glory. For several years after the first display of automobiles in Boston there were annual exhibits in connection with some larger production, like a food fair, the promoters being glad to obtain two or three of the crude vehicles of that day as curiosities.

In 1901 a group of promoters came to the city and proposed to have a big show of automobiles in Mechanics' Building. The manufacturers, however, had not been educated up to paying the prices for show space that prevail nowadays, and they were staggered by the cost of exhibiting. Few of them, therefore, took kindly to the automobile show proposition, and the grand display amounted to little. The public did not patronize it very generously and those that went saw comparatively few machines. By the time the next year came around, however, Boston had an automobile club, which desired to be as prominent as possible, and a strong nucleus of dealers in the city got together and proposed to run the 1902 show. They were not over-ambitious and were content to secure for their show a section of Mechanics' Building, in which a large fair was being held. The clubmen and the dealers co-operated and worked for the success of the show, and for its size, it was interesting. There was a street parade of automobiles, the cars starting at Mechanics' Building and passing through the business section of the city. There were steam, electric and gasoline cars in line, and the public took much interest in the parade.

It was during the progress of the 1902 show that the dealers formed an organization for the purpose of co-operation in trade matters and for show promotion. But despite the advance the industry and the trade had made by 1903 the first exhibition of that year was not successful. The failure was attributed to the inability of the clubmen, who had assisted in the previous show, and the dealers to work together. In the early Winter they decided to have a union show, but it developed very soon that both parties to the scheme wanted to be in charge, and the result was the usual one—they separated. The clubmen, who were practically all private owners, organized the New England Automobile Association and secured the main hall of Mechanics'

Building for a week in February, when the New England Kennel Club was using the rest of the building for its dog show. Very few of the dealers put cars in this show with the result that the display was made up largely of privately owned cars, and the chief attractions were "stunts" which were performed in a small ring and in the open space in the center of the hall.

The first show held exclusively by the dealers was in March of 1903, and it took place in Symphony Hall. There were about eight spaces, and the exhibit included the Darracq, Franklin, Crestmobile, Rambler, Eclipse, Northern, Winton, White, Columbia, Peerless, Baker electric, Locomobile, Pope-Robinson, Prescott steamer, Stevens-Duryea, Knox, Renault, De Dion, Autocar, Oldsmobile, Packard, Stanley, Upton, Waltham and a few others. The descendants of some of these cars will be seen in the coming Boston show; others have passed almost from memory. The show lasted a week and was very successful, the gate receipts exceeding the expectations of the promoters. Symphony Hall was also used for the 1904 show, which was held by the dealers' association, but more of the building was required than the previous year and there was a more comprehensive display of automobiles, motorcycles and motor boats. This show saw the beginning of uniform decorations at automobile shows, a practice used ever since in Boston.

When preparations began for the 1905 show it was apparent that Symphony Hall would not be large enough to hold all the exhibits, and the association moved down to Mechanics' Building, taking the whole structure for a week in March. That year there was a split among the dealers, and some of them conducted a separate shown in Symphony Hall. The main show was successful, while the smaller show did not have a very large attendance. In 1906 both Mechanics' Building and Symphony Hall were used for show purposes, the Symphony Hall space being taken largely by the representatives of imported cars. That year Horticultural Hall, which had been used previously for motor boats, was not taken, the motor boat division being in the basement of Mechanics' Building. The 1906 show was a great success and the halls were crowded all through the week.

It was in 1907 that Manager Chester I. Campbell conceived the idea of a New England apple orchard as the setting for the automobile show, and his success in carrying out that idea was notable. The demand for space was greater than ever, two years ago, and the management was compelled to take a lease of Horticultural Hall to accommodate all who wished to exhibit automobiles, motor boats and accessories. That plan of having one part of the show separated from the main exhibit was never successful, and though everything possible was done in 1907 to induce people to visit the Horticultural Hall display the attendance was not very good. The main display in Mechanics' Building was crowded steadily. Before the end of the show week, however, it became clear that the automobile and the motor boat had reached the parting of the ways. The automobile trade has become so large, and the Boston show was recognized by the manufacturers as so important, that the entire space in Mechanics' Building was needed. On the other hand, the motor boat people objected to being crowded into the basement with inadequate space, and with the counter-attraction better placed in the same building. They, therefore, decided to go their own way, and last year held the first separate show of motor boats.

BAY STATERS IN NEW HOME

BOSTON, March 1.—Housed in the beautiful Carlton Hotel on Boylston street at the entrance to the park system, occupying the major portion of the ground floor, in quarters which in this city are acknowledged to be the most commodious and richly decorated clubrooms in Boston, the Bay State Association is luxuriously and comfortably now at home, with surroundings that will increase its popularity among its members and consequently broaden the scope of its activities.



L.R. Speare
President



Hotel Carlton
Home of Bay State Club.



J. Fortesque
Secretary

The history of the Bay State Association has been intimately linked with its clubhouse features, having moved several times from place to place, as the membership increased and required more room, and as the importance of the organization in automobiling circles grew. Like many other now prosperous bodies, it began its existence in a very quiet and unostentatious manner. In December of 1904 a few of the prominent automobilists of Boston thought the time was ripe for an active association to promote and protect motoring interests, when legislators were threatening the passage of hostile bills.

Another object of the association was to further the automobile industry by the promotion of tours, contests and races. How well it has succeeded is now well known to the automobile world. At its start it was fortunate to possess such prominent motorists as Harlan W. Whipple, Elliot C. Lee, both past presidents of the American Automobile Association; L. R. Speare, president then and now of the Bay Staters, first president of the National body; H. L. Bowden, and F. Tudor.

During the first years of its existence its location was at the Lenox Hotel, but this place soon proved inadequate to accommodate the rapidly increased membership, and the casino of the Woodland Park Hotel, at Auburndale, was secured. This, in its turn, was soon found insufficient to answer the requirements of the membership of 600 which the association had reached. A committee was chosen to select a suitable house in the city, and the association took possession of 282 Dartmouth street, one of

the choicest locations in Boston. After occupying this place for two years, the present location was suggested and taken.

The Carlton was erected at a cost of half a million dollars by its present owner, Gardner H. Shaw, and in addition he expended \$10,000 on the alterations and decorations of the clubrooms. A

number of beautiful rooms were set aside and specially furnished and finished. The café is excellent, and the billiard room is unique, being furnished in dark green oak to represent old hand-hewn timbers, paneled in the same style, with a heavy beamed ceiling and an antique fireplace. A special entrance has been constructed of marble for the use of the members. There is a large waiting room joining the secretary's office, and large rotunda,

used for a reading room. The design of this room is Colonial.

The present officers are: Lewis R. Speare, president; Harlan W. Whipple, vice-president; J. S. Hathaway, treasurer; J. Fortesque, secretary; directors, G. W. McNear, Dr. J. F. Hovestadt, F. A. Hinchcliffe, Gardner H. Shaw and C. F. Whitney.

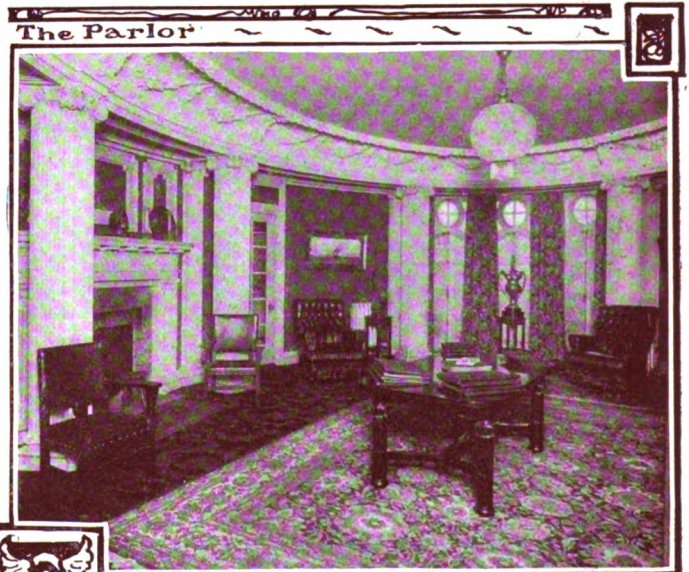

The Parlor

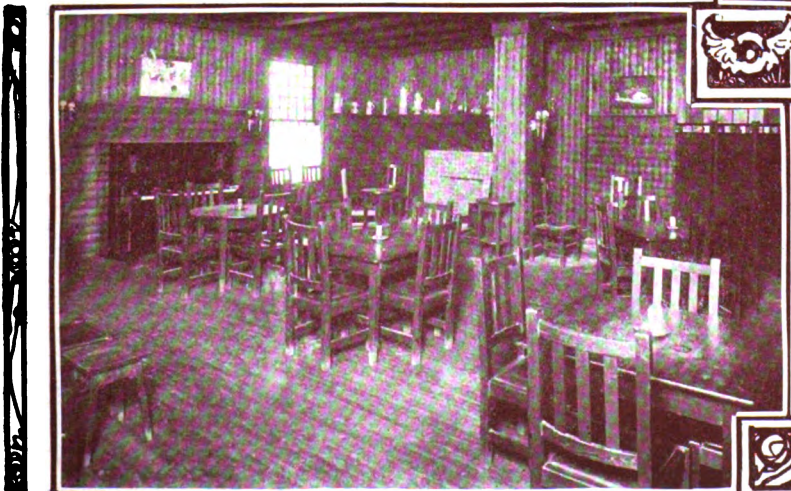

The Cafe

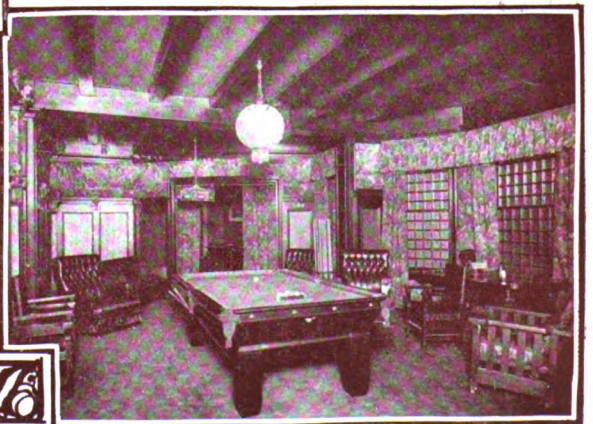

Billiard Room

BOSTON AS A MOTOR MART FOR NEW ENGLAND

BOSTON, March 4.—The automobile trade in Boston, like most other things in the Hub, is conservative; it is not subject to sky-rocketing and sudden changes, and a firm once established is pretty sure to stay in business, subject to the ordinary changes. For this reason changes are not frequent, and in the automobile district it is easy to find men who have been handling the same car for a long series of years, some of them dating back to the very earliest days. That not a single Boston automobile firm of recognized standing came to grief during the trying times of last winter, when from all over the country came reports of failures, is strong testimony of the strength of the local trade.

Geographically the trade has spread out, the agents and branches taking larger quarters as their business has increased. Almost anybody who has been familiar with the local trade for a few years back can remember when the major part of the automobiles were sold in old railroad sheds and other inexpensive quarters in the vicinity of Park Square. Only the most courageous dealers occupied stores along Columbus avenue, and they in the main were bicycle dealers who had taken on the automobile as a side line, but who depended upon the bicycle trade for the larger part of their income.

How Boston's Auto Trade Has Changed Location.

In late years all this has changed, and the automobile district extends from Massachusetts avenue on the south to Park Square on the north, a distance of a mile and a half. Along upper Boylston street the owners of property cannot rebuild fast enough to supply automobile salesrooms, even at the very high rents that are charged. It is along Boylston street that the greatest growth has taken place during the past year, and there

are now in process of reconstruction a number of buildings which, when completed, will be occupied by automobile or accessories' dealers. The great demands for space in the locality have been evidenced by the many requests for information.

Some Trade Changes Since the Last Show.

Since the last show several concerns have gone out of business or been succeeded by others with different names. The Harry Fosdick Company, which used to handle the Atlas and the Springfield, retired, and the F. E. Randall Company, which had the Pennsylvania and Pullman agencies, is also no longer on the trade list. The W. A. Frederick Company has been succeeded by the American Automobile Company, and the E. P. Blake Company has given up the retail end of the Jackson business, retaining only the wholesale department. The Columbia Motor Vehicle Company, the branch of the Electric Vehicle Company, has been closed, and recently Morgan B. Kent, the Stearns agent, withdrew, John H. MacAlman taking the agency. The Shawmut Motor Car Company, whose activities have been greatly hampered by a fire in its factory at Stoneham, no longer has a Boston salesroom, its Boylston street quarters being occupied now by the Michelin Tire Company. The Buick Motor Car Company's branch has succeeded Stranahan-Eldridge Company as the sales representative of the Buick. The Dragon Motor Company branch closed with the company, and the Morrison & Price Company, agents for the Rainier and Wayne, dissolved.

There are in Boston practically three score agencies and branches, and they represent 75 different makes of cars, a larger number than in any previous year. Affiliated with the trade in one way or another are some 350 concerns. There are nearly a

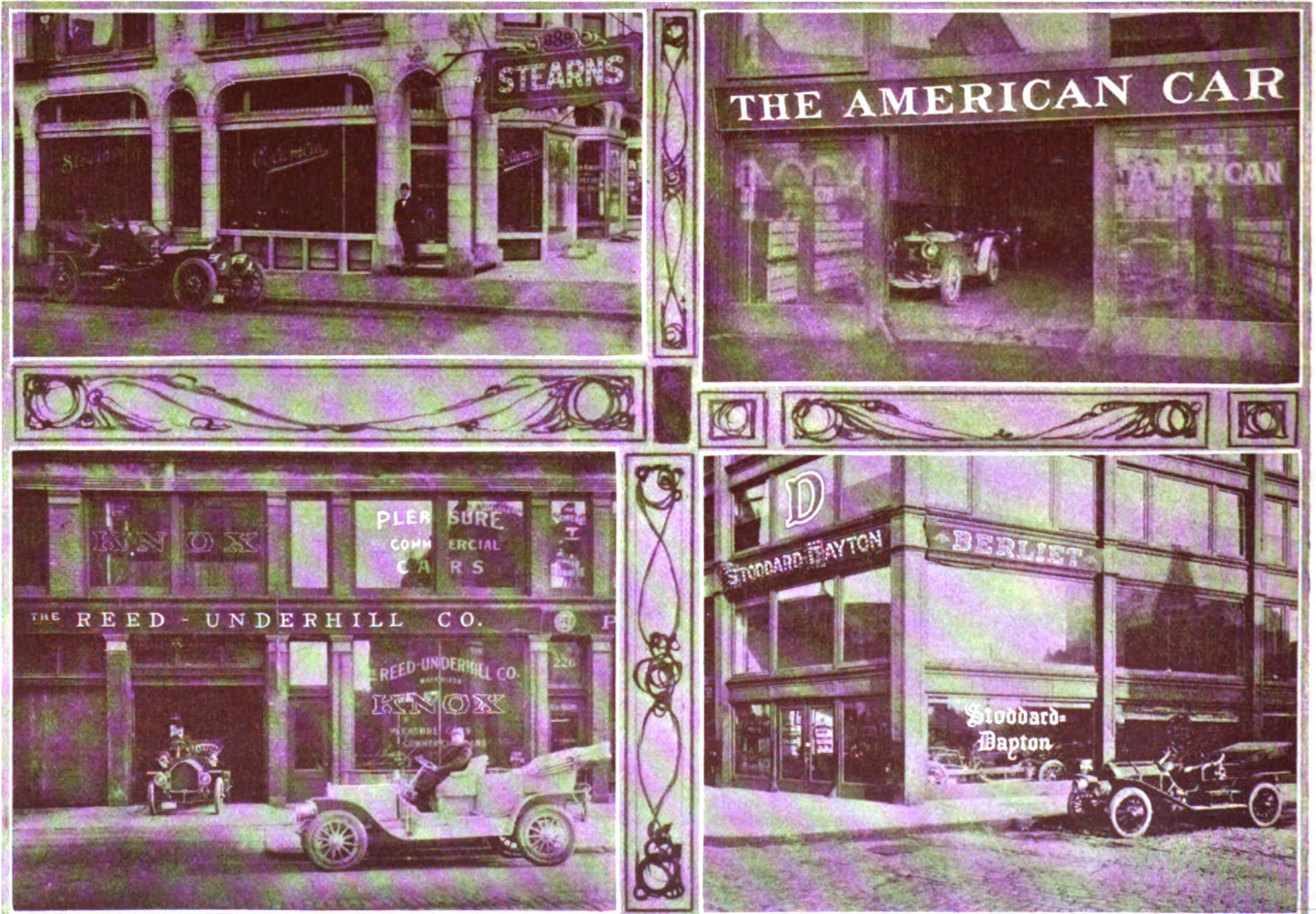

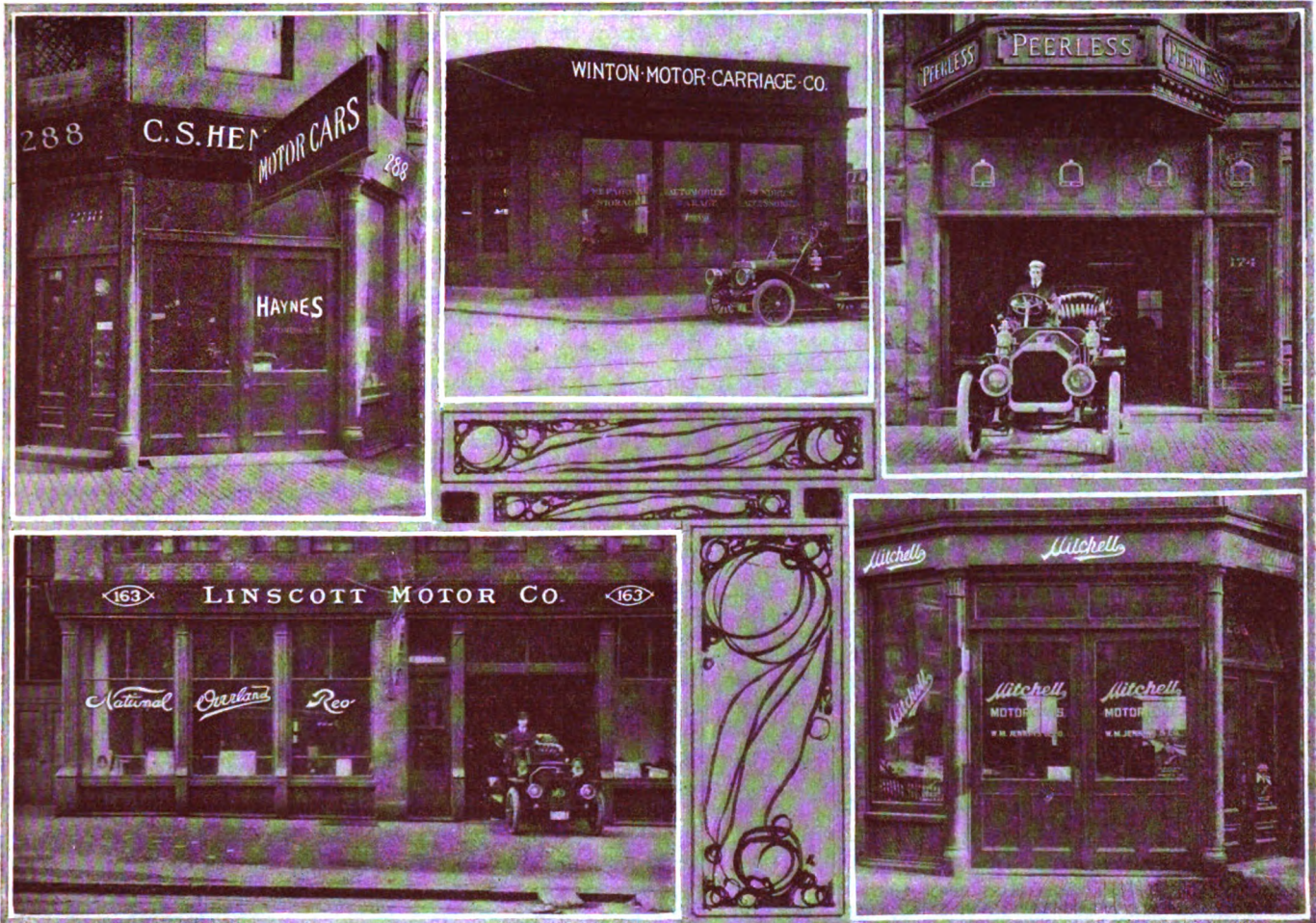

score of large garages. A complete list of the Boston automobile trade and the street locations is herewith appended:

- | | | | |
|---|-----------------------------|--|--------------------------|
| Sewing Machine Supply Co., 22 Lincoln St..... | Inter-State. | J. H. MacAlman, 889 Boylston St..... | Columbia, Stearns. |
| Harry S. Merry, 24 Tennyson St..... | Jackson. | H. C. & C. D. Castle, 893 Boylston St..... | Lozier. |
| American Automobile Co., Motor Mart..... | American. | Whitten-Gilmore Co., 907 Boylston St..... | Thomas, Chalmers. |
| Auto Motor Co., 11 Park Sq..... | Pennsylvania, Regal. | J. W. Bowman Co., 911 Boylston St..... | Stevens-Duryea. |
| Curtis-Hawkins Co., Motor Mart..... | Chadwick, Speedwell. | Hol-Tan Co., Hereford St..... | Lancia. |
| Buick Motor Co., Motor Mart..... | Buick. | The White Company, 320 Newbury St..... | White. |
| Alvan T. Fuller, Motor Mart..... | Packard, Cadillac. | Premier Boston Depot, 1008 Boylston St..... | Premier, Selden. |
| F. E. Wing Motor Car Co., Motor Mart..... | Marmon. | Studebaker Bros. Co., 1020 Boylston St..... | Studebaker, E-M-F. |
| Crown Motor Car Co., Motor Mart..... | Pullman, Glide. | Maxwell-Briscoe Boston Co., 121 Massachusetts Ave..... | Maxwell. |
| Park Square Auto Station, Motor Mart..... | Alco, Stoddard-Dayton. | Grout Auto Co., 117 Massachusetts Ave..... | Grout. |
| General Automobile Co., Motor Mart..... | Holsman. | Algonquin Motor Car Co., 97 Massachusetts Ave..... | Oldsmobile. |
| Boston Motor Car Co., Motor Mart..... | Acme. | Thomas B. Jeffery & Co., 93 Massachusetts Ave..... | Rambler. |
| Everett S. Litchfield, Motor Mart..... | Austin. | Panhard & Levassor, 92 Massachusetts Ave..... | Panhard. |
| George H. Lowe, 11 Park Sq..... | Gyroscope. | Roy E. Faye, Quincy Sq., Cambridge..... | Matheson. |
| Fred S. Smith, 38 Columbus Ave..... | Apperson, Autocar, Oakland. | Alfred Cutler Morse, Motor Mart..... | Renault. |
| Ford Motor Co., 147 Columbus Ave..... | Ford. | Dodge Motor Vehicle Co., Irvington St..... | Pope-Hartford, Waverley. |
| George J. Dunham Co., 188 Columbus Ave..... | Royal Tourist. | Butler Motor Car Co., Harcourt St..... | Rapid. |
| Peerless Motor Car Co., 176 Columbus Ave..... | Peerless. | French Carriage Co., 92 Summer St..... | Clement, Balley. |
| Linscott Motor Co., 163 Columbus Ave..... | National, Overland, Reo. | South End Motor Car Co., 24 E. Concord St..... | Brush, Atlas. |
| Winton Motor Carriage Co., 148 Berkeley St..... | Winton. | C. A. Eaton, 64 Pembroke St..... | Lambert. |
| Reed-Underhill Co., 222 Columbus Ave..... | Knox. | D. P. Nichols & Co., 11 Edgewood St..... | Frayer-Miller. |
| W. M. Jenkins Co., 286 Columbus Ave..... | Mitchell. | A. F. Neale, Motor Mart..... | Baker. |
| C. S. Henshaw, 288 Columbus Ave..... | Haynes. | G. H. Proctor Supply Co., 25 Irvington St..... | Mora. |
| F. R. Parker, 243 Columbus Ave..... | Elmore. | Stanley Motor Carriage Co., Newton..... | Stanley. |
| Locomobile Company of America, 589 Boylston St..... | Locomobile. | The G. H. Pixley Co., 239 Columbus Ave..... | Pixley. |
| Franklin Automobile Co., 671 Boylston St..... | Franklin. | Stanley Webster Co., 1024 Boylston St..... | Pittsburg. |
| Kissel Kar Kompany, 741 Boylston St..... | Kissel Kar. | General Vehicle Co., 84 State St..... | Electric trucks. |
| Mills-Kennedy Co., 733 Boylston St..... | Welch. | | |
| J. W. Maguire Co., 745 Boylston St..... | Pierce. | | |
| Fiat Automobile Co., 885 Boylston St..... | Fiat. | | |
| Bartlett & Jacobs, 887 Boylston St..... | Allen-Kingston. | | |

These vacancies in the trade list have been more than filled by new agencies. The Sewing Machine Supply Company, of 22 Lincoln Street, has taken the Inter State agency with Victor A. Charles, formerly Rambler branch manager, as its agent. Harry S. Merry, of 24 Tennyson street, is now in charge of the Jackson retail sales, and the Auto Motor Company is a new firm that



handles the Pennsylvania and the Regal-Detroit. George H. Lowe, the veteran dealer, is connected with the Gyroscope. The Crown Motor Car Company has lately taken on the Pullman line, and Fred S. Smith has added the Oakland to his agency, which includes that for the Apperson and the Autocar. George J. Dunham has left the city to become president of the Royal Tourist Company, but his name remains in the George J. Dunham Company, Royal Tourist agents. The Linscott Motor Company has added the Overland to the National and the Reo. J. H. MacAlman now represents the Stearns as well as the Columbia, and the Kissel Kar Kompany is a newcomer during the year, succeeding the H. C. Stratton Company. The Studebaker branch has the E-M-F. agency and Grout Motor Car Company has the agency for that car.

Branch Houses of Leading Makers Are Plentiful.

Many of the leading manufacturers maintain branches in Boston, such as the Ford, Buick, Peerless, Winton, Locomobile, Franklin, White, Premier, Studebaker, Maxwell and Rambler. The importers are also well represented. The Panhard & Levassor, Hol-Tan Company and Fiat have branches, and there are agencies handling the Renault, Hotchkiss and other cars

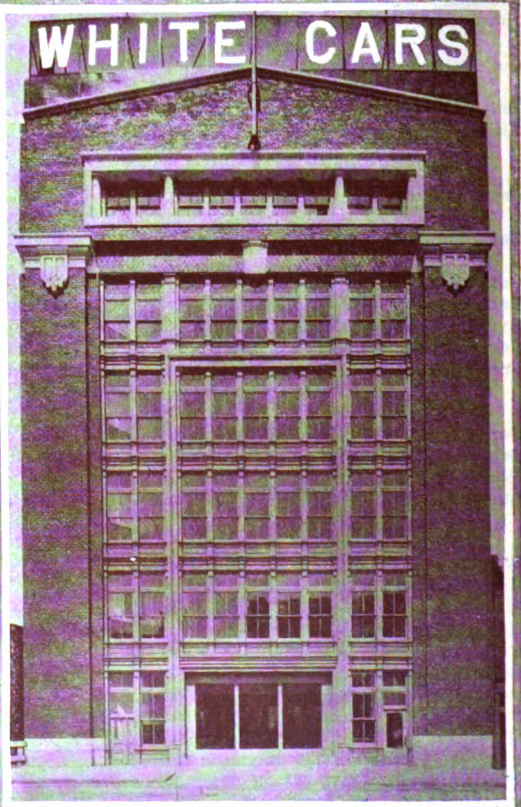
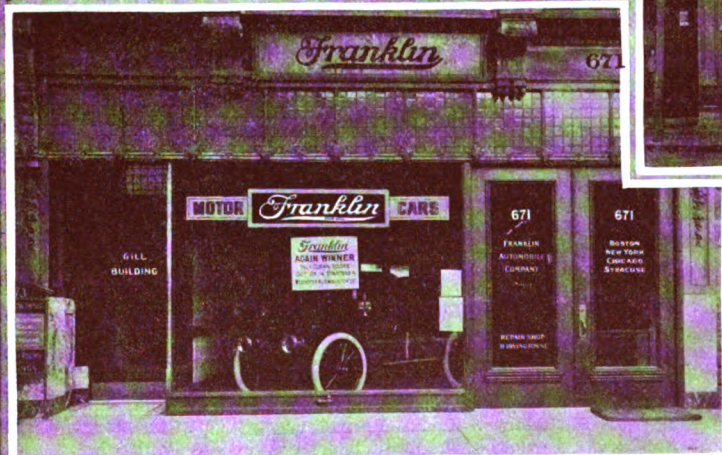
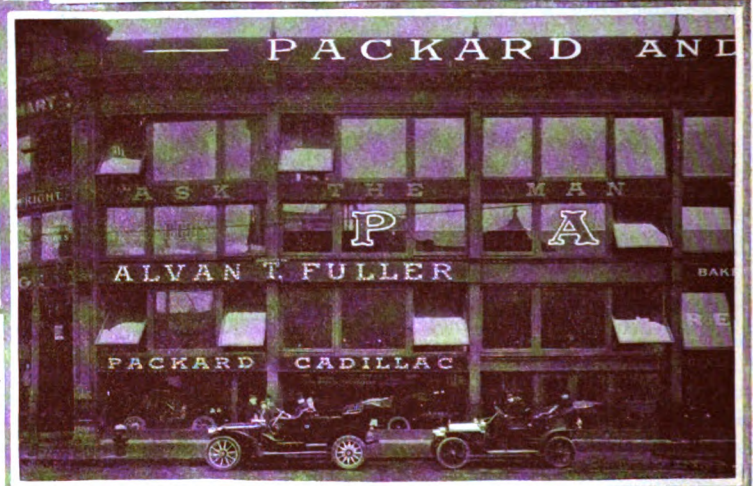
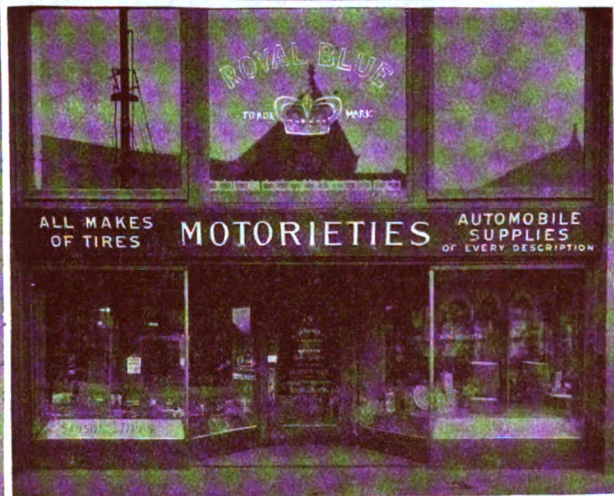

from abroad. The personnel of the trade has changed but little. Alvan T. Fuller, of the Packard and Cadillac; J. W. Maguire, of the Pierce, and F. E. Wing, of the Marmon, are some of the longest established dealers who have handled the same cars for years. J. W. Bowman, the Stevens-Duryea agent, is comparatively a newcomer, having been in business here only two years, but he has won a high place in the local trade and is considered one of the largest dealers in the city. The Reed-Underhill Company, the Knox agents, date back to the early days.

ENDURANCE RUN FOR DETROIT DEALERS

DETROIT, March 1.—An outgrowth of the local automobile show is a four-day endurance run that will be given by the Detroit Automobile Dealers' Association, April 27 to 30. The first day's run will be to Port Huron and return; the second to Jackson and back; third to Lansing and return; fourth to Pontiac, Rochester, Orion, Oxford, Lapeer, Flint, Fenton, Holly, Clarkston, Pontiac and back to Detroit. A day's mileage under these schedules would be from 100 miles up, and suitable prizes will be awarded in the three classes into which entrants will be divided. Cars will be parked each night around the Tuller Hotel.

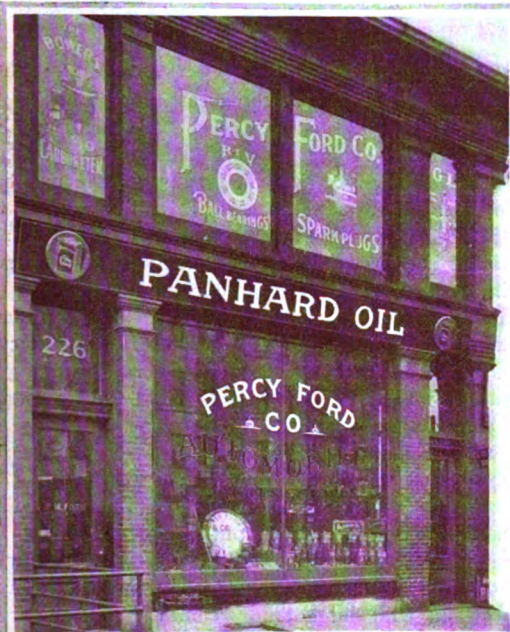
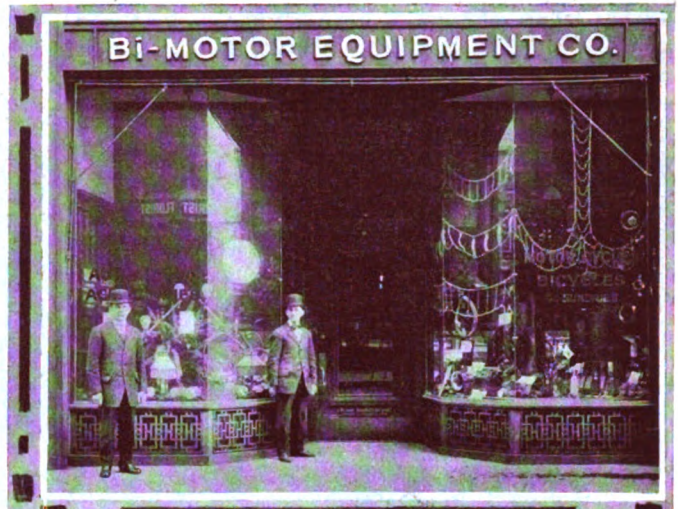

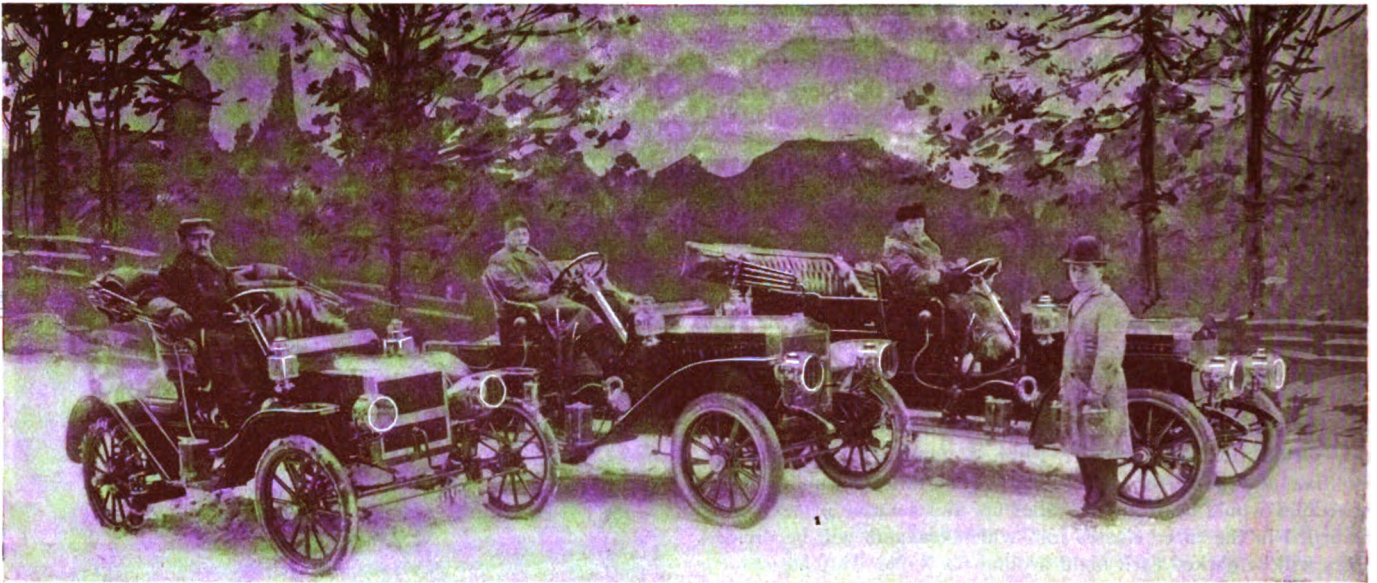

Maxwell Demonstrating Models that Are Making a Tour of New England, Visiting the Agencies, Under Their Own Power.

MAXWELL SHOW CARS ON PARADE.

BOSTON, March 4.—A distinct novelty in a demonstrating or show campaign has been started throughout New England by the Maxwell-Briscoe Boston Company, that of going to nearly all of the important towns, and first parading the new models with all the local Maxwells in a decorated procession, and then of showing the new members in the evening at the headquarters of the various agents.

Ford and Lyon, the Fitchburg Maxwell agents, originated the scheme for a three-day show in January, with a parade each day, between the hours of 12 and 1, of the new models and all the local cars available, covering the business and residential streets, after which the 1909 cars were on exhibition during the afternoon and evening. The result was so profitable that the Boston branch decided to go all over New England, taking the cars under their own power from place to place.

The following towns and cities were visited: In Massachusetts, Malden, Brockton, Worcester, Fall River, Taunton, Waltham, Haverhill, Peabody, Springfield, Milford, Maynard, Webster, New Bedford, Attleboro, Lowell, Lawrence, Gloucester and Holyoke, and Woonsocket and Providence in Rhode Island. After the Boston show the cars will again be sent upon the road.

GARAGE FOR ELECTRIC CARS ALONE.

BOSTON, March 4.—As a result of the great increase in the use of electric automobiles in this city in recent months, there has been built here for the Dodge Motor Vehicle Company, the Boston agent for Waverly electrics, the largest garage and battery station for electric cars in the east. Mr. Benway, of the local concern in speaking of the great increase in business and the building of the new place, said, "The erection of this structure will facilitate our caring for practically any number of electric cars and our force of battery experts and electricians, who are familiar with all makes of storage batteries and electric vehicles, places us in a position to turn out work pertaining to them better than ever before. We are able to do work promptly and at lowest prices, and in addition to repairing or caring for cars, we are now building sparking and vehicle batteries of our own, guaranteed as to life and mileage per charge.

"This, with our line of Waverly electrics, including ten models of pleasure cars ranging in price from \$1,150 to \$2,150, has placed us in a position to please anyone looking for electrics. We have found many who have wished to buy cars of this type of motive power but who did not do so until a special garage and business for them was opened."

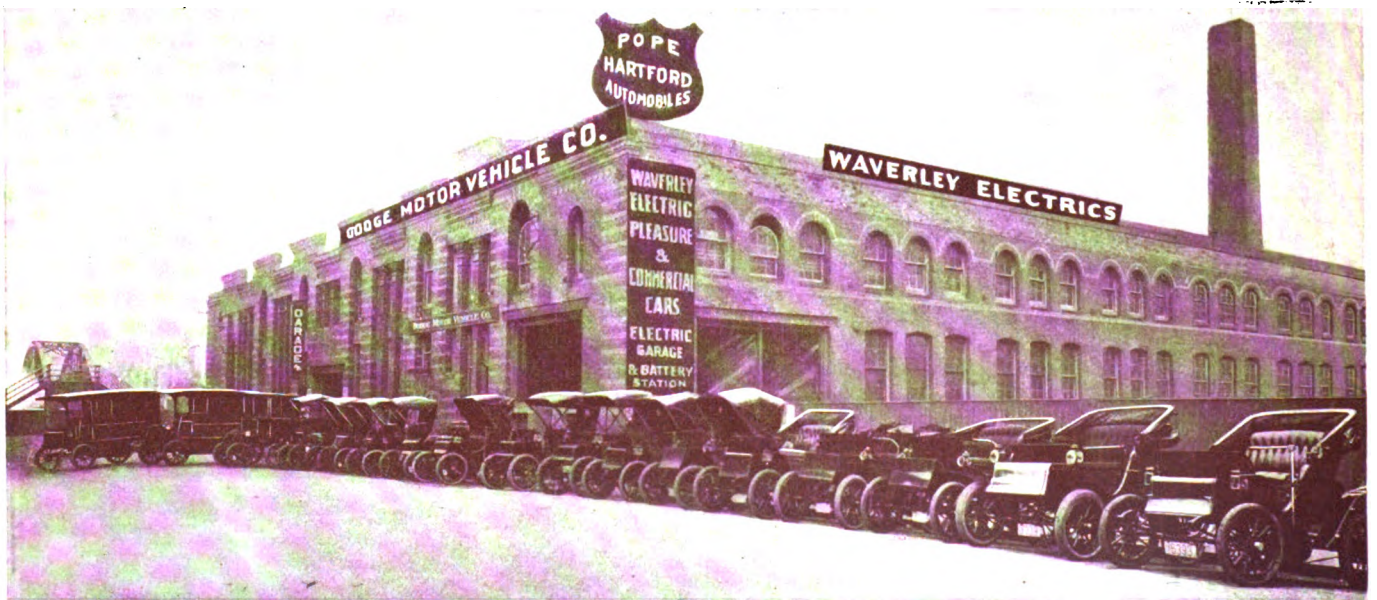

A Leading Boston Garage that is Exclusively Devoted to the Sale and Storage of Electric Automobiles.

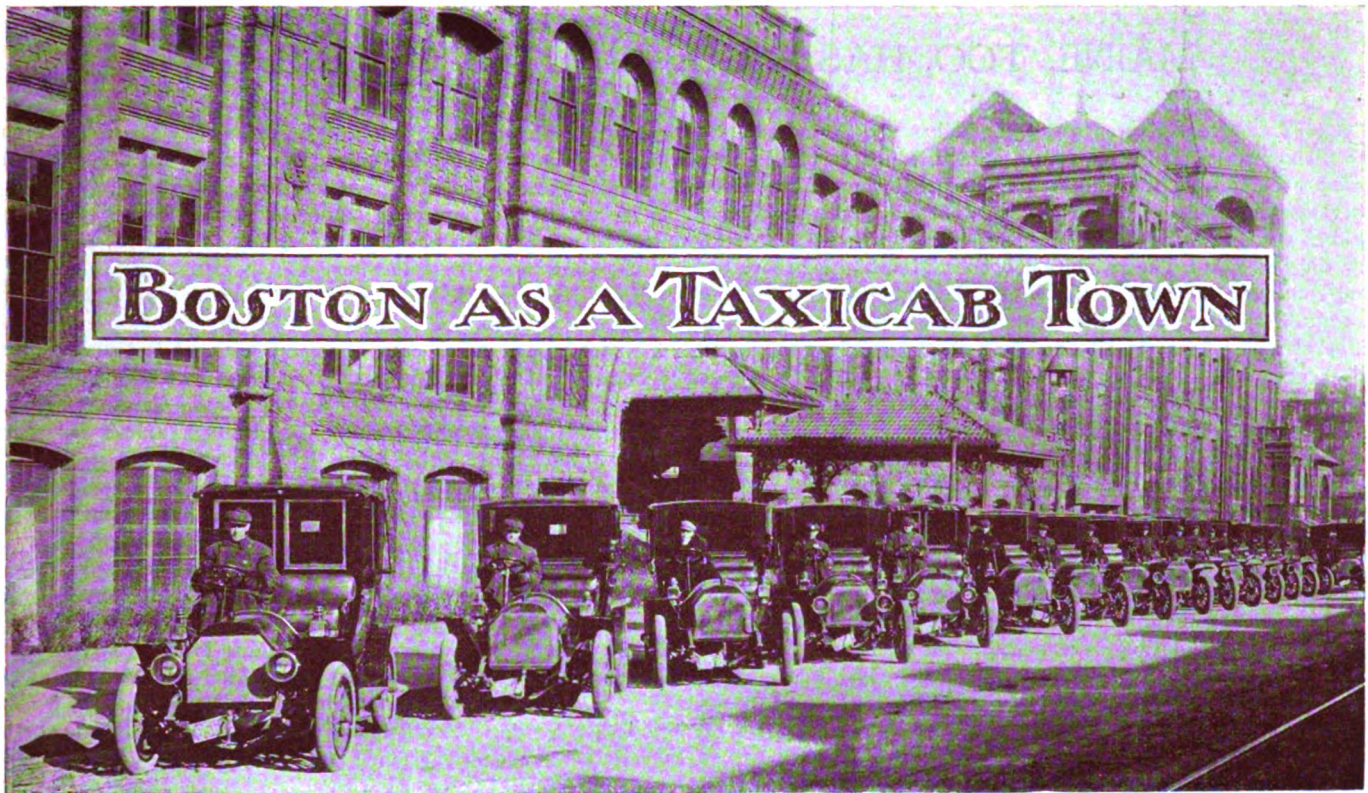

Equipment of the Taxi-Service Company of Boston, Which Will Have the Exclusive Taxicab Service Privilege for the Boston Show.

BOSTON, March 4.—Taxicab use in this city, according to A. E. Morrison, has undergone much change in recent months, so that instead of proving a failure where they had not been successfully used before, they have proven exceedingly popular and now really a necessity in transportation. The Taxi-Service Company, the largest in the field, began operating its Berliet cabs on September 1 of last year, and after six months of work its experience has shown that Bostonians appreciate this quick method of getting from place to place.

Facing an outlay of enormous sums of money for machines and equipment, and with warnings of failure from the records of other concerns which had tried the business, it was freely predicted that success would be impossible, especially because there was already one other company in the field and not room for two. Time has proven the fallacies of these opinions, for the new firm now has forty-three cabs in this city alone, with twenty-five more coming at a rate of five each week, covering the entire field around the city, including the leading hotels, theatres, stations and other places where it is natural to find persons to whom the use of taxicabs is now necessary, or at least convenient.

With H. Bradford Lewis as president, George F. Smith as vice-president, John M. Stewart as treasurer, and A. E. Morrison as manager, and a great deal of courage to face the obstacles thrown up, the company started in the fall and its judgment has proven sound by the phenomenal success of the enterprise. There are few transportation companies which pay for a long time after beginning, but the taxicabs immediately found favor with the public, and the expenses for operating the cars on the very first day were covered by the receipts. The financial condition of the company is now splendid, for it owns every one of its cabs and is able to pay dividends upon its stock.

Knowing the mistake of false economy in purchasing cheap or untried equipment, the highest grades of cabs were thoroughly investigated, both as to quality and appearance, without special regard to price, feeling that an expensive machine might be the more economical in the end, through lack of necessity for extensive and frequent repairs. A powerful car was required, with ample seating capacity, and one that could be used by any one

without feeling that a cheap-looking machine was being employed. The product of the American Locomotive Company, the Berliet cab, was selected, and again the sound judgment of the firm was shown, for these machines have given the excellent service and low up-keep expense promised by the makers.

To distinguish them from competitors, the door of each has been painted a dull yellow, and they can be readily recognized at some distance. So much business has developed that at times only about 90 per cent. of it can be handled, though, of course, each succeeding week, with its arrival of five cars, is showing less of a loss of the business that calls for taxicabs. The company controls the service at the hotels Lenox, Thorndike, Brewster, Boston Tavern, Tuilleries and Empire and the National Shawmut bank, besides meeting all trains at the South Terminal Station, and following up service desired at many other places in and around the Hub.

Having made a success of its work here, the Taxi-Service Company some time ago decided to branch out and is now operating ten Berliet cabs in Providence, R. I., and has just established a branch company in New York City, taking over the service of the Waldorf-Astoria, the Holland House and five smaller hotels. It is operating sixty automobiles and two hundred horses in caring for the business there, and the horses will be displaced as fast as the cabs can be secured. The cabs have proven much more economical and efficient than the horse-drawn vehicles.

The management of the Boston show has shown confidence in the Taxi-Service Company and the realization that the crowds who visit the big exhibition will be calling for cabs, by arranging to give this concern the exclusive service rights at the show, to handle the immense amount of business that will arise there. A uniformed starter will be in attendance day and night, while the doors are open, to answer questions and to supply cabs. It is the intention of the taxi management to give a most thorough service to the autoists who will visit the show, and extra cabs will be used if they can possibly be obtained from the makers.

One hundred machines are expected to be in use by the first of July, a number which is thought to be sufficient for the requirements of the Boston public for some time to come.

MAINE, TOO, HAS A GOOD AUTOMOBILE SHOW

PORTLAND, ME., March 1.—Portland has another automobile show to its credit, the fourth annual, which concluded Saturday evening, and was more successful than any of the three previous ones. As in the case of all the others, this show was held in the spacious Auditorium, which was profusely decorated for the occasion. The exhibition opened Monday, February 22, and continued the rest of the week. Though the weather was not at all satisfactory for the greater number of days, there were large crowds present at all times and they came from all parts of the State.

The fourth annual show was not quite as large as some of the previous ones, but everything considered it was a much more satisfactory one. All the exhibitors were there for business and almost a record number of sales were recorded for the week. Agents were present at all times and there were few who did not take a number of orders during the week.

Though most of the cars exhibited at the show have been seen in the city before, there were several newcomers. Perhaps the most notable of these was the appearance of the high-wheeled Black machines, which proved a source of great interest to all the visitors, and aroused no little comment. The Marion car, one of which was driven over the road from New York to Portland, was also on exhibition and elicited a good deal of favorable comment.

The Maine Taxicab Co. has just been formed in this city to use the Palmer type of public carriage, and these were shown for the first time. The taxicab will be seen on the streets of the city this summer, and there is every indication that it will be extremely popular not only with the residents of Portland but with the hundreds of visitors who come here every summer.

Portland's streets were covered with ice, and for the most part were in horrible condition during the week of the show, but this did not prevent the demonstrators from getting out with their cars, and the city was filled with buzzing, speeding machines during the six days of the show.

While there were plenty of automobiles on exhibition, the number of motorboats was rather small, for there were but three large ones shown in the basement. These embraced the speed,

cruising and ordinary pleasure types. They were beautiful pieces of workmanship and attracted plenty of attention. Frederick M. Prescott had charge of the show, and showed his ability in the excellent arrangement of booths and the beautiful decorations of evergreen, palms and bunting. The principal exhibitors at the show were the following:

F. A. Nickerson & Co., Pierce Great Arrow and Oldsmobile; L. C. Gilson Auto Co., Mitchell and Stanley automobiles; Buick Automobile Co., Buick cars; Harmon Automobile Co., Thomas, Chalmers-Detroit, Franklin and White cars; New England Motor Sales Co., Marion automobiles; Palmer Bros., Gasoline engines and boats; Portland Shipbuilding Co., boats; Taxicab Company of Maine, taxicabs; W. L. Blake & Co., marine engines and oils; George D. Thorndike, Mianus engines; Thomas Laughlin Co., marine hardware; F. H. Little Oil Co., oils; Vacuum Oil Co., oils; C. F. Guptill Co., marine supplies; The Portland Co., Knox automobiles; L. Calvin Miller, Black motor vehicles; Valvoline Oil Co., oils; Dresser & McKenney, marine carpenters; J. A. Salmon & Co., monograms; Borne Scrymser Co., oils; James Bailey Co., automobile accessories; Maine Motor Carriage Co., Stevens-Duryea and Peerless cars; Stoughton & Folkins, Maxwell cars; C. F. Roper & Co., safety propellers; Frank M. Low & Co., clothing; Gordon Automobile Supply Co.; F. F. Wentworth, Overland automobiles; Darling Automobile Co., Reo automobiles; Simmons White Co., marine motors; French Leather Novelty Co.; Marine Motor Manufacturing Co.; Bath Marine Construction Co.; Studebaker Co., electrical vehicles; Rice Brothers, motor boats; Underhay Oil Co.; Harris Oil Co.

It is with the greatest of satisfaction that the automobile dealers of Maine view the prospects for the coming year. The panic of last year hit this section of the country a very light blow, so there is little danger that the sales will be light. From all indications, the chances are that there will be more machines sold this season than in any previous year. Already there are over three thousand automobiles owned in Maine, and it is confidently predicted that the four thousand mark will be reached this year. The spread of the good roads movement has been responsible, to a great degree, for the growing popularity of automobiles here.

MERRY BANQUET OF HARTFORD DEALERS.

HARTFORD, CONN., March 1.—During the show week in this city the Hartford Automobile Dealers' Association held a banquet at the Allyn House, convening after the doors of the show had closed on last Thursday evening.

The banquet equipment included Maxwell cocktail, Simplex-in-cup, Packard with Stevens-Duryea on the Side, Broiled Buick Hen on Pierce-Arrow Toast, Thomas Salad, American with Stoddard-Dayton Demi (Overland) Tasse. The list of oils included Autocar appetizer, Ford Sherry, White Steamer Champagne, Oldsmobile Highball, with decorations in Mitchell style. Ignition was by Franklin cigars, Knox, Cadillac and E-M-F cigarettes.

President Ralph D. Britton of the dealers' association presided as toastmaster. The first to respond was Mayor Hooker, who proved a witty speaker. But Assessor P. Davis Oakey, as tax assessor, could not quite comprehend why the Mayor should have placed a valuation of \$500 on his \$4,000 car. State Highway Commission James H. MacDonald enlightened the multitude on the State road improvement problem and introduced many facts and figures, all of which he had at his fingers' ends. P. E. Curtiss, automobile editor of the Hartford Times, proved a marvel of wit, and Walter S. Schutz paid a glowing tribute to the work of the State Highway Commission.

MILWAUKEE SHOW DATES EXTENDED.

MILWAUKEE, March 1.—The first annual Milwaukee auto show, scheduled to open Thursday, March 11, and end March 13, will be made a four-day affair, it is now certain. The Milwaukee Automobile Club has found so much interest in the show that it is assured of bigger success if the time is extended into the next week. One hundred cars, at least, will be exhibited, forty agents having taken space, and a number of others cannot be crowded in. The accessory and motor cycle spaces are also filled. The big Hippodrome is not large enough to accommodate all. The balcony must be used for car exhibits, and additions will be built to make room for the accessories that will be crowded out.

PLANS FOR TOLEDO SHOW UNDER WAY.

TOLEDO, O., March 1.—Arrangements are well under way for the annual automobile show of the Toledo Automobile Dealers' Association, which was incorporated some time ago. The dates set for the event are March 22 to 27, inclusive, and the affair will be held in the Coliseum, the same hall where the show was held last year. Committees are now at work, and instead of being divided as at that time, all the local dealers are interested and will participate. This assures a much larger show than has yet been undertaken in this city.



CLEVELAND, March 1.—Saturday night, to the strains of "Home, Sweet Home" and "Farewell," the lights winked out the seventh annual Cleveland automobile show—the largest, most artistic and most successful ever held in the State.

Early in the evening the work of dismantling exhibits commenced. Big canvas covers were produced, cars were enveloped and shot out through the big Lakeside Avenue entrance. Before the crowd was away nearly one-third of the cars were either lined up outside or on big drays being carted away. Just before the close Robertson's Band paraded the main floor. With rousing, old time tunes, it serenaded first the Thomas "round-the-world" exhibit, and then around the entire line. The march was accompanied by the tooting of horns, the organ-like notes of the Gabriel and the cheers of the crowd.

FURTHER PLANS FOR CARNIVAL WEEK.

To ratify the various plans, which had been made up to that time, by the carnival committee of the New York Automobile Trade Association, a large mass meeting of the members of the trade was held last Thursday evening in the Automobile Club of America audience room. The ideas followed out by the committee met with the hearty approval of the members, and further plans were discussed. It is probable that in addition to the hill climb on the Fort George Hill, and the day parade on Saturday of the week, April 5 to 10, that there will also be speed trials on the Ocean Parkway, special tests and an aeronautical exhibit at Morris Park, an opening dinner for trade members and a wind-up smoker at the Automobile Club of America.

To meet the expenses it will be necessary to raise between \$15,000 and \$20,000, and of this about \$2,500 was subscribed at the meeting. An additional committee of ten was nominated, to assist Gen. John T. Cutting, chairman of the finance committee, composed of the following: E. W. Bonham, Goodrich tires; F. M. Hadley, Knox; Harvey Adams, Auto Supply Co.; W. J. Coghlan, Moon; F. M. White, Stewart Speedometer; George F. Hare, Olds; Oscar Hausen and Richard F. Fenker, Parkway Garage Co.; W. C. Poertner, National; Harry Pyke, Chalmers-Detroit, and A. J. Interrieden, Warner Instrument Co.

Cleveland and Clevelanders can well be proud of the 1909 show. To say that it was a great success would only be repeating what has been said before. There was not a hitch. Everything was conducted in a systematic manner that was above criticism. Good will was the dominant feature. There has been rivalry, of course, but of the good fellowship kind.

It is estimated that upward of 50,000 people attended during the week. There was difficulty in getting around at times. The sales closed up as a direct result of the show will number hundreds. It has not only been an automobile show of Cleveland, but of the entire northern part of the State. Visitors have been drawn by hundreds from neighboring cities. No one has been disappointed. Cleveland dealers are more than pleased and manufacturers satisfied. The show has brought results.

AUTO SHOW FOR NORTHERN NEW YORK.

GLENS FALLS, N. Y., March 1.—In the three-story garage of the Glens Falls Automobile Company, from March 15 to 20, there will be held an exhibition of a number of well-known makes of cars that will probably draw interest from a large section of this part of the State. The building will be especially decorated for the occasion and an orchestra will be in attendance each evening. Among the cars which will surely be shown are the following: Thomas, Knox, Regal-Detroit, Overland, Maxwell, Franklin, Oldsmobile, Pope-Hartford, Pierce Great Arrow and Cadillac. The New York-to-Paris race-winning Thomas is expected, and there will be a number of accessories shown.

MINNEAPOLIS NEEDS MORE SHOW SPACE.

MINNEAPOLIS, March 1.—In answer to a great demand for space in the automobile show, which will be held here from March 13 to 20, the management is now trying to rearrange the plan of exhibits, to accommodate all who wish to be included among the exhibitors. Elaborate plans are being made for the entertainment features of the show, and it is confidently expected that the week will draw thousands of people to this city from all over the Northwest.



Fifth Regiment Armory, Where Baltimore's Fourth Annual Automobile Show Was Held Last Week.

BALTIMORE, March 1.—The first automobile show given under the auspices of the Automobile Club of Maryland, and the fourth affair of the kind held in Baltimore, opened last Wednesday afternoon and closed Saturday night at the Fifth Regiment Armory. It can truthfully be said that Baltimore really had a show this year, for everything went off in perfect harmony, the displays were numerous and of the highest order, and there was no cramping of exhibitors nor crowding of visitors. While there was not a dearth of room in the Armory, it was arranged in a comfortable and easy manner, the exhibits displayed to advantage and with sufficient room for the crowds to walk along without any congestion.

There were many more cars shown than ever before, just 120 being on the floor of the regimental hall, with 44 exhibitors. This includes in addition to the automobile dealers, those engaged in the accessories and tires trade, motors, motor boats, motorcycles, etc. The show was more than a local exhibition, as was the case in former years, for there were visitors from all sections of the State, as well as from the Southern States and nearby Northern and Western States. Of course, the crowd for the most part was made up of Maryland motorists, but there was a big representation from the South. The dealers have been jubilant since the close, for they made more sales and have more prospects than at any previous show. They do not hesitate to say that the present exhibition has done much to make the holding of a show in Baltimore an annual affair, with dealers and owners alike, and that future events of the kind will be left to the good management of the club.

This opinion has, however, arisen only since the opening, for previous to the undertaking by the club the dealers had decided to do away with shows in the future here, considering the New York, Chicago, and Philadelphia exhibitions enough to satisfy the Baltimoreans. They were simply discouraged by the poor success they met with at previous exhibitions, but evidently Baltimore has a rekindled epidemic of the motoring fever, and the increase in the number of cars owned here within the last year has been remarkable. The fact that the club succeeded in getting the Fifth Regiment Armory for the holding of the event was a great help in making the celebration such a pleasing one in every way. Heretofore the dealers and visitors had to be contented with smaller halls entirely unadapted for such a purpose.

Among the novelties from a Baltimore standpoint was the exhibition of the French Renault, the first foreign car ever shown here, and, in fact, the first one to be represented here. Two styles of this car were at the booth of the Stoddard-Dayton Baltimore Auto Company, the \$8,750 landaulet and the runabout which sells for \$1,750.

Two Baltimore cars were on exhibition, the Spoerer car, manufactured by the Carl Spoerer's Sons Company, who entered the trade last fall, and the Maryland car, made by the Sinclair-Scott Company, which has been in the motoring field for several years. One car of each of these makes was shown, both being fully equipped touring cars with tops, the Spoerer selling for \$2,850 and the Maryland for \$2,500. The Spoerer has a four-cylinder water-cooled motor, 4 1-2-inch bore and 5-inch stroke, with cylinders cast separately and a five-bearing crankshaft. The transmission is of the three-speed selective type, and the gears made of Krupp nickel steel throughout, running on Hess-Bright bearings. The front axle is of I-beam section with Timken roller bearings, while the rear axle is a floating one in a pressed-steel housing. The ignition is by the Bosch dual system.

Another practically new car on the market, and a Maryland product, was the Burns car, manufactured by Burns Brothers, of Havre de Grace, Md., who have also been in the business only since last fall. The car which this company makes is styled a transformable coupe, resembling a physician's carriage, and is particularly for service on country roads. The engine is of 14 horsepower with double opposed air-cooled cylinders under hood. The car has a wheel steer, with gas and spark control on top. The axles are of the Timken roller bearing types, front and rear, the springs full elliptic and the wheels are high, 40 inches front and 42 inches rear, with solid or cushion tires.

Other cars new in the show line to Baltimore were the Rauch & Lang electric, the Palmer-Singer, Lozier, Reo, Oakland, Chalmers-Detroit, E. M. F., Rambler, Brush and Gaeth. Commercial cars were poorly represented, the Brush package cart and mail car and the Hart-Kraft \$1,200 commercial delivery wagon of 18 horsepower, at the booth of Little Joe Weisenfeld, who has just entered the motor car business with the Reo and Oakland agencies, being the only ones shown. The newest thing in the accessories line was the autolight igniter and con-

troller, patented by the International Manufacturing Company, of this city. This is a device for lighting and controlling gas lights on an automobile, which enables the driver to control the light from the seat. It was demonstrated on a Kissel-Kar.

Howard A. French had a big line of Indian and Pierce motorcycles of the 1909 style in his booth. Frank B. Burton displayed for the first time here Vim motors and a motor boat manufactured by the Niagara Motor Boat Company, of North Tonawanda, N. Y. James G. B. Davy & Company gave out automobile directories of this State, containing the list of license numbers of each owner and arranged in the order of the numbers from 1 to 8,077. The Brush single cylinder runabout, which made a run from Detroit to a number of eastern cities last Summer, attracted considerable interest.

The following is the list of exhibitors:

- Shaffer Manufacturing Company—Pullman.
- White Garage Company—White steamer.
- Brush-Nichols Company, Washington, D. C.—Brush.
- Ford Auto Company—Ford.
- F. W. Sandruck—Gaeth.
- J. L. B. Wilhide—Kissel Kar.
- Charles F. Houghton—Overland.
- Burns Brothers, of Havre de Grace, Md.—Burns.
- Maryland Rwy. and Electric Supply Co.—Witherbee igniter, electric devices.
- Baltimore Rubber Tire Co.—Kelly-Springfield tires.
- Hector C. MacRae—Champion accumulator.
- Automobile College.
- Automobile Club of Maryland.
- Edw. A. Cassidy & Co.—Jones' speedometer, Monogram oil.
- Frank D. Burton—Vim motor, Niagara power boats.
- Howard A. French—Indian & Pierce motor cycles.
- Jones' Machine Company—Keystone automobile grease.
- National Sporting Goods and Auto Apparel Company.
- H. A. Broadbelt, Jr.—Stanley steam car.
- Standard Oil Company.
- E. R. Elliott & Co.—Automobile insurance.
- Thomas G. Young—Stearns.
- Mount Vernon Motor Car Company—Autocar.
- James G. B. Davy & Co.—Accessories.
- W. P. Shuler—Mitchell.
- Sinclair-Scott Company—Maryland.
- Auto Equipment Co.—Rambler, accessories, Continental tires.
- Bridge Garage Company—Cadillac.
- Carl Spoerer's Sons Co.—Spoerer, Goodyear and Diamond tires.
- Stoddard-Dayton Balto. Auto Co.—Renault, Stoddard-Dayton.
- Baltimore Buggy Top Co.—Automobile and buggy tops.
- Lambert Auto Company—Maxwell.
- Motor Car Company—Thomas, Stevens-Duryea, E-M-F.
- Zell Motor Car Company—Peerless, Chalmers-Detroit.
- Little Joe Weisenfeld—Oakland, Reo.
- Winton Motor Carriage Company—Winton.
- Rice's Garage—Welsh, Pennsylvania, Rauch and Lang.

- Mar-Del Mobile Company—Packard, Franklin, Waverley.
- Auto Outing Company—Buick, Palmer-Singer.
- Olds Motor Works Branch—Oldsmobile.
- Foss-Hughes Motor Car Company—Pierce Great Arrow.
- Southern Auto Company—Lozier, Pope-Hartford.
- Dixon C. Walker—Studebaker.
- Great Eastern Optical Company—Accessories.

MARYLAND CLUBS TO FIGHT TAX.

BALTIMORE, March 1.—At the convention of automobile owners in this State on Saturday morning, under the auspices of the Automobile Club of Maryland, to discuss the special tax feature of the automobile bill prepared for the Maryland Automobile Commission by Col. Sherlock Swann for presentation to the next General Assembly, a plan for forming a general State club to fight the passage of its obnoxious features was unanimously adopted. This club will consist of local councils in every important city and town and in all of the counties.

There was a decided political tinge to the convention, and the proceedings were animated throughout. President Rowe, of the club, started things going by asking the several hundred delegates whether, as a last resort, they would take up the fight for what they consider their rights with their ballots. The answer was unanimously in the affirmative. "We can muster nearly 8,000 voters," declared Dr. Rowe, "and that means something. When we show the members of the General Assembly that we are affecting their parties we can, no doubt, get a hearing. While I believe it is but fair to pay a nominal registration fee to maintain the bureau of registration, I do not see why the owners of automobiles should be compelled to bear all the expenses of maintaining good roads, when horse-drawn vehicles do equal, if not greater damage to the thoroughfares. And then, just now, the good roads in this State exist only in imagination and on paper, and we would pay tax for the maintenance of such roads."

In behalf of the members of the Hagerstown Automobile Club, W. B. Littleton explained that the special tax in Washington County would work a great hardship to the autoists of that section. All the roads there are toll roads, the county is so close to adjoining States that the several licenses necessary make the cost of automobiling almost prohibitive.

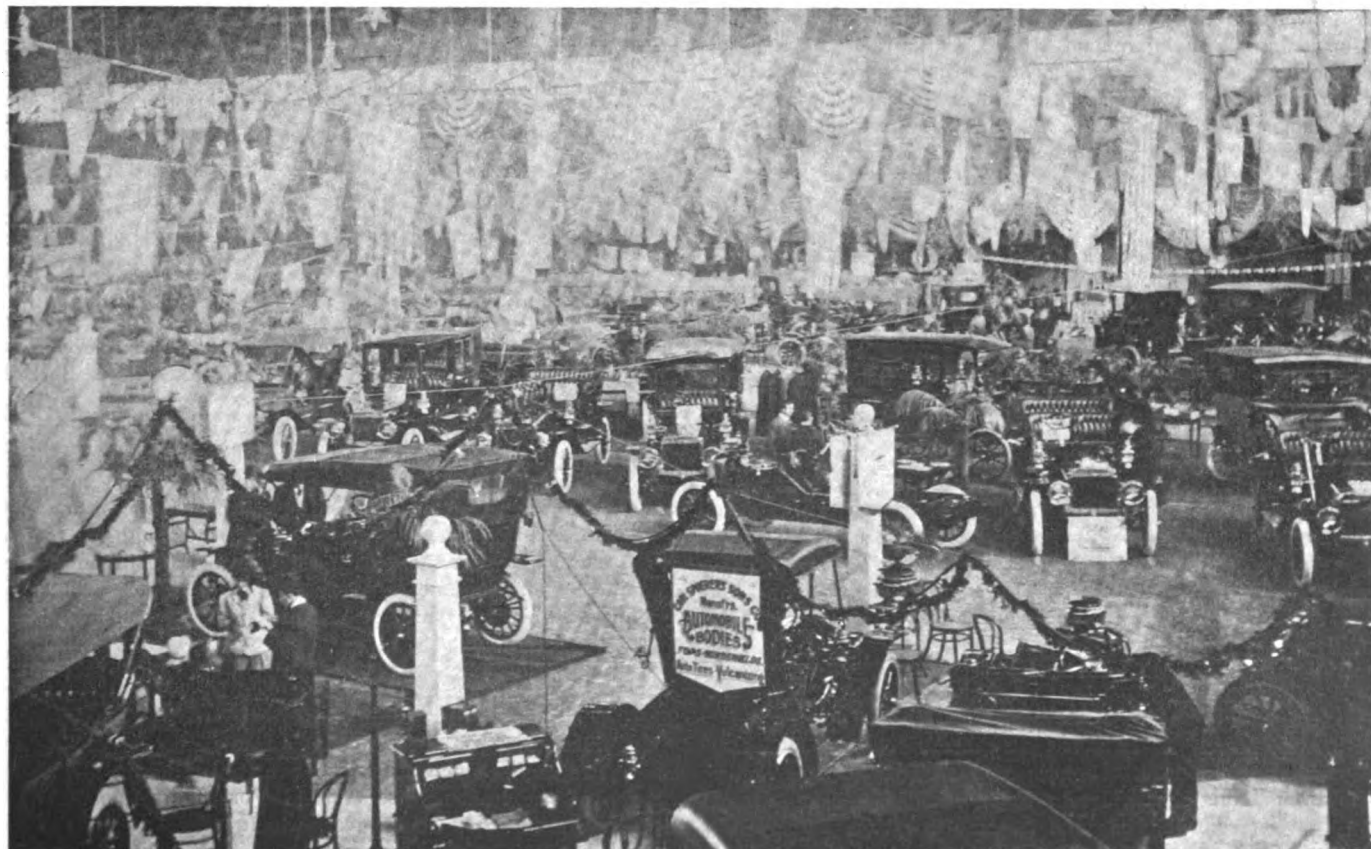

The Massive Baltimore Armory's Interior Was Effectively Decorated and the Exhibits Were Well Massed.

BUFFALO'S SHOW A SPLENDID SUCCESS

BUFFALO, March 3.—Convention Hall is aglow with the greatest automobile show that Buffalo has ever witnessed, the seventh effort of its kind, and the first under the exclusive direction of the Automobile Club of Buffalo, opened on Monday evening by President John M. Satterfield in a brief speech, punctuated by choruses of "honks" from the 122 motor cars exhibited by the 38 dealers. Secretary Dai H. Lewis was, as usual, in general charge of the arrangements, and the club made the effort of its life in the way of decorations, the chief effect being constellations of stars, gleaming in golden galaxies from the ceiling, a field of pink.

The hall was found totally inadequate for the applications for space. Even the ante-rooms were pressed into service for the exhibitors, and, in one instance, the space renter found himself so crowded for room that he hung one of his runabouts up in the air over the rest, taking the entire stage at that.

The show has representatives of the principal cars of American make, and one that was never exhibited before. This is a car made in Buffalo, the Austin Lyman Special, a six-cylinder, 60-horsepower, four-passenger car, with a toy tonneau, warranted to sustain a speed of 70 miles an hour. The price is \$3,000. It is the first of its kind, made by the Austin Lyman Company, Terrace and Erie streets, Buffalo.

The electrics are represented by the Babcock Electric Carriage Company, the Waverley and the R & L electric.

The Pierce Arrow Motor Company exhibit nothing but six-cylinder cars, the feature of the display being the green Louis XVI, \$12,500 limousine shown in New York.

The E. R. Thomas Motor Company shows a full line of big six five-passenger flyabouts, little six cylinders, four-cylinder landaulets and 20-horsepower broughams.

The Automobile Club also had an exhibit, consisting of road signs, to indicate distances and danger points, and of membership blanks handled by capable membership solicitors.

A novelty at the show is an automatic automobile protector designed by a Buffalo woman, Mrs. S. C. Partington. It is an automobile cover of canvas suspended from the roof or ceiling of the garage and lowered or raised over the car by a pulley.

A Rambler and chassis, two Reos, two Overlands, a Regal and Premier are shown in one exhibit. Another agent shows

four different makes, the Stevens-Duryea, Knox, Corbin and E-M-F. The Pullman, Crawford and Firestone motor buggies and trucks are the exhibit of another. Twenty-seven trophies won by the Pullman car are shown on a shelf above the cars. A manufacturer of automobile tops and bodies shows a Franklin fleet of five air-cooled cars. The Gaeth shares space with the Oakland and Cartercar and the Oldsmobile foregather with the Oakland and Rapid. There is a big display of motor trucks, the American Motor Truck Company exhibiting three.

A local company exhibits cylinders cracked and welded together so deftly as to deceive the inexperienced eye in trying to locate the fracture. Broken axles, pistons and frames are also exhibited, united by the same magic electric welding process.

The Peerless and Cadillac are shown side by side and the Maxwell-Briscoe Company uses seven cars to show the varied output of its factories. The Chalmers-Detroit and two Stearns cars are neighbors alongside of a Mitchell and four Stoddard-Daytons. A Winton "Six" and R. & L. electric are exhibited side by side. Then as the visitor proceeds up one aisle and down the next he sees a large Packard exhibit, Pope-Hartford and Selden cars, eight Buicks and Grabowsky power wagon, the Brush runabout and delivery wagons, and a Haynes touring car and chassis, all making a brave showing.

The accessories interested have a large representation, a dozen exhibits showing everything in the line of automobile and chauffeur equipment. The attendance has been large every day and evening. The exhibitors report both large sales and many more prospects.

Pierce-Arrow—Pierce-Arrow Motor Car Co.
Thomas Flyer—E. R. Thomas Motor Co.
Stearns—Mason B. Hatch, 729 Main st.
A. L. S. (Austin Lyman Special)—Austin Lyman Co.
Chalmers-Detroit—Mason B. Hatch, 729 Main st.
Cartercar, Gaeth—Louis Engel, Jr., 732 Main st.
Pope-Hartford, Selden—Buffalo Automobile Exchange, 461 Franklin st.
Maxwell—Maxwell-Briscoe Motor Co., 24-28 Goodrich st.
Franklin—Brunn Automobile Co., 1140 Main st.
Stoddard-Dayton, Mitchell—J. A. Cramer, 737 Main st.
Pullman, Crawford—Meyer Carriage & Auto Co., 322 Ellcott st.
Buick—Buick Motor Co., 1100 Main st.
Reo, Regal, Rambler, Premier, Overland—Poppenberg Motor Car Co., 674 Main st.
Peerless, Cadillac—Kane Motor Supply Co., 539 Ellcott st.
Stevens-Duryea, Knox, E-M-F—Co-operative Motor Car Co., 672 Main st.
Winton, R. & L.—Ralph E. Brown Motor Car Co., 721 Main st.
Packard—The Densmore Co.

CARNIVAL WEEK PROGRAM ANNOUNCED

NEW YORK, March 1.—The program for Carnival Week of the New York Automobile Trade Association has been arranged, giving a list of events for every day of the six, from April 5 to 10, with the exception of the Friday, which is Good Friday and a holiday. Monday there will be the hill climb on the Fort George Hill, with Col. K. C. Pardee in charge, as he was last year, when there were 87 entries. Tuesday has been set aside for straightaway races and speed trials on the Ocean Parkway or the Motor Parkway, with C. R. Teaboldt as chairman of the committee for these events.

Souvenir Day has been the term given to Wednesday, and the trade will be asked to give to their customers, or owners, suitable

souvenirs, banners, or catalogues, and in the evening there will be a trade banquet at some important hostelry. Alex. Howell has been made chairman of the committee for this affair. Special aeroplane events either at Morris Park or some other suitable place will be held on Thursday, with Orrel A. Parker in charge. Saturday will be the great parade day, when it is expected that there will be a greater number of cars in line than last year and some more original and beautiful decorations. Gen. Cutting has announced the acceptance of Gen. Geo. Moore Smith, to act as grand marshal with authority. R. C. Howell is chairman of the committee on arrangements. Saturday evening there will be a meeting at which the various prizes will be presented.

E. R. THOMAS WILL TOUR IN AFRICA.

BUFFALO, March 1.—In a big six-cylinder Thomas limousine of 70 horsepower, E. R. Thomas, of the E. R. Thomas Motor Company, of this city, will tour Egypt and into the interior of that country. The big car and its chauffeur have already left New York for Naples, where Mr. Thomas will be met.

WHY AMERICANS TOUR ABROAD.

The illustration on the adjoining page almost tells its own story as to why so many Americans yearly tour in Europe. The view is in the Italian-Swiss Alps at Portofino-Kulm, and the well-known De Dion-Bouton car, which makes a specialty of mountain climbing, is the automobile included in the picture.

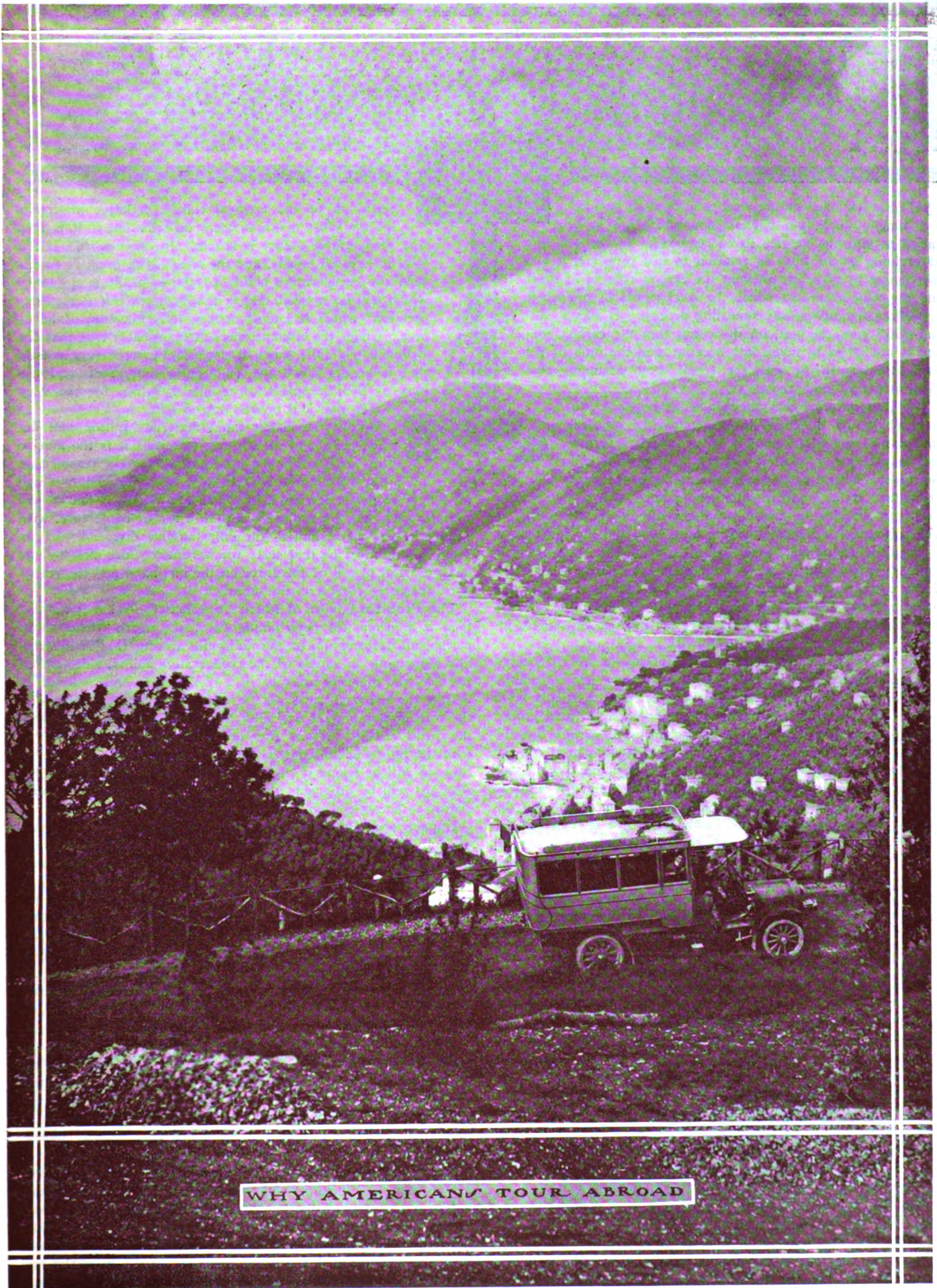

WHY AMERICANS TOUR ABROAD

PRINCIPLES OF THE SCLEROSCOPE FOR MEASURING HARDNESS

By Thos. J. Fay

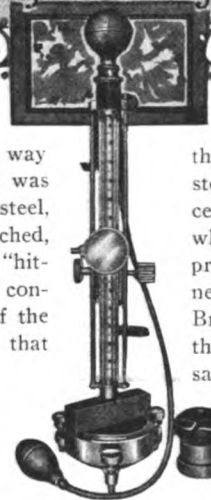

PHYSICAL hardness in steel as it is used in automobile work is a phenomenon which has to be varied to suit the service to be rendered. In the old way of arriving at the facts in relation to this property, it was the custom to take into account the carbon content of steel, and the temperature at which the steel would be quenched, as well as the subsequent annealing process. It was a "hit-and-miss" game at best, on the count that the carbon content is not all to be taken into account, and the bulk of the steel also has to do with the result, even assuming that shape is not a large factor.

The illustration shows the Shore Scleroscope, the main ability of which is to determine the physical hardness of materials, notably steel; which information is valuable, in that it reflects, to a considerable degree, the several other qualities residing in the steel.

From the "stylus," with its diamond point (used to scratch the steel, to show its hardness), to the methods of "Brunnell," in which the steel is indented, was a long way, and the indentation of the little (hardened) steel ball, as used in the Brunnell plan, does extremely well by way of indicating the hardness of steel, if the same is soft enough to respond to the process. In the meantime, the "Shore" method (of the subject), comes as a great advance, in that the metal does not have to be scored, indented, to any great extent, or crushed.

Alloy Steel Is the Hardest of All Metals.—In the early days, in which carbon steel was the mainstay, it was not considered difficult to determine the hardness of the steel, particularly in view of the fact that the carbon content was as a good guide; at the present time it is not possible to go by the carbon for the reason, that it is not carbon on which reliance is placed for the great hardness to be noted. Then, it is a fact, that full knowledge of the properties of alloys is not available, and the result is that it is no longer possible to make a good guess, even in the absence of a test, which is but another way for saying that the test, if made, could be gauged, as to its probable accuracy. Owing to the great hardness of alloy steel, tests for hardness are more difficult, especially if it is desired to arrive at conclusions closely approximating the facts. It would be a very difficult process to use a "stylus" on "quenched" alloy steel balls as found in some of the superior ball bearings, or, for that matter, alloy steel as it is used in transmission gears would be beyond the art of the metallurgist equipped with a stylus.

The Shore scleroscope depends for results on the fact that steel will vibrate more or less depending upon its strength, elasticity and hardness, considering a fixed set of relations, taking into account the shape of the specimen used in the test and the manner in which the test is conducted. In the Shore method, then, it is the aim to interpret the hardness of the material in view of the elasticity of the same. But in this will be found much food for serious reflection, in view of the small drop-hammer with which the scleroscope is equipped, and the fact that the minute device could scarcely create more than a ripple in a "molecular sea." It is quite out of the question to assume that the "fiber elasticity," of the material undergoing test, is the phenomenon which is responsible for the accuracy of the scleroscope, in its search for the hardness of material.

Molecular Elasticity and Recuperative Ability.—That the hammer of the instrument searches out the molecular structure, and compels a response to the impact of the hammer, is what

seems to be the rational claim. Relative molecular motion must result in local deformation if it is true that recuperative ability is absent. In other words, if the steel is stressed locally, and the stress is so great as to exceed the recuperative ability of the same, it is a "dent" which will be noticed, and in the Brunnell test is the "depression" which is looked upon as an indication of hardness. Under the circumstances, it is probably true that the Brunnell test falls short of accuracy, for the very reason that it breaks down the (molecular) structure, and the same is then incapable of telling the story for the very reason that it is broken down.

Within the elastic limit, materials follow well defined laws, and in working materials it is the aim to keep well within the elastic limit, for the reason that once the material is stressed to the "yield point" it will no longer respond; the laws, of which knowledge is potent, are over-stepped, and the student is lost in a sea of conjecture, with failure heaped about him as the only tangible dividend. In the same way it must be that tests for hardness which destroy the structure fail to tell of the force on the one hand and the resistance (negative force) on the other.

The Problem Savors of Much Complexity.—What is wanted, then is a means for determining the force which would attain permanent deformation of the molecular structure, without actually deforming, in excess of the recuperative ability, since to tell the tale, the material must be in a recuperative state. In other words, the material must not be destroyed in the process, else the information sought will sink into oblivion in company with the form crushed out of the material undergoing test. Even with the Shore Scleroscope, evidence of the inability of metal to respond will be found if the same zone is struck repeatedly; the readings will be different; the structure undergoes change sufficiently to be noticed on an instrument of such nice delicacy.

Impact and Pressure Related.—The instrument takes into account the usual laws of impact in which the impact or blow that a body is capable of delivering after it has acquired momentum, in response to a force, acting during a greater time, is used to conquer a greater force in less time. Were it possible to estimate exactly the ratio of the intervals of time, this ratio would serve to indicate the ratio of the force of impact. Impossible as this would seem to be (since the lesser interval of time is as the infinitesimal increment), renders it desirable to approach the subject from the other point of view and estimate the values involved in the spaces through which the masses move.

In general, it is to say that if W equals the weight of the hammer and h equals the height of fall, $W \times h$ will equal the energy of the blow; that is to say, it will equal the energy residing in the hammer at the instant of contact. The energy will be employed in the manner as follows (a), in compressing the hammer; (b), in compressing the test specimen on which it falls; (c), in compressing the base on which the specimen is rested; (d), to a minute extent in friction, etc.

Plainly, then, account must be taken of the relative hardness of the hammer, which is compressed, and the specimen, which is also compressed; the clamp "should be devised in such a way as not to introduce a notable factor into the calculation. That the relative hardness (of the hammer and the specimen) is not a matter which will defeat the project is assured from the fact that the instrument serves the purpose with lead as well as with

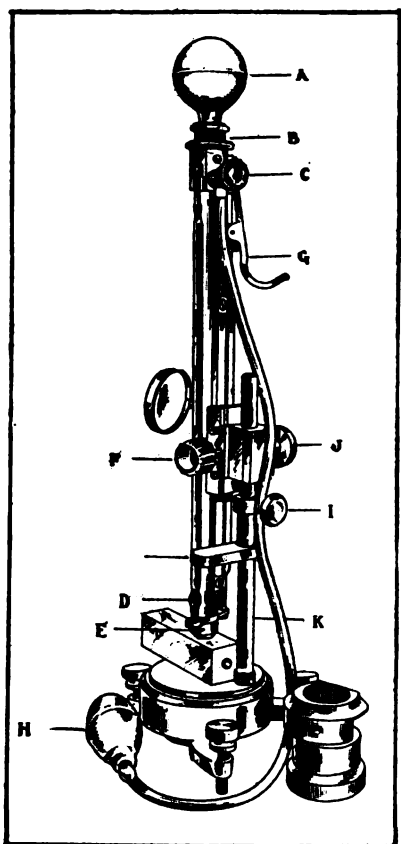

Fig. 1—Explanatory Figure of Instrument.

hardened steel. The great advantage of the instrument lies in the fact that it is capable of measuring the compression of the specimen, and to respond to the compression of the hammer, small as the values are, despite the fact that the feat was looked upon by scientists as quite beyond the pale of human ingenuity.

In view of the wide use to which an instrument such as this might be put, it is extremely important to feel sure of the basis of its application, which, up to the present time, has been much discussed, although the conclusions thus far reached fail to impress one as being in full accord with each other, or sufficiently in accord to be regarded as lasting. Even as it is, the question of the effect

of crushing the molecular structure, with its consequent effect upon the readings, is one which will have to be investigated at some length, since it is true that the readings will differ if a blow is struck twice on the same spot.

Mathematical Exposé of the Performance.—Assuming the conditions (which must be satisfied) to obtain as follows:

Let

- R = the effective resistance of the specimen to be tested;
- = the total resistance, less the weight of the members;
- S = area of the head of the hammer in contact with the specimen;
- P = the pressure, at any instant, exerted between the hammer and the specimen, which ultimately reaches the pressure at the instant of maximum compression of the specimen;
- E = modulus of elasticity of the material;
- L = depth of the specimen acted upon;
- W = weight of the hammer, as before given;
- h = height of fall, as before given.

The distance of fall of the hammer, after actual contact, during which the specimen is being compressed, is the compression due to the maximum effort, and will be equal to:

$$\frac{RL}{ES}; \text{ which takes into account uniform compression; it is in}$$

this connection that speculation will creep in, in that the compression may be so localized as to render an estimate of the distance L difficult to ascertain.

In all events the work performed in compression will be equal to:

$$\frac{R^2 L}{2ES}$$

Were it possible to consider a second blow on the same surface, noting the added compression, it would then be fair to pursue the matter at further length, and end by solving for R, which, as before stated, represents the effective resistance of the specimen to be tested. In the absence of this ability it is possible to note on an arbitrary scale in the instrument what may be called relative resistance.

What the Figures Seem to Indicate.—The work performed in the process is as R^2 by the depth L of the molecular disturbance; taking it for granted that the area S, of the zone, is as the area of the hammer in actual contact. The modulus of elasticity of the material will serve to modify the conclusions, in so far as $2ES$ will have bearing upon the situation, if it is true that the modulus E is a variable in steel, that is to say, a variable of some magnitude. It has never been definitely settled that the modulus E is much different in the several grades of steel, as in alloy steel, relative to carbon steel.

In view of the fact that R^2 will have the greatest influence on the situation, and that S, if small, adds to the efficiency of the scheme, it is plain to be seen that appreciable readings will follow even if L is of an unassignable magnitude. Since R increases with the hardness of the steel, and R^2 is the value which influences the situation, it would seem as if the harder the steel the more pronounced will be the reading on the scale, although it is true that the diminishing value of L will taper off the readings.

The Results as Reported in Practice.—When a force acts upon a body a secondary force, or a force of reaction, is at once set up, equal and opposite in direction. The hammer is thus brought to rest, and the only phenomenon in which interest is here taken lies in the ability of the steel to resist the force, and snub the motion within the shortest interval of time. On the arbitrary scale, which takes notice of the rebound, the ability of the steel is disclosed, since in the absence of hardness the distance L would be increased, but the value of R would fall away, and since the magnitude is proportional to R^2 , it is plain to be seen that rebound would be less pronounced; proof of which lies in the fact that the expenditure of energy would be maximum in the case in which motion is arrested within the shortest distance of travel. In actual practice it is found that with lead the readings are about 2 per cent. of what would obtain with steel under the same conditions. In this is an indication of the working out of the law, showing that the value of R^2 (increasing) is a sign of hardness, while increasing the value of L is by way of reduced hardness. True, the two factors are for hardness, but one increases as the other decreases, and the value which increases as the square is the value which has the most marked effect by way of engendering hardness.

The regular Shore scleroscope is intended to measure the hardness of the hard grades of steel, as medium and high carbon steel, as well as the alloy steel products. In the cases involving soft metals what is called a "magnified hammer" is used. In both cases the hammer weighs but one-twelfth of an ounce, and it is figured that (in view of the area) the hammer is capable of exerting a pressure of 500,000 pounds per square inch. A close in-

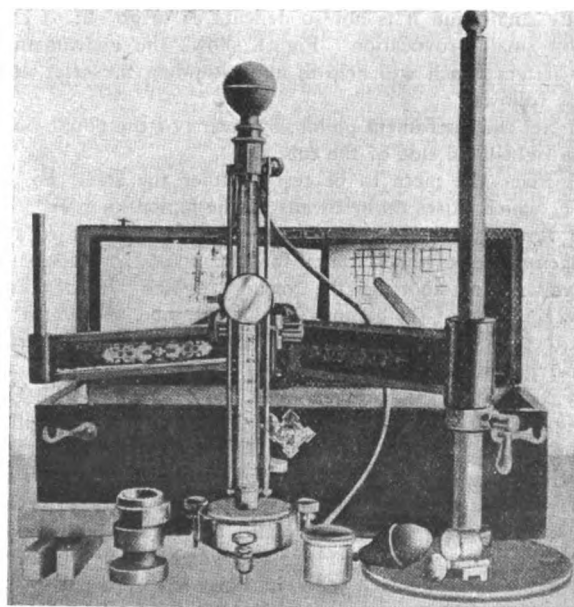

Fig. 2—Showing Instrument and Accessories Furnished.

spection of the formula will disclose the surprising fact that the weight does not have to be great; it is even possible to consider that the weight should not be beyond a certain point. What the formula demands is that the weight should be resisted so that motion will be arrested in the shortest time, and the weight should be so light as to enable the bounce to be measurable. It is fortunate that this is true, for it enables the device to do the work in a manner quite up to the requirements, despite the fact that measurements for hardness were looked upon as difficult to make on a basis of reasonable accuracy.

Range of Possible Uses of the Instrument.—In industrial work in general, there will be many uses for an instrument of this sort, but in the automobile zone of activity it is a question if the instrument may not be used for the specific purpose of determining the state in which the finished parts may reside, with a view to passing upon them. In other words, it may be possible to use the instrument in the testing departments of the various automobile shops, in order to show that the heat-treated products come up to the desired standard.

With a little practice it would seem possible to determine the carbon condition of the steel; if it is in the Martensitic state, for illustration, the instrument would show a hardness accordingly; in the pearlitic, the steel would show the softness to correspond. If a part is intended to be made of, say, chrome nickel steel, and if, through some inadvertence, the part comes out carbon steel, the scleroscope would quickly disclose the fact, merely because the degrees of hardness would fall far short of the hardness due to chrome nickel steel in the hard state.

If a part is to be hard on one surface and soft in general, local heat treatment is necessary, and if in the press of work the hardening operation be overlooked, the inspector armed with an instrument such as this would detect the fact and the result would be for good. In the purchase of steel, the same would be true, in that the test would have to come up to a standard, and if actual tests were to show quite differently, it would be a fair inference that the purchased product would be of a different grade. In the laboratory it would be a great advantage to be able to ascertain the hardness of steel, (a) in the normal state; (b) annealed; (c) quenched, from several temperatures; (d) annealed after quenching, considering several temperatures; and in case-hardening it would be of the greatest advantage to be able to note if the core is soft, and if the shell is hard. That the core should be soft is well understood; and that it does not always come soft is assured. The shell should be hard; as hard as glass (so they say), but it would be a good idea to interpret the statement in terms a little more in keeping with what might be called defined limits.

Portability Is of the Greatest Advantage.—The instrument is quite small, and it is not so delicate as to go out of calibration on small provocation. Fig. 1 shows the instrument with index letters which will help in understanding the brief description as follows:

(a) Set the instrument plumb, by means of the plumb-bob rod, on the right-hand side of the tube D.

(b) Place the piece to be tested under the steel cap of the tube E, which raises up by means of the pinion-knob F.

(c) Lower the instrument to the work; press it down a little, by placing the left-hand thumb on the hook G; this opens the pad valve, thus aborting the vacuum, which would otherwise follow the drop of the hammer, within the tube, and which would affect the rebound, which would in turn influence the accuracy of the instrument.

(d) To release the hammer, press the red rubber bulb H with the right hand, and to know the result observe the rebound; taking the readings just as the weight is in a state of counterpoise.

It will be understood that the weight is raised by means of the rubber bulb A, and in the operation it is necessary to press and then as suddenly release, when with the inrush of air the difference in pressure will result in the weight being sucked up to the top. A suitable catch takes into account the small piston C, with a hardened pin or rod on it, which is adapted to push

against a pendulum-like hook pin, which engages with a circular dove-tailed recess in the top of the drop hammer.

The instrument and the parts which go to make up the set will be noted in Fig. 2, and as the user will naturally be supplied with complete instructions as to the mode of procedure, it will not be necessary to enlarge upon the details here. In this article it is the idea to take into account the situation in general and to point out that the uses to which the instrument can be put may far exceed the original intent.

As a Quick Means of Investigating Steel.—In these days, when nearly all the steel used in automobile work is heat-treated to render it strong, as well as to bring out the much desired kinetic properties, it is not enough to purchase good steel, low in metalloids, and free from such imperfections as steel naturally falls heir to. If the steel has to be heat-treated, and if the carbon content is high enough to markedly effect the qualities of the product, merely because the temperature is even slightly above or below some critical point, this instrument should serve to reduce the chances of going wrong.

It is well understood that the structure of steel will be more or less crystalline, depending upon the temperature at which the same is raised and the rate of cooling of the same. This will be true for all grades of steel, but it will be especially true in cases in which the carbon content is a little high. If the structure is noticeably crystalline, it is then that the performance of the material will be below a desired standard, while in dynamic work failure is almost assured.

Fortunately it is possible to detect a difference in hardness of a given specimen of steel for the several "fracture" conditions. In other words, if the steel is "silky," the hardness will be that for such a structure; if the structure is crystalline, the hardness will fall off, and increasing crystallinity decreases hardness, with the result that the structures which are not kinetic can be detected by a man of no great skill.

What is needed is a set of standards which are known to be in a satisfactory state, in order that the instrument can be used on a comparative basis. In cementing work the question will be a little troublesome, on the ground that the "core" of the cemented structure will not be open to test in some cases. But it will nearly always be possible to grind through the shell at some point and apply the test to the core, with a view to finding out to what extent kinetic qualities reside therein.

It is in this cementing work that there is a need for great accuracy, since the shell can be hard with no assurance that the core will be kinetic. If the shell is hard, it may be what is wanted, but it will be of no avail if the core is brittle, on the count that the part will fail in service. It would be a waste of time to perform the cementing operation at all were it not for the desire to provide against brittleness; several grades of tool-steel will become quite hard enough if the materials are heated and quenched; brittleness is one of the properties in such products.

The instrument will tell the artisan, once he becomes acquainted with the performance of the same, whether or not it will be necessary to subject cemented products to a double treatment with the idea of correcting the core without destroying the hardness of the shell. It is well understood that cemented products can be rendered the more perfect, under certain conditions, if the double quench is resorted to. On the other hand, it is also well understood that the more complex process is liable to go awry, on the ground that if there is a hazard in one operation, there is a double hazard in two such operations. There is one other point which is prominent in the makeup of this instrument, namely, it is not so delicate as not to be handled by men of ordinary skill, and previous training is not so much of a factor. In general it is quite out of the question to entrust such work to men whose training is short of that which would follow some years of work in the laboratory, even assuming that a previous schooling might not be to advantage. In a word then, this instrument is of advantage to the busy practitioner, and its splendid accuracy is not to be destroyed by workmen, who may use the same.

EFFICIENCY OF INTERNAL COMBUSTION MOTORS*

By BERTRAM HOPKINSON, M. A., M. Inst. C. E. (Professor of Mechanism and Applied Mechanics, Cambridge University).

IN a paper read before this Institution two years ago, on the "Influence of Size Upon Thermal Efficiency," Professor Callendar based his conclusions upon a comparison of efficiencies by the Research Committee with the efficiency of a small air-cooled bicycle engine tested by himself. The measurements made then were never questioned, although it appeared that the data were incomplete. Professor Callendar, in order to arrive at a formula which should express the effect of size upon efficiency, made the assumption that, other conditions (which he precisely defined) being the same, the heat-loss and the efficiency of an engine are independent of the speed at which it is run. Though there was much to be said in favor of that assumption, it could not be said that there was direct experimental proof of it, and it did not command universal acceptance. Upon it, how-

ever, Callendar based the formula $0.75\eta \left(1 - \frac{1}{D}\right)$ for the efficiency of an engine of cylinder diameter D (inches), whose compression ratio is such that the air-cycle efficiency is η . The formula expressed, with an accuracy which went far to show that it was substantially right, the efficiency of engines so diverse in type as those mentioned above. Nevertheless, it was pointed out in the discussion that this agreement might be fortuitous, and that before it could be accepted as final it must be shown how far and under what conditions it could be considered as applicable to other instances.

The Results of Two Years' Tests.—The author has recently completed a study of a Crossley gas engine of 40 horsepower with 11 1-2-inch cylinder running at 180 revolutions per minute. It has been possible for him in the two years during which he has been engaged in the work, to deal with certain points which the research committee could not fully investigate, or could not touch at all, in the few days which were available for their experiments. Such are the effect of mixture strength upon efficiency, the accurate measurement of heat-loss under different conditions, and the temperatures reached by the metal of the engine. He has also been able to carry out some tests on a four-cylinder Daimler engine with 3 1-2-inch cylinders running up to 1,200 revolutions per minute. More recently the opportunity for further research has been provided by the Wolseley Tool & Motor Company, who have placed at his disposal one of their well-known four-cylinder motor-car engines. The experiments on the latter engine have only been in progress for a short time, and the results are not complete, but some are available.

The author proposes, therefore, to make a comparison between the Crossley engine and the high-speed type as represented by the Daimler and Siddeley (especially the latter), in respect of efficiency, power and heat-loss. The most important aspect of heat-loss being the temperatures in the engine which it causes, it will be considered mainly in that connection. Direct experimental evidence of the relation between the temperature and heat-loss is available in the case of the Crossley engine, but not in the other case. Conclusions here are to some extent speculative.

Engines and Testing Arrangements.—The Crossley engine develops 40 horsepower on the brake in ordinary full-load working at a speed of 180 revolutions per minute. The Siddeley gives about 34 brake horsepower at a speed of 1,000 revolutions per minute, and is capable, at 1,600 revolutions, of more than 40 brake horsepower.

In testing the Siddeley engine it was direct-connected to a dynamo and measurements of brake horsepower were based on the electrical output, the dynamo losses having been accurately determined. An indicator was used, applied to one cylinder only, and indicated power was based upon the brake power. The friction loss of the engine was determined using the dynamo as

a motor and reading the electrical power consumed. The petrol was contained in a graduated tank, and the rise of temperature and amount of jacket water were measured. The exhaust gases were analyzed by means of an Orsat apparatus.

The Daimler engine has cylinders 3.54 inches (90 mm) in diameter, while the stroke is 5.12 inches (130 mm), with a compression ratio of 3.85. At 1,000 revolutions it gives about 16 B. H. P. This engine was loaded with a Prony brake and the losses were measured by indicating one cylinder with the other three running idle and throttle wide open, but it was recognized that this method leads to an overestimation of the losses. So another method was devised which overcomes this, but still leaves the measurements of indicated power less accurate than those obtained electrically.

The following comparative table shows the relation between the two motors as regards dimensions and speed. The dimensions refer to a single cylinder of the Siddeley engine.

TABLE I.

	Crossley.	Siddeley.	Ratio.
Diameter (inches)	11.5	4.62	2.5
Stroke (inches)	21	5.08	6.2
Piston Area (square inches).....	104	16.8	6.2
Stroke volume (cubic feet).....	1.26	0.0495	25.5
Total cylinder volume (cubic feet).....	1.495	0.0655	22.8
Compression space (cubic feet).....	0.235	0.016	14.7
Compression ratio (r).....	6.37	4.18	1.52
Piston speed (feet per minute).....	630	850*	0.74
Piston displacement per minute (cubic feet)	113	24.7*	4.6

*At 1,000 revolutions per minute.

Methods of Determining Power Losses.—The measurements of indicated power were based on brake-power. In determining indicated power in this way, it is necessary to separately measure the engine friction, and experience has shown that it varies greatly with the temperature and lubrication of the cylinder walls. Measurement of this to be accurate must, therefore, be made when the engine is as nearly as possible in the same condition as when the brake-power and petrol consumption were determined. The procedure in the present instance was as follows: At the conclusion of the consumption test the supply of jacket water and of petrol was shut off and the engine was motored round at the exact speed which obtained in the consumption test. The power then absorbed is equal to the work done in pumping, compressing, and expanding the cold air in the cylinder plus that absorbed in friction. The first item was found in a separate experiment in which the power absorbed when motoring was measured, with the cylinders open to the air, and with the cylinders closed. It was also estimated from light spring diagrams. Both methods gave at 930 revolutions per minute about 3 horsepower, equivalent to a back-pressure of 7 1-2 pounds per square inch. Deducting this from the total, a measure of the power absorbed in friction is arrived at, which represents with reasonable certainty the power wasted by friction alone in the test.* The work absorbed in pumping when firing (about 1 horsepower) was determined from light spring diagrams and added to the friction and brake-power in order to obtain indicated power, which thus represents the positive loop of the indicator diagram. The petrol used was "Shell Motor Spirit" of density 0.721, and a large number of tests by the author and by others on petrol of various brands, and of density varying from 0.700 to 0.730, having shown that its calorific value was always within 1 per cent. or 2 per cent. of 18,900 thermal units per pound, that was assumed to be the value.

NOTE.—*There was a length of several feet of shafting between the engine and dynamo which necessitated an additional bearing near the flexible coupling. The friction of this bearing is, of course, included in the measurement, and the friction of the engine is on this account rather over-estimated. But this does not affect the Indicated Power measurement. [This loss is clearly underestimated, since the power absorbed would be much greater with the pistons loaded by the force of explosions.—Ed.]

*Paper read before the Institution of Mechanical Engineers at London, Eng., Feb. 10, 1909.

The following table shows the results of two satisfactory tests made at full load and 930 r.p.m.:

TABLE II.

	A.	B.
Work given dynamo, horsepower.....	23.9	29.7
Friction, horsepower	4.5	(4.5)
Pumping	1.0	1.0
Total indicated horsepower.....	34.4	35.2
Petrol supply, pounds p.m.....	0.308	0.310
Efficiency, based on petrol.....	0.252	0.256
Exhaust gas analysis:		
CO ₂ (per cent).....	13.5	13.1
O ₂	1.4	1.3
CO.....	0.0	0.3
H ₂ O (calculated).....	15.6	15.9

Combustion Is Rarely Perfect.—Separate experiments indicated that combustion is rarely quite perfect; in fact, tests upon the residue in case B, exploded with electrolytic gas showed a further 0.7 per cent. of CO (reckoned on the original volume of exhaust gas). Further experimentation proved that the exhaust may contain combustible matter even with an excess of oxygen, so if we allow for this unburnt gas, the efficiency in test B, reckoned on the actual heat-supply, is over 0.26.

According to the manufacturers, 32 I-2 B.H.P. were developed at 930 r.p.m. on a petrol consumption of 0.310 pounds per minute. It seems probable that the engine losses were for some reason rather less in their test, but they can hardly have been less than 3.5 horsepower (which would give a mechanical efficiency of over 90 per cent.). Taking that figure, the thermal efficiency works out at 0.26.

In experiments on the Daimler engine the efficiency was 0.255 at 900 r.p.m., reckoned on the total petrol consumption, the exhaust containing no excess oxygen or CO.

In comparing these results with the efficiency of the Crossley engine, regard must be had to the effect which mixture has upon efficiency. The author found that as the percentage of coal-gas was increased from 8.5 per cent. to 11.5 per cent., the efficiency fell from 37 per cent. to 32 per cent. In a discussion of these results it appeared that the determining factor in the efficiency of an engine of given compression ratio and size was the temperature reached in the explosion, which again depended on the heat supply per unit volume of the products of combustion. Looked at from this point of view, the Siddeley engine must be regarded as working with a high mixture strength, the air present being but little more than is just sufficient to burn the petrol. To arrive at the heat value of the mixture in the Siddeley engine, we may assume the temperature of the cylinder contents at the end of the suction stroke to be 150 deg. C. This figure is probably under-estimated.

The volume of the cylinder contents when reduced to standard conditions is 0.342 cubic feet. The heat supply per cycle per cylinder is 3.05 thermal units, equivalent to 73 thermal units per cubic foot of the mixture before explosion. After explosion there is an increase in specific volume of 5 per cent., so that the heat supplied per cubic foot of the products of explosion is 70 thermal units. In order to get an equivalent heat supply in the gas engine (with a decrease of volume of 4 per cent.), the cylinder contents before explosion must contain 11.2 per cent. of coal-gas, having a lower calorific value of 600 thermal units per cubic foot. The corresponding efficiency is 0.325, so that we can formulate the following table:

TABLE III.

	Crossley.	Siddeley.	Daimler.
Compression ratio (r).....	6.37	4.18	3.85
Air cycle efficiency $\eta = 1 - (1/r)^{\gamma}$	0.522	0.435	0.417
Measured efficiency.....	0.325	0.26*	0.255
Relative efficiency.....	0.62	0.60	0.61
Relative efficiency (Callendar).....	0.685	0.59	0.54

It will be seen that Professor Callendar's formula overestimates the efficiency of the Crossley, is about right for the Siddeley, and too low for the Daimler.

The formula gives a very close approximation to the efficiency

*The efficiency of the Siddeley includes an allowance for unburned gas. If this were ignored and the efficiency calculated on actual consumption of petrol it would be 0.254, and the relative efficiency would be 0.585. In the Crossley the combustion was complete, and in the Daimler the unburned gas was not determined, and no allowance was made.

of the large gas engine when run under the ordinary conditions. It would appear that in constructing a formula which takes account of dimensions only, the distributing effect of mixture strength ought to be eliminated by running the engines under identical conditions in this respect. If this be done, in similar engines running at the same piston speed, the relative efficiency is more nearly independent of the dimensions than the formula would indicate.

Efficiency Varies with Speed.—If the efficiency of an engine of given compression ratio and piston speed is nearly independent of its dimensions, it follows, that in its effect upon heat-loss, the greater proportion of surface to volume in a small engine must be largely counteracted by the shortness of the time of contact between gas and metal. The efficiency of an engine will then vary with its speed to a material extent.

The fundamental postulate on which Callendar's formula was based was the independence of heat-loss and engine speed; the greater turbulence of the gases at high speeds being supposed to increase their effective conductivity to an extent sufficient to counteract the shorter time of exposure. From this the efficiency of an engine is almost independent of its speed. Professor Callendar was careful to point out that this postulate only applies to that portion of the total heat-loss which affects the efficiency, namely, the loss which occurs during and soon after ignition. This is only a fraction of the whole heat absorbed by the jackets, which includes also the heat given up by the gases during exhaust—a loss which is without effect upon the mean pressure. Measurements of the jacket loss show some increase as the speed diminishes, but this cannot be relied upon as a proof that the part of the heat-loss, which is important in the present connection, also increases in the same way.

The argument based on turbulent motion loses much force when applied to the flow of heat with the piston at rest and when the gases have had opportunity to settle. It may be doubted whether the heat loss will differ greatly from that following an explosion of the same mixture at rest in a closed vessel of the same size and shape. The author has shown that the heat-loss following an explosion varies as the square root of the time elapsed since ignition, and it seems likely that a similar law governs the loss of efficiency due to heat-loss, which would vary inversely as the square root of the speed and inversely as the square root of the linear dimensions. A careful study of this question of comparisons of efficiencies at different speeds has been made on the Daimler engine, with the following results:

TABLE IV.

Speed in R.P.M.	Efficiency.	Exhaust Gas Analysis.			
		CO ₂	O ₂	CO	H ₂
720	0.245	13.5	0.2	0.7	0
1,000	0.26		Not taken.		
1,200	0.275	14.0	0	0	—

In each test the mixture was such as to give maximum efficiency which corresponded to the strongest mixture consistent with complete combustion. The above table gives results at 530 r.p.m., compare the following test at 930 r.p.m.:

TABLE V.

	530	535	A 930	B 980
Speed revolutions per minute.....	530	535	930	980
B.H.P.	18.0	17.0	28.9	29.7
Friction	1.6	1.6	4.5	4.5
Pumping	0.6	0.6	1.0	1.0
I.H.P.	20.2	19.2	34.4	35.2
Petrol per minute (lbs.).....	.219	.202	.308	.310
Analysis:—				
CO ₂	13.5	13.4	13.5	13.1
O ₂	0.5	1.8	1.4	1.3
CO	0.2	0.0	0.0	0.3
CO ₂ after exploding residue....	0.5	0.35	...	0.7
Efficiency on petrol consumption....	.207	.213	.252	.256

There is no question that the efficiency at 530 revolutions is at least 10 per cent. less than at 930 revolutions.

Power from the Automobile Engineer's Viewpoint.—From the point of view of the automobile engineer, the power is of greater importance than the efficiency. Given the efficiency, the maximum power is determined by the quantity of oxygen which the engine can burn per minute. The maximum amount of explosive mixture which an engine sucking from the atmosphere

can take in per stroke is equal (apart from scavenging devices, having the effect of replacing the contents of the clearance by explosive mixture) to the stroke volume reckoned at external temperature and pressure.

The ideal automobile engine would be one that took in the whole of this volume at each stroke, which is impossible because of the throttling at the valves and heat flow from the walls thus warming the mixture. From the exhaust gas analysis, it is possible to figure the quantity of air taken in and deduce from this in turn the percentage of the maximum possible amount of mixture which is actually taken in. With the average of the two tests at 930 r.p.m., this figures out at 69 per cent. In the case of the Crossley this varied from 82.1-2 to 87 per cent, while with the Siddeley the result is 83 per cent.

Difference in Heat Absorption.—In the Siddeley, however, there is a slight loss due to the fact that the pressure does not fall to the atmosphere until about 5 per cent. of the suction stroke has been completed. Allowing for this, it appears that the heat absorbed by the charge and the work done on it during suction are sufficient to warm it through 100 deg. C. against 60 deg. C. in the Crossley. The greater heat absorption in the Siddeley is perhaps due to the close proximity of the exhaust and inlet valves; a large part of the incoming stream of gas must pass over the exhaust valve, which will have a temperature of perhaps 300 deg. or 400 deg. C. Whatever the cause, however, it would appear that the reduction of this heat absorption during suction is a matter worthy of the consideration of designers. If the Siddeley and Crossley engines could be brought on to the same level in this respect the power of the former would be increased by about 15 per cent. The Daimler engine, when running at a speed of 750 r.p.m. was found to burn 0.197 pounds of petrol per 1,000 revolutions, the exhaust gases containing about 0.2 per cent. excess of O and 0.7 per cent of CO. Probably 0.19 pound per 1,000 revolutions would represent its consumption at this speed if the combustion were perfect. The corresponding supply of air is 0.0188 cubic feet per suction (reckoned at 15 deg. C.), making, together with the petrol vapor, 65 per cent. of the stroke volume. At a speed of 920 r.p.m. (when the piston speed is the same as that of the Siddeley) the ratio would not be more than 55 per cent.

In this respect, therefore, the more modern Siddeley engine shows a material improvement. This is doubtless due in part to its larger size, but the valve action is also probably better. The rise of pressure at the end of the exhaust stroke, due to the exhaust of a neighboring cylinder, was more marked in the Daimler than in the Siddeley, and it is possible that some of the exhaust gases backed through from the exhaust to the inlet pipe during the overlap of the inlet and exhaust valves. In the Siddeley engine, this overlap is reduced to a very small amount, and it is not possible that much gas can get through. Moreover, the Daimler engine did not "fill up" quite so well as the Siddeley at the end of the suction stroke. It is worthy of remark that the inlet valve of the Siddeley engine remains open until 45 deg. after the in-center.

The quantity of air taken per suction stroke falls off considerably with the speed, as is shown in the following tests of the Siddeley:

TABLE VI.

	A ₁	A ₂	B
Speed.....	530	535	930
Petrol per 1,000 revolutions (lbs).....	.42	.375	.333
Exhaust Analysis:—			
CO ₂	13.55	13.4	13.1
O ₂	0.55	1.8	1.3
CO.....	0.8	0.0	0.3
CO ₂ (residue).....	0.5	0.35	0.7
Air per suction per cylinder.....	0.041	0.0395	0.0335

It appears that the air per suction stroke is about 20 per cent. greater at 530 revolutions than at 930 revolutions. The ratio of air and petrol vapor to stroke volume is 83 per cent. at the former against 69 per cent at the latter speed. This difference is ascribable to better "filling up" at the end of the suction stroke, but mostly to the lower temperature of valves and walls so that the charge is preheated less.

Tests on the Daimler engine showed an even greater variation in the volume of charge taken in, with the variation in speed:

TABLE VII.

Speed R.P.M.	Petrol Taken per 1,000 Revs.	Ratio of Air and Vapor to Stroke Volume.	Vacuum in Inlet-Pipe. (lbs. per sq. in.)
720.....	0.197	0.65	0.6
1,000.....	0.16	0.53	
1,220.....	0.138	0.455	

Analyses taken at 720 and 1,220 r.p.m. show that the combustion was nearly complete, and that there was no excess oxygen. At 1,000 revolutions no analysis was taken, but the petrol consumption was that corresponding to maximum efficiency, and it is certain that combustion was practically complete.

Length of Exhaust Pipe Influences the Power.—The charge volume is greatly influenced by the length of the exhaust pipes. In the tests on the Siddeley and Daimler engines which have been described, the engine exhausted through a short pipe into a box. The effect of gaseous inertia is then comparatively slight at all speeds; at 930 r.p.m. the pressure drops to atmosphere at about the middle of the exhaust stroke, and then rises again. If the exhaust pipe were considerably longer, the pressure drop would be delayed, its amount increased, and the result might be to cause a partial vacuum in the clearance space. Since the clearance volume is one-third of the stroke volume, it is obvious that a great improvement in power can be effected by filling it with mixture. The Wolseley Company informed the author that they have tried experiments of this character, and that by making use both of long inlet pipes and long separate exhaust pipes, they have increased the power of an engine by as much as 50 per cent. at high speeds. The author believes that some early tests of his own on the Daimler engine, in which considerably higher mean pressures were realized than those obtained by Mr. Morse, are to be explained by a difference in the exhaust conditions. Mr. Morse, with a short exhaust pipe opening into a box, could only obtain 15 B.H.P. at a speed of 1,000 r.p.m., the petrol consumption being 0.16 pounds per minute, whereas in the earlier tests over 17 horsepower was recorded with a petrol consumption of 0.22, some of which was probably unburned.

Heat-Flow and Its Influence.—The effects of heat-flow are of far more importance practically than its effect upon efficiency, which is comparatively slight. This is more especially true of large engines in which the stresses due to unequal expansion constitute a serious problem for the designer and are responsible for many failures. But the subject is not without its importance in the construction of small motors. The expansion stresses are not, as a rule, serious in such cases.

The factors determining the temperature of the metal at any point on the inner surface are the mean rate of heat-flow per unit area into the wall near that point, and the distance which the heat has to travel before reaching the jacket-water. The first of these factors is dependent mainly upon the gas—its density, temperature, and state of motion—and is but little affected by the temperature of the solid surface within the limits which are possible in practice. It is obvious that gas having a temperature of 1,500 deg. C. will lose heat at nearly the same rate to a metal surface, whether that surface be at 100 deg. or 300 deg. C. The second factor is mainly dependent upon the design and size of the engine, and on the conductivity for heat of the metal, composing the cylinder walls.

A rough approximation to the rate of heat-flow per unit of area can be obtained by dividing the mean area exposed to the hot gases into the total heat carried away by jacket-water and radiation. An estimate of this kind can, of course, only give the order of magnitude of the absolute value of the heat-flow at any point, for the distribution of the jacket loss over the different parts of the cylinder wall is not uniform, and is very imperfectly known. But it will serve as a fair basis of comparison between different engines, provided that the "mean area" used in the calculation is taken out in the same way for all. From this the temperature gradient necessary to extract the heat may be figured.

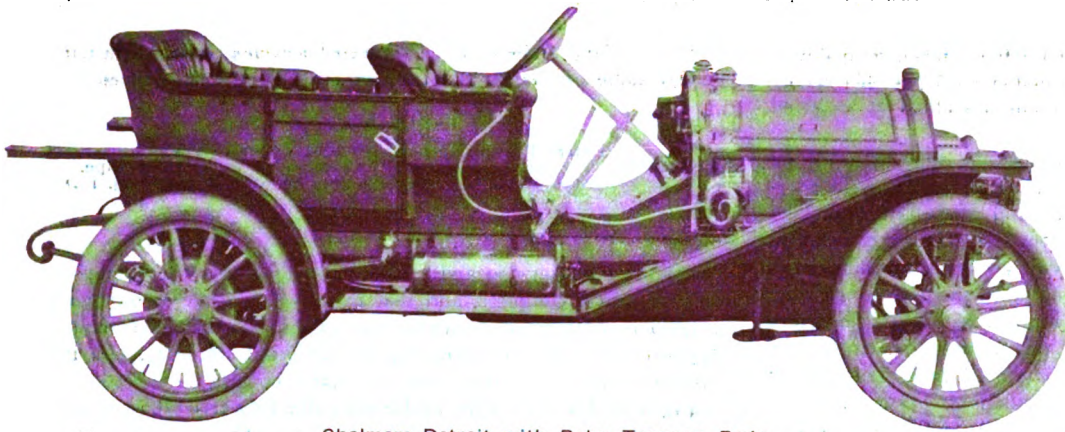

Chalmers-Detroit with Baby Tonneau Body.

POPULARITY OF THE TOY TONNEAU.

The trend in body designs is in the direction of comfort and simplicity with a certain well-defined attempt to engender strength of the kind which makes for long life. From the rear-entrance tonneau to the seven-passenger side-entrance body was a long way, and in the judgment of numerous autoists there was a want unfilled in that the middle chamber of automobile body designing was left to its own devices, so to speak. Many autoists failed to see the logic of a body so roomy and commodious as to render it even uncomfortable, due to the fact that it is hard to stay in the seat if the foot room is so great as to make it difficult to realize a braced position under road conditions which tend to "bounce" the occupants.

Certain five-passenger bodies are so very good for the purpose that it will come as no surprise to note that the long wheelbase car-makers are now taking kindly to this class of bodies in modified form. Furthermore, "toy tonneaus" will be found on many of the best class of automobiles in which the wheelbase easily affords room for seven-passenger bodies. In the use of this construction it is possible so to locate the rear seat as to render easy-riding qualities so plausible that

preference is given to the toy tonneau by autoists of discrimination.

There is a difference between the conventional five-passenger body, as it is generally understood, and a modern toy tonneau, in that the five-passenger body is scarcely big enough for five; at any rate it is generally believed that three passengers in the rear seat feel as if they are living in a congested district. The toy tonneau, on the other hand, is intended to afford all the room required by two pas-

sengers—adults, in point of age and girth—and at the same time render the experience far more comfortable than it might be in a standard seven-passenger body.

Chalmers Idea of Baby Tonneau.—The illustration at the top of the page shows a Chalmers-Detroit 40-horsepower car fitted with a baby tonneau body. In this case the foot room is

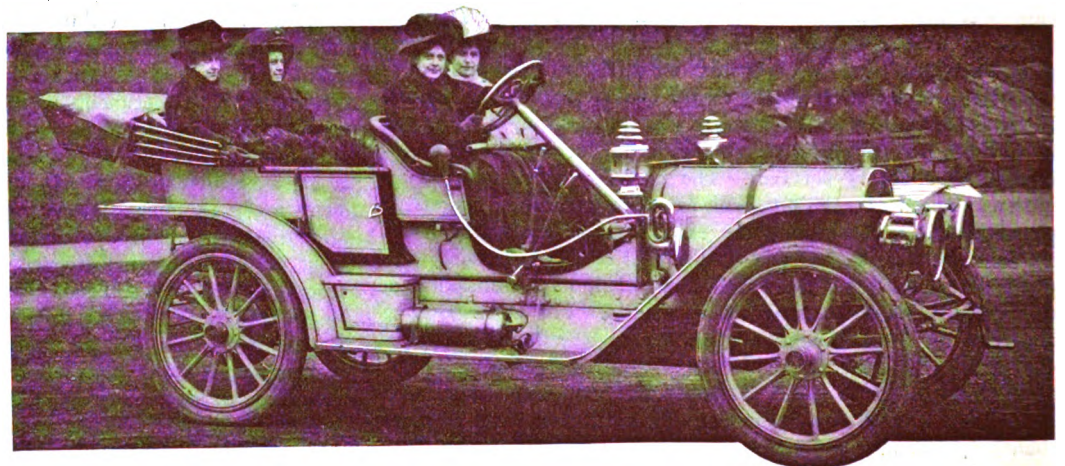

The Haynes 1909 Model, Equipped with the Popular Toy Tonneau.

liberal and the side entrance is far enough to the front so that there is ample room to get in and out without brushing against the rear mud guards which as their name indicates are usually muddy. The rear seat room is also liberal although the body is intended for but five passengers.

Popular Little Haynes.—The plot of the play "The Man From Home" being laid in Kokomo, Ind., the home of the Haynes car, it is particularly appropriate that both of the stars in the play should drive Haynes cars. The central illustration shows the leading lady at the wheel of her top tonneau.

Selden Toy Tonneau.—The view of the Selden car allows a clear insight into the tonneau, which is seen to be divided as for two people. This gives each one a little more comfort than does the straight-backed form of upholstery, usual in tonneaus. The long wheel-base so clearly brought out in the picture, makes for easy riding qualities. A large steering stock allows turning in short radius.

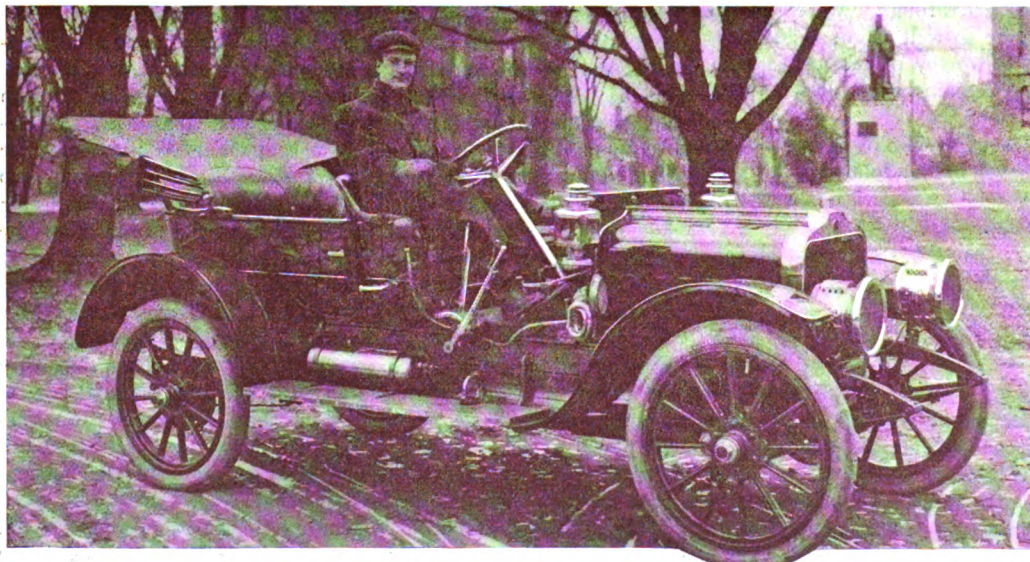

Henry R. Selden, at the Wheel of 1909 Selden, with Toy Tonneau.

MULTIPLE-SERIES PROLONGS BATTERY LIFE

By A. L. HASKELL, NATIONAL CARBON COMPANY, CLEVELAND, O.

THE arrangement of dry batteries as shown on the accompanying diagrams is not altogether new but until comparatively recently, it was not realized just how good an idea it was and how very useful. Another thing is that we have been able to get the dry cell to a point where deterioration is so small with the series-multiple connection. Some cells have been used six or nine months, but did not deteriorate to any extent. This enables us to get the full benefit of the series-multiple connection, which we have hitherto been unable to do. The figures explain the conditions of the tests. They were made on a four-cylinder, four-cycle engine of the automobile type at 1,700 r.p.m. We did not test every coil made, but we tested a good many, and we found that with almost every coil we tested we could get just as good results from four cells in series, in spite of the fact that people usually use five or six. We took three, four, five, six and seven cells, and tried them in series, and found in every case the length of serviceable life was almost identical, but with the three cells in series the engine would miss occasionally. With four cells the service was entirely satisfactory in every way, and you would get just as long service.

From this we have reached the conclusion that four was the most advantageous number, and so have used this number in all later tests. There are some coil makers, however, who object to these figures and recommend that their coils be used with five or six cells, and in that case we suppose the best thing to do is to take the coil maker's recommendation.

PRACTICAL TESTS—ACTUAL ENGINE SERVICE.

No.	Arrangement of cells.	Hrs. service.	Estimated miles service.	*Estimated cost per 100 miles.
146	1 set of 4 in series.....	20	400	25c
246	2 sets of 4 in series-multiple.....	70	1,400	15c
346	3 sets of 4 in series-multiple.....	120	2,400	11c
446	4 sets of 4 in series-multiple.....	170	3,400	8c

*At retail prices of batteries.

CONDITIONS UNDER WHICH TESTS WERE MADE.

1. Engine equipped with standard commercial timer and coil.
2. Average speed of running, 20 miles per hour.
3. Test stopped when engine began missing fire.
4. Cells used, Columbia Igniters (size 2½ x 6 inches).
5. Continuous service.

Diagrams are Self-Explanatory.—The diagrams show how the cells are connected together in multiple series. The dry cell is not intended for very heavy service, which is the explanation of the result shown. It can stand a certain amount of current drain. If you were to subject the dry cell to a very heavy drain, hydrogen would form and the cell would go out of business. When you connect the cells in multiple, the drain is evenly divided. In sending out these cells, the only trouble is that the average layman, unless he has a diagram, is apt to get confused and put too many cells in series, which will burn up the points and injure the vibrator points, so that we recommend sending the cells out in cases; and it is a mighty good thing to seal these cases in wax, provided you do not put it in too hot. This would set up internal action in the cell, but wax can easily be poured in at a temperature that you can put your finger in. This protects the cell and gives it a show.

In connection with the cells getting wet, each individual cell in itself is practically water-proof. Some cells are sold on the market as water-proof, but, as a matter of fact, each cell is ordinarily water-proof anyway; but if connected in series and you get them wet, it will hurt them, having them touch, whereas in single sets, it would not hurt.

*Paper read before the National Gas and Gasoline Trades Association, Chicago, Feb. 9, 1909, and the discussion of the same.

Discussion of the Paper.—President Wilson: Do I understand that connected in multiple series the drain is the same from each series?

Mr. Haskell: It is very closely the same.

President Wilson: Is not the resistance through one set of four different from some other set of four?

Mr. Haskell: It will vary a little, but in practice it does not make any difference. We have tried that, but the question arises, if you have one dead cell, whether the others are not discharging through that, and building up the voltage on that set. The large cells give very good results, and it is a question whether the efficiency of the smaller cell is greater than of the large cell. The large cell is efficient in present sizes, but whether it is more efficient than a series-multiple connection I am not prepared to say.

Deterioration Limits the Combination.—President Wilson: Could this connection be carried out ad infinitum?

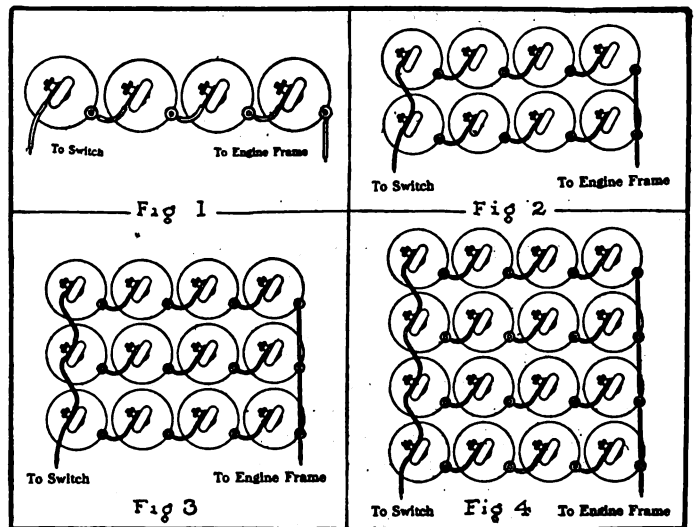

Showing Batteries in Series and in Multiple-Series Relation.

Mr. Haskell: There is a limit, due to the amount of space you want to take up, and the deterioration of the cell. Any dry cell deteriorates to a certain extent, and it would not pay to carry the thing into four or five years.

President Wilson: What is the life of a dry cell under good conditions by your limit?

Mr. Haskell: That is hard to tell. We do not know what the shelf wear of batteries is.

President Wilson: How long do they become inefficient by shelf wear?

Mr. Haskell: We recommend that the battery be put into service within 60 days, in order to get efficient service.

President Wilson: On an engine, how long can they be used?

Mr. Haskell: They have been used for several years. The average is about six to nine months.

President Wilson: In a single cylinder cut-out hit-and-miss engine I find that it does not exhaust cells at all. That is, the cells go out by age limit on the ordinary engine. We have people who use them for a year and a half with one set of cells. It is not always the case, but it occurs often enough to make me think that we do not use the cells up. They simply go out by age limit. In the ordinary hit-and-miss engine the batteries will not run out in eight or nine months.

Where the Cost Ceases to Decrease.—Mr. Linn: In the last column of costs you keep on decreasing. Have you carried that out to a point where it starts to increase?

Mr. Haskell: We have carried it out as far as is practical to use them under ordinary conditions. With the reasonable coil adjustment and four sets in multiple, you get pretty fair service. In lighting in a boat last Summer we burned five lamps continuously for a month and we put ten sets of dry cells in multiples. During that time the lights had not begun to dim and we used them the rest of the season and they did not go out.

President Wilson: There would be no value in this for single-cylinder engines, which would use up one set in nine months.

Mr. Haskell: There is one more point. After the cells have been used and get down to a certain point, you can get a remarkable amount of power out of them if you connect them in series. However, it is better to connect them in series first and start with them that way. In an automobile or boat you get a reserve and are not left suddenly without any current, as might otherwise be the case.

President Wilson: In a hit-and-miss engine the coil, while it may be extravagant in amperage consumption, makes a better spark for the engine. We can take a coil that has a low amperage test and put it on an engine and it will miss. We can make no other adjustment and put on a coil with a high amperage consumption and the engine will run along.

Influence of Batteries Upon Coil Service.—Mr. Williams: The coil that apparently shows a high consumption in current has a low resistance in winding, and if it has polarized to an extent that the voltage is low, you can put it on a coil with low voltage and it will still give some service on account of the resistance being low. It should, however, have a short timer segment and you will get better life out of the battery than you will out of a high-resistance coil.

President Wilson: With the one that would miss on the low consumption coil, we could increase the timing length and keep the engine from missing.

Mr. Williams: You can not do it when the battery is exhausted down to the low voltage. Automobile engineers make laboratory tests of coils. They put them up with dry batteries and run them continuously for so many hours to see which would run the greatest number of hours, and they would say, that is the coil for us, because the batteries last longer. They do not run them on timers with the proper length segment with each one using the coil. If they did that, they would find that the coil which used the batteries up the quickest on the long run, would give them the longest run on intermittent service, and the coil makers would have to make the coils to suit the engineers.

GOODYEAR'S NEW TIRE-MAKING MACHINE

AKRON, O., March 1.—The completion and practical operation of a tire-making machine by the Goodyear Tire & Rubber Company promises to work something of a revolution in the manufacture of pneumatic tires and to affect radically the industry so far as manual make is concerned. If the claims of the company are true the Goodyear company has the unusual good fortune to have been the first tire-making company to attain what has been the aim of the industry for years. The company now has four of these machines in operation in its new building and is preparing to install four more. Frank A. Seiberling, president of the company, is the designer.

American companies having found the machines used in France, and first used there, to be unsatisfactory, several have spent much thought and time on trying to make a better machine. It has been known for some time that the Goodrich, Diamond and Goodyear companies have been developing a machine, and the Goodrich company has had a limited number in its newest factory, but it has made no public announcement of its success. The Goodyear company has received applications from other

companies for the right to use its machine in manufacturing. George M. Stadleman, secretary of the Goodyear company, in explaining the practicability of it, says:

The durability and longevity of a tire has been largely dependent on the skill and strength of the man who made it. All chance of weakness in any spot in laying layer upon layer and stretching the fabric on is now declared to be done away with by the machine's unvarying strength. To give the greatest mileage, the fabric must be stretched to an absolutely even tension over each portion of the tire, and each alternate layer of fabric must be given the same tension as those previously put on. This evenness of tension can never be given where human hands are depended upon, as tires made in the morning, when a man is fresh, will be stretched more evenly and tightly than later in the day, when his muscles are weary. Thorough tests covering the past 14 months have conclusively shown the vast superiority of machine-made tires over hand-made, in the matter particularly of blowouts, fabric breaks and separation between the plies of fabric. There is the further advantage that while by handwork a skilled workman can turn out only six or eight tires a day, and few do this well, with the machines a man of average skill can make perfect tires at the rate of 50 a day. Besides, the machines make all sizes with equal rapidity, while it takes a man longer to make the larger sizes.

THE AUTOMOBILE CALENDAR

AMERICAN.

- March 6-13.....Boston, Mechanics Building, Seventh Annual Automobile Show, Boston Automobile Dealers' Association. C. I. Campbell, Manager, 5 Park Square.
- March 8-13.....Kansas City, Kansas City Automobile Dealers' Association Show.
- March 8-14.....Portland, Ore., First Annual Automobile and Sportsman's Show, Portland Automobile Club. W. F. Lipman, Secretary.
- March 11-13.....Milwaukee, Wis., Hippodrome, First Annual Show of Milwaukee Automobile Club.
- March 13-20.....Minneapolis, Minn., National Guard Armory, Second Annual Show, Minneapolis Automobile Show Association. F. E. Murphy, Secretary.
- March 15-20.....Rochester, N. Y., Convention Hall, Annual Show, Rochester Automobile Dealers' Association. Chas. J. Moran, Exhibition Manager.
- March 22-27.....Toledo, O., Colliseum, Annual Automobile Show, Toledo Automobile Dealers' Association.
- March 27-Apr. 3..Pittsburg, Duquesne Garden, Automobile Show, Pittsburg Automobile Dealers' Association.

Races, Hill-climbs, Etc.

- March 5-12.....Palm Beach, Fla., Lake Worth, Fifth Annual Regatta. Palm Beach Power Boat Association.
- March 11.....New York to Boston, Second Midwinter Endurance Run for the Chester I. Campbell Cup.
- March 23-26.....Daytona, Fla., Seventh Annual Florida Beach Races, Florida East Coast Automobile Association. New York Representative, W. J. Morgan, Thoroughfare Building.
- March 24-27.....Syracuse, N. Y., State Armory, Automobile Show, Syracuse Automobile Dealers' Association.
- April 5-10.....New York City, Carnival Week, New York Automobile Trade Association.
- April 10.....New York City, Fort George Hill, Second Semi-Annual Hill Climb of New York Automobile Trade Association.
- April 27-30.....Detroit, Mich., Four-Day Endurance Run, Detroit Automobile Dealers' Association.
- May 3-6.....Harrisburg, Pa., Third Annual Endurance Run, 700 Miles, Washington, Baltimore, Scranton, Motor Club of Harrisburg.

INCREASING MOTOR POWER PER UNIT OF MASS*

By G. LUMET.

DIMINISHING the weight of the motor, or to express it technically, increasing its power per unit of mass (*puissance massique*) is the chief aim of the designer to-day. It may be well to explain at the outset just what this expression signifies. Formerly the term generally employed was specific power. The more powerful the motor was with relation to its weight, the greater was its specific power. A motor weighing 330 pounds and producing 20 horsepower had double the specific power of one weighing twice that much for the same output. But upon closer investigation, it will be seen that the expression "specific power" is not absolutely accurate in that it involves the factor of weight, which varies at different points on the earth's surface. A certain mass of lead would not have the same weight at the equator as it did at the pole. It follows, in consequence, that a motor would not have the same specific power at these two points. Hospitalier has accordingly proposed to substitute *puissance massique*, or power per unit of mass, for this expression, as the factor of mass would always have the same value.

Light Motor Responsible for the Aeroplane.

By grace of its light weight and great power the explosion motor has given us the automobile; it has made it possible to accomplish the most important progress in aviation, and, finally, it has brought about flight with the heavier-than-air machine. It would appear that the practical limit of weight reduction has long since been reached on the automobile and there is no further incentive to progress in that direction; likewise, there is but faint interest in advances of this nature on the dirigible balloon. Seemingly the only cause for the continued study of the light motor is for the benefit of the aeroplane. I believe it will be interesting to show that for the greatest good of any of the devices utilizing the power of the motor, whether on the road, in the air or on the water, every gain in weight represents progress.

But, it may be said, it will be necessary to increase the angular velocity of the motor to attain that end, and difficulties in lubrication will be encountered. The useful life of the motor will be shortened. The problems of ignition, fuel supply and cooling will all be complicated. Is the angular velocity of the motor the sole factor in the increase of power per unit of mass? I propose to show that it is not, and that for certain applications of the explosion motor it is not necessary to tend toward an increase in angular velocity. The lightening of the motor may be realized by a logical study of the other factors involved. Motors in current use, in actual running order, weigh from 17 to 22 pounds per horsepower, for units between the limits of 20 and 50 horsepower. Assume that we have a car with a 30-horsepower motor, weighing 22 pounds per horsepower, or a total of 660 pounds, and it is proposed to substitute for it one of the same power but half the weight. Should not such an advance be regarded in the light of progress?

With all the accessories now carried, such as headlights, generators or acetylene gas tanks, spare tires or wheels, tire inflators, trunks and the like, are we not traveling with considerable excess baggage, the weight of which would stand some reduction? Here we are offered a decrease of 330 pounds in the weight of the motor alone. Pneumatics are indispensable on the automobile. They must be regarded as such and conditions made as favorable as possible for their use. On the other hand, the motors of commercial vehicles must be substantially built, but a study of the conditions governing an increase in the power per unit of mass will prove that the motor may be lightened without affecting its durability. It is equally well understood that dirigible-balloon motors are already sufficiently light. Marine motors must be very durable and must also produce their rated power at a comparatively low angular velocity, as

the propeller is not adaptable to high speeds. It cannot be denied that considerable interest attaches to the creation of a motor which shall be greatly lightened without affecting its durability or without increasing its angular velocity, which will permit of greatly augmenting its radius of action by allowing an increase in the amount of fuel carried through the saving in weight.

Increasing the Mechanical Efficiency.

The factors influencing an increase in the mechanical efficiency of a motor are numerous. It is proposed to review these factors and we have ranged them in three groups:

1. Those having to do with the construction of the motor.
2. Those having for their effect an increase in the motor couple.
3. Those having for their effect an increase in the angular velocity.

The first class comprises those, which by a logical grouping of the members of the motor, contribute to the decrease of its weight. The Esnault-Pelterie motor (seven-cylinder, air-cooled with two-throw crankshaft and one-piece cam, 35 horsepower, weight 220 pounds or 6.2+ pounds per horsepower) is a typical example of the importance of the factor of proper grouping of the members in weight saving. A comparison of the dimensions of this motor and a standard automobile type of the same cylinder dimensions recently made showed that all the moving parts, bearings, etc., were on an equivalent scale.

Air-cooling is an equally important factor in weight saving. In a paper on the subject prepared by M. L. Perissé for the Technical Commission of the Automobile Club of France, he has placed air-cooled motors in two classes. The first includes motors in which the general arrangement is conventional, and upon which has been superimposed a special air-cooling system, eliminating the employment of water. The Frayer-Miller and the Hautier motors are of this type. The second class is that in which a peculiar type of construction has been adopted with a view to permitting the use of air for cooling, examples of this being found in the Franklin and the Farcot motors.

Materials an Important Factor.

The choice of materials for motor construction and the lessening of the weight of moving members to decrease inertia effects are further factors, upon which a very interesting paper was recently read by M. Guillet before the Society of Civil Engineers. The following are some of his conclusions:

Important investigations are now being carried on with a view to the production of materials of high resisting qualities, this being accomplished in alloying by the addition of diverse elements, notably vanadium. It is well known that magnesium, added to aluminum in small quantities, produces an alloy of excellent resisting qualities and of a lesser density than the ordinary aluminum alloys. Why should such products not be employed in light motors? The great increase in the tensile strength and elastic limit of automobile steels now produced permit of a notable reduction in the weight of motor parts and chassis. The Germans have also recently brought out a remarkably light alloy for use in bearings, while the improvements in the direction of weight saving made in castings are really marvelous. Metallurgy has given up another of its valuable secrets to facilitate the lubrication of motor parts running at extremely high speeds, under which conditions it would be almost impossible to attain this end with the ordinary liquid lubricants. M. Guillet thinks it will be necessary to employ "auto lubricating" alloys for this purpose and that special mixtures of bronze and lead will serve best, the free lead playing the rôle of a lubricant at the excessive speeds employed.

At the present time the possibility of the employment of pistons of aluminum alloys is being investigated with the hope of being able to realize a great saving in the weight of the moving mem-

*Translated from the French of *Omnia*, by Charles B. Hayward.

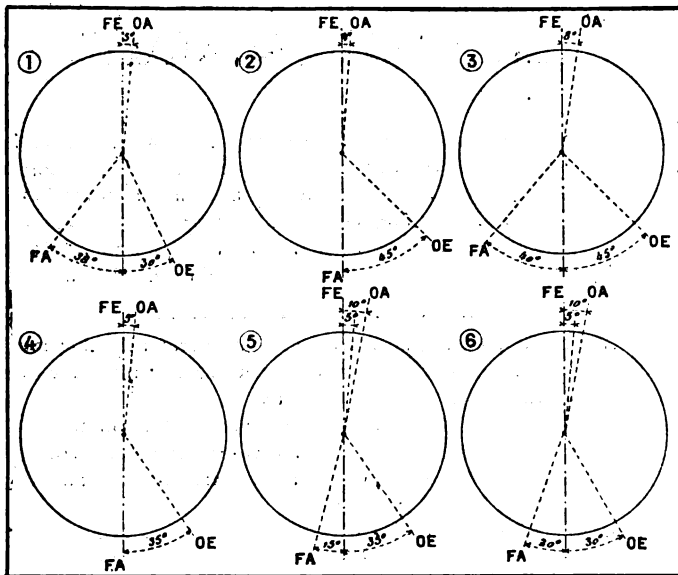

Figs. 1, 2, 3, 4, 5 and 6—Various methods of valve timing which gave increased power. O A F A, point of opening and closing inlet valves. O F F E, point of opening and closing exhaust valves.

bers, and, in consequence, a great reduction in the inertia effects. Aluminum is an excellent conductor of heat and readily parts with the heat units transmitted to it. This has an important bearing on the matter, as in a motor that has been designed to have an initial compression just short of the point of auto ignition the greater the speed the closer will this point be approached. Needless to add it will frequently be passed after running steadily for a length of time. This phenomenon arises, in part, from the fact that the piston being submitted to the heat of the explosions at very high frequency, rises in temperature to a point where auto ignition is inevitable. Moreover, the filling of the cylinder is less and less perfect at high speeds.

Consequently, if we can cool the piston the compression can be slightly increased, which will better the thermodynamic output of the motor accordingly, while by a study of the best forms of manifolds and inlet ports the more perfect filling of the combustion chamber at high speeds may be accomplished.

Augmenting the Motor Couple.

Among the conditions favorable to an increase of the motor couple must be comprised:

1. All those which have for their effect the more perfect filling of the combustion chamber, the conditions of fuel supply from the point of view of the flow of the gases, as much in the carbureter as in the manifolds, being something that should be par-

ticularly studied. Every loss in the charge is a factor tending toward the diminution of the weight of the carbureted mixture introduced. The gases should move at the lowest speed possible compatible with the proper entraining of the fuel with the air and its pulverization. This condition leads to the selection of a carbureter of large capacity.

2. In this class must be comprised those conditions favorable for ignition, both where the energy liberated by the ignition is concerned as well as the choice of the location in which is to be produced are concerned.

3. The influence of valve timing. The importance of this factor has been well demonstrated by the comparative results obtained by various settings. It is not so long ago that it was considered proper to close the inlet valve at the lower dead center. When the piston begins to return on the upstroke its linear velocity is then very low, while the speed of the gases being aspirated is, on the contrary, high and their kinetic energy is such that they continue to enter despite the piston rising against them. It must be borne in mind that the proper point for the closing of the inlet valve depends somewhat on the speed of the flow of the gases, and in consequence, upon the characteristics of the motor and the sections, length and form of the manifolds.

Some Different Valve Settings Compared.

The figures reproduced herewith serve to illustrate some different standards of valve timing employed on a number of motors. The letters O A, F A, indicate the points of opening and closing the inlet valve, while the letters O F, F E, indicate the opening and closing of the exhaust valve. Fig. 1 represents the timing of a motor of 3.9-inch bore (100 millimeters), which, according to the formula of the *Commission Technique* of the Automobile Club of France, should produce 33.88 horsepower, and which, in reality, showed 40.28 horsepower. Figs. 2 and 3 are modified standards of timing the same motor. With the first (Fig. 2) it showed an increase that brought its total up to 50 horsepower, and with the second (Fig. 3) an output of 56.5 horsepower. Figs. 4, 5 and 6 represent successive variations in the regulation of a motor which gave 28.2 horsepower with the first and 33 horsepower with the third.

An increase in the compression is a favorable element in the augmentation of the motor couple, but the value of its effect on the increase of power per unit of mass is doubted by some authorities. The point of opening the exhaust valve plays an important part in the increase of compression, in that these two elements are interconnected in their influence on the increase of the angular velocity. If the compression be increased within the limits of auto ignition, of course, it will be necessary to advance the point of exhaust-valve opening in order to increase the angular velocity. In this manner one part of the cycle may be bettered, but another is sacrificed.

HARMONIOUS RELATIONS SHOULD OBTAIN

IF the design is right, and the materials are as good as they ought to be (theoretically), then it is assured that any process which will maintain the torque at a maximum and allow of increasing the speed to the mechanical limit, from the gear ratio point of view, will end in the maximum possible result from the point of view of the reciprocating motor under conditions not including a change in the fuel. It is easy enough to handle speed up to at least 3,000 r.p.m., and the process resolves itself into one which will realize torque on a stable basis as a result. The maximum torque will be the product of efforts in the directions as follows:

- (a) By the elimination of mechanical losses;
- (b) through the utilization of the most suitable mixtures;
- (c) if the timing is correct;
- (d) assuming the scavenging is well done;
- (e) through the use of an energetic ignition system;

- (f) effective cooling at the most advantageous temperature;
- (g) the maximum volume of the charge, or mixture;
- (h) the most advantageous compression.

The mechanical means of arriving at these desirable conditions is a matter that has no place in this article. That a motor to do the work, as here indicated, must be of a harmonious design, goes without saying; moreover, it is not enough to say the valves must be large. It is not necessarily a fact since they may be relatively small, and by opening them at the propitious instant, and holding them open long, the relatively small valves may be even superior. If valves are large, then it is to note that they will be more prone to warp, and warping means loss of compression. In a dozen ways there are mechanical reasons why a motor may perform below the requirements, from the point of view of holding to a maximum torque, and preventing the torque from falling away as the speed increases.

Letters Interesting and Instructive

FREMONT IMPACT TEST FOR MATERIALS.

Editor THE AUTOMOBILE:

[1.769.]—In view of some of the articles in THE AUTOMOBILE in which the question of the qualities of materials are discussed and the tests for impact are given, would it not be a good idea to explain the nature of the "Fremont" test for illustration? This is the impact test most used, perhaps. I, for one, do not well understand the nature of the test, although I do appreciate the fact that the material is shocked to rupture.

L. E. D.

Oakland, Cal.

In this test for impact ability of materials the "proof" is machined to some predetermined size. For illustration:

- (a) Length, 35 millimeters;
- (b) Beam width, 10 millimeters;
- (c) Beam depth, 8 millimeters;
- (d) Notched at the middle, on the under side, to a depth of 1 millimeter, thus making the depth of the bar 7 millimeters at the notch. The bar, so finished, is set upon supports, so that the unsupported distance is 30 millimeters, with the notch on the under side, midway between the supports.

(e) In this position the test-piece is struck one blow with a "tup," designed to afford the requisite energy to fracture the specimen. In a word, considering a given weight of the "tup," the distance of the fall is so regulated as to gather enough energy to fracture the specimen.

(f) The residual energy in the weight (the energy in excess of the exact amount required to fracture the test-piece) is measured by allowing the weight and the fractured test-piece to fall on a steel plate, the latter being in the same plane, below, resting upon springs. The pressure on the springs produces a deflection, and, in view of the fact that the springs are carefully calibrated, they serve as a spring balance, and by the use of a suitably devised lever the energy absorbed by the springs is taken note of.

(g) The energy represented by the fracture of the test-piece is the difference between the prime impact energy of the "tup," deducted from its mass and distance of fall, and the residual energy, as shown by the interpretation of the spring plate performance.

(h) In this way the impact resisting properties of the steel are arrived at within about 1-75, considering the use of fairly tough steel. On the other hand, it is fair to say that the actual accuracy of the test is dependent largely upon the quality and condition of the steel.

There are divers ways of testing for impact and each has advantages as the conditions change. This phase of the subject is so broad and so important that it will not be possible to interject here a comprehensive discussion of its phases.

TAKES TIME TO GROW A DEPTH OF CARBON.

Editor THE AUTOMOBILE:

[1.770.]—Please tell me if a piece of cold rolled steel can be case-hardened by any process in a few minutes. As I understand it, the carbon content in the "normal" steel is below 10 points, and since case-hardened steel, considering the shell, has a carbon content of about 90 to 110 points, I do not see how any quick process will result in any great depth of the hard shell

HARDENER.

Philadelphia, Pa.

There are hundreds of receipts said to be satisfactory for this purpose, but few have been accepted by metallurgists. Authentic information on the subject seems to lead to the conclusions as follows:

- (a) The time depends upon the composition of the cement;
- (b) The heat (sensible) influences the situation very much; 900 degrees centigrade is a safe temperature;
- (c) For a penetration of 10 to 12 thousandths of an inch, the time required, considering the above temperature, will be 1 hour, after the parts reach the degree of heat stated. In 10 hours the penetration will be about 5 times what it will be in 1 hour.

RELATION OF AIR TO GASOLINE MIXTURES.

Editor THE AUTOMOBILE:

[1.771.]—I wish to determine the volume of liquid gasoline required to produce a given volume of vapor, and the ratio of gasoline vapor and air for the best explosive mixture. Can you give me the above information?

CHANDLER PRINCE.

Ann Arbor, Mich.

Gasoline is a somewhat uncertain mechanical mixture of several hydrocarbon (fractional) distillates, in which the compound "hexane" is supposed to be the major portion. This compound answers to the formula C_6H_{14} , the products of combustion of which will be $CO_2 + CO + H_2O$, in which CO will not be found if the combustion is complete. A final expression of complete combustion will be as follows:

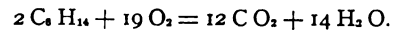

Taking into account the atomic weight of the elements, the volume of air required in the complete combustion of 1 pound of hexane may be set down as follows—atomic weight of the elements involved:

Carbon (C).....	12
Hydrogen (H).....	1
Oxygen (O).....	16

The molecular weight of $C_6H_{14} = 6 \times 12 + 14 \times 1 = 86$; the required oxygen will weigh (molecular) $19 \times 16 = 304$; the ratio of the compound, hexane, then, to the combining oxygen will be

$$\text{Ratio} = \frac{304}{86} = 3.54, \text{ nearly.}$$

Considering 1 pound of hexane, the weight of oxygen required for its complete combustion will be equal to the ratio as above given, i.e., 3.54 pounds, nearly.

Since the oxygen is taken from the air, it is necessary to consider dry air in the attempt to determine as to the weight of the same. This air, under a pressure of 1 atmosphere, and at a temperature of 60 degrees Fahrenheit contains 0.23 pounds of oxygen, hence the required air =

$$\frac{3.54}{.23} = 15.39, \text{ in pounds.}$$

BRIDGE-CONSTRUCTED SOLID TIRES.

Editor THE AUTOMOBILE:

[1.772.]—Please give opinion of "bridge constructed" solid tires. Also state, if possible, actual and comparative values, power loss in 36 by 4 airless and ordinary pneumatic, when new and after 5,000 miles, if each is supporting 1,000 pounds. Will not the blocks of rubber crush in time and thus cause the tire to ride harder and harder and consume more and more power?

SUBSCRIBER.

Lafayette, Ind.

The data asked for cannot be given, as we have never heard of any tests of this nature having been made. When you come to think of it, this is rather surprising, too. Why don't you make these tests yourself, and thus answer your own questions? The most that we can say in this connection is that the records of both solid and pneumatic tires as made in actual service speak for themselves. The rubber blocks should not crush, if the maker's specified loads are not exceeded, that is, if you do not load the tire beyond the weight for which it was designed.

WEIGHT VERY UNDESIRABLE IN AUTOMOBILES.

Editor THE AUTOMOBILE:

[1.773.]—Since in marine motor boat work the noise of the exhaust is silenced by copious applications of water in the exhaust manifold, back of the motor, with a considerable length of pipe between the point at which the water enters and the muffler, would not water be good to use in automobiles for the same purpose?

Boston, Mass.

If account be taken of the weight of water used in cooling systems, in automobiles, and considering the objections raised,

despite the presence of only about 50 pounds of water in the average cooling system, it will be quite evident that a water silencer or muffler, which would weigh a considerable amount, cannot be recommended despite the fact that silent performance would be a feature. In marine mufflers the amount of water used is vastly more than would find a place in an automobile as they are constructed at the present time. Water weighs 8.33 pounds per gallon, and 42 gallons, a barrel full, would not last long enough to give satisfaction.

LEVER ADVANTAGE AND GEAR RATIO ENTWINED.

Editor THE AUTOMOBILE:

[1,774.]—All other factors remaining the same, what is the difference in percentage involving a car geared 3 to 1, or $3\frac{1}{2}$ to 1, taking into account (a) power and (b) speed?

What are the names and distinguishing features of the several quick detachable rims, as distinguished from clinchers?

What is the difference between high and low tension magnetos in reference to (a) use of coils, (b) use of timer or distributor, (c) intensity of spark, (d) use of one set of spark-plugs in connection with battery, coil and timer system?

Walden, N. Y.

SUBSCRIBER.

Considering the gear ratio, it is proper to say (a) the power of the motor is independent of the gear ratio, but if the gear ratio is not suited to the needs the motor will not be in a position to deliver maximum power; (b) if the best power speed of a motor is, say, 900 revolutions per minute and the gear ratio is 3 to 1, the road wheels will have to run at 300 revolutions per minute. But if the motor has not the power requisite for the task, the speed of the motor will fall off and the scheme will be thwarted. In this case it will be proper to consider a gear ratio such as will afford the desired harmony, and perhaps 3.1-2 to 1 would be suitable. In such an event the motor at 900 revolutions per minute would drive the road wheels at 257 revolutions per minute, in round numbers. In this case it is difficult to see how any question of percentage relation can be of the least value, since it is mainly a matter of fixing upon the one right gear ratio.

The names of makers of the several rims will be found in THE AUTOMOBILE TRADE DIRECTORY; names of makers cannot be quoted in these columns.

The differences in magnetos were well discussed in THE AUTOMOBILE of Feb. 25 by J. A. Williams. (See Page 245.)

GEAR RATIO FOR A SPEED CAR.

Editor THE AUTOMOBILE:

[1,775.]—Please state what will be a good gear ratio for a speed car; taking into account a three-speed selective transmission.

Trenton, N. J.

GO IT SOME.

In speed cars it is the practice to consider that the gear-set should afford three speeds ahead as follows: (a) accelerating, (b) hill climbing, (c) speeding, and (d) reverse. The following is an example of what proved to be good practice in this zone of automobile activity:

MOTOR AT 1,000 REVOLUTIONS PER MINUTE.

- Accelerating, 23 miles per hour of the car;
- Hill-climbing, 69 miles per hour of the car;
- Speeding, 93 miles per hour of the car;
- Reverse, 13 miles per hour of the car.

The above is a case from actual practice considering a car with a motor of sufficient power to make the speeds as given.

A LITTLE SMOKE IS QUITE A GOOD SIGN.

Editor THE AUTOMOBILE:

[1,776.]—My car has a good oiling system and I get excellent service from it, excepting that I borrow trouble about the oiling question. An expert told me to oil until smoke shows up at the exhaust. I have been told also that the excess lubrication which is indicated by smoke will result in a carbon deposit on the combustion chamber walls. What would you advise me to do?

Columbus, O.

T. B. DELMAS.

The two horns of the dilemma are there. When the car first starts out in the morning there is no question but that a little

smoke will prove beneficial indirectly, proving that lubrication is proceeding. Always be sure that all the bearings will be oiled; profuse oiling is superior to chance work. Do not allow the motor to smoke all the time, or, as you say, excess lubricating oil will result in carbon deposit.

WATER CIRCULATION DEFECTIVE.

Editor THE AUTOMOBILE:

[1,777.]—I have a double-opposed motor, and during the first season it ran quite well. It has a tubular radiator and a gear pump, also a coil and battery sparking equipment, which details I deem it expedient to mention, in connection with the fact that when I run the car for a while and then attempt to shut the motor down by cutting off the spark it (the motor) continues to run. Please tell me why.

Chicago.

READER.

Pre-ignition in this case is due to the presence in the cylinders of some deposit, and that the jacket walls are incrustated to some extent is probably true. In the meantime the gear pump is probably in a leaky condition and the amount of cooling water is less than was formerly circulated.

USE BEESWAX ON THE CLINCHER RIMS.

Editor THE AUTOMOBILE:

[1,778.]—The rims of my old car do not keep free from rust, even though I do clean them off and apply black enamel. What can you do to help me out?

Erie, Pa.

H. D. L.

Clean the rims off as well as possible and get rid of all the rust which will come off by scraping through the liberal use of sandpaper. Then apply a coat of bees-wax. It will have to be heated by a blow-torch or otherwise. The bees-wax will prevent the further formation of rust, because it combines with iron-rust, and the compound clings to the surface of the metal so that the air is thereafter excluded from the surface. Bees-wax will not damage the tires.

WANTS TO BE ABLE TO TURN IN NARROW STREET.

Editor THE AUTOMOBILE:

[1,779.]—I have in mind the designing of a town car, and there are points which I do not well understand, as, for example, the question of the length of the wheelbase as related to the radius of turning. Will you please state in an early issue of THE AUTOMOBILE the wheelbase length which will enable a car to turn around in a narrow street, say, with a clear space between curbs of 36 feet?

New York City.

R. J. W.

If the front road wheels can be "canted" 36 degrees to each side of the center the car may have a wheelbase of 102 inches—to be a little precise—but with 100 inches wheelbase there will be a little spare room, which will be an advantage.

BATTERY IS RUN DOWN COMPLETELY.

Editor THE AUTOMOBILE:

[1,780.]—My car (a one-lunger) runs for a few hundred yards and then the cylinder misses, until finally the motor stops. The spark at the gap is there when I shut down for a time. What can you make of it?

Charleston, S. C.

G. L. SANDERS.

The battery is run down, and if you use dry cells the chances are that what you need is a new set. In case you use a storage battery it will have to be recharged if it is in good order; in case it is not in good order it should be put in the hands of a repairman of competence with a view to rebuilding it.

FRANKLIN CYLINDER SIZE WRONGLY QUOTED.

Editor THE AUTOMOBILE:

[1,781.]—In your issue of February 4 (Letter No. 1,730, "Discrepancy in Horsepower Ratings"), a subscriber to your paper lists the Franklin engine as follows: 4-inch bore, $4\frac{1}{2}$ -inch stroke, 18 horsepower. Your subscriber is in error in this by reason of the fact that the bore for our 18-horsepower engine is $3\frac{3}{4}$ -inch, stroke 4-inch.

We call this to your attention owing to the fact that your subscriber's arguments are based especially on the size of the cylinders in our engine. As he is evidently laboring under a misapprehension, he had better be straightened out in the matter.

Syracuse, N. Y.

H. H. FRANKLIN MFG. CO.



A New York State Road near Albany

ROADS BUILDING NOW COMMANDS NATIONAL ATTENTION

BEAUMONT, TEXAS, has a population of 30,000, and, according to Albert Phenix, a special correspondent of the *Manufacturers' Record*, it owes its prosperity to the attention it has paid to the development of its roadways. There is a movement on foot to secure a good road from New Orleans to San Antonio, a straightaway distance of some 1,200 miles. John W. Gates, who, at his Port Arthur home, is devoting much of his energies, his time and his money to the development of this section of Texas, is an enthusiastic helper in this work. Much preliminary work has been done already, and it is reported that the active co-operation of all the county and parish authorities in Texas and Louisiana is almost instantly secured when once the advantages of good roads are presented to them. The counties and parishes that are not in the movement readily realize the disadvantage they would be under if they refrained from joining in a movement their neighbors have undertaken, and so it is largely a matter merely of passing the word along and securing thus the co-operation of county after county in the work.

The Beaumont and Jefferson County Good-Roads Association has been extremely helpful as well, in getting the work of good-road development followed out along economical and scientific lines. The engineer of the association gets up plans for the new roads on scientific plans, providing for drainage and all other requirements, and in this manner it has been possible to secure the maximum amount of benefit for the minimum of cost. The statement is made, that in the construction of the roads in this

county, since the first costly experiments, over \$600,000 has been spent. Incidental to this development of good roads, there has been a remarkable increase in the number of automobiles in use in Beaumont. Statistics are to the effect that not less than 150 machines are owned here now, with a number of new ones ordered and on the way.

Beaumont has steadily grown and has become a substantial, well-built and very prosperous city. The values of real estate have held their own at all times, with a gradual and maintained advance. There has been a development of farm property as well, with a material enhancement in values, particularly along the improved roadways. The multiform advantages of the good roads of this place are so evident and so universally recognized that every citizen and taxpayer is an enthusiastic advocate of the proposition, and the Beaumont and Jefferson County idea is finding favor everywhere around.

So a good road from New Orleans to San Antonio is not so far from actual realization. New Orleans people have already inaugurated a good-roads movement that has borne fruit in at least one stretch of good road to the East. Atlanta is active in behalf of a Washington to Atlanta highway, and with the increasing number of Winter tourists who visit the coast country between Mobile and New Orleans, it can scarcely be very long before all the gaps are filled and a fine highway provided between San Antonio and the national capital—in fact, between the Far South and all the North Atlantic seaboard.

JACKSONVILLE-FERNANDINA ROAD PROPOSED.

FERNANDINA, FLA., March 1.—Backed by a strong favorable public sentiment, the proposal of the Jacksonville Automobile Club and the local Board of Trade to have a road built from this city to the metropolis of Florida, is taking tangible form, and it is probable that, within a very short time, actual work upon it will be begun. The movement is of prime importance to the people of this city, as well as to automobilists of Jacksonville and those who annually tour in this State.

The plans call for a hard highway down the center of Amelia Island, upon which this city is located, the building of an inexpensive draw-bridge, with its necessary piling approaches, and connections with existing good roads in Duval County leading to Jacksonville. The cost has been found to be very slight in proportion to the need for it, and through the combined effort of all those who are interested the proposition will be pushed. There has been nothing but favorable comment upon the project, inasmuch as it will not only open a fine route to this city for automobilists, but it will also give a road for truck farmers to take their goods to Jacksonville, as well as to bring them here, opening up for cultivation a great deal of now inaccessible country. With its natural seaport facilities, automobiles from the north can be unloaded here and much time saved in shipment.

IMPORTANT SOUTHERN BRIDGE COMPLETED.

SAVANNAH, GA., March 1.—With the completion of the King's Ferry bridge over the Ogeechee River, about 15 miles from this city, one of the most important links in the route from this city to Jacksonville has been opened to travel, and it will be but a comparatively short time before autoists can make the run between these two cities in ease. On Washington's Birthday the bridge was opened to travel with appropriate ceremonies, and in the evening a dinner was held in honor of the occasion, at which a number of prominent men spoke, among them being ex-Governor Robert B. Glenn of North Carolina, ex-Governor Albinus Nance of Nebraska and F. C. Battey, president of the Savannah Automobile Club.

The Jacksonville Automobile Club combined with the local organization in the festivities. The bridge itself was built by the county commissioners, through the work of the convicts who did such good work in laying out the course for the Grand Prize race. They were used also in building the roads to the bridge, and Bryan County, on the other side of the river, will use convicts in extending the route southward to the Florida line. Already this is a popular touring route and will become more so, for the roads run through some of the most distinctive and beautiful scenery in the south and the surface is fine.

BOOSTING TRANS-PENNSYLVANIA ROAD.

PHILADELPHIA, March 1.—Last Saturday saw the Philadelphia-Pittsburg highway given a good boost when upward of one-hundred delegates of good roads associations met in the Capitol at Harrisburg and formed a permanent organization under the title of "Forbes State Road Association," with Senator W. C. Muller, of Bedford, as president, and J. A. Strite, of Chambersburg, secretary. No special route was advocated, it being the sense of the meeting that all hands should pull together for the road, leaving the selection of a route to be determined later by a commission. The name "Forbes" was adopted in honor of the general of that name who built the first military road across Pennsylvania between the two cities. In view of Governor Stuart's efforts in helping along the project a resolution recommending that the new road be called the "Stuart State Highway" was unanimously adopted.

"Farmer" Creasy, who is not at all enthusiastic over the Philadelphia-Pittsburg road, at last Tuesday night's session of the Legislature, introduced a resolution demanding an investigation of the entire highway department for having allowed contractors to collect \$345,147.55 as "extras" over and above their contract prices for building 352.2 miles of roads during 1907. If this resolution is favorably acted upon by the Legislature, it will in all likelihood postpone all good roads legislation for many weeks, if not head it off entirely for the present session.

NEW JERSEY'S OCEAN BOULEVARD.

TRENTON, N. J., March 1.—The Senate Committee on Agriculture to-day gave a hearing upon the scheme to build an ocean boulevard, extending from Atlantic Highlands to Cape May, connecting the same with the county seats of the various counties of the State by State roads. It carries no State appropriation and, it is believed, will be favorably reported. The bill was supported by a great many influential men, who explained that the counties would be expected to bear two-thirds of the expense and the State one-third at a later time. The plan was opposed by a number of men from interior counties who claimed that their constituents would receive no benefit from it, would have their taxes increased accordingly, and that the road would be for a certain class rather than for the whole State.

GOOD ROADS MOVEMENT IN MAINE.

PORTLAND, ME., March 1.—The prospect of a State highway from Kittery, at the southern point of this State to Bangor, a dream of autoists and others for some time, will probably become more realistic in the near future, if the work now progressing upon roads in this State continues, and there is every likelihood that it will. The good roads movement has taken a firm hold in all parts of the commonwealth and tourists who come here this summer will readily see the improvement. Roads are being built in all sections in line with a plan to have the various towns construct roads that will join in continuous lines when completed.

INDIANAPOLIS SPEEDWAY PLANS CHANGED.

INDIANAPOLIS, IND., March 1.—An important change has just been made in the plans for the track of the Indianapolis Motor Speedway in the decision to make the outer track two and one-half miles long and the inside loop track the same length, the original plans calling for an outer track of two miles while the inner track was to be three miles. It is believed that with the change to be made, greater speed can be attained. Several events of importance have already been scheduled for the track. Probably the first will be the run by a National stripped stock car of 1,000 miles a day for ten days.

Another event scheduled is the annual meet of the Federation of American Motorcyclists, to be held here some time in June. The stakes for the track have all been set and the actual work of making it will begin within a few days.

NEW ENGLAND 1909 BLUE BOOK OUT.

First of the 1909 series of "Official Automobile Blue Books," issued by the Class Journal Company, is out this week, the volume covering broadly the New England States, with portions of the Hudson Valley and extension routes into the Canadian provinces, and to the principal cities.

The 1909 edition consists of 792 pages of closely compiled matter, of which a large proportion has been written and mapped new during the past year. This is especially true of Vermont, the principal routes of which were covered almost entirely by the "Blue Book" car, very recently.

Among the new routes included in this volume are Burlington to Montreal and reverse of same, Montreal to Burlington. These routes have been the subject of a great deal of inquiry from tourists for several years, and now for the first time specific running directions and odometer measurements are available in their entirety, formerly given approximately.

A valuable feature has been added to the new edition in the form of general maps covering the entire territory, showing the relation of one route to another and the territory at large, including all important cities and most towns. To facilitate reference the general maps have been keyed by letters and figures. Each town or city in the "Index of Places" is supplied with a letter and a figure, the use of which will save time and trouble in locating the points desired.

Copies of the New England book will be on sale at the Boston show during the coming week, and orders for same can be filled by the hotels and garages through New England and the Hudson Valley, as well as by leading booksellers; or they can be ordered direct from the publishers, the Class Journal Company, 231 West Thirty-ninth street, New York. Other volumes, covering other districts, brought to date, are now at press.



A Friend In Need!

Tramp (to clerical motorist whose spanner has just slipped, at the expense of a barked knuckle): Beg pardn, gov'ner, but can I say anything for yer?—From "The Car."

WHAT THE LAW-MAKERS ARE FRAMING THESE DAYS

HORSEPOWER RATES IN VERMONT.

MONTPELIER, VT., March 1.—"In a spirit of malicious glee," according to the opponents of the measure, the Legislature of this State recently passed a series of new motor vehicle laws, embodying a number of features seen in the present trend of legislation in a number of States, a license fee based upon the horsepower rating, reciprocity with States showing the same courtesy to Vermont autoists, and a maximum speed limit of twenty-five miles per hour.

Three statutes were used in amending the previous law, now covering nearly all points, though it was opposed by a majority of the automobile users, and put through largely by opponents of auto touring. The fee is now one dollar for every horsepower of the machine, with a provision placing a bonus on the keeping of the same car from year to year, the second year the fee being reduced one quarter and the third and each succeeding year by one-half of the first sum. This applies, in the enforcement of the new act, to all cars licensed in 1907 or 1908 and to autoists from other States, who may register this year, a car which has been registered previously in other States.

The new law exempts the car from any other tax, allows one registered after August 1 a discount of 50 per cent., and if sold provides that the registry may be passed along to the new owner for a consideration of one dollar. The reciprocity section allows autoists from States which grant a similar privilege to those of Vermont in touring, to tour in this State for not more than ten days without registering. For a presence in the State of from ten to sixty days there will be a charge of \$3 for cars of 20 horsepower or less, \$6 for those between 20 and 40 horsepower, and \$10 for cars of over 40-horsepower. For a period of more than 60 days the car would be amenable to the State law.

In considering speed the statute says: "No automobile or motor vehicle shall be operated on the public highway in a careless or negligent manner," recognizing 25 miles per hour in the open country as the dividing line between careful and careless running, ten miles per hour in cities or incorporated villages, and permitting towns to regulate the machines in their own limits.

SEVERAL MEASURES PENDING IN DELAWARE.

WILMINGTON, DEL., March 1.—Automobilists all over the State are keeping their eyes on Dover until after the present session of the Legislature, as notices have been given of a number of new bills proposed to regulate the use of motor vehicles. It is hardly likely that all of these bills will come in, but some of them are looked for and will probably be acted upon.

The proposed measures come from different sources and have different objects. One, prompted by some of the car owners of the State, seeks a reduction in the license fee; another, which was sent down by farmers of Brandywine Hundred, wants a tax imposed for the use of tires with chains, on the ground that the chains damage the roads, while the farmers also seek to reduce the speed. Another bill is to remodel the automobile regulations.

The Delaware Automobile Association has decided to fight the bill which passed the House of Representatives a few days ago, taxing automobiles as personal property. This decision was held at the last meeting of the association, when several other subjects were also considered. The association is also interested in a proposition to have another ferry between Wilmington and Penn's Grove, N. J., for carrying automobiles.

ONE DOLLAR PER HORSEPOWER TAX.

MINNEAPOLIS, MINN., March 1.—After weeks of hard work and anxiety, the leading motor enthusiasts of this State are now feeling easier about the new automobile bill which finally has the unqualified endorsement of all of the nineteen clubs affiliated with the State organization. The bill provides for a tax of \$1 per horsepower in lieu of all personal taxes on the machines, and, besides several other desirable features, it directs that all funds accruing from this taxation shall be used by the State Highway Commission in the good roads work of the entire State. This will annually add between \$150,000 and \$200,000 to the good roads funds now available.

The bill was introduced in both Senate and House and was referred to the committee on legislation. At this point two clubs which, it developed later, had given the matter hasty consideration, communicated with the Senate committee speaking against the bill. The result was that the committee postponed action indefinitely until the bodies of the State association were unanimous in supporting the measure. By quick and effective influence the objections of these two clubs were removed and there is now every chance in the world that the matter will be reported favorably out of the committee and action secured soon.

REAL RECIPROCIITY WANTED IN JERSEY.

NEWARK, N. J., March 1.—Real reciprocity, the kind which permits an autoist of any State granting a similar privilege to those of this State, to tour in New Jersey without first taking out a license, is what is now wanted according to the direction the opinion in this city has taken. The new automobile bill, which would alleviate to a great extent the obnoxious statute now upon the books, has had its second reading in the State Assembly, introduced by Austen Colgate, of East Orange, and it is considered as likely that it will pass the Senate when it reaches that body, and soon replace the present law.

This bill, however, would require non-resident autoists to pay \$1 for a license which would allow them to tour in this State temporarily and this does not meet with favor here. If the uniform law is adopted in New York and Pennsylvania the shoe would be on another foot, for then Jersey automobilists would be required to take out licenses in those States unless the present bill pending is so changed as to give to all non-resident members free rights here. Real reciprocity is what is wanted, whether it is given at once in return or not.

NO SPEED LIMIT IN WISCONSIN.

MILWAUKEE, WIS., March 1.—If the Wisconsin Legislature acts favorably upon a new law which has been introduced by Senator E. E. Page, of Milwaukee, automobilists of this State will have a law which does not mention any definite speed limit, using the more logical term of reasonable speed, wiping out the present statute, and giving one devoid of regulating features. It would also take away from State control such highways as are privately owned, and would forbid the enactment by any city or local authorities of conflicting regulations, thus making the law uniform throughout the State.

Still another bill has been introduced which is aimed at "joy-riding," making it a misdemeanor, punishable by fine of not more than \$100 or thirty days in jail, for any person to drive an automobile unless the owner is riding in it or has given consent to its use. It is hoped that this will end a nuisance.

What the Clubs are Doing These Days

HARRISBURG CLUB WRITES MR. HOWER.

HARRISBURG, PA., March 1.—Inasmuch as many sundry reports have come to the capital of the Keystone State, and to its Motor Club, of the effect upon automobile contests, of the appointment of Frank B. Hower, of Buffalo, as chairman of the Contest Board of the American Automobile Association, although no official notification of this has been received, the Motor Club has decided to proceed unmolested to perfect the arrangements for its third annual endurance run.

The dates have been fixed—May 3 to 6, inclusive—and a route decided upon which will give those who enter not only a good run for the trophy, but also a beautiful and pleasant tour over all conditions of roads. Covering about 175 miles each day, a total of 700 will be reached, making the event one of the most important ever held in this section of the country. Leaving this city upon the day of the start, the cars will run via Gettysburg, Hagerstown, Harpers Ferry and Frederick to Washington, D. C. On the second day they will return to this city via Baltimore, Westminster, York, and Lancaster. The route for the third day will be to Scranton, following the Susquehanna River and passing through a number of towns, including Wilkes-Barre. The final run will be another return to Harrisburg, first crossing the Pocono Mountains and down through Stroudsburg, Delaware Water Gap, Easton, Allentown and Reading.

There has never been scheduled a better route in the East than this one, and active preparations for the contest have been started. The list of technical penalties will be made by David Beecroft, editor of *Motor Age*, chairman of the technical committee.

At the last meeting to consider the matter a thorough discussion took place regarding the attitude of the club toward the chairman of the Contest Board of the A. A. A. A motion to hold a contest without any reference to Mr. Hower's committee was laid on the table, as was a motion to apply for a sanction to the Automobile Club of America. Finally the following letter to Mr. Hower was agreed upon:

Dear Sir:—It has been stated in the newspapers, although we have received no official notification to that effect, that your committee wishes to extend its authority and sanctioning power over all local reliability contests. The statement has also been published that you are planning to draw up, or have drawn up, a set of rules for the use of local committees.

If we had your rules before us, we would be very glad to consider them carefully and adopt from them such suggestions as might be thought applicable. Not having had any communication from you, we are compelled to rely upon our own resources, as in previous years.

We therefore beg to inform you that we have printed our entry blanks, decided definitely upon our rules, route, etc., and selected as our officials the same gentlemen who have acted in our previous contests. In conclusion we would say that, on receipt of the proper official notification, we are quite willing to pay to your committee the sum of twenty-five dollars, the sanction fee as quoted in the newspapers.

Yours respectfully,
CONTEST COMMITTEE,
 Motor Club of Harrisburg.

MONTREAL CLUB'S INTEREST IN ROADMAKING.

MONTREAL, Feb. 22.—Twenty-two miles of practically dustless roads will skirt Lake St. Louis this summer, if the Automobile Club's plans, in which the mayors of the lakeside municipalities are interested, can be carried through. In recent years from Lachine to Ste. Anne's a dust cloud hangs over the region every day, during the season of touring. A meeting has been held, however, between the directors of the Automobile Club of Canada and the mayors of these places, to discuss the advisability of using oil to abate the dust nuisance.

A NEW YORK STATE CLUB'S TOUR.

BINGHAMTON, N. Y., March 1.—In the absence from the East this year of the annual tour of the American Automobile Association for the Glidden trophy, a number of proposed runs have been announced, and of these one that has met with particular favor, since the route and conditions have been made known, is the fourth annual tour of the Binghamton Automobile Club. Six days of touring through some of the most picturesque scenery in this part of the country, with noon controls for luncheon, and rules that will give the competitors a thorough test, and at the same time, a highly pleasant week, is a part of the comprehensive plan outlined.

Night controls at Albany, Boston, Hartford and Newburgh are proposed, with a full day layover in the Hub, and the stops for luncheon will be at Worcester, N. Y.; Springfield, Providence, Tarrytown and Delhi. This route, 761 miles in length, as now figured, but which may be changed in the trip of the pathfinding party, will give those who enter roads of the finest kind in the country. Macadam highways will be covered for nearly the entire distance, the only lapses being a few miles on the first day, a few on the second and a few on the last.

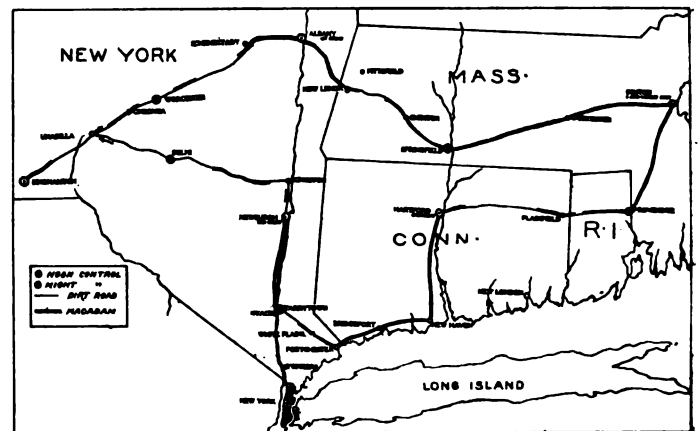

Route of Tour of the Binghamton Automobile Club.

Although the entry blanks have not been sent out and no real endeavor has been made to ascertain the number of cars which may be entered, twenty-eight owners have already signified their intentions of being in the caravan. A valuable trophy is the prize, presented to the club by George F. Johnson, and it will be permanently won by the owner of the car making the best reliability record. There will be two classes, divided at \$2,500, class A cars being those sold below that price and class B those sold above it. The rules will call for a definite running schedule, in which the class A cars will be given an additional allowance of from 20 to 30 minutes. In the mornings these machines will be started that much earlier than the larger ones, so that all will reach the noon stop at about the same time, and in the afternoon all will be started together, giving the smaller contestants the additional time in which to reach the finish.

As in other tours through the section of the country to be traversed, one great feature will be the beauty of the scenery and the general interest in the historical points passed. The pathfinding party will make special efforts to collect all interesting data and will include this in the route book, so that the latter will be one for reference at all times. Starting on a Monday morning, June 21, the Susquehanna and Mohawk valleys will be crossed, through Schenectady, into Albany, and at 8-

o'clock on Tuesday morning the run across to Boston will be begun, going through the Berkshire Hills, Springfield and Worcester, past the Wayside Inn and many other interesting places. A full day in Boston will be given over to sightseeing.

On Thursday there will be a short run of 45 miles to Providence, a two-hour stop for luncheon and sightseeing, and then a run of 85 miles to Hartford. On Friday the party will lunch at Tarrytown, after a ride through Harriman's estate over his own private automobile road. From Tarrytown to Newburgh will complete that day, and the home stretch will be taken on Saturday, with a noon stop at Delhi. A great deal of interest in this last run will be found in going through the Ashokan Valley, where every village is soon to be destroyed, the timber cleared, every farmhouse, fence, tree, barn and bridge is to be removed, until there is not a thing in sight from hillcrest to hillcrest, and a dam 220 feet high will be built across the valley, forming a great reservoir, 12 miles across at its greatest width, to supply New York City with water.

Although there is still considerable time to elapse before the contest will begin, the full plans will be worked out well ahead. Every member of the Binghamton club, resident or non-resident, will be eligible to enter a car.

MANITOBA'S MOTOR LEAGUE IS PROSPEROUS.

WINNIPEG, MAN., March 1.—The annual general meeting of the Manitoba Motor League, held recently, was largely attended by autoists from all over the province, and the work of organizing for the coming season was carried out with the greatest enthusiasm. The league was first formed in January, 1907, being called into existence by the introduction of a bill into the legislature to control the use of automobiles in the province. From the very commencement the league has met with success, it having secured the passing of the new law in such a way that it has been found to work in a manner entirely satisfactory both to the automobilist and the legislature. The following officers were elected for the ensuing season: Honorary president, Judge Phippen; president, W. Elliott Brandon; first vice-president, D. B. Sprague; second vice-president, Joseph Maw; third vice-president, Major Young; Secretary, W. C. Power; treasurer, P. C. Hagarty, Souris. Consuls were appointed as follows: Portage la Prairie, Harry Stevens; Carberry, Claude Isbister; Neepawa, John Crawford; Gladstone, A. J. Williams; Manitou, Mayor Elliott; Brandon, McClements; Boissevain, W. Elliott; Carman, Dr. Pirt; Plum Coulee, J. Bargoh; Cartwright, John Mooney; Carnegie, James Pearson; Virden, H. Goulter. Executive committee at league headquarters, Winnipeg, E. C. Ryan, H. A. Aylwin, Sam Henderson, and L. R. Barrett.

Arrangements were made with the legislature whereby the league will be allowed to affix its direction signs onto the telephone poles, thereby saving expense in the erection of these signs. Arrangements were also made for a good-roads committee to take up with local members of the legislature the improvements of roads throughout the province.

QUAKER CITY APPOINTMENTS ANNOUNCED.

PHILADELPHIA, March 1.—President L. D. Berger, of the Quaker City Motor Club, made the following announcement of committee appointments at the meeting of the Board of Governors last week: Law and Ordinance—G. Douglass Bartlett, C. Edgar Shreve. Good Roads—R. E. Ross, Frank Hardart, William T. Taylor. Routes and Tours—Edwin H. Lewis, Richard Sellers, A. E. Maltby, A. C. Buzby. House—Frank Hardart, A. T. James, Fred C. Dunlap, N. E. Petty, George G. Meade. Membership—A. T. James, A. T. Stewart. Auditing—Fred C. Dunlap, W. C. Jackson, Dr. W. J. Donnelly. Charles J. Swain was appointed chairman of the Technical Committee and Dr. W. J. Donnelly of the Press Committee, the remainder of these committees to be announced hereafter. Dr. J. R. Overpeck was reappointed as "club pathfinder" and G. Hilton Gautert official starter. A number of plans for spring activities are being discussed.

ACROSS THE CONTINENT IN THIRTEEN DAYS.

LOS ANGELES, CAL., March 1.—The first anniversary of the New York-to-Paris race, coupled with the announcement of the transcontinental race from New York to Seattle, to take place the coming Summer, has aroused intense interest in the coast-to-coast trips, which have been and are about to be made. Speaking of those that have been, how many people know that the continent has been crossed no less than eighteen times? This is a fact, nevertheless, the cars and the number of trips to their credit being as follows: Oldsmobile, four; Franklin, Packard and Reo, two each; Winton, Glide, Buick, Zust, DeDion, Maxwell, Brush and Thomas, one each.

The last-named, it is now announced, is about to have another try at it. The Thomas representative in Los Angeles, Rene A. Brassy, has announced his intention of leaving the southern California metropolis on May 15 at midnight with New York City as his destination and the overthrow of Whitman's long-standing record as his ultimate aim. This record, made in 1906, is 15 days, 2 hours, 10 minutes, and was made over what is known as the short route. Although traveling a longer distance, Brassy is confident of doing the trick in 13 days. The car used will be a six-cylinder, 70-horsepower Thomas with a flyabout body, which will carry four passengers. The route followed will be the old Santa Fé track through the Mojave desert and Death Valley, thence back over the route of the New York-to-Paris race. A relay of drivers will be used, following Whitman's scheme, the car being driven night and day.

Incidentally the Chicago-New York course may have new figures hung up, as it is well known that W. W. Shaw, who will join the party at the Windy City, has been casting longing eyes at the latter for a long time. In setting 13 days as his goal, Brassy has undertaken a very ambitious "stunt," for this is a cut of two days and two hours from the existing marks or 18 per cent. The whole programme calls for an average of over 250 miles a day. While this and better is possible in the East, it hardly seems probable in the Far West, even in May.

HOW A. A. A. WILL SANCTION EVENTS

That the control of automobile contests in this country, including track races, other than those which are international, will in the future be vested in the Contest Board of the A. A. A. has been decided through the ratification by the Executive Committee of the terms of the agreement between that body and the Manufacturers' Contest Association, composed of American manufacturers and importers. To insure greater harmony of rules throughout the country and to see that the contests are run upon fair conditions, with responsible parties in charge and standing for the prizes, the Contest Board will hereafter work with an advisory committee from the makers.

The Contest Board is now composed of Frank B. Hower, chairman; A. L. McMurtry and Frank G. Webb, with Alfred Reeves, A. M. C. M. A.; E. P. Chalfant, A. L. A. M., and E. R. Hollander, I. A. S., as the advisory committee. All national events will be under the supervision of these autoists and they will endeavor to conduct the races and tours with less of the petty trouble heretofore noticeable.

A definite schedule of sanction fees has been made as follows: Road race, where a stand is erected, \$300; track meeting, \$100; track meeting, including 24-hour race, \$250; hill climb, \$50; endurance contest, \$50, and road or beach speed trials, \$100. All clubs affiliated with the A. A. A. will be entitled to a reduction of 50 per cent. of these rates.

At a meeting of the Executive Committee of the A. A. A., held February 23, it was reported that there has been good progress in the preparation for the Cobe stock car race to be held near Chicago; that there are several cities which would like to have the second annual good roads and legislative convention next Summer, and that the decision of the Contest Board relative to its jurisdiction over the Quaker City Motor Club endurance run was sustained.



is the best medium for this rapid transition from one environment to another. The need of the out-of-doors is an absolute necessity to every one at all times. Of course, one can always walk and walking costs nothing, but, unfortunately, the things that cost nothing are not always those that appeal most to us, and so, for those who can afford it, the motor car is the ideal mode of locomotion. Physicians insist that a certain amount of the open air is absolutely requisite, and if one can combine that air with a moving panorama that is beautiful and interesting, something that lies close to the ideal has been reached. If the owner is forced to make a pleasure of necessity, to a great extent, the auto comes into play with its twentieth century activities, affording the busy woman the maximum of exhilaration in the minimum of time, and by the very force of its rapid progress drives the fresh air into her system. Those women who have never experienced the pleasure that comes from motoring have

missed one-half of the joy of living.

If women could only realize the keen pleasure of driving their own car, the pleasure to themselves and the pleasure they can give to others, they would take up driving at once. There are a great many machines built at the present time that can be driven with perfect safety by a woman—for the woman who is rather timid, there is the little electric with its absence of cranking, sparking, changing of gears, clutches or throttle. With only steering and controlling levers and brakes, nothing could be more simple and yet give so much pleasure and comfort, and all the work of shopping, marketing and calling is made a delight. Then, too, there is the added thrill of holding the power in one's own hand, and there is nothing more soothing to a tired and nervous woman than a seat in a smoothly running car. On the other hand, there are women to whom the gasoline car particu-

In these days, when it can be truly said that the automobile has "arrived," there are probably few who stop to consider it from a hygienic standpoint. It rejuvenates tired nerves, changes the feeling of dullness to one of energy, gives a keen joy in the beauties of Nature, and the swift pace is certainly stimulating to the circulation. The woman who is afflicted with ennui will find her trouble quickly dispelled by a spin in her car, and, through the medium of fresh air and sunshine, will be physically and mentally the superior of one who dawdles away her time at home over a piece of fancy work or talking the latest gossip.

Air, light and space are said to be essential to health, and, deprived of these, the result would be physical deterioration. There is no way to obtain these three life-giving qualities as satisfactorily as by autoing. The motor-loving woman will never remain at home on account of weather, for with the many kinds of motor raiment now procurable, the weather has little effect upon the true lover of the sport. Another prime necessity of a woman's life is the alternative distraction or occupation, and there is absolutely nothing that fits so exactly every requirement as the automobile. From the hygienic standpoint it is the amusement par excellence, and, again, it furnishes a very necessary relaxation. There are many women who do not realize the great need for physical as well as mental exercise, and find themselves exhausted and incapable of further effort, when they have accomplished a certain amount. They do not realize that unless one has a healthy body it is impossible to have a healthy brain, and without this one cannot do good work of any kind.

A change of scene is also a necessity, for upon the difference in surroundings one must depend, to a great extent, for new ideas. These can readily be obtained by going abroad from the beaten track, and for the woman of affairs the automobile



Mrs. Cuneo at the Wheel of Her Knox Giant.

larly appeals; they are perfectly at home behind the wheel of a big car and are rivalling the masculine drivers. When the weather permits, a brisk spin into the country will blow the cobwebs from the brain and fit one for renewed activity. On a tiresome trip of shopping the car is called into requisition, and this combines a most disagreeable phase of woman's life with one of the enjoyments, for there are probably few women who really enjoy the round of traveling from one shop to another.

Extended Suburban Trips as a Health Producer.

Long trips can be made into the surrounding territory, an impossibility with a horse and carriage, which not only would one be confined to the city limits, but would not give much of the exhilaration that goes with speed. In a couple of hours' time forty or fifty miles of country can be seen, whereas a woman restricted to a victoria, would follow the stereotyped round of the parks and boulevards. This, after experiencing the delights of touring, seems like deadly dull employment. Autoing is the most perfect cure in the world for an over-wrought condition of the nerves; there are untold possibilities for good in it as a rest cure in this restless age. It gives a healthy appetite and is a pastime which demands sensible living. It gives a delight to life which cannot be found in elaborately decorated drawing rooms. There are many women who can prove that their health has been improved to a really wonderful extent by automobile rides more than any medicine in the world could do; cases, for example, of women who have cured themselves of serious bronchial ailments by spending the greater part of every day in little machines which they can drive themselves. It is not always necessary, but often advantageous, to not only be able to drive cars expertly, but also to take them apart and put them together again, and besides the absorbing interest of new knowledge is always a healthful diversion.

What a Prominent Surgeon Has Advised.

One of the most prominent surgeons in this country recently made the statement that women's arms were fast becoming mere anatomical vestiges, like the appendix, and advised women in general, who could find it possible to do so, to learn to drive their own cars as much as possible in order to exercise their arms freely, the handling of the steering wheel and the manipulation of the different levers giving much needed muscular action. Brachial neuralgia is seen frequently in women, especially in those of the leisure class, who have never used their arms in domestic or material work, and are almost invariably of a nervous organization. A touring trip will produce the same effect as a stay in the mountains; there is an increase in the number of red blood corpuscles and sleep becomes deeper and lasts longer.

The motto of the woman who can motor should be, motor early and motor late, but surely motor, for each and every woman who does can find pleasure, good health, youthfulness and an unequalled exhilaration with the aid of the automobile.

NEW YORK SCHOOL FOR AUTO OWNERS.

Primarily to give owners of automobiles a thorough course of instruction in the care and operation of their machines, a new school, to be called the Stewart Automobile Academy, will be opened about March 20 at 231 West Fifty-fourth street, New York City. A large building has been secured and fitted up, and both men and women will be instructed in automobile and motor boat subjects. There will also be a complete course for chauffeurs given later. The equipment includes 1908 and 1909 engines and other mechanism, with special work outlined in ignition and carburetion. Close attention will be given to road work, and modern cars with double sets of brakes will be employed. The academy will be under the direction of Mr. Stewart, a graduate of Rutgers College, who has been connected with the automobile school conducted by the West Side Y. M. C. A.



IN the days of our grandmothers, when travel was by diligence or post-chaise, the most suitable headgear was found to be a close-fitting, padded bonnet. To-day, with winter travel in the open air again in vogue—even in the open automobile, far more healthful, by the way, than the closed car—feminine fancy has turned up an old fashion and made it new again.

The advance guard of winter travel has already arrived on the French Riviera, and though blue skies and a radiant sunlight may favor something more airy and open, the bulk of those dainty Parisians who so love a new vogue, and who have journeyed down by road, have in large numbers been coiffed with these dainty and fascinating caps of our grandmothers.

The imaginative Frenchman has also caught time by the wing, or rather the aeroplane, and a progressive manufacturer of clothing for automobilists, aeroplanists, and others has launched two new creations in caps, one called "the Orville" and the other "the Wilbur," each as suitable for automobilists, presumably, as for aeroplanists, and neither differing greatly from the cap or *casquette* of convention, save with a little snugger fit here and a little looser fit there, more or less of a visor, or perhaps a longer or shorter flap.

At any rate, the "styles" have caught on, and now the young sports of Paris who have never got nearer an automobile or aeroplane than the pictures in the illustrated papers, haunt the boulevards, clean-shaven like Wilbur, or with mustachios of Orville, coiffed with the *casquette à la mode*.

It was ever thus; in the days when we went to Coney Island on an Iron Steamboat we wore a yachting cap like that of the commodore of the New York Yacht Club; and when we thought of learning to ride a bicycle we first bought a cap with a long, peaked visor like a horse jockey's; and now, with automobiles and aeroplanes ever in view, we must have a "Janetzy," or a "Foxhall," an "Orville," or a "Wilbur."

BRIMLESS HATS FOR LADY AUTOISTS.

The automobile fashions from the other side include a few novelties that will be of interest. No direct changes are expected but the coats will be worn shorter and cut upon straighter lines than heretofore, while sleeves will be smaller and closer fitting. This will really be an advantage for the close fitting garments will shed the dust better. The new head gear is more radical, consisting as it does of very small, deep crowned brimless hats. Although at first sight seeming very ugly, it is said that one soon gets used to the peculiar appearance. One of the newest innovations resembles Mercury's helmet and, adorned with a plume on each side, will doubtless become popular, being particularly suitable for motoring wear. Other novelties are slight changes in the skirts, which will be plain, and waists liberally adorned with braid and rows of satin buttons.

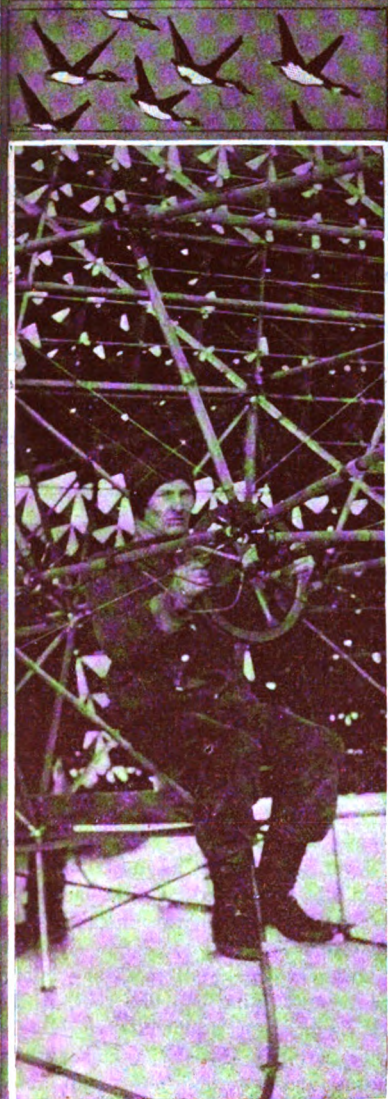
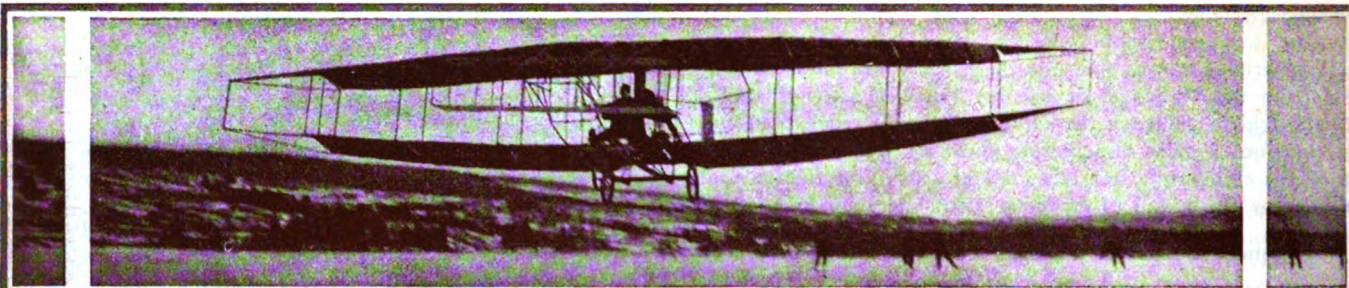

NOVA SCOTIAN AERIAL RESULTS

BADDECK, N. S., March 1.—By flying for four and a half miles over ice-covered Lake Bras d'Or, at a rate of speed of over 40 miles an hour, the aeroplane *Silver Dart*, with which Dr. Alexander Graham Bell and his associates, the members of the Aerial Experiment Association, have been conducting experiments here, has proven to contain the successful features so long sought. Equipped with an eight-cylinder, water-cooled motor of 50 horsepower, this machine last week made its successful flight, and as long as the lake stays frozen the members of the party, who are staying at Dr. Bell's summer residence, will continue their experiments with this machine and the new tetrahedral kite.

These two interesting machines, if such they may be called, are being operated entirely by J. A. D. McCurdy, who designed them, and who, with Dr. Bell, G. H. Curtiss and F. W. Baldwin, form the association. The aeroplane is the fourth motor-driven one built by them this year, and contains many improvements over its predecessors. A great deal of its success is due to its motor, which was built at Hammondsport, N. Y., by Mr. Curtiss, of eight cylinders, placed in sets of four at an angle of 90 degrees, with copper water jackets, a bore of $3\frac{3}{4}$ inches and a stroke of 4 inches.

Of equal importance is the new tetrahedral kite which Dr. Bell has built, containing 3,690 little cells and weighing 950 pounds with the operator.

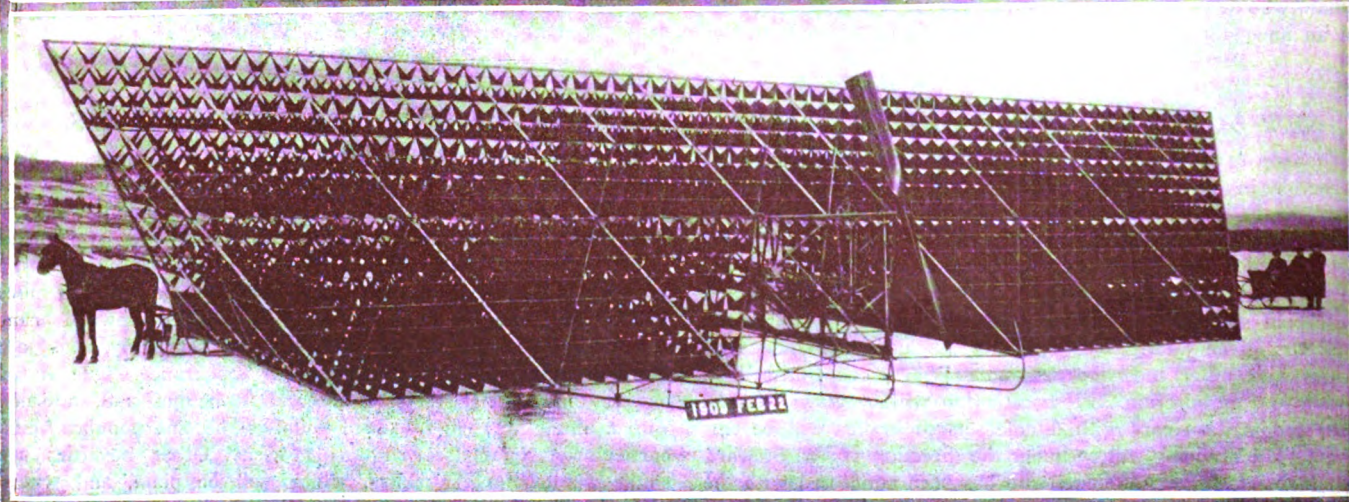

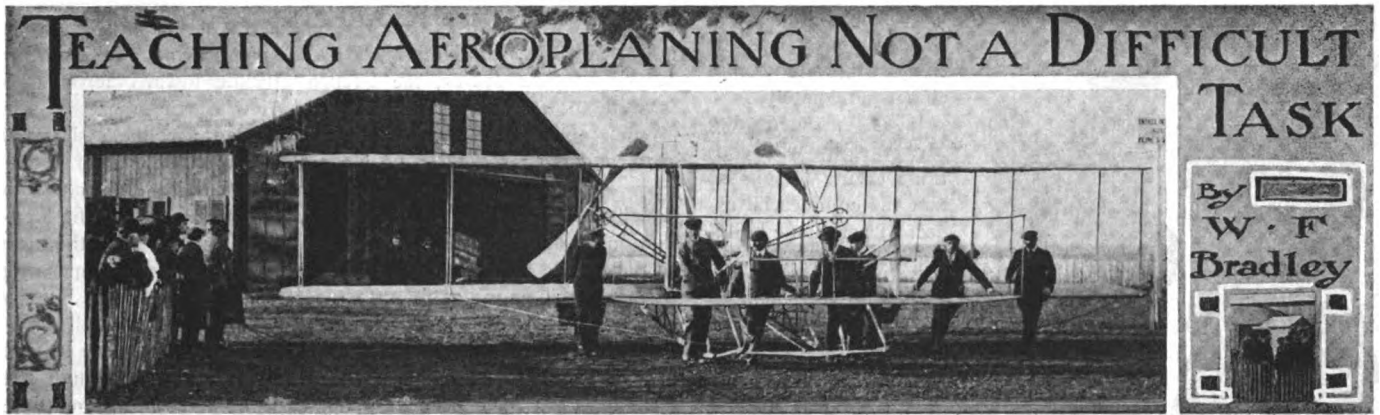

Wilbur Wright's Pupils Bringing the Aeroplane Out of Its Sheltering Place.

PARIS, FRANCE, Feb. 28.—To prove that aeroplaning is not so fraught with dangers and difficulties as is often thought, or that it is a sport or business that should be avoided by those who have great regard for their lives, is an opinion which has been disproven more than ever during the past fortnight, in the flights made under the direction of Wilbur Wright. Just to show that the science can be learned in a comparatively short time, and that it is not so very hard to master the fundamental principles, Mr. Wright has been giving lessons to two or three persons here, and one flight was made by M. Tissandier and Count Lambert, with the former in charge, while the inventor remained upon terra firma.

The propelling mechanism does not figure greatly in the teaching, for almost everyone who is seriously interested understands a gasoline motor and how to control it. In the Wright machine the engine is of standard construction, and is controlled much as is an automobile motor. The first thing to be learned, and upon which much importance is placed, is the method of keeping a balance, just the same problem which had to be mastered in learning to ride a bicycle and it has proved difficult.

Of course, the mere ability to operate the engine and to manipulate the rudders is not more than a beginning, for air

currents and many other conditions of the atmosphere have to be studied, but this is a practical start. Mr. Wright has been desirous of proving that aeroplaning is not limited to a certain few, and consequently he has taken up more persons lately than ever before. His sister was one of them, going up to a great height, but she did not do anything in the way of operating the machine. Since then she has made frequent trips.

Count Lambert, however, has become quite proficient in a short time, and M. Tissandier so much so that Mr. Wright has allowed him to make trips unaccompanied, and the one mentioned in which these two were the crew. The fact that there are others who can learn to guide the aeroplane has given a great deal of satisfaction among those interested, for it is a decided step towards making the science or sport more popular. The other day Mr. Wright started with Colonel Vives, of the Spanish aeronautical department, but in starting off the inventor did not seem to lift the rear rudder sufficiently, and it caught in the starting rail and ripped. This necessitated a stop, and the way in which Mr. Wright brought the machine to the ground within 75 or 80 yards of the end of the rail won the applause of the crowd, and of Colonel Vives. The damage consisted of a couple of broken spars and a derangement, which will be



Ready, Count Lambert, Pupil, in Charge.



Wilbur Wright, Comte and Comtesse de Lambert.



Orville Wright Shows How Wind Velocity is Read.

fixed shortly, delayed by the necessity for completing another machine immediately.

It is expected that Mr. Wright will continue giving lessons so that the commercial aspect of aeroplane building may assume more realistic proportions. Orville Wright, a few days ago, made his first flight since his accident at Fort Meyer, going up in the balloon Icarus, piloted by Marquis de Kergariou.

After an unusually successful flight of about twenty-five miles (400 kilometers), a

landing was effected near a small town, Tarbes, from where the party returned to the starting point in an automobile. As final proof of Orville Wright's complete recovery from the unfortunate accident at Fort Meyer last fall, the flight aroused more than ordinary attention.

AEROPLANING IN CHATEAULAND.

PARIS, Feb. 28.—Chateauland has now consoled itself at the loss of the automobile Grand Prix, and has set about gathering together the \$20,000 subscriptions which were returned to their donors when the road race was killed. The Municipality of Angers has voted its previous subvention of \$5,000, and believes that this example will rapidly draw in from various sources, the total sum of \$20,000. With the practical certainty of getting this amount the district has approached the Aero Club of France asking that one at least of its aeroplane races should be held in the district. The subvention, originally intended for the Automobile Club, will be handed over to the Aero Club.

As the Aero Club of France has not less than three races to organize this year, including its own Grand Prix for aeroplanes, the Gordon Bennett aeroplane race, and the French elimination for this event, there is every possibility of the Angers offer being accepted. Not only is the financial assistance satisfactory, but the district and local club will give all necessary aid in organizing, and has a vast tract of land on the banks of the Loire on which a circuit eight miles round can be traced.

The conditions of the Gordon Bennett race are that it should be held on a course between three and six miles round, and that the total distance covered should not be less than 12 miles. The course selected must be announced not later than April 1. It is safe to predict that the first competition for the James Gordon Bennett trophy and \$5,000 in cash will be held over the Chateauland course, and also that the Aero Club Grand Prix, under very similar regulations, will be run off on the same course.

It has been asked that the Aero Club of France dirigible balloon race, announced for 1909, should also be held near Angers, but in view of the difficulty in obtaining gas and in housing the airships, it is more than probable that this district will be passed by in favor of the Champagne country.

MACHINE GUNS ON GERMAN BALLOONS.

BERLIN, March 1.—Small cannon and machine guns are to be used in the future by the German military authorities in the equipment of their military balloons. Experiments have been carried out for some time, and it has been decided to use balloons of the rigid Zeppelin type, the danger resulting from the recoil and escape of gas having been overcome by a secret method. For lighter guns a semi-rigid balloon of the Parseval and Gross types will be employed.

AERONAUTICAL AFFAIRS IN GENERAL.

In "My Way of Thinking," by Henry Sturme, in a recent edition of *The Motor*, the French attitude toward aeronautics is well shown and is interesting in view of the fact that the French government intends to organize an aeroplane show in 1910, and is "resolved to be leaders in aeronautics." Mr. Sturme writes: "Without disparaging the enterprise and initiation which the French have shown in this new field of scientific locomotion, and while they do 'lead' to-day, I cannot help thinking of Count De Dion's boast to me ten years ago, when, speaking of the British as motor manufacturers, he said: 'This is a French industry. It is *ours* and we mean to have it, and you will *never* do anything in it.' When I think of this and of the early history of cycling and automobilism, I can surmise that, although the British as yet have been very apathetic in aeronautical matters, directly they assume commercial importance, British capitalists and engineers will interest themselves in these affairs and will pull back the lead which their French competitors by their more mercurial temperament and earlier efforts have secured. All honor to the French for taking the lead. Whether they will keep it, is for the future to decide. I have my doubts. But what an example is this decision of the French Government to our own! Where would you find in this country the Government, either of the country or of a municipality, spending public money and interesting itself in the pushing of any particular form of industry?"

AMERICANS TO FLY ACROSS CHANNEL.

NEW YORK CITY, March 1.—Feeling that the success attained warrants their seeking broader fields of activity, the members of the Aerial Experiment Association have arranged to send an American aeroplane to England in May, to try for one of the two prizes offered for the first successful aeroplane flight across the English Channel. It will be modeled on the plan of the successful *Silver Dart* and work upon it will commence at once at Hammondsport, N. Y. It will probably be in charge of J. A. D. McCurdy and F. W. Baldwin, two members, who have been at Baddeck, N. S., with Dr. Alexander Graham Bell conducting experiments upon the ice with the *Silver Dart* and Dr. Bell's new tetrahedral kite. The association is now prepared to build aeroplanes for practical uses and upon orders.

PREPARATIONS FOR THE NATIONAL RACE.

On June 5 the national balloon race under the auspices of the Aero Club of Indiana will start from the track of the new automobile speedway, at Indianapolis. Aeronauts in all parts of the country are taking great interest in the proposed balloon race, among them being Cortland F. Bishop, president of the Aero Club of America, with which the Indiana club is affiliated, and also A. Holland Forbes, vice-president and chairman of the contest committee of the Aero Club of America. A gold medal will be given to the winner of the race and he will also be awarded the national championship. G. H. Curtiss, who won the *Scientific American* trophy for aeroplanes last July, will make an exhibition with his aeroplane *Gold Bug*.

A 50-horsepower, six-cylinder aeroplane engine is now being built at the Kilburn works of the Simms Manufacturing Company in England, fitted with a special carbureter and a Simms magneto. It is being made by F. W. Simms for a new aeroplane being constructed by S. F. Cody and will weigh only 4 1-2 pounds per horsepower, the bore and stroke being 110 mm., and the cylinders set at an angle of 120 degrees.

There is some little surprise in German aeronautic circles at the fact that a Baldwin balloon has arrived in Berlin for the well-known aeronaut Captain Hildebrandt, as the press plainly confesses it cannot conceive why the airship was brought from the United States, which, it asserts, is not so far advanced in this branch of sport as Germany. But Captain Hildebrandt probably knows why!

OF AND BY THOSE PROMINENT IN THE INDUSTRY

C. W. Churchill, sales manager of the Winton Motor Carriage Company, in speaking of the great demand for automobile parts and the fact that a large number of the makers are unable to fill orders, said a few days ago: "We don't smile at anybody's misfortune, but we are mighty glad that we make practically all Winton Six parts in our own plant. That enables us to deliver cars according to promise. Winton Six buyers will be using their cars this Spring and Summer when some other buyers will still be wondering why they can't get delivery." At the Cleveland show one maker of small parts confessed that if the orders now on his books should stand without a single addition his plant would have to run night and day from now until September 20. Of course, that means that more than one automobile manufacturer will be unable to secure parts that he expects to use in his 1909 cars.

A Noted Foreigner Is with Us.—American automobile factories, during the past couple of weeks, have been visited by one of the most noted foreigners connected with the automobile trade, Frederick R. Simms, of Simms-Bosch magneto fame, who is making a thorough round of the industry in this country. Mr. Simms has not only attained American fame through the use of his magneto, but also through the knowledge here of his prominence in English and continental automobile affairs. He is the founder of the Royal Automobile Club and also of the Society of Motor Manufacturers, and was the first vice-chairman of the former and president of the latter for two years. Professionally, he is best known in connection with ignition subjects, although he is really as much interested in automobile manufacture itself. He has figured prominently as a consulting engineer and designer, and has introduced the use of the gas engine into many spheres aside from that of automobiles. At present he is working upon its development for use in aeronautics. It was he who introduced the Daimler engine into England, after first seeing the German production in 1888 at Bremen, and he became a director of the famous German concern, successfully forming a syndicate to work the Daimler patents in England. From Mr. Simm's account of

the early days of the industry and of how he became engaged in it is most interesting because of his close touch with its growth, from the time when he was referred by Daimler factory officials in discussing ignition subjects with them, to a German machinist of ideas. The Simms-Bosch magneto was the result of the new acquaintanceship, bringing the original Bosch down from a size 16 inches in height to one suitable for use on automobiles.

As to future changes in construction, Mr. Simms predicts some important ones, although they may not be thought of now, except as ideas, drawing his lessons from improvements made in the past, such as those to the steam engine, which, when perfected in its reciprocating types, was followed by the turbine. Automobile designers are now working upon hydrocarbon turbines with more or less success, the principal difficulty being in caring for the excess of heat. The Knight motor, he mentions as an improved type. In interviews up-

on the subject of gasoline motor design, he favors cylinders cast in pairs, with valves in the head and a hemispherical compression chamber, a single camshaft, thermo-syphon cooling, selective sliding gear transmissions, and shaft drive. The number of cylinders depends upon the power necessary, four cylinders up to a certain size and then six. This is true, also, of his idea upon the number of speeds used in the transmission, medium priced and powered cars having three and the larger ones four.

An interesting point by Mr. Simms is that, to a great extent, the French designers as a whole are behind those of two or three other countries, because a number of the ideas which are now becoming popular were originated in these other countries.

What Gruenfeldt Noted in Europe.—Emil Gruenfeldt, M. E., E. E., who is the designer and chief electrical engineer of the Baker Motor Vehicle Company, of Cleveland, has recently returned from Paris and Berlin. Mr. Gruenfeldt reports that the

various types of electric motor cars now in use in the principal cities of Europe he cannot perceive any substantial benefit to be derived there in the line of batteries and motor construction. He says that European cars are not built to render the substantial service demanded of electric motor cars in this country, and that while the batteries in use abroad are of very high capacity, having thin plates, their life of active service is reduced; and the chief merit of European electrics appears to be their comparatively high speed.



Emil Gruenfeldt.

Mr. Gruenfeldt maintains that the main parts of the electric motor car, such as motor, controller and wiring, in connection with the necessary smaller attachments, are, as a whole, worked out very poorly in the European car and not capable of yielding the long life and high efficiency of the high-grade American car. The European production appears to be confined principally to broughams and cabs, and there appears to be a large field for the marketing of a properly designed small electric motor car of the high-grade American type.

Stewart McDonald, vice-president and general manager of the Moon Motor Car Company, of St. Louis, in commenting upon the great activity of his concern said recently: "The volume of our business has increased to such an extent that the 1909 output, which we planned in making our advance orders for material, has already been sold or contracted for. We have found that we must turn out more cars than we planned this year. To do this we increased our working force 10 per cent. just after the St. Louis show, and as soon as our facilities will permit it, we will probably make a further addition to our factory force. Fortunately, the Moon factory was built with this growth of the business in view, and we have plenty of room at our plant."

James Joyce, manager of the Alco car manufacturers, who may fairly be taken as a spokesman for the makers of the cars of highest grades and prices, with regard to the increase of cheap and medium-priced cars on the market this year, says: "Let them come; the more the merrier; they have their field; they make new converts and send a lot of them higher up for their second cars. These low-priced cars bring many new faces into the automobile field. Some cannot afford to pay more, but will be able to do so later. Some others can afford to pay the top price, but figure that they can buy two or three cheap cars for



F. R. Simms. From "Automotor Journal," London.

the price of one of the others. They are the sort who must learn in the school of experience. Seasoned automobilists like a car that stands seasoning; that they know and understand as a friend. They figure on the economy in the long run, counting the cost per thousand miles, the percentage of time the car is out of commission, the delay, annoyance and deprivation endured, or the comfort, convenience and confidence enjoyed. All these things count in a car, the same as they do in house furnishings or clothing."

George M. Stadleman, secretary and general sales manager of the Goodyear Rubber & Tire Company, in speaking of the great amount of tire trade centering around Akron, the value of the business to be done there during the coming season, and, from this, drawing a deduction as to the number of automobiles to be manufactured in 1909, says: "It is practically conceded that about 75,000 automobiles of different sizes will be manufactured in 1909, and to furnish tires for these and to renew tires on the ones already in existence means a production of \$15,000,000 worth of tires alone from the city of Akron. The tire industry was never better in every part of the country, and so great has been the increase in that handled by our Boston branch that enlarged space has been found necessary.

"This has led to the purchase of a lot and the erection of a five-story building, and it has just been occupied. At Akron we have just completed a new vulcanizing room of concrete and turrent construction over the Cuyahoga River. Eight presses, each of which will vulcanize 14 tires at once, have been installed and in combination will give facilities for an enormous product. Still another building of brick, concrete and steel, five stores high, is now being built."

H. H. Rice, manager of the Waverly Company, has advanced a new comparison to explain the care and management required for a storage battery by likening it to a horse. He says: "The same thought and attention that every intelligent man bestows on a horse should be applied to a battery, and the same degree of intelligence that is required for the care of a valuable horse is sufficient for proper management of a battery. Charging a battery is much like feeding a horse. It should be done regularly, at the proper times and within proper limits. If you were driving a horse on short trips about town, you wouldn't feed him at every hitching post. Neither should you put your battery on charge every time you house it in the garage. You should wait until the battery has been discharged down to a certain point and then give it a full charge.

"But a full charge doesn't mean overcharging any more than a good feed means overfeeding. Overfeeding a horse may produce fever, and just so overcharging a battery will raise the temperature of the plates unduly and injure them. On the other hand, you wouldn't work a horse until he had used up the last atom of strength in his body, and so you shouldn't use a battery until every volt of current has been discharged. The rule is not to discharge a battery below 1.70 volts per cell—or for a 30-cell battery, 51 volts. Again, if your horse has been worked pretty near the limit of his strength, you won't allow him to stand long in the barn without a feed. Just so with a battery. It should be kept charged whether you are going to use it or not. Moreover, it should always have a sufficient supply of water. This is just as true of a horse.

"Of course, the analogy might be pushed too far, but it is a general truth that if a man will give the same intelligent consideration to the needs of his storage battery as to those of a 'hay motor,' the care of an electric will prove far easier than that of a horse, and the satisfaction of its use far greater."

F. M. Hoblitt, general sales manager of the American Locomotive Company, stopped in Minneapolis for a day on his return from an extended trip on the coast, and he is all enthusiasm about the conditions from Minneapolis to the Pacific. While in San Francisco he closed a deal with three of the largest hotels for 25 American Locomotive taxicabs for spring delivery, and says that this feature of the industry is just coming into its own on the coast. He also opened an exclusive American Locomotive

agency in Los Angeles, and while there personally sold three cars within a few days of each other. The Victoria Motor Car Co., of Minneapolis, the Alco agents, Mr. Hoblitt says, is slated to do a large business. Mr. Hoblitt recalled the days when the inhabitants of Minneapolis chased him up Nicollet avenue, not for any crime, however, but to see his automobile go. Since that time he has been here many times and takes a great interest in the growth of the automobile industry in Minneapolis and the Northwest.

NOTED MOTOR BOATS FOR PALM BEACH.

BY JOHN C. WETMORE.

PALM BEACH, FLA., March 1.—Preparations for the fifth annual motor boat carnival and races of the Palm Beach Power Boat Association, which will take place on Lake Worth, March 16 to 19, are now complete. Indications point to the most successful regatta and notable power boat carnivals in this country. Leland Sterry, secretary of the association, is in communication with owners of some of the fastest and best known speed crafts in the country, and every inducement in the way of favorable freight, railroad and hotel rates is being offered.

No finer sheet of water for motor boat racing is available in this country than Lake Worth. A course measuring 2 1-2 nautical miles straightaway has been surveyed, showing a minimum depth of 12 feet and a maximum of 20 feet. There is practically no tide on the lake, thus permitting top speed in each direction. Between \$2,500 and \$3,000 represents the total cash value of the magnificent trophies the association has put up for competition. Foremost among them is a \$500 silver trophy, 25 inches in height, offered for the best mile record made during the meet. Then come the \$400 trophy offered by the Beach Club for the endurance contest on the final day, and the \$300 cup to be competed for by Florida built boats.

The first day of the carnival will be devoted largely to speed trials. Timers will be placed at every stake to secure the records of the boats. Theodore D. Wells will use the figures thus obtained as a basis for the handicaps during the remainder of the regatta, a system which has proved most satisfactory during the four years of his administration as handicapper at these regattas.

The entries will close the day before the start of the regatta, though they may be made at once with Leland Sterry, secretary, the Breakers, Palm Beach, Fla., or with W. J. Morgan, Thoroughfare Building, Fifty-seventh Street and Broadway, New York City. Among the entries already received are: *The Buffalo Courier*, W. J. Connors, Buffalo; *Trente Sept and Crusher*, George Gingras, Rockledge; *Kitty Sparks*, Charles Furthmann, New York; *Messenger Boy*, George E. Andrews, Palm Beach; *Possum* and *Flying Fish*, Lieut. Hugh L. Willoughby, Newport; *Dewey*, W. T. Coachman, Jacksonville; *Dennison III*, Com. Christopher Gallagher, Philadelphia; *Dixolite IV*, Jupiter, Fla.

MUNICIPAL CAR GOES 100,000 MILES

CHICAGO, March 1.—Some one interested in figures has dug up the fact that the city of Chicago has no less than 14 automobiles in service, divided as follows: Police Department, 2; Fire Department, 2; Board of Improvements, 2; Health Department, 2; City Physician, 1; Commissioner of Public Works, 1; Bureau of Streets, 1; Bureau of Engineering, 1; Park Commission, 1; Department of Track Elevation, 1, and Council Committee, 1. Any one who thinks that municipal cars do not see service will be greatly surprised to know that the record is held by Superintendent Doherty's Street Department machine, which has traveled 97,000 miles in two years. That this is not an isolated instance is shown by the additional statement that Deputy Commissioner Paul Redieske, of the Public Works Department, traveled 52,000 miles in a single year—1908. Another machine, recently purchased, has gone 5,000 miles in two months of the winter, which is at the rate of 40,000 miles a year. Considering the usual treatment of municipal equipment this example of useful work by a city machine will be of interest to taxpayers, who foot the bills.

PITTSFIELD INDUCTOR TYPE H. T. MAGNETO.

DALTON, MASS., Feb. 29.—Developments in magneto design have followed one another so rapidly during the past few years that it has been difficult to keep track of them, and their variations are coming to be such that it is equally difficult to classify them. This is the case with the new Pittsfield high-tension magneto that made its debut at recent shows. It consists of a generator of the inductor-alternator type, but embodies numerous features that distinguish it from previous attempts in this direction, beside auguring well for its success in service. Imported steel of a special grade is employed in the shape of the usual permanent magnetic field of conventional compound horseshoe design, but the magnetic circuit marks a radical departure from practice in this field hitherto. Being of the inductor type, the magneto generates the current at low tension, but the induction coil is not only incorporated in the machine, but its core is made to serve as part of the magnetic circuit. The pole pieces are of laminated construction, and attached to them top and bottom are two bars, measuring about ¼-inch thick by ¾-inch wide, and extending about 1½ inches beyond the permanent field at the circuit-breaker end of the machine. Between the outside terminals of these two extensions of the magnetic circuit, the induction coil is clipped, its built-up core making a close fit between the two, though it is so mounted as to be readily removable for inspection or replacement. Next to the bore of the polar gap is placed a four-part sleeve, in which revolves the inductor.

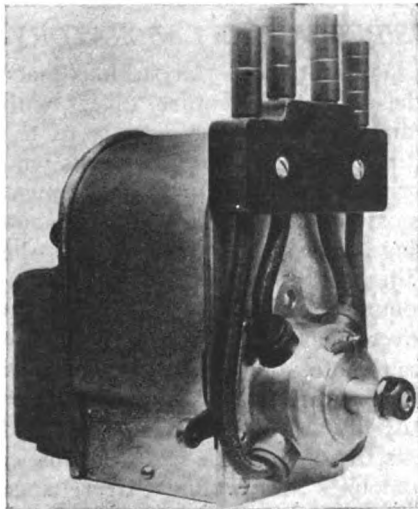

General View Pittsfield Magneto.

The four members comprising this sleeve are fastened at the distributor end of the magneto to a circular bronze plate and serve to provide for changing the time of occurrence of the impulses, this method giving a range of advance of 30 degrees at the magneto, or the equivalent of 60 degrees on the motor. As it is of the inductor type, there are no moving windings, the impulses being generated directly in the primary of the coil already mentioned. Just behind this is placed the circuit breaker. Due to the use of the sleeve already described, the magneto generates four impulses per revolution, but in order to comply with the usual requirements on four-cylinder motors only two are utilized.

Quite a departure is to be found in the condenser, which is circular in form and is assembled on a special machine devised for the purpose at the Pittsfield Spark Coil Company's factory in this city. Owing to the usually liberal condenser capacity provided, no sparking is visible at the platinum contacts at any speed, while the current generated is such that a very long spark is produced at a low r. p. m. rate, due in large part to the fact that the inductor is laminated. The efficiency of the generator is further enhanced by the extremely small clearance between the inductor and the sleeve obtained by special methods of manufacture devised at the Pittsfield plant. The field poles as well as the inductor are of laminated construction, and after they have been assembled in place, the magnets and poles are jugged and the tunnel is then rough bored. The jig employed is extra heavy and holds this foundation of the generator securely against movement in any direction. After the completion of the first cut, lapping is resorted to, and is subsequently followed by a very fine finishing cut, taking off about .002-inch. The faces of

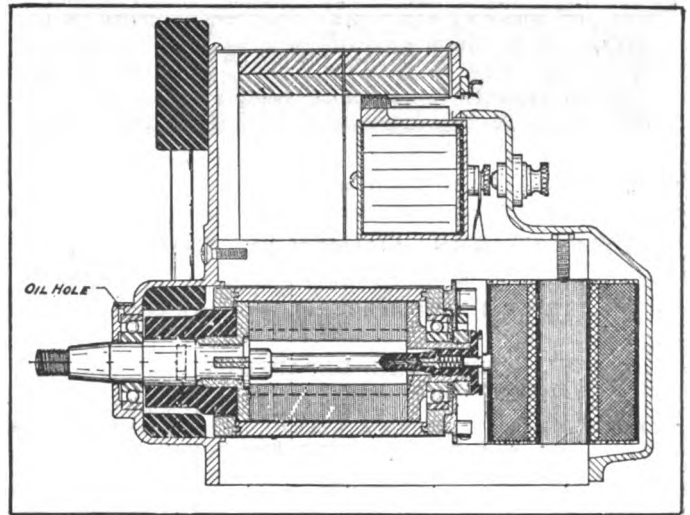

Longitudinal Section Through the Pittsfield Magneto.

the laminated inductor are ground to an extremely close finish, and it is mounted on F. & S. annular ball bearings.

An unusually high degree of efficiency has been attained in the construction of the induction coil, this measuring scarcely three inches in height over all by about 1½ inches in diameter. The core is of the usual laid-up construction, annealed iron wire of special grade being employed, upon which the primary is directly wound, oil silk being employed for insulation, while the winding itself consists of enamel insulated wire having a much higher factor of resistance than the usual silk covering and occupying considerably less space. The secondary winding is held between fiber washers and is put on in the usual manner, the entire coil being subjected to a bath in a special insulating compound applied in an impregnating tank at high pressure.

In testing out the first magneto of this type, it was run at 2,300 r. p. m. for the equivalent of more than 40,000 miles travel of a car, while the first series of machines to come through was subjected to a 10-day test at the same speed running constantly for 10 hours a day, without revealing any signs of weakness. As applied to a Franklin air-cooled motor in Mr. Muller's laboratory at the Pittsfield factory, the magneto exhibited unusually good starting qualities, the motor getting under way from cold on the first compression for a score of times in succession, there being no necessity of making a complete revolution of the crank in order to insure a start.

The plant of the Pittsfield Spark Coil Company, at Dalton, Mass., is probably one of the largest in the country devoted exclusively to the manufacture of ignition specialties, everything, with the exception of wire, being turned out in the home factory.

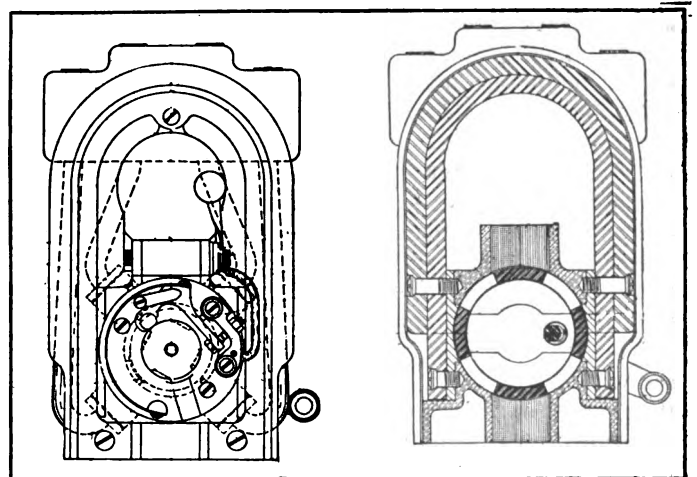

End View Circuit Breaker.

Cross Section of Same.

THE AUTOMOBILE

Vol. XX

Thursday, March 4, 1909

No. 9

THE CLASS JOURNAL COMPANY

H. M. SWETLAND, President

231-241 West 39th Street, New York City

EDITORIAL DEPARTMENT

A. G. BATCHELDER, Managing Editor

R. F. KELSEY, Associate Editor

THOS. J. FAY

MORRIS A. HALL

W. McKEAN WHITE

W. F. BRADLEY, Foreign Representative

BUSINESS DEPARTMENT

A. B. SWETLAND, Business Manager

LOUIS R. SMITH

FRANK B. BARNETT

W. I. RALPH, 1035 Old South Building, Boston, Mass.

C. H. GURNETT, } 1200 Michigan Ave., Chicago, Ill.

F. W. VAN SICKLEN, }

H. H. GILL, Detroit, Mich.

T. B. VAN ALSTYNE, Philadelphia, Pa.

Cable Address - - - - - Autoland, New York
 Long Distance Telephone - - - - - 2046 Bryant, New York

SUBSCRIPTION RATES:

United States and Mexico - - - - - One Year, \$3.00
 Other Countries in Postal Union, including Canada - - - - - One Year, 5.00
 To Subscribers—Do not send money by ordinary mail. Remit by Draft,
 Post-Office or Express Money Order, or Register your letter.

FOREIGN SUBSCRIPTION AGENTS:

ENGLAND:—W. H. Smith & Sons, Ltd., 186 Strand, London, W. C., and all book-
 stalls and agencies in Great Britain; also in Paris at 248 Rue de Rivoli.
 FRANCE:—L. Baudry de Saunier, offices of "Omnia," 20 Rue Duret, Avenue
 de la Grande Armee, Paris.
 GERMANY:—A. Seydel, Mohrenstrasse 9, Berlin.

Entered at New York, N. Y., as second-class matter.
 The Automobile is a consolidation of The Automobile (monthly) and the Motor
 Review (weekly), May, 1902, Dealer and Repairman (monthly), October, 1903,
 and the Automobile Magazine (monthly), July, 1907.

AERIAL PROGRESS INDEBTED TO AUTOMOBILE.

How few people there are who have the correct viewpoint of the very recent and almost startling progress made in navigating the air! To place the credit where it belongs is a hard matter, and one that would lead to a war of words and hard feeling, but to ascribe all of that progress to the men prominent in aeroplane work is certainly a mistake. The vast advancement made in automobile engine construction surely paved the way for what followed, and therefore the automobile industry as a whole must shine by reflected light, so to speak. Aeronautical men generally are free to admit that the light-weight motor has made the two-hour flights not a possibility, but a probability, and, more, a reality. This statement, when analyzed, allows but one rational deduction, viz., that without the ultra-light engine we would be to-day where we were several years ago. To descend to slang, then, the engine is the "whole thing." Further, the engine is distinctly an automobile production, therefore the inference is that the airship is an automobile production, not *per se*, but indirectly.

Now, to bask in this reflected glory a little bit, let us see what the industry has done for the internal combustion motor in the way of reduction of weight and improvement in reliability. Ten years ago the automobile that would run at all was very uncommon; in fact, it was a curiosity. The smooth-running, quiet motor of

to-day was but a dream, the stern reality was the necessity of keeping the engine in motion for more than a minute or two. As to weight, the motor weight of those days ran up to two or three hundred pounds per effective horsepower. This was pulled down by successive stages to one hundred, eighty, sixty, forty, and so on. To-day there are many motors which weigh close to ten pounds per horsepower. For aeronautical work this figure is cut in half, but in so doing the effective life of the motor is reduced an equal amount. At any rate, there is a great deal in the contention that the automobile is the father of the airship and therefore entitled to its share of credit.

To eliminate this ever-present factor of uncertainty and still retain the light construction is the engine builder's problem to-day. In this work, too, the automobile firms should find an outlet for a vast amount of surplus energy and one that is well worthy of extended attention, not only from the measure of glory to be received but also from the more practical viewpoint of profit. This is readily seen by considering a simple question, thus, where will aeroplane builders of to-morrow obtain engines of light weight, in large quantities?

* * *

PRACTICALLY CONSIDERING THE LABORATORY.

In former times the laboratory was a mysterious place in which it was not the custom to venture, unless with hat off, muffled tread and voiceless. The director of the premises was supposed to be one of the few mortals who could cope with the problems, and as to the equipment used, it was of the most baffling description. It is no wonder that the testing of materials was left to the makers thereof, for the most part, excepting in rare cases, taking into account such users of vast quantities of materials as the Government.

When automobiles came into vogue and it looked as if materials were found to be wanting, in some respects at any rate, the question of the ability of the materials had to be arrived at and tests for the purpose had to be made. The designers of automobiles soon found that reliance could not be placed on the tests that emanated from sources under the wing of the makers, and an attempt was soon made to get at the bottom facts, and by so doing look the problem squarely in the face.

It was then ascertained that all the so-called impact tests fell short of the truth by a distance equal to a stellar unit of measurement, and that the "dynamic ability," in relation to which publicity agents raved, was frequently but a myth. In the meantime men of ability, actuated by pure motives, took hold of the problems, and while the situation savored of much complexity, the fact remains that the problem bowed to honest endeavor in much the same way that the mightiest oak pays humble tribute to the breath of the storm king.

Of the notable advances in recent times it is fair to say that the Shore Scleroscope, used in testing for hardness, is well worth more than passing notice in view of its good accuracy, great flexibility and the fact that it is simple enough to put into the hands of the artisan upon whom reliance must be placed for uniform results in the long run. The principle involved is of interest in that it takes into account the phenomena involving impact, and measurements do not have to be made, the nature of which are beyond the skill of workmen.

N. A. A. M. FAVORS DETROIT START FOR A. A. A. TOUR

NEW YORK CITY, March 3.—Attended by a number of important figures in the automobile trade, the regular monthly meeting of the members of the executive committee of the National Association of Automobile Manufacturers was held this afternoon and several affairs of importance to automobilists considered. The Chicago show was reported a success; it was decided to aid Detroit in its campaign to secure the start of the Glidden Tour; it was also agreed that its counsel should fight the anti-auto legislation at Mount Desert, Me., and committees for the following year were announced.

In his report upon the exhibition at Chicago, General Manager Miles showed that the great affair had been a success, not only from the amount of the net receipts, but also from the amount of business transacted by those exhibiting machines, and the makers were greatly pleased at the result. Inasmuch as Detroit has become the greatest automobile manufacturing city in the world, it was the opinion that it really deserves to have the start of the annual endurance contest, and resolutions were adopted asking that such should be decided by the A. A. A. Contest Board. Fully a dozen entries from that city alone will probably be made if the tour starts there, and there will be unbounded enthusiasm. The pathfinding car will leave Detroit within a couple of months.

For some time there has been a growing agitation at Mount Desert, Me., against the use of automobiles on the island, and it has been found, upon investigation, that a great deal of it is prejudice, according to the N. A. A. M. opinion. Therefore, at the meeting this afternoon, the executive committee authorized its counsel to do all possible to prevent the passage of legislation preventing the use of automobiles there.

S. D. Waldon, of the Packard Motor Car Company, was in the chair for the first time since his election as president. The others present were: S. T. Davis, Jr., Locomobile; W. R. Innis, Studebaker; R. D. Chapin, Chalmers-Detroit; W. E. Metzger, E-M-F; W. T. White, White; L. H. Kittridge, Peerless; A. L. Pope, Pope; Thomas Henderson, Winton; Charles Clifton, Pierce Arrow, and S. A. Miles, general manager.

The following committees were nominated by the president and approved to stand during the coming year:

Membership—S. T. Davis, Jr., Benj. Briscoe, C. C. Hildebrand.
Legislation—W. R. Innis, R. D. Chapin, C. G. Stoddard.
Roads—R. D. Chapin, S. T. Davis, Jr., L. H. Kittridge.
Show—W. E. Metzger, A. L. Pope, Thos Henderson.
Contest—H. O. Smith, W. T. White, W. E. Metzger.
Audit—Benj. Briscoe, S. T. Davis, Jr., Chas. Clifton.
Traffic—A. L. Pope, W. R. Innis, C. C. Hildebrand.

CROSS-THE-COUNTRY TO SEATTLE FAIR.

'Tis possible that the cross-country endurance run from New York City to the Seattle Fair may start about the middle of May in order that there shall be no possible chance of interference with the annual Glidden tour of the American Automobile Association. This suggestion is made by the contest committee of the Automobile Club of America to the promoters who have obtained a conditional international sanction from that committee.

Originally the date of the start was to be on or about June 1, but it seems that an objection was made to this date from several sources, which is probably the cause of the club's committee suggesting another date.

The International Association of Recognized Automobile Clubs has no rules governing a transcontinental endurance contest, nor did it take any heed whatever of the 1908 event of a similar sort which encircled the globe. Hence, it is predicted by some who are in a position to know the trend of events that the old misunderstanding with the A. A. A. and the A. C. A. may have another lease of life. Others claim that there is no chance whatever of friction and that whatever difficulties may arise will receive amicable consideration—in fact, assurances of this sort are said to have been mutually interchanged.

One significant thing is pointed to in the presence on the advisory board of the Manufacturers' Contest Association of a member of the contest committee of the A. C. A.

In the meantime T. F. Moore, of Mills & Moore, has returned from his Seattle visit surcharged with enthusiasm and confidence. A tentative route has been chosen, and other arrangements are gradually being decided upon.

One rule as first proposed has been changed, so that in addition to the frame, the cylinders, transmissions, front and rear axles and crankcases will be stamped before the start, and each car will be allowed two complete extra sets, one to be kept for use at Chicago and the other at Cheyenne, Wyo. They will be held at these points by responsible parties.

At Seattle the Exposition authorities will erect a building to house the machines, at the conclusion of the trip, for exhibition purposes, and railroads will file rates with the Interstate Commerce Commission allowing them to ship the cars back East at half the usual rate, and guarantee to deliver them at Chicago in ten days. The rules and entry blanks have been issued and the contest committee of the Seattle Automobile Club nominated to take charge of the race from the western end.

SOME OHIO WINTER COMPETITION.

CLEVELAND, March 1.—A rough and ready go-as-you-please road race to Akron and return between a Cadillac and Jackson for \$100 a side, won by the Cadillac, and a sprint to Toledo and back through the mud by a sealed Maxwell marked the closing days of the Cleveland show this year.

There has been considerable talk between the Cadillac and Jackson people here of late, culminating in a challenge to the Jackson to race between Cleveland and Akron and return for a side bet. The contest, held under the auspices of the automobile department of the Cleveland *Plain Dealer*, started from the show building at 7 A.M. Saturday morning. The eighty miles was covered by the Cadillac in 5 hours 25 minutes, while the Jackson went into a ditch and bent the gear-shifting lever so badly that low speed could not be used.

The Jackson people have come back at the Cadillac representatives with a return challenge, allowing the Cadillac people to make their own terms. What the final outcome will be is not yet known.

The Maxwell run was to test out a green car with everything sealed up. A four-cylinder roadster was taken off the show floor and pressed into service. The hood, coil box and tool box were sealed by the automobile editor of the *Plain Dealer* and the car started. The mud was terrible, the axles often dragging for miles. The machine left here Friday morning at 6 o'clock, and got back Sunday at 6:30 P.M., after a trip which most people said was impossible. Not a seal was touched during the entire run, and the car is now being used to demonstrate around the city streets.

FORD CLAIMS PATENT INFRINGEMENT.

DETROIT, March 1.—Claiming that several automobile manufacturers in their rear-axle constructions are infringing upon a basic patent covering this, Henry Ford, president of the Ford Company of this city, has threatened to bring suit against these concerns, the names of which are not, as yet, made public. The patent, No. 747,909, was taken out in 1903, and, it is claimed, covers a great many of the rear constructions now used in prominent cars.

Probably the first aeronautic professorship in the world has been instituted at Gottingen University, where Professor Prandl has been nominated to lecture on aeronautics in general and their practicability for universal use.

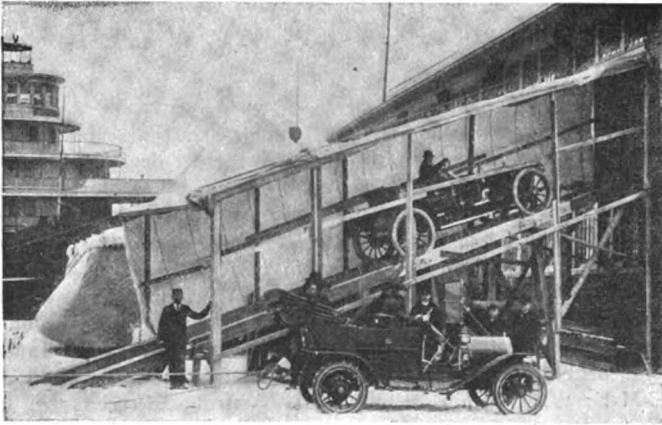

How E-M-F Pulled Cars Into Detroit Casino.

ONE WAY TO CLIMB A 30 PER CENT GRADE.

DETROIT, MICH., March 1.—A difficulty which confronted the management of the Detroit show the other week was how to get a number of the heavy cars up to the second floor, especially when the runway allowed by the city give a rise of 13 feet in 40, slightly over 30 per cent grade. It was finally accomplished by having LeRoy Pelletier's E-M-F touring car attached to one end of a block and tackle, after a truck had failed to appear and the use of horses scorned. At first the car was unable to secure traction, its wheels spinning, even though chains were on the tires. By loading a number of heavy men into the tonneau, this was overcome and some very heavy cars pulled up the steep incline, one limousine weighing 5,500 pounds.

DETROIT TO HAVE ANOTHER, YET UNNAMED.

DETROIT, March 1.—The Hudson Motor Car Company is the latest addition to Detroit's automobile colony. The incorporators of the concern are J. L. Hudson, one of Detroit's largest merchants, who is identified with a great number of local industries; R. B. Jackson, George W. Dunham and R. B. Jackson, trustee. It is a closed corporation, with \$100,000 capital, all of which has been paid in. Mr. Hudson will act as president.

Mr. Jackson was formerly general manager of the E. R. Thomas Motor Car Company, and has been identified with the industry in an executive capacity for some years. George W. Dunham was until recently chief engineer with the Olds Motor Works, at Lansing, and is recognized as a designer of ability.

Details of the car have not yet been announced. For the present the company will occupy the plant formerly used by the Northern Motor Car Company.



Fur-coated Testers of Pierce Great Arrow Cars.

Immune to all kinds of weather, this squad of men is employed by the Pierce Arrow Motor Car Company at Buffalo to give all of its cars a dash over the roads before shipping them. Two of the men in the picture have been with the company since it was started in 1901. During the recent storm, though the ground was covered with a foot of snow, their work was not interrupted.

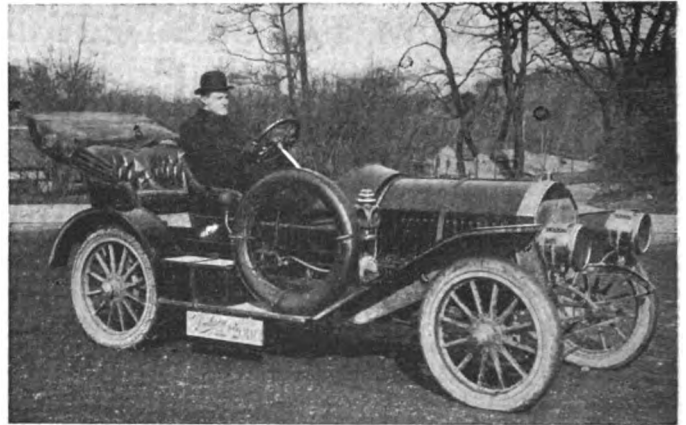

Champion Frank Kramer In His Jackson Car.

THE WORLD'S CHAMPION DEMONSTRATOR.

NEWARK, N. J., March 1.—It is seldom that a real world's champion volunteers as an automobile demonstrator, but Frank Kramer, the cyclist, who for three years was the amateur and for seven years the professional champion rider of America, besides winning one year Europe's most important race, volunteered as such at the Newark, N. J., show last week, using his own 40-horsepower Jackson car, to aid the Essex Automobile Company, from whom he purchased the machine. Kramer successfully filled the part of demonstrator, selling several cars.

LOCOMOBILE HAS APPRENTICE SCHOOL.

BRIDGEPORT, CONN., March 1.—The graduation of employees as apprentice machinists is a happening which does not often occur in automobile factories, but which did last week at the plant of the Locomobile Company of America in this city. Feeling that additional knowledge and interest on the part of its mechanics would benefit the company directly, a combination course for apprentices has been arranged so that boys who work in the big factory on the water front are able to go to school a part of four days every week.

The school is the industrial department of the local Y. M. C. A., toward the maintenance of which each factory sending apprentices contributes. The Locomobile Company has established a three-year course, allowing the boys to go to the school two hours each day and work in the factory during the rest of the time. It has been so arranged that all are not away from the plant at the same time, and their absence is thus not greatly missed. They are taught simple arithmetic, algebra, mechanical



Facsimile of the Locomobile Diploma.

drawing, geometry, grammar and similar subjects. When the course is completed the "graduate-apprentice at the machinist's art and trade" is given a neat lithographed diploma.

STEADY PROGRESS OF THE COMMERCIAL VEHICLE.

THE situation to-day in the field of the self-driven or power vehicle is such that the men most interested in that line count that day lost which does not chronicle some new or different commercial vehicle installation opening up an entirely new field of usefulness. The largest development of the past few months has been in the line of municipal use as police, fire, hospital, emergency, and similar service. Not that other branches have stood still, but this field has shown a wonderful increase.

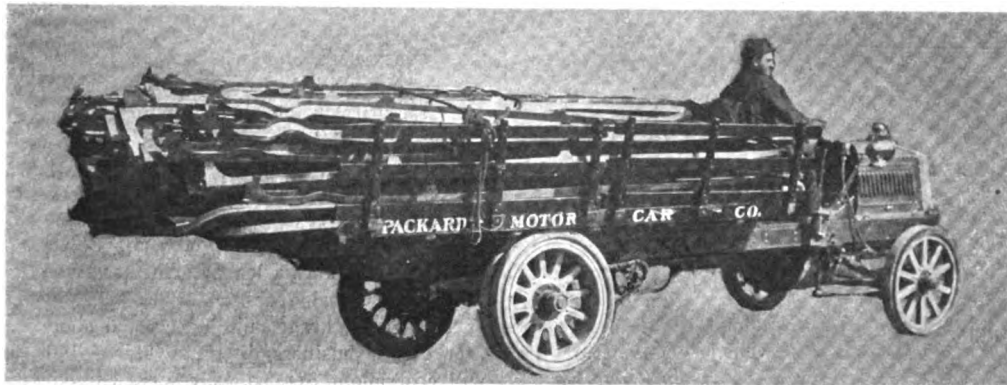

Packard Truck That Has an Admirable Record for Efficient Service.

In the transportation of passengers, in our large cities, the increase has been less spectacular and more on the order of slow but sure. Thus in suburban traffic and in the transporting of people between towns that have poor railroad facilities or none at all, the past year has shown an expansion that was particularly gratifying. In this connection, one of the accompanying illustrations shows an omnibus installation in Washington which marks the public demise of a much-despised horse service. In marked contrast with the evil smelling and poorly lighted old herdics, will be the new clean omnibus, lighted by electricity.

Truck Undergoes Two Years of Severe Service.

As a mark of confidence in its own product, publicly expressed, the excellent example of long service afforded the Packard Company by its truck number four, is also of interest. This vehicle did the hardest kind of work and was subjected to all sorts of overloads, yet after two years of this, a single coat of paint and simple overhauling is the only reward it will get before being put to work again.

In connection with the recent diatribes of the Senate, against automobiles for transportation, the point has been brought out that this country possesses a smaller number of commercial cars than any European country one might think of. This evidence of backwardness on the part of a nation accustomed to pride itself on the opposite, will only be dispelled by the wholesale adoption of commercial cars. An opening wedge, perhaps, is the recent purchase by the War Department of a car of the light delivery type from a prominent Pennsylvania concern. At any rate, this car and its performance will be closely watched, not only by other departments, but by other manufacturers of this type of car

as well. The pointers gained from this installation will be valuable when Uncle Sam is again in the market. Although a poor customer in this line, in time to come he will be a heavy buyer.

The question is often asked: "How long will a motor truck stay in active commission?" An exact reply is impossible because every individual truck operates under different circumstances, performs different service and may have different care. Examples of what some trucks have done, however, show that

a good truck is capable of much longer service than ordinarily would be expected. The Packard Motor Car Company, of Detroit, Mich., uses its own three-ton truck exclusively in local hauling. The Packard Company's truck No. 4 was put into service in 1907. It has been actually in service 522 days, during which it has covered 16,489 miles. Its principal work has been in hauling express and freight between the Packard factory and the different railway freight depots. The truck, in the time it has been in use,

has made 1,373 trips and has hauled 7,833,022 pounds of freight, or, approximately, 4,000 tons. Its tonnage per day has been 7.5 (15,006 pounds) and its average tonnage per trip 2.85 (5,705 pounds). The gasoline consumed in these 522 days of work has been 3,548 gallons, or on an average of 4.64 miles per gallon. The truck has just been put into the shop for repainting and overhauling, and, as soon as this is accomplished, will be placed again in the regular service.

Replacing Horse-Drawn Herdics in Washington.

A motor omnibus, the product of the H. H. Franklin Manufacturing Company, has been put in service in Sixteenth street in Washington, the plan being to replace with such vehicles the horse-drawn herdics which have been in use in that street despite long complaint on the part of Washington people. The omnibus is specially built to accommodate fourteen or sixteen people, seated along the side. It is for operation without a conductor, the door, at the rear, being controlled by the driver by means of

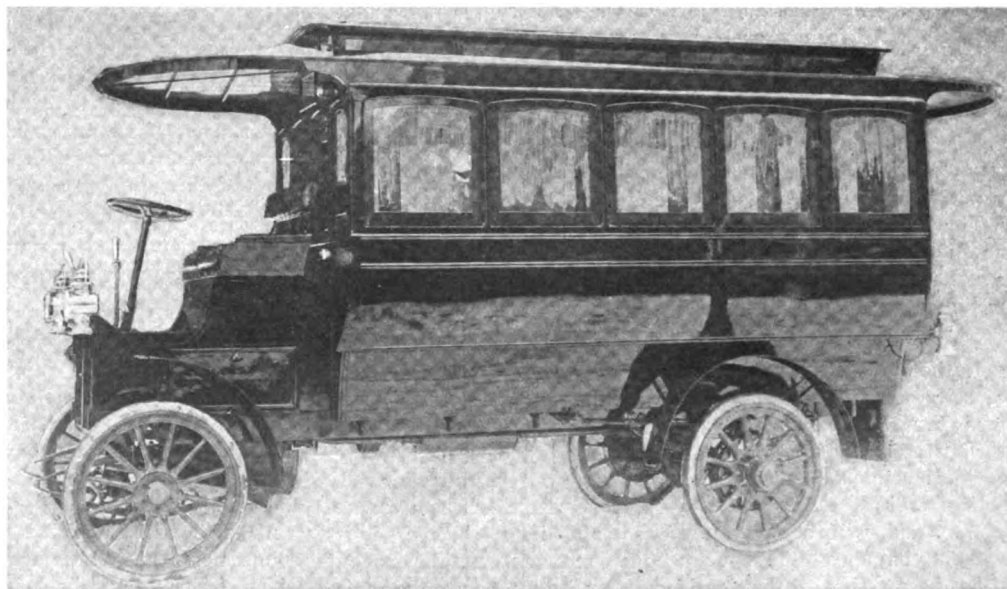

Franklin Air-Cooled 'Bus in Service on Sixteenth Street, Washington.

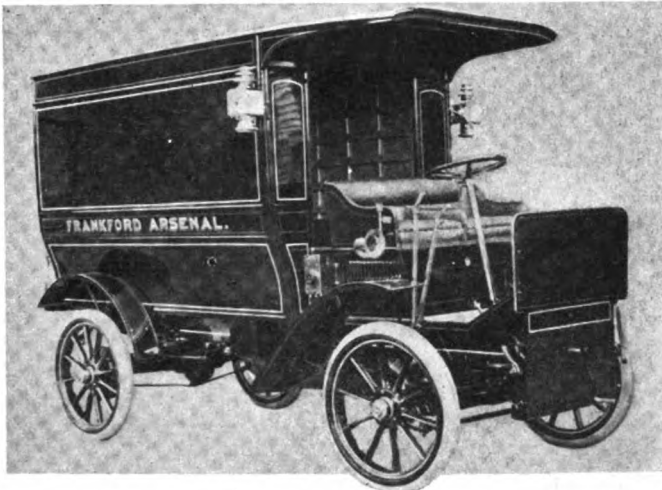

The War Department's Latest Recruit, an Autocar.

a strap. Fares are deposited in a cash box of which he is in charge. The car is electrically lighted and weighs 3,180 pounds. It is built on a chassis that is practically that of one of the Franklin trucks, with a lengthened wheel base, 120 inches. It has a worm drive rear axle. The engine is air-cooled and has 18-horsepower. The cylinders are $3\frac{1}{2} \times 4$ inches. The vehicle is geared to run about fifteen miles an hour, and is to be in service $17\frac{1}{2}$ hours daily, running in that time 120 miles. It is provided with three speeds forward and a reverse; the transmission is of the progressive type, sliding gear. The body was built by the Ellis Omnibus & Cab Company of Cortland, N. Y., and negotiations for placing the car in service were made by the Cook & Stoddard Company, Franklin dealer in Washington. The omnibus is operated by the Metropolitan Coach Company.

Uncle Sam Takes Delivery of a Commercial Vehicle.

The third illustration shows a car recently delivered to the United States War Department for use at the Frankford Arsenal in Philadelphia. This is a good example of the new Type XVIII commercial car brought out by the Autocar Company of Ardmore, Pa., and although this type is in the nature of a departure for this firm, the happy result is best expressed by such involuntary compliments, coming as the result of a searching inspection of the whole field by the Engineers of the War Department. By an examination of the cut it will be seen that the car is of the type in which the driver is placed over the engine thus shortening the effective length of the car, and what is of even greater value, the wheel-base, which in turn decreases the turning radius. In cities of many narrow streets, this latter is a great advantage as it allows of turning around without backing. The car has the additional time-saving advantage of a unit power plant which is quickly removable without disturbing any other part of the car. Thus in case of trouble, particularly where time is of first importance, the power plant is removed as a unit and another substituted, delaying the car but a small fraction of the time that would be necessary to remedy the damage.

The body is of the box or enclosed type, with rear doors. In addition, the front of the car body is open so that the driver can see the interior at all times, curtains being provided as a protection against inclement weather.

Rutherford, N. J.—Three automobile stages, with a seating capacity of thirty each, have been put into service by the Rutherford Transit Company between the Erie Railroad station and various points in the borough. This company, composed mainly of local residents and stockholders, has been recently formed, with a capital of \$2,000, to supply proper transportation to the station, and, with a low rate of fare and fixed schedules, it is thought that most of the 1,500 commuters will use the stages. It has been estimated that it will cost \$13,870 to operate the three cars yearly, and that the gross receipts will be \$16,425.

TAXICABS AND A FACTORY FOR SAVANNAH.

SAVANNAH, GA., March 1.—Taxicabs on the streets of Savannah will be a reality in the immediate future. Mr. Edward Wilson, while at the automobile show in Detroit, closed a contract for automobiles valued at more than \$75,000, among them being six taxicabs that will be seen here as soon as the factory can make the shipment. The taxicabs ordered are of the latest and most approved model.

A convenience such as the taxicabs is bound to be something which the visitors as well as the merchants will not overlook.

Prior to going to Detroit Mr. Wilson visited the motor-boat show in New York, and now that he has seen what the larger cities are doing, has in mind building an automobile factory to begin with a capital of \$350,000. Mr. Wilson is the second one who is figuring on a factory here, and it is probable that before the end of the year Savannah will be found with one or more of the largest automobile factories in the United States.

HOOSIERS TO HAVE TAXICABS, TOO.

INDIANAPOLIS, IND., March 1.—A taxicab service similar to that of other cities will be established in this city about April 1. The promoter of the project is Charles W. Sheetes, who has owned a livery stable for several years.

Sheetes is having a concrete garage building erected about one mile from the center of the business district. This will be 42 by 100 feet and will cost about \$11,000. He has ordered four Lambert taxicabs and will add to this number later if the demand warrants an additional expenditure.

It is the intention to send the cabs out only on call when the service is first established, but as the number of taxicabs increases, some of them will be stationed on downtown streets for the convenience of transient passengers. While this will be the first taxicab service, the city has had electric cabs for some years conducted by the Bird Transfer Company. This consists of electric cabs which have been stationed at the Union Station, hotels, and held at the garage for special calls.

NEW TRUCK HAS ECONOMICAL ENGINE.

DETROIT, MICH., March 1.—The former head of the Reliance Motor Truck Company, which has just been sold to the General Motors Company, is now busily engaged in the formation of a new concern to manufacture an improved type of truck. Associated with Mr. Paige in the new enterprise are H. A. Wilcox and Andrew Bachle, both technical experts. The new concern will put on the market commercial trucks, as did the Reliance company, but claims to have a new engine, which, while similar in some respects to others now being used, will include several improvements, on which patents have been taken out.

The inventions, which are said to characterize the new motor truck to be exploited by this company, are the results of the experiments of several men.

One of the features will be the consumption of less than one-third of the gasoline usually required. The factory, when it is built, will employ 800 men.

CANADIAN CITIES TO HAVE TAXIES.

MONTREAL, March 1.—A company is being organized, with a capitalization of \$2,000,000, to operate taxicabs in Montreal, Toronto, Ottawa, and Winnipeg. An investigation has already been instituted as to the kind of cars that will be most suitable for winter climate. The cabs will cost between \$1,250 and \$1,300 delivered in the city. They will be of the ordinary type, the operator sitting above and behind. The capacity will be two and four persons.

As to the tariff, which is an important matter, no definite announcement can yet be made, for there is a by-law in force which forbids taxicabs being run for hire in this city. The promoters of this project want this law repealed.



Pierce Pleases Pittsburg's Police.

Seated in the forty-horsepower Pierce-Arrow, recently purchased by the city of Pittsburg for the police department, are Edward C. Lang, Director of Public Safety, at the wheel; Thomas A. McQuaide, Superintendent of Police; Robert P. McCurdy, manager of Banker Brothers Company, and Murray Livingston. Although delivered very recently, the police officials are enthusiastic over their car.

Unusual Fuel Economy.—With all the talk of lower-priced lower-powered cars, the main idea back of it all may be summed up in a single word—economy. This same idea is being carried forward now, and the matter of economy of maintenance is becoming one of large interest. In this respect probably the two largest items are tires and gasoline. The former may not be helped much, but the latter is certainly susceptible to improvement. At one stage in the industry a mileage of eight or nine per gallon of gasoline was considered very good, but of late superior construction has pulled this up to 12, 14 and even higher for an average on long runs, with 20 and higher for shorter runs under favorable conditions. Thus, in the election day contest of many, perhaps hundreds, of Chalmers-Detroit drivers, the prize was awarded for a mileage of 25. Many made 20 and 22 miles. Recently on the coast a century run with six passengers was made in a car of this make on less than five gallons.

No Necessity for a Crane.—If you possess a good car, in particular a good electric, there is no necessity for a crane to hoist anything. The spectacle is often seen of the tedious process of hoisting by means of a horse and a windlass truck. This process is quite too slow for the Lilly & Stalnaker Hardware Company, of Indianapolis, who own a Model 43 Waverley electric delivery wagon. Having a 500-pound casting to hoist to the third floor of the new Y. M. C. A. building in that city the other day, they rigged a block and tackle as if for a windlass, attached one end of the rope to the casting and the other to their Waverley and then started up at first speed. Without a moment's halt, and at a rapid pace, the Waverley moved down the street and the casting up to its place. It was all done in a jiffy, and the lever was not advanced beyond first speed.

Apperson's California Victory.—Further details received upon the victory of Elmer Apperson in the blue ribbon automobile event upon the Pacific Coast, the Pasadena-Altadena hill climb, on Washington's Birthday, show that the performance of the Jack Rabbit this year was even more to its credit than that of last February, which it also won. The hill is a mile and four-tenths long, with an average grade of 11½ per cent., and was covered by the winner in 1:24 from a standing start, an average speed of a mile a minute being attained. In the 1908 event the time was 1:36 1-5, an average of 52½ miles per hour. The trophy is a handsome cut glass bowl, presented by the Automobile Dealers' Association of Southern California. Barney Oldfield was second in his six-cylinder Stearns, in 1:29½, and a Stoddard-Dayton third, in 1:36 2-5.

New Top Has Novel Feature.—At present the enclosed body holds sway, but very soon the open touring body with folding top will be in demand. Anticipating this, limousine bodies designed for touring over a protracted period of time have many novel features. The latest of these, a top that is practically removable, is found in the 50-horsepower Isotta-Franchini which Lewis A. Riley, president of a big Philadelphia transportation company, purchased from J. M. Quinby & Co., of Newark, N. J., the limousine body being made by the same firm. Mr. Riley has planned an extensive tour abroad for this coming season in his new car, and when in mountainous country can have part of the top rolled back, thus permitting an unobstructed view of the mountain peaks which tower above in every direction.

Packard Will Use Shock Absorbers.—Time was when the necessity for any form of shock absorber was not granted, but had to be proven, being a disputed

point. To-day the opposite view holds, in that all of the best cars are fitted with a form of "jolt" preventer. This right-about-face has taken place in the last three years, and, although gradual, is none the less permanent. The announcement, therefore, by the Hartford Suspension Company that for 1910 every Packard automobile will be equipped at the factory with the Truffault-Hartford shock absorbers does not come entirely as a surprise, but as a further evidence that automobile manufacturers as a whole are appreciating that anything they can do to make their cars ride easier and give better satisfaction is money well invested.

Hagstrom Company Increases Stock.—An increase in its capital stock from \$50,000 to \$150,000 has been voted upon favorably by the stockholders of the Hagstrom Bros. Mfg. Co., of Lindsborg, Kan., manufacturers of the Hagstrom patent inside blow-out patch and other specialties. The directors of the firm are William Hagstrom, president; Emanuel Hagstrom, secretary; Gustaff Hagstrom, treasurer; N. J. Thorstenberg, vice-president, and A. A. Abercrombie, Gust Eskwall and A. E. Agrelius. Plans for extensive additions and alterations around the factory have been made, including the building of a garage and salesroom, where the agency for a number of medium-priced cars will be placed.

Light Delivery for Library.—Following the example of the Chicago and other large libraries, the Minneapolis institution will hereafter be served by a gasoline vehicle. Kemp Brothers, agents for the Brush runabouts and package wagons, have recently closed a contract for a light delivery wagon to be used in the delivery service of the public library and its branches. This deal was put through after several convincing demonstrations had been made of the ability of the little wagon to waltz through the heavy drifts of snow and rough going now found in all sections of the city. The little wagon did the work of two horses and saved nearly 50 per cent. of the time in so doing.

Diamond Tires On White House Cars.—The makers of Diamond tires, according to C. B. Myers, of the factory, are well pleased with the representation which this make has received lately from officialdom in Washington. Mr. Myers says, "We have the equipment on the cars to be used by President Taft at the White House, on Speaker Cannon's personal machine, and also upon the Peerless limousine which was exhibited in the Cleveland show and has since then been shipped to Washington for Vice-President Sherman. On this car we have also marsh rims with quick-detachable tires."

First Show at San Jose.—Following the larger cities, the smaller towns are being infected with the show microbe. The latest to "take" out on the Coast is San Jose, which held its first automobile show recently. Previous to the opening a street parade was held, in which not less than fifty cars participated. For the exhibition the Auditorium Rink was utilized, but even this was insufficient, in view of the crowds attending. Considering that this was a first "offense," that sort of a reception was particularly gratifying to the promoters and assured the annual continuance of the affair.

New Toledo Company to Build Electrics.—The Ohio Electric Carriage Company, to build electric automobiles of the coupe style, has been formed by prom-

inent Toledo business men. Options have been taken on two or three factories here, but it is likely than an entirely new plant will be erected to produce the car, which will be known as the Ohio. H. P. Dodge, who has been a leading spirit in the preliminary work, will be the general manager, and incorporation papers are now ready to be sent to the Secretary of State.

A Pertinent Correction.—Talk about geography made to order. In the hurry of getting out a big issue like that of February 11, relative to the Chicago show, firms are sometimes inadvertently shifted from one town to another. Sometimes, too, this does not please, strange to say. For instance, in the issue mentioned above we moved the W. H. McIntyre Company to South Bend, Ind. Now it seems that this company do not like that town, so we hasten to move them back to Auburn, Ind, where they were before we started to experiment with the map.

Hartford Shock Absorbers at New Orleans.—Truffault-Hartford shock absorbers have figured in more races and record-breaking trials during the recent Mardi Gras automobile race meet at New Orleans. They were the equipment of the Fiat *Cyclone*, which made the ten-mile track record, and won a considerable number of all the events, and they were used also upon the Knox *Giant*, which Mrs. J. N. Cuneo used, and with which she won a number of events and always figured well up among the finishers.

Touring in Cuba.—That the term of office of Governor Magoon, who has just returned from Cuba, had a good effect upon the roads of the island is well shown by the number of American auto enthusiasts now making winter trips over the ideal highways. Governor Magoon changed them from cart paths to 60-foot wide macadam roads, and one of the number now touring over them is Dr. Munyon, of Philadelphia, in a Lozier limousine.

New Metropolitan Supply House.—The Weaver-Ebling Automobile Company, composed of Raymond H. Weaver, who was formerly with the supply department of Wycoff, Church & Partidge, and R. W. Ebling, of New York City, has been formed to carry on a business in automobile supplies. A full line of all kinds of sundries will be handled from the firm's location, on Broadway at Seventy-ninth street, New York City.

A. M. T. A. Elected Officers.—The board of directors of the Automobile and Motor Trades Association, a Rochester, N. Y. organization, met recently and elected officers for the ensuing year. These were the men chosen: President, John A. Breyfogle; vice-president, William S. Graham; secretary, Frank Peck; treasurer, Sidney B. Roby. A meeting will be held shortly, at which President Breyfogle will announce his committees.

Auto Races for York, Pa.—J. Allen Heaney, an inventor of York, Pa., is arranging plans for a number of local race meets, both on track and road. The first would be a speed contest of 50 or 100 miles on roads leading to York with a prize of \$100 to the winner. A second race of 15 or 20 miles will be held upon the track of the York County Agricultural Society, while the third has not as yet been decided.

Will Build to Order.—Nilson-Miller Co., of Hoboken, N. J., recently incorporated with a capital of \$25,000, is located at 1300 Hudson street, in the shop

formerly occupied by W. D. Forbes & Co. and will conduct an engineering and general machine shop business, making a specialty of designing and building, to order, electrical apparatus, gasoline engines, etc., for commercial vehicle, marine and stationary use.

Walter Plant Will Make Roebling Cars Only.—At a meeting of the Walter Automobile Company held last week at the East Trenton, N. J., plant, it was settled that the Roebling-Planche car exclusively will be built at this works. A number of hands were taken on and the cars as shown at the Garden show will be turned out in larger numbers.

IN AND ABOUT THE AGENCIES.

New Agencies for York Pullman.—H. R. Averill salesagent for the York Motor Car Company, the manufacturers of the Pullman automobiles, has returned



Stoddard-Dayton's New York Home.

The illustration shows the new home of the Stoddard-Dayton in New York City. The building is located on Fifty-seventh Street, near Broadway, next door to the old store.

to the factory after a two-months' trip around to various automobile shows and reports the establishment of agencies in the following cities: Chicago, Ill.; Topeka, Kan.; St. Louis, Mo.; Louisville, Ky.; Cleveland, Ohio; Cincinnati, Ohio; Indianapolis, Ind.; Dallas, Tex., and New Orleans, La. Later a branch house will probably be opened in Chicago. The factory is now running night as well as day to fill orders.

Elmore, Philadelphia.—Elmore popularity in Philadelphia and the East is signified by the recent acquisition by Gawthrop & Wister, the Quaker City agents, of a large subsidiary establishment at 223-225 North Sixteenth street, which will be solely devoted to garage purposes, the "Row" quarters at 244 North Broad street to be used hereafter

only as salesrooms for the rapidly growing local business. In addition, W. W. Gawthrop, who is Elmore sales manager for the Atlantic coast States, has established a main sales office in the Bulletin building, opposite the City Hall.

Remy Magnetos, Chicago.—A branch distributing house has been established at 1400-1402 Michigan avenue, Chicago, under the management of Major B. Hawxhurst. An expert magneto mechanic will be sent from the factory to assist Mr. Hawxhurst and the company will be prepared to install magnetos on old cars. The Remy Electric Company opened a branch distributing office in New York some time ago. The demand for Remy motor ignition systems has resulted in the factory and office forces being almost doubled as well as new agencies established.

Factory Sales Corporation, Chicago., has taken on as an addition to their present line of accessories, the product of the New York Coil Company. This comprises both high and low tension coils in all the various forms applicable to automobile, marine and gasoline engines, also a special motor-cycle coil and wireless telegraph coil. A specialty is a multiple coil with master vibrator for use in connection with low-tension magneto, although it is equally applicable to battery service.

Renault, Chicago.—Owing to a large increase of business in Renault cars handled in Chicago, the Renault branch has arranged to have a building erected for it at 1606 Michigan avenue, with large showrooms, repair shop and spare parts department. During the Chicago show Mr. Lacroix received from the Auto Taxicab Company, which operates the Renault taxi service, an order for thirty more cabs.

Moline Agencies.—The Moline Automobile Company, of East Moline, Ill., has appointed these new agents: Cambridge, Ill., P. A. Johnson; Monee, Ill., George S. Miller; Joliet, Ill., O. S. Viner; Walcott, Ia., J. H. Strobben; Coffeerville, Kan., Isham Hardware Company; Bloomfield, Neb., Bloomfield Auto Company; Santa Fé, N. Mex., O. W. Alexander.

Fisk Tires, Philadelphia.—The Bergdoll Company, which is operating thirty taxicabs in Philadelphia, has just closed a contract with the local Fisk representatives to equip all their cabs with 32 by 4½-inch Fisk tires. The Bergdollites have figured that this size tire gives better service on taxicabs than anything larger or smaller.

Mitchell, Pittsburg.—The Pittsburg Mitchell Company is the name of the new firm that will handle the Mitchell cars in this city. The new firm is composed of A. X. Phelan, a well-known Pittsburger, and R. L. Flynn, formerly with the Mitchell agency at Washington, D. C.

Morgan & Wright, New York City.—The business of selling "good tires" has increased so that Morgan & Wright of New York have been compelled to move from their old location at 214 West Forty-seventh street into more commodious quarters. They are now at 1849 Broadway.

Lozier Agencies.—Three new agencies for Lozier cars have been established, in line with a policy of moving into Western territory. They are: Horicon, Wis., Williard V. B. Campbell; Franklin, Pa., Franklin Motor Car Company; Columbus, O., Samuel A. Esswein, 24 West Broad street.

Reliable Dayton, Memphis, Tenn.—A branch house, office, repository and salesroom has been opened at 335-337 Poplar avenue, Memphis, by the Reliable Dayton Motor Car Company, of Chicago. At the opening held recently a large amount of business was done.

Midland, New Jersey.—The agency for the Midland car, made in Moline, Ill., has been taken by E. K. Conover, of Paterson, N. J. Mr. Conover will have the entire State as his field, and from salesrooms in Newark and Paterson will establish sub-agencies.

Continental Tires, Kansas City, Mo.—The list of distributors of Continental tires and tire materials has been augmented by the addition of the Columbus Buggy Company at 810-14 Walnut street, who will have the states of Missouri and Oklahoma.

Trojan Tires, Philadelphia.—The Philadelphia Rubber Tire Company, 680 North Broad street, has taken the local agency for Trojan clincher and solid tires. Samuel Levy, formerly of the Philadelphia Auto Tire Repair Company, is manager.

Matheson, Rauch & Lang, Denver.—F. S. Vreeland is at the head of a new firm formed to handle the Matheson gasoline and Rauch & Lang electric cars in Denver. Headquarters have been secured at No. 1643 Court place.

Petrel, Chicago.—R. D. Loose, who has the Chicago agency for the Pittsburgh "Six," has added the Petrel, a moderate-priced car made by the Petrel Motor Car Company, of Kenosha, Wis., to his list.

Jewel, Chicago and Toledo.—New agencies have been established in the West by the Jewel Motor Car Company as follows: Chicago, S. H. Peterson & Company, 1229 Michigan avenue; Toledo, O., Standard Garage Company.

Nadall, Detroit and Columbus.—The General Sales Company of Detroit has taken the sole representation for the Nadall product. In the future this concern will be represented in Columbus, O., by the Curtin-Williams Company.

Apperson, Pittsburg.—The agency for the well-known Apperson line, including the famous Jackrabbit, has been taken by Wainwright & Bratton, proprietors of the Pittsburg Automobile Hospital.

Columbus Electric, New York City.—The famous firm of horse dealers, Fiss, Derr & Carroll, have opened an automobile department and are the Eastern distributors for Columbus electrics.

Great Western, Chicago.—The Great Western Motor Car Company, the local agent for the Great Western cars, has moved its office and salesroom from 1325 to 1253 Michigan avenue.

Reo and Kisselkar, Beloit, Wis.—George F. Beedle and Allen Daerhammer have formed a partnership to handle in Beloit the Reo and Kisselkar.

Maxwell, Columbus, O.—G. J. Stark and R. F. Baker, composing the firm of Stark & Baker, have taken the agency in Columbus for the Maxwell.

National, Columbus, O.—Robert Boda has signed for the National agency in Central Ohio.

SOME BUSINESS TROUBLES.

New York Car and Truck Company.—Schedules in bankruptcy of the New York Car and Truck Company, manufacturer of automobiles and car trucks at Kingston, N. Y., of which Orlando

F. Thomas of New York, was president, show liabilities of \$496,580, of which \$309,603 are secured, \$7,171 for taxes, and \$2,829 for wages, and nominal assets of \$2,821,742, consisting of factory property and plant, \$2,500,000; actual value unknown, mortgaged for \$308,000; stock, \$86,558; accounts, \$11,885; notes, \$2,450; cash in bank, \$724; office furniture, \$125; and shares of stock in other corporations, \$220,000. Among the creditors are the Morton Trust Company, \$220,000, secured; Trust Company of America, as trustee for bondholders, \$20,000; secured; Hudson Trust Company, \$20,000; Consolidated National Bank, \$72,239; Robert Bernard, \$7,000, secured; H. G. Lewis, \$6,000, and T. J. Lewis, \$6,000.

Cadillac Automobile Company, Indianapolis, Ind.—A fire, starting from an explosion of gasoline, destroyed 14 machines and gutted the building occupied by the Cadillac Automobile Company, 23 East Ohio street. The loss on the building was about \$1,000, while the contents were valued at \$17,000.

Rainier Motor Car Company, New York and Saginaw.—Schedules in bankruptcy of this company show liabilities of \$209,355, as against nominal assets of \$283,818. There are also unliquidated claims for damages aggregating \$89,292, the actual value of which is unknown.

Crescent Motor Car Company, Chicago.—E. C. Buell was recently appointed receiver of the Crescent company, following the filing of a petition in bankruptcy by its creditors. According to the latter, the liabilities aggregate \$10,000, while the assets are only \$6,000.

F. F. Goodman, New York City.—Schedules in bankruptcy of Frederick F. Goodman, Inc., conducting an auto garage at 53 West 93d street, show liabilities of \$14,000 and nominal assets of \$5,476.

RECENT BUSINESS CHANGES.

American Distributing Company, Indianapolis, Ind.—After March 1 the American Distributing Company, formerly of Cleveland, will be located at 207 West South street, Indianapolis, from which point it will continue to act as exclusive sales manager for the Westinghouse Electric & Mfg. Co., Hayes Wheel Company, Lewis Spring & Axle Company, Jackson Drop Forging Company, American Gear & Mfg. Co., Elyria Machine Parts Company, Kinsler-Bennett Company and the Sparks-Withington Company.

Jones Speedometer, Hartford, Conn.—Temporarily, the Jones speedometer is without an office in Hartford. On Tuesday, February 25, fire rendered its branch at 284 Trumbull street, in that city, uninhabitable for the time being, and pending repairs the New York City headquarters will take care of the Connecticut trade.

Morgan & Wright, New York City.—Owing to the large increase in business, the Metropolitan branch of this Detroit rubber house has been compelled to move from its old location to more commodious quarters, at 1849 Broadway, right in the heart of automobile row.

Foss-Hughes, Baltimore.—The Foss-Hughes Motor Car Company have leased the large store at 533 North Howard street, where the salesrooms for the Pierce Arrow cars will be removed as soon as the extensive repairs now being made are completed.

Providence, R. I.—There has been a change in the personnel of the Dauer

Auto Company. George E. Foster is now secretary and treasurer, while W. S. Achorn will act in the capacity of manager. The Franklin agency will be retained.

Boston, Mass.—The Ajax Tire Company, Boston branch, has moved from Boylston street to Park square, near the Motor Mart. C. H. Cooper is the local manager.

C. W. Leavitt & Company, New York City.—After March 20 this firm, dealers in ores, metals and alloys, will be located in the Hudson Terminal, at 30 Church street.

PERSONAL TRADE MENTION.

Harry S. Howlett, who has been identified with some of the largest tire manufacturers in the New England States, has assumed charge of the Jones Speedometer office in Boston. Manager Howlett will promote the Jones interests throughout the New England territory, where he is well and favorably known in the trade. He was formerly engaged with the Diamond Rubber Company, and more recently with the Fisk Rubber Company's Boston branch.

Mr. and Mrs. Firestone Go South.—President H. S. Firestone, of the Firestone Tire & Rubber Company, accompanied by Mrs. Firestone, left Akron this week for a journey to Southern lands, to be gone until April 1. After some days spent in New York, at the Firestone agency at Havana, Cuba, and other points in that island, they will return to Miami, Fla., and sail from there to the Bahamas, returning in time for the speed contest at Ormond and Daytona beaches.

J. Stewart Smith, formerly with Emil Grossman, now as general manager of the Standard Sales Company, has opened New York City offices at 1779 Broadway, at Fifty-seventh street, as successor to the T. C. & W. L. Fry Company, handling the Fry magneto and spark plug.

Ralph P. Dowse, of Chicago, has succeeded to the position of manager of the Detroit branch of the G. & J. Tire Company, taking effect March 1. He is well acquainted in the trade and familiar with the G. & J. tire, having spent several years on the road for that company.

Evans C. Church, who for several years has held the position of assistant manager at the Philadelphia White Company branch, has succeeded Max R. Greene as manager. The latter goes to New York, where he will join the sales force of the Carl H. Page & Company.

L. G. Nilson has been elected president of the Nilson, Miller Company, 1300 Hudson street, Hoboken, N. J. Mr. Nilson was formerly chief engineer for the Strang Gas Electric Car Company and will continue to act for the company in an advisory capacity.

C. J. Connolly is now on the sales force of the Mutual Auto Accessories Company, and will cover the territory formerly covered when he was on the traveling force of the Motor Car Equipment Company.

F. L. Fuller, manager of the Philadelphia Chadwick branch, is back at his desk after a season of recuperation at Atlantic City from a severe attack of typhoid fever.

Charles A. Monson has accepted a position with the Gray & Davis Lamp Company. He was formerly with the G. & J. people as manager of the Detroit branch.

RECENT TRADE PUBLICATIONS.

Pope Manufacturing Co., Hartford, Conn.—The Pope-Hartford catalog has 24 pages. The cover, a masterpiece of its kind, was designed by Thomas Sindelar of New York City. The design represents a female figure draped with a veil, holding in the outstretched left hand a Pope-Hartford car and in the right, a palm branch. The idea conveys speed, the face showing excitement and the veil, motion. In the distant background are factories. The whole is printed in black on rhododendron telanian blue paper with high lights in white and background in gold. The inside illustrations are printed from duotone plates, black over buff, the resulting effect being of a highly artistic and pleasing nature. There is a handsome sub-cover and the inside pages are of "superfine" paper. The treatment of the subject-matter consists of the use of full pages for the complete cars, showing the various touring car, roadster, pony tonneau, and enclosed bodies, while detailed cuts scattered through the opposite pages cover the mechanical features. With the exception of the engine, these are small, but this important part of the car is given nearly two whole pages. By using cuts of this large size, the essential features are made very prominent, allowing a close inspection. Not the least interesting portion of the book is the last section devoted to commercial cars. There both the police patrol and ambulance are pictured and well described also.

H. H. Franklin Mfg. Co., Syracuse, N. Y.—In the wonderfully improved press work being used in the newer catalogues it is hard indeed to select any one feature that stands out more prominently than the others. The 1909 book of Franklin Motor Cars is a striking example of this. Carried through the book is a border effect in very soft tones, these borders being a series of different rural scenes, starting with a broad, tree-lined, winding drive up to a palatial country home and ending with just a glimpse of a car, a Franklin naturally going in a garage. The numerous illustrations depict the parts and features common to all Franklin cars, together with this coming season's line of bodies. The newer details are an X-ray picture of the steering gear, the magneto, oiler, wood frame and clean dashboard. Four full page color plates showing the Franklin "en tour," at a polo game, hill climbing in the fall of the year and the closed car in winter source, increase the artistic effect.

Badger Brass Mfg. Co., Kenosha, Wis.—This new catalogue covering the 1909 product is distinctive in that, aside from the cover, all of the artistic trimmings usual to these are omitted so that the work is a short very business-like mention of the articles manufactured with all of the usual superlative boasting left out. A few pages at the front are devoted to a clear exposition of the Bresnard system of light projection and eclipsing for which this concern has the exclusive rights. Of pleasing appearance to the motorists who do not keep a chauffeur as well as the chauffeurs themselves, is the new black patent leather finish. This is impervious to heat and moisture, besides being fully as durable as any body finish. Mention is also made of the short focus mangin mirror reflectors used on all of the better lamps. An insert sheet describes the new motorcycle headlight recently produced.

The White Company, Cleveland, O.—Bulletin 13, just off the press, the cover of which we show herewith, is as might be judged by the cover, rather an exposition of the factory methods and men behind the car than a catalogue. Insert cuts liberally scattered through this 28-page booklet show scenes in the new shop buildings, machines and groups of machines both idle and at work. These little side lights on a famous product show that there is nothing to hide, even the daily work and the machines that do it being a source of pride. Not the least of the cuts is one of the locker rooms showing the wash-stands. This is right in line with the betterment work being done by all of the larger factories for their own good incidentally, and that of the men directly. A capable description of the plant by R. T. Clegg amplifies the pictures.

National Tube Company, Pittsburg, Pa.—This is really not a catalogue but a description of the process of making Shelby steel tubing. The illustrations are fine on a very heavy book paper and illustrate in full detail the principal operations through which a billet of open-heat steel passes on its way to become a seamless cold-drawn steel tube. Beginning with the view of a pile of steel billets, the process is followed through the centering, piercing, sawing, hot rolling, pointing, cold drawing, and annealing processes. The finished stock, the various shops, and many of the smaller details are expanded and illustrated, also. A very simple and

right-to-the-point discussion or write-up of the whole process amplifies the pictures.

Moline Automobile Company, East Moline, Ill.—The car for anywhere, the Moline Models K and M for 1909, are described in full in the new catalogue. A very attractive heavy brown cover with the word "Moline" in large white raised letters houses it, while between the catalogue and the cover is an attractively designed sub-cover green upon brown. The text in green type with black sub-heads describes the detailed features of these two models, considerable space being devoted to the unit power plant and three-point suspension idea, featured in both. Following the modern trend toward commercial wagons, Model M is also fitted with a light delivery body in place of a tonneau.

Moon Motor Car Company, St. Louis.—The attractive design shown herewith covers the 1909 catalogue of Moon cars. The feature of this is the use of the outlines of the lamps as the two "o's" in the name of the car. The subject-matter itself is equally as attractive as the cover. A very common sense feature appears in this for the first time; namely, the division of the subject-matter into two parts, the first being the general non-technical write-up, and the second the technical description. The larger illustration shows the bodies and completed cars, prominent among which is the new Brevette body, while the smaller cuts illustrate the various units and parts.

Fisk Rubber Company, Chicopee Falls, Mass.—A slightly different catalogue under the name of "Cup Winners, 1908," shows some very effective and tasty press work. The center of each page, the only portion printed upon, is of white and the type black, but the border of each page is of a buff shade. The wide border and different color make the central portion of the page stand out very distinctly. The text refers to the records of the Fisk bolted-on tires and removable rims in hill, road, and track contests during the past season, which the illustrations amplify. Among the interesting photos are the Knox and Thomas Vanderbilt racers.

Stevens-Duryea Company, Chicopee Falls, Mass.—In a small 6x9 catalogue of 32 pages this company has presented in concise and ready reference form the details and specifications of the various models now produced. The six-cylinder constant torque engine is dwelt upon briefly, as is also the unit power plant and three-point support. The four models for the coming year are the big and little "six," continued from last year, and a new "four," larger and more powerful than last season's Model R. Not the least interesting thing in the book is the list of twenty rules for automobiles by Dave Hennon Morris, reproduced in the back of the book.

New Departure Mfg. Co., Bristol, Conn.—The latest catalogue from the press of this firm is a new departure in itself. Besides exploring every possible feature of the New Departure two-in-one bearings by very interesting pictures and well written text, all of the mechanical statements made are proven in foot notes. The latter are written in as simple language as is possible to use and prove the point so that the book will be of equal interest to the technical man or designer and the layman with little knowledge of technical points. The illustrations are well chosen to illustrate the point named.

Continental Caoutchouc Company, New York City.—Is distributing a book relative to Continental Ready-Flated tires, the method of treatment in which is unique. On one page will be found photographs of two letters of recommendation, while upon the opposite page will be found photographs of the two cars in question plainly showing the Continental tires in place. These include many racing cars prominent in the Brighton Beach and Briarcliff races, as well as the new fire-wagon for the Detroit Fire Department. The whole makes an excellent and convincing exposition.

Reliable Dayton Motor Car Co., Chicago.—The first real successor to the horse is the statement or rather the phrase used on the title of this brown cover booklet. The remaining 23 pages are devoted to proving this as well as incidentally enlarging on the good features of construction used in this motor buggy. An insert folder labelled "Pictorial and Written Evidence," has some very cunning pictures of the Reliable Dayton acquitting itself well in bad places, such as hub deep in the mud, through 18 inches of water, deep sand, etc.

Apple Electric Company, Dayton, O.—Bulletin 3 describes the Apple Ignition and lighting system, and Bulletin 4 portable storage batteries. In the former the dynamo-floating storage battery ignition system is illustrated by line diagram and cuts of the parts,

which consist of the dynamo, volt ammeter and storage battery. The second bulletin goes into the details of the battery. This is so made as to be acid proof both outside and inside.

The Cameron Motor Company, New York City.—Sales agent for the Cameron air-cooled car, is distributing a large folder descriptive of their 1909 lines. This includes four models with the usual line of bodies and varying in price from \$900 for the Model 14 four-cylinder runabout, to \$1,500 for Model 11 six-cylinder touring car. The air-cooled motor is illustrated and described in full, as is also the patented transmission, which allows of direct drive on all speed.

Goodyear Tire & Rubber Company, Akron, O.—This 9 by 12 pamphlet is not exactly a catalogue, but rather an expansive exposition of the idea pictured on the cover. This is in the nature of proof of and reasons for the statement, "We need the dealers and the dealers need us." The air-bottle, red seal inner tube, universal rim, and other features shown on the cards are enlarged upon in language that should be very persuasive to the dealer contemplating a move or a change in this line.

Columbia Lubricants Company, New York City.—A pocket-sized book of 32 pages is offered as "evidence" of the reliability and efficiency of Monogram oils. This is a series of pictures of famous races and equally famous drivers with commendatory letters from the latter relative to the performance of "Monogram" in these races. A couple of new pictures of the Savannah course, Robertson driver of the Vanderbilt winning Locomobile, and others are of live interest.

The Waverly Company, Indianapolis, Ind.—is sending out a neat little booklet descriptive of the Waverly electric carriages. This is 5x6 in size, printed on a heavy book paper, and covered with blue on which the gold letters stand out very effectively. The full line as described is too extensive for mention here, so it will suffice to say there is a car for every need. The driving system, the controller, and some other mechanical features are lightly touched upon.

Olliver & Worthington, San Francisco, Cal.—The special pocket edition of the 1909 catalogue of automobile and motorcycle supplies is 4x9 in size, designed to slip in the side pocket. This firm handles Merkel motorcycles, Breeze carburetors, Champion ignition supplies, and the product of many other prominent accessory and part manufacturers, on the Western coast. The catalogue itself of 112 pages describes these products in detail.

Eck Dynamo & Motor Company, Belleville, N. J.—is responsible for a flexible leather-covered catalogue of pocket size with provision for additional sheets. Those included within the covers for present distribution are descriptive of the d.c. dynamos and motors built by this firm. Other leaflets up to 54 in number describe the company's other products, which are converters, fans, switchboards, and other similar electrical products.

R. B. F. Ball Bearings.—The International Engineering Company of New Jersey presents the 1909 catalogue of the Société Française Des Roulements A Billes, whose radical and thrust ball bearings sell in this country. Tables of sizes in both millimeters and inches are given, as well as instructions for mounting and a very complete table of equivalents. This firm also has the agency for the well-known Lemjone products.

Gaeth Automobiles.—Pictures have been made to tell the story of the Gaeth, the cover of the pamphlet issued under the title of "Advance Showing, 1909," having its front cover appropriately illustrated with a view of the Gaeth entry in the last A. A. A. tour, while its perfect score certificate is reproduced on the back. The contents consists largely of illustrations of the different Gaeth models.

Stromberg Motor Devices Company, Chicago.—is distributing a simple little leaflet showing Type A&B carburetors in view and in cross section; the latter explaining the detailed construction of these very successful devices. Both types are fitted with glass foot chambers, venture shaped internal walls for the vaporizing chamber and other distinctive Stromberg features.

The Empire Automobile Tire Co., Trenton, N. J.—This is a calendar which is being distributed gratis to the trade. The design is an Empire tire in black upon a pure white ground. Within the tire is a large pure white cat, the lettering being "nine lives. Empire tires wear longest." It is an unusual and effective piece of advertising.

Patterson, Gottfried & Hunter, Ltd., New York City.—dealers in machinery hardware, tools and supplies have recently issued a new catalogue of automobile tools, a copy of which may be had from them for the asking.

THE AUTOMOBILE

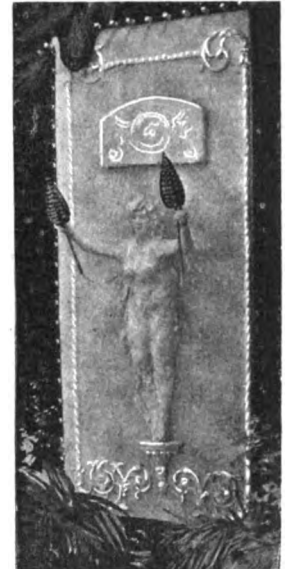

BOSTON, March 10.—This city's automobile show success is always spelled with a big S, and this year is no exception to the rule; if anything, the present show so far has exceeded all its predecessors in attendance and business transacted, and everybody who has space is optimistic over the interest that has been demonstrated since the exhibition began. On the opening night there was a tremendous attendance; as many people crowded into the building as it possibly could hold. Aisles and spaces were so thronged that it was next to impossible to see anything, and it is estimated that more than 40,000 people passed the ticket takers. First-night attendance, however, signifies little except general public interest, and the sales which were reported were mostly those which had been worked up to the signing point before the show began.

With the first of the week, however, began the real business of the show, and it was apparent Monday that all previous records would be broken, for there was a heavy attendance from the time the doors opened, and all day long the salesmen and demonstrators were kept hustling with prospects who took a genuine interest in the cars. Reports of sales were made with unusual frequency and with more ring of genuineness than is customary. Not a few exhibitors have already secured customers for all the cars they have on exhibition, and have taken orders for many duplicates. Even those concerns which have

come to the Boston show with new cars, not previously exhibited here—and there is a larger number than in any former year—are well satisfied with what has been accomplished thus far, and are encouraged as to the business outlook for the spring season. There seems every reason to believe that any make of car which can demonstrate reliability and good riding qualities will not lack for patronage this season in New England.

Boston usually has some novelties to offer, and this time they are very plentiful. There is a compressed air car, for instance, a decided novelty that has not been exhibited elsewhere. This machine has a two-cylinder air-cooled horizontal engine in front, combined with which there is an air compressor and a superheater. The superheating is accomplished by means of the exhaust and the superheated compressed air is delivered to a four-cylinder air motor which in turn drives the car. The advantage claimed for this method of operation is economy and the absence of such complications as gear transmission and clutch. The air motor is used for braking purposes, but the car also has an emergency brake as a part of its equipment.

Another new car is the Panther, a little single-cylinder machine listed at \$300 and equipped with a disc clutch and gear drive. The Jewel is a third new machine in Boston. This car has a single two-cycle cylinder rated at 10 horsepower and is listed at \$500. The Pickard, Herreshoff, Hupmobile, Velie,



The Efficient Corps of Pages that Was Uniformed in Scarlet and Black.



Taking In the Exhibits from Rear of Mechanics' Hall.

American Simplex and Brownie cars are also newcomers to this city. Then there are a number of cars, which were shown in New York but which have not previously been shown in Boston, such as the Inter-State, Oakland, Lancia, and Pittsburg Six. An unofficial count puts the total number of different makes of cars on exhibition at eighty-two, which is believed to be a record for any show in the country. The representatives of these eighty-two makes are exhibiting about two hundred and seventy-five separate cars, the count including chasses and all the different types of pleasure cars.

In popularity of type the standard touring car easily leads, and it is a noticeable fact this year that the exhibitors are putting the five- and seven-passenger touring cars in the conspicuous places of the spaces, instead of featuring the toy tonneaus, baby tonneaus, double rumbles and other fancy styles. Next to the touring cars the roadsters are popular, but practically every exhibitor states that the larger number of show visitors is looking for cars that will carry the whole family rather than for sporty vehicles. The Boston show is a little late for enclosed bodies, so there are not as many limousines, landaulets and town cars in evidence as there were at some of the previous shows this season, but in quite a few exhibits there are some handsome enclosed bodies. One of the most striking of these is that ordered by the actor, Nat Goodwin, for his bride. It is on a six-cylinder Welch chassis and is an enormous affair equipped with bath tub, bunks and all sorts of conveniences to enable its owner practically to live on the road.

In every department the Boston show is larger than ever before, and this is especially true of the commercial vehicle section in the basement. The commercial vehicle is experiencing what is expected to develop into a good-sized boom in this city, and the manufacturers and agents are aware of the possibilities in this direction and have put on view an exceptionally fine lot of vehicles ranging from a light delivery wagon to immense five-ton trucks. Not a few of these vehicles are to be delivered

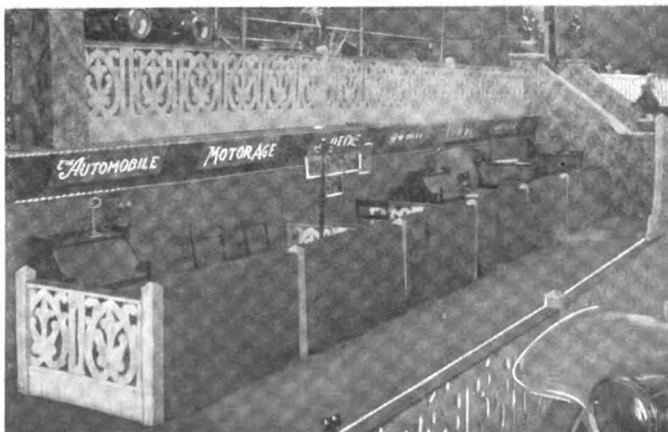

Where the Leading Trade Journals Were Quartered.

to local houses as soon as the show is over, and the names of these concerns on the trucks is somewhat of a revelation in the way the commercial automobile is being taken up. One of the best exhibits is that made by the Rapid, consisting of a large number of complete vehicles and chasses. The Studebaker Company, D. P. Nichols & Co., General Vehicle Company and Knox are also large exhibitors in this section. The motorcycle division is more extensive than it has been in other years, more different makes of the two-wheelers being shown than were exhibited at either of the New York shows.

Every year the accessory division grows, and Manager Campbell had difficulty in taking care of all who wanted show space this year. He drew a line against all applicants unless their goods were actual accessories, but even at that all the balcony spaces and not a few in the basement are occupied. The tire exhibits are larger and more numerous than has ever before been the case in Boston, and practically every leading manufacturer of speed-measuring instruments, oils, shock absorbers, lights, warning devices and the like, has space, and all claim to be well satisfied with the attention their exhibits are receiving from the show visitors. Even those exhibitors who by force of circumstances were crowded away into the most inaccessible corners say that people are seeking them out and are taking extraordinary interest in what they have to show and say—all of which demonstrates that the New England public is not only auto-wise but auto-enthusiastic.

There is a very good representation of foreign cars at this show, though the New York importers have not given the Boston exhibit as much attention as they do customarily. The Fiat has the finest display of foreign machines that has ever been made here, with the Lancia a close second. The Renault has an excellent showing of cars, and the Panhard branch is exhibiting two machines. The new American Napier, which is being turned out by the reorganized Napier Company of America, attracts a good share of attention. Very little has been heard of this car for a year or more, but it is said that the company is now in a position to go ahead and manufacture machines in quantity.

Manager Campbell is looking forward to closing the show next Saturday night with a larger net profit to the credit of the Boston Dealers' Association than at any of the previous six shows given here under its auspices. The first of the week attendance is largely from Boston and vicinity, but before the week ends, with continued good weather, there is every probability that there will be a very large throng of people from Maine, New Hampshire, Vermont and western Massachusetts.

The extra features of show week have been numerous. Tuesday evening Paul Revere Hall was thronged with members of the Bay State Automobile Association and their ladies at the ball given by the association. This was the first attempt of the show management and of the Bay State to hold a social affair in which the ladies participated, but it was a thorough success. Dancing began at 11 o'clock, a half hour after the close of the show, and it was not until an early hour Wednesday morning that it ceased, and the dancers went home in the limousines and taxicabs. To-day has been a very busy time at the show. For one thing, it has been dollar day, when the exhibitors expect to meet their choicest prospects, and therefore have been keenly alive to the possibilities of every visitor at the spaces. Secondly, it was motorcycle day, and motorcyclists from all parts of New England, and not a few from New York, were here. Thirdly, the executive committee of the American Automobile Association held its annual meeting in Mechanics' Building, and everybody was on the *qui vive* to see if any action would be taken in regard to the Glidden tour or other important matters.

To-morrow (Thursday) the feature is the run from New York to Boston, in which many cars have been entered. The cars will leave New York at 8 o'clock in the morning and are expected to finish here in the early evening. Incidentally there are not a few trade dinners and other social affairs on hand to take up the time of the exhibitors after 10:30 at night.

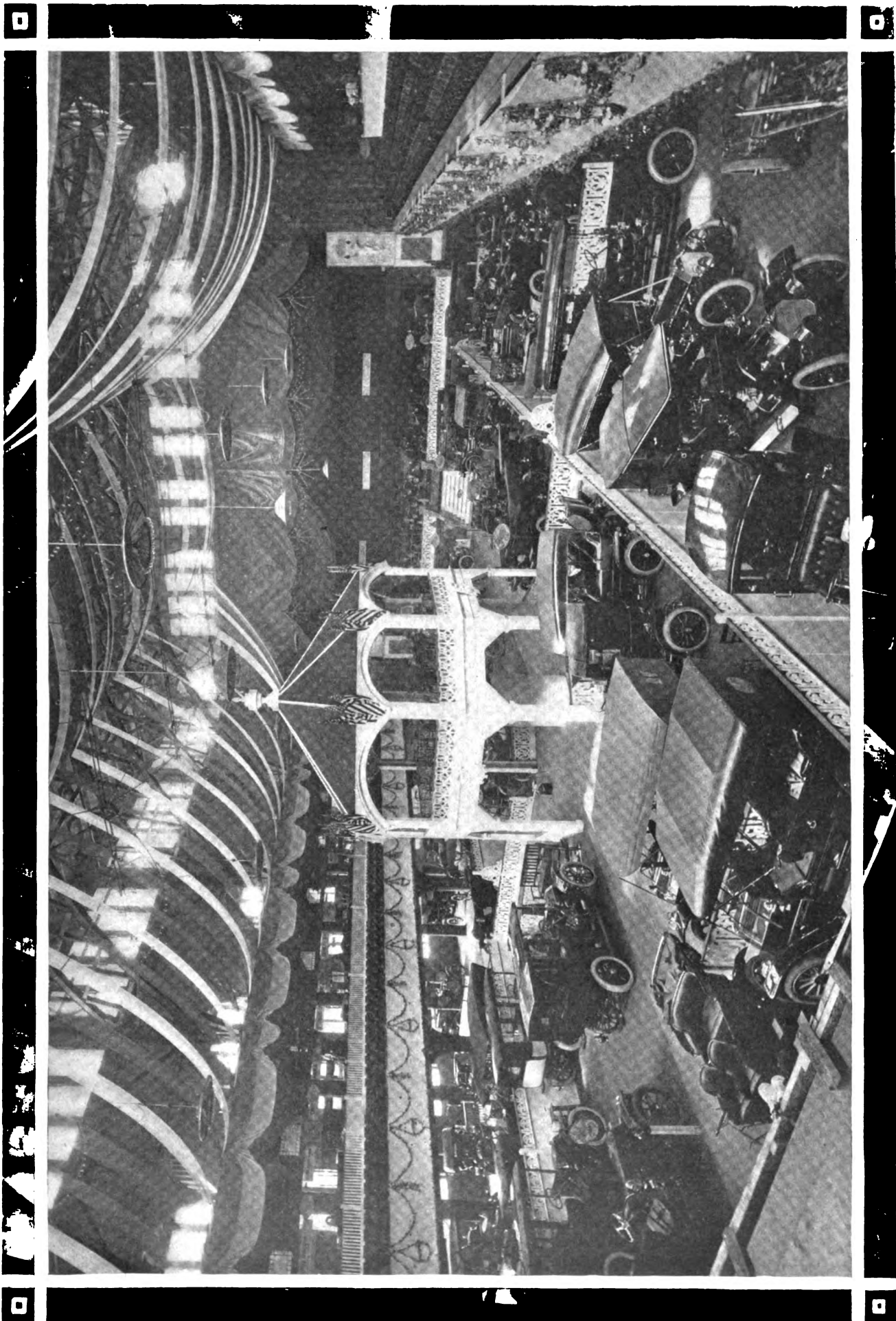

From the Huntington Avenue End of the Main Hall the View Was Impressive—a Fitting Culmination of the Season's Great Industrial Exhibits.

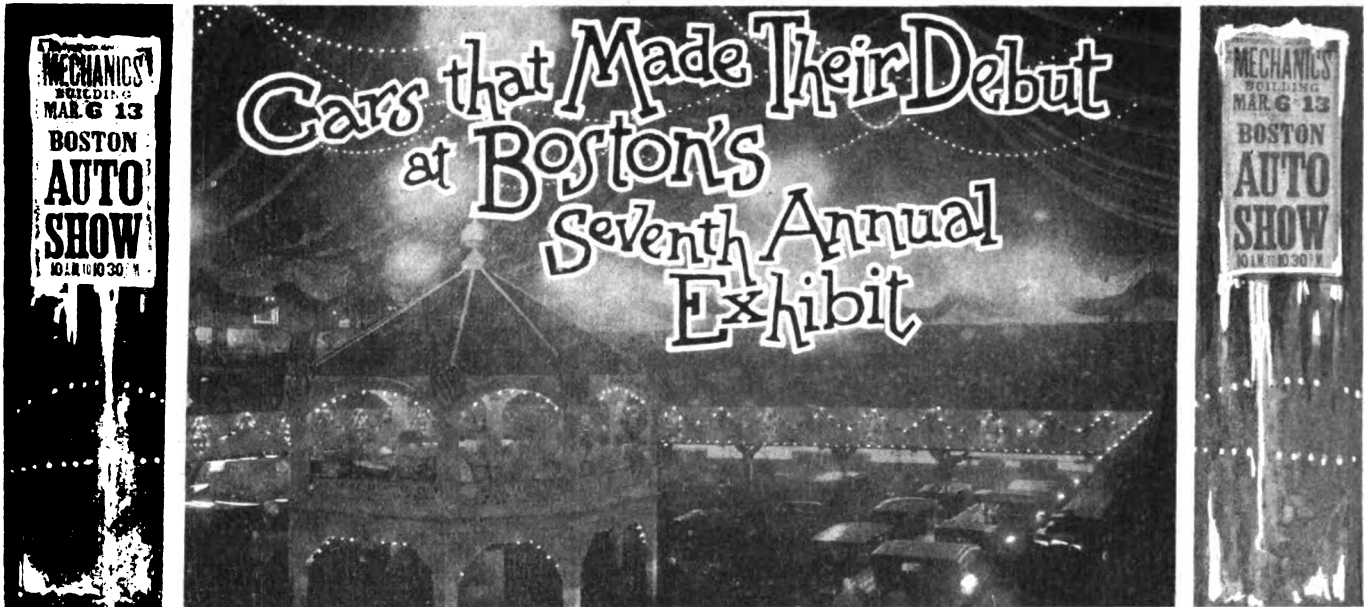

The Reflection of Thousands of Brilliant Lights at Night Mellowed the Decorations with a Soft Glow.

PYRAMIDED superiority is the summation of the increments for quality, eked out of all the cars, but the height of the pyramid, and its nice proportions, gained immensely at the Boston show, due to the presence of cars of splendid promise, exhibited for the first time, braving the metropolis of the sagaciously conservative, at small risk of adverse criticism, due to the enlightened state of automobile designing on the one hand, and the profusion of superior materials to be had for the asking.

Buyers of cars have automatically contributed a large quota to the success of the ventures in that they now know what is best for use, and it is but to supply definite wants when new cars are projected into the arena of popular favor. Because builders, and buyers, alike, understand the situation perfectly so-called freaks and slants at odd angles from the designer's point of view are not indulged in, and it was regarded as distinctly elevating to go into the Boston show for no other purpose than to critically examine the newcomers, basking in the sunlight of conservative features, strong with good materials and bristling with that formidable array of armament, beaten into form sublime in the smithy of simplicity, launched in a sea of art.

Napier, American Napier Company, Boston.—Perhaps the new 40-horsepower Napier is so much in line with the generally well-known characteristics of the "parent car" that its presence at the show indicated the usual interest rather than something to be called by a new name. At all events, as the illustrations here offered will show, the reasons for the keen interest taken in the Napier exhibition are too good to require comment. As a light-weight automobile of vast endurance and great flexibility, the new model struck a responsive chord in the hearts of the buyers of Boston, and with such features as Bosch magnetos of the latest and most approved type, for the ignition system, coupled with the utility of the new Hoyt carbureter (designed by Superintendent F. C. Hoyt, of the company), the situation looks pleasant. But the Napier company proposes to go far beyond the mere production of a standard touring car, and in the making of the roadster type all the so-called innovations of automobiledom will be boiled down to absolute finality before they can fit into a description of this Napier creation. The future of the company will be to the tune of a new light delivery wagon, and it is whispered about that the new "compressed air" exploitation will make for history in transmission systems in some Napier cars.

Compressed Air Power Company.—The novelty of the Boston show was conceded to be the landaulet, as exhibited by the above-named company, in which compressed air is the transmitting medium; the prime source of power being a gasoline motor. What the company aimed at was flexibility such as can

never come with the use of sliding gears and the car, as it was seen at the show, impressed the spectators as being the product of experts with definite ideas of what they want to accomplish.

The installation includes an air-cooled gasoline motor, cooled by the exhaust air, from the air-power motor, it being the case that the exuding air from the power motor is cold enough to form ice if it is expanded from pressures such as can be used, and it follows that there is a wealth of a cooling medium with which to keep the air-cooled gasoline motor at any desired temperature. The gasoline motor drives a compressor, and the compressed air derived therefrom is passed through a "re-heater" so that it enters the air-power motor at high heat and pressure furnishing power to the road wheels of the car.

The high pressure heated air is enabled to expand to a low point without "icing" the valves, and the economy resulting is very high, indeed. The air-power motor, like a steam engine, will run in both directions, and power can be realized at all speeds. Regulation is precisely on the same basis as would be the case with a good steam engine and as a result transmission gears are not needed at all. Plainly, then, the flexibility which is present in steam practice is expected in connection with the car as fitted with the air system, which reports seem to agree with.

The exhaust air is available for all auxiliary purposes as inflating tires, blowing the horn, and, as before stated, in cooling the gasoline motor. The equipment has attracted much attention, and it is said that the Napier Company of America will fit out some cars this year with the compressed-air power plants of this make. Frank Lester, whose experience in this line dates back for some years, rushed the first car to completion for the Boston show, beginning last Thanksgiving Day at the plant of the Atlantic Works, East Boston.

Herreshoff, Herreshoff Motor Company, Detroit.—The makers of the Herreshoff state that their car was designed primarily for the owner of a heavy car who desires in addition a machine suited for fast city and suburban work. A heavy car in congested traffic is often in the position of the proverbial bull in a china shop; it blocks the street every time it turns around, if it is true that it can be turned around without backing and filling, so to speak, several times, due, as it is well understood, to the law governing the turning radius of all automobiles, in which wheelbase and angle of the front road wheels, as they are canted for turning, render the problem easy, or not, depending upon the details of design present. A light car suffers none of these disadvantages; of comparatively short wheelbase, it is adapted for a quick turning radius, and its light weight alone

makes it easily checked or accelerated. The Herreshoff motor has four cylinders cast in pairs, of 3.3-8 inches bore and 3.3-4 inches stroke. It is designed to run at from 200 to 2400 r.p.m., and is rated at 24 horsepower. The crankcase casting is extended rearward to include the flywheel and the gear box, the essentials of the power plant thus forming a single, compact unit on a three-point suspension. The motor is fitted for double ignition, but the magneto is listed as an extra; cooling is by a vertical tube radiator with thermosyphon circulation. Power is transmitted through a 25-disc steel-on-steel clutch to a three-speed gear of the progressive type. The gears are of projectile steel, cut to insure absolute quiet and non-stripping. The drive shaft is enclosed in the torsion tube, and has a single joint of the spherical square type. The torsion tube has diagonal braces extending from the joint to the rear spring seats.

The running gear includes a live rear axle with floating shaft and a drop-forged I-section front axle, both carrying 32-inch wheels with 3.1-2-inch tires. Brakes are internal and external on the rear hubs; a single pedal controls the clutch and the service brake by a progressive motion. The chassis is fitted either with a five-passenger touring body or a neat rumble runabout. Herreshoff cars are handled by the French Carriage Company, 92 Summer street, Boston.

Pickard, Pickard Bros., Brockton, Mass.—This car made its debut "at home" and the Model E runabout at \$750 measured for supremacy with a long steel tape, most accurately graduated, so the story goes. In this car the front axle is of manganese bronze, of the I-section, nicely proportioned. It will be remembered this is the famous bronze which costs several times the price of steel, and the strength of the bronze is 80,000 pounds per square inch tensile strength, with an elastic limit of 36,000 pounds per square inch. The rear axle is of the live floating type fitted with ball bearings, light, strong and with good ground clearance under the differential housing. The motor is air cooled and is rated at 25 horsepower and rests on a sub-frame, taking its mixture from an automatic carbureter, exhausts into a muffler which renders the exhaust silent, but the performance is in the absence of any back-pressure; 20 gallons of gasoline will fit in the tank and it is ignited at the propitious instant through the good office of a coil of suitable quality using electricity from dry cells. With a rated speed of 50 miles per hour, in view of the commodious body and upholstery that ranks with comfort, it is easy to account for the unusual state of affairs which makes the Pickard "a prophet at home." The South End Car Company holds the agency for the Pickard and it looks like a happy combination.

Hupmobile, Hupp Motor Car Company, of Detroit, Mich.—Entered the show for the first time, but by no means as a stranger, due to the facility with which news travels and the splendid home performance of the cars of this make. The 16-20 Hupmobile is distinctly different, made so for a purpose. Briefly, this car is low in power, but it is also low in

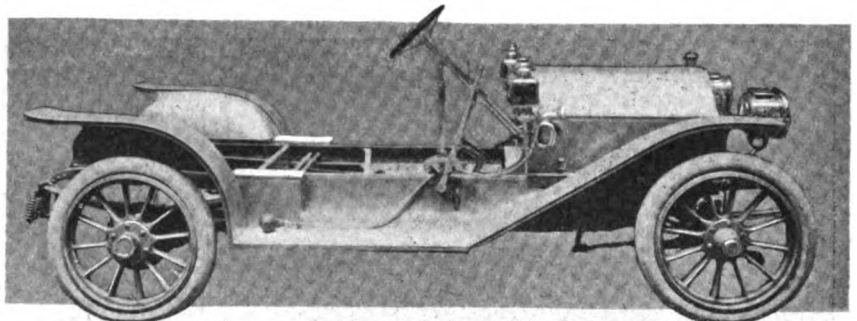

Napier 40-Horsepower Chassis—American Napier Co., Boston.

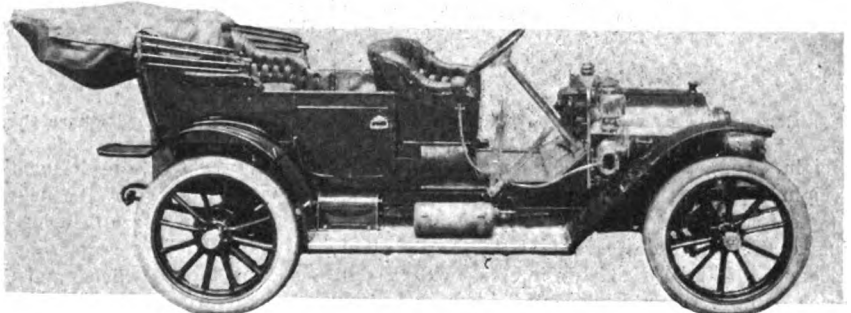

Herreshoff 24-Horsepower Car—Herreshoff Motor Co., Detroit.

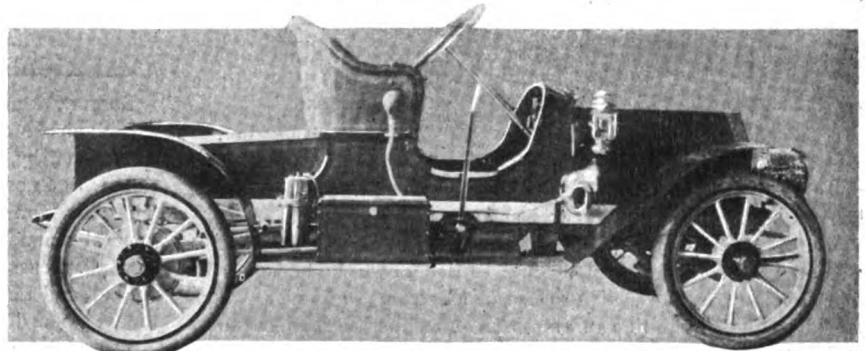

Pickard 25-Horsepower Air-Cooled—Pickard Bros., Brockton, Mass.

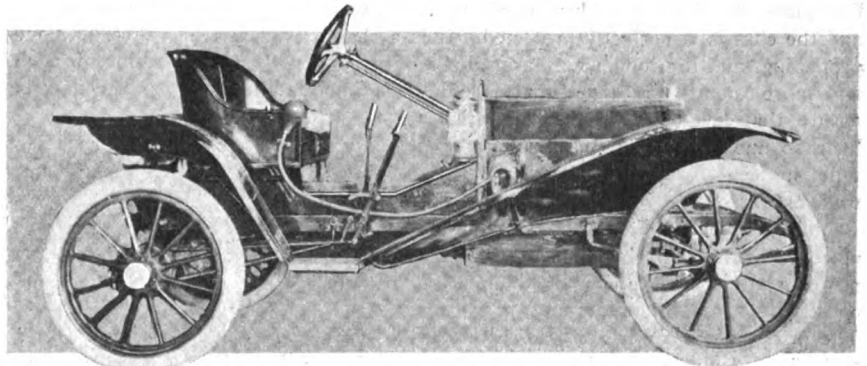

Hupmobile 16-20-Horsepower—Hupp Motor Car Co., Detroit.

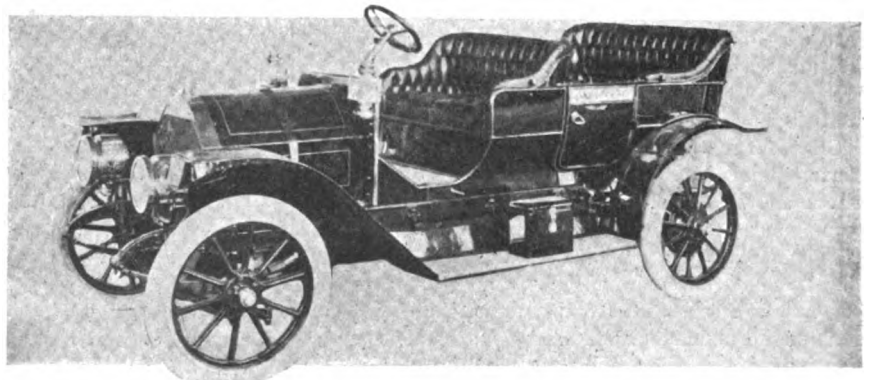

Velle "30-Limited"—Velle Motor Vehicle Motor Co., St. Louis.

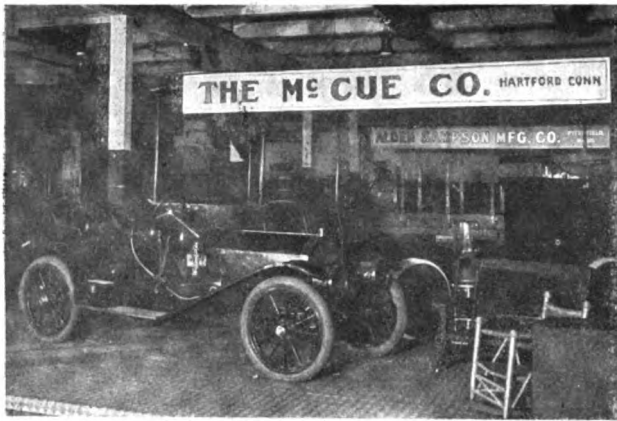

Connecticut's Newest Car—The McCue, from Hartford.

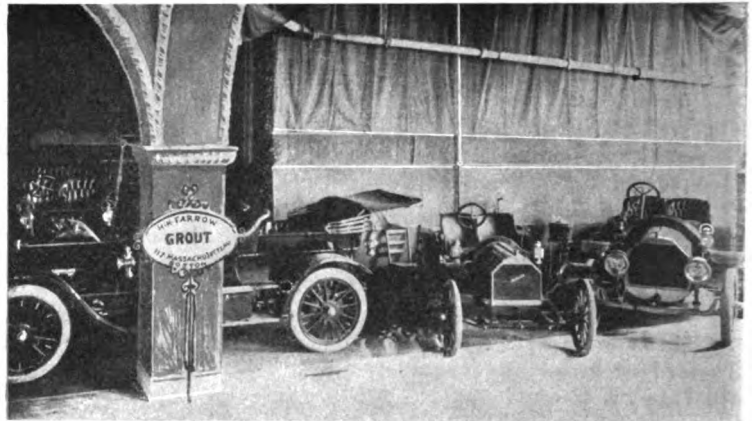

Where the Grout Cars Were Displayed by Agent Farrow.

weight. It is, therefore, a big automobile since the reduction in weight is not at the expense of cramped quarters within the ample folds of the splendid body that graces the chassis. Looking at the "Mercedes" front of this car, glistening in its simple elegance of design, excites interest with a dull sense of high price, which feeling is dispelled when the genial salesman pronounces the sentence "The price is \$750." The car weighs 1,100 pounds, is of absolutely conventional design, with channel section steel side-members, half-elliptic springs on front, three-quarter platform springs to the rear, shaft drive, with two sets of splendid brakes, and the water-cooled motor is fitted with a Breeze carboreter, while the cooling is done with a tube radiator of very neat and substantial design. It is needless to point out that the propeller shaft is provided with protected universal joints and that the car as a whole is a sure cure for skeptics. Henry F. Farrow is the agent, at 117 Massachusetts avenue.

Velie, Velie Motor Vehicle Company, Moline, Ill., entered Boston with the "30-Limited" and settled down to be admired. The touring car of the line sweeps back from the cooler, which starts on the center line of the front axle, just as modern automobile designing demands, and the flare of the mud-wards has the advantage of being good; they look like business, too. In the first place, the shape is such as to allow one to work on the tires and the chassis is perfectly protected. It is a chassis well worth protecting, and the long wheelbase allows of a body with room, and more room. The three-quarter elliptic springs in the rear assure that level platform about which we hear so much, and the steering gear is not only in fine form, but the materials, as well as the way of their use, augurs for stability. The hood is of nice shape held in place with straps of heavy section, and the power plant, nested under the bonnet, is a consistent and "sweet running performer." The price of the car is \$1,750, ready to run, and sharps, who keep tabs on such things, say "the Velie has a clean pair of heels." The rest of the company's line included a roadster, low, long and rakish, light, lythe and takash. The Boston end is handled by Kilbourne Corlew Motor Company, located at 26-28 Bowker street.

Chas. Waugh & Company, Cambridge, Mass.—The American one-ton delivery wagon and five-ton truck and the Commercial 1000-pound electric wagon comprise the line of commercial cars exhibited at this stand. The truck is driven by a four-cylinder, 40-horsepower motor with separately cast cylinders, placed under the footboard. Transmission is through an inverted cone clutch, two-speed planetary gear and side chains. The construction seems substantial, as is fitting,

considering the load to be carried; the rear axle is a solid steel bar, 2½ inches square, and the pressed steel side bars of the frame are 6 inches deep. The delivery wagon carries its motor under a regulation hood; the cylinders are cast in pairs with opposite valves, and the change-gear is of the three-speed selective type. The Waugh Company also makes cape and canopy tops, and does a considerable business in making parts to order from original designs and in reconstructing and remodeling.

AMERICAN NAPIER COMPANY REORGANIZED.

Boston, March 8.—With the consent of all the stockholders, the Napier Motor Company has been reorganized as, or rather superseded by, the American Napier Company, a Maine corporation with \$1,000,000 capital, most of which has been written up. The new company is headed by Otto B. Cole, as president and general manager, with M. C. Barnard, vice president, and Fred L. Hall, treasurer. These three, with Wm. H. McMasters, Joseph Ellwell and Leon Pettit, Jr., constitute the new board of directors, the old board having resigned.

The plant of the older concern, at Jamaica Plain, Mass., has been acquired, put in working order and some additions started, among which is a three-story machine shop. A number of men have been put to work and the factory is busy getting out machines for spring and summer delivery.

The new company will have the same arrangements with the English Napier Company as did its predecessor in the way of contracts and patent rights. Consequently, the output will be patterned along the line of the latter, although by no means as extensive. This will include the new 40-horsepower four-cylinder model as exhibited at the Boston show, a medium-priced light weight roadster, a taxicab model and possibly a new style of light delivery wagon. As light weight is the Napier slogan, the details of the roadster are awaited with great interest, the larger car at the show having shown up well.

Among the features of the cars will be the rear axle construction, double ignition with Bosch magneto as the principle source of current, and a special carbureter invented by Superintendent F. C. Hoyt. A few cars will also be built using the compressed air type of transmission; in fact, the Compressed Air Power Company has been given an order for the transmissions.

The details of the New York City branch are being arranged, as are also other branches. For the convenience of Boston owners, a shop repair department has been established.



Manager Campbell consults the Telephone Directory

WHAT LEADING NEW ENGLAND ACCESSORY MAKERS HAD TO OFFER

Atwood-Castle Company, Amesbury, Mass.—Gas and oil lamps of all kinds and sizes may be seen at this exhibit. One of the new gas headlights is made especially to harmonize with the straight-line bodies now in vogue. Its lines are simplified as much as possible, and the ventilators in the hood are made diamond-shaped, giving an unusual and distinctive touch to the lamp. Not to show any partiality, however, the company shows another lamp in which not a single straight line is to be found, while curves riot in luxurious abundance. All lamps can be furnished in the popular black finish at a slight extra charge.

Allen Fire Department Supply Company, Providence, R. I.—The Allen two-port carbureter seems to go back to first principles in some respects, as it embodies a positive control of the vapor and auxiliary air operated directly by the throttle. The device gets its name from its two parallel passages, one for pure air, the other containing the spray nozzle. The throttle is a flat plate with suitably shaped openings which slides over the upper ends of the two passages and opens them in proportion to the speed. In this way a high degree of simplicity is attained; there are no springs to be changed in tension by heat or long use, no diaphragms, no dash pots or sensitive valves. The device seems substantially built, and with proper proportioning of the openings, which no doubt has been attended to, it should give good satisfaction.

Bi-Motor Equipment Company, Boston.—The difficulty often found in arranging a tail-light to light up the rear number tag is obviated by an electric device shown at this stand, which may be attached to any part of the car. Those who own machines with extra long tonneaus will find the comfort of their passengers increased by a folding foot-rest, also made by the Bi-Motor Company. In addition to a full line of accessories this company handles the Pfanstiehl coils, which are new to the Eastern market. These are of the same design as the coils used in x-ray work, and give what the makers call a "caterpillar flame." Any Pfanstiehl coil unit, with a ten-volt current and

an x-ray tube, may be used to produce x-ray. The coils are tested on a 16-volt current.

Boston Auto Gauge Company, Boston.—The "Triumph" tank gauge is claimed to be unique in that it necessitates no hole through the wall of the tank, and breakage of the glass will not cause a leak. The interior part of the gauge consists of a tube with a spiral slot, with a float inside which engages with the slot so as to turn with every rise of the level in the liquid. The float carries a small magnet, and the gauge needle, being itself magnetic, follows the movements of the float on a graduated scale. Another form of the gauge may be fitted to the dashboard.

Burn-Boston Battery Company, Boston.—This company shows a new type of wet primary cell, intended to replace dry batteries. These batteries are square in shape, and it is claimed that they lose no current when not in use and will not dry up or freeze. Its freedom from deterioration makes it especially adapted for use as an auxiliary with magnetos, as ordinary batteries when used in this way waste more current than they give. The amperage is about the same as that of an ordinary dry cell. The company's headquarters are at 9 Duane street, Boston.

L. C. Chase & Company, Boston.—All kinds of fabrics for automobile use are shown at this exhibit, but the specialties are mohair mackintosh, rubberized cloth and "Chase leather," for covering folding tops and slip covers. The rubberized fabrics are made in both single and double texture, in a variety of grains and finishes. In double texture these fabrics make an unusually reliable top material, as they contain two thicknesses of cloth with a rubber proofing between, and a second rubber coating between. The company's offices are located at 89 Franklin street, Boston. A folder is being issued containing samples of the different fabrics.

Coates Clipper Mfg. Co., Worcester, Mass.—Autoists who take pride in the neat appearance of their brass work will be interested in the Coates auto buffing outfit, which with a mini-

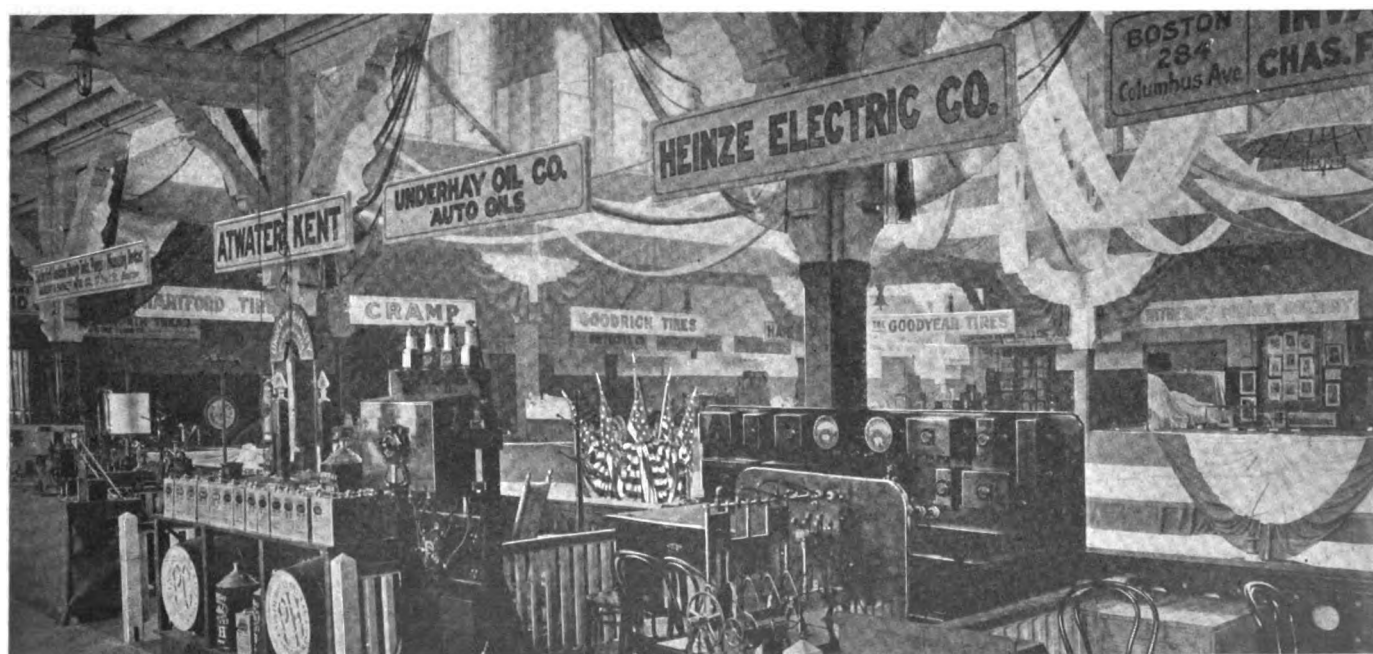

Most of the Accessory Exhibits Were Admirably Situated In the Spacious and Well-lighted Gallery.



Where the Atwood-Castle Lamps Were Quartered.

num of labor will enable him to use his lamps as mirrors. The outfit is driven from the right rear wheel of the car, previously jacked up, and sufficient length of shafting is furnished to reach the headlights without difficulty. The same outfit with a drill or an emery wheel in place of the buffer may be used for drilling or grinding. Coates flexible shafting is made in sizes to transmit from 1-10 to 150 horsepower, and may be used in connection with anything from a speedometer to a heavy machine tool. The exhibit included an emery wheel turning 21,000 r.p.m., and a number of drills and other tools driven by electric motors on the other side of the stand, the connecting flexible shafts giving the place the appearance of the cageful of boa constrictors.

Coes Wrench Company, Worcester, Mass.—One of the features of this exhibit is a massive Coes "steel handle" wrench at least four and a half feet long, which lies on the desk in front of the stand and rarely fails to attract the attention of passers-by. It certainly was not intended for automobile work, as it would require a tool box as big as the car itself to carry it. Of much more practical interest from the autoist's point of view is the new four-inch wrench, which weighs but seven ounces and opens 13-16 inch. It is just the size for the many small nuts



An Aisle in the West End of the Main Building.

on the carbureter and ignition system, and is especially adapted for motorcyclists' use.

J. W. Colgan Company, Boston.—Not only do demonstrators and agents usually desire to have the name of their car prominently displayed on the radiator or running board, but there is a rapidly growing custom among private owners of giving their cars an individuality by the use of monograms or crests. The Colgan Company, Sudbury Bldg., Boston., makes a specialty of this sort of work, and their monograms are original and distinctive in style. It also makes medallions to be attached to robes and other loose impedimenta. The exhibit includes specimens of the different styles, and an illustrated booklet is also issued. In addition to these, any design can be made to order.

Couch & Seeley Company, Boston.—A scale no less than 28 inches long, with individual 5-16-inch figures for each mile, is the distinguishing feature of the Casgrain speedometer made by this company. The device itself is of distinctive form, consisting of a horizontal cylinder intersected near the right-hand end by the vertical drive shaft. The right-hand portion contains the trip and season odometers, and the larger left-hand portion the speedometer proper. The figures appear through an aperture in the case, and no more than three can be in sight at one time. The principle is novel; a horizontal shaft carrying paddle blades rotates in a liquid in the center of a cylinder carrying the figures of the scale arranged spirally. The friction of the rapidly moving liquid then carries the scale cylinder around with it against the tension of a spring. As there is no mechanical connection between the driving mechanism and the scale all inaccuracy from wear is eliminated, and careful precautions are taken to insure against the escape of any of the liquid. The instrument is compact and of neat appearance.

Dover Stamping and Mfg. Co., Boston.—Sheet metal specialties of all descriptions form the basis of this exhibit. There are oil cans and oil guns of every shape and size, long spouts, short spouts and no spouts at all. The stand is walled in with galvanized iron drip pans, to be placed under the cars in garages. The pans receive all drippings of oil and gasoline, and not only keep the floors clean but considerably reduce the danger from fire.

Essex Brass Foundry Company, Cambridge, Mass.—As its name indicates, this company makes brass castings for all kinds of automobile and motor-boat use. One of its specialties is a patented folding-top support, which provides a resilient support for the bows of the top when folded down and prevents their breakage. It is made of manganese bronze and highly finished. Steering wheels and propellers for boats and door handles, foot rests, robe rails and other fittings for autos are also shown.

Federal Mfg. Co., Lowell, Mass.—The makers of the Rex storage batteries have put on the market a spark coil known as the Bliss, a feature of which is a new torsional vibrator. The vibrator points are made of a special iridio-platinum alloy to obviate pitting. The cases of the unit coils are of hard rubber and provided with anti-induction shields, which prevent the activity of one coil from exciting a current in its neighbor—often a cause of irregular firing. The coils are said to operate one 1-10 ampere.

Ernest Flentje, Cambridge, Mass.—Flentje shock absorbers are built on the same principle as the glycerine recoil checks used on 12-inch cannon. They consist of a cylinder and piston, one to be fastened to the axle and the other to the frame of the car. The cylinder is filled with glycerine, and the piston has bored in it six holes, two small and four large. All are open when the piston goes down, so that the downward motion is unchecked, unless it becomes too violent; but on the return stroke the large holes are closed by check valves, so that the glycerine must all pass through the two small ones. This makes a very effective damper on the rebound of the springs. The devices are made of phosphor bronze and steel, the cylinders being fin-

ished in nickel, while the hangers may be painted to match the rest of the car.

Gordon Auto Supply Co., Boston.—This company shows an extensive line of automobile supplies, among which may be noted the Whittaker tire chain. The cross chains of this device are made of hard steel wire, hand-welded, and copper-plated. The side chains are fitted with snap hooks, which simplify putting on and removal. The Gordon company is also New England distributor for the Geiszler non-sulphating storage battery.

Gray & Davis, Amesbury, Mass.—The Wridgway "No-glare" shade, shown on Gray & Davis headlights, is an innovation that will be welcomed by all who have ever been caught in front of a dazzling acetylene beam, as this shade prevents any diffusion of light above the level of the lamp itself. It consists of a series of thin horizontal plates across the face of the lamp behind the front glass. These are dull black on top, so that all upward rays are absorbed, and silver-plated beneath, thus intensifying the light cast on the road. The shade can easily be attached to any lamp. It is interesting to note that a law recently passed in New York makes the use of some sort of shade obligatory on headlights.

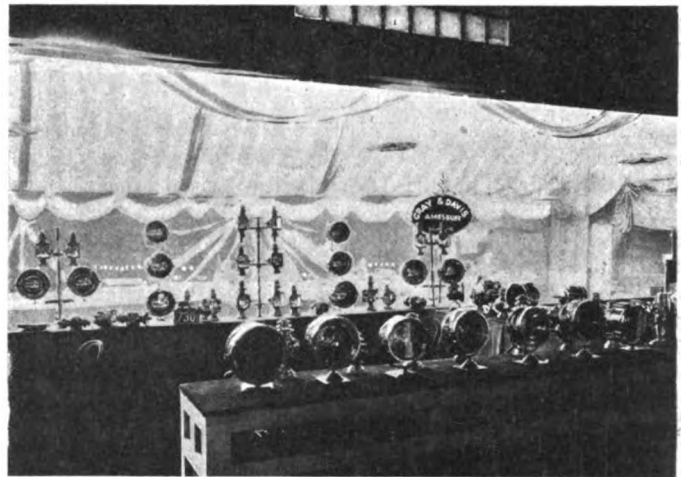

Here It Was that Gray & Davis Lamps Shone Brightly.

Heinze Electric Company, Lowell, Mass.—An exhibit at the Heinze stand which never failed to draw a crowd was a monster spark coil, two feet long, with distributor and plugs of proportionate size. The plugs, mounted high in the air, gave forth sparks of a size more suitable for a wireless telegraph outfit than an automobile; and the distributor, from which the cover had been removed, kept up a fine display of fireworks on its own account. On the other side of the stand was a dummy wooden model of a four-cylinder motor, the shaft of which was geared to one of the new Heinze magnetos. The whole apparatus was turned by a crank, and demonstrated very effectively the ease with which a car can be started with a modern design of magneto.

Hoffecker Company, Boston.—"The Steady Hand" is the watchword of this company, whose speedometers are now beginning their third year on the market. The mechanism works on the centrifugal principle, and the connection between the governor and the indicating hand is made by a special system of levers so arranged that no vibrations can be transmitted. The dial shows a circular miles per hour scale in heavy black, with a black indicating hand, and around the outside of this a trip odometer scale reading to 100 miles, in red with a red indicating hand. The season odometer dial is of the usual type, with fig-

ures showing through an aperture in the lower part of the dial. This speedometer is also furnished mounted by the side of a Chelsea clock, with a small electric light and reflector, and in this form is known as the "Hoffecker twin."

Holtzer-Cabot Company, Brookline, Mass.—These late-comers are showing the newest thing in electric horns. This horn is operated by a direct current and may be wound to work on pressures up to 123 volts for 5 hours without heating. By a new form of contact, sparking even at very high voltages has been practically eliminated. The horn is compact, water-tight and can be relied upon absolutely, which accounts for the fact that the United States Navy has adopted it for emergency signaling. This statement alone speaks volumes for the actual merit of the device.

Hopewell Brothers, Cambridge, Mass.—A spare tire carried on the running board or on the rear of a car at best does not add to its appearance, and to make this necessary article as little offensive to the eye as possible it is well to enclose it in a neat-appearing case. Such is the philosophy of the Hopewell Brothers. Their case is held on by two endless spiral-wound springs, and has no straps, buckles, buttons, or other exterior fastenings.

Hoyt Electrical Instrument Works, Penacook, N. H.—The Hoyt voltammeter consists of two separate instruments, the voltmeter and the ammeter, which are intended to be mounted

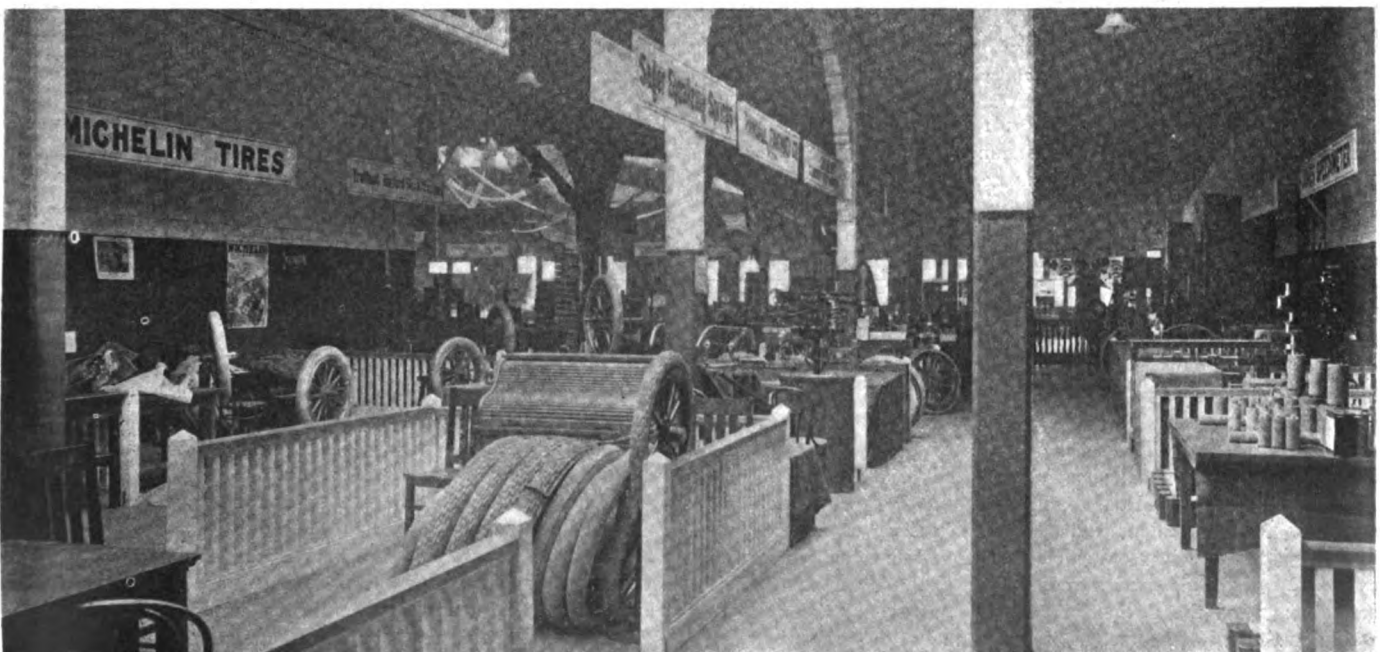

A Glance Down the Long Aisle in the Second Floor of Big Triangular Eastern Section of Mechanics' Building.

together on the dashboard. The windings of both are so calculated that they consume only a very small amount of current, and so they may be kept in circuit constantly without detriment to the batteries. Used in this way they give the driver of a gasoline car the same constant knowledge of his ignition system that the steam engineer has of his steam supply. The instruments operate on the D'Arsonval principle, which is the standard for scientific work. The moving parts are mounted in jeweled bearings, and although very sensitive to changes in the volume or pressure of the current are at the same time dead-beat in action. The cases are made in a variety of finishes to match the other metal work of the car to which they are to be applied. The voltammeter not only indicates the condition of the batteries at all times, but is also an efficient trouble-finder for any part of the ignition system, as the readings of the instrument often show where any fault lies. A booklet issued by

piston covers the opening of this passage, and the remaining air is entrapped and compressed. A too violent movement of the springs is thus immediately checked.

W. H. Leland & Company, Worcester, Mass.—Well known to the trade as a manufacturer of finished crankshafts of exceptional quality, this company has also put on the market the Worcester spark coil. This coil is mounted on a swinging bracket especially convenient for use on roadsters and other cars with hooded dashes. If the coil is rigidly affixed to the dash, the hood makes adjustment of the vibrators extremely difficult. The "Worcester," however, may be swung out into full view whenever desired for inspection or adjustment. The high-tension terminals are arranged very neatly, ending in hard rubber bolts which slip into the bottom of the case and are held in place by nuts of the same material. The coil is fitted with a neat design of kick switch.

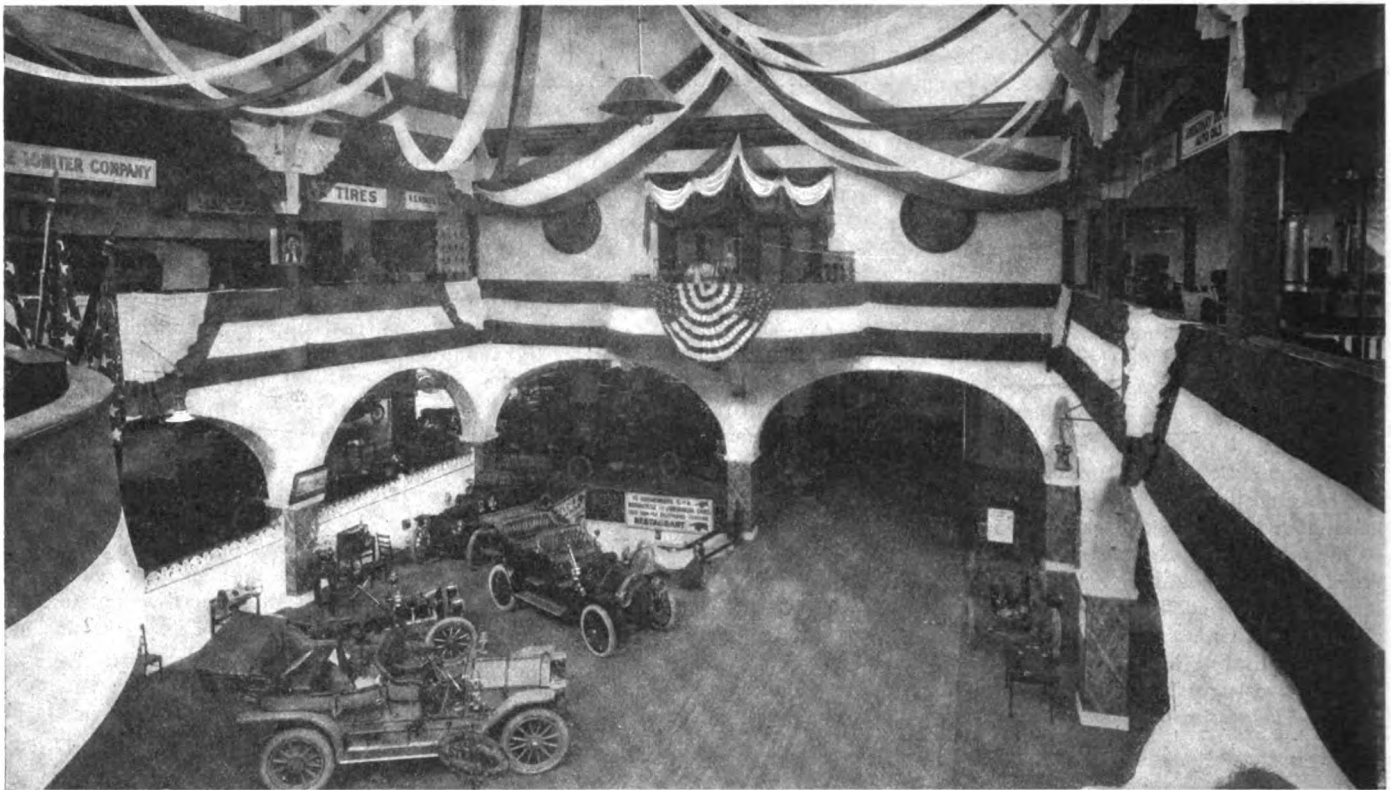

Looking Down from the Gallery in the East Wing, Where the Skylights Made the Lighting Advantageous and Effective.

the makers from their office at 161 Summer street, Boston, clearly explains the use of the instruments in this way, and also gives diagrams of the connections necessary to install them in the ignition system.

Chas. W. Kidder, Stoughton, Mass.—A new design of shock absorber which shows considerable merit is the Monarch. The principle is that of the cam with spring-pressed follower. The body of the device is rigidly bolted to the frame of the car, and the cam is connected to the axle by a crank and link of suitable length. The cam is shaped to give a gradually increasing resistance to excessive motion in either direction, and a positive stop at the limit of action which will be dangerous to the springs of the car. The mechanism is of course carefully enclosed to prevent the entrance of dust and grit.

Kilgore Mfg. Co., Boston, Mass.—The Kilgore shock absorber is designed to make use of the elasticity of air to eliminate the jolts and jars to which an automobile is subjected. A cylinder, full of air, and a tight-fitting piston comprise the essential parts of the device. A narrow passage in the cylinder wall short-circuits the air, as it were, and allows the piston to move with comparative freedom within a short distance on either side of the middle of its stroke; but a further movement of the

Parker Mfg. Co., Roxbury, Mass.—The Standard speedometer marketed by this concern is another example of the centrifugal type. Its distinguishing feature, however, is the method of actuating the indicating hand by direct gearing from the governor weights, without cams or other intermediate mechanism. The scale is evenly spaced and easily read. A new form of trip odometer is used, in which the figures are on a ring-shaped plate beneath the face of the dial and appear through a suitable aperture above the speed-indicating scale. An improved form of swivel joint is used on the driving mechanism on the front axle and is claimed to obviate breakage of the shafts.

Pittsfield Spark Coil Company, Dalton, Mass.—The Pittsfield line of coils and plugs is already familiar to the trade, and the new "arc flame" magneto is rapidly acquiring the same prestige. Improvements in the standard accessories are in details only, such as a new side catch on the coil to hold the top in place, a coil with hinged bracket supports, and a kick switch for magneto and battery or double batteries with a safety plug which cannot be replaced by a nail or a cotter pin. A new plug is listed for use with the "arc flame" magneto.

Post & Lester Company, Boston.—This well-known supply house shows a standard line of accessories, ranging from



HOW THE BOSTON SHOW WAS LUBRICATED

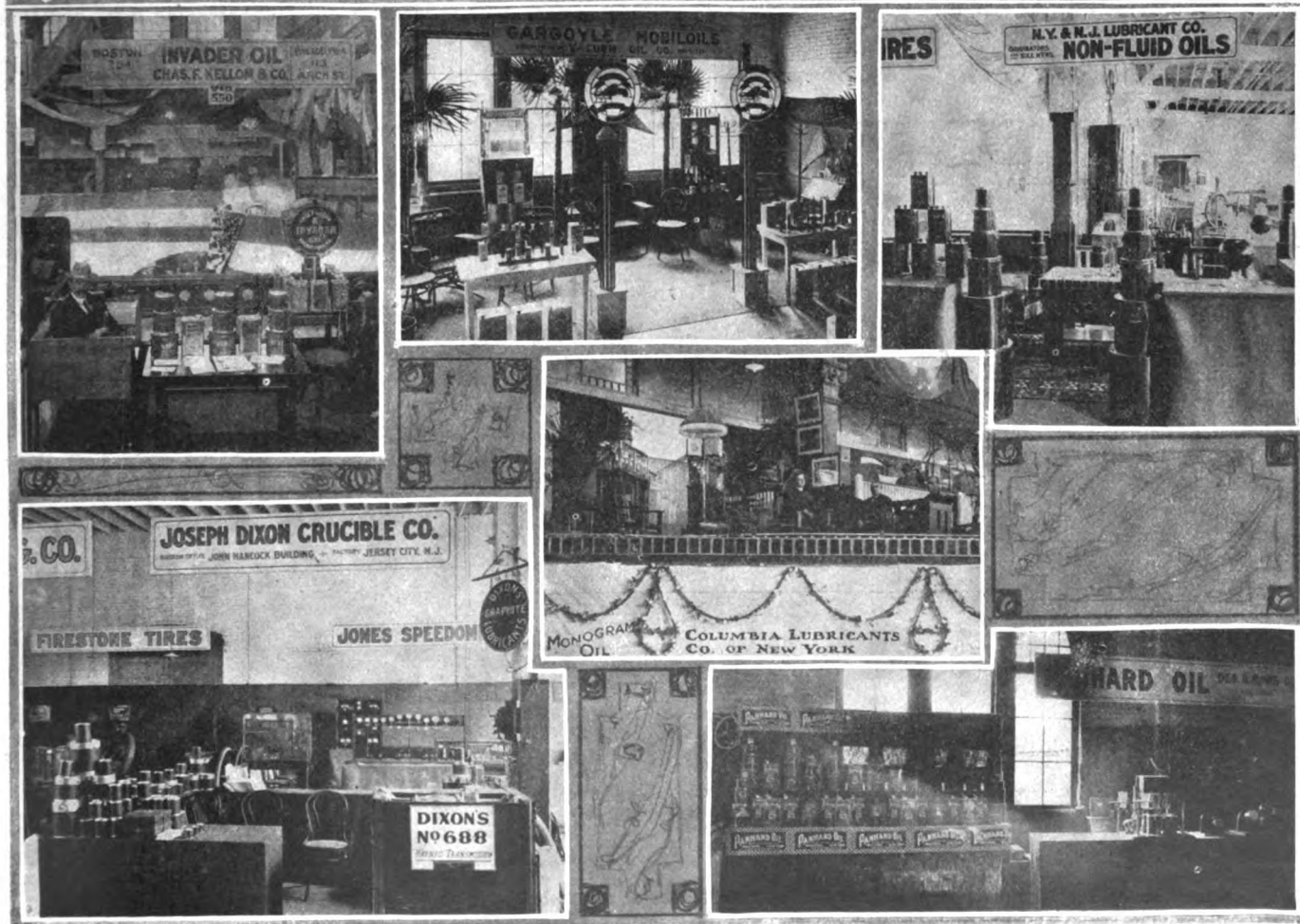

watch fobs to spark plugs. One interesting exhibit is the new Rushmore Multiplex searchlight, for which this company is New England distributor. The front door glass, instead of being flat, is made in four slightly convex lenses, set vertically, which spread the light out in a broad, flat beam. They have the additional advantage of doing away with the flickering which is often so objectionable. Hanging across the front of the stand is a horn shaped like some monstrous variety of snake, the tube forming the body and the bell the head, made in exact imitation of a snake's head even to the forked tongue. It looks very formidable, and should be useful in securing a quick and unobstructed right-of-way.

Randall-Faichney Company, Boston.—This company is well known as a manufacturer of high-grade surgical instruments, and experience in this line may account for some of the fine workmanship to be seen in their automobile accessories. The feature of the Back Bay and Broadway oil guns is that they may be operated with one hand. Both are made of seamless brass tubing, and have metal plungers ground to fit—no packing. The line also includes a grease gun and a gasoline primer. Another useful specialty is the Webster gasoline tank gauge; this is actuated by a spherical metal float connected by a long arm and positive gearing to the indicator on the top of the tank. In connection with this is furnished a tank cutter, to be used in a bit-stock to cut a hole in the tank to which it is desired to affix the gauge. The float and other fittings may be introduced through this hole, without any other means of access to the interior of the tank, and without danger of dropping them inside. It is claimed that the hole can be cut and the gauge inserted in ten minutes. The very latest addition to the line is the Tzar horn. This is easily attached, requires no cleaning, never clogs up, and will outlast the car, in fact. It is operated by the exhaust, which insures more noise and greater convenience in operation. As it is readily attached to the end of the muffler, no especial preparations for its use are necessary, and a real mechanic could put it on in less than an hour. In addition to all these virtues, the price is low so as to place it within the means of all.

Shawmut Tire Company, Boston, Mass.—This company, recently established at 97 Bedford street, with factory at East Watertown, Mass., has put on the market a tire of standard design for which, however, it claims a number of advantages. The rubber is applied by a special process and is vulcanized at a comparatively low temperature, so as to avoid burning or weakening the fabric. This is claimed to eliminate blowouts to a large degree. Shawmut tubes are made of such tough rubber that no flap is needed to protect them from the lugs. The Shawmut Company also makes a full line of cement, acid, patches, tools, and other tire accessories.

Springfield Portable House Company, Springfield, Mass.—A 12 x 18 garage set up on this space leaves passers-by in no doubt as to the business of this company. The garage is formed of sections which may easily be taken down or put together. The hip roof is shingled and the walls weatherboarded. The swinging doors in front open to nearly the full width of the building, and two windows are provided on each side. It is attractively finished in white with dark green trimmings. The company not only makes small buildings, such as garages and work-shops, but even complete eight and nine-room cottages. Autoists who live in suburban districts, if they have even a very little room in the yard, will find the portable garages, as made by this company, not only good for the purpose, but they are in ornamental designs conforming to the needs. The cost of a "portable" will soon be made up in saving of garage charges.

Winestock Mfg. Co., Perkinsville, Vt.—Winestock spark plugs show a new application of the detachable principle. The shell is intended to be permanent in the cylinder; the plug proper is secured in the shell by a bayonet lock, released by a quarter turn. One model has insulated lugs projecting at right angles to give a good finger grip for turning, and the other has a folding handle for the same purpose. The spark gap is adjustable to micrometer fineness. The same company also makes "Cedar-oleum," a hand-cleaning fluid which contains no alkali or grit. It is also used on oil or water stones for sharpening tools, and for cleaning windows, so that it is capable of serving for a wide range of uses with the automobile.

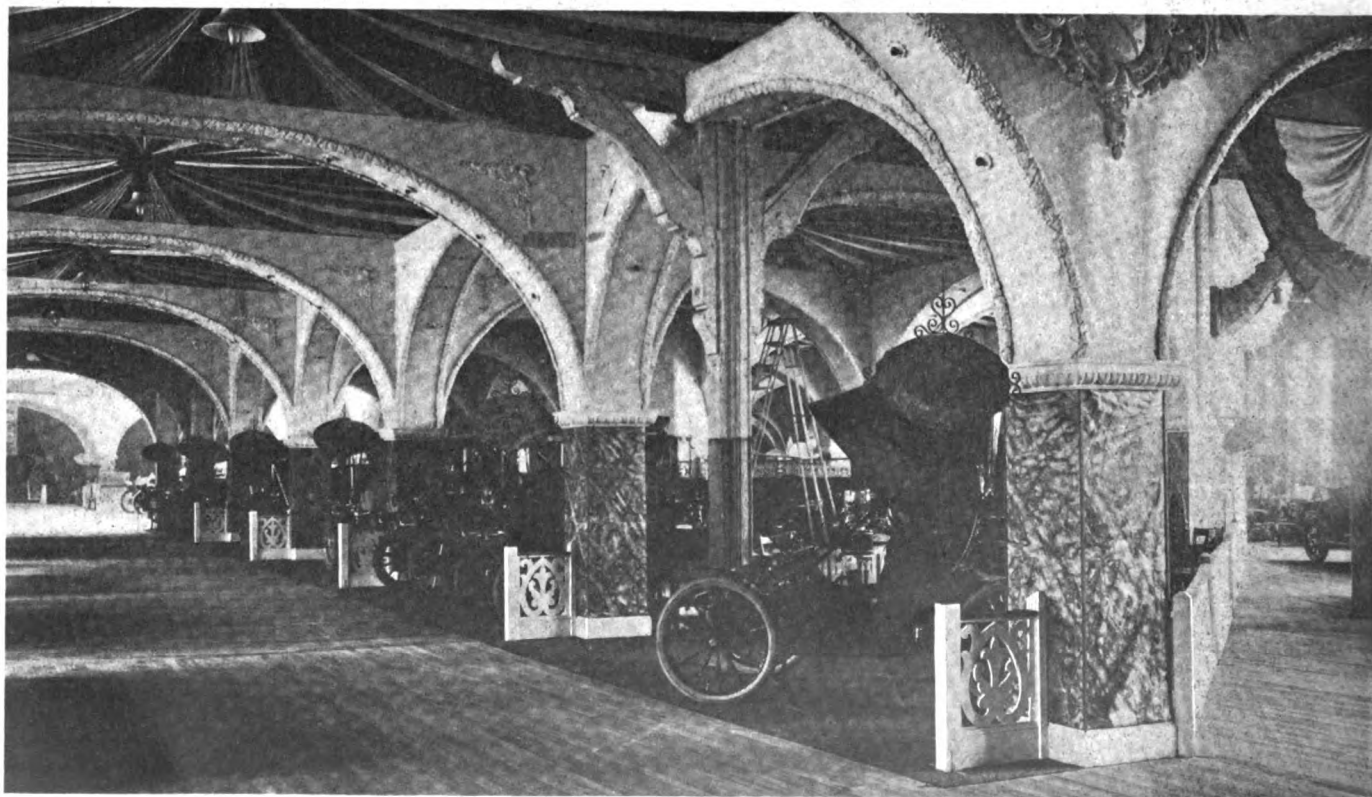

After Passing the Main Entrance Visitors Take Their Choice of the Two Diverging Aisles that Lead to the Exhibits.

TWO NOVELTIES SEEN AT THE BOSTON SHOW.

A Canadian Demountable Rim.—The Standard Combination Motor Rim Company hails from Toronto, Canada, and its exhibit at the show attracted more than a little attention, presenting novelty entwined with utility, in the form of a demountable rim. This rim is parted at one point, and means are provided for expanding the same to get it off of the felly. When the rim is removed it is possible to replace and inflate the tire, after which the whole will slip into place and the locking device enables the whole to be put into place quickly and securely. One of the side flanges comes off in the process and the tire can therefore be taken off and replaced easily. When the rim is mounted, side fasteners, at three points, prevent it from drifting off, and every provision is taken to enable the autoist to do the work with almost no effort, yet with all the security means are adequate for the purpose. The rim is drawn tight at the parting line by a double turnbuckle with a right and left thread.

Seaton Spring Wheel.—Hurbert H. Ward & Associates, with headquarters at 227-235 Williamson Building, Cleveland, O., exhibited the "seaton" spring wheel at the Boston show and while their presentation of the wheel was on a basis to attract attention the wheel would accomplish that feat unaided. Briefly described, the wheel is really a wheel within a wheel with a double set of concentric fellys, in which the inner felly is attached to the hub by spokes in the usual manner, and the outer felly is fastened to the inner one through a series of coil springs in which the axis is at right angles to the radial plane of the wheel. The solid rubber tire is on the outer felly and the resiliency of the tire coupled with the effect of the series of springs is claimed to more than compensate for the absence of air in the tire. The spokes of the wheel proper are of wood and in some measure the ability of this wood adds to the good effect. The wheel is nicely designed, amply strong for the purpose, and unlike most built-up wheels, it is not unduly heavy. As a rule the "flywheel" effect of wheels, in which a spring system is used, is far more than can be countenanced, unless it is that the car on which they are used is to go very slow.

RECENT DOINGS OF THE BOSTON TRADE.

Essex Brass Foundry Company, Cambridge, Mass.—These brass founders, formerly of Amesbury, Mass., have removed to Cambridge, where, at 141-145 Main street, greatly increased facilities will be afforded. As the name would indicate, the specialty is brass and aluminum castings.

Pickard.—The South End Motor Car Company, of 24-28 East Concord street, agents for the Atlas, Brush and Metz, formerly the Waltham, have taken on the Pickard, a new runabout emanating from Brockton and selling at \$750.

Mora.—The G. H. Proctor Supply Company, of 25 Irvington street, has been appointed agent for the Mora car, manufactured in Newark, N. Y., and will start in immediately to push the sale of them.

Herreshoff.—The Boston agent for the Clement & Bailey electric, the French Carriage Company, will in the future sell the new Herreshoff car also. This concern is located at 92 Summer street.

American Simplex.—A recent change in address for the American Simplex Company, handling the two-cycle car in the Hub, places this company at 10 Columbus avenue.

Gramm-Logan.—S. M. Harmon, the Eastern representative of the Gramm-Logan Motor Car Company, manufacturers of motor trucks, has located at 22 Motor Mart.

Post & Lester Co.—The retail branch has moved from 815 Boylston street to 16 Park square. In addition, a wholesale store has been opened at 288-290 Devonshire street.

De Luxe.—Donald MacVichie, formerly of Chicago, has taken on the De Luxe agency and opened a store at 171 Huntington avenue, in the New Century Building.

Midland and Marion.—The New England Motor Sales Company, managed by B. F. Blaney, has taken this territory for the Midland and Marion cars.

Middleby.—The Boston agency for the Middleby, an air-cooled car, has been secured by the Malden Center Garage Company.

Kilgore.—The Kilgore Mfg. Co., manufacturer of shock absorbers, has opened a new salesroom at 585 Boylston street.

Holsman.—The agency for this high-wheeler has been taken by the General Auto Company, 10 Columbus avenue, Boston.

Hupmobile.—Henry F. Farrow, 117 Massachusetts avenue, agent for the Grout, has added the Hupmobile to his list.

Velie.—The Kilbourne-Corlew Company, 28 Bowker street, will represent this Western car in the Hub from now on.

Browniecar.—The New England Auto Company now has the agency for the new juvenile, the Browniecar.

Lambert.—Charles A. Eaton, handling the Lambert friction drive car, is now at 64 Pembroke street.

Matheson.—Roy Faye, the Matheson agent, has moved from Cambridge to 823 Boylston street, Boston.

MILWAUKEE SHOW OPENS SUCCESSFULLY.

MILWAUKEE, Wis., March 9.—Wisconsin's first annual show opened at 8 o'clock to-night, and it is already evident that the people of the State have long been waiting for this opportunity to see almost every known make of motor car assembled under one roof, beautifully decorated, and conducted by an organization like the Milwaukee Automobile Club.

Thirty-eight agencies purchased all the show space available, and cars are displayed even on the balcony floor of the Hippodrome. Four motor cycles are on exhibition in one corner, and the remainder of the floor is devoted to accessories, supplemented by displays in rooms off the main floor.

The show is proving to be one of the greatest society events of the season. In anticipation of this, the club arranged for luncheon service at all hours during the show periods, with music by orchestras and bands. Thursday will be "State Day." All of the local clubs affiliated with the Wisconsin State A. A. will be officially represented. Several tours have been arranged by clubs within striking distance of Milwaukee.

The success of the show was assured long before to-day. The club never feared that it would not draw big crowds, for hundreds of people from the interior are coming. A feature of the arrangements was an illuminated parade of over 100 demonstrating machines and private cars owned by club members, on Saturday night, March 6. This assisted greatly in waking up the people of Milwaukee to the fact that it has a real show "in its midst."

SYRACUSE SHOW ENGAGES DAI LEWIS.

SYRACUSE, N. Y., March 8.—A town that has once been bitten by the show microbe practically never recovers. This is the true explanation of the continuous increase in the number of automobile exhibitions. Last year this city was given its first show by the H. H. Franklin Mfg. Co. The affair was held in the Alhambra, the chief convention hall of the city, which was crowded during the days of the show. Following up the success of its initial show of last year, Syracuse is preparing for its second automobile exhibition, to be held in the New York State Armory March 24-27. This has been followed up by the recent formation of the Syracuse Automobile Dealers' Association, with a score or more of members, representing the automobile agencies in Syracuse and Central New York of many of the well-known motor cars. Dai H. Lewis, manager of Buffalo's successful exhibitions, has been engaged to conduct the show.

SCORE OF CARS ON RUN TO BOSTON.

NEW YORK, March 11.—In a mid-winter endurance contest, on a running schedule of twenty miles an hour, twenty-one automobiles early this morning left Columbus Circle on their way to the Hub, in competition for the Chester I. Campbell trophy, expecting to finish shortly after 6 o'clock this evening at Mechanics' Hall, where Boston's annual show is in progress. As "The Automobile" goes to press the cars are well on their way, traveling over muddy but fairly good roads.

Under the direction of Mills and Moore, this contest was gotten up almost upon the spur of the moment, but it shows that makers, dealers and owners alike, appreciate a contest at this time of the year when such an event is a diversion from the regular round of exhibitions. At 6:30 this morning the first machine, a Mora, driven by W. W. Burke, was sent away on the run of about 243 miles, making it due at the finish at 6:39, and



Campbell Cup Offered in New York to Boston Run.

the others followed at one minute intervals. The rules called for an average speed of the legal limit in this State and Massachusetts, with the same through Connecticut, several checking stations being chosen on the route, where the cars were due to arrive on their schedule or be penalized one minute for each minute late.

New Haven was selected as the first station, the first car being due at the New Haven House at 10:30; the second at the Hotel Heublein, in Hartford, at 12:36; the third at the Worcester Automobile Clubhouse, in Worcester, at 4:33, and then to the finish. From Worcester R. H. Johnston, of the White Company, has arranged to pilot the cars into Boston, the remainder of the journey being comparatively easy to follow. The roads have been covered with mud and slush for several days and a hard test was expected when the contestants left this city.

The trophy was first competed for two years ago and was won by L. H. Perlman, who has returned it to Mr. Campbell in order that it may be the prize again this year and perhaps on following occasions. The referee, Leon M. Bradley, of the A. M. C. M. A., has stated that the trophy will be awarded to one contestant, and if there is a tie to-day he has reserved the right to send the cars either back over the same route or on some other one

until a definite winner is evolved. The following is the list of entrants, in the order of their start:

No.	Car.	Entrant.
1	Mora	W. W. Burke
2	Renault	Paul Lacroix
3	Haynes	W. E. Shuttleworth
4	Acme	A. B. Cordner
5	Matheson	A. D. Hall
6	Franklin	C. S. Carris
7	Kissel Kar	F. S. Dickinson
8	Stearns	Guy Vaughn
9	National	W. C. Poertner
10	Knox	Albert Dennison
11	Zust	V. P. Pisan
12	Premier	R. R. McNamara
13	Atlas	Chas. H. Beecher
14	Stearns	M. W. Batts
15	Matheson	C. F. Rothfuss
16	Cadillac	L. R. Burne
17	Cleveland	J. I. Miller
18	Cadillac	H. A. Street
19	Lozler	C. E. Force
20	Maxwell	C. W. Kelsey
21	Coates-Goshen	A. MacRae

DAYTONA RACES WILL BE HELD.

After encountering many obstacles, which for a time made it look as if there would be no races this year upon the Florida beach, affairs have been finally arranged so that the contests at Daytona will be run off as scheduled, from March 23 to 26, and additional entries have been made. Of these there are a number of large powerful cars which have participated in many events in this country and should enliven matters in the sunny South, among them being the Fiat Cyclone with Ralph DePalma at the wheel, Lewis Strang with a special Buick, and H. J. Kilpatrick with the big reconstructed Hotchkiss.

The Fiat will defend its title to the Minneapolis trophy, won by the late Cedrino, and will be entered in every event eligible. Burman is already at Daytona with Buick cars and Strang is due to join him very shortly. It is highly probable that the two Knox cars will be contenders. Kilpatrick has rebuilt the Hotchkiss, the one which was formerly owned by E. R. Thomas, and changed its color from the yellow that became so well known to a bright red. The aeroplane race is also looking up well, a number of entries have been received, and the machines are on their way to the scene of action.

The Contest Board of the American Automobile Association yesterday granted a sanction for the races, thus closing an incident that for a time appeared to be one which might cause considerable trouble. Although there will be foreign cars competing, the event is considered to be a national one, and therefore the A. A. A. was asked for the sanction. W. J. Morgan, who has this year's races in charge, is actively engaged in the work.

NEW APPLICANT FOR BRIARCLIFF.

NEW YORK, March 9.—Automobile racing circles about this city were very much surprised, and a new puzzle added to those encompassing Briarcliff race affairs, to-day when an application was made to the Board of Supervisors of Suffolk County, Long Island, for permission to hold on certain roads a race similar to the one for the Briarcliff trophy, and in some cases said to be that event itself. The application was made by L. C. Austin, and a 60-mile course suggested, with Riverhead, Quogue, Patchogue, Huntingdon and other points, upon it.

Neither Henry H. Law, son of the donor of the trophy, Walter W. Law, and a member of the contest committee of the A. C. A., nor Percy Owen, chairman of the Briarcliff race committee, knew anything about the affair, and inasmuch as it is now up to Mr. Law to determine upon the course, rules and other matters in connection with that contest, it is not thought that he Suffolk County promoters would be able to secure the Briarcliff trophy. That, of course, would not prevent them from holding a race and donating a new prize.

WHAT SOME NEW ENGLAND MAKERS ARE DOING

W. M. KEAN WHITE

SPRINGFIELD, Mass., March 8.—Present prosperity and preparation for one of the greatest, if not the greatest automobile selling season ever known in this country, is the line along which automobile manufacturers in the vicinity and in Hartford are working, making great numbers of cars for delivery when the real Spring opens and the demand becomes greater than the supply, machining great amounts of materials, and not in the least showing any fear of more financial trouble, the tariff question or of anything, except a shortage of new automobiles when dealers want them most for delivery to pressing customers.

Both the Knox Automobile Company, in this city, and the Stevens-Duryea Company, at Chicopee Falls, are working to the limit in order to fill orders which are coming in now, in a procession that has been surprising, while the Fisk Rubber Company, also at Chicopee Falls, has almost as much work as it can do in making enough tires. At Hartford, a center of the automobile industry, the story is the same, the Pope Manufacturing Company, now reorganized and out of the receivers' hands for nearly three months, not only working its big factory as fast as possible, but at night as well as day. The Electric Vehicle Company, making the Columbia cars, will be out of its difficulties within a couple of months and already many of the plans for the reorganization are well under way. The McCue Company is just waiting for the completion of its new factory and the Hartford Rubber Works is finding overtime work necessary.

Probably one feature of a trip through these factories is the enormous amount of raw material, castings, forgings and other parts, that are being machined preparatory to being used in construction, the rows of cars that have been made during the winter for Spring delivery in some places, and the general hum of industrious application to the coming problem, that of constructing enough high grade automobiles to satisfy the consumer, and there are no second-hand or slightly used cars being returned to the factories, either, for repairs or the scrap piles.

Many Cars in Stevens-Duryea Factory.

Four hundred automobiles represents a great amount of money, time and labor, but that is the number which the Stevens-Duryea Company has in its big factory at Chicopee Falls, being machined, assembled, painted, tested, or finished awaiting delivery. Between 1,200 and 1,300 four and six-cylinder touring cars and roadsters, with a few enclosed cars included, will be the output for the year, and at present the shipping rate is averaging 41 cars a week, so that with a productive capacity of 50, the concern can put away a few machines to meet the demand that will prevail in May, June and July. But to see 100 beautifully finished touring cars covered with dust cloths, complete with the exceptions of tires, standing on the storeroom floor, a hundred assembled motors nearby and then other cars by the score in the various departments in the stages of their development, is enough to impress the casual visitor with the immensity of the industry.

This is perhaps the feature of the prosperous condition at the Stevens-Duryea plant. In starting through in the same direction as the raw material takes from the time it enters as rough stuff until it is in the finished car, the whole aspect of the fac-

tory, extending over 300,000 square feet of floor space, is that of activity. On Friday of last week there were hundreds of cylinder castings on big trucks going from machine to machine, showing that the large number of finished cars to be shipped is but a part of the entire production, scores of transmission sets, clutches, crankcases and rear constructions, being around also, in various stages of development into parts of the cars. In the paint shop there were fifty running gears, by actual count, having the rough and finer coats placed upon them, in the finishing department there were twenty cars having the finishing touches worked up, the stripes put on them and in other ways completing them for the purchaser. Another twenty chassis were in the process of erection in the room set aside for that work, and in the assembly room there were at least twenty-five completed rear constructions, and fully 100 motor-clutch-transmission sets, all being in a unit aluminum housing, ready for lifting into the pressed steel frames standing nearby. So altogether 400 cars are in the factory, some, of course, just being started.

Yet in spite of the large number of finished cars, the great amount of work going through the factory and the building of half a hundred machines a week, the factory can give immediate delivery only upon its four cylinder models, the demand for six cylinder ones being equal to the supply. Just about an even thousand employees are engaged in the work of the Stevens-Duryea Company, and in the erecting room the men are doing evening work. A new building is being constructed to serve as a storeroom with a capacity of 70 machines.

Of great interest, too, is the testing department, one of the most thorough of any automobile concern, all of the new motors being run from two to three days upon testing stands with their own carbureters and magnetos, attached to electric dynamos which accurately show the amount of power being developed. Seventeen stands are provided so that many can be tested at once. The new engines are first "run in" and limbered up by the electric motors, and then the tables are turned, so to speak, and the automobile engines, both fours and sixes, are operated under their own power, driving the electric motors as dynamos and registering the amount of power developed. When they have passed inspection, and run quietly, they are installed in their chassis and given a test upon the road from 50 to 100 miles.

Fisk Makes Four Hundred Tires Daily.

Nearby, along the canals that furnish water power, is the plant of the Fisk Rubber Company, where 400 pneumatic shoes and 600 tubes are being made daily, and more to the point, are being

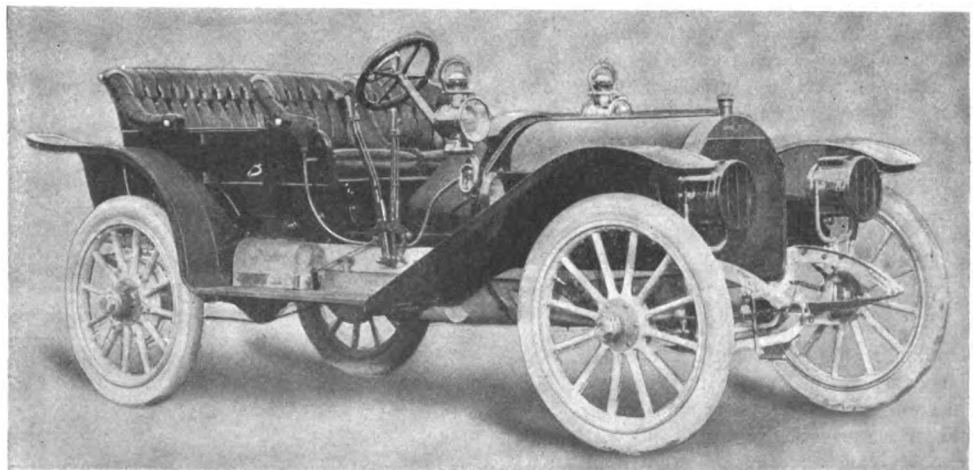

Four-Cylinder Stevens-Duryea Equipped with Toy Tonneau.

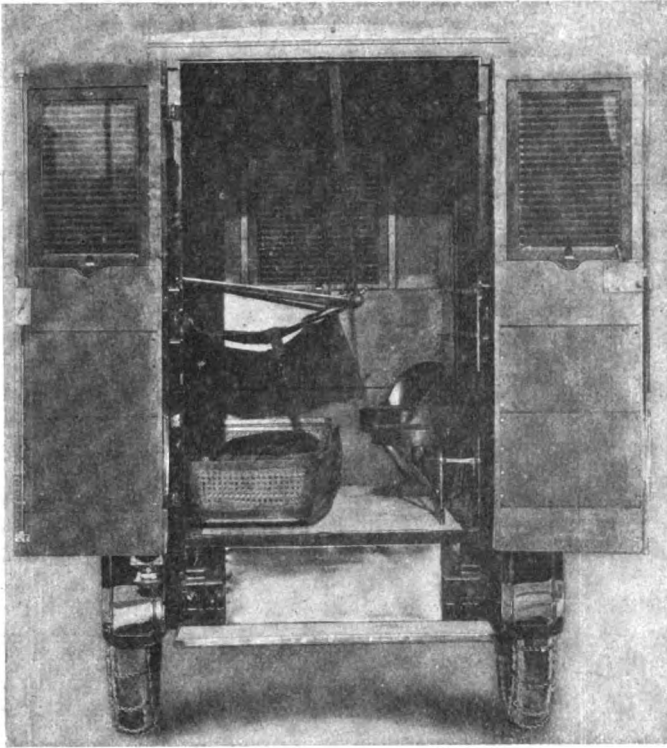

Interior View of the Improved Knox Ambulance.

shipped away to supply orders, or to give the branches, agencies, or factories a stock for use when needed. The Fisk feature for some years has been the bolted on type of tire and with the new removable rim, lately introduced, the demand for this has surprisingly increased, according to the officials of the company. The bolted-on tire, fitted to the new rim combines the features of a mechanically fastened shoe with that of the quick detachable or demountable, and the increased demand for this combination has been remarkable. At present the principal business is with manufacturers who are equipping their new machines, and the amount transacted last month was double that done during February, 1908. In taxicab circles the Fisk has shown such success that the firm has received orders for this equipment from many cities, among them being Philadelphia, where the Bergdoll cabs have recently put them on. Thirty tires were shipped last week for taxicabs on the Pacific coast, and, in fact, there has been a great deal of business done through the South and West, the regular centers, such as New York and Boston, doing about the usual amount, the growth apparently being farther away from the home town.

In line with the trend toward larger diameters, the Fisk Company is now making fifty tires of 40 inches by 6, to fill an order, a remarkably big tire when it is seen in comparison with the more generally used sizes. There is a decided movement among manufacturers from small size to larger wheels, especially those from 36 to 42 inches in diameter.

Busy Times for Knox Makers.

At the plant of the Knox Automobile Company, in this city, there is a similar scene of activity, everybody busy turning out cars, both for pleasure and business purposes, with either air or water-cooled motors, and with enough raw material going through to show the large business that

will be done during the season. It takes some time to machine 300 cylinder castings, enough for 75 complete cars, and to finish these cars; and the fact that there were fully that many castings sitting in the machine shop was conclusive evidence of the plans for a whole lot of work and a big product. About 600 machines are to be put out this season, and, of course, a large number have been delivered already, a few are awaiting delivery, and a large amount of material is being constructed for the ones to come. Of the total number of pleasure cars, about 500 will be the Model O, with its 38-horsepower motor, and the other 100 will be the Model M car with a 48 horsepower motor. The trucks and commercial machines are built to order so that it is difficult to estimate at any time just how many will be built during a season.

Increased business has necessitated increase of space and now the company has 216,700 square feet, building all its own bodies, making its own aluminum and bronze castings, and doing all of its own upholstering and top building, besides the regular work of making the greater part of its cars right in the factory, very few finished parts being bought outside. A walk through the machine shop was sufficient to show the trend, for in addition to the 300 cylinders already mentioned, there were rows upon rows of pistons, ready to be machined or already finished, piles of connecting rods, bearings and small parts, galleries of crank shafts, and scores of big aluminum castings that combine the crankcase and transmission case in one. After the machine shop, located, in a room nearly 400 feet long, is through with the various parts they are sent to the stock room and out of it, in turn, to the assembling floor in trucks, each of which carries the parts necessary for one car. This is a feature which struck one as being good and not often seen, that of taking from the stock room the four cylinders, the clutch, the valves, springs, gears, wires, spark plugs, balls, pumps, crankshaft, pistons, connecting rods and the other various parts, and putting them into separate box trucks so that each motor can be put together without there being any need for the mechanics to walk more than a yard between the stand and the supply.

The motors are all run in on stands, driven by belts, and are thus worked for about two days when their compression and freedom must be correct before they are put into the chassis and given a road test of from two to three days. Several motors were going through the various stages on Saturday morning, when the factory was visited, and a number of testing cars upon the road, but the demand for the Knox cars has been such as to prevent the firm from getting ahead and storing cars away for later use, the only ones on the floor being even then headed toward the shipping room. The body, top and upholstery rooms were all working to their capacity, while the department making the Knox glass fronts and paint shop were having enough to do.

The Knox Company has always been prominent in truck work

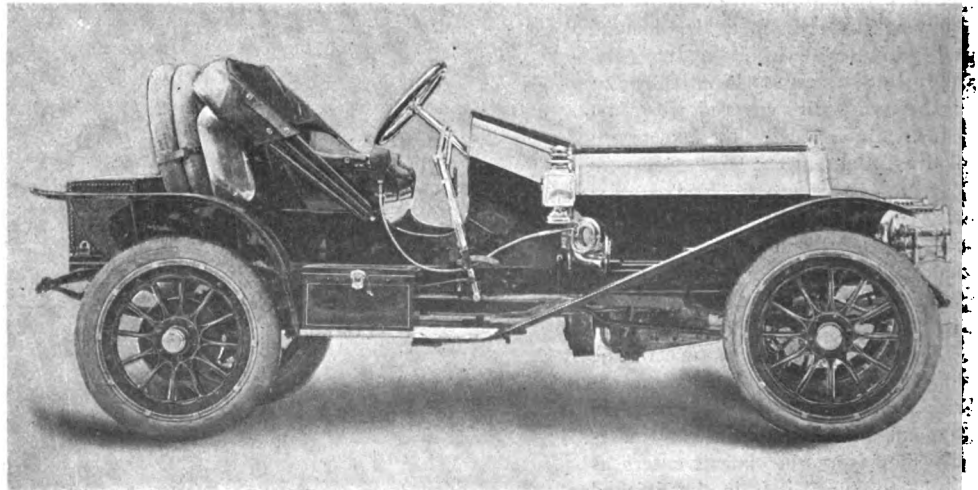

New Body Type on Knox 38-Horsepower Chassis.

and its list of orders shows that the commercial situation is improving, there being a steadily growing demand for cars of this class. All types are supplied, from those with a capacity of 1,000 pounds to those which can carry eight tons, with motors from the single cylinder to a four or six, many of them either water or air cooled, for any use from an ambulance to a fire engine, and the big truck, that has a motor gear-driven pump at the rear, for the Boston show was receiving final touches. The fire equipment has been given especial attention and a number have been shipped recently.

The Knox Company will stick to contests this year as it has done in the past, entering hill climbs, speed contests on tracks and roads, endurance runs and practically everything that comes along. It has just received the award of \$1,000 for the winner of the Garden City Sweepstakes, on the Motor Parkway last fall, the Sharp-Arrow being disqualified.

What the Hartford Factories Are Doing.

HARTFORD, CONN., March 8.—Dropping down the Connecticut Valley to this State's beautiful capital, the same note of optimism was found in the offices of its several automobile manufacturing concerns, the orders coming in a highly satisfactory manner, trade difficulties having been overcome and the only apparent purpose being to turn out cars, as fast as compatible with high quality.

The Pope Manufacturing Company, building the Pope-Hartford cars, is the largest of the concerns in the automobile business in this city, and although making 700 machines this year the capacity will be the limit in 1910. Only about three months ago this concern came out from the hands of receivers, and its policy for this season was to a large degree outlined then, following a reasonably conservative policy. Even now there are 1,100 men employed in the big factory, one of the largest of its kind in the country, with 400,000 square feet of floor space, and evening work was announced to commence again this evening. It has been found that evening work can be gotten from the employees for a certain length of time without making them too tired the following day, or necessitating an extra shift, but then that must be stopped and the men given a rest.

An enjoyable trip can be made through this plant, to one interested in automobile affairs, for there is perhaps no concern in this line of work which makes more of its finished cars in its own factory than the Pope company does at Hartford. Its crankshafts, connecting rods, steering knuckles and other parts are drop forged in its forge shop, its radiators are made in its sheet metal department, all the castings are machined in its extensive shops and the bodies are built in still another department. The raw material can easily be followed from the sheds in the yards through the various operations of machining and fitting, to the assembling room where it goes into the cars. That there is plenty of work to do to keep the factory running full time, even if the notices of evening work were not seen, would be evident from the amount of unfinished castings seen throughout the plant, and finished ones ready to be put together are in the extensive stock rooms occupying two large fire-proof floors.

The Pope-Hartford is enjoying another year of popularity, judging from the tone of the officials when speaking of the number of shipments, the increase of incoming orders, the general good feeling existing with the outlook free from any restrictions, and the amount of material authorized sent to the purchasing department. The cylinder and aluminum castings, which are made outside of the factory, are being received in large, frequent shipments and are handled in the machine shops as fast as possible, while those parts which are made right in the plant are

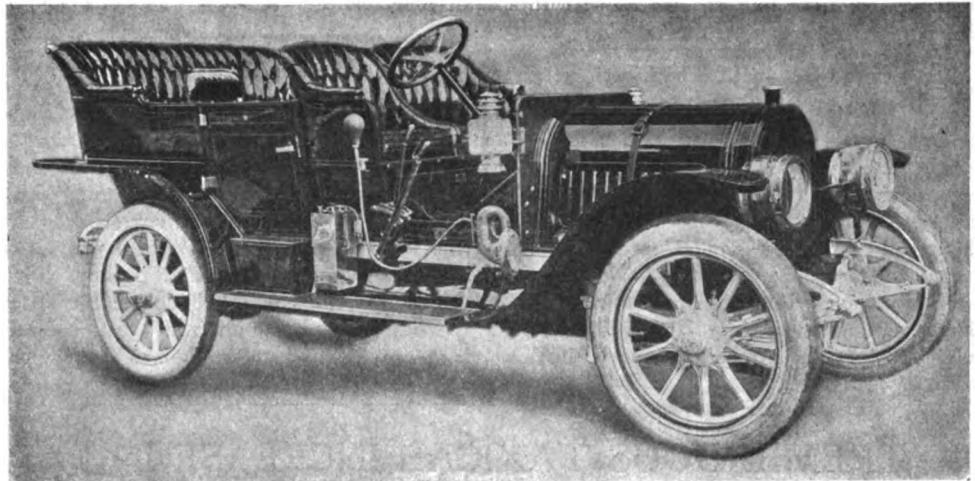

Latest Type of Pope-Hartford—A Seven-Passenger Touring Car.

going through in like order. The wood frames, which have proven successful in years past, have been retained and these, of course, of second growth hickory, are secured away from the plant but shaped in it. Sheet-metal bodies are used on all of the cars except parts of the enclosed machines, most of which, however, have been delivered, and the upholstering department, top and body department are all doing just as much as they possibly can. Only a few cars have been saved to meet any growth in the demand, but it is hoped that by getting in extra time work, a few may be finished ahead, in order to give dealers immediate deliveries. There are a large number, of course, in the factory in the different stages of finish, some almost ready to be shipped, others in the paint shops, still others in the body department, and many being assembled. Quite a squad has been employed all along in testing out the cars on the roads, after the motors have been run coupled to dynamos to record their power and to run them in, fully a dozen cars being on the road on Saturday.

The extent of the Pope-Hartford machine shops is impressive, for they are entered one after another, floor above floor, long and wide and filled with all kinds of lathes, presses, shapers, milling machines, gear cutters and others for doing special or regular operations in completing the mechanical parts of the machines. The tool shop alone, for making special tools or for keeping those in use in order, is nearly as large as the complete machine shops of some smaller factories.

Receivers Soon to Leave Electric Vehicle Company.

Further up Capital avenue is the plant of the Electric Vehicle Company, makers of the Columbia cars, soon to be free from the receivers and able to pursue a more aggressive policy than it has done for some time, according to Henry C. Knuckols, one of the receivers. In about two months' time the receivership will be dissolved and the reorganization completed. At the present time, however, it is pursuing a plan of building 400 gasoline cars and 100 electrics, on an average of 12 to 15 cars a week, with 500 employees working full time. Of course, as soon as the concern is out of the receivers' hands it will start to build more cars for the 1910 season, and already material for the new product is being arranged, the details having been worked out, and the new cars with some altogether new features will probably be upon the roads by the middle of April.

One of the attractions at the Madison Square Garden show was the color combination at the Columbia booth, a white and a cream yellow car, each receiving a great deal of attention, and so the question was asked as to whether there has been a demand for fancy colors, especially the lighter ones. From the answer it is evident that there is a desire for such machines, for three white ones have been sold here in Hartford, one in Chicago, two yellow ones in other places and a number of prospective purchasers are contemplating having cars gaily finished. The five-passenger touring car, as is generally the case, is the popular

model, though the four-passenger one with a detachable tonneau is being sold in many sections of the country.

Large Production of Hartford Rubber Works.

Working its big factory 24 hours, and turning out 400 shoes and 600 to 800 pneumatic tubes, 2,200 bicycle tires and 200 solids every day, the Hartford Rubber Works Company is doing an enormous business and one that directly reflects credit upon the automobile industry, for the large number of cars that will be built will require tires, and from the demand in the factories of these goods can be seen the stride being taken by the motor-vehicle builders. Both the pneumatic and solid business has been increased during the early part of this year, and the full day and night work has been required to meet the demand.

The newest of the concerns engaged in the automobile business around this city is the McCue Company, which is building a standard car bearing that name, equipped with a 29-horsepower, four-cylinder motor, a three-forward speed, selective sliding-gear transmission and a full floating rear axle. A four-cylinder motor of 45 horsepower can be supplied at an additional cost. Two types of bodies are supplied, either a five-passenger roadster or a four-passenger roadster. The construction throughout is that followed in generally accepted automobile construction, and at present the company is carrying on its work in a small machine shop while waiting for the completion of its factory, to be finished during the latter part of this month. It is planned to build from 150 to 200 cars this year and to increase that number to the limit of the new plant for the 1910 season.

TREMENDOUS TAXICAB INCREASE IN PARIS AND LONDON

PARIS, March 3.—Paris is cursed with a multiplicity of taxicab fares which the authorities are powerless to remove. In order, however, that the public may no longer remain in ignorance as to why a fixed journey in three different cabs should cost three different prices, the Prefect of the Seine has ordered that on and after April 15 all taxicabs shall carry the price per kilometer marked on the flag at present bearing the word "libre." This price will be the one charged after the initial fare of 15 cents has been paid. The distance to be covered for the minimum initial fare, and which at present varies from 600 meters to 1200 meters, must be indicated on a metal plate carried by the side of the driver. Thus a cab running 900 meters for 15 cents would have this indicated on the side plate. If the following rate were 4 cents per additional 400 meters, the flag would carry the figure corresponding to 10 cents, this being the rate per kilometer. Cabs at present vary so much in power, comfort and fittings that it is impossible to enforce the same rate of payment for all, regardless of equipment.

The number of taxicabs in circulation in Paris at the end of 1908 was officially declared to be 2,923, while the number of horse cabs at the same period was 8,790. Twelve months previously, at the end of 1907, taxicabs numbered 1,465 and horse cabs 9,608. Automobile cabs have thus doubled during the twelve months, while the number of horse cabs shows a serious decrease. The decrease of the horse cabs, however, is not in the same proportion as the increase of the motor cab, for it must be remembered that the latter does at least 30 per cent. more work than the former is able to accomplish.

Though Paris holds the lead with the number of taxicabs in use, it is very closely followed by London, which at the end of 1908 had 2,805 taxicabs in regular service, compared with 723 twelve months previously, and only 96 at the end of the year 1906. The decline of the horse and the increase of the taxicab

in the city of London since 1903 is remarkable, as is shown by the following official figures:

	Horse Cabs.	Motor Cabs.
1903.....	11,404	1
1904.....	11,057	2
1905.....	10,931	19
1906.....	10,492	96
1907.....	9,818	723
1908.....	8,475	2,805

As in New York, the use of the taximeter as a recording instrument was unknown until the automobile cab made its appearance. This doubtless accounts for the sudden jump into favor, the London public appreciating a system which made payment a matter of clockwork. In Paris, on the other hand, the taximeter was an established institution long before automobile cabs made their appearance, and when these latter did appear they had to compete against a low rate of fares applied with mechanical accuracy to horse-drawn vehicles.

The number of motor omnibuses in use in London at the end of last year was officially declared to be 1,133, this being a slight decrease on the number in service twelve months previously. The comparative figures, as given in the official returns, are as follows:

	Horse 'Buses.	Motor 'Buses.
1903.....	3,623	13
1904.....	3,551	31
1905.....	3,484	241
1906.....	2,964	783
1907.....	2,557	1,205
1908.....	2,155	1,133

The number of motor 'buses in service in Paris at the end of 1908 was 162. The company responsible for the service in the French capital holds a monopoly, but is under an obligation to replace all horse 'buses by automobile vehicles during the year 1910.

AGRICULTURAL MOTOR COMMISSION FORMED.

PARIS, March 4.—A new commission has been added to the half dozen of which the Automobile Club of France is practically composed, the new body to be known as the Agricultural Commission. Its object will be to encourage the application of the automobile and internal combustion motors to agriculture, this being a field of activity that has hitherto been much neglected in France. In view of the possibilities of usefulness in the matter of agriculture, it has already been decided to hold an exhibition and practical tests annually for the next four years, the district chosen being a different one each year, in order to diffuse knowledge on this subject and arouse interest all over the country. The acquisition of a field for experimental work with motor-driven agricultural machines has already been decided upon, the field to be of such a nature that it can also be employed for aeronautical experiments.

FRENCH COMMERCIAL TESTS OCT. 15-NOV. 15.

PARIS, March 4.—The next commercial vehicle competition of the Automobile Club of France will be held from October 15 to November 15 of the present year, the center to be at some point in the suburbs of Paris, and the route to consist of circular trips from this center. Special importance is attached to the competition from the fact that it will be held under the auspices of the War Department, and partly under their regulations, the Army having decided to offer a substantial indemnity to all commercial vehicles conforming to the successful type evolved from the competition, on condition that the automobiles shall be at their disposition in time of war. As army officers will in all cases be responsible for the control, there will be much more rigorous treatment than usual in tests of this nature.

There have been a number of makers in this country who have desired this very important test.

SAFETY AND UTILITY OF AUTOMOBILE STEERING SYSTEMS

PART I

RAILWAY equipment does not have to be provided with steering gear, for the reason that the wheels are flanged in such a way that they will not run off of the steel rails over which they are designed to roll. Horse-drawn vehicles are not provided with steering gear in view of the manner in which the horses draw the vehicles along, thus making it necessary to

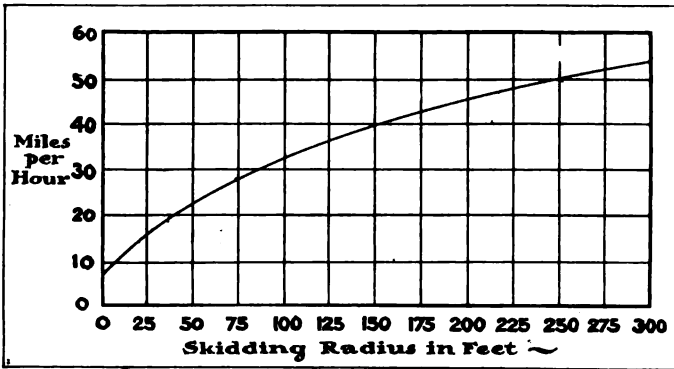

Fig. 1.—Showing relation of speed of cars to skidding radius.

guide the horses instead of the vehicles. In automobiles, however, the principle is different; they are propelled, not drawn, nor do they roll over guiding rails; hence they have to be steered. According to Newton's "first law of motion," even automobiles would not have to be steered on a hard level roadway were the automobiles of a harmonious design, and provided they were always to travel in a straight line, for the law says: "If a body be at rest, it will remain at rest; or, if in motion, it will move uniformly in a straight line till acted on by some force. That the secondary force must not be parallel to, and in the same direction, as the force which impels the car, is true.

But one of the advantages of the automobile is that due to its mobility in all directions despite the law, which urges it forward in a straight line. On the other hand, the ability to direct a car out of a straight line does not defeat the tendency of the same to hold to a tangent, and it is for this reason that it is dangerous to overstep the bounds beyond the ability of the devices available to control.

Stable conditions are present in a car when it is traveling in a straight line. Instability begins with the first turn of the steering wheel and increases as the angle of the road wheels is increased, which instability is also augmented as the speed is increased. That some cars will perform better than others, in this respect, is assured, if only it is true that all cars are not with the same center of gravity and in general harmony.

The first serious sign of instability, when a car is diverted out of its habitual straight course, is when the skidding tendency is noticeable. Fig. 1 depicts the situation under good average conditions, in that it shows the relation between speed of the car, in any given case, in miles per hour, and the radius of the arc of a circle through which it can be directed, within which, skidding will not take place on a hard, level road, in the absence of accidental outside influences.

In the curve, Fig. 1, abscissa represent speed in miles per hour, and the ordinates are given values in feet, representing radius of turning, under conditions of eminent instability, as indicated by skidding. If a car is traveling at 40 miles per hour, the curve shows that the intersection with the ordinate representing the skidding radius will be at 150. In a word, then, if a car is

traveling at a speed of 40 miles per hour, skidding will ensue if the radius of turning is 150 feet.

In actual practice, considering streets of the average width, Fig. 2 shows the usual performance, in turning corners, and the radius of the arc of the circle is given as 75 feet. In this case the curve, Fig. 1, indicates that skidding will take place at about 38 miles per hour of the car. The manner in which the corner is turned, as shown in Fig. 2, is not looked upon as good practice by many autoists, and Fig. 3 is offered to illustrate the proper way to go around corners, according to some authorities. In this case the autoist is supposed to keep to the right, and in so doing the radius of the arc described in turning will be about one-half of that which will be due to cutting the "in-curb," as represented in Fig. 2.

To go around corners in the manner as shown in Fig. 3, it is necessary to slow down, for the reason that the radius of turning will be less, and, as the curve Fig. 1 tells, skidding will follow if the speed is 18 miles per hour, assuming the radius is 37 1-2 feet. Likewise, for every speed of any automobile there is a maximum rate at which the turn can be made without skidding, and safety demands that skidding be avoided. Skill in driving consists in knowing and maintaining safe speed, taking into account (a) the fundamental laws and their effects, (b) the road condition, which introduces "accidental" variations, tending to distort normal performance.

Front Wheels Must be Set Properly.—Makers of automobiles, if they have in mind the best results, take into account the manner in which turns have to be made in order to avoid skidding on the one hand, and undue tire depreciation on the other. This is not to say that makers of cars can do anything about the skidding question if the speed is higher than the law allows for a given radius of curvature, in view of the effect of

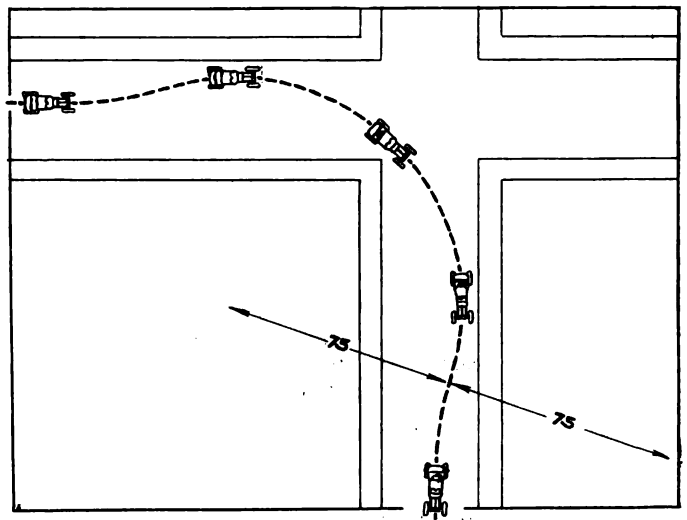

Fig. 2.—Corner clipping orbit of the average driver.

centrifugal force, as previously stated. What the makers can do is to avoid certain tendencies, within limits.

Ackerman, in the eighteenth century, discovered that a vehicle, on a curve, to perform properly, had to be provided with such tierods for the front wheels as would enable them, respectively, to roll on independent orbits, not to a common radius, but from a common axis. Fig. 4 is offered to illustrate the point

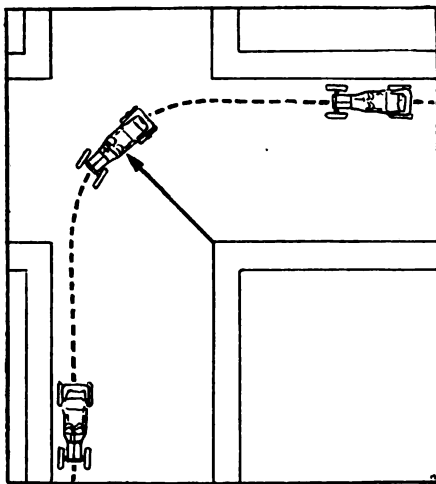

Fig. 3.—In legal driving keep to the right.

to be made, in which it is shown that true rolling motion of all the wheels will be realized when the car is going straight ahead. When the wheels are canted, as in negotiating a curve, if the tierod arms are parallel, since they are connected by a rigid tierod in practice, the radius O A will be the inner wheel radius C C', of turning, but the outer wheel will cant to the same angle, and

upon the governing conditions in practice. If it is true that the average turning radius is, say, 75 feet, as given in Fig. 2, this is the distance to use in the diagram Fig. 6 as the value of O A. The distance b equals the wheelbase of the car, and a is equal to the distance between the two pivots of the right and left steering knuckles. Thus far it has not been necessary to do any

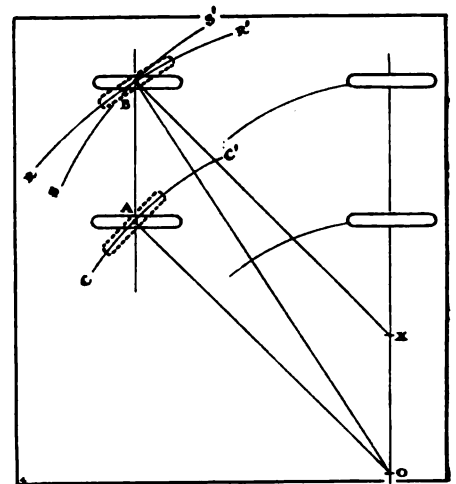

Fig. 4.—Tendency of wheels to drag.

the arc S S' will be described, which arc is not parallel to the arc C C', and the wheels will not roll perfectly; in fact, the outer wheel will drag.

But if the dragrod arms are to the rear of the axle and converging, in the manner as will be presently shown, it is then that the two front wheels will roll on parallel orbits to a common center, O, Fig. 4, and the inner wheel will have a radius O A, while the outer wheel will have a radius of turning O B. As the figure shows, the arc R R' is parallel to the arc of the circle C C', under which conditions the wheels will perform their functions without dragging, and the tires will avoid damage in the process, because parallelism will be maintained.

Ackerman-Jeantaud System of Steering.—This definite advance over the original idea of Ackerman is illustrated in Fig. 5, in which the arms O L and O' L of the tierod L L converge to the rear, and are parallel to, and cut by, the line A L O on the right side, and A L O' on the left side. The point A is at the center of the rear axle. In turning, the point A moves out on the rear axle plane to the point A', with the result that the turning radius of the car becomes that of the radius A' O' for the inner wheel, and the radius of turning of the outer wheel becomes A' O, so that the two canting wheels turn on parallel orbits around a common axis, A'.

Obviously, the arms L O and L O', instead of converging to the rear, would serve just as well if they were made to diverge to the front, provided only they be designed to remain in the same plane as a projection of the line A O for L O and A O' for L O'. This is not always possible in practice, because the spokes of the road wheels are in the way.

Characteristic Illustration of Common Practice.—Practice leaves its earmarks on everything, and the Ackerman-Jeantaud system of steering gear is no exception to the rule. In some shops the manner in which the problem is dealt with is illustrated in Fig. 6; one of the advantages is due to greater accuracy in the cases involving a turning radius of more than that due to 30 degrees cant of the steering road wheels.

Considering the diagram, Fig. 6, it is first necessary to decide

figuring, and all that remains is to fix upon the angles m and n.

It will be remembered that the radius 75 feet is not the turning angle of least radius; it is the most likely radius, all things considered. Under the circumstances, to be able to establish the relative angles, m and n, it is to proceed as follows:

$$\begin{aligned}
 & AC \\
 (1) \dots \cot m &= \frac{CO}{BC} \\
 (2) \dots \cot n &= \frac{CO}{a} \\
 (3) \dots \cot n - \cot m &= \frac{BC - AC}{CO} \\
 (4) \dots \cot n &= \cot m + \frac{a}{b}
 \end{aligned}$$

Tabular Values Save Calculations.—While it is always desirable to know the method by which results are arrived at, it is important to see things as in a "bird's-eye view," in order to realize something of the relative advantages. Then, it is to avoid mistakes if tabulations are made, since they can be done on a leisure basis and mistakes can be discovered and corrected. With these advantages in the mind's eye, the tabulation here offered takes into account the several likely canting angles of the steering road wheels of automobiles, and the effect of the length of wheelbase may be seen at a glance.

As an illustration of the use of the table, it will be enough to call attention to a car with a 100-inch wheelbase, which shows beneath a 15-foot turning radius if the wheels are canted 45 degrees from the center. In like manner it will be possible to fix upon the turning radius, in feet, for all cars up to 116 (inclusive) wheelbase for all canting angles between 34 and 46 degrees from the center.

Importance of the Equalization of Power.—While it is true that the question of steering is ordinarily regarded as a simple operation, in which guiding the car is the main feature,

TABLE SHOWING THE SHORTEST TURNING RADIUS OF AUTOMOBILES.

ANGLE OF INNER WHEEL DEGREE	LENGTH OF WHEELBASE IN INCHES AND TURNING RADIUS IN FEET												
	92	94	96	98	100	102	104	106	108	110	112	114	116
35	17	17	18	18	18	18.5	19	19	19	20	20	20	20
36	17	17	17.5	18	18	18	18.5	19	19	19	19	19	20
37	16.5	17	17	17	17.5	18	18	18	18.5	19	19	19.5	20
38	16	16.5	17	17	17	17.5	18	18	18	18.5	19	19	19
39	16	16	16	16.5	16.5	17	17	17	18	18	18.5	19	19
40	15	16	16	16	16.5	16.5	17	17	17.5	18	18	18	18
41	15	15.5	16	16	16.5	16.5	17	17	17	17.5	18	18	18
42	15	15	15.5	16	16	16	16.5	16.5	17	17	17.5	18	18
43	15	15	15.5	15.5	16	16	16	16.5	16.5	17	17	17	18
44	15	15	15	15	15.5	16	16	16	16	16.5	17	17	17
45	14.3	14.5	15	15	15	15.5	16	16	16	16	16.5	17	17

NOTE.—The distances in feet in the body of the table are given in the nearest (above) feet, and fractions of feet, on the ground that further accuracy would be uncalled for.

it is nevertheless useless to go through the process unless the car will mind the helm, so to speak. The steering wheel is almost the least device to be given consideration in the process.

The power is delivered to the traction wheels, usually the rear wheels of the car, and since the two traction wheels do not always travel at the same speed, some means must be provided by which the power can be equalized. If the power is not equalized, it is then that skidding will be likely, since the ability of each of the wheels is limited, and each must do its share.

But the share of work that must fall to each traction wheel is a variable depending upon the road conditions, speed of the car, curvature of the road, centrifugal force, and all the other tendencies such as will cause the traction wheels to press more or less. If the load is equal on both wheels, and if the road is of the same texture under them respectively, then, if the car is on the "straight ahead," it is a fair inference that the power requirement will be the same for both of the traction wheels.

Unfortunately, there are the conditions under which the steering wheel will be the least needed; the car should tend to maintain its straight course, as previously stated, and it follows that when the steering gear is used the conditions of its use are quite different.

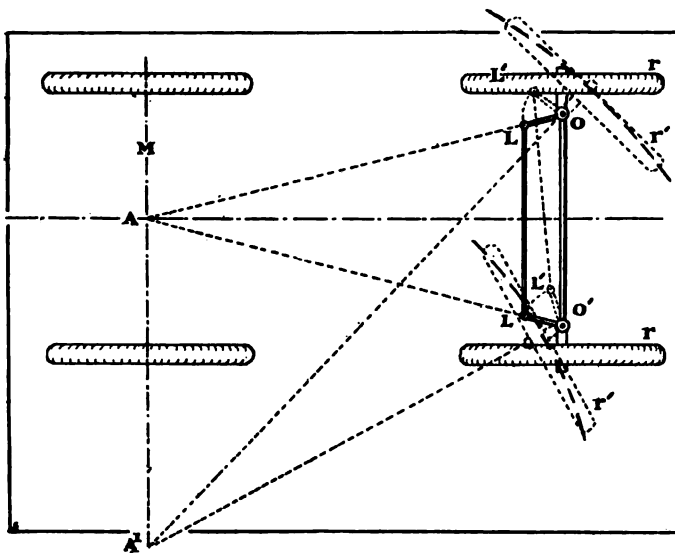

Fig. 5.—Characteristic Ackerman-Jentaud steering layout.

In order to be able to deliver the power in proportion to the respective abilities of the two traction wheels, it is the custom to use compensation gearsets (differential gears), which may be of divers designs, as square-cut or bevel types of gears. At all events, the purpose of the "differential" is to correct the evil tendencies, and, in a large measure at any rate, the use of the "differential" results in the equalization of the delivery of power to the respective traction wheels, thus aiding in the steering process, since skidding is aborted.

The complex nature of the "differential," and the curiosity it arouses in the haunts of owners of automobiles, demands an explanation of its peculiar action, at this time, on the ground that it is of great importance in connection with the steering operation, since it assures that a car will respond to the will of the operator as expressed by the steering wheel. Fig. 7 shows the arrangement of a bevel type of differential gear, in which A represents the bevel pinion which, in conjunction with its mate B, transmits the power of the motor to the differential housing C. Tracing the transmission further in its migration, it is to note that the spider D D serves as the means and the axis of rotation of the "satellites" E and E', through which the distribution is made to the gears F and F', which, in turn, are keyed to the differential shafts G and G', which shafts are in rigid relation to the traction road wheels.

The one remaining question is, How does the differential perform the distribution in delivering power to the respective trac-

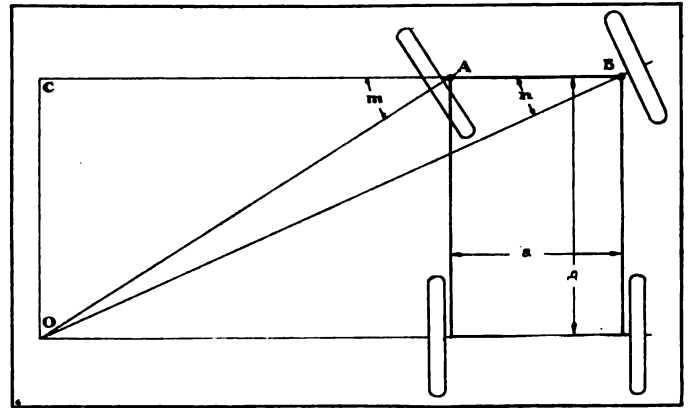

Fig. 6.—Practical method of laying out steering linkages.

tion wheels in proportion to their respective needs? Considering the source of torque to be the motor, which causes rotation of the pinion A, it is self-evident that this pinion, since it meshes with the gearwheel B, will compel rotation, and the direction will be as shown by the arrows, thus assuring that the housing of the differential gears will rotate in response to the motor, and to this extent there is no differential action whatsoever.

Since the satellites E and E' are free to rotate on the spindles of the spider D D, and considering that the spider D D is free to rotate on the bearing over the shafts G G', the satellites are free to respond to the tendencies in the manner as follows: (a) When the car is on a straightaway, the satellites merely serve as a balancing arm, weighing out to the planets F and F', equal increments of torque, and both road wheels rotate at a common speed, during which period the satellite pinions do not rotate, with their spider, around G G', nor will the same satellite pinions E E' rotate on their own bearings on the spindles of the spider D D. The whole housing rotates instead. (b) But if the car is negotiating a curve, it is then that the differential will have a function to perform, since the road wheel, on the inside, will make a less number of revolutions than the remaining road wheel. The result is that the speeds of the planets F and F' will not be the same, and during this time compensation will be due to rotation of the satellite pinions E and E', not only on the spider spindles D D, but the spider will also rotate on the shafts G and G'. During the period of this relative motion the ability to deliver power is in no way interfered with, and while the road wheels are enabled to revolve at different speeds, they are also driven, respectively, without cessation of torque, although it is true that the wheel traveling the fastest will measure the greatest result in horsepower.

What happens under other conditions, as on bad roads, is a matter which will not be taken up here, nor will certain other possibilities of the differential gear be interjected, on the ground that the situation would be unduly complicated. The point to be made here is that it is the action of the differential gear which enables cars to roll around curves, delivering power to both wheels without altering the "slip" relation of the wheels.

(To be continued.)

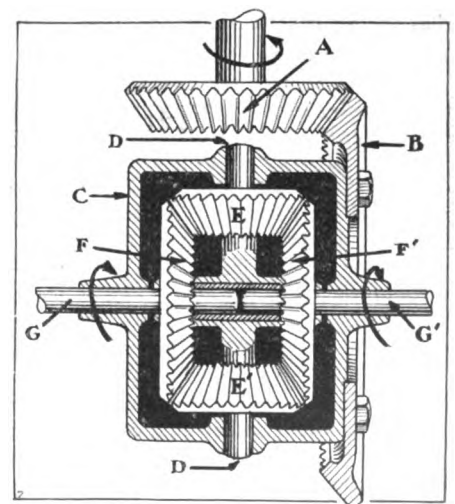

Fig. 7.—Bevel differential gears set.

HOW ONE AGENT VIEWS THE SELLING PROPOSITION

By A. D. HARD, MARSHALL, MINN.

THE methods now in use by which automobiles are finally sold to actual users by local agents does not differ much from those by which any valuable piece of merchandise is marketed. But back of the final sale, the plans by which the manufacturer places his product in the hands of dealers is peculiar to the automobile business alone. Men of considerable business ability have tried to evolve a scheme of selling by means of which certain evils might be eliminated and advantages secured, but from careful observations and investigations made for the purpose I am convinced that they are at present following plans which must very soon be altered or abandoned.

In my investigations I have commenced at the retail end of the selling proposition and worked backward toward the manufacturer. The scope of my observations includes only several small cities in southwestern Minnesota and western South Dakota. The roads in this region of country in their natural condition are favorable for automobile use a greater portion of the year, and the people are above the average in wealth and refinement. They have money with which to buy pleasure, and they get it in automobiles. Outside of physicians and real estate agents, nearly all automobiles are used as luxuries.

A farmer will quit the plow at 3 o'clock, and, getting into his four-cylinder car, come to town to talk politics. The business man of the small towns will get out his touring car after business hours and take his family and friends to the city, thirty miles away, to attend the theater, and the women of the family will use the car as much or more than the men themselves.

The small city of Flandreau, South Dakota, with a population of less than fifteen hundred, has 54 automobiles, and one of them cost \$8,000. Madison, a similar sized city, some thirty miles west, has 42; Pipestone, twenty-two miles east, has over 30, and Luverne, a city of about twelve hundred, is the manufacturing home of the Luverne automobile, an assembled two-cylinder car of some pretensions.

The men who sell automobiles as local agents as a rule are much less able to own an automobile than those who buy for their own use. They cannot keep several cars in stock, therefore they sell from catalogs and demonstrations made by State agents in Sioux Falls or Minneapolis. In many cases the agent who sells the car is not the credited agent of the car that he sells, but by a bargain between him and some agent of that car in some other town nearby he is able to handle the sale and clear 10 per cent. profit. Agents in several nearby cities combined to accept one agency on the deposit-contract system, and then divide up the cars to suit themselves. This enables the agent to supply a customer with almost any car that he may prefer and still make as much net profit as though he was selling the car that he has the agency for. But the local agent does not sell many of

the cars that come to town. Several men who wish to buy cars will get together and arrange for one of their number to take a deposit-contract agency, and each gets his car at wholesale price. The agency is then not pushed at all, and, as no other agent can be given a contract in that town, no more of that make of cars are sold in that place.

It is a very easy matter for agents in several nearby cities to bunch their orders, and the manufacturer wonders why he is not able to secure a deposit-contract agency and send more cars into that territory. The State agent does not feel the loss, as he puts out all the cars that he has deposits on, and, as the demand at present is about equal to the possible supply, he is satisfied with the big discount which the manufacturer has been compelled to give, in order to get him to handle this system of selling. One reason that agents are combining to evade the restrictions of this deposit-contract system is because the proportion of the 30 per cent which the manufacturer sets off for the middlemen is divided in such a way that the man who works to make sales and takes risks not asked for in other lines of business gets but one-half the profit of the sale. His 15 per cent is further cut into by the various expenses of the business until a paltry 10 per cent is left as profit on a sale that it takes months to make.

Under these conditions, which do not apply to large cities, an agency for automobiles is not a very alluring proposition. The ultimate effects of the combinations of single buyers and trading in agency products comes back to the manufacturer. It does not affect the State agent very much, as the cars that reach any customer comes through his hands and drops 15 per cent in his pocket, no matter whether they go to clubs or to a bunch of agents represented by one contract. The local agent has not made many sales, nor has he made much money in the business, and he loses all interest in pushing the business next year. The next year the manufacturer will begin to realize that he has not only sold his cars at a big discount, but the discount given has not resulted in building up a permanent or reliable demand because the local agents are not pushing sales.

Already the deposit-contract system is beginning to disintegrate by secret evasion of the restrictions by manufacturers and State agents, in order to get ahead of competitors. I have on my desk a letter offering to waive the deposit clause and allow me to get cars for spot cash as wanted, one at a time.

One of the largest manufacturers of automobiles in the United States has just sent one car here to a party at wholesale price for private use on an open agency proposition. Five persons here have formed a club and taken an agency for a well-known car in order to secure the 15 per cent discount on their own private cars.

THE DIFFERENT IMPORT DUTIES ON TIRES

WHEN auto tires are imported as tires in shipments of tires the customs duty upon them is 30 per cent., but when they are brought into this country in the same crate as an automobile, even though they have never been put upon the wheels of the car, the rate is 45 per cent. This is according to a decision made last week in the United States Court of Appeals in New York upon a case appealed from a similar decision by the Circuit Court by the Auto Import Company, of New York City, which had received a shipment of automobiles in which the tires were simply enclosed in the same crates, but had never been fitted to the wheels of the cars.

This company brought up the test case, holding that the tires should be taxed at a tire rate, but this contention was overruled by the court, it being held that automobiles and their tires are

entireties. In making this decision, Judges Lacombe and Ward concurred, but Judge Noyes dissented, giving as his opinion that inasmuch as it was problematical as to whether the identical tires which were received in the crate would ever be put upon that car, they should be received at the lower rate, there being an appreciable difference in the case of four expensive shoes and tubes.

As a result of the pending enforcement of the German liability law, at present before the Imperial Diet, every class of persons professionally interested in motor cars have united into one great opposing force, as all regard the measure uncalled for, untimely, ill-advised, and a severe handicap on the industry, which is just again collecting its strength after the universal financial crisis.

Letters Interesting and Instructive

DIRECT ON THIRD AND FOURTH SPEED.

Editor THE AUTOMOBILE:

[1,782.]—(a) I have read about a car in which the transmission gear set is devised for "direct drive" on the third and fourth speed. Please illustrate the idea.

(b) Does the speed of an automobile motor depend upon the sizes of the valves?

(c) Are the articles by Thomas J. Fay to be published in book form, and, if so, when?

Ishpeming, Mich.

C. A. S.

(a) The "Berliet" is one of the cars so designed that the transmission gearset is contrived for direct drive on the third and fourth speed. The plan is as shown in the illustration here given. As will be seen, two bevel-gear sets are used, and, since they are sleeved, it is possible to shift the one or the other at will for the purpose.

(b) The speed of a motor will increase as the result of larger valves, more commodious passageways, higher compression, better timing of the valves and the spark. Also if the design can be improved so that the mechanical efficiency will be on a higher level. It is assumed that you mean that the power should in-

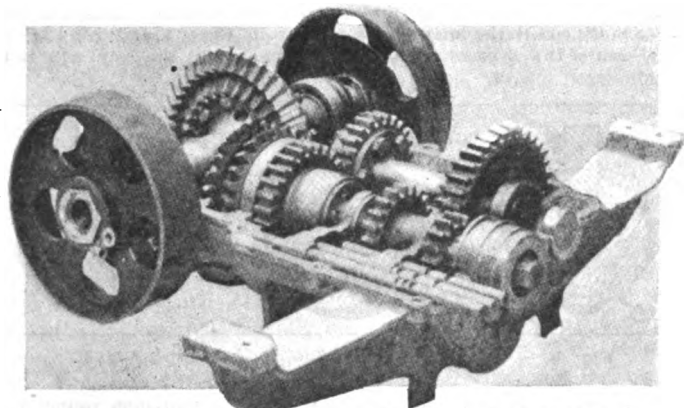

Berliet, Illustrating Direct on Third and High Speed.

crease as well. There are limitations to the increase that can be realized since pre-ignition will follow if the compression is increased beyond a certain point, which might be about 95 pounds per square inch, absolute. Then, it is true that valves will warp if they are too large to withstand the heat changes and the strains which follow.

(c) A date cannot be fixed for the issue of the writings of Thos. J. Fay in book form.

RELATION OF GEARS TO TIRES.

Editor THE AUTOMOBILE:

[1,783.]—Will you kindly tell me in "Letters Interesting and Instructive" which type of transmission—planetary or sliding—is the better, from the point of view of endurance, and if the planetary is easier on tires; also, if it is true that speed changing is attended with jerks, if sliding gears are used?

Allentown, Pa.

TRANSMISSION.

The planetary has a certain useful range in automobile work, and while this zone, if such it might be called, has been invaded by the sliding gear system, it is true, nevertheless, that the planetary system has held its own. On the other hand, the sliding gear system is of undoubted ability, capable of serving in the most exacting work, and it is highly improbable that any concrete comparison between the two types of transmissions will be of any value. From the tire point of view the more speed changes there are the better. But the planetary furnishes the equivalent of speed changes in starting a car, since the bands can be slipped.

FIERCE ACTION OF MULTIPLE DISC CLUTCH.

Editor THE AUTOMOBILE:

[1,784.]—Please tell me what to do to stop "chattering" in my multiple-disc clutch, when the car is starting from rest. The clutch appears to slip harshly, through a small arc, let go, and repeat, several times, in rapid succession at certain critical points during the engagement process. The clutch seems to be of ample proportions as it does not slip in regular running when the lubricant used is not too thick. The thrust bearing is in good shape.

This "chattering" is destructive to the car and annoying to the occupants. As the makers have no suggestions to offer I will be obliged for your solution of the difficulty.

New York City.

R. R.

For some reason the engaging pressure is too abrupt. This could be due to discs of small diameter, brought suddenly into high-pressure by a stout spring. The oil used probably is not the best for the purpose, it is too thin, that is to say, it has not the requisite body. Then, it is too persistent. For clutch lubrication the oil must possess peculiar properties which are not generally well appreciated. What you will have to do is to select a lubricant for the clutch in which the properties will be about as follows:

(a) The body of the oil will have to be pronounced; a fairly heavy cylinder oil, such as will answer well in the cylinders of your motor, will serve the purpose.

(b) This oil, alone, will be of very little value for the purpose, for the reason that it will not squeeze out excepting under very high pressure, and even then it will "flatten" to a very thin film, rather than squeeze out. To give this oil the property of primary lubrication, and to afford it the facility of running out from between the discs, after it has served the purpose, involving a time element in the process of accelerating, it will be necessary to add kerosene.

(c) The amount of kerosene to add, cannot be stated definitely in the absence of information in relation to the lubricating oil which may be used and certain clutch-mechanism characteristics having bearing upon the performance.

(d) In usual cases it is the custom to use cylinder oil and kerosene in equal parts and the results seem to be very good indeed.

In the mean time it is not proper to "slam" the clutch into instant engagement. Nor should the motor be "raced" at the moment of engaging the clutch. The transmission gear set is provided with speed changes for the purpose of enabling the acceleration to take place in gradual increments; unless advantage is taken of the presence of the speed changes it is assured that they are either useless appendages or, they should be used for the intended purpose.

Finally, if the clutch persists in its "fierce" action after the lubrication is adjusted, it is the spring that will have to be modified in some way, in order to give it more limber properties, but the chances are the spring will not have to be touched if the lubrication is properly adjusted and if the car is properly driven.

THE KERNEL IS UNDER THE HUSKS.

Editor THE AUTOMOBILE:

[1,785.]—You say: "There is no occasion for having a full complement of balls, if the bearings without a full complement are properly selected." It will be interesting to know exactly what you mean by this expression. How would you proceed to properly select a bearing without a full complement of balls that would be more effective than a bearing with a full complement?

You say further, "You show utter lack of knowledge of the subject in thus attempting to maintain that a ball bearing increases in ability in direct proportion to the number of balls used."

According to Striebeck,

$$P = kd^2 \frac{Z}{5}$$

Where k is a constant depending on the properties of the material and the form of the ball race.

d is the diameter of the ball.

Z is the number of balls.

Now, let us take two bearings made of the same material and having the same form of race and the same dimensions, both of the balls and races. Then, if Z_1 and Z_2 are the number of balls in each bearing, and P_1 and P_2 the corresponding carrying capacities, we have

$$P_1 = \frac{kd^2}{5} Z_1;$$

$$P_2 = \frac{kd^2}{5} Z_2;$$

and $\frac{P_1}{P_2} = \frac{Z_1}{Z_2}$; or, in other words, the carrying capacities of the

two bearings are directly proportional to the number of balls.

New York City.

ASHER GOLDEN.

The difference between the facts as depicted by Stribeck and your version lies in the license you take with the figures. You cannot, in a given set of raceways, increase the number of balls, unless the diameter of the balls are decreased. Under the circumstances it would seem as if the use you make of the formula is quite beyond its normal scope. Then, there is a certain irrelevancy about the example you cite which is so self-evident as not to require further discussion.

BALL BEARINGS DEPEND ON ACCURACY.

Editor THE AUTOMOBILE:

[1,786.]—In the discussion now going on in your columns in regard to ball bearings, it seems as if several material points have been overlooked thus far, or at least have not found expression in type. The load carrying capacity of a ball bearing depends not only on the number of balls, but also on the accuracy of both balls and races. Given a bearing with balls exactly spherical and uniform in size to the last thousandth of a millimeter, running between races every element of which is a perfectly true circle; assuming also that the balls and the races are of uniform hardness over all the contact surfaces, it follows inevitably that the load carrying ability of the bearing will bear some rough relation to the number of balls used. This, of course, on the assumption that the balls and races are of the same size in both cases.

Furthermore, the life of the bearing will be increased in substantially similar proportion for equal loads. It is a known fact that even the best ball bearings wear somewhat, although the wear is very small. When analyzed this simply means that each revolution of each ball represents a certain minute wear, whose amount, other things being equal, will bear some relation to the load the ball sustains. Reduce the load per ball by multiplying balls, and the life of the balls will be increased; though possibly this may not hold true of the races, since, what is saved in wear per ball revolution is lost by the greater number of balls going around in a single revolution of the shaft. Incidentally, the same reasoning shows why the life of a bearing is shorter under high than low speeds for equal loads. The wear is simply proportional to the total number of revolutions in the given time.

From the above it follows that if the balls and races are not sufficiently accurate to distribute the load, little is gained by adding balls, since three balls at most will carry the entire load. In other words, the load cannot be distributed among a larger number of balls than three, and it may be borne wholly by a single ball, which must be strong enough to resist crushing. In this case, the only gain from multiplying balls is that the load is transferred more quickly to fresh groups of balls, so that an individual ball carries its maximum load through a smaller arc of revolution.

In a word, the question of load-carrying ability and endurance cannot be divorced from the question of accuracy in size. If the limit of error is well within the compressibility of the balls and races under the loads they sustain, this minute compression will suffice to transfer excessive loads from the larger or irregular balls to the smaller or more uniform balls.

The statement of Mr. Golden in your issue of February 25th, that "when a radial bearing having a filling slot is subjected to end thrust the balls are pinched at the slot, resulting in rapid wear to both balls and races," is true only of bearings in which the balls come in physical contact with the inner end of the filling slot. In the best bearings made to-day with filling slots, these slots are shallower than the ball paths, so that the balls must be sprung in under a greater pressure than they can possibly receive in service. Once in, they never again touch the slot, which virtually no longer exists. In such bearings the ability to endure end thrusts is roughly in proportion to the number of balls provided the requisite standard of accuracy is maintained.

New York City.

J. B. BRETZ.

THE VALUE OF ACETYLENE AS FUEL.

Editor THE AUTOMOBILE:

[1,787.]—I read with a good deal of interest the discussion in "Letter No. 1763" in relation to the use of acetylene as a fuel in automobile motors, and it was my privilege some years ago to see a vehicle of this sort, built by some people in a northern New England State. This car was provided by a carbide feed generator.

At the time I gave the matter considerable thought, reaching the conclusion that nothing could come of it commercially. The cost would be excessive from the point of view of gasoline, since it is approximately possible to realize a horsepower using 1 pint of gasoline. This would cost about 1.9 cents. Now, even assuming that acetylene is 3.28 times more powerful than gasoline, it is also true that the cost of the necessary 6 cu. ft. of gas would require the use of $1\frac{1}{2}$ pounds of carbide at a cost of 15 cents.

If the average automobile is provided with a tank for gasoline that will hold 10 gallons, the fuel in the tank would weigh about 120 pounds, which represents the amount of carbide that could be carried without increasing weight. Then there is the water to use in dissolving the carbide, so that double the above weight would have to be considered as the least figure. Without going into further detail, it is plain to be seen that acetylene is not so very attractive at the present time. Nor is any account taken of the troubles which will follow the use of a carbide generator on a large scale. It will be remembered that carbide generators as used in lighting give about all the trouble that can well be tolerated due to the lime formation as a residue.

HAROLD H. BROWN.

Boston, Mass.

HOW TO KEEP A WHEEL ON AN AXLE.

Editor THE AUTOMOBILE:

[1,788.]—In "Letter 1755," R. R. Kelsey mentions trouble in keeping the rear wheel keyed tight on the driving axle. This can be accomplished in the manner as shown in Figs. 1 and 2. Fig. 3 represents the present conditions under which the key will not hold.

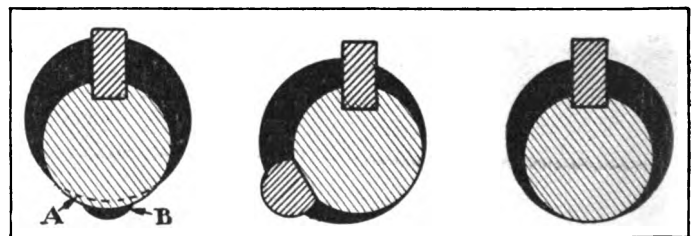

Fig. 1.

Fig. 2.

Fig. 3.

Fig. 1 represents the first method. With a half-inch round file make groove at A, opposite keyway, clear through hub. Then file off the portions at B with a half-round file until the shaft bears on hub for one-quarter inch width each side of groove A. Groove A must be not less than three-eighths inch wide after the work is done. This groove is just as important as the bearing surface each side of it. The keyway in the shaft should be planed or milled to a better condition, and the keyway in the hub can be filed to match. The only objection to it is that, theoretically, it throws the hub "off the center" a little more than method number two.

For the second method, take a piece of iron of the same size of shaft and wedge it into the hub and drill a one-half inch hole half in the hub and half in the iron, one-third, 120 degrees around from the keyway, clear through the hub. This gives a half-round keyway in which a piece of steel is easily fitted to make a raised part in the hub, which gives us a three-point bearing.

When inspecting the machinery of the car, hit this key with a hammer, and if it shows signs of loosening up, take it out and put a thin piece of tin under for a shin.

Fulton, N. Y.

C. V. ARMSTRONG.

LIKES THE HIDDEN TUBE IDEA.

Editor THE AUTOMOBILE:

[1,789.]—I have just noticed in your "Letters Interesting and Instructive" the suggestion by F. W. Ferguson (1,759) in regard to elimination of the flexible tube, connecting horn and bulb, and mentioning internal piping arrangement. I entirely agree with Mr. Ferguson, having broken two tubes myself, and know that they are the bugbear of cleaners and wipers, besides destroying, by a homely curved line, the sweeping horizontal lines of beauty of the body.

So I have invented a simple system of concealed piping which a well-known manufacturer has taken up and will use on all 1910 models—possibly on some of the 1909 cars as well. Mr. Ferguson certainly has the right idea, and I am surprised that the matter has not been taken up before.

St. Louis, Mo.

JOHN GULLY COLE.



King Alfonso of Spain Congratulates Wilbur Wright.

PARIS, March 4.—Minister of Public Works Barthou is such a great admirer of Wilbur Wright that on a recent visit to the district of Pau he rushed out to the aerodrome at Long-Pont and requested a second journey in the flyer. There was only half an hour to spare before the train left for Paris, but it was not many minutes before the machine was made ready and off with the minister and pilot aboard. For ten minutes Wilbur Wright showed his skill as a flyer by describing circles, soaring up and sweeping down, then passing over the heads of the spectators sufficiently high to clear them, but sufficiently low for the Minister to shout down a message. When M. Barthou had rushed for his train, his private secretary was initiated to the joys of a flight.

Two of the Wright pupils, Comte de Lambert and Paul Tissandier, are now efficient in the handling of the flying machine, and although they have not yet been aloft alone, have made several journeys of 20 minutes' duration without the intervention of the teacher. The training of the third pupil, Captain Lucas Girardville, will commence immediately, and it is expected that by the end of March three men will be fully capable of driving the machines. King Alfonso, of Spain, was a recent visitor at Pau, and evinced much interest in the flights.

DATES ARRANGED FOR AERONAUTICAL SALON.

PARIS, March 3.—Paris will have an aeronautical salon in the Grand Palais next Fall, probably from October 2 to 17. Aeroplane constructors, dirigible-balloon builders and automobile constructors interested in the manufacture of light-weight motors have formed a union which will take care of the exhibition. An interview has been had with the Under Secretary of State responsible for the palace in the Champs-Elysees, with the result that assurance has been given that the hall will be placed at the disposition of the flying-machine men. Although no attempt will be made to hold an elaborate show, and heating and light expenses will be cut out altogether, the number of those forming the union is sufficiently high to assure a successful event. Apart from those directly interested in the construction of flying machines, the following automobile firms are actively interested in the movement: Renault, Fiat, Bayard-Clement, Esnault-Pelterie, Gobron, Darracq; two tire firms, Michelin and Continental.

The show cannot be regarded as other than a rival to the annual salon held by the Automobile Club of France. An attempt was made last year to put on foot a separate aeronautical show, but the French club stepped in and arranged for its incorporation in the commercial vehicle section, thus keeping all shows in its own hands. With an independent show for flying machines, and most of the big French automobile firms refusing to have anything to do with the 1909 salon, the task of the national club is not an easy one.

GERMAN AERONAUTICAL NEWS.

BERLIN, March 1.—A new German airship is being built by Dr. Wagner, of the Stettin "Vulcan" Wharf, in connection with the chief engineer of the Kiel Howaldto Wharf, which is to be a combination of the rigid and non-rigid systems without embodying any of their drawbacks. Neither wood nor aluminum will be used, but layers of papierolyn instead, alternating with various fabrics, such as batiste, linen, and unbleached silk, muceous, and steel wires. This will all be welded together and the airship built of the finished material, which is said to be much more durable than either steel or aluminum. Steps have been taken to finance the new concern and acquire the somewhat complicated plant for the preparation of the material. A million marks would be necessary, this including two airships as well, of which the first is designed in a size of 9,000 cubic metres, capable of covering about 65 kilometers in the hour, the shape somewhat resembling a Zeppelin.

Orville and Wilbur Wright have contracted to appear in Berlin in the fall to give an exhibition of their aeroplane. After the various ill-successes of Zipfel in the German capital with his Voisin machine, huge interest is being aroused by the fact that the Wrights' visit is definitely settled.

The project of a German autodrome will not take shape until next year, as the newly founded and most influential company to finance such has deemed it best to wait until the industry has quite thrown off the effects of the depression it has been passing through. Prince Henry of Prussia was present when this decision was arrived at.

SANTOS-DUMONT'S FEATHERWEIGHT FLYER.

PARIS, March 4.—With the return of the fine weather Santos-Dumont's diminutive flyer has again been brought forth for daily exercise. The machine, which holds the record for lightness and smallness, has been modified during the winter, and is now fitted with a two-cylinder, opposed air-cooled engine built by Dutheil-Chalmers. The power plant is above the main bearing surface, and in the slight angle formed by the two wings. The wooden, two-bladed propeller is mounted directly on the engine shaft without the use of a reducing gear. Below the wings is the driver's seat, composed of a piece of canvas stretched from two of the frame members and only five or six inches from the ground. All complete the aeroplane only weighs 330 pounds.



Santos-Dumont's New Diminutive 330-Pound Aeroplane.

AEROPLANE RACES FOR CHATEAULAND IN AUGUST

PARIS, March 3.—American automobilists contemplating a tour through Europe this summer can fix on two districts to visit if they are interested in aeroplane flights. The plains around the old city of Reims will be alive with the hum of mechanical birds at the end of August, and Chateauland will have artificial flyers during the month of September. Both districts are excellent for touring purposes, and will doubtless retain many a car and its occupants from distant parts.

The Reims programme is at present the most complete, and appears likely to be the most attractive. Starting on Sunday, August 22, and continuing until Sunday, August 29, there will be five distinct flying events, comprising an endurance test, a 30-kilometer speed test, a short-distance speed test, a high-flying test, and a race for passenger-carrying aeroplanes. In addition it has been decided that the Gordon Bennett Aeroplane Trophy, to be competed for by national teams of three, shall be included in the Reims programme. There will probably be a French elimination race on Monday, August 23, to pick out the three national champions, and the final race for the Cup on the following Sunday.

The important feature of this event is that all the items on the programme are within the capabilities of present-day aeronauts,

and all prizes should be won. Unlike the Monaco meeting, and many of the private races announced for the coming season, there is no special element of danger in the Reims events, and no attempt to set the flyers an impossible task. Even the Gordon Bennett race only requires a minimum of 30-kilometers on a closed circuit, a task which at least thirty machines should be capable of accomplishing before the month of August.

Apart from the Gordon Bennett trophy and money prize accompanying it, the district has raised the sum of \$40,000 to be devoted to the aeronautical week. The situation is ideal, the plain being at the very doors of Reims, within 90 miles of Paris, and easily reached from England, Switzerland, Belgium and Germany.

The main feature of the Chateauland aeronautical week will doubtless be the holding of the Aero Club of France Grand Prix for aeroplanes, an event which must be competed on a closed circuit, the minimum distance to be about 30 kilometers. The sum of \$20,000 is being raised toward a prize list, this amount to be spread over several events for flying machines. The details of the programme have not yet been drawn up, nor has the exact date been fixed, but it is probable that the week chosen will be early in September.

SILVER DART FLIES EIGHT MILES.

BADDECK, NOVA SCOTIA, March 8.—Douglass McCurdy, in the big aeroplane, *Silver Dart*, by flying eight miles in eleven minutes and fifteen seconds to-day, established a new record in the work of the Aerial Experiment Association, which is conducting a series of flights here under the direction of Dr. Alexander Graham Bell, and doubling the length of its best previous flight.

After four preliminary flights, in which it was seen that the 50-horsepower motor was working splendidly, Mr. McCurdy started from the laboratory and droned over to Stoney Island and back, passing over Baddeck Harbor both times.

LABORATORY FOR AERO EXPERIMENTS.

PARIS, March 3.—The Aero Club of France wants a laboratory for aeronautical experiments, and proposes that the sum of \$40,000 shall be devoted to this purpose. The club is prepared to vote a substantial subvention toward the work, and looks for the remainder of the amount in the form of a Government subvention and private subscriptions. At the present moment the Government has the sum of \$20,000 to dispose of toward the encouragement of flying, and it is believed that some of this can be obtained for the laboratory, which will be established in or near Paris, and will be the first of its kind.

THE AUTOMOBILE CALENDAR

AMERICAN.

- March 11-13.....Milwaukee, Wis., Hippodrome, First Annual Show of Milwaukee, Automobile Club.
 March 13-20.....Minneapolis, Minn., National Guard Armory, Second Annual Show, Minneapolis Automobile Show Association. F. E. Murphy, Secretary.
 March 15-20.....Rochester, N. Y., Convention Hall, Annual Show, Rochester Automobile Dealers' Association. Chas. J. Moran, Exhibition Manager.
 March 22-27.....Toledo, O., Coliseum, Annual Automobile Show, Toledo Automobile Dealers' Association.
 March 27-Apr. 3..Pittsburg, Duquesne Garden, Automobile Show, Pittsburg Automobile Dealers' Association.

Races, Hill-climbs, Etc.

- March 23-26.....Daytona, Fla., Seventh Annual Florida Beach Races, Florida East Coast Automobile Association. New York Representative, W. J. Morgan, Thoroughfare Building.
 March 24-27.....Syracuse, N. Y., State Armory, Automobile Show, Syracuse Automobile Dealers' Association.
 April 5-10.....New York City, Carnival Week, New York Automobile Trade Association.
 April 10.....New York City, Fort George Hill, Second Semi-Annual Hill Climb of New York Automobile Trade Association.
 April 27-30.....Detroit, Mich., Four-Day Endurance Run, Detroit Automobile Dealers' Association.
 May 3-6.....Harrisburg, Pa., Third Annual Endurance Run, 700 Miles, Washington, Baltimore, Scranton, Motor Club of Harrisburg.

- May 18-19.....Norristown, Pa., Second Annual Endurance Run, Norristown Automobile Club, to Hagerstown, Md.
 May 22.....Hartford, Conn., 200-Mile Endurance Run, Hartford Automobile Club.
 June 1.....Start from New York, New York to Seattle Race, M. Robt. Guggenheim Trophy, to Alaska-Yukon-Pacific Exposition.
 June 11-12.....New York City, Two-Day Mountain Tour and Reliability Contest to Catskill, N. Y., and Return, New York Automobile Trade Association.
 June 21-26.....Binghamton, N. Y., Fourth Annual Endurance Run, Binghamton Automobile Club, Albany, Boston, Hartford, Newburgh.

FOREIGN.

Races, Hill-climbs, Etc.

- March 31-Apr. 14.Monaco, Italy, Annual Motor Boat Regatta and Championships.
 May 2.....Slilly, Targa Florio, Automobile Club of Italy.
 May 26.....Russia, Moscow—St. Petersburg Race.
 June 10-18.....Germany, Prince Henry Cup Competition.
 June 14-19.....Scotland, Scottish Reliability Trials.
 June 20.....France, Boulogne-sur-Mer Course, French Voiturette Race, auspices of "L'Auto."
 July 13-17.....Belgium, Ostead Automobile Race Week.
 August 22-29.....France, Reims, Aeroplane Races and Grand Prix, Aero Club of France.
 Sept. 5.....France, Mont Venteoux Hill Climb.
 Sept. 11-19.....Italy, Bologna, Florio Cup Race, Automobile Club Bologna.
 Sept. 19.....Austria, Semmering Hill Climb.

CONNECTICUT LEGISLATORS ARGUING OVER AUTO LAW

HARTFORD CONN., March 8.—That there is much opposition to the present motor car law is evident, and that it is due mainly to the indiscretion of a small thoughtless element, that never heed the fellow who walks or drives in rural sections is also a fact. Hearings were assigned last week for the discussion of the bills submitted to the present Legislature, some of which would put a decided restriction on the sport. Some of the bills would tend to improve matters. The hearings were before the committee on roads, rivers and bridges, in the hall of the House. Some of the remarks passed were decidedly antagonistic. One bill provides for the fitness of a person applying for a license, which shall be determined by the Secretary of State, and adopts substantially a part of the New Jersey law, which would eliminate the present "reciprocity" feature of the Nutmeg State law and compel every non-resident to register in this commonwealth, reduces the speed limit to 20 miles an hour outside the city limits, 12 miles within and compels drivers to bring their cars to a stop when approaching trolley cars not in motion.

The present law was thought to be a model one, and some so regard it at the present time. In the hands of sensible people it was a good law, but there is the road hog and the speed maniac and it is against them that the public needs some sort of protection. The present law is a good one, but some safeguards must be thrown about it.

Some of the speakers favored a stricter examination of the qualifications of chauffeurs, and ex-Representative Birdseye, of Farmington, an automobilist, spoke strongly in favor of the present law, and referred to a series of resolutions adopted by the Farmington grange, the gist of which were as follows: To secure uniform legislation throughout New England; to provide

an effective means for enforcing the law; to tax motorists according to horsepower; to have new markers each year; no colors to be duplicated within four years; to have all licenses expire December 31 of each year; speed limit to be placed at not over 25 miles an hour and 8 miles an hour around corners.

A. C. Judd, proprietor of the Hotel Elton, at Waterbury, spoke for the hotelkeepers, and stated that his establishment, which had been erected at a cost of \$400,000, would not pay expenses if it was deprived of the patronage of automobilists.

Walter S. Schutz, attorney for the Automobile Club of Hartford, said it seemed to be practically agreed that 75 to 85 per cent. of motorists are all right and proper. There are from 15 to 25 per cent. that have to be punished. He referred to that feature of the present law which provides that all convictions shall be reported to the Secretary of State. The records show that not one-third of such convictions have been reported and that the fault is with the authorities themselves. Autoists desire to see the man guilty of wrongdoing summarily punished. He suggested that some department of the State be given the enforcement of the law, and that the question of the revocation of licenses be lived up to. Make the law more specific, if necessary, by giving the Secretary of State the right to revoke licenses upon complaint of any violation without conviction.

It is a common impression in local circles that something will happen to the present law. Those who make the laws are well aware of the fact that the innocent always suffer for the guilty, but, nevertheless, the harm has been done and some one must pay the fiddler. Many members of the Legislature own and operate automobiles. Just how soon the matter will be put before the assembly for final action is a question.

COLUMBUS WANTS TO COLLECT LICENSE FEES.

COLUMBUS, O., March 8.—Automobile owners of Columbus are up in arms over the decision rendered by Judge Dillon, of the Common Pleas Court of Franklin County, holding that a municipality has a right to collect the automobile license, provided for in the vehicle license ordinance. When an attempt was made to enforce this, William M. Frisbie, a member of the Columbus Automobile Club, brought a test suit on the ground that the city ordinance conflicted with the State law. The latter provides for registration and identification of motors with a fee of from \$3 to \$5. The club secured a restraining order and the city auditor refused to accept any fees until the case was decided. The city solicitor took the case up with the result that the law was sustained.

At a meeting of the Columbus Automobile Club steps were taken to carry the case to a higher tribunal. One of the principal objections is the fact that the money sought to be raised by the license does not go for the improvement of the streets. The money received from the State department, on the other hand, save that used in paying the expenses of the office, goes to the good roads fund.

MARYLAND'S GOVERNOR FAVORS AUTO TAX.

BALTIMORE, March 8.—Governor Crothers is determined to have the automobilists of this State pay full taxes as set forth in the Swann automobile bill that they may pay their share of the cost, according to his figuring, of building and maintenance of good roads in the State. He declares that neither he nor the Auto Commissioner are anxious to do anything unconstitutional or to make motoring in this State a burden to owners of cars. Neither does he agree with the owners that they are being worked for oppressive taxation by those handling the bill. He points out that the rule applies to street railway companies which pay a license tax in addition to the general levy on their property.

MICHIGANDERS OPPOSE HORSEPOWER TAX

GRAND RAPIDS, Mich., March 8.—The Michigan State Automobile Association is making plans to oppose Highway Commissioner Earle's efforts to get an additional tax put upon automobiles. The latter's plans, as they mature, seem to be to have a bill introduced into the present session of the Legislature taxing automobiles owned and operated in the State ten cents per year for each horsepower, making the tax on a 60-horsepower car, for instance, \$6. This would be in addition to the annual registration fee of \$1, which autoists now have to pay, besides the personal property tax on the machine. The commissioner's idea is that automobiles do more harm than other vehicles to the roads and should be made to pay accordingly.

This, however, does not accord with the view of the autoists, and J. R. Jackson, president of the association, says the law will be opposed. "While the associated clubs through the State," says he, "are in favor of road improvements, and are willing to do even more than their share in bringing about improved conditions, such a measure as this would be gross injustice."

The dealers are also taking a hand in opposing it, claiming that it is class legislation, and that if an additional tax is needed for road improvements it should be a general tax on all vehicles, and not a fine on automobile owners for having machines.

NO AMENDMENTS TO OHIO LAW THIS SESSION.

COLUMBUS, O., March 8.—Several bills pending in the Legislature provide for amendments to the State law for the registration, identification and regulation of motor cars. None of the bills have been enacted into a law and some carry unreasonable features. One of the amendments provides for the painting of the number on a glass background to be shown by light during the night. Because of the fact that the Legislature will soon adjourn, it is not believed any material change will be made in the law.



Vol. XX Thursday, March 11, 1909 No. 10

THE CLASS JOURNAL COMPANY

H. M. SWETLAND, President

231-241 West 39th Street, New York City

EDITORIAL DEPARTMENT

A. G. BATCHELDER, Managing Editor

R. F. KELSEY, Associate Editor

THOS. J. FAY

MORRIS A. HALL

W. McKEAN WHITE

W. F. BRADLEY, Foreign Representative

BUSINESS DEPARTMENT

A. B. SWETLAND, Business Manager

LOUIS R. SMITH

FRANK B. BARNETT

W. I. RALPH, 1035 Old South Building, Boston, Mass.

C. H. GURNETT, } 1200 Michigan Ave., Chicago, Ill.

F. W. VAN SICKLEN, }

H. H. GILL, Detroit, Mich.

T. B. VAN ALSTYNE, Philadelphia, Pa.

Cable Address - - - - - Autoland, New York
Long Distance Telephone - - - - - 2046 Bryant, New York

SUBSCRIPTION RATES:

United States and Mexico - - - - - One Year, \$3.00
Other Countries in Postal Union, including Canada - - - - - One Year, 5.00
To Subscribers—Do not send money by ordinary mail. Remit by Draft,
Post-Office or Express Money Order, or Register your letter.

FOREIGN SUBSCRIPTION AGENTS:

ENGLAND:—W. H. Smith & Sons, Ltd., 186 Strand, London, W. C., and all book-
stalls and agencies in Great Britain; also in Paris at 248 Rue de Rivoli.
FRANCE:—L. Baudry de Saunier, offices of "Omnia," 20 Rue Duret, Avenue
de la Grande Armee, Paris.
GERMANY:—A. Seydel, Mohrenstrasse 9, Berlin.

Entered at New York, N. Y., as second-class matter.
The Automobile is a consolidation of The Automobile (monthly) and the Motor
Review (weekly), May, 1902, Dealer and Repairman (monthly), October, 1903,
and the Automobile Magazine (monthly), July, 1907.

SUCCESS IS KNOWN BY ITS COMPANY.

When the automobile was projected into the keeping of man, out of the fertile brain of genius, it presented a moot question, nor could fortune's predictor say that success would deign to permanently occupy a seat in the tonneau. At Boston, seven years ago, when the virgin New England show, as a debutante, rent the placid atmosphere with its siren call, it challenged all the chariots of the world to come and contend for success, and the spectacle was inspiring.

The refined of the "Hub" ventured forth and gathered in the arena to view with critical eye what was, to be sure, a somewhat meager exhibition of automobiles. But the sagacity, which is at the bottom of what is known as New England conservatism, pierced the future, and the show returned, a second time, after a twelvemonth, in better form.

From that day to this the Automobile Show has been an "event," and for seven years New England's representative people came in dignified, but increasing numbers, to witness the advances made, and to support the industry by substantial patronage. Each succeeding year has been a little better than the last, and that strange jewel, consistency, robbed dire prediction of its potency, while the automobile found a fitting response in the hearts of what is said to be the most conservative, nay, critical, audience on the North American continent.

Naturally, the commercial phase of the situation is as an echo of this New England approval of the automobile, and sales were made on a gradually increasing basis each succeeding year, until to-day it assuredly would require an upheaval of the imagination to tender justice to the situation. Boston is now a center of activity in the automobile zone, after which a deluge of excellent business is sure to follow.



INSTABILITY ACCENTUATED BY SKIDDING.

As the microscope unveils the microbe which may be at the root of a disorder, so does "skidding" disclose acute instability to an autoist who persists in driving around curves at high speed. The very condition of instability which is rendered manifest by skidding on a curve is ever present in cars directly they are guided out of the straight course, and designers as well as drivers must bow to the natural law which enables centrifugal force to overcome traction.

Of two prime sources of trouble, ill devised compensating gearsets (differential gears) should be looked upon as possibly the more serious. If the compensating gears fail to work one of the rear wheels must slip, and it is a property of traction to forfeit its potency instantly slipping begins. This point is adequately illustrated in brakes which fail to perform the braking function if excess pressure is applied enough to cause the wheels to slip. Obviously, the same phenomenon will follow if the differential gear sticks sufficiently to defeat compensation.

The second fault will be present if one of the steering road wheels must slip on a curve, which condition will surely follow if the tie-rod arms are not set properly. Unfortunately, it is impossible to locate these arms in such a way as to render their action universal, but they can be set for the radius of curvity likely to obtain in actual practice, taking into account the manner in which roads are built, with an eye to the free space at the intersections of streets, such as would invite speeding on a curve.

Beyond these fundamental considerations there is nothing to interfere with safety in driving cars around curves, excepting careless workmanship, inferior materials and "feather-weight" designing, unless it is that autoists want to play "bully bender," as boys are wont to do on a handy mill pond, but thinly veiled 'neath meager ice. There is no room in the automobile industry for men who persist in supporting any of these "pastimes," and one of the reasons is that innocent spectators must be protected from the gangrene infested.



TAXICAB PROGRESS REALLY WONDERFUL.

A study of the taxicab situation will convince anyone that the motor-driven cab is here to stay and must ultimately drive out the horse-driven rig. These convenient little vehicles may make money for the company operating them, but, regardless of this, the public have taken to them and will have nothing else. The larger cities are rapidly increasing their complement of cabs and it is a noteworthy fact that, no matter how small the city, no taxicab service, once started, has been withdrawn. An article elsewhere in this issue gives detailed figures for the number of cabs in use in large cities.

TROUBLE OVER CONTEST CONTROL UNLESS SIGNS FAIL

THERE is trouble brewing in the matter of control and sanction of automobile contests of all kinds, but particularly in the two more prominent branches, as races, tours or reliability runs. There was a time when the national governing body had the last word; what it said went, and the promoters of contests meekly obeyed. Now all that has been changed by ill-advised and domineering methods, which have antagonized even the friends of the "powers that be." From meek obedience of orders to open defiance is a far cry, yet that is the situation to-day. This spirit of revolt is not sectional, but general, and must inevitably result in some radical change. What this will be is hard to predict at this time, but when a club can plan a complete run, down to the last detail, and then write to the governing body and say (as did the Contest Committee of the Harrisburg Motor Club recently), "upon receipt of the proper official notification we are quite will-

ing to pay to your committee the sum of twenty-five dollars" (the sanction fee as quoted), it is self-evident that trouble is brewing, or, to descend to the language of the street, that there will soon be "something doing."

The chances are that very soon there will be a revolt, and the club mentioned above will doubtless be found in the forefront at that time. The attitude of manufacturers toward the present control is well known and will need no comment here. It is to be hoped, however, in this connection, that the new M. C. A. formed from the manufacturers and importers, will step in and assume control before the situation becomes chaotic and impossible. This is a step that must come as inevitably as to-morrow, and the sooner it comes and thus relieves the present strained situation, in which clubs are "quite willing" to pay for sanctions, the better it will be for all concerned.

A. L. A. M. MEETS AND ELECTS A NEW MEMBER

NEW YORK CITY, March 8.—At the important meeting of the board of managers of the A. L. A. M., held last Thursday, nearly every firm was represented, 26 of the 31 members being present. The report of the show committee made by Col. George Pope, its chairman, was enthusiastically received. The show was the most successful ever held, both as to receipts and business done by exhibitors. Over \$40,000 will be rebated to vehicle exhibitors and members of the Motor and Accessory Manufacturers' and Motorcycle Manufacturers' Associations. The rebate not only leaves in the hands of the show committee a large working capital for the next show, but is the highest rate of refund ever made to the exhibitors of a national automobile show, being an increase of nearly 40 per cent. over the rate of rebate of

the seventh automobile show at Madison Square Garden in 1908, and of nearly 100 per cent. over the rebate of the same show in 1907. A vote of thanks was accorded the show committee for their work. The same committee (Col. George Pope, chairman; Charles Clifton and E. P. Chalfant, with M. L. Downs as secretary) was appointed to conduct the tenth automobile show at Madison Square Garden, which will be held in January, 1910.

A new member was elected, and in this the city of Detroit scores once more. The latest addition to the licensed family is the Hudson Motor Car Company, of Detroit, Mich., named after its president, J. L. Hudson, one of Detroit's largest merchants. This is a new company, organized for the purpose of manufacturing a four-cylinder car, to be built in large quantities.

THEY, FRENCH RACING DRIVER, DEAD.

PARIS, March 9.—Francois Leon They, famous as a racing driver, died at his home here last night. He was born in Paris, April 16, 1879. After a fairly prosperous early career, in which he won many minor contests, in 1903 he entered the employ of Richard Brasier, with whose cars he had unusual success. In that year he won the French elimination tests and many other races. The next year, 1904, in the Gordon Bennett race over the Taunus course, starting from fifth position in an 80-horse-power Brasier, he surprised everybody by easily beating Jenatsky in a Mercedes. The time, 5:50:05, was at the rate of 53 miles per hour, then considered wonderful.

The following year, on July 5, over the Auvergne circuit, he repeated this performance in slower time. This double victory marked the height of his racing supremacy, for although always a big factor, he later failed to capture any of the larger events. He continued with the Richard Brasier firm up to his death.

GRAND PRIX PROMOTORS GET OFF EASY.

PARIS, March 3.—The Automobile Club of France has got out of its Grand Prix with a loss of \$800 only. Natives whose land had been rented for grandstands, etc., protested at the abandonment of the race, and certain villages spoke of suing for damages. The matter was settled, however, by the payment of the sum of \$800 to the organizing committee to be distributed as an indemnity to those persons who had actually entered into an agreement to rent their land. Medals will be granted to all commissaires who acted at the last Grand Prix races, and, this accomplished, the Racing Board has practically ceased business for twelve months.

FAMOUS THOMAS IS SEATTLE PATHFINDER.

NEW YORK, CITY, March 10.—To add to the laurels which it won in the race around the world, from New York to Paris, the famous Thomas car has now been slated for another strenuous trip, that of the pathfinder from Chicago to Seattle, of the race from this city to the Alaska-Yukon-Pacific Exposition. This has been arranged between the managers of that contest, and the E. R. Thomas Motor Company, of Buffalo, but as yet the car which will inspect the roads from this city to Chicago, if one is thought necessary, has not as yet been chosen.

The Thomas will leave this city on March 15, to run to the Windy City, where John Kane Mills will meet it and go over proposed routes from that point to the Pacific coast. It is expected that it will take at least a month to make the preliminary surveys, and should the mud of Nebraska be forbidding, a southern course, through St. Louis and Denver, may be selected.

KNOX DECLARED WINNER OF SWEEPSTAKES.

NEW YORK CITY, March 8.—The announcement was made recently that William K. Vanderbilt, Jr., referee of the Motor Parkway sweepstake races held on October 10, on the occasion of the formal opening of the Long Island Motor Parkway, has disqualified the Sharp Arrow car, which won in the Garden City class. This disqualification gives the first place and the prize to the Knox Model O, which was driven by William Bourque.

The races were open to stock cars, of which ten had been built previous to the race. It was upon this ground that the referee disqualified the Sharp Arrow, it having been proven to him that the competing car was the only one of its type that had been built. Consequently, the \$1,000 will go to Springfield.

What the Clubs are Doing These Days

SAVANNAH CLUB ELECTS OFFICERS.

SAVANNAH, GA., March 8.—At the annual meeting of the Savannah Automobile Club held last week the officers who so successfully guided the organization through the past year and superintended to a great degree the Grand Prize race, were unanimously re-elected. They are: Frank C. Battey, president; J. J. Rauers, vice-president, and A. W. Solomon, secretary and treasurer. The board of governors was chosen as follows: F. C. Battey, J. J. Rauers, A. W. Solomon, George W. Tiedeman, George J. Baldwin, Harvey Granger, F. M. Oliver, C. G. Bell, D. G. Rosenheim, Wright Hunter and A. B. Moore.

President Battey announced the appointment of the following executive committee: Chairman, Harvey Granger; vice-chairman, W. W. Williamson; W. B. Stillwell, George W. Tiedeman, A. W. Solomon, Albert Wylly, George J. Baldwin, Leopold Adler, J. A. G. Carson, F. C. Battey, T. J. Charlton, F. M. Oliver, A. B. Moore, J. J. Rauers, J. M. Dixon, W. B. Stephens, R. M. Hull, Abe S. Guckenheimer and S. E. Theus. Governor Hoke Smith, Governor-elect Joseph M. Brown and Robert Lee Morrell were elected as honorary members.

The splendid success which has attended each of the three races held here, especially the Grand Prize, leads the club to believe that it can get that great event for another time, and has decided to ask for it for next Fall. Pictures of the last race will be sent to every automobile club in this country. Plans for the annual country run, which is held in April, are about to be started. It is not known as yet where the course will be nor when it will be held, these points having yet to be decided, the many good roads giving ample room for choice.

ROCHESTER CLUB PLANS NEW ENGLAND TOUR.

ROCHESTER, N. Y., March 8.—At the recent meeting of the board of directors of the Rochester Automobile Club it leaked out that a long tour is planned for the coming Summer by Secretary Van Tuyle. This event, which is not so very far off, in reality, will include some of the most historic and picturesque places in the East, and will not be competitive in its nature. More than a score of the members immediately volunteered to participate, so that the success of the run is assured.

The purpose of the meeting was for the nomination of officers for the coming year. It was necessary to persuade President Henry G. Strong to run again, but after that was settled there was no difficulty in choosing the others. The rest of the nominees are: Vice-president, William C. Barry, Jr.; treasurer, Rudolph Schmidt; secretary, Bert Van Tuyle. Board of governors—George C. Gordon, F. E. Mason, John E. Morey, A. F. Crittenden, W. S. Hibbard, H. S. Woodworth and John S. Bingeman.

Other minor matters to be disposed of were the adoption of a club pin and the election of George C. Gordon as chairman of the banquet committee. This will be held March 29, in conjunction with the annual meeting. This happy date selection also catches the annual meeting here of the New York State Automobile Association, delegates to which will be entertained at dinner.

MARSHFIELD, WIS., TO HAVE AUTO CLUB.

MARSHFIELD, WIS., March 8.—An automobile club is to be formed in this city as the result of agitation by the Milwaukee Automobile Club, which is leading the fight of the Wisconsin State Automobile Association for better highways in the northern part of the State. All the wealthy lumbermen located here are owners of autos, and as the new club will be largely composed of them, wide influence will be exerted.

QUAKER CITY CLUB REINSTATES PREMIER.

PHILADELPHIA, March 8.—After a hotly contested fight to have its disqualification withdrawn, the Premier touring car which finished the New Year's Day run of the Quaker City Motor Club to Wilkes-Barre and return, with the only perfect mechanical score, but which was disqualified for having gone part of the way up Giants' Despair Mountain without its full complement of passengers, has been reinstated by the club, but with a penalty of 270 points on its time score, placing it thirteenth in the order of those which finished.

This was decided upon at a meeting of the new contest committee of the club recently. The record of the meeting says: "From the records of the observer in said Premier car, and from the official records of the Quaker City Motor Club, it appears that said car passed the checking station at Hazelton 7½ minutes ahead of schedule time and 25½ minutes ahead at the following checking stations: Hamburg, Reading, Pottstown, Norristown and at the finish." The penalty placed against the car was the total, 270 points, one point for every minute ahead of time.

President L. D. Berger has appointed the following to the contest committee, with two additional names still to be announced: Ferd M. Johnson, chairman; Fred C. Dunlap, R. E. Ross, G. Hilton Gantert, W. J. Donnelly, W. West Randall and F. K. Worley.

NORRISTOWN CLUB WILL RUN TO HAGERSTOWN.

NORRISTOWN, PA., March 8.—The contest committee of the Norristown Automobile Club has finally decided upon Hagerstown, Md., as the outer mark for its two-day endurance run which is scheduled for May 18-19. The intermediate controls have not yet been decided upon. The round trip will approximate 300 miles. A pathfinding expedition consisting of three cars—a Matheson, a Crawford and an Overland—will take a trip over the route as soon as the roads will permit.

At the annual election last Friday evening the following officers were chosen to serve during the next twelvemonth: President, John H. Rex; vice-president, Isaac A. Smith; treasurer, L. E. Taubel; secretary, William B. Hart. Board of directors—Lewis E. Taubel, Harry A. Wilson and William B. Hart, for three-year term; Samuel Roberts, John E. Mountain and Frederick M. Jaquith, for two-year term; Robert A. Jackson, A. H. Root and H. C. Carney, for one-year term.

COLUMBUS CLUB HAS REMARKABLE GROWTH.

COLUMBUS, O., March 8.—The Columbus Automobile Club, which recently opened elaborate clubrooms in the Northern Hotel, now has more than 300 members and is quite prosperous. Since the opening, about three weeks ago, the clubrooms have been, and will be kept open permanently, with the officers in charge. The regular meeting is on the first Monday evening of every month, with occasional club evenings. The following are the officers: Max Morehouse, president; Perrin B. Monypeny, first vice-president; George P. Stevenson, second vice-president; Herman Hoster, treasurer; Normal O. Aeby, secretary.

GRAND RAPIDS CLUB STILL AFTER A HOME.

GRAND RAPIDS, MICH., March 8.—The local club is still considering the project of building a new clubhouse, but the organization seems to be about equally divided as to whether the new building should be erected in the city or whether a suburban location should be chosen. A vote on the question will probably be taken at the next meeting.

PENNSYLVANIANS OPPOSE GRIM BILL.

PHILADELPHIA, March 9.—At the annual meeting of the Automobile Club of Philadelphia, at the Racquet Club, last night, a call was sounded for co-operation in the effort to put the Grim bill through the Legislature, now in session, and to antagonize by every legitimate means the progress of legislation introduced by automobile baiters. The various reports were most enthusiastically received, especially that of W. O. Griffith, chairman of the Committee on Routes, Maps and Sign Posts, which showed upward of 1,200 posts erected, a road book printed and much other work. President Powell Evans' report showed a membership total of 708. The effort to locate and build a club house and garage evidenced early fruition of the plans of the committee in charge, headed by Dr. D. Braden Kyle.

The terms of four members of the Board of Governors having expired, three of them were re-elected and W. O. Griffith chosen in place of Isaac Starr. That body is now made up of Powell Evans, S. Boyer Davis, D. Braden Kyle, Henry P. Baily, Jacob J. Seeds, Stedman Bent and W. O. Griffith.

As an appreciation of the services of the last-named gentleman as chairman of the Routes, Maps and Sign Posts Committee he was presented with a handsome high-grade speedometer by the club.

DAVID WILL TACKLE ROAD GOLIATH ALONE.

PHILADELPHIA, March 8.—Manager William P. David, of the local Middleby agency, has been endeavoring to get some of his \$1,250-or-under confrères to trot him a heat from this city to Pittsburg and return for a \$500 wager, just to demonstrate the effectiveness of the air-cooled principle from the Middleby viewpoint. But after wearing the chip on his shoulder for over a week without landing a competitor he has taken down the money, which he had posted with the editor of the *Philadelphia Inquirer*, and will send his car over the route alone after making the necessary arrangements to have the test officially timed. The route going and returning will be as far as possible over the proposed Philadelphia-Pittsburg cross-State highway, which is now being discussed in the Legislature.

RESTRICTIVE CHANGES IN FRENCH PATENTS.

France for the French seems to be the main idea as embodied in the new French laws as they relate to "letters patent" such as may, in future, be taken out in that country. Under the new law, unless a patent is "worked" within a period of three years from the date of issue it will be void. But this French law is wider in its scope, in that it holds to the dictum that, "the patent courts will be invested with discretionary power to call upon the holder of a patent to show cause why he should not exercise his right in French territory, in an adequate degree." Under the new French law then, a foreign "patentee" is at the mercy of the court; with no more definite right than "the court allows."

MID-WINTER AUTO TRIP TO SAVANNAH, GA.

To some a tour in an automobile means a trip in delightful summer weather, over roads smooth and dry. To others it means a test of endurance, when roads are at their worst. It was under the latter conditions that C. A. and W. A. Warren and Dr. E. D. Loughran, of Kingston, N. Y., have just completed a journey from New York to Savannah in a Stoddard-Dayton Model K roadster. The route followed was via Philadelphia, Gettysburg, Winchester, Natural Bridge, Danville, Charlotte, Columbia, Augusta to Savannah.

HARTFORD SHOW MADE GOOD PROFITS.

HARTFORD, CONN., March 9.—The recent automobile show held in Foot Guard Armory will net the exhibitors a dividend of about 40 per cent., which will be passed upon at the Dealers' Association meeting next week.

BRINGS SUNNY SOUTH TO ZERO COUNTRY.

A quick change from mid-winter in Yellowstone Park, with the mercury forty degrees below zero, to the genial warmth of the slopes with which Southern California borders the Pacific, has been made by H. W. Childs, manager of the Yellowstone Park Association, in a trip with a party in a Franklin touring car, his experience emphasizing anew how wide climatic differences are set at naught by the use of the automobile. San Diego, Cal., was the objective point of the trip, the party thence working up the coast to San Francisco.

Mr. Childs states that the number of tourists will be greatly augmented by automobilists headed for the Alaska-Yukon-Pacific Exposition, and while there have been restrictions on the use of motor cars in Yellowstone Park, a change in their favor has been coming. An evidence of this is the recent replacing of one of the last of the old stage coaches by a Franklin touring car.

PEERLESS FACTORY ADDITION MOST FINISHED.

CLEVELAND, March 9.—The Peerless Motor Car Company, of this city, is rushing work upon the new office and factory buildings. For some time the Peerless people have been very badly cramped in both executive and factories quarters, and the new structures are expected to relieve the congestion. The factory building will be four stories in height, while the office structure will be half as high. Both will be built of brick, concrete and steel throughout, and will conform to the general plan of all the Peerless buildings.

The trade in general in this city is undergoing a steady boom—not the mushroom kind, but a healthy growth. The past week has seen one new agency come into the local field, while another general garage concern has opened up. J. F. Egensperger, formerly indentified with the Northern in this city, has accepted the agency for the Sterling, built in Elkhart, Ind., and demonstrators are expected this week. The Auto Sales Company, managed by John W. Rauch, has started business at 1121 Chestnut avenue.

NEW CHICAGO HOME FOR PACKARD.

CHICAGO, March 8.—Following the lead of the metropolitan agents of permanently locating in high-class buildings properly located among the right surroundings, the Chicago Motor Car Company, selling agents for the Packard, has leased for 99 years the northwest corner of Michigan avenue and Twenty-fourth street, which, together with the purchase of the property at 128-130 Twenty-fourth street, will give a space for the new building of 60 by 200 feet. The existing buildings will be demolished and a four-story reinforced concrete structure will be erected, to be ready for occupancy by August 1, 1910.



Comedian James E. Rosen in His Overland Roadster.

Mr. Rosen is the famous little comedian who created the part of "Buster Brown," and is now playing in the "Newlyweds" as the baby. He purchased the car at the recent Cleveland Show, and will do extensive touring with it during the vacation season.



How the Chalmers-Detroit Big Shipment Looked When Unloaded.

What is claimed to be the largest single shipment of automobiles ever sent from Detroit to a single dealer, was that of 46 Chalmers-Detroit "30's" that went to H. E. Fredrickson, the Omaha, Neb., agent. The freight cars bearing this consignment left Detroit all together in one train. When they were unloaded at Omaha, they were lined up for the above picture.

Moon Company Arranges Lecture Course.—In order to give its employes a practical idea of automobile construction, instead of confining them to the knowledge of the certain parts which each makes, the Moon Motor Car Company is arranging a lecture course for their benefit exclusively. It is planned to give short talks after the luncheon hour, and a recent experimental lecture showed the amount of interest aroused. At night there will be frequent illustrated lectures, and throughout the course authorities in the automobile engineering field will be called upon. Stewart McDonald, general manager of the company and a member of the Society of Automobile Engineers, will take up more general topics of pertinent interest.

Auto Races on Tampa Track.—A series of automobile races, which will be held at frequent intervals during the year on the half-mile track at the Tampa Bay Hotel, was started by a meet on February 23, the time being slow because of the size and condition of the course. The feature of the day was a five-mile event for touring cars carrying four passengers, which was won by E. T. Bryan's Premier in 7:24, with P. Arguelles' six-cylinder Ford second and W. F. Feriman's Cadillac third. This car was the fastest of the trio, but was held up by dirty gasoline. A three-mile race for cars under 15 horsepower was won by C. B. Witt's Franklin, and one for cars of 22 horsepower or under at five miles was won by H. D. King's Buick.

Refrigerator, Lunch Case and Alcohol Cooker.—Most interesting of all is what may be called a close-coupled limousine in that the tonneau has but one seat to accommodate three. Behind this seat is a false back, to which access is had through doors opening from behind the car. This false back contains lockers the full height of the body, a refrigerator, lunch case with alcohol cooker, and storage space for six suit cases. On the roof, which is of the cabin-deck type, with portholes for ventilation, is a tank which provides water. This is probably one of the most interesting body undertakings that the Quinby Company, of Newark, N. J., ever devised.

Many Farmers at Omaha Show.—Earle J. Moon has recently returned to the factory of the Moon Motor Car Co. from the Omaha show, much impressed with the numbers of farmers

interested. He said: "It made me realize what an important person the farmer has become. Only a short time ago these people looked upon automobiles as beyond their comprehension and were much against them, but it is different now, at least in Nebraska. Those at Omaha showed not only an interest but an accurate knowledge of machines and were well able to buy when they found what they wanted."

Close-couple Body with Double Rumble Seat.—Innovations in body designs are still to be seen in the haunts of the advanced designers, and autoists persist in wanting specialized products. There is now at the shops of the J. M. Quinby Company, Newark, N. J., a type of close-couple body with double rumble seats, which will gladden the heart of Owen Osborn, of Philadelphia, for whom it is being built. The double rumble will accommodate the chauffeur and the maid, nor will their confidences reach the ears of the occupants of the body proper. "It is a poor rule that does not work both ways."

Kisselkar Also Stars on Pacific Coast.—Later advices from the scene of the Pasadena-Altadena hill climb show that the performance of the Kisselkars was worthy of note. Three different models were entered, of 30, 40 and 60 horsepower, respectively. The thirty won the touring-car class for cars selling between \$1,001 and \$1,500; a forty finished second among the touring cars selling between \$1,501 and \$2,000; a forty roadster won the event for that type of machines selling between the same prices, and the sixty was second in both the \$2,500 to \$3,000 roadster class and in the free-for-all stock roadster class.

Alco Cars Make Debut in Los Angeles.—With W. P. Brooks in charge, a building on South Oliver St. will soon be animated with Alco cars, and the agency is expected to be a "live one" in view of the projected \$3,000,000 appropriation, made by Los Angeles County, with which to build roads. The American Locomotive Automobile Company, of Providence, R. I., builder of the Alco, is imbued with the idea that California will absorb many an automobile in the near future and preparation is being made to enjoy some of the prosperity.

Winton Self-Starter Always Ready.—"Proof of the pudding is in the eating of it." A. A. Marshall, of Fitchburg,

Mass., went to California, leaving his Winton "Six" on dead storage, and when he returned six weeks later, on Feb. 13, last, it was with no idea that the car would respond instantly to the self-starter, when he tried the trick. Mr. Marshall soon learned, however, that a Winton starter is not rendered "hors de combat" by six weeks of cold storage. The motor responded to the self-starter without ado.

Can't Keep a Good Firm Down.—Although it has suffered a severe loss by the fire which totally destroyed the main factory, the Automobile Supply Mfg. Co., of Brooklyn, N. Y., has been able to take care of the orders on contract at the other two plants on Taaffe place and Classon avenue. At the former plant 12,000 additional feet of floor space has been secured and a new plant fitted up. The president of the company, Louis Rubes, states that all present and future orders will be promptly attended to.

Superior Manganese Comes from Japan.—In dry cells manganese is used for a depolarizer and it is of the greatest importance to have the same not only pure, but in acceptable shape. Formerly the product used came from the land of the "Czar." The Rock Island Battery Company, of Cincinnati, recently placed a large order for Japanese manganese and the company reports that American business relations with the Japanese are excellent. The Japanese product is a little higher in price.

R. F. Hardy Company's Guarantee.—"Sta-Rite" spark plugs, which are well and favorably known to the trade, have proven to be so reliable in service that the company now proposes to offer users what amounts to a perpetual guarantee, in that the plugs will be kept in good repair free of charge for all time. At the works of the company in New York City, it is reported that the plugs returned, thus far, proved to be those which have seen four or five years' service.

Kissel Factory Working At Night.—The plant of the Kissel Motor Car Company, at Hartford, Wis., which was recently enlarged to treble its former size, is now working both day and night shifts on its estimated production of 1,200 cars per year. Increased work has been necessary especially upon the new-size cylinder models, the orders for which exceed the capacity of the plant in producing.

Owen Thomas Will Build New Factory.—Rapidly increasing demand, coupled with ill-adapted rentable buildings, urges the Owen Thomas Motor Car Company, of Janesville, Wis., to adapt the expedient of putting up its own factory. Orders in hand for cars, taking into account prospects, urges the company in undertaking the work of erecting a plant at once.

India Agency Wanted.—An American exporter is preparing to establish permanent show rooms for American goods in India. The plan will be conducted along strictly American lines, and only selected lines of machinery and automobiles will be displayed. Further particulars can be obtained by addressing 3075, Bureau of Manufacturers.

Reliable-Dayton Increases Capital.—The Reliable-Dayton Motor Car Company, Chicago, makers of carriage motor cars and delivery wagons, has increased its capital stock from \$25,000 to \$200,000, fully paid in. The company was incorporated under the laws of Illinois in 1907, in its third business year.

IN AND ABOUT THE AGENCIES.

Mitchell and Auburn, Wichita, Kan.—Advices from M. L. Arnold, of the United Motor Company of Wichita, Kan., State agent for the Mitchell and Auburn cars, announce that the report published in these columns on February 25 that Mr. Arnold would hereafter be connected with J. L. Sternberg & Company, at 119 East Second street, the agent for the Inter-State car, is incorrect. Mr. Arnold writes that neither he nor his company is in any way connected with J. L. Sternberg & Company and will continue to handle the Mitchell and Auburn at 115 to 119 East Second street, as in the past.

Oakland, Philadelphia.—The Oakland car, which was formerly represented in the Quaker City by the Bergdoll Motor Car Company, will henceforth be looked after by the Oxford Automobile Company, 238 North Broad street, which also handles the Brush and Grout output in Philadelphia and contiguous territory.

American Agency Wanted in Asia Minor.—The Bureau of Manufactures, Washington, D. C., will forward to a business man in Asia Minor any propositions which may be addressed to No. 3110, care of the Bureau. It is reported that there is a field in Asia Minor for automobiles.

Pierce Arrow and Oldsmobile, Austin, Tex.—The Houston Motor Car Company has opened a branch in Austin, in addition to its branch in San Antonio. The company will sell the Pierce Arrow and Oldsmobile.

Royal Tourist, Seattle, Wash.—The newly formed Royal Sales Company has secured the agency for the Royal in the Northwest and will push the sales in Tacoma, Portland, Seattle and other large coast cities.

Jackson and Ford, Morristown, N. J.—Seaman Brothers have been appointed sub-agents for the Essex Automobile Company, of Newark. They will represent the Jackson and Ford cars.

Moline, Davenport, Ia.—C. P. Peterson, of Davenport, has taken the agency for the Moline and will build a large garage. He will have charge of all sales made in the three cities.

White, Denver.—C. S. Newsom, who has been appointed agent for the White steamer in this city, will establish headquarters at Fifteenth street and Cleveland place.

Firestone, Baltimore.—The Firestone Tire & Rubber Company has placed a distributing agency with R. Milton Norris, 516-18 W. Baltimore street, Baltimore.

Reo, Wisconsin.—The Cumberland Auto Company, of Cumberland, has arranged to handle the Reo in six counties in the northern part of the State.

E-M-F and Studebaker, Savannah.—The Graham Automobile Company has taken the agency for the E-M-F 30 and Studebaker cars for this vicinity.

Regal, Youngstown, O.—L. P. Hoffmaster and C. A. Clifford have formed a partnership to handle the Regal car in the northern Ohio town.

Schacht, Montclair, N. J.—W. L. Mason has secured the agency for the Schacht, a high-wheeled auto, manufactured in Cincinnati.

Maxwell, Savannah.—The Maxwell-Briscoe Motor Company has opened a branch in Savannah, with Mr. Hazzard as manager.

Herreshoff, San Francisco.—The Reliance Automobile Company is to act as agent for the Herreshoff in this city.

Overland, Trenton, N. J.—J. C. Van-Horn has been appointed local agent for the Overland car.

RECENT BUSINESS CHANGES.

Auto-Car Manufacturing Company.—The truck building firm, the Auto-Car Equipment Company, of Edward street, Buffalo, N. Y., has changed its name to the Auto-Car Manufacturing Company and increased the capital stock to \$250,000. It will move into the new buildings at Elmwood and Hertel avenues, May 1. The plant will be one of the most complete in construction and equipment, and will have a capacity for an output of about one thousand machines per year. The Auto-Car Equipment Company has been quoted as the oldest manufacturer of commercial cars in America.

Allen-Swan Company, Brooklyn, N. Y.—Lew Allen, president and general manager of the Allen-Swan Company, the well-known Long Island agent for Stearns cars, has bought out the holdings of Messrs. Kingsley and Swan. He will continue the business at 1384-86 Bedford avenue, and alterations will be hurried so as to fit the place for spring business. Burt W. Phillips will be the new treasurer, and Howard Drakely will continue with the company.

Metropolitan Garage, New York City.—This concern, located at Seventy-seventh street and Broadway, has been purchased by the Monarch Motor Company, which will make numerous improvements and operate it as a high-class storage garage. The garage, which has already made an enviable record, will be made one of the largest and finest in the city.

James L. Gibney & Bros., Philadelphia.—Continental tire agents at 211 North Broad street, have just taken a long-term lease on the double property at 215-217 North Broad street, which is now being fitted up to accommodate their rapidly growing accessories business. The alterations will be completed April 1.

Oshkosh Electric Company, Oshkosh, Wis.—The Oshkosh Electric Company, of Oshkosh, Wis., manufacturers of spark coils, has discontinued business, and its machinery, tools and machinery have been disposed of to various concerns making electrical goods.

Newark, N. J.—On March 15 the official headquarters of the Motor and Accessory Manufacturers, now located in the Union Building, Newark, N. J., will be moved to the Argus building, 17 West Forty-second street, New York City, where the regular business of the association will be conducted.

Kansas City, Mo.—The Ford Motor Company, at 318-320 East 11th street, and the Midland Motor Car Company, at 1608-1610 Grand avenue, are to trade salesrooms.

RECENT BUSINESS TROUBLES.

Motor Commercial Delivery Company of Philadelphia.—Creditors of this concern, with headquarters at 1505-09 Apple-tree street, have asked that a receiver be appointed for it. The petition states that the company has a total indebtedness of \$16,500, with available assets of only \$100, apart from machinery, tools, and fixtures valued at \$5,430. It is alleged that the company is unable to meet its obligations, is insolvent, and that no assignment has been made for the benefit of creditors.

Pneu L'electric Company, New York City.—A petition in bankruptcy filed against this company, dealers in tires and other automobile accessories, at 1610 Broadway, by attorney for creditors, alleges that the concern is insolvent and unable to pay debts amounting to \$3,700.

OBITUARY.

William W. Austin, known as the father of the automobile, died suddenly on March 7 at his home, 37 Shirley street, Winthrop, Mass. At the time of his death, although 85 years old, Mr. Austin was busily engaged in perfecting a late invention, a gasoline lamp. A company, headed by ex-Governor Frank S. Black, of New York, and including as stockholders John D. Rockefeller and others, had been formed to manufacture and market the product. Mr. Austin got his name of "father of the automobile" from the fact that in 1860 he invented and built the first steam auto. During the Civil War he built another that is still in existence and for which he recently refused an offer from the Stanley Automobile Company of Newton, Mass. He was a prolific inventor, having to his credit the steam-propelled bicycle, a sailing catamaran, rubber heels, an airship and many others.



President Taft's White Steamer Leaving White House Garage.

With the advent of the new administration in Washington, D. C., there was also an important change in the White House stable, turning it into a garage, with a gasoline tank displacing the feed bins and from the pegs, instead of harness, inner tubes and casings now hang. President Taft delegated to W. C. Sterling, the Washington representative of the White Company, the task of making the necessary changes. The garage is now in charge of Geo. Robinson, who has been detailed from the War Department to drive the car.



New Quarters of Maxwell-Briscoe Motor Company at 1332 Broadway, New York City.

PERSONAL TRADE MENTION.

George F. Fenno has joined the staff of the Geo. H. Gibson Company, advertising engineers, Tribune Building, New York City. Mr. Fenno is a graduate of Sibley College, Cornell University, and for the past two years has been insurance engineer with the Middle States Inspection Bureau, an organization maintained by 36 of the leading fire insurance companies. His experience in this line has made him widely familiar with engineering and manufacturing plants, a feature which will be valuable to him in his present work of promoting the sale of engineering supplies and equipment by means of publicity.

C. R. Van Auken has been appointed manager of the Detroit branch of the Ajax-Grieb Rubber Company, succeeding C. W. Hatch. Mr. Van Auken has been connected with the tire industry for several years and prior to that time had long experience in the rubber and druggists sundry business.

J. A. Temme, until recently with the Auto Equipment Company of Philadelphia, has been appointed manager of the Boston branch of the Stromberg Motor Devices Company, manufacturers of the Stromberg carburetor.

L. B. Fijux has been appointed manager of the Chicago office of the Willard Storage Battery Company, of Cleveland, and will take charge of the company's interests in Chicago and surrounding territory.

J. Stewart Smith has entered into relations, as general manager, with the Standard Sales Company, of 1779 Broadway, New York City, after several years with Emil Grossman in his various enterprises.

F. W. Suhr is now connected with the Diamond Rubber Company and is located at 223 Columbus avenue, Boston. He was formerly with the Michelin Tire Company as New England representative.

James W. Florida, who drove a Locomobile in the last Vanderbilt race, gave a dinner to his team-mate, George Robertson, in Philadelphia, when the latter returned from New Orleans.

W. R. Stroud, famous as a bicycle racer in days gone by, has just associated himself with the Penn Auto Supply Company, of Philadelphia, and will have charge of the motorcycle and tire end.

Benjamin Gerdelman has been engaged by Gray & Davis as a special representative and will have a salesroom at 4630 Olive street, St. Louis, where he will carry a stock of lamps and parts.

Arthur R. Smith has accepted the position of manager with the new Drum-

mond garage and salesroom for White steamers and Woods electric, 2024 Farnam street, Omaha, Neb.

J. B. Burwell, former Chicago manager of the Ajax-Grieb Rubber Company, has gone to Minneapolis to take charge of the Ajax branch in that city at 905 First street, West.

TAXICABS AND TRANSIT.

Chicago.—Some one interested in figures has dug up the fact that the city of Chicago has no less than 14 automobiles in service, divided as follows: Police Department, 2; Fire Department, 2; Board of Improvements, 2; Health Department, 2; City Physician, 1; Commissioner of Public Works, 1; Bureau of Streets, 1; Bureau of Engineering, 1; Park Commission, 1; Department of Track Elevation, 1, and Council Committee, 1. Superintendent Doherty's Street Department machine has traveled 97,000 miles in two years. That this is not an isolated record is shown by the additional statement that Deputy Commissioner Paul Redieske, of the Public Works Department, traveled 52,000 miles in a single year—1908. Another machine, recently purchased, has gone 5,000 miles in two months of the winter, which is at the rate of 40,000 miles a year.

Rutherford, N. J.—Three automobile stages, with a seating capacity of thirty each, have been put into service by the Rutherford Transit Company between the Erie Railroad station and various points in the borough. This company, composed mainly of local residents and stockholders, has been recently formed, with a capital of \$2,000, to supply proper transportation to the station, and, with a low rate of fare and fixed schedules, it is thought that most of the 1,500 commuters will use the stages. It has been estimated that it will cost \$13,870 to operate the three cars yearly, and that the gross receipts will be \$16,425, leaving a balance of \$2,555.

Girard, Ga.—An automobile line has been established between Girard and Waynesboro, making a daily round trip between these points, a distance of twenty-five miles. Girard does not have a railroad, and this means of transportation is an important one to the town. Regular schedules will be in force with a rate of fare averaging 4 cents a mile. The officers of the company are: President, Charles Brigham; vice-president, W. R. Buxton; general manager, J. B. Heath; secretary-treasurer, W. V. Stephens. A charter will be applied for.

Morristown, N. J.—An automobile chemical engine was recently tested out very thoroughly in the streets here by the Fire Department and town officials.

The town is about to purchase a machine for Independent Hose Company, and this one was brought here by the Webb Company for demonstration purposes. The fire extinguishing equipment, consisting of a 40-gal.-long tank, 1,000 ft. of hose, etc., was mounted upon an Oldsmobile chassis.

New Orleans, La.—Automobile patrols are getting so common now that it is considerable of a task to chronicle all of them. The latest of the Southern cities to fall into line is New Orleans, which, with a Studebaker patrol and five police motorcycles, is getting quite up to date. The new machine, which is to be used as an emergency vehicle as well as a patrol, is to be kept at the First Precinct Station.

Cleveland.—Finding it impossible to hold up its end in competition with electric railways on the basis of steam service, the Cleveland Akron & Columbus Railroad is preparing to put on a half-hour suburban service between Columbus and Westerville, using a gasoline-propelled car of large capacity. A large number of cars will be put into service at once.

Tampa, Fla.—A new departure for Tampa will be the installation of a big automobile, equipped with chemical tanks, etc., for fire department service. This move was brought about by the unusually severe service, which wore out the horses faster than the department could afford to buy them.

Brownwood, Texas.—Plans are under way for the establishment of several motor bus lines. One is to run between Brownwood and Mays, another to Rockwood, and still another to Mercer's Gap. A meeting is to be called in the near future, and it is expected that \$200,000 will be raised for the maintenance of the lines.

Chicago.—The Board of Underwriters has taken delivery of a three-ton fire insurance patrol wagon, made by the Knox Company. This machine, which is of the conventional patrol type, will be put into service at once, working from the No. 3 house at Twenty-third and State streets.

Jacksonville, Fla.—John S. Lane, proprietor of the Ocklawaha Hotel, has started a bus line between the Seaboard Air Line Depot at Tavares and the hotel. The automobile used seats sixteen people and has been very busy ever since it was put into service.

Carlsbad, Tex.—The Carlsbad Commercial Club recently closed the contract with the Midland-Seminole Automobile Company for an auto service between Carlsbad and Midland three times a week and the building of a fine road for this exclusive use.

Fort Worth, Tex.—Beginning March 1, a taxicab service will be installed here. Starting with two cars, the Reid Automobile Company will add more as the service demands it. Two large garages which were recently furnished will be utilized.

Boston, Mass.—The Taxi Motor Cab Company has done such an excellent business of late that it has been obliged to add 50 more cabs; in fact, it is expected that this number will not be adequate for their present needs.

Ormond Beach, Fla.—The Florida East Coast Hotel Company is about to start an auto bus service between Ormond, Daytona and Palm Beaches. Three cars have been purchased from the American Locomotive Company.

INFORMATION FOR AUTO USERS

Zig-Zag Tire Chain.—The latest thing on the market in the nature of anti-skidding devices is the Zig-Zag tire chain, manufactured by the Motor Appliances Company, 1438 Michigan avenue, Chicago. The feature of this appliance is that it is in the form of a continuous chain held in a zig-zag line along

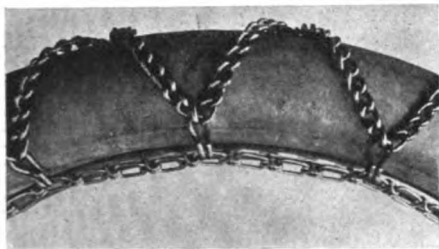

ZIG-ZAG TIRE CHAIN APPLIED.

the periphery of the tire. The chain itself is of the well-known twisted-link pattern, with special links disposed at intervals throughout its length. These hooks are so placed in the chain, that when it is laid out in a straight line without twist, they alternately point in opposite directions. These hooks are secured to the side chains at such distance apart as to give the tread member a zig-zag line of approximately 45 degrees to the plane of the wheel.

Great efficiency is claimed by the makers in the line of efficiency owing to the fact that the chains engage the ground in an oblique line, thus equally resisting the tendency to skid sidewise, and aiding traction and brake action. The close proximity of the contact points in the chain brings two of these points on the ground at all times, and it is also claimed that this naturally aids their gripping power and eliminates vibration. These chains have been rigidly tested before offering them to the public. Distributing agencies are being rapidly placed.

Swinehart Twin-Tread Bridge Tire.—After exhaustive tests, the Swinehart Tire & Rubber Company, Akron, O., has put on the market its new bridge tire, a section of which is shown in the ac-

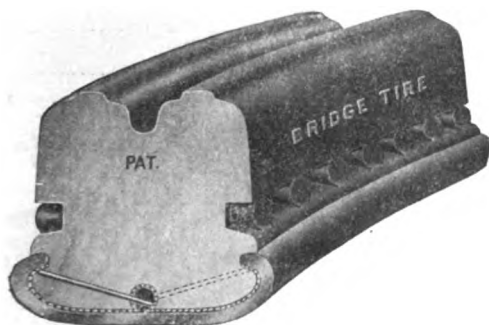

SECTION SWINEHART TWIN TREAD TIRE.

companying cut, and which, the makers assert, eliminates the ragged edges and grinding away of the bridges due to faulty construction in the past. Thorough tests have proven to the satisfaction of the Swinehart Company that bridges in the side of a tire, in the form of cylinders, are practically indestructible, and will stand the greatest amount

of abuse without cutting or tearing away from the tire proper. These bridges take up the shocks gradually, offering very little resistance at the beginning, but spread and effectually break the shock as the cylinders are flattened out. This, is claimed, makes a very easy riding tire, and nearly as durable as the regular concave tire.

Foster Shock Absorber.—This is announced as a new and simple device for eliminating excessive spring action without destroying the resiliency or free central movement, and the resisting force is applied gradually and in proportion to the severity of the shock. The stationary base of the absorber consists of an oval-shaped steel cup, the length being one-fourth inch greater than the width. The cup is encircled by a one-piece band of flexible spring steel faced with thermoid liner, which bears against the outer surface of the steel cup, thereby producing the desired friction. The amount of resisting force exerted is governed by one adjusting nut, and can be varied as required. Owing to the oval

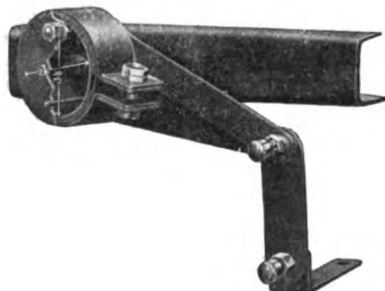

FOSTER SHOCK ABSORBER IN PLACE.

shape of the cup, the central movement is free, and can be varied from one inch to three inches at the end of the arm. In consequence, spring action is free for a corresponding distance, after which the friction is gradually applied and increased on both the upward and downward stroke. As the arm of the absorber moves off the center the flexible steel band changes its shape to conform to the oval cup, thereby creating a gradual increasing friction to conform to the arm movement. All bearings are case hardened to insure durability, and the friction cup is dustproof. The Foster shock absorber will operate from 12 to 15,000 miles before replacement is necessary, and can be applied to any type of motor vehicle. It is manufactured by Claude H. Foster, 1410 East Fortieth street, Cleveland.

Infallible Metal Polish.—Branch houses established recently in Chicago, New York, New Orleans and San Francisco by George William Hoffman, of Indianapolis, manufacturer of metal polishes and other similar specialties, in answer to a demand in these sections of the country, is regarded by Mr. Hoffman as an indication that standard polishes are wanted not only by autoists but by other people as well. The substance is put up in paste, liquid and powdered form, so that it meets any requirement, and is suitable for use on gold, silver, plated ware, nickel, tin, brass, copper, etc., removing stains and producing a brilliancy equal to newness. Mr. Hoffman suggests it as especially useful in cleaning auto-

mobile brasses, band instruments, locomotive and machine mountings, kitchen utensils, metal street signs, show cases, scales, headlight reflectors and many other like articles.

Keystone Grease.—At the automobile shows recently held in New York the stand of the Keystone Lubricating Company, Philadelphia, contained a convincing exhibit showing the special adaptability of this company's product to automobiles. The exhibit consisted of a combined differential and change-gear, lubricated with the No. 3 density grease. The mechanism was driven by an electric motor, and was conveniently arranged to permit a good view of the gears running in the lubricant and show the unique properties of the latter. The mechanism is of the roller-bearing type, and is effectively lubricated, it is stated, by a charge of ten or twelve pounds of the grease. In operation the latter sticks fast to the rapidly revolving parts, forming a thick glib which penetrates between the teeth of the gears and resists being thrown off by them. Moreover, the motion of the gears causes a slow but positive circulation in the body of the grease, which means that every part of the mechanism is permeated by a constantly changing flow of lubricant. The clinging consistency of this grease is stated to be such that the moving parts of the mechanism, instead of making a cavity in the body of the lubricant or clearing themselves of it, as they would ordinarily do, remain smothered in it, so to speak, at all speeds. This property of "sticktoitiveness" is, it is claimed, accompanied by the lowest attainable coefficient of friction, and by perfect chemical neutrality and freedom from corrosive substances that might injure the gearing. It is also stated that the consistency and lubricating quality are unaffected by the wide temperature variations that naturally obtain in automobile work, ranging from exposure to zero weather with the car standing still in winter to the maximum running temperature of the gears on a hot summer day.

English Non-skid Tires.—Cryder & Company, of New York City, are importing the Kempshall non-skid tires which are made in England, with the skid-preventing qualities molded right into the tire, without the use of steel or leather. They are built with a flat tread in which are suction pockets that increase their efficiency, and being low

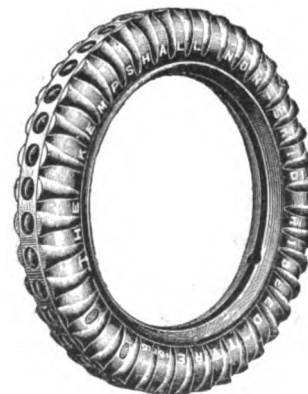

KEMPSTALL IMPORTED NON-SKID TIRE.

pressure tires minimize vibration and increase comfort. With plenty of the best rubber and fabric, they are said to be nearly immune from punctures and other troubles, ten to twelve thousand miles often being gotten from the one tread.

INDEX TO ADVERTISERS

Acetylene Gas Illuminating Co. 50
Acme Motor Car Co. 54
Adams Co. 54
Ajax-Grieb Rubber Co. 56
Alden Speare's Sons Co. 64
American Ball Bearing Co. 69
American Carburetor & Improvement Co. 79
American Electric Fuse Co. 89
American Motor Car Co. 81
American Motor Truck Co. 84
American Napier Co. 99
Anderson Forge & Machine Co. 52
Apple Electric Co. 60
Ashtabula Bow Socket Co. 57
Ashton Valve Co. 50
Asphalt Ready Roofing Co. 77
Atwater-Kent Mfg. Works. 104
Autocar Co. 84
Austin Automobile Co. 88
Auto Car Mfg. Co. 74
Auto Tire Security Co. 98
Auto & Supply Mfg. Co. 51
Baker Mfg. Co. 68
Baldwin Chain & Mfg. Co. 52
Barndt-Johnson Auto Supply Co. 77
Bartholomew Co. 100
Bellfuss Motor Co. 78
Billings & Spencer Co. 49
Bi-Motor Equipment Co. 49
Black Mfg. Co. 76
Blue Book 58-59
Bongartz Co. 84
Borne Schrymser Co. 70
Boston Auto Gage Co. 50
Bowser & Co., S. F. 51
Boyle & Co., John. 68
Brennan Mfg. Co. 69
Bretz Co., J. S. 62
Brown & Co., S. N. 57
Brownell Motor Co., F. A. 53
Buckeye Jack Mfg. Co. 65
Buckeye Mfg. Co. 80
Buffalo Specialty Co. 60
Buob & Scheu 57
Burnett-Compound-Spring Co. 72
Cadillac Motor Car Co. 54
Cameron Motor Co. 69
Canton Drop Forging Co. 52
Chadwick Engineering Works. 68
Chandlee & Chandlee. 64
Chase & Co., L. C. 70
Chicago Auto Top Co. 61
Cleveland Co. 82
Cleveland-Canton Spring Co. 52
Colgan Co., J. W. 44
Collins & Sons, G. A. 79
Columbia Lubricants Co. 51
Conn. Tel. & Elec. Co. 97
Continental Natural Gas Alcohol Co. 51
Continental Caoutchouc Co. 56
Continental Motor Mfg. Co. 62
Corbin Motor Vehicle Corp. 81
Cornish Friedburg Motor Co. 54
Correspondence School of Motor Car Practice. 50
Covert Motor Vehicle Co. 54
Cullman Wheel Co. 52
Davies Co., J. P. 65
Dayton Motor Car Co. 88
Dayton Rubber Mfg. Co. 56
De Luxe Motor Car Co. 54
Diamond Chain & Mfg. Co. 52
Diamond Rubber Co. 100
Dietz Co., R. E. 108
Dixon Crucible Co., Joseph. 64
Dow Tire Co. 76
Driggs-Seabury Ordnance Corp. 52
Duplex Co. 51
Duplex Coil Co. 50
Echo Horn Co. 73
Eclipse Machine Co. 51
Edison Auto Accessories Co. 50
Edmunds & Jones Mfg. Co. 62
Eldredge Electric Mfg. Co. 50
Electric Launch Co. 71
Elite Mfg. Co. 78
Elmore Mfg. Co. 107
Empire Automobile Tire Co. 84
Everett-Metzger-Flanders Co. 81
Excelsior Supply Co. 67
Excelsior Tire Co. 47
Firestone Tire & Rubber Co. 97
Fisk Rubber Co. 85
Flentje, Ernst 74
Fort Pitt Motor Car Co. 54
Franklin Mfg. Co., H. H. 80
French Mfg. Co. 64
G. L. Economizer Co. 61
Gabriel Horn Mfg. Co. 86
Gaeth Automobile Co. 80
Gearless Motor Car Co. 54
Geisler Bros. 50
General Accumulator & Battery Co. 50
Gilbert Mfg. Co. 67
Goodrich Co., B. F. 53
Goodyear Tire & Rubber Co. 78
Gramm-Logan Motor Car Co. 54
Grand Rapids Spring Co. 62
Gray & Davis. cover
Grossman Co., Emil. 55
Grout Auto Co. 54
Ham Mfg. Co., C. T. 53
Hardy Co., R. E. 81
Harris Oil Co. 56
Hartford Suspension Co. 79
Hart-Kraft Motor Co. 60
Haynes Automobile Co. 80
Heinze Electric Co. 57
Hemmeter Spark Plug Co. 72
Hercules Electric Co. 86
Herschell-Spillman Co. 52
Herz & Co. 73
Hess-Bright Co. 52
Hill Dryer Co. 53
Hoffecker Co. 64
Hoffman, Geo. W. 77
Hotel Gibson House 66
Hotel Woodstock 56
Howard Motor Works. 54
Hoyt Electrical Ins. Works. 52
Hydraulic Pressed Steel Co. 52
Indestructible Steel Wheel Co. 52
Interstate Automobile Co. 81
Jackson Automobile Co. 54
Jacobson Macine Mfg. Co. 78
Jeffery & Co., Thos. B. 109
Jewell Motor Car Co. 62
Joyce-Cridland Co. 88
K. W. Ignition Co. 72
Kalamazoo Carbureter Co. 95
Karl Co., Adolph. 50
Keasbey, Robert A. 72
Kellom Co., Chas. F. 64
Keystone Lubricating Co. 91
Kimball Tire Case Co. 65
King Top Mfg. Co. 57
Kinsey Mfg. Co. 57
Kirkham Motor Mfg. Co. 85
Kissel Motor Car Co. 95
Kitsee Storage Battery Co. 68
Knox Auto Co. 60
Konigslow, Otto 52
Kokomo Electric Co. 94
Larchmont Mfg. Co. 51
Lavalette & Co. 58
Leather Tire Goods Co. 56
Lehman Mfg. Co., J. H. 50
Leland Co., W. H. 78
Lexington Motor Car Co. 80
Life Publishing Co. 62
Lipman Mfg. Co. 51
Lobebe Pump & Machinery Co. 51
Locke & Co. 69
Locomobile Co. of America. 54
Long Arm System Co. 74
Long Island Auto Supply Mfg. Co. 53
Loring Appliance Co. 93
M. & E. Mfg. Co. 77
Masury & Son, John W. 89
Matheson Automobile Co. 96
Maxwell-Briscoe Motor Co. 92
Mayo Radiator Co. cover
McCue Co. 54
Mechanical & Elec. Mfg. Co. 56
Mercedes Motor Mfg. Co. 50
Metz, Chas. H. 81
Meyers Auto Top Co. 57
Mica Core Mfg. Co. 87
Michelin Tire Co. 56
Midland Motor Car Co. 81
Miller, Chas. E. 89
Mitchell Motor Car Co. 80
Model Automobile Co. 103
Moline Automobile Co. 81
Moon Motor Car Co. 54
Mora Motor Car Co. cover
Morgan & Wright 78
Mosier & Co., A. R. 51
Moss Photo Engraving Co. 86
Motz Clincher Tire & Rub. Co. 56
Muttly Co., L. J. 57
N. Y. Sporting Goods Co. 85
National Brake & Clutch Co. 52
National Motor Vehicle Co. 90
National Welding & Mfg. Co. 79
Neustadt Auto & Supply Co. 67
New Departure Mfg. Co. 98
New York Gear Works. 57
Nightingale Whistle Mfg. Co. 87
Nordyke & Marmon Co. 54
Northway Motor & Mfg. Co. 79
Nuttall Co., R. D. 52
Olds Motor Works. 54
Omar Motor Co. 98
Orange Machine & Mfg. Co. 101
Overland Automobile Co. 74
Owen & Co., R. M. 54
Packard Electric Co. 73
Packard Motor Car Co. 111
Palmer & Singer Mfg. Co. 87
Pantastote Co. 96
Parish & Bingham. 52
Parker, Stearns & Co. 56-62
Peerless Motor Car Co. cover
Pennsylvania Auto Motor Co. 80
Perfection Spring Co. 52
Perfection Non-Skid Climber Co. 83
Perfection Wrench Co. 83
Petrel Motor Car Co. 50
Peugeot Freres 52
Picrome Hide Co. 52
Pirelli & Co. 50
Pittsfield Spark Coil Co. 66
Prest-O-Lite Co. 102
Price Co., Henry W. 77
Prosser & Sons, Thos. 68
Puritan Gas Tank Co. 52
Quincy-Manchester-Sargent Co. 53
Raimes & Co. 53
Rajah Auto Supply Co. 58
Randall-Falchney Co. 75
Reflex Ignition Co. 79
Regal Motor Car Co. 54
Remy Electric Co. 53
Reynolds, Harry H. 57
Robert Instrument Co. 50
Rome-Turney Radiator Co. 72
Samson Leather Tire Co. 69
Royal Equipment Co. 50-73
Royal Tourist Motor Car Co. 86
Rushmore Dynamo Works. 99-101
Safety Device Co. 82
Salisbury Wheel & Mfg. Co. 52
Samson Leather Tire Co. 69
Schenectady Spark Plug Co. 69
Schrader's Son, A. 50
Schubert Bros. Gear Co. 57
Seaboard Air Line. 81
Selden Motor Vehicle Co. 90
Shain, Chas. D. 50
Shaler Co., C. A. 87
Shawver Co. 67
Simplex Motor Car Co. 91
Sireno Co. 51
Siro Carburetor & Mfg. Co. 61
Smith Co., A. O. 85
Spacke Machine Co., F. W. 52
Spare Motor Wheel of Am. 73
Speed Changing Pulley Co. 75
Speedwell Motor Car Co. 76
Spicer Universal Joint Mfg. Co. 53
Splitdorf, C. F. 54
Sprague Umbrella Co. 75
Spring Strap Co. 65
Standard Co. 61
Standard Connecting Rod Co. 61
Standard Roller Bearing Co. 75
Standard Welding Co. 68
Stanley & Patterson. 82
Star Speedometer Co. 102
Stearns Co., F. B. 89
Stevens-Duryea Co. 103
Stewart & Clark Mfg. Co. 63
Stromberg Motor Device Co. 47 and cover
Studebaker Automobile Co. 70
Success Auto Buggy Co. 54
Swinehart Clincher Tire Co. 73
Syracuse Alum. & Bronze Co. 88
Syracuse Chemical Fire Extinguisher Co. 83
Thomas Motor Co., E. R. 81
Timken Roller Bearing Axle Co. 94
Tray Plate Battery Co. 66
Trenton Rubber Mfg. Co. 56
Trimont Mfg. Co. 68
Troy Carriage Sunshade Co. 77
Tucker, C. F. 50
Tudor Mfg. Co. 75
U. S. Fastener Co. 69
Uncas Specialty Co. 65
Universal Tire Protector Co. 77
Veeder Mfg. Co. 92
Vehicle Specialty Corporation. 66
Velle Motor Vehicle Co. 105
Victor Clutch Compound Co. 56
Victor Tire Traction Co. 73
Warner Instrument Co. 51
Watt-Detroit Carburetor Co. 79
Weed Chain Tire Grip Co. 76
Western Motor Co. 77
Weston Elec. Instrument Co. 83
Wheeler & Schebler. 106
White Co. 110
White & Bagley Co. cover
Whitlock Coil Pipe Co. 69
Whitney Mfg. Co. 68
Wildmer Machine Works, C. A. 73
Willard Storage Battery Co. 78
Willett Engine & Carburetor Co. 75
Winston Motor Carriage Co. 112
Witberbee Igniter Co. 50
Wyman & Gordon Co. 49
York Motor Car Co. 60
Zimmerman Mfg. Co. 89

Advertisement for J. W. Colgan Co. featuring logos for Mitchell, Emore, Cadillac, Rambler, National, Acme, Columbia, Pullman, and Haynes. Text includes 'MONOGRAMS AND NAME PLATES', 'ALL STYLES', 'ALL SIZES', and 'SUDBURY BUILDING - BOSTON, MASS.'.

THE AUTOMOBILE

OVER roads which included good and bad and still suffered from Winter's onslaught, mud-bogged in some parts of Connecticut, and more uniformly acceptable in Massachusetts, the route was a trying one for the twenty contestants who participated in the endurance run, held March 11, for the Chester I. Campbell trophy. Fourteen made the difficult journey from New York City to Boston with absolutely perfect scores, necessitating a drawing for the handsome prize cup. This will be held at an early date at a luncheon given by L. H. Perlman, the first winner of the trophy, to all the contesting drivers and entrants. Of the cars penalized only two had large scores marked against them, and these were caused by the heavy condition of the roads in some parts of the route.

W. W. Burke in his six-cylinder Mora, A. B. Corder in the six-cylinder Acme driven by Patchke, A. D. Hall in the Matheson touring car, C. S. Carris in the six-cylinder air-cooled Franklin, Guy Vaughn in the Stearns stripped tourabout, Albert Knox in a 38-horsepower Knox, V. F. Pisani in the Zust, Ray McNamara in a Premier, M. W. Batts in a Stearns, C. S. Rothfuss in a Matheson tourabout, L. R. Burne in a Cadillac tourabout, J. I. Miller in a stripped Cleveland roadster, H. A. Street in another Cadillac and C. W. Kelsey in a Maxwell were the successful competitors who kept their clean scores throughout. The penalties inflicted upon the Lozier, 2 points, and the Renault, 16 points, were promptly protested, but neither allowed by the referee, the others taking the marks as given, the Haynes 6 points, Coates Goshen 50, the KisselKar 165 and the Atlas 200.

As means of arousing interest throughout New England in automobiles, in addition to the Boston show, this event was just what it had been intended to be, a suc-

Over Muddy Roads from the Metropolis to the Hub



cessful one, and the fact that so many cars were able to complete the 243 miles in such a short period of time was a matter of pleasure to everyone connected with the great show, just finishing. All along the route there were crowds of people who attested to their interest by waiting on the streets, or, if at controls, by surrounding the muddy machines and crews.

The morning of the start from Columbus Circle was a very cold one, as compared with the warm weather of the day previous to it, but all of those who had entered machines appeared except one, a National entered by W. C. Poertner, and were sent away at one minute intervals by Starter McMurtry, with the managers of the event, Mills and Moore, watching the proceedings and ready to help in getting the automobiles away. Of course, the route in leading out through the greater city was generally over paved streets and the fine macadam on Jerome Avenue, Fordham Road, and the Pelham Parkway, to the old Boston Post Road, and on this the trouble began. Deep, slimy mud flew over everyone, in the sprays of water thrown from ruts by the

Where the Cars Started on Broadway at Columbus Circle



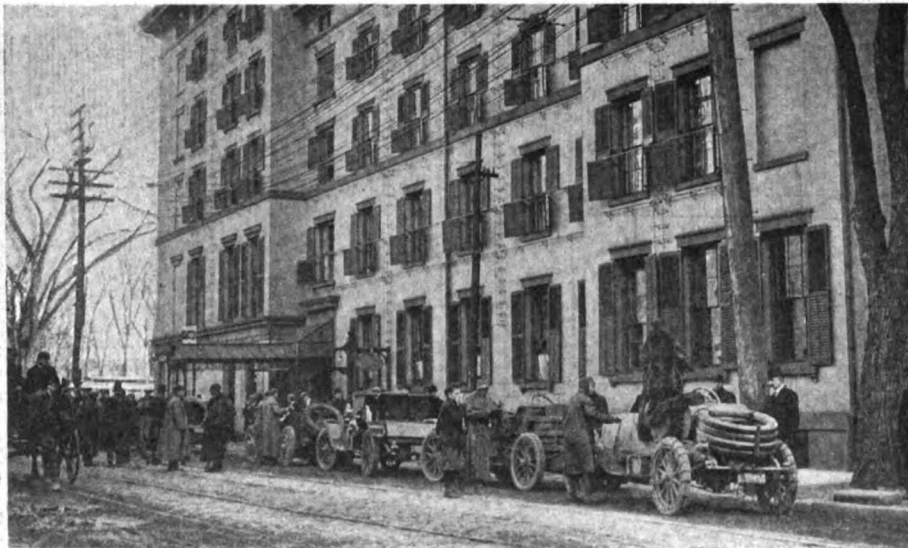

At New Haven, Where the Cars Checked In at the First Control.

flying wheels, and the surface underneath the mud was so rough that it threw the machines from side to side and bounced the passengers around. A twenty mile an hour schedule had been mapped out, with the first control at New Haven, making car No. 1, Burke's Mora, due there at 10.30. Before the contestants had gone very far they realized that they must travel as fast as possible over good roads in order to go slowly over the worst ones, on account of the deep mud.

Through the suburban resident sections of New Rochelle, Larchmont, Mamaroneck, Rye, Portchester, into Connecticut and on through Greenwich, Stamford, Norwalk, Fairfield and Bridgeport the route took the cars and there were many people all along the way. Near Fairfield an unfortunate occurrence happened when a horse was badly frightened by one of the cars, and a rich Bridgeport manufacturer, A. W. Wallace, in attempting to jump out, was killed. Paul Lacroix, who was driving his 35-45 horsepower Renault in the run, was blamed for this, though he professed that he did not cause it, and knew nothing of it until informed by New Haven police. His number was phoned ahead to Bridgeport and the authorities there tried to stop him with an American flag, but thinking that this was a part of the general celebration he brushed by, and so was held for a few minutes at New Haven. Unfortunately the flag was caught by

the car and damaged, and the police of Bridgeport added the charge of publicly mutilating the national emblem to that of reckless driving preferred by other places. At a hearing a few days later, Mr. Lacroix was fully exonerated, not only of the blame in connection with the death of Mr. Wallace, but also of wilfully damaging the flag. It was brought out that the flag was not unfurled when waved, consequently it could not be distinguished from a piece of red bunting, and, moreover, the policeman who handled it was not in uniform. Mr. and Mrs. Lacroix, however, presented the authorities with a new emblem to replace the one lost. At Fairfield there was no trial, those in charge of the prosecution having satisfied themselves, from the previous examination of witnesses, that Mr. Lacroix was not implicated. This trouble cost him his clean score. Inasmuch as his protest was not sustained by Referee Bradley, Mr. Lacroix has

protested to the Contest Board of the A. A. A., claiming that he is penalized for an accident probably caused by another car.

Over an hour before the Mora was due at the first checking station, Albert Dennison, who has figured as a Knox pilot with Bourque in their many victories last season, was one of the first in, sharing the honors about evenly with the Acme driven by Cyrus Patchke, who drove the Acme in the Vanderbilt race, and won second place in the Fairmount Park race. Burke's rumble seat and tool box loosened in the bumping along the New York and lower Nutmeg State roads and he had to stop to fix it. The only car which did not reach the first station was the Atlas, which was being driven by C. H. Beecher, and as it did not report at any station its penalty was placed at 200 points. No little trouble was found by the contestants a number of times in finding the route into strange towns, not following the route book closely enough and in one or two cases a change from these books had been made. All the cars had some time to wait on the Yale campus, and the travelers spent it in discussing the bad roads, and in wondering what would come next. The two men in the Cleveland car, and those in the Haynes were sources of much merriment to the onlookers because of the coating of mud all over them. Their cars did not have rear fenders and the tire changes threw a plaster over them, front and back.

A short control was that from New Haven to Hartford, only 42 miles, and Burke was due there at 12.36, but even in that short distance with none too good roads, the drivers were able to make up enough time to give them half an hour for lunch at the Heublein, arrangements for which had been made by J. K. Mills, who preceded the cars by rail. From Hartford to Springfield was absolutely the worst run of the trip, although there was no control in the latter city, for the roads were terrible and as one veteran of Glidden tours said, "There was about twenty miles of 'Crocker, Indiana,'" and those who participated in the 1907 tour knew what was meant. Perhaps only Road Commissioner MacDonald can explain the methods of road construction from Winsor to Thompsonville and thereabouts, where roads deep in mud were being covered deep with sand, so that it was impossible for the cars to go



The Halt at Hartford, Where Lunch Was Served to the Hungry.



MORA READY TO LEAVE WORCESTER.



VAUGHN AND HIS STEARNS AT A CONTROL.



FRANKLIN AT THE NEW HAVEN CONTROL.



KNOX AFTER ARRIVAL AT WORCESTER.



MAXWELL AT WORCESTER.



ACME FINISHING AT BOSTON.



PREMIER READY TO LEAVE WORCESTER.

Some of the Perfect Score Cars that Completed the New York Boston Run

CADILLAC ENTRIES ARRIVE AT WORCESTER.

RUTHFORD MATHESON AT NEW HAVEN.



through them without difficulty. As big and powerful machines as the Mathesons and the Stearns had to use their low and second speeds, and the first three cars through, the Mora, Hall's Matheson and Vaughn's Stearns, took to the trolley tracks as a better highway. From Springfield into Boston, however, there was no trouble, many of the roads being in remarkably fine shape for this time of the year.

The control next after Hartford was at Worcester, where the local automobile club had affairs in charge, and it was a run of 79 miles, with 42 miles more to cover into Boston. At Worcester a number of Boston autoists met the muddy caravan, Watson Coleman, of the White branch, and R. H. Johnston, of that company, acting as pilots in a large White car, and a number of other machines joined the party. It was just getting dark as the cars entered Commonwealth avenue, but they had no trouble in reaching their destination in front of Mechanics Building where they were checked in. The accident at Fairfield had caused the authorities from Worcester into the finish to be stricter even than usual and so no high speed was attempted by the contesting drivers. In most places, however, there was little opposition to seeing the cars go about as fast as possible.

Fourteen cars in a deadlock out of twenty was not a pleasant outlook for those who wanted the run to decide a definite winner, but on the other hand, it generally pleased the trade, as showing what the cars are able to do, in this kind of weather, on bad roads, when kept going at high speed. The cars and men taking part in it made up a really representative assortment, more so than was expected when the event was gotten up on short notice. The machines all seemed to be good ones and well able to undergo the test again, at once, without further preparation than oiling. In the lists of cars there were some which have been in the public eye before, the Stearns, which Guy Vaughn drove, being the same one used in racing, the Maxwell, driven by Kelsey, being the one entered in the Fairmount Park race in Philadelphia, the Premier, driven by MacNamara, being the one which finished the Quaker City Motor Club January run with the only perfect technical score, the six-cylinder Mora being the first of that type built by the Mora Company, the Cleveland being one which raced on tracks around New York City last fall, and several other cars have been especially prominent. The big Matheson touring car, driven by Hall, was the only seven-passenger car in the run and it was well up with the leaders at all times, starting fifth and generally finishing third at controls.

The contestants often ran in groups, the first one composed of the two Stearns, which were very fast, the Matheson touring car, the Mora roadster and the Acme tourabout. The Renault also gained the reputation of being extremely fast, but it was delayed by the police and had a handicap to overcome. Pisani, the Zust driver, was criticized by others for his recklessness, and his way of running at about forty miles an hour and then turning around in his seat to see who was behind, so that once in doing this he had to make a quick application of his brakes and nearly precipitated a mix-up between himself, Guy Vaughn and Hall's Matheson. C. E. Force had his Lozier car stripped and driven by Ralph Mulford, and these two were well plastered with yellow clay before they had gone very far. Kelsey showed the speed of his Maxwell between Hartford and Springfield by passing fifteen cars and coming in about fifth instead of twentieth. The two Cadillac cars, the KisselKar and the Coates Goshen took the run very easily, though the latter ones had to stop and were late, the Coates Goshen at Boston and the KisselKar at New Haven. Carris in his six-cylinder Franklin took the run easily but fast and was one of the first into the Worcester control. His was the only air-cooled car in the contest, and as is usual, had no reason to fear any trouble from that score. One of the largest cars was the Matheson tourabout, a four cylinder one, driven by C. F. Rothfuss, which made a perfect run throughout the trip.

There was some discussion as to whether there would be a run-off but the entry blanks stipulated that in case of a tie there would be a drawing for the trophy, and that would have been held

on Friday but for the fact that the Referee, L. M. Bradley, of the A. M. C. M. A., decided to wait until he found out what would happen to Lacroix. The Lozier entrant protested because of a mistake claimed to have been made by the checker at Worcester in sending him away two minutes out of order.

The latter part of the run was marred by an accident in which E. P. Blake, the New England Jackson agent, F. Ed. Spooner, the photographer, and C. P. Richardson, of New York, were involved. They went out to meet the contestants and while coming back, in Marlboro the car turned turtle, throwing out the occupants. Messrs. Spooner and Richardson suffered merely from shock, but Mr. Blake was taken to the hospital, where it was stated that his injuries were not serious. The result of the run caused much jubilation among the tire men. Guy Vaughn's Stearns was equipped with Continentals; the Renault Zust and two Mathesons had Michelins; the Premier and Franklin had Goodrich, and seven others had Diamonds.

Chairman Frank B. Hower, of the A. A. Contest Board, sent out to Worcester a pacemaker to lead the cars into the finish, in Glidden Tour fashion. One of the cars in the run left Worcester about five minutes after the pacemaker and averaged at least 35 miles an hour over roads where there was little or no traffic, and never once caught up to the pacemaker. Those familiar with past Glidden Tours saw little difference between the speed of the run from New York to Boston and the annual A. A. A. event, for there was no more speeding than in the annual mid-Summer national contest.

PHILADELPHIA CHAUFFEUR GETS ONE YEAR.

PHILADELPHIA, March 15.—Irresponsible chauffeurs and owners who are inclined to dally with the local speed laws, to the possible injury of their fellow-citizens, were startled last Friday when Harry Brutslin, a local chauffeur, on trial for running down and injuring Miss Ada Fadeley, on October 31 last, was convicted of aggravated assault and battery, and sentenced by Judge Sulzberger to one year in the county prison.

Before sentencing Brutslin, the judge said that conditions required that he should be made an example. "Men such as you seem to forget that the streets are for the use of all the people. Under the local police regulations all trolley cars are required to come to a full stop on the near side of every cross street, and it is the duty of all other vehicles, and especially automobiles, to do the same. The tooting of a horn is only an aggravation of the offense of reckless speeding, as it tends to confuse and perplex a pedestrian."

The holding in bail, in the large sum of \$2,000, of A. M. Van Osten, who ran down Edward S. Vaughn on February 19, and who has since been sued by the latter for \$10,000, is additional evidence that the announced determination of the local judges to put a stop to the overspeeding habit is no "fairy tale."

DETAILS OF DETROIT RUN COMPLETED.

DETROIT, March 15.—Details of the second annual reliability run of the Detroit Automobile Dealers' Association, which will differ materially from last year's event, have been completed. Detroit will be the starting and finishing point on each of the four days' runs, the machines being parked at the Hotel Tuller each night. The addition of another day will also make the contest more strenuous, although that will be more than offset by the advantage of not having to spend a night in a country hotel, where accommodations are far from first-class, as was the case last year.

May 10-13 are the dates selected for the run, the first day's journey being to Port Huron and return, taking in Mt. Clemens, Marine City, Ste. Clair, Capac, Romeo and Utica. The second will be to Jackson, Adrian, Tecumseh, Saline and Ypsilanti, thence back to Detroit. The third day will be to Pontiac, Lapeer and Flint and return, and the fourth to Lansing and return. A large number of entries are promised.



WASHINGTON'S BIRTHDAY has come to be the one big fête day in Hawaii, and this year was no exception to the rule. The floral parade at Honolulu was witnessed by the largest crowd of spectators in the history of the event, these including representatives from eight or nine nations. A conservative estimate of the number of tourists places this at two thousand, many of them having timed their visit to coincide with the big "doings."

The parade was larger than any previous year and was materially assisted in the making of a fine impression on the tourists by perfect weather. The character of the designs and decorations of the entrants was fully up to the high standard set in previous years. The entries were spread evenly over five classes, but the first, largest and most important was the automobile division. In this four prizes were awarded to the best float, most original decorations, best runabout and best touring car. Great zest was given to the affair by the capture of the last-named prize by the Japanese Consul-General Uyeno. This was intended to show the existing "aloha" between America and Japan, the idea being expressed by the use of suitable flowers. Thus the meaning of the combination of American Beauty roses with the cherry blossoms of Japan was plain to all.

The judges were all visitors, "malihinis" in the native tongue, and were chosen from among the guests at the various hotels. Their work, always so difficult, was splendidly done, and no adverse comment was heard. One source of regret, however, was the small number of prizes, relative to the large number of contestants.

One of the most daring designs, and one that showed the careful work of preparation, was the float entered by the crew of the naval tug Iroquois, this being a nearly life-sized duplicate of the tug. The whole conception was splendid and was worked out to the smallest detail, even the lifeboat, filled with calla lilies, swinging from the davits.

A car of equal interest was the National car, on which the color scheme of red, white and blue was worked out in carna-

tions, daisies and asters. Balloons of the three colors floated above the car, the body of which was covered by flags and flowers. This was cheered all along the line of the march. Another semi-patriotic float, and a very appropriate one, represented what happened to George, meaning George Washington, of course. This presented a Mount Vernon tableau shortly after the cherry tree was no more, and showed the paternal Washington, birch in hand, and the disconsolate son preparing for the worst.

The beautiful decorations and costly floats were not confined to the automobile division by any means, the wagon and bicycle classes revealing many artistic productions. In the latter the Japanese, with their clever designs, captured a majority of the prizes. Most of these were fishes or animals.

The wagon float which took first prize was that entered by a well-known musician, and was intended to represent Music. It was an exquisite creation of violet and white paper flowers, surmounted by a lyre in the same colors. The harness was wrapped with purple, contrasting with the horses, while all of the occupants were costumed in harmony with the color tones of the float.

In the evening a street carnival of the Mardi Gras order was held. This was an innovation this year, but the spirit in which it was received and the fun everyone had out of it, without any roughness, insured it as a permanent feature of future carnivals. The Elks and the Fifth Cavalry boys helped greatly by turning out in large numbers and with a fine lot of original ideas in the way of costumes.

The day was fittingly closed by an elaborate masked ball at the Alexander Young Hotel roof garden. The costumes were surpassingly beautiful, and the roof garden, with its lights and floral decorations, showed up at its best. The attendance was large and was a merry jostling crowd of fun-makers, who danced and danced until the musicians were tired, and even then called for more. After it was all over everyone voted it the most elaborate and by far the most successful of the Washington Birthday celebrations which have been held in Honolulu

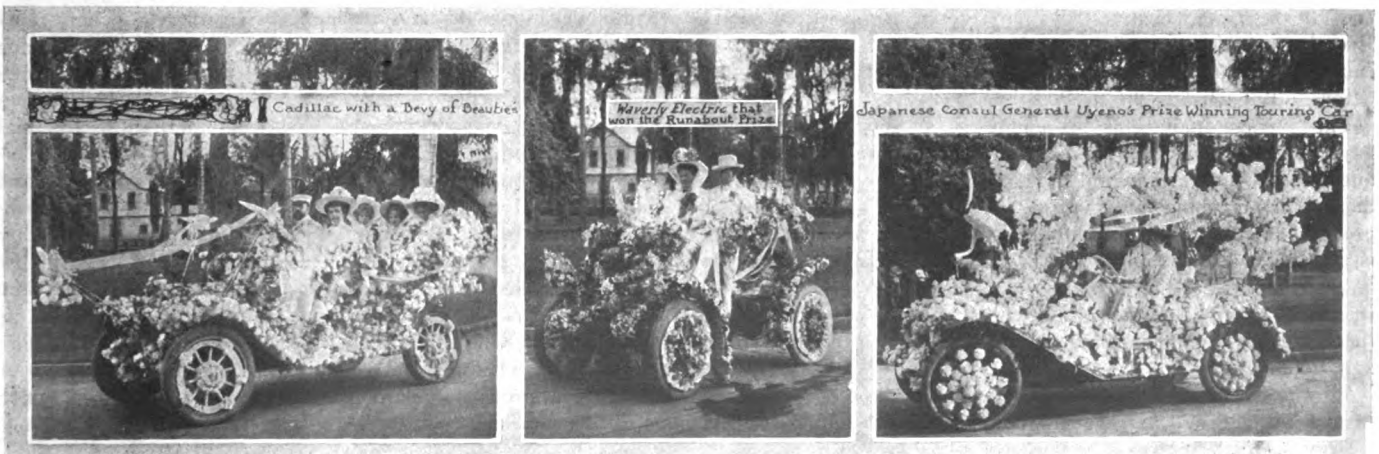

INVOLVING ROAD RACES AND LEGAL SPEED

By E. P. CHALFANT, GENERAL MANAGER A. L. A. M.

THE public must now realize that automobile contests are in their infancy. However, the most expert men in the business cannot tell what turn the sport is going to take next. The whole manufacturing world is divided on the subject of racing. One maker says the sport is of no benefit to the industry; another says it helps more than anything else. Some favor a speedway, but urge the importance of practical contests.

Racing undoubtedly has a very material function in mechanical progress. It develops the art of driving specifically, and executive ability broadly. It has a great human interest, which will not and should not be suppressed. It is undoubtedly the supreme test for one thing, and its excitement and interest have proven of such a nature as to draw the biggest crowds ever seen at any sporting event. The road race naturally stimulates the strongest efforts of the designer, the draughtsman and the manufacturer. To continually improve the result to the limit of skill is to gain for the factory and the industry.

Healthy growth and development can, however, proceed on no other than rational lines. The members of the Association of Licensed Automobile Manufacturers have done much to encourage rational contests and keep them within proper bounds.

Recently in various parts of the country challenges to speed and endurance contests on the public highways have been issued. Wherever such contests involve a violation of the village, town, city or State speed laws, obviously they should not be tolerated. The inhabitants of the territory passed through at an illegal rate of speed may very reasonably have a feeling of bitter and retributive resentment, which may very possibly record itself in positive legislative action, which will oppress the fair-minded autoist and militate against the interest of the automobile industry as a whole, and impede the normal development of mechanical road traction. Such short-sighted affairs can only tend strongly to precipitate contemplated adverse laws in the form of bills proposed in the various State halls of legislature, or, unhappily, to defeat the passage of such liberal legislation as may have

received some encouragement. There was an instance of the last mentioned kind in a State nearby recently.

It is impossible to foretell what may be the result of any "cross-country" road race at speed. It is difficult to run a race in which speed is not used, no matter how the driver may be limited in action. Invariably speed laws will be broken.

Let us consider the worst effect of all. Motorists in this country, assisted by a good many other people, are doing their utmost to get good roads appropriations through State legislatures and Congress. The violation of speed laws can only alienate friends in this field and prevent the making of new ones. It should only be necessary to recall to any forgetful mind that good roads are largely the sine qua non of autoing.

If road races must be run, a twenty, thirty or forty-mile course should be arranged for by consent and according to law; and be properly protected and policed during the conduct of the race. Doing anything else is worse than unkindness to a dumb animal. The automobile can easily survive conflict with its legitimate enemies. Nevertheless, it should be protected as much as possible from its unwise friends. Many of the members of the Licensed Association have consistently supported sensible contests and will continue to do so.

Incidentally, special challenges are seldom justifiable. There are opportunities enough to race on properly guarded courses in due observance of law.

A reliability contest, of not more than a day's duration, over recognized automobile thoroughfares, conducted by promoters who obligate themselves that speed laws will not be violated (safeguarding this obligation by proper controls), can result in the fair promotion of the sport, and in properly testing out new models for manufacturers, particularly when such contests are held under difficult road conditions. A notable case in point is the contest held between New York and Boston this month, the controls being so well placed as to make it practically impossible to exceed the country speed laws of twenty miles an hour.

"THE MORE THE HASTE, THE LESS THE SPEED"

By CHAS. E. DURYEY.

CONTEST time of year is nearly here. Races, tours and hill climbs will be the menu generally as heretofore. Yet everybody knows that speeds on the level and up hills are faster than there is any call for. No sane buyer cares to rush the hills at dangerous speeds. The gain does not pay for the cost in fuel, tires and other things. Same with road speeds. Our lawmakers are trying to discourage more road speeds and are hitting the innocent with the guilty. Rather more, in fact, for it is the slow-going law-abiding driver that gets caught while the scorcher gets away. And still we inaugurate such contests and fan the flame which destroys our rights. And to what good? Everybody knows now that speeds are a matter of price. Pay enough and the rig can be built that will beat anything gone before. But what is the use?

The average man claps his hands, as at any fireworks, and buys something he can use. Makers who have goods to sell ought to encourage this kind of man. Why does not the awarding of hill-climbing prizes to the rig which gets the lowest product of time, multiplied by price, solve the problem? This is certainly what the buyer wants. Low time and low price. It is easily figured. The man at the roadside can get the result, just as he now pulls his cheap watch on the time only. It would therefore be a popular way of judging. But it needs a little agitation.

Why not coasting contests? These would show the efficiency of the mechanism. Let the hill be coasted with clutch set and

spark and throttle off. Oil, brakes and everything else normal. Then the man learns whether he is wasting fuel turning mechanical parts or using it to propel his vehicle. Efficient size of wheels, efficient tires and all such parts would figure in such a test, and the buyer would learn something practical. Tests by coasting with clutches disengaged would also show up the efficiencies of the various transmitting devices quite well. But in such tests it would be necessary to classify according to type of transmitting mechanism or rigs like the Duryea buggyaut, which has no parts turning when coasting except the ball bearing vehicle wheels, would have an immense advantage. There must be an enormous difference in the fuel costs of a vehicle which can be towed by a pull of three to five pounds and one which requires thirty to fifty pounds, as many rigs do. The coasting contest brings this out in such a way as to disclose the real utility of an automobile, reflecting stability as well.

A towing contest would do this also, but not so easily and simply. Yet I do not see why our able committeemen having such contests in charge cannot devise rulings which will bring out the things practical buyers need to know, and leave in the background the facts already too well known. Forget the "cannon." Fourth of July does not come frequently. Give us something that will put meat in the pot. Then, give us the pot, and let us have the fire, but refrain from marking sizzle all over the aggregation as if, indeed, we have lost the process by which we can be calm and cool, or, better yet, sane.

SAFETY AND UTILITY OF AUTOMOBILE STEERING SYSTEMS

By Thos. J. Fay Part II

STEERING is not necessarily a safe enterprise because speeding on curves is avoided. Speeding on a tangent (in a straight line) has the disadvantage of making it difficult to steer clear of an obstruction if, perchance, the speed is so great that the car cannot be stopped in time, and if room is not afforded sufficient to clear the obstruction.

Applying the brakes will be of no value at all when the speed of a car is so great that it cannot be stopped within the distance afforded. True, a car can be slowed down, and in so doing

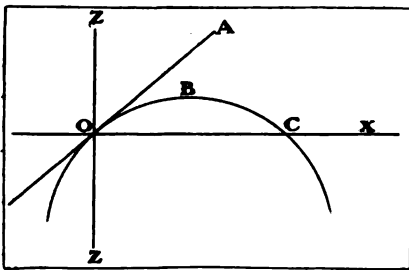

Fig. 9.—Diagram of unrestricted projection of bodies in atmospheric air.

take advantage of the brakes and all possible. When the brakes will no longer serve it is then a question of steering only, and since it will be difficult to avoid a collision under such conditions, the question is, what will be the safest course? There is no actually safe

way, since, presupposing a case in which a car cannot be stopped, is admitting that an obstruction will be collided with, assuming it is in the way. It would be easy enough to say, do not go so fast that the car cannot be stopped within the allowable distance. But this is so self-evident as not to require any attention, and the other side of the question has its serious phase. Attempting to turn out after it is found that the speed cannot be checked is dangerous, since if a car turns over it is likely to do more damage to the occupants than as the direct result of a collision, if the same is intelligently courted.

High Speed Will Cause a Car to Capsize.—The chart, Fig. 8, shows under what conditions a car will capsize if the speed is too high, and if the turn is short enough to introduce a sufficient turning moment. The chart shows, for instance, that if a car is turned on a 50-foot radius it will capsize when it is going at 26 miles per hour, in round numbers. In this case it is assumed that the car is well designed, and that the road is level and hard. If the road is slippery, it is then that the car will skid until the wheels take a "purchase" against some obstruction, and then the car will capsize. The end will be the same in either case, and the method is not to be recommended.

If a turnout (which really amounts to speeding on a curve) is so fraught with dangers, the question is, what is the best thing to do? If, in an emergency of this kind, the car is steered straight ahead in order to prevent turning over, and if a collision follows, the main point is to so direct the collision as to be sure of a clear space ahead in which to shoot out of the car and travel the greatest possible distance in the air, unobstructed, before landing.

Safety Lies in Leaving the Car.—Following the law of the unresisted projectile seems to be the safest course, and, as Fig. 9 shows, the performance will be in obedience to a compound of vertical motion of a falling body, and of the horizontal motion due to the horizontal component of its velocity of projection. In the figure, let O represent the point of projection (the seat of the car), and while it will be impossible to tell the "elevation" of the path, let the direction OA indicate an

upward inclination. In this way it will be feasible to say that the path OA as it relates to OX will be at some angle. Let the angle XOA = θ . The horizontal increment will be equal to

(5)..... $V \cos \theta$

The vertical (downward) increment will be

(6)..... $V \sin \theta$

When

V = velocity of projection, so that, at the instant of projection, the two components will be in the relation as above given.

Gravity influences the situation in accordance with the gravitational laws, just as would be the case were a motorist to fall out of the seat to the ground, the vertical distance from the seat to the ground, and the fall will be no more damaging if the same motorist shoots ahead for whatever the distance may be, complying with the law of "unresisted projectiles." The time interval during the projection will be that required for the motorist to fall to the ground direct from the seat. The distance that the motorist would shoot ahead could be worked out, but it would be of small avail. In one case that the author had a chance to examine into closely the distance was 69 yards, in which case the motorist was not hurt, for the reason that he did not strike anything while going through the air more resistant than the air.

In an emergency such as this it would seem as if it is better to select the collision point with a view to accepting the projection, rather than to turn out, and in so doing be sure of turning the car over with good chances of landing under the same. The main reason for thus attacking the subject, however, is to clearly indicate that it is not safe to drive under conditions which will not allow the motorist to see ahead far enough to allow him to judge of the nature of the road if the speed is so high that the brakes will not serve for the purpose of quickly arresting motion, thus making it absolutely a question of steering.

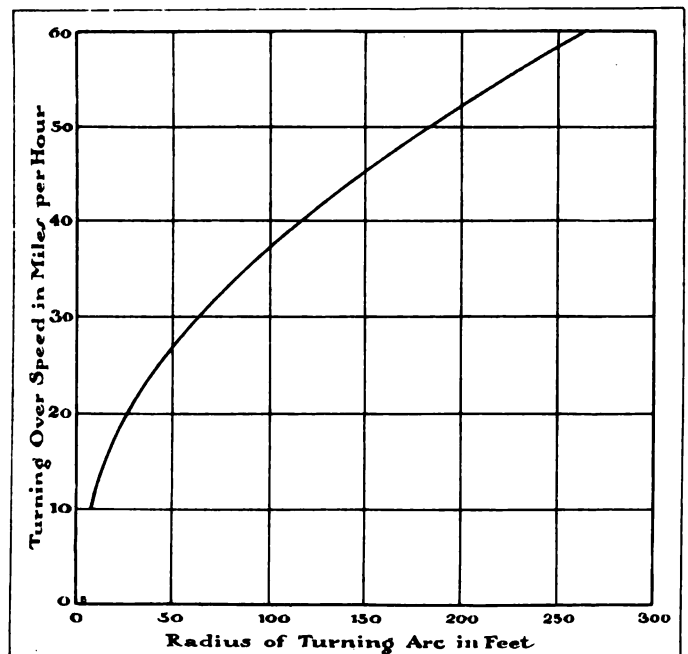

Fig. 8.—Showing speed on curves which will cause capsizing.

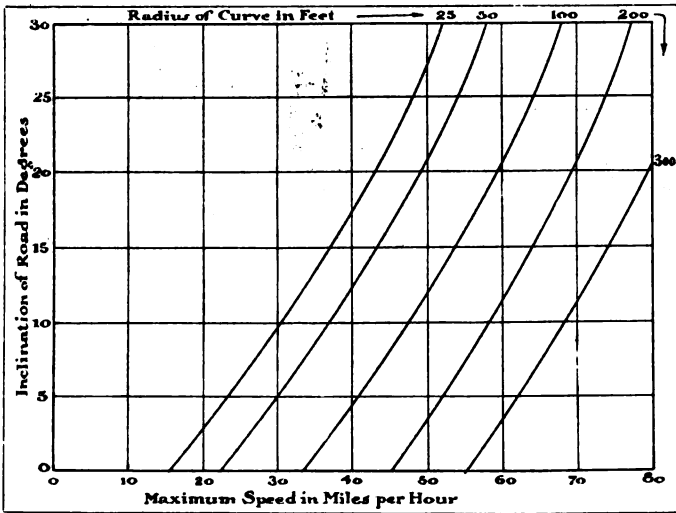

Fig. 11.—Curve showing advantage gained by banking roads at turns to suit different speeds.

That the future will hold some improvements in this connection is shown by the latest devices abroad*, in which air is used to help snub motion, and since the air is in no way connected to the question of adhesion of the tires to the road, it follows that air brakes will put a new face on the situation and possibly shorten the distance in which motion can be arrested. Fig. 10 gives information in relation to the resistance offered by air to the transit of a body, and the chart will apply in two ways to the point to be here made. As the chart shows, if a car is going, say, 60 miles per hour, the wind resistance will be between 13 and 14 pounds per square foot.

Air Propellers Will Serve for Brakes.—If an air propeller will serve to drive an airship, which is a settled fact, the same air propeller will serve to stop a car, and it matters not at all if the car is going through the air or rolling over the ground on wheels. If the car is rolling over the ground it will be possible to snub motion with the idea of reducing speed to a safe point, in view of the road condition (a) by using the brakes up to the limit of the tractive ability, and (b) through the use of the wind brakes, which will work whether the wheels slip or not.

It is this same wind resistance which enables one to be projected out of a car and land at a considerable distance ahead without being seriously hurt. The energy is expended in overcoming wind resistance, and the end is that the fall to the ground from no great height is all to be dreaded. On the other hand, it is of the greatest importance to select an unobstructed orbit, if such it may be called, to avoid impact with some obstruction, since such a contingency will result in another story.

Wind Resistance Must Be Taken Into Account.—To show that wind resistance is quite an effective phenomenon to encounter it is only necessary to take into account the result of the pressure at 60 miles per hour as before referred to. If the resistance is fixed at, say, 13 pounds per square foot, and if the front area of a car is 10 feet, the instantaneous value of the horsepower increment will be fixed by the formula,

$$(7) \dots\dots\dots \text{H.P.} = \frac{PA (M \ 5,280 | 60)}{33,000} = 0.96 \text{ PAM.}$$

When,

- H.P. = Instantaneous value in horsepower;
- P = Pounds per square foot pressure due to wind;
- A = Front area of the body in square feet;
- M = Speed in miles per hour.

As a practical demonstration of the formula, assuming that the front area of a car may be 10 feet, if the speed is 60 miles

Note: See article by W. F. Bradley, entitled "Just Out of the Shops Abroad," in this issue of "The Automobile," in relation to the subject of wind brakes.

per hour, the wind resistance will have the equivalent value as follows, almost without respect to the shape of the front area against which the wind must beat—nor does it seem to make any difference whether the surfaces are at the front of the car, or to the back:

$$\text{H.P.} = \frac{13 \times 10 (60 \times 5,280 | 60)}{33,000} = 20.8.$$

Thus far the discussion has taken into account hard, level roads. If roads are "banked" on curves it is quite another story that may be told, for then the speed can be increased as Fig. 11 will show. As the curves look, if the inclination of the embankment is 20 degrees, and if the curve is at a radius of 300 feet, the speed can be 80 miles per hour, which is a very considerable increase over what can be allowed if the road is level. On a level road it was shown in Fig. 1, Part I, of this article that the speed could be but 53 miles per hour with the same radius of curvature, i.e., 300 feet.

Banked Curves Make for Safety.—Another look at Fig. 11 will show that decreasing the radius of the arc of turning has the usual effect even if the road is banked, in that the speed must be lowered if the radius is shortened. If the radius is, say, 100 feet, then a 20 degree inclination of the embankment will allow of a speed of about 60 miles per hour. Of course these speeds sound high, but by dealing in high figures it becomes possible to accentuate the points to be made. It is also true that banking should be in excess rather than restricted in the cases requiring attention with a view to increasing speed.

Camber of Roads Puts a Different Face on It.—Unfortunately, roads, instead of being embanked, are cambered (with a crown at the center) in the manner as shown in Fig. 12, the amount of the camber differing in the several localities, and under varying conditions. The "crown" or camber of the road is quite pronounced on many "pikes" as to become a menace under certain conditions of steering. The general formula of the crown which would serve well for drainage purposes in practice is given as follows:

$$(8) \dots\dots\dots O = C \left(\frac{D}{R} \right)^2,$$

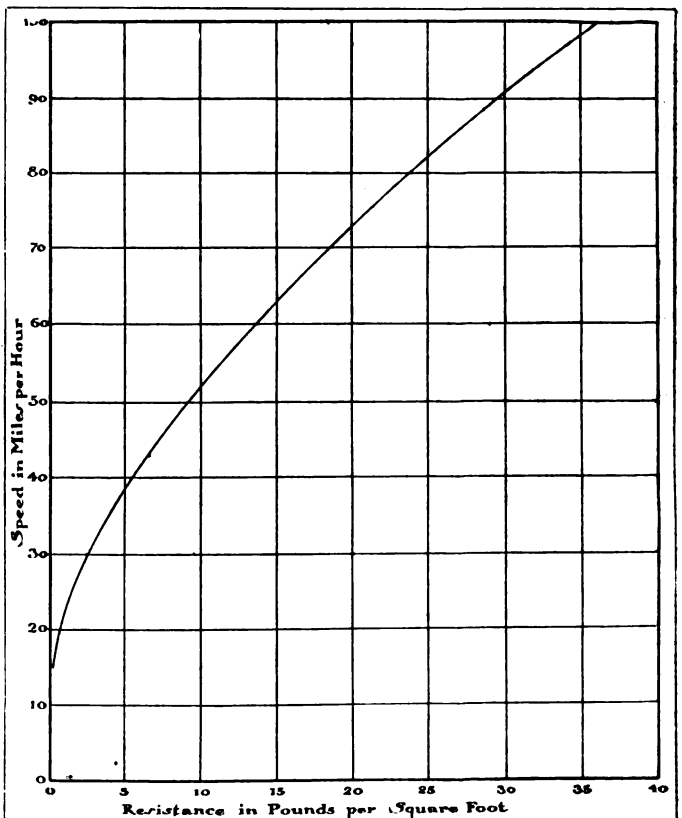
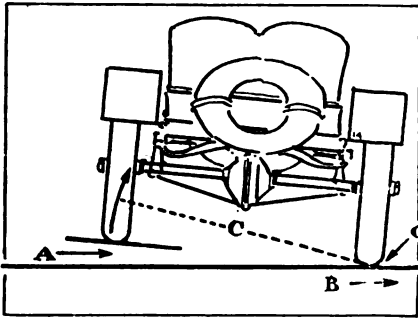

Fig. 10.—Curve showing resistance of bodies through air.



When,
 O=Ordinates in inches;
 C=Crown in inches;
 D=Distance in feet
 from center of the
 road to the ordi-
 nates, in each case;
 R=One-half the width
 of the roadway in
 feet.

Taking into account
 the camber of the road
 and the fact that, in
 turning, the off side of

the road is used, it is plain to be seen that, instead of an embankment, it is a declination that will be used. The effect of this declivity is the reverse to that of an embankment, as the curves, Fig. 13, show. Looking at the curve will show that on the 5 degree slope (downward) the safe speed is reduced to 24 miles per hour, approximately, if the radius of the turn is 100 feet. The same turn can be made at a speed of 32 miles per hour if the road is level, as the curve also indicates, and with an embankment of 5 degrees it is shown in Fig. 13 that a speed of 38 miles

a car tends to turn in a circle the axis of which will be of a cone, as shown in Fig. 15, at O. If one of the tires is allowed to come off, the cone will touch the rim of the wheel without a tire at A and A' and the outer wheel, on which the tire will remain, will contact as usual at B and B'. The radius of turning will be such as to introduce a serious hazard even if the speed on the car is not very high, unless the driver prevents the car from turning around on the circle whose axis is at O in Fig. 15, since the radius of the curve might be even below 20 feet, depending upon the sizes of tires used on the wheels.

It is interesting to note, then, anything which will tend to seriously reduce tires to the point likely to cause a "blowout," such as running on car tracks, as shown in Fig. 16. In this case it is plain to be seen that all the ingenuity in the world could not bring on a blowout any quicker. This section of rail is not used in modern streets in which the pavement is good, but it will be found in the sparse districts, just where the rolling may be had, and when the temptation to use the car tracks will be the greatest. In all cases the use of car tracks is to be looked upon as dangerous, even in the cases in which the rails are flat on the tread, for the reason that rails do not always remain in good order, and a knife-edge will soon make short work of the casings.

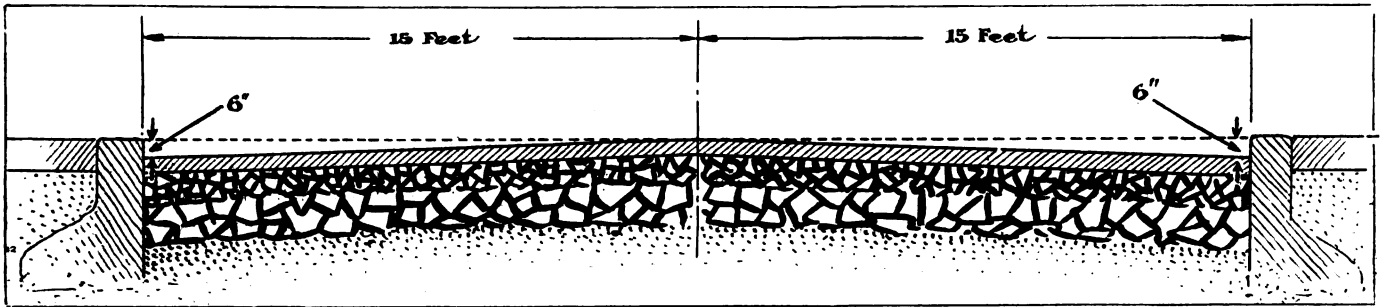

Fig. 12.—Cross-section of roadway showing effect of crown on turning.

per hour will be safe. Obviously, much depends upon the slope of the roadway at the point of turning, and if the slope is declining, provided the radius of turning is short, it is anything but safe to make the turn at a very high speed.

Tractive Ability Declines Rapidly.—Since steering really depends upon the tractive ability of the wheels of a car, it is of interest to note that the traction decreases as speed increases, and on a curve, where the traction is the most needed, the in-wheel leaves the road if the radius of turning is short or if the speed is high. Fig. 14 shows something of what does happen, assuming in this case that the car is being viewed from the rear, and making a turn to the left. The in-wheel will leave the roadway at the point A, turning on the out-wheel as an axis at the point O, to the radius C, rotating in the direction as shown by the arrow. The wheel in contact with the roadway will tend to slide in the direction of the arrow B, and this wheel will have to afford all the tractive force.

The curves for speed on arcs of circles will hold true in all cases in which the radius of turning is not too short, but the performance as shown in Fig. 14 will defeat all the laws and render the going dangerous, unless it is on "banked" curves, when the in-wheel will tend to stay on the ground, affording some measure of the tractive ability excepting when the speed is higher than that allowed according to the curve of safe speed under such conditions. As a rule, skidding will intervene before the in-wheel will leave the ground, but a rut in the roadway or an obstruction in the way of skidding will introduce an accident.

Bursting Front Wheel Tires Dangerous.—In fast going, it generally happens that the bursting of tires, as in a "blow-out," results in danger to the occupants of the car, because the diameter of the wheel is less after the tire bursts, while the tire on the opposite side remains as before. The result is,

Tires Should Be Inflated Sufficiently.—In many automobiles the front tires are of smaller section than on the rear, primarily to afford a sufficient turning (canting) angle of the wheels, but there is a second reason bound up in the ease with which the narrow tires will allow the steering wheel to cant the road wheels around. The difficulty in steering is accentuated if the tires are not properly inflated, while the wheels will bounce off of the roadbed if the pressure in the tires is excessive.

While it is true that the rear wheels should be inflated more than the front, because the load to be borne is more, the fact remains that the front tires should be stoutly inflated in order to

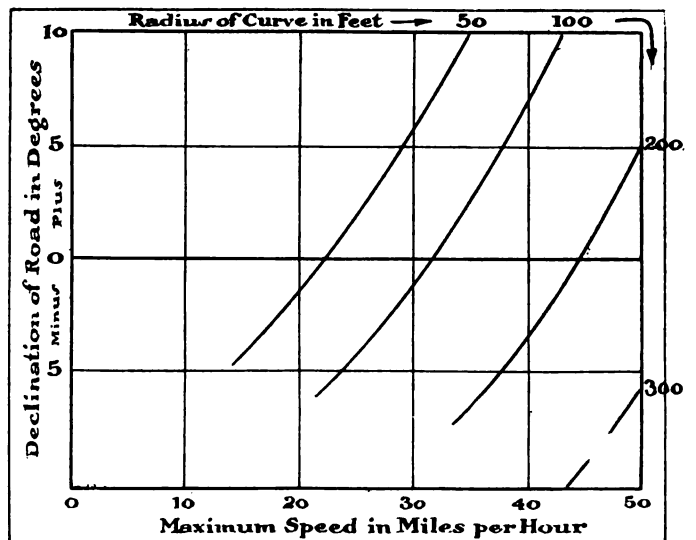

Fig. 13.—Effect of declination of roadway on turning speed of car.

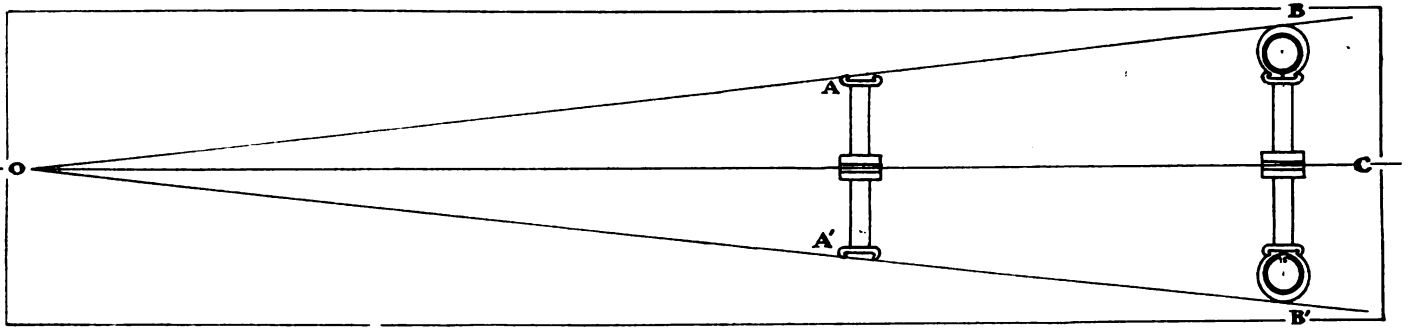

Fig. 15.—Diagram showing how to find turning radius with one tire off.

assure traction on a maximum basis, on the one hand, and to enable the wheel to cant easily on the other. The pressure per square inch at the point of contact of the tires will depend upon the weight on the wheels and the degree of inflation. If the tires are not well inflated they will squash down and the area will increase accordingly. In this case the pressure per square inch under the tires on the roadbed will be low, whereas if the tires are well inflated it is then that the pressure per square inch will increase accordingly, with the result that the adhesion

will be augmented, unless it is that the tires are inflated to a point eliminating any tendency to squash.

The curve, Fig. 17, affords information in relation to the extent to which tires should be inflated the best results. In this case air is taken as the medium for the purpose, and it will be worth while to call attention to several details involving the use of other gas media besides air,

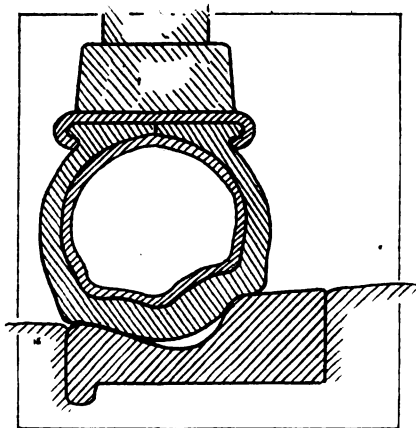

Fig. 16.—Section of tire when deformed by car track of this shape.

since the results are not the same in all cases. The curve, Fig. 17, shows that the pressure of the air increases as the tires heat up, as they will under the load, due to molecular work. Some inflating gases are more marked in this phenomenon, and it is important to take this into account.

Diffusion of Gases Depends Upon Composition.—Air will stay in tires longer than any other gas used for the purpose, for the reason that the diffusion of air through rubber is at a lower rate than will be that of carbon dioxide or any other gas such as might be used for the purpose, of which the author has knowledge. In some experiments which the author made for the purpose it was found that the ratio of diffusion of air to carbon dioxide was as 12 is to 30, considering the tubes used in the experiment.

If the inflating is done with carbon dioxide it is necessary to take into account the rate of diffusion, and inflate the tires more often, so that the desired pressure will be in the tires at all times. It is at the time when such matters are not attended to that dangers arrive and hazards make bold to proclaim ownership. It is also true that some gases increase in pressure due to heat, more than air. This is a matter for separate treatment.

Should the Front Road Wheels Toe In?—If the front road wheels are not set parallel steering will be affected in some way depending upon the relation of the wheels to each other. If one wheel toes in and the other is parallel with the roadway, it will be very difficult indeed to steer the car, especially if the road is in a slippery condition. If both wheels are set parallel to each other, and parallel to the roadway, steering will be far less difficult, but it will still be far from perfect. One way to over-

come the troubles of steering as they come from the set of the front road wheels, is to have both wheels toe in.

The amount of the in-toeing should not exceed 1 degree from the center, for each of the wheels, but it is desirable to have the angle of the two wheels carefully adjusted, so that they will both toe in the same amount. This in-toe will cause slight wearing of the tread of the tires, but it is probable that the wear will not be so much as will follow if the wheels are not so adjusted since in the absence of this set of the wheels they will be more prone to skid, and it is a moral certainty that skidding is the most damaging to the tires of all the happenings on the road, barring a tenpenny wire nail, fastened in a board, with the business end up.

There is one other advantage to follow the set of the front road wheels in the manner as described. It is difficult, if not impossible to keep all lost motion out of the knuckle joints, and as this lost motion increases, it tends to throw the wheels out of the right relation with the road, and with this mal state, steering troubles are increased to a vast extent. In other words, the sag which must follow lost motion in the knuckle joints will cause the wheels to toe out, but there can be no assurance at all that the two wheels will toe out an equal amount. As against this, it is generally conceded that, if there must be a difference in the amount of the toe, it is better to have both wheels toe in, in any case, even if they do not hold to exactly the same angle. If the wheels toe in, and if in slowing down, with a view to coming to a stop, the power is not thrown off, skidding will not follow, even if the roadway is not so very good. The design of gasoline cars does not permit of leaving the power on, but in electric cars it is possible to allow the motor to stay in circuit, exerting some force. It is even possible with planetary gears to take advantage of this fact. A good deal depends upon the acumen of the driver when reference is had to difficult road work, and it is the height of folly for a new driver to trust to his lately acquired experience to guide him through dangerous channels due to speed-made tendencies in the absence of enough experience to assure a fair measure of automatic action.

(To be continued.)

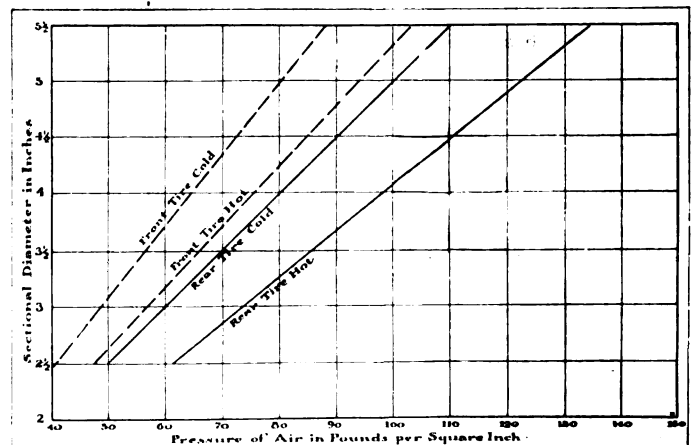

Fig. 17.—Showing initial and heat pressure in pneumatic tires.

AUTOMOBILE COOLING SYSTEMS ANALYZED

By MORRIS A. HALL.

THE cooling of a gasoline or other automobile engine may seem a simple thing to the uninitiated, but in reality it is far from that and it is a fact that the deeper one goes into it the more complex the situation becomes.

Speaking broadly, the cooling of internal combustion engines, in which category all automobile engines come, is divided into two classes according to whether the cooling medium is a liquid or a gas. This broad classification, when reduced to every-day language, gives us the air and water cooled genera. In the latter case, however, the one mentioned is but a single instance of many. That is, to complete the class, it would be necessary to mention also oil cooling and the use of other fluids. On the other hand, in the class of engines using a gas for the cooling media, the writer has never heard of the use of or any proposal or suggestion to use anything except air.

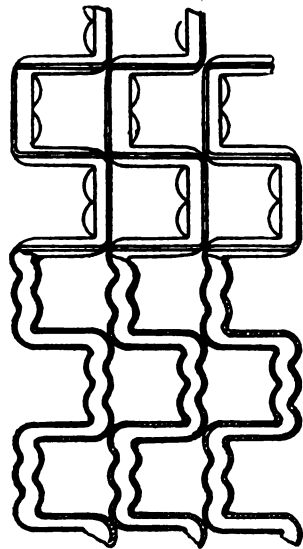

Method of Increasing Surface.

walls cool, and that only. These walls must be kept cool for two reasons: one is to permit of proper lubrication, without which the piston could not move up and down in the cylinder. Lubricants have a definite flash point, and when this temperature is reached they will burn and leave a carbon residue. In other words, then, the cylinder walls must be kept cool to prevent the carbonizing of the lubricating oil.

The second reason for cooling the cylinder walls is to prevent preignition. If the metal be allowed to heat up to red heat, for instance, the fuel will ignite during the compression stroke, previous to the completion of the stroke and thus cause the engine to reverse. Even if not occurring before the end of the stroke, this would cause firing at irregular intervals which could not be predetermined. Consequently, the power would be indeterminate and unreliable.

To go back to the first reason for cooling and the common, erroneous idea of the same, the gases within the cylinders should retain as much as possible of the heat produced by the combustion. Therefore, it is advisable to let the cylinder work at as high a temperature as the lubricating oil will stand without carbonizing. This fact is pertinently brought out by one of the makers of air coolers, who in his catalogue makes the following statement which is quoted verbatim: "The nearer the cylinder temperature of a gas engine can be kept to 350 deg. the better it works and the more efficient it is. In other words, a gas engine does its best work and gets the most power out of the gasoline at a wall temperature of about 350 deg."

With a temperature as high as this, the thermal efficiency is also very high, but the other side of the question lies concealed within the mechanical efficiency. This has no direct connection with the heat-cycle competence unless it be that it varies inversely with the latter. At any rate, it is certain that with temperatures such as this not only common, but the regular thing, it is certain that a tight or even close-fitting piston is impossible.

From this and other details which might be mentioned if space allowed, it is at once apparent that the mechanical efficiency is very low, indeed. The inference then is, to obtain the maximum heat efficiency a large sacrifice of mechanical efficiency must be made. Also, the reverse of this holds, that to get a high mechanical ability, heat efficiency must be sacrificed or a balance struck between the two. This is the course usually pursued.

Reliability the Most Important Factor.—In keeping the cylinder wall temperature high and close to the carbonizing point of the oil, care must be used not to overdo this for, in the last analysis, reliability is the desideratum and by attempting to do too much with the retention of heat within the mixture, this very desirable quantity will be lost. As this is the one factor which held the gasoline engine back for many years, it would be a serious matter to lose it now. This is a factor which the advocates of the simpler gas-cooling systems, in their reaching after simplicity, have lost sight of.

A point easily seen to be in favor of the more bulky, assuredly heavier and admittedly more complicated fluid systems with positive circulation, at once crops out in the light of what has been said above. This, put into words, is that regardless of bulk, weight and complication this, as exemplified by the pump circulated water system, is both reliable and consistent. The ratio of cooling substance to power which upon analysis is seen to be the desired quantity, is here obtained and here only. The positive assurance of this regular, unswerving ratio is worth a great deal and it is a question if it is not worth more than all the extra weight, bulk, etc.

The Relation of the Structure to the Efficiency.—While the bare statement that the structure, or to be more explicit, the design, has a positive relation to the efficiency and a direct bearing upon the results, is at first sight a strong one, the facts, upon close scrutiny, bear it out. It will not be denied that the temperature of the explosion, which is the influencing factor in the efficiency formula, is governed by the temperature of compression. This, in turn, is wholly dependant upon the pressure of compression, which is a fixed portion of the structure, or, in other words, is a predetermined part of the design.

The effect of a high compression then is to increase the efficiency of the heat cycle. This may be done by reducing the size of the compression chamber and by increasing the stroke or otherwise. It is at once apparent that any increase in the initial temperature means a proportionate increase in the heat which

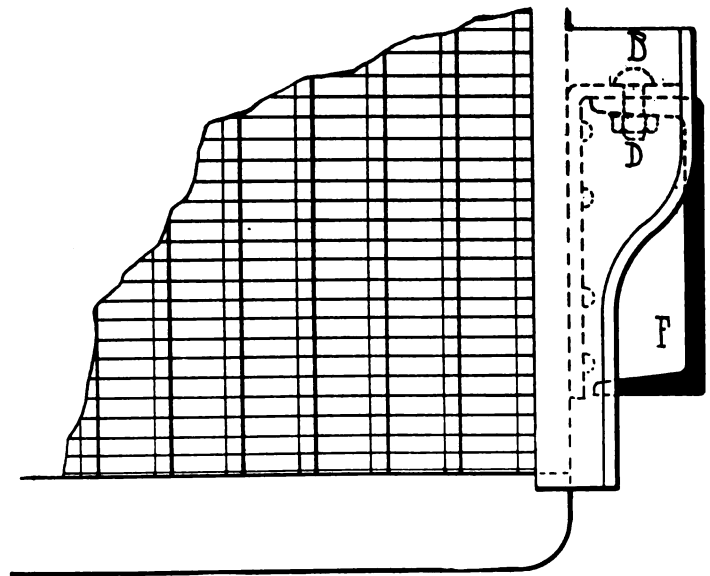

Method of Suspending Radiator from the Main Frame.

must be carried away and in the case of the decreased combustion chamber the difficulty of doing this is increased at the same time. From this it is obvious that an increase in efficiency must not be sought blindly else the results will not be satisfactory. An alternative method is to obtain the desired result by increasing the speed. With the gas-cooled method this is practically impossible, but for the liquid-cooling system, in which positive circulation is utilized, this is an excellent way, as with increased speed of the motor, comes increased speed of the cooling medium because the means of propagation bear a fixed ratio to the speed of the engine.

Heat Balance Expressed in Percentages.—To express the heat balance in a reasonable and easily understood manner, let us give it in proportion of the total heat, or in other words, in percentages of the possible heat which the gas is capable of producing. According to one well-known authority, whose fig-

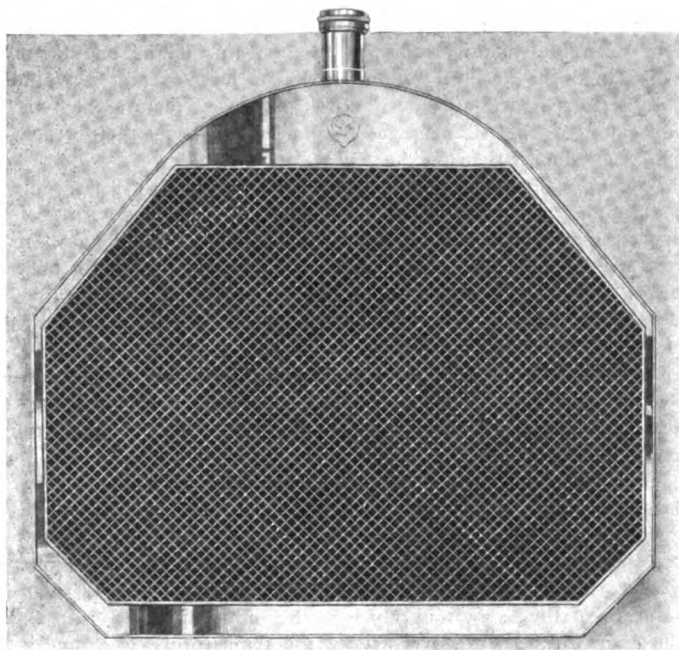

A Neat Example of the So-called Mercedes Type.

ures on this subject have never been disproven and are therefore reliable, the average distribution of the heat energy of the fuel is:

TABLE 1.

Useful Work	17 per cent.
Loss to the Exhaust.....	16 per cent.
Carried off by Jacket Water.....	52 per cent.
Radiation, Conduction, etc.....	15 per cent.
Total.....	100 per cent.

This means, then, that of the total energy which the gas develops in the cylinder, only 17 per cent. goes to useful work as it results in speed, hill-climbing or other manifestations of ability. The other 83 per cent. is wasted in various ways, by far the largest and most important of which is the one we are here concerned with, the heat carried through the cylinder walls and then carried away by the cooling medium, 52 per cent. of the whole, as shown above.

Now to go deeper into this distribution of heat and in particular, into the amount carried by the jacket water, it will be necessary to go into the mathematics and give a few formulæ.

- (1) 1 Horsepower = 33,000 foot-pounds per minute.
- (2) 1 B.T.U. = 778 foot-pounds.

From the above, to reduce mechanical power to heat units, usually abbreviated B.T.U.,

$$(3) \frac{\text{H.P.} \times 33,000}{778} = 42.42 \times \text{H.P.} = \text{B.T.U. per minute.}$$

This mechanical equivalent of power expressed in heat units

may be put in the more convenient form of units per hour by simply multiplying by sixty, or,

$$(4) 2,545.2 \times \text{H.P.} = \text{B.T.U. per hour.}$$

Figures for a Selected Example.—If a 20-horsepower (20 H.P.) engine be selected to apply these figures to, multiplication by 20 gives the heat equivalent of this power as 50,904 B.T.U. per hour. The mechanical efficiency of the engine must be taken into account here so that a factor allowing for this loss must be introduced. This has been known to reach a figure of 90 per cent. or .90, but in calculations of this nature .80 is commonly used. Moreover, from this, the total heat content of the fuel is found by figuring backward from the resultant heat and the proportion of the whole as given above in Table 1, thus:

$$(5) \frac{20 \times 2,545.2}{.90 \times .17} = 332,300 \text{ total B.T.U. in fuel.}$$

From this total the corresponding figures for the other divisions are readily obtained. These are:

TABLE 2.

Division.	Percent.	Heat-units.	Equiv. H.P.
Useful Work	17	56,300	22.2
Exhaust Loss	16	53,000	20.9
Jacket Water	52	173,000	68.0
Other Losses	15	50,000	19.6
Totals.....	100	332,300	130.7

It is then apparent that the losses are enormous, for, to get an actual delivered horsepower of 20, it is necessary to deliver a fuel with a latent content of over 130 horsepower. Of this, the extra 110 is not only unavoidable, but also absolutely necessary from the "nature of the beast," so to speak.

Jacket Water or Other Cooling Medium Carries Most of the Heat.—To return to the subject under discussion, the cooling medium, it is at once apparent that this must carry off an enormous percentage of the total loss. In the above typical case the amount to be disposed of in this manner is no less than 173,000 B.T.U. per hour. To carry through a rough calculation of the amount of fluid necessary to conduct this away let water be assumed as the medium, also let it be assumed that one B.T.U. is the heat necessary to raise 1 pound of water 1 deg., which is not absolutely correct, but simplifies the calculations. Then in a hypothetical case, the water is put in at 100 deg. and taken out at 200 deg., a rise of 100. Then to carry off 173,000 B.T.U. per hour will require

$$(6) \frac{173,000}{100} = 1,730 \text{ lb. of water per hour} = 182 \text{ gal. per hr.}$$

In all fairness, it must be added that these figures are far from the actual. The water will seldom be allowed to reach 200 deg. for in some regions that would be boiling, and the lower limit seldom gets down to 100 for average continuous running. A more fair estimate, then, would just about double the above figures, which were chosen at random to show the method of figuring. The resultant figure is, then, 364 gallons per hour. Reducing this to amount per horsepower, to show the relative quantity to be used:

$$(7) \frac{364}{20} = 18.2 \text{ gals. per H.P. per hour.}$$

This is an approximation, of course, for the mechanical efficiency was assumed, and if taken too high, lowering it would raise the total heat, and with it the heat of the jacket. The increase in the latter will increase the weight or quantity of the cooling water, so it is usual to select such a figure as will give an excess. This is not allowed to keep the cylinders cold, but is circulated slower to compensate for the excess quantity. It is in this connection that the type and mechanical efficiency of the pump used enter into the problem.

(To be continued.)

HOW THE NOVICE GETS HIS INSTRUCTION

SPECIALIZATION in automobile instruction to meet the needs of owners and prospective owners of special types of cars is the latest improvement introduced into its course of study by the automobile school of the West Side Young Men's Christian Association of New York City. Under this plan, while every pupil is given a thorough course in general automobile operation and repair designed to fit a man to be chauffeur of any type of machine, an owner who wishes

to become absolute master of his own car, as well as the possessor of it, may elect to have special instruction which will train him to get the maximum road results out of his car and also to make on the road all ordinary repairs not requiring a machine shop.

That the new plan is decidedly popular is evidenced by the fact that when the school opened for the January term of 1909, a class of 100 students was enrolled, two of whom came from as far as Mississippi and another from Canada to enter.

The plan as outlined would require the services of far more cars than could either be purchased or borrowed, while it would be impracticable to try to get a car just for the occasion from the New York agents when an owner of that make turned up. Inasmuch as the entire fees charged are used to increase the general Y. M. C. A. revenues, it was equally impossible to purchase the various machines.



A number of the manufacturers, realizing the part which this non-commercial school plays in the development of automobilism by training men thoroughly and at a moderate fee, are aiding the officers of the Y. M. C. A. school by donations of cars and models. The Haynes company has recently given a fully equipped four-cylinder touring car, the Ford interests have promised to do likewise, and other makers have accepted the Association's invitations to inspect its work and have shown their interest by donating equipment.

Makers of automobile accessories have also appreciated the value of a good, reliable course of instruction and have aided in the effort to establish an experimental and practical laboratory of automobile devices where its present and former students, numbering nearly 3,000, can study and work with new inventions or types of construction. The gift of Eisemann magnetos from Lavalette & Co., of New York, and a 7-horsepower gas engine from the Bridgeport Motor Company has been much appreciated by the students.

The same plan of instruction that has been followed in the past will be continued this year in all classes of instruction, that of giving all students a thorough mechanical knowledge of motors, and other parts of the chassis in the shops before they are taken out upon the roads. When they are well able to care for a car in case of road trouble competent instructors, one teacher to each student, will take cars out and give lessons in road and street operation, both in the country and on city streets, where traffic practice can be obtained.

A great deal of interest in the conduct of the courses was shown at the Grand Central Palace show, where a booth was donated by the management, and it was there that the attention of certain manufacturers was secured.



It has been discovered by some makers that the courses given frequently lead to sales, principally because of the makes of cars used in instruction, a fact that occurs simply because the Association was fortunate in securing these.

The election to the advisory board of the school of Alfred Reeves, general manager of the American Motor Car Manufacturers' Association, has been pleasing to school's friends.

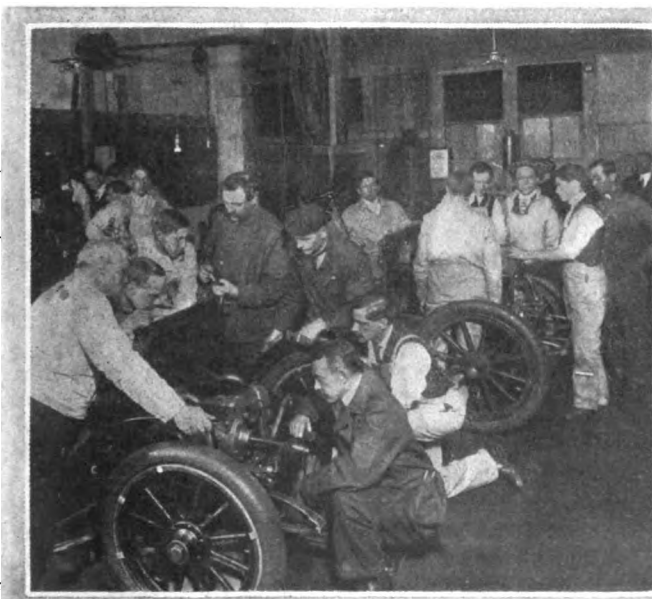

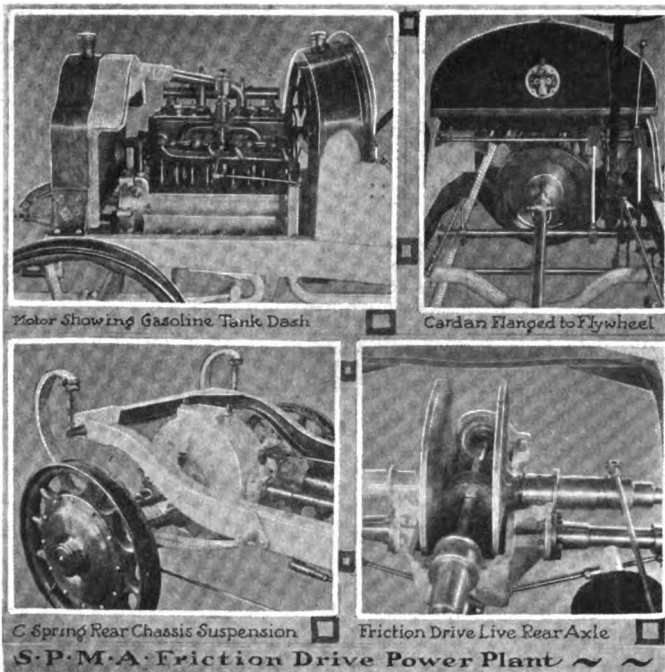

JUST OUT OF THE SHOPS ABROAD

By W. F. Bradley

Obviously such would be the case if provision were not made to avoid it. The weight of the car is carried on dead axles, the drive being through the live axles, the inner end of each one carrying the friction pulley and the outer end a pinion meshing with an internal gear contained within enclosed drums on the road wheels. With such a system it is a simple matter to interpose a pinion which will transform the reverse movement into a forward one with the same gearing as that of the opposite directly driven wheel.

And the differential? it will be asked. There is none. Theoretically, with the coil springs in proper condition, the two which should be driven at the same rate, and turning should be a difficult matter at speed. In practice, however, it is found that such is not the case, and although the inventor is not in a position to explain why it is so, the fact remains that there is sufficient slip on the plate connected up to the wheel on the inside of the curve to allow any turn to be made at high speed with the same ease as on a differential car. As a proof of its ability to pull under a load and on a heavy grade the car was taken to the top of Montmartre, where, on a 13-per-cent. grade that rarely sees any vehicle, several stops and starts were made with full complement of passengers on board. The car making the demonstration had been in constant use for twelve months. Some portion of the success of the car in this respect is undoubtedly due to the metals employed for the driving drum and the friction disks, the nature of which it is not desired to make public at present.

A reduction of weight is obviously one of the greatest advantages of this system, for at one end of the chassis is an ordinary engine, and at the other a rear axle weighing less than the same organ on the average shaft-driven car. Between the two is a propeller shaft and four steel ties, connecting up to the brakes and the springs. The total weight of the chassis, in complete condition is declared to be 1,210 pounds. The engine has a bore of 75 and a stroke of 110 millimeters, which gives a nominal rating of 14 horsepower. There has been no attempt to depart from standard lines of construction. A detail feature, however, is that petrol and oil tanks are on the forward face of the dashboard, the only thing in connection with the running of the engine that is to the rear of the dashboard being a single sightfeed and switch combined.

Suspension at the front is by semi-elliptics, but at the rear a special type of C spring is employed, the feature of which is that the tension can be altered with a few turns of a wrench in order to suit heavy or light bodies.

A NEW WATERPROOF MAGNETO COVER.

PARIS, March 10.—Little attention has been paid to the protection of the magnetic machine which supplies the indispensable spark to the cylinders of an automobile engine. The car bonnet is generally considered sufficient to keep off the worst enemy—wet; but the inadequacy of this is shown by the number of careful drivers who during the wet season cover the bonnet with an efficient waterproof. For marine work some protection is absolutely necessary, especially on racing craft, that necessarily ship a certain amount of water at high speeds, some of which finds its way into the engine room. More than one breakdown at Monaco has been due to no other cause whatever than the magneto receiving a drenching from flying spray.

This drawback has been entirely removed by the Bosch company by the recent production of a metal magneto cover, which is guaranteed to be absolutely waterproof. There is nothing

PARIS, March 3.—Friction-driven cars are not a French feature, there being but one firm, to our knowledge, having devoted attention to a type of vehicle so well known in the States. There is a newcomer in the field, however, who has produced a friction-driven car on new and original lines. Robert Dubois, the inventor of the S. P. M. A. automobile, a Parisian production, carries his classical four-cylinder engine forward under a bonnet, has a universal behind the flywheel, and proceeds direct to the rear axle by one long propeller shaft squared for its entire length. Mounted near the extremity of the shaft is a solid-steel drum which can be moved backward and forward in the same way as a sliding-gear set, and by exactly the same means, namely, a side lever and notched sector. The shaft passes completely through the rear axle housing, and is carried in large bearing at each end. Within the housing, and flanking the steel drum on the propeller shaft, are two friction plates bolted to the extremity of each of the two halves of the live axle. The necessary friction is obtained by means of coil springs contained within the axle casing, and contracted by an eccentric with connecting bars linking up to the clutch pedal. As will be readily seen, the operation of gear changing is, so far as the driver is concerned, the same as on nine-tenths of modern cars: depression of the clutch pedal, with the consequential separating of the two disks, and, by means of the side lever, the shifting of the driving drum along its shaft so that it will come in contact with a different horizontal diameter of the friction pulleys. The operation is the same as the one on cars with sliding gears with the advantage of not requiring any skill to cause the gears to mesh.

There are five forward speeds, one reverse, and of course a neutral position. This latter is obtained by bringing the driving drum in the horizontal line of the driving axles, which, being hollow at this point, leave nothing for the drum to work upon. Advantages claimed for the system are increased frictional surface, and, in consequence, decreased loss of power; also added simplicity by reason of a backward and forward movement of the driving pulley only, without any need for the pivoting shaft generally used on friction-driven cars. The friction plates are contained in an aluminum housing, which has the appearance of an unnecessarily large differential housing. It has inspection plates at the top and at the rear, and in addition the upper half of the housing can be removed in one unit by the withdrawal of a few bolts.

The objection will at once be raised that a drum mounted on the end of the propeller shaft and driving friction disks to left and right of it will turn the road wheels in opposite directions.

in common with this cover and the canvas and rubber ones which have been put on the market, which certainly protected the magneto from flying spray, but were powerless to prevent the penetration of water if poured on in a volume. It is a hammered brass case which is employed, with but a single welded seam. The case fits closely onto the magneto platform, which is provided with a raised waterproof beading, the only projections being the driving shaft at one end and the timing lever at the other. The encircling metal band securing the magneto to its platform is here on the outside of the case, and is secured in the usual way, as will be seen from the illustration.

A separate cover is provided for the contact plugs, this being bolted down to the main portion of the casing. The insulated leads all pass to the inside of the cover through one opening, which has also been made watertight. As oil holes are provided on the casing, it should never be necessary to dismount this latter except when it is required to entirely dismount the magneto. The firing of the cylinders can be verified by withdrawing the two bolts holding the cap in position, and without in any way interfering with the general body of the magneto. As this verification is far from being a daily occurrence, automobilists will not object to the removal of two bolts when it becomes necessary. The advantages of such a cover are so obvious that it is safe to predict its general use not only for open motor boats, but on all well-equipped cars.

FEATURES OF NEW AIR PROPELLER BRAKE.

PARIS, March 10.—Braking generally consists of the friction of a moving part on a fixed portion of the machinery, a system that has in its favor simplicity and ease of application, and general efficiency where the braking effort is intermittent. Where the retarding influence has to be continued without intermission for a long period, as often happens on good surface mountain roads, the friction sets up so much heat that the brake rapidly becomes inefficient. It was the development of automobiling on perfect European mountain roads, with grades of five to ten per cent. for several miles, that drew attention to water-cooled brakes, now so common on big cars, and the use of the engine as a retarder.

A device has just been produced by the Peugeot firm by which an aerial propeller carried under the car is made to retard the vehicle without any possibility of heating and consequent inefficiency through prolonged application. The propeller, composed of two flat steel blades, is mounted at the end of a vertical shaft, the housing of which is attached to one of the cross members of the frame to the rear of the engine. The housing is stiffened by stout rods passing from its base to another cross-frame member further in the rear. The Peugeot truck on which this system has been fitted has a final drive by double side chains, the gearset being combined with the differential on the countershaft. From the gearset a horizontal propeller shaft is carried forward and attacks the vertical propeller shaft by means of bevel gearing. Thus, on the vehicle being in motion, the

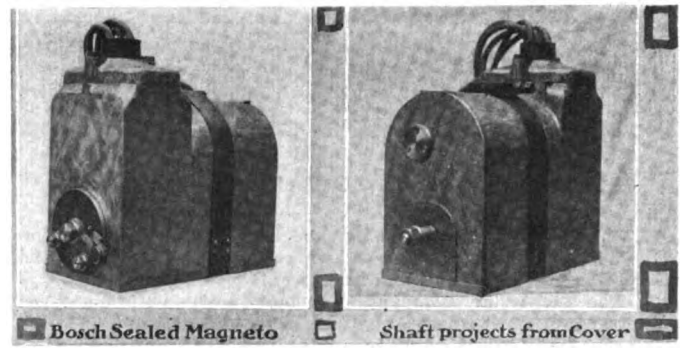

Bosch Sealed Magneto Shaft projects from Cover

aerial propeller is driven from the road wheels through the gearset and the propeller shaft. Provision is, of course, made for engaging or disengaging the propeller at will by means of a special lever on the dashboard. The gearset through which the car is driven is employed for driving the propeller, which, of course, profits by the different ratios, the driver being able to increase or decrease the speed of the propeller in relation to that of the vehicle by a simple change of gear. With the propeller running on its high gear a very powerful retarding influence is created as the result of the resistance of the air on the revolving blades.

A test of the system was recently made from the top of Mont Valerien, a hill overlooking Paris to the banks of the river Seine. The engine was stopped and the vehicle, a commercial truck with a load of 3 1-2 tons, was allowed to run down. The total distance of about two miles was covered at a speed of slightly less than three miles an hour, without the driver on any occasion touching his ordinary set of brakes. It is intended to continue the experiments and produce a model in which the propeller, instead of obtaining its resistance from the air, will revolve in a liquid, either water or glycerine. At present the brake is only applied to the company's heavy commercial vehicles, but will doubtless be fitted later to the larger touring cars. There is one other advantage to be taken into account in connection with brakes which receive their "purchase" by way of opposition in the air—i.e., it does not matter at all if the wheels lose their tractive ability, since the "fan" brakes would still be in a position to work, regardless of the tractive ability of the road wheels. Indeed, the car, fitted out in this fashion, could be controlled even if the wheels might slip, so that the conventional brakes would fail to work, due to loss of traction on a grade.

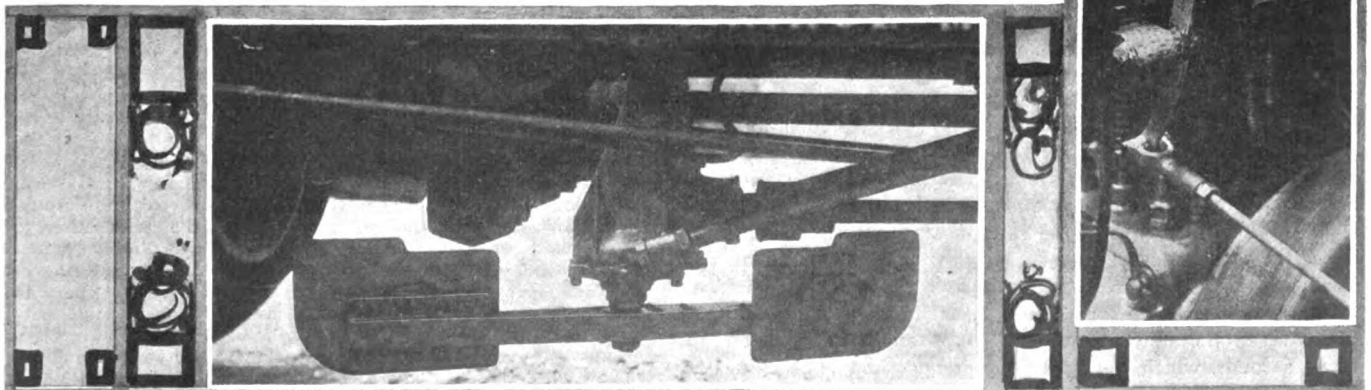

Peugeot Air Propeller Brakes Under Car Lever Control for Peugeot Brake

Letters Interesting and Instructive

SOME QUERIES AS TO VARIOUS RECORDS.

Editor THE AUTOMOBILE:

[1,790.]—Will you kindly answer the following questions for me:

1. What automobile, either steam or gasoline, has the fastest record for one, two, five, ten and twenty-five miles?
2. Has the White Company ever built a car with more than 30-horsepower until this year? If so, when and where?
3. Has the White steamer ever been defeated in any hill climb? If so, by what car and what was the time and distance?
4. What is the record of the Buick car for one, two and five miles?

Saranac Lake, N. Y.

FRED T. TREMBLE.

1. The following records for 1, 2, 5 and 10 miles were made in 1906, on the beach at Ormond, Florida: One mile—Marriott, Stanley steamer, 0:28 1-5; two miles—Demogeot, 200-horsepower Darracq, 0:58 2-5; five miles—Hemery, 200-horsepower Darracq, 2:34; ten miles—MacDonald, 90-horsepower Napier, 6:15. The record for 25 miles is that made on the Fresno track by Barney Oldfield, in a 60-horsepower Peerless, and is 23:38 3-5. The straightaway record for that distance is not listed.

2. The White Company has never built a stock model of more than 30-horsepower until this year.

3. Your question is too general and the field too great to allow of our giving an accurate answer.

4. It would probably be advisable to communicate with the manufacturers of this car to secure a satisfactory answer.

THE CARE OF AN AUTOMOBILE BODY.

Editor THE AUTOMOBILE:

[1,791.]—Please be good enough to answer in your "Letters Interesting and Instructive" the following: In the summer time the body of a car is oftentimes merely dusty, and a good dust-off would make it look as good as ever, if only you could pick the dust off clean, but a dry duster, although picking up the most, still spreads a certain amount, making it necessary to go all over again with another cloth to make a perfect job. Is there not some simple thing that I can dampen my cloth with that will pick the dust up clean, not hurt the finish, nor leave it greasy or sticky?

Portland, Ore.

J. D.

A highly finished body should never be wiped off dry, as it is impossible to do this and not scratch the polished surface. The best and quickest way is to turn a hose on it and then while still wet wipe off with a piece of chamois or a soft cloth. Waste might be used if of a selected grade, but the ordinary cheap kind must never be utilized, as it contains small sticks and other hard substances which will scratch the varnish. There are many cleaning substances now made, and by consulting the advertising pages of THE AUTOMOBILE you will doubtless find one that will suit you.

THE RECORD TIME ON A STRAIGHTAWAY.

Editor THE AUTOMOBILE:

[1,792.]—Kindly tell me in "Letters Interesting and Instructive" the greatest speed ever maintained by an automobile on a straightaway and also the name of the car.

Liberty, Ind.

L. E. HOWE.

The greatest speed ever attained by an automobile on a straightaway was made at Ormond Beach, Fla., on Jan. 26, 1906, by Fred Marriott, driving a Stanley steamer. On this occasion he did the mile in 28 1-5 seconds and the kilometer in 18 2-5 seconds. The former is at the rate of 127.6 miles per hour, and the latter 121.6 miles per hour. At this same place and on the same day Louis Chevrolet, driving a 200-horsepower Darracq, made the fastest times for a gasoline machine on a straightaway. He covered the mile in 30 3-5 seconds and the kilometer in 19 2-5 seconds, which is 117.6 miles per hour and 115.3 miles per hour, respectively. Four days later, driving the same car, Demogeot drove two miles in 58 2-5, at the rate of 123.3 m.p.h.

ENGINE PERSISTS IN OVERHEATING.

Editor THE AUTOMOBILE:

[1,793.]—Having observed in your issue of February 4 a letter signed P. O. Peterson, in which he complains of his air-cooled car at times running hot, and your reply to same, would say I ran an air-cooled car of popular make (1906 model) for two years with fair satisfaction, sufficient to warrant the purchase of a 1908 model of same make last Summer. This car has proved unsatisfactory as it has been impossible to run it on even moderately warm days without constant overheating of the engine. As I ran an air-cooled car successfully for two years, I feel certain this is no case of retarded spark, lack of adequate supply of a suitable grade of lubricating oil, or of too rich a mixture, and if Mr. Peterson's car is of the same model as mine, probably nothing short of a more powerful engine capable of carrying a fan will suffice to keep his motor cool on warm days.

Chelsea, Mass.

DR. C. N. CUTLER.

Your engine is powerful enough to run a fan, as very little power is consumed in this manner, but that is not your trouble. It appears from the symptoms that your valves may not be correctly timed so as to exhaust at the proper time, for instance. Again, there is the bare possibility that you have an unusually stiff set of piston rings, which are absorbing lots of power. After you have fitted a fan, if it does not relieve the situation, you might follow up these suggestions. If you had not previously driven an air-cooler, we would make the suggestion that the makers of these recommend a hot running condition, the Franklin Company, for instance, recommending 350 degrees.

BEARING METAL IN AUTOMOBILE MOTORS.

Editor THE AUTOMOBILE:

[1,794.]—Can you tell me what kind of metal is used in the large ends of the connecting rod bearings in so many automobile engines? I have melted some of the scrap metal and it melts in a ladle like babbitt, but at somewhat higher heat and after poured requires longer to chill and harden than babbitt metal does. If you can tell me what this metal is and where I can obtain it, it will be appreciated.

East McKeesport, Pa.

J. D. F.

In many cases the metal used is of the copper-tin alloy in which the tin content is 90 per cent. This metal is quite hard, melts at a high temperature, relatively, and requires some skill in the fabricating process. In its use the results are not always good for the reason that the "teeming" is done at too low a temperature. In pouring this metal in the process of fashioning bearings it is necessary to raise the metal to a red heat. It should be covered with charcoal to keep it from oxidizing.

In some cases it is the practice to take a good grade of babbitt, such as can be had on the open market, and after melting the same in a pot, it is loaded with tin until a specimen, after it solidifies, will fracture readily, showing a cold-short condition. Very good results have been realized in this way, although it is true that the copper-tin metal as previously discussed has the advantage of being the more certain.

A GOOD CHANCE FOR GENIUS TO CLIMB.

Editor THE AUTOMOBILE:

[1,795.]—I would like to be informed through the columns of "The Automobile," or otherwise, whether there is any signal code in use among the best autolists in the country, whereby one automobile driver can inform another by the use of his horn whether he is going to stop, or start, or turn to the right or to the left, etc. Also please tell me what is the proper use of the horn in saluting other machines if you chance to meet one on the road. If there is no signal code for the purposes that I have mentioned, could not the one used by steamboats on the ocean be used for this purpose, with perhaps a few alterations, and if so, will you have the kindness to tell me what that is. There does not seem to be any rule for the use of the horn around here; they all toot away one, two or three blasts. That seems to mean, if they mean anything, look out or get

out, or something of that kind. I am going ahead, or going to stop, or going to turn to the right or to the left, or turn around, or do any other old thing that comes into my head to do. I am satisfied from my own experience that the knowledge and use of a signal code would prevent many accidents and do away with much inconvenience, not only to pedestrians, but to horse drivers as well, who would soon learn the meaning of these signals if they were in common use. For instance, I am driving down a road that crosses another road and I want to turn into the left hand road at the point of the crossing. I, of course, slow up in order to make the turn safely, when another machine that has been following me rather closely, but unobserved by me, seeing me slow up, understands it to mean that I give them an invitation to pass me and they make a dash to do so, and before they find out their mistake a collision results.

Columbus, Ga.

There are no very well understood signals in use; it would be a good chance for you to exercise your talents. The pages of THE AUTOMOBILE will be open to your suggestions.

ELECTRICAL INVENTION SEEMS IMPOSSIBLE.

Editor THE AUTOMOBILE:

[1,796.]—Being much interested in an article entitled "Here's Another Wonderful Invention," on page 322 of your issue of February 18, I wrote the firm named J. W. York & Son, and was greatly surprised to receive in return my letter of inquiry (which I enclose) upon which was written, "we know nothing in regard to the above."

The invention is so utterly opposed to modern knowledge of the generation of electric currents that it has awakened a great deal of interest, and the fact alone of its appearing in your columns gave it greater prominence, and stamped it with greater reliability than would have been the case had it appeared in some other journals more inclined to the sensational. Your valued paper would confer a favor upon its readers if it would give the correct names of the parties directly interested, and any further information it can secure in relation to the matter.

New York City.

A. D. WELCH.

One more look at the item as it appeared in THE AUTOMOBILE will disclose to you the fact that it was not regarded as likely to be true. The item came in as "news" and was given space more by way of showing odd slants of the human mind than anything else.

MAXIM'S SILENCER IS A MUFFLER.

Editor THE AUTOMOBILE:

[1,797.]—Maxim's noiseless gun is exciting much interest from a military standpoint.

1. Do you believe this principle could be applied as a muffler of an automobile?
2. If so, would it eliminate back pressure, or would it cause back pressure?
3. Would the possibility of muffler explosions be eliminated?

Tiffin, O.

L. O. R.

The principle of the "silencer" is that represented in the muffler as used in automobile work. Back-pressure will follow if the principle is not rightly applied. "Muffler shots" are due to missing in the firing of the charge in one or more of the cylinders. If timing is right, and if the ignition is adequate, provided the mixture is homogenous, and in the right proportion of fuel to air, there should be no trouble of this sort.

GREATEST NUMBER OF AUTOMOBILES.

Editor THE AUTOMOBILE:

[1,798.]—Will you tell me, to settle an argument, what city or town has the greatest percentage of automobiles relative to its population and what that percentage is? Thanking you for the trouble,

Tekonsha, Mich.

C. Q. D.

The information necessary to answer your question is not available; in fact, we have never seen or heard of anything of the sort. We can, however, give you a few of the places which have claimed this honor. These are: Waukesha, Wis., one in 220; Decatur, Ill., 170 machines for 30,000 people, which is one in 176; Hart, Mich., 35 for 1,600, that is one in 45, and Tahoka, Tex., with 14 among 500 people. This latter is one automobile for every 35.6 population. London, the largest city in the world, with over 4,500,000 population, has the tremendous total of 40,000 cars, bringing the average there up to one for each 112 people.

MIXED BEVERAGES FOR THE MOTOR.

Editor THE AUTOMOBILE:

[1,799.]—Do you recommend the practice of mixing lubricating oil with gasoline for the purpose of assisting in lubrication of cylinders, pistons, valves, etc., in conjunction with the splash system; and if so, in what proportions should the oil and gasoline be mixed? Does this practice not interfere with carburetion?

Philadelphia, Pa.

J. R. K.

The views of a "pioneer" will be found in this week's letters in relation to this matter. Perhaps others will come forward with a quota rather with the expectation that the scheme will be put on a stable footing.

ABSORPTION DYNAMOMETERS IN DEMAND.

Editor THE AUTOMOBILE:

[1,800.]—We will appreciate it if you will put us in touch with the makers of water absorption dynamometers.

Hope Valley, R. I.

N. & L. M. CO.

Several inquiries of a like character would seem to indicate that there is quite some activity in this line. Makers of this class of dynamometers can have information forwarded to the interested parties by addressing the same to this letter number, care THE AUTOMOBILE.

SOME REFLECTIONS OF A PIONEER.

Editor THE AUTOMOBILE:

[1,801.]—Your reply to Mr. Hawkins in the February 11th issue regarding the use of gasoline and lubricating oil mixed, seems to me as likely to do injustice to a splendid method of lubrication.

While, as you state, a mixture of gasoline with oil is not considered a lubricant, it is a fact that the gasoline is a splendid vehicle for carrying the oil to the place where needed in the proper quantity and at the proper rate. Mr. Hawkins has used it temporarily and regards it as a makeshift, but many people are using it regularly. Holsman oils his latest design of four-cycle engine that way, which he can well do, because, in this case, he draws the mixture into the crank case, and so brings the oil into contact with the parts to be oiled, just as is done in the Duryea buggyaut two-cycle engine, and in many others of this type. The cycle of the engine does make a difference, for in the usual form of four-cycle engine the mixture does not get into the crank case, and so will not oil the parts there.

An amount of oil in the proportion of one to twenty, or, even one to forty, is mixed with the gasoline, and dissolves fully therein, so that the mixture flows through chamolis and through the carburetor, just as does gasoline alone. The gasoline evaporates and leaves the oil floating as an exceedingly fine mist. This deposits on all the parts that it comes in contact with and lubricates just as well as if deposited by some other means. Such of it as does not deposit (which I believe to be very little) goes into the cylinders and burns in the intense heat of the explosion. The deposit on the spark plug and heads of the cylinders seems to be less by this method of oiling than by the more common methods. The quantity of oil required is not excessive. In fact, I consider it less than most methods require. If the engine backfires into the case, the mist of oil is burned and the piston fails to be oiled. This is a fault, but the feeding of oil when wanted, and in quantities proportionate to the work done, is such a good feature that we can afford to fight the one fault by screening the transfer passage so the engine will not backfire.

Everybody admits the advantage of simplicity and the substitution of this simple method for the usual complicated positive oilers, with better results, is certainly a move in the right direction, and not to be considered a "makeshift method." It must be remembered that the gasoline does not do the lubricating by this method any more than it does when the explosive charge is admitted into the crankcase with some other method of feeding. In a number of instances the oil is dropped into the supply pipe, but this renders it necessary to bother with the adjustment of the oiler, and is not so good a method. A drip oiler feeds in proportion to the time, and does not take account of the revolutions or of the work done. A pump oiler feeds in proportion to the number of revolutions, but the solution method feeds in proportion to the power produced, whether this is in hard pulling at slow speeds with full throttle, or in light work, but with engine racing. It does away with worries about filling the oiler, for one mixes the oil with the gasoline when his supply tank at the garage is filled, and thereafter the filling of the fuel tank of the vehicle takes care of the oiling. It may interest users of the four-cycle engine to know that a little oil with the gasoline will often improve the running of their engines. It lubricates the cylinder walls at the top of the stroke where they are too often dry, and so adds to smooth running, noiselessness, and increases power.

Reading, Pa.

CHAS. E. DURYEA.

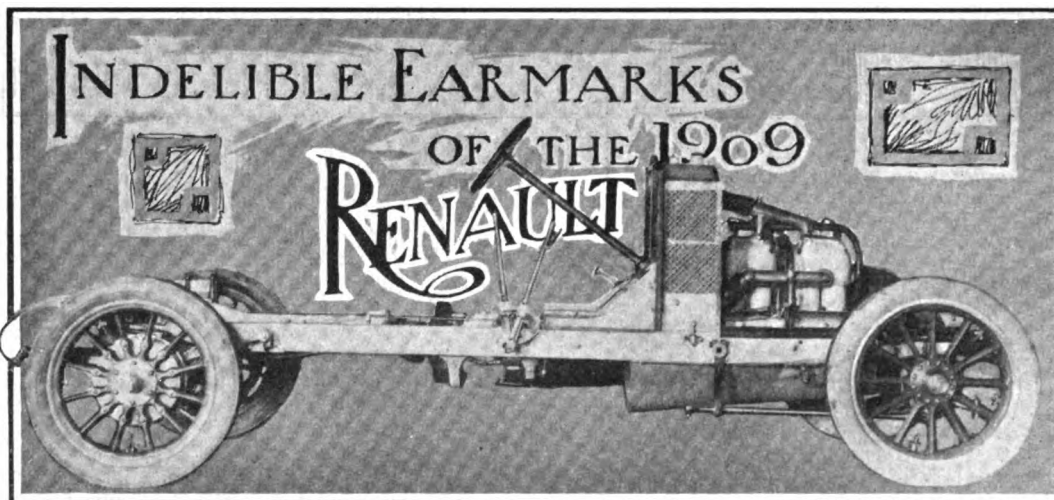

Figure 1 — Chassis Thirty Special

SOME years ago when the utility of the automobile was very much in question, and when the foreign makers of cars made bold to proclaim the qualities of "continental" handiwork, Renault Frères, cantered across, as an early bird, in quest of the worm, bringing along the "Renault"; then, as now, a car to be picked out of a parkful. It is just

this detail which has done much to make the Renault car popular, among the buyers of the better class of automobiles. The car has the Renault earmarks, and they are indelible in stability and style of design.

Then, as an importer of automobiles the Renault Frères selling Branch, located at 1776 Broadway, New York City, considered well the American methods, which are so necessary to continued success in this country, and American roads, which are but slightly improved in many places, hence demanding the utmost rigidity of the component parts of cars, coupled with a flexibility of the units, such as can only follow if the design is keen, and if the material is superior.

While it is true that the Renault holds to a certain characteristic design, it is also true that the car has kept pace with time, as experience showed the way to superior materials, and more lucid details in point of design. The Renault, for 1909, embodies all the features, free from frills, such as can be looked upon as fitting in the culmination of the automobile, in view of half a decade of activity of the most strenuous order.

All Alike in the Main Characteristics.—Since all Renault models, of which there are some 17, are as like as peas in a pod, in all the main essentials, it is just possible that the discussion here will be the more comprehensive if it is somewhat restrained, and with this end in view reference may be had to the chassis, Fig. 1, showing to good advantage the general arrangement of the cars, in which the motor is of the four-cylinder type, with vertical cylinders, and the motor is located in the front of the chassis. The power is transmitted by means of a cone clutch, leather faced, to a semi-progressive transmission gearset, with three and four speeds for-

ward, depending upon the model, not counting the reverse. From the gearset the power is transmitted through a propeller shaft to the live rear axle, thence to the rear road wheels.

Likewise, the chassis, in all the models, holds to a common Renault practice, taking into account frames of the channel section of a "super" grade of steel, and with dimensions of the section, such as will afford the requisite degree of rigidity. The frame is of the "drop" type, on certain models, which lowers the center of gravity and makes the side entrance easy, and the spring suspension is with 3-4 elliptic rear members of nice design, while the front springs are half-elliptic, designed for level platform work despite road inequalities of moment.

In this spring suspension account was taken of the constant load in front and the variable nature of the load in the rear, hence the rear springs are free, thus accounting for well defined flexibility in the performance of the springs. In order, however, to assure just the performance which is characteristic of Renault cars on the road, shock absorbers, of a most effective design, and of superior materials, are provided in the manner as shown in Fig. 3, and a glance at the details of design will disclose the perfect universal action of the devices used.

From the springs through the axles to the road wheels, the power of the motor is rendered potent, and by way of axles to sustain in service, the front is of the I section, of great strength, and with integral spring perches. The live rear axle is of tubular form, in which the housing over the bevel drive and the compensating gear is of great strength, in view of its shape, which does not prevent it from being light, and it is in this way capable of doing work without introducing complication, if the speed of the car is high.

Wheels, Wheelbase and Control Systems.—The rear road wheels are in driving relation with the differential shafts, which in turn take their power from the compensating gears, and the road wheels are so attached that none of the bending moments are transmitted through the shafts; the tube, which serves for the shaft housing, is designed to take all such strains. The wheels are of

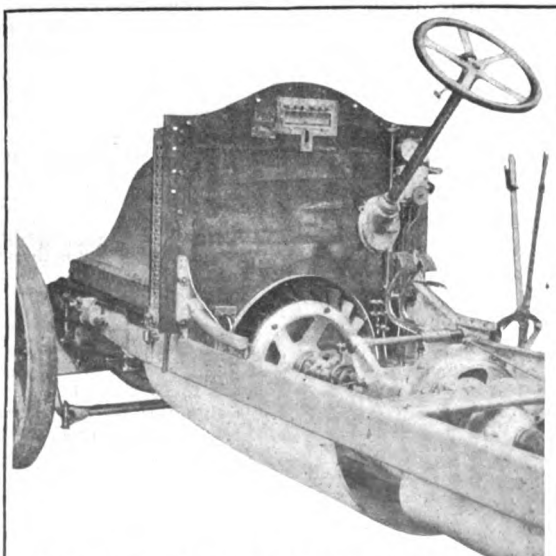

Figure 2 - Thirty - Thirty - Five - - -
Air Propeller on Periphery of Fly Wheel



the most approved design in all respects, and the tires adopted on the several models take into account the load and speed to an adequate degree.

Motion is controlled by means of two very powerful brakes, acting on the back wheel hubs and on the differential. These brakes are entirely metallic, and hold equally well backward and forward. The brake acting on the wheel hubs consists of two drums made in one for the wheels, and in the interior of which are cast-iron segments which expand internally against the drums. The expansion of these brake liners against the drums is obtained by rotation of a finger-shaped cam.

These wheel brakes are controlled by a hand-lever placed at the side of the change speed lever at the right hand of the driver. This lever moves on a notched sector, allowing one to leave the brake on or off, whichever position may be desired.

The brake level is joined up to that of the cam, which expands the segments by a steel rod. The adjustment of the brakes is very easy. The brake working through the differential is worked by a pedal. This brake is operated in the same manner as those on the back wheels—expanding cast-steel segments—and is very gradual in its action and easily operated.

Renault chasses are fitted with three push pedals; that on the left hand works the clutch, the middle one the brake, or clutch and brake if desired; the third, on the right, is the accelerator pedal.

The steering is irreversible, and is of the helicoidal type, which is effected by an endless screw. It is very easy, and does not in the least tire the driver, the road shocks not being transferred to him. The movement of the steering wheel is transversal to the wheels by means of a revolving arm fitted on a sector and helicoidal grooved shaft, secured by a ball socket jointed rod to the levers working the wheels.

The wheels are mounted on the journals, which are thus jointed in their sockets to the front axle. In addition, on to the journals are fitted levers, holding between them a connecting rod, by means of which the two wheels are kept parallel one with the other. When the levers are fitted to the journals, there are large tapered squares. This arrangement gives the greatest possible rigidity by entirely avoiding all the shock or rattling of joints and escaping all fear of breakage.

Self-starting Device Makes for Utility.—In special cases the Renault cars, notably the 20, 30, 35, and 50-horsepower models, are fitted with self-starters, of a type in which compressed air is distributed to the cylinders at the propitious time. The same compressed air can be used for the purpose of inflating the tires. This self-starter idea is very reliable, and it is of particular advantage in the cases in which the owner prefers to run his own car betimes. Then it is the more sure way of starting, which is something to take into account these days when gasoline is not up to the high standard of former times, thus making "cold" starting something to ponder over.

A Sweet Running Motor Furnishes Power.—Renault silence has ever been a mystery, due to the complete silence of the machinery, rather than to the musical notes, as distinguished from discords, which are usually regarded as obtaining in what is called noiseless performance. The motor in Renault cars is small for the power, belonging to the class in which cylinders are cast in pairs, with the mechanically operated exhaust and inlet valves on the same side, L fashion.

The single camshaft is with the cams cut from the solid, and

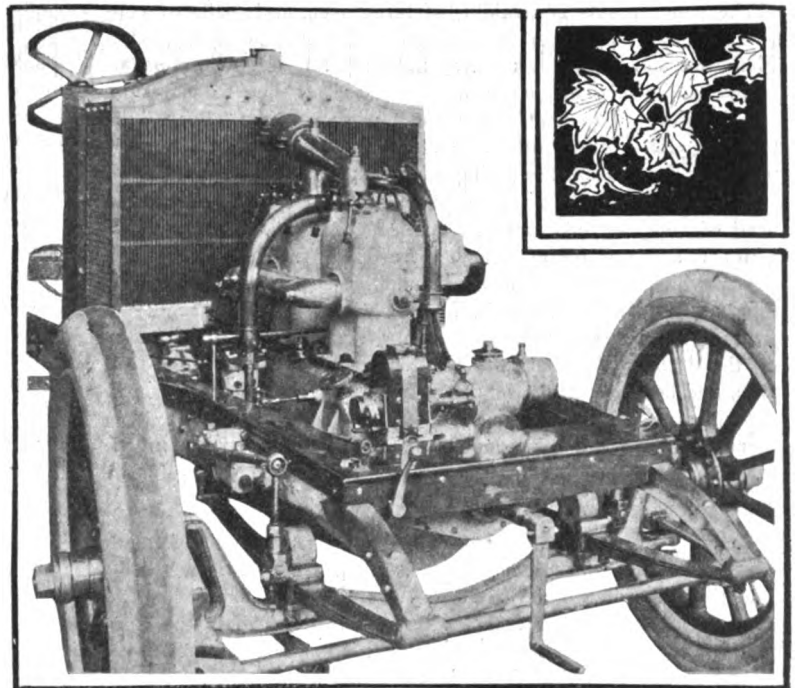

Figure III—Thirty—Special—Motor, Magneto, and Thermo-Syphon Cooling

the material is that which will take great hardness without brittleness, which is but a way for saying that the material used is highly kinetic. Likewise, the crankshaft is of a suitable grade of material, taking into account the arduousness of the service, and the desirability of continuity, due to the cost and inconvenience which must follow if crankshafts fail in service.

Ignition is by means of Simms-Bosch high-tension magneto, in which the secondary circuit connects up to Renault spark plugs, which are noted for long life and the entire absence of "sooting" tendencies. The magneto is shown in Fig. 3 and is driven by a helicoidal pinion, from the camshaft, with all parts enclosed.

Cooling is effected by means of the thermo-syphon system, in which the method reaches a high state of efficiency due to the nice manner in which the principle is carried out. The radiator is shown in Fig. 3, just over the flywheel of the motor, and as will be observed the air-propeller is of the type in which the "vaness" are on the periphery of the flywheel, just where they will do the most good. With a superabundance of air to wipe the heat off of the cooler surfaces, coupled with a static head of water, due to the elevated position of the radiator, the success which has attended the Renault system of cooling is easily understood, especially if account is taken of the commodious piping system used and the manner of its application.

Figure IV. Thirty Special—Shaft-Drive and Level Platform Suspension

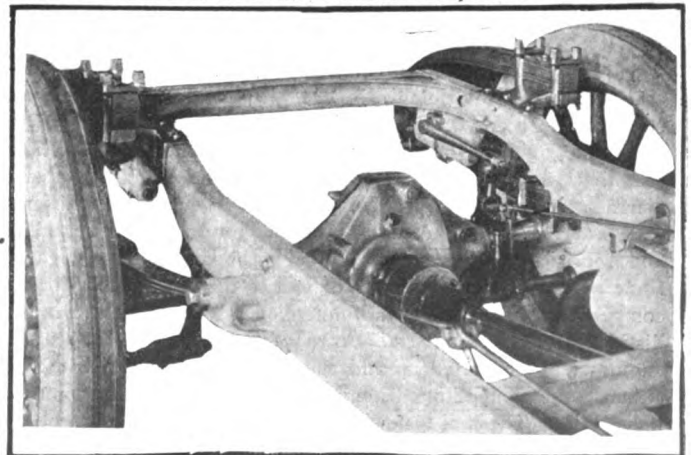

The water piping is straight, of large area, and made of copper, which is noted for its strength and utility in this service. Flexibility is assured by the way in which the design is consummated, and leaks, as the result of service, or due to vibration, are avoided. The neat appearance of the piping adds to the pleasing effect of the machinery, and should repairs have to be made for any reason the piping can be dismantled readily.

The more efficient a power plant becomes the greater is the need of adequate lubrication. While definite and profuse lubrication is a factor for efficiency, yet even so, the very increase in power which naturally follows, demands the greatest certainty of lubrication. In the Renault, for the cylinders, oil is regulated and fed by means of an eccentric on a rod, within the lubricator on the dash of the chassis. The lubricator is of the sight feed type, and besides caring for the cylinders in the manner as above described, crankcase lubrication is assured and regulated by means of a special arrangement of transverse partition in the lower half of the crankcase. The connecting rods are oiled by splash, but provision is made to assure uniformity.

Renault Commercial Cars.—While it is true that the Renault cars are in great prominence in pleasure pursuits, it is not to be said that they are to the exclusion of the same make of cars in commercial work. The company is heavily engaged in the commercial zone of activity, and there are four distinct models of Renault cars available for this class of work. These models cover about everything required from a light delivery wagon to trucks for the heaviest service in important work.

The smallest car is designed to carry 1,200 pounds burden, and the motor is rated at 9-12 horsepower. This is the light delivery wagon, in which the motor is of the two-cylinder type, and the chassis is intentionally designed to place in the hands of men of almost no skill at all. The 10-14 horsepower car is the next size, and this car is rated to carry a load of 1,800 pounds. This is also a car in which the motor is of the two-cylinder type. For heavy work the 14-20 is available, in which the motor is of the four-cylinder type, and the normal capacity of the car is 3,400 pounds burden. This chassis is probably one of the finest propositions possible to devise for the purpose, in which all the parts are especially devised in view of the arduousness of the service, taking into account the lack of efficient care which must be the lot of trucks in the hands of men who are not mechanics and whose early training may be such that they never will be able to wield a monkey-wrench with safety to any piece of mechanism below the ruggedness which will put up with abuse to a vast extent and in divers uncalled for ways.

In addition to the chassis which will do for delivery and truck work, the company has in hand a 20-24-horsepower, four-cylinder "autobus" which is rated to sustain under a load of four tons. This is the chassis used by the New York *Herald* in its most exacting work and it is claimed that the *Herald* depends upon the car to a vast extent. Of course, the commercial cars of the Renault are much like the pleasure vehicles in the main; that is to say, there is the same fine material, the details of design, and the Renault ear-marks with the brand of success burned in them by the fire of skill and experience.

ENTRIES FOR MONACO BOAT RACES BREAK ALL RECORDS

PARIS, March 10.—A total of 97 boats, consisting of 66 cruisers and 21 racers are now entered for the Monaco carnival, March 31 to April 11. The number is a record and exceeds that of last year by 12. For the first time the limited bore regulations, as applied to racing automobiles, will be in vogue for the motor boats, the weight of the hull being limited according to the bore of the engine, and the maximum bore being fixed at 155 millimeters for a four-cylinder engine, as in last year's road races. Many of the boat engines indeed will be those which were used on racing cars last year.

The center of interest lies in the International Cup, which will be disputed by boats of unlimited power for a distance of about 60 miles. As under the Gordon Bennett rules, only three boats per nation can be entered, the nations regularly engaged being America, with Dixie and Standard; France, with Panhard, Levassor and Alla-Va, driven by Brasier engines, unless either of these unlimited boats is beaten in the eliminations by some of

the fast 155-millimeter bore craft; England, with Wolseley, Siddeley and a privately owned boat which has not yet been named; Germany, with the Prinz Heinrich, engined by Benz, and the Lizelotte, with Mercedes Grand Prix engine; Italy will have one boat only, the Nibbio, carrying a Fiat 155-millimeter engine.

Other interesting speed tests will be the championship of the sea, a 220 kilometers scratch event for all boats having qualified in their class races, and the mile and kilometer races. In addition to the two American racers, Dixie and Standard, the Western continent will have a third champion in a hydroplane boat built by W. H. Fauber and carrying a Motobloc engine of 155 millimeters bore. This craft, part hydroplane, part boat, will run in the 155-millimeter racing craft, the Championship of the Sea, the mile and kilometer trials, and in the International Cup as a French boat (engines only being considered) if she qualifies in the elimination.

PARIS TO HAVE A NOVEL CHAUFFEURS' COMPETITION

PARIS, March 10.—Every trained autoist knows the sound of his own car sufficiently to distinguish it from a crowd of others, although invisible to the eye. But how many professional chauffeurs can correctly name fifteen different cars merely from the sound of their open exhaust? A Parisian journal believes that there are sufficient experts in the music of the exhaust to warrant the holding of a competition. About fifteen different cars, varying from the modest one-lunger to the powerful six and four-cylinder monster, will be gathered in a large garage some Sunday morning toward the end of the present month. The competitors will be in an adjoining room, where they can hear distinctly, but see nothing. As a preliminary test each of the engines will be started up and run for a few minutes with open exhaust, the competitors listening attentively and taking notes if they desire. The real test will then commence. Each engine will

be run for two or three minutes with open exhausts, the competitors to write down on a slip of paper the name of the engine they believe to be at work. The competitor having the largest number of correct replies will be the winner.

The event will doubtless be keenly contested, but will of necessity be confined entirely to professional chauffeurs and repair men. The average automobilist, who may be an expert at distinguishing the make of a car from its noise on the road, has little opportunity of becoming familiar with the roar of its engine alone. Even the exhaust cut out would be more familiar, for the length of piping before the cut out is reached has a considerable influence on the sound, and this is more frequently heard than the directly open exhaust. A sound test of cars under ordinary road conditions would have been equally interesting and would have appealed to the average automobilist.

NATURAL ADVANTAGES OF GAS IN AUTOMOBILES

HOMOGENEITY is a property which is difficult of attainment in mixtures of gasoline and air out of a carbureter of the conventional float-feed type unless the gasoline is volatile in the extreme, and this is not likely to be true if the gasoline is a mechanical mixture of a number of the fractional distillates due to the range of temperature, in the distilling process, which is said to obtain at the present time. It is claimed that the present practice in the production of gasoline is to use all the fractions between 50 and 150 deg. C.

To a very considerable extent the trouble is aborted by pre-heating the mixture on its way to the combustion chamber or if the air is heated sufficiently before it enters the carbureter. The time was when this process worked very well, indeed, but it is becoming more difficult every day to so heat the air, or the mixture, that globules of gasoline will not enter the cylinders and coke up. The amount of heat required for the purpose is vastly more than is generally well understood, and unless enough heat is supplied, the results will be with a crop of carbon in the combustion chamber.

Any process that will manufacture a homogeneous gas to the entire exclusion of liquid gasoline will serve the purpose, and preheating the mixture is a step in the right direction. The time was when autoists hoped that illuminating gas could be put under compression and that enough of it could be carried in a tank of reasonable size to accomplish the work. It is generally understood that illuminating gas will serve well for the purpose, but it is not possible to store enough of the gas to enable a car to travel far without having to replenish the tank.

Recent Improvements Make Way for the Gas Tank.—That the gas-tank idea clings to the automobile with a tenacity which augurs for inherent utility will be seen in the illustrations here offered. Fig. 3 shows a gas tank and the manner in which it is connected up to a six-cylinder car in which it will be noticed that the carbureter is entirely dispensed with. The entire absence of a carbureter is the best indication of the change over from liquid gasoline to gas, and it is the manufacture of this gas, as it is needed for the motor, that will be given attention at this time.

The gas producer consists essentially of a copper tank, or container, about the size of the conventional gasoline tank, located in any convenient place, as under the seat of the driver, which tank is filled with laminæ of wood-pulp sheets, superimposed. Each sheet is about 1-4 inch thick, of rectangular shape, and drilled full of holes, each about 1-4 inch in diameter, and spaced about 1 1-2 inches apart. The sheets of wood pulp are separated from each other about the thickness of one of the laminæ, and the nests of sheets are in two sections.

Between the two sections of the nests of wood-pulp sheets the space is taken up by a heater for the air as it enters on its way to the gasoline-saturated wood-pulp sheets. The heater is made up of a coil of piping in a manner not unlike the radiators used in steam-heating work. The exhaust gases from the motor serves to convey the heat to the radiator. The air enters at the top, passes through the heater coil to the under side of the nests of wood-pulp boards. The admission of air through a check valve, and the suction of the motor, furnishes the required difference in air pressure, so that the air is sucked in.

Since the air cannot turn back through the check valve, it must pass up through the nest of pulp boards, and the holes in the boards furnish the openings, as well as a large surface. Fig.

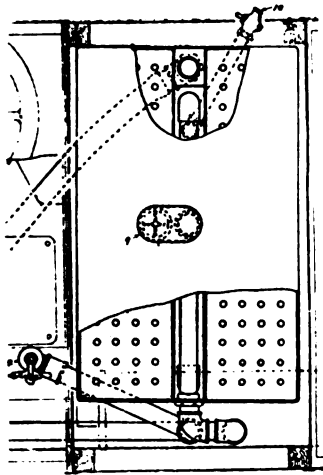

Fig. 1.—Generator with top cut away to show holes in pulp filling.

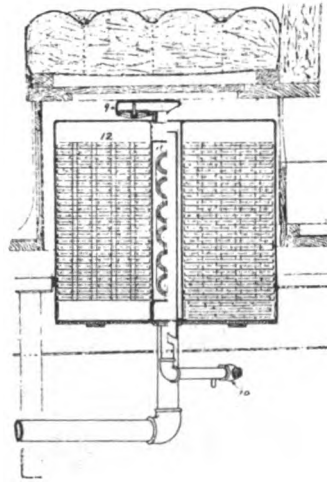

Fig. 2.—Section showing nest of boards with spaces between.

Hexane, the formula of which is C_6H_{14} , is admitted to be the superior fraction of all the distillates from the crude oil used in the production of gasoline, and while the distillers would like to have credit for using nothing but the best for the purpose, the fact remains that gasoline of the present time can scarcely be classed as hexane, nor does it seem to hold any more hexane than the amount required to assist in cranking a cold motor, it being the case that a motor could not be started "cold" in the absence of some of the more volatile of the hydrocarbons.

Carbon in Cylinders Due to Gasoline Used.—Lubricating oil is charged with the crime of depositing carbon on the surfaces of the combustion chamber, and this carbon in turn causes "bucking" and preignition. It probably is true that inferior cylinder lubricating oil will deposit carbon, to some extent, but the main trouble is from the gasoline which will not vaporize until it is allowed to contact with the hot cylinder walls, and this process of reducing the gasoline to vapor is bound to lead to a carbon deposit for the same reason that wood is "coked" if it is heated to a temperature of about 650 deg. C., provided the amount of air present is less than that which would cause complete combustion.

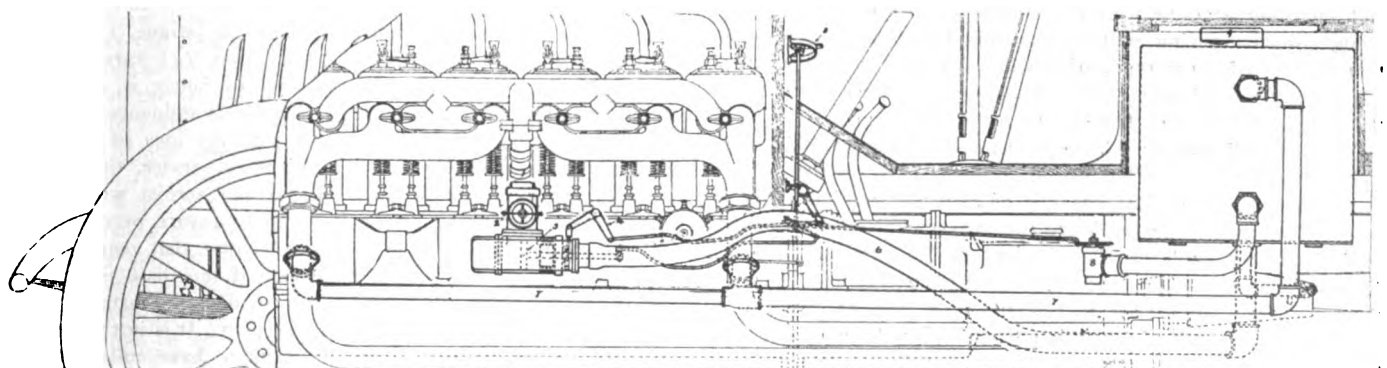

Fig. 3.—Diagrammatic scheme showing the manner in which the generator is used and piping connecting to motor.

t shows the top of the container cut away, exposing the top layer of pulp boards to view, and the small holes will be noticed. The same figure shows the heater in the middle of the container, and Fig. 2 is offered to more clearly bring out the construction features of the system.

The cross-section of the container, as shown in Fig. 2, indicates that there is but very little free space in the same, and in the process, gasoline is spilled into the top of the tank in sufficient quantity to saturate the wood-pulp mass. The amount of gasoline required is about 60 per cent. of the amount which the tank would hold if the wood-pulp system were not present. Excess gasoline is not required, and in the process the heated air as it passes up through the holes in the pulp boards wipes the vapor of gasoline off of the surfaces, and in view of the heated condition of the air, it is in fettle to become enriched, even if the gasoline is of a poor quality.

Through the good office of a valve devised for the purpose the rich mixture is diluted after it leaves the tank, and the device is so ingenious that the motor is enabled to draw just the quality of mixture of a homogeneous gas as will best serve the purpose, while the motorist is enabled to alter the proportions at will, taking into account the road conditions, atmospheric influences, and the properties of the gasoline, as the supply reduces in the tank, leaving the heavier residuum.

There can be no explosion of the gas in the tank for the reason that the same is not sufficiently diluted with air to render it explosive. If all the gasoline is used up, in so far as it can be, what is left can be ignited without danger of any sort for the reason that the same will not be highly explosive, and the amount that can hide in the free space is not sufficient to do any damage at all. As will be seen, then, there is no danger to be attributed to the presence of gasoline in a car, provided it is concealed in wood pulp in the manner in which these generators are built.

From the economy point of view it seems almost unnecessary to more than point out that what is wanted in any case is a homogeneous mixture, such as is made in this system, and since the system precludes the chance of dribbling liquid gasoline along the roadway, taking into account the homogeneity of the same, the radius of travel of a car is about the same as if the tank were filled with gasoline of the conventional sort without the packing of wood pulp. In the meantime the motor will deliver more power with the better mixture, and carbon formations in the cylinders are aborted. The International Generator Company, at 244-250 West Forty-ninth street, New York City, is very active in the manufacture of this system, and the demand is quite in keeping with the advantages following its use.

CHAIN OF ELECTRIC STATIONS PLANNED.

To further the development of the use of electric automobiles, a large gathering of those interested was held recently at the Boston Athletic Association, the manufacturers, the agents, the electric lighting companies and the battery makers being represented, and as a result steps are being taken to thoroughly canvass the whole electric vehicle situation. Numerous garages and charging stations will be located at advantageous points along popular touring routes, according to a well-laid plan, so that owners of these types of machines may tour without fear of running out of power, even though the battery capacity of the machines may vary from 40 to 70 miles or more.

A scheme of battery relay stations was discussed and found to be feasible if concerted action is taken, and regular garage men will be instructed in the use of charging outfits. Among those active in the new work are the Waverly Electric Company, of Indianapolis, and the Electric Storage Battery Company, of Philadelphia, and other concerns are realizing the importance of their policies. The new movement, if it can be made successful, will be one of great importance, for there is a recognized field for electric machines, and a campaign looking to the more general adoption of them is a commendable one.

NEW DETACHABLE LINK CHAIN IS NOVEL.

Fame and Diamond chains entered into a lasting partnership and linked the automobile to success, despite the hamperings of road inequalities, lack of designing experience and the fearful strains that come. In the earlier days when it was extremely difficult to get materials so good that dependance could be put in them under the conditions demanded in detachable work, it was fitting to bow to the dictates of prudence.

Time wrought changes in materials and in methods of manufacture, as well as in the treatment of the finer grades of steel, with the result that Diamond chains have long been made of steel, the nature of which augurs for success under the most severe conditions of service, and the day of the "detachable" made bold to proclaim itself.

It is not because chains are in any way prone to fail in service that the detachable idea commends itself, nor can it be said that the chain question has been much of a factor in the trouble end of the average automobile, whereas, in the better class of cars, it is the chain that stood for sturdy reliability in defining the word. But, the time must come when the best device that man can build will reach the fag end of its life, and the great question then becomes one of prolonging the hoary old age of the faithful servant.

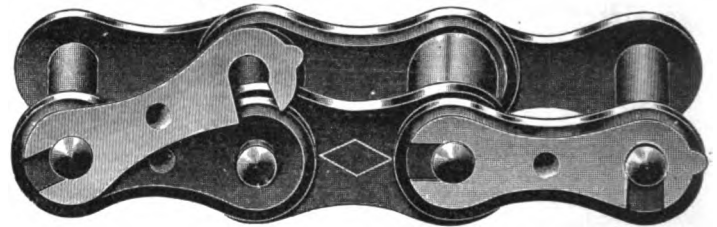

Diamond Detachable Chain Showing Locking Mechanism.

The Diamond Chain & Mfg. Co., of Indianapolis, Ind., recognizing the potency of the idea, recently brought out a chain for use in automobile work, into which is incorporated the detachable principle. The cut shows a link in the chain in which a thin strip steel lock on top of each outside link slips into a groove around the rivet surface and turning on one rivet as a center slips down into a similar groove on the other rivet, thus preventing the side bar proper from coming off. The strip is itself locked into position by being slightly warped inward, and having at its center an inward projection which snaps into a depression in the side bar. Once snapped into place, the strip can't change its position unless an intentional upward pressure is exerted on the clip at the end. The hole in the side bar is so reamed that when the bar is pressed into position, there is perfect bearing contact between the rivet shoulder and the side bar throughout the thickness of the bar.

High Grade Materials Lend Stability.—Billets of special analysis steel are used in the process, all under the eye and control of the makers of the chains. Nickel steel is used for such parts as demand the properties of metal of this sort, and case-hardened rivets in conjunction with seamless rollers help in the production of accuracy, in which all the conditions as follows are adequately taken into account: (a) limit of fatigue, (b) elastic limit, (c) ultimate strength, (d) elongation, (e) variation and (f) backlash. The process, from start to finish, is conducted by the company in the absence of all outside influences.

In the working up of the material with the idea of affording the greatest possible length of satisfactory service, the bearing surfaces are vastly more than the average autoist would have any idea of, and every means is taken to assure permanent fit and alignment of the links in the chain. Noise, that vague specter of the autoist, is kept out of the system if the chain is accurate and if the sprockets are rightly cut, provided the chain holds to the dimensions agreeable to the original plan. It is in this respect that the makers of the "Diamond" claim to have culled perfection and dressed it in its simplest form.

GOOD AND BAD LAWS PROPOSED IN WISCONSIN

MILWAUKEE, Wis., March 15.—At least eleven statutes relating to the use of automobiles have been introduced into the legislature of this State, but it has been so busy with other matters that it has not had time to consider them, and perhaps the only legislation that will be effected will be that for good roads. Of the bills proposed governing the automobiles there are several that are worthy of the support of the autoists of this State, while others will have to be fought. Two are identical and would change the present law to make the initial license fee \$2.00, and \$1.00 for each annual renewal. This meets with general approval, as does one to prevent anyone under 17 years of age from operating a machine, and one which cuts out speed limits, making it a penal offense to drive recklessly or when under the influence of liquor. Still another bill would prohibit the placing of bumps or other obstructions in highways, and a sixth makes it a misdemeanor for anyone to use an auto without the consent of its owner.

Of narrow-minded and thoroughly pernicious origin are four bills, and a determined stand will be made against them, if the

members of the State Automobile Association will work together. One provides for an annual registration fee of \$5.00 for machines not exceeding five horsepower, \$10.00 for cars not exceeding 10 horsepower, and fifty cents per horsepower for each additional horsepower above 10. If a car should be sold a re-registration would be required and all would expire on January 1. The dealers would have to pay \$40.00 annually, with \$5.00 for each extra set of number plates. Another of the bills is patterned along the same lines but bases its classification upon weight. Equally nonsensical with these is a proposal that hereafter the maintenance of guide boards by the several towns shall be optional instead of compulsory, and it can readily be seen how many towns would bestir themselves upon such a matter. The remaining obnoxious bill would allow each city to locally control the speed and use of automobiles within its own confines.

One bill has been introduced, upon which the Association has taken no stand, providing for a State inspection of all gasoline and prohibiting the sale of gasoline testing below 65 degrees. The oil people claim this will tend to raise the price of gasoline.

OHIO LAW IS AMENDED AT LAST.

COLUMBUS, O., March 15.—By the amendments to the State automobile law enacted at the recent session of the Ohio General Assembly, every license expires on December 31. Heretofore licenses expired one year from issuance, which caused the State automobile department considerable confusion. Each year the color of the tags to be placed in front and in the rear of every machine will be changed, making it possible for the police departments to ascertain whether the license for the current year has been paid. The words Ohio and the year will also appear on the tag. Motor trucks and drays which were formerly exempt from the operation of the law, are now included, making it possible for the State department to regulate such classes of vehicles.

Section 31, providing for records in each of the 88 counties, as well as in the State automobile department, of every conviction for violation of the law, was repealed entirely. The old law provided that every conviction of fast or careless driving should be recorded with the clerk of the courts in every county. Since no other misdemeanor or crime is so registered, it was thought to be a grave injustice and class legislation that would not stand the test of its constitutionality.

LEGAL FIGHT NOW ON IN CHICAGO.

CHICAGO, March 15.—Enough of the necessary money having been raised, the fight against the Chicago wheel tax has been begun and will be carried right up through the Supreme Court and a precedent established, not only for this city, but for the whole country. The kick is directed against the use of the tax money and the seating capacity as a basis for the tax ordinance rather than the weight of the car.

The objections to the ordinance and its results were so widespread that the Automobile Trade Association decided to fight it if outsiders would help to raise the money to pay for the legislation. The sum of \$10,000 was settled upon by the committee.

To quote the treasurer, Henry Paulman, "We feel that there should be some sort of a tax, but we use the boulevards extensively, which are under State control, and therefore get none of the money paid in to the city. We want the money expended where it will do the most good to the men who are obliged to pay it. Probably the best way to collect a tax from the automobilists would be to have the charge included with the State license, with a part of the money set aside for the city." This should be an easy thing to do, and with slight expense.

INDIANA MODIFIES ITS ROAD LAW.

INDIANAPOLIS, IND., March 15.—A radical change in the road laws of Indiana, that will probably mean a decrease in the building of new roads, has been effected in the repeal of the three-mile road law by the legislature. In a new law the procedure is changed, and the referendum system adopted. The new law provides that fifty resident property owners may petition to the county commissioners for an election to decide whether or not a road shall be built. If a petition is not presented protesting against the election and signed by 55 or more property owners, the commissioners are required to order the election.

Under the old law, upon the petition of fifty property owners, the commissioners were required to order the building and improving of a road, without the formality of an election. The only proviso was that the proposed road should not be more than three miles long and that it must connect at each end with improved roads or be traveled by a United States rural mail route. While the three-mile road law was in effect, roads to the extent of \$8,000,000 a year were built and improved under it. Farmers raised the principal objection to the old law, because residents of small towns petitioned for brick streets under the law and the whole township had to bear the expense.

MARYLANDERS WILL OPPOSE THE SWANN BILL.

BALTIMORE, March 15.—Secretary Frank W. Barling, of the Automobile Club of Maryland, has organized the autoists of Union Bridge, this State, for the purpose of co-operating with the club in its fight against the passage of the Swann automobile law, now before the Maryland Legislature, particularly that section of the same which provides for what is considered a new special rate. Raymond K. Angel has been selected as chairman *pro tem* of the new local association.

DELAWARE AUTOISTS PROTEST AGAINST TAX.

WILMINGTON, DEL., March 15.—Official protest against the bill now pending in the Delaware Legislature, proposing to tax automobiles as personal property, was made last week when John J. Satterthwaite, president of the Delaware Automobile Association, and other prominent members appeared before the State Senate and stated their reasons for opposing the bill, and pointing out its apparent injustice. No action has been taken upon the measure. That the association will put up a good fight against the measure is assured.



Vol. XX Thursday, March 18, 1909 No. 11

THE CLASS JOURNAL COMPANY

H. M. SWETLAND, President

231-241 West 39th Street, New York City

EDITORIAL DEPARTMENT

A. G. BATCHELDER, Managing Editor

R. F. KELSEY, Associate Editor

THOS. J. FAY

MORRIS A. HALL

W. McKEAN WHITE

W. F. BRADLEY, Foreign Representative

BUSINESS DEPARTMENT

A. B. SWETLAND, Business Manager

LOUIS R. SMITH

FRANK B. BARNETT

W. I. RALPH, 1035 Old South Building, Boston, Mass.

C. H. GURNETT, } 1200 Michigan Ave., Chicago, Ill.

F. W. VAN SICKLEN, }

H. H. GILL, Detroit, Mich.

T. B. VAN ALSTYNE, Philadelphia, Pa.

Cable Address - - - - - Autoland, New York
Long Distance Telephone - - - - - 2046 Bryant, New York

SUBSCRIPTION RATES:

United States and Mexico - - - - - One Year, \$3.00
Other Countries in Postal Union, including Canada - - - - - One Year, 5.00
To Subscribers—Do not send money by ordinary mail. Remit by Draft,
Post-Office or Express Money Order, or Register your letter.

FOREIGN SUBSCRIPTION AGENTS:

ENGLAND:—W. H. Smith & Sons, Ltd., 186 Strand, London, W. C., and all book-
stalls and agencies in Great Britain; also in Paris at 248 Rue de Rivoli.
FRANCE:—L. Baudry de Saunier, offices of "Omnia," 20 Rue Duret, Avenue
de la Grande Armee, Paris.
GERMANY:—A. Seydel, Mohrenstrasse 9, Berlin.

Entered at New York, N. Y., as second-class matter.

The Automobile is a consolidation of The Automobile (monthly) and the Motor
Review (weekly), May, 1902, Dealer and Repairman (monthly), October, 1903,
and the Automobile Magazine (monthly), July, 1907.

THE FUEL QUESTION IS SERIOUS.

The reason why gasoline was used to the practical
exclusion of kerosene oil in automobile motors was
because the lighter fractions of the distilling process
possessed the more volatile properties, and could be
more completely burned in the cylinders, thus rendering
up more power per pound of fuel used, and in the
process carbon was not left as a residuum.

When gasoline was to be had for the purpose, it was
predicted that the price would soar, for it was well
understood that less than ten per cent. of crude oil would
distill off in this form. It was then that inventors were
active, and a means for burning kerosene oil was sought
as if much depended upon success.

In due course the distiller of crude oil made bold to try
a hand at inventing, and the gasoline furnished to auto-
mobile users is really a compound of all the fractions
down to the kerosene distillate, with just enough of the
lighter fraction to assure that a motor can be started
cold. The result is that the fuel enters the cylinders as
liquid—to a vast extent, at any rate—an l in the combus-
tion process the fuel is broken down and the carbon is
"coke" out.

The whole thing was accomplished by such easy
stages that autoists failed to account for the presence of
excess carbon in the cylinders, unless to lay it to the
lubricating oil, and the question of ignition gradually im-
proved so much that the firing of the charge was not

attended by serious difficulty. In the meantime ad-
vanced experimenters located the real trouble, resulting
in fuel systems in which the exhaust heat is utilized to
vaporize the fuel so that it cannot enter the cylinders
in liquid form, there to "coke" up.

While it is true that the fuel is not what it was sup-
posed to be, it is equally true that the change resounds
to the greater advantage of autoists in general, if it can
be said that the heavier fuel can be made to burn with-
out leaving a residuum, provided the power of the motor
will be quite as good, and if flexibility will be no less.
Starting "cold" is something to take into account, but
this is a matter which seems to be in good fettle.



TRACTORS PLEASE RURAL POPULATION.

Anybody who is not familiar with or who does follow
the progress of agricultural machinery will be very much
surprised with the recent advances in this field, particu-
larly among the tractors. These clumsy-looking ma-
chines bid fair to put the farm horse out of business, not
because of its speed, but because of its inherent inability
for sustained labor. Thus upon plowing the length
of one side of a 200-acre farm, the horse must rest be-
fore attempting the return trip. This rest, when multi-
plied by the number of furrows ploughed in a day,
means a large loss of time, possibly at a season when
every minute is valuable. On the immense farms of
the West and Northwest, some of which are of ten thou-
sand acres and more, it is readily seen that this loss,
whatever it may be, is again multiplied, this time by fifty
or more. From the above, it is apparent that a self-
propelled tractor, which can drag a gang plow and thus
turn up six or more furrows at a time, do a series of
these in less minutes than the horse takes for one and
keep it up all day without a minute's rest, has advantages
that the farmer must see and appreciate.

The timely trials of last year which took place at the
Winnipeg Fair showed, as had never been shown before,
what the tractor could do when given a fair chance and
intelligently handled. A brief mention of some of the
best performances will be appropriate. Thus, the winning
machine ploughed 3 1-4 acres of virgin prairie sod, which a
heavy rain had converted into sticky Manitoba "gumbo,"
in two hours on a consumption of 8 1-8 gallons of gaso-
line. This is an average of but 2 1-2 gallons per acre,
which at 14 cents per gallon makes the cost for fuel just
35 cents per acre. This machine was of 30 horsepower,
having four 6 1-4-inch by 7-inch cylinders, was operated
by one man and pulled six 14-inch bottom gang plows.

Similar and equally valuable results were obtained in
the French trials, which were not as extensive, however.
These results show the farmer, who works on a small
margin of profit at best, what may be done with the
"new fangled" machinery, and thus points out an addi-
tional source of economy.

The winning machine and many of the others were so
equipped that after the first furrow has been plowed,
the machine steers itself automatically. This allows the
man in charge to walk beside the plows and observe the
work as it is done. The necessity for more than one man
does not exist, therefore, an additional source of econ-
omy is opened up, this being a more real blessing to the
farmer than the actual saving in cost, as farm laborers
are particularly hard to get and keep.

SPEARE SUCCEEDS HOTCHKISS AS HEAD OF A. A. A.

BOSTON, March 15.—Lewis R. Speare, of this city, has been elected to the presidency of the American Automobile Association, to succeed William H. Hotchkiss, who has resigned, to give his full attention to his new duties as Insurance Commissioner of New York. During the automobile show the regular quarterly meeting of the board of directors of the A. A. A. was held, and Mr. Speare, the president of the Bay State Automobile Association, chosen to head the national body, filling out Mr. Hotchkiss' term, which expires on December 1.

At this meeting also a strong addition was made to the A. A. A. through the election to membership of two more State associations, the Colorado State Automobile Association, with six clubs, 650 members, and the South Dakota Motor and Vehicle

Chairman Powell Evans, of the Touring Information Board, has secured the official recognition of the United States Government as the national organization of motorists. This has been brought about by the A. A. A.'s having become a conferee of the National Conservation Commission, Mr. Evans being the Association's conservation committee chairman, and not alone through its interest in good roads can the A. A. A. work prove beneficial in this connection, but also in other ways. This is suggested in a letter to the commission from Chairman Evans, in which he suggests that through the influence of the A. A. A. every autoist in the country can, within a few weeks, be mobilized into a most efficient scouting force, to give notification promptly of any outburst of forest fires, as well as possibly



Quarterly Meeting of the A. A. A. Board of Directors, Assembled In Boston, March 15, President Speare Presiding.

Association, with six county organizations, 350 members, bringing the total number of State bodies to 27. The Lookout Mountain Automobile Club, of Chattanooga, Tenn., was elected as an unfederated club. George C. Diehl, of Buffalo, a member of the board of governors of the Automobile Club of Buffalo, county engineer of Erie County, and an active participant in all good-road movements, was appointed chairman of the national good roads board, to succeed C. Gordon Neff, of Cincinnati, whose resignation was accepted with regret. P. M. Milner, president of the Motor League of Louisiana, was elected a director.

The deed of gift of the Cobe trophy, donated by Ira M. Cobe, president of the Chicago Automobile Club, for a stock chassis race, was accepted and referred to the Contest Board, with power to conduct the event. Those present at the meeting were: Lewis R. Speare, president of the Bay State A. A.; A. E. Bliss, president, and A. D. Converse, vice-president of the Massachusetts State A. A.; J. P. Coughlin, president of the Worcester A. C.; A. E. Lerche, president of the A. C. of Springfield; W. W. Brown, president of the A. C. of Vermont; S. A. Miles, general manager of the N. A. A. M.; E. P. Chalfant, general manager of the A. L. A. M.; F. B. Hower, chairman of the A. A. A. Contest Board; C. H. Gillette, secretary of the Connecticut A. A.; F. H. Elliott, secretary of the A. A. A.; W. B. Lasher, A. C. of Bridgeport, Conn.; L. J. Powers, Jr., Springfield; W. H. Chase, Wachusett A. C.; Francis Hurtubis, Boston; E. F. Whitmore, Willimantic, Conn.; H. R. Burbeck, North Adams, Mass.

giving aid in their suppression. Mr. Evans therefore urges each club to pass a resolution pledging its members to notify by telegraph the proper officer of any State of any fire observed.

AMERICAN MOTOR LEAGUE GIVES UP GHOST.

Apparently the American Motor League has passed away, though its demise has been a lingering one, owing to the individual activities of Isaac B. Potter, its president, who was the head of the L. A. W. in its palmy days when it had a membership of 107,000. The former offices of the League in the Vanderbilt Building on Nassau street, New York City, are untenanted, and, according to the *New York Globe*, Mr. Potter has become a resident of Denver, where he intends to continue practicing law. At one time an amalgamation seemed assured of the A. A. A. and the A. M. L., but the joint committee of the two bodies failed to agree upon a satisfactory constitution.

JERSEY AUTOISTS IN EVIDENCE AT TRENTON.

TRENTON, N. J., March 17.—Although a large number of automobile owners to-day appeared in the Assembly to urge the passage of the Colgate bill, they were disappointed, for the bill went over until to-morrow, having already passed its second reading in the House. At the same time they protested vigorously against the plan of the legislature to divert \$120,000 from the motor vehicle department into the State treasury.

CHICAGO MAKES PREPARATIONS FOR COBE TROPHY RACE

CHICAGO, March 15.—By the appointment of a board of executives and other officials, and the inspection of the proposed course, active preparation for the road carnival of the Chicago Automobile Club on May 29 and 31, which will include a light car race upon the first day, and the national contest of stock chassis for the Cobe trophy on the second, has been commenced. A thorough inspection of the roads was made in a trip yesterday and the possibilities of the circuit have been examined by experts. The excellence of existing conditions surprised those who will have the events in charge, so that a race that will compare with the most successful national events is predicted.

The club has decided to give the conduct of the meet to its contest board, Joseph F. Gunther, A. J. Banta and C. G. Sinasbaugh, while the various executives will consist of eleven men, in whose hands will be vested the power to carry on the work. Frank H. Trego has been made general executive, having a general supervision of the details; N. H. Van Sicklen, Sr., will superintend the construction of the course; F. E. Edwards will attend to the construction of the grand stands and the fencing while other departmental chiefs include the following: Technical, David Beecroft; finance, Ira M. Cobe; house, Burley B. Ayers; hospital, Dr. L. W. Bremerman; diplomacy, Harold H. Wheeler; publication, Fred W. Van Sicklen; publicity, C. G. Sinasbaugh. The committee on public safety will have for its chairman the colonel commanding the Indiana militia, which, it is hoped, will be detailed to guard the course. A Chicago delegation will visit Governor Marshall at

Indianapolis this week to ask that soldiers be assigned to this work. It is hoped the Governor will consent.

In the trip over the course yesterday it was found that the stretch between Crown Point and Cedar Lake is the most winding, but it is believed that while the curves may slow the drivers some, they will not be dangerous. From Cedar Lake to Lowell, a distance of six miles, there is a perfectly straight road, then comes the turn into Lowell and out on to a broad road, that runs three miles to the southeast corner of the course. This bit of road has a couple of turns, one a short S, but in general is one of the best parts of the course because of the width and smoothness of the roads. Turning from this leg there is a 10-mile straight way to Crown Point, where great speed can be made. On this leg, near Crown Point, it is planned to erect the grand stand, probably within a mile of Crown Point, because of its accessibility.

"I consider the Crown Point-Lowell course superior to the one over which the Braircliff was run, and I believe it is the equal of the Vanderbilt, outside of the Motor Parkway strip," said N. H. Van Sicklen after the inspection trip. "It is going to take a lot of work to put the course in shape, but I believe that a liberal expenditure of money will give us a circuit that will be capable of producing a winning average of 50 miles an hour, which is not bad when it is remembered the race is for stock cars. The roads are generally wide enough for the cars to pass each other. The circuit is about 24½ miles in length, instead of the 22 that had been estimated, so Chicago will have a circuit as good as any in the country."

FLORIDA'S MEET MAY RESULT IN NEW RECORDS

DAYTONA, FLA., March 17.—The annual races on the Ormond-Daytona beach, scheduled to begin next week, Tuesday, and continue the balance of the week, may result in some new straightaway speed records, for the entry list promises to contain some of the most noted cars in the country. Owing to the lateness in the announcement of the meet itself, the entry list is going to be kept open until the eleventh hour. The Florida East Coast Automobile Association is busily engaged in making final preparations, and the resourcefulness of W. J. Morgan, the manager of the meet, is certain to bring forth a generous entry.

One of the noted cars entered is the Benz, which Hemery drove in the Savannah Grand Prize. This has been bought by Hugh McIntosh, the well-known Australian sporting man, who is here to see how it will perform in the hands of D. L. B. Brown, who made the best amateur record a year ago. Ralph De Palma is a Fiat participant, and H. J. Kilpatrick will drive the Hotchkiss, which was the best performer in the Jamaica (L. I.) straightaway trials. Herbert Lytle will also participate, probably with an American, and George Robertson, the Vanderbilt winner is a possibility.

PERMISSION FOR FAIRMOUNT PARK RACE GRANTED

PHILADELPHIA, March 15.—Thoroughly pleased with the result of the Founders' Week 200-mile stock car race, which was held upon its fine roads last fall, the Fairmount Park Commission on Friday granted to the Quaker City Motor Club the right to repeat its successes upon the same course on October 7 of this year. Thus this club is the first in the country to set its date for what will undoubtedly be one of the most important events of its kind held in this country this year. A single dissenting vote was cast by the commission, recognized to be one of the most conservative in the city.

Formal application was made through a letter to the board at its regular monthly meeting, in part saying: "It is the intention to use, if possible, about the same course which was followed in the Founders' Week race, and to conform to the same rules and regulations, although we wish it understood that such conditions as you may see proper to impose will be strictly complied with." The same responsibility for the roads and the same method of policing the course will be enforced.

So well did the members of the commission favor it that the letter was hardly discussed, and the club will now have to deal only with the Committee of the Park on Superintendence and Police, working with it in planning for the big contest, as arranged by the Park Commission. The result of this is not only exceedingly gratifying to the Quaker City Motor Club, but also to all Philadelphians, and it is freely predicted that the crowd of 400,000 people which saw last year's event—a record attendance—will be materially increased.

Although the big road race will be the star card in the Quaker City Motor Club's programme of enlivening affairs, it will not be the only one by any means and the contest committee is outlining a busy season. A roadability run will be held late in April, as a preparatory stunt to a big four-day endurance contest to Pittsburg and return, scheduled for May 19 to 22. It is probable that this date will be slightly changed because the Norristown Automobile Club has already set its run to Hagerstown and back for May 18 and 19.

What the Clubs are Doing These Days

HARTFORD AUTOISTS DECIDE TO EXPAND.

HARTFORD, CONN., March 15.—General expansion and broadening the influence of the Automobile Club of Hartford, in the interests of automobilists, is the matter of greatest import to its members since a well-attended meeting was held at the club rooms in the Allyn House on last Friday evening.

The acquirement of a permanent clubhouse has always been a topic of discussion, and there seems to be a more strenuous demand for one now than ever before. The membership is now about 350 with bright prospects for an increase before spring. A committee, consisting of General Wallace T. Fenn, chairman, Edgar L. Ropkins, F. W. Stickle, N. F. Allen, C. H. Veeder, C. D. Rice, H. P. Maxim, Geo. W. Merrow, A. G. Hinckley, F. A. Morley and F. W. Dart, was appointed to draw up suggestions for the expansion of the club. They will report at a banquet to be held on Friday evening, March 26.

The club by unanimous vote has gone on record as being heartily in accord with the proposition to erect a bridge at the mouth of the Connecticut River connecting Lyme and Saybrook. It would obviate the use of the obsolete ferry which plies at the mouth of the river. The Automobile Club of Hartford will be more of a factor in the sport this season than ever before. The forthcoming endurance run, from all reports, will be the best ever held around here. Every member is anxious to have the organization listed among the best of the country. When the roads are in good shape the sign post committee will continue its campaign where the coming of cold weather necessitated a stop. Every road of any importance will be amply posted for the benefit of all who motor. Since the club inaugurated an anti-scorching campaign some time ago there seems to have been a decided let-up on the part of the reckless element.

CONGRESS STEALS MARCH ON AUTOISTS.

WASHINGTON, D. C., March 15.—The Automobile Club of Washington has decided to put up a vigorous fight against the imposition of an annual wheel tax on automobiles. During the closing hours of Congress, a rider was tacked on to the District appropriation bill, providing that hereafter there shall be assessed and collected an annual wheel tax on all automobiles owned and operated in the District of Columbia. Cars having seats for two persons will pay \$3, and those having seats for more than two persons will pay an additional tax of \$2 a seat.

This provision was included in the bill without the knowledge of the automobilists, and had been a law a week or more before it was known to any one except a few members of Congress. Naturally a big howl went up from the automobilists and the matter was discussed at length at the club meeting on Saturday evening, it being resolved to fight the provision to the last ditch, on the ground that it is class legislation of the rankest sort. A resolution was passed authorizing the club's secretary to notify every member of the organization not to pay the tax until compelled to do so by the Federal courts. It has not as yet been decided whether the Club will institute a test case.

A SMALLEST CITY WITH AN AUTO CLUB.

EVANSVILLE, WIS., March 15.—This little city will soon have an automobile club, which will affiliate with the Wisconsin State A. A., a member of the "Three-A." Twenty-two prominent residents of the little city have purchased cars, and at the suggestion of the Milwaukee Automobile Club, are agitating the formation of a local club. If this is done, Evansville will have the honor of being the smallest city in Wisconsin to have a club.

EARLY POPULARITY OF NORRISTOWN RUN.

NORRISTOWN, PA., March 15.—The contest committee in charge of the endurance run of the Norristown Automobile Club, which will be held over a 400-mile route between this place and Hagerstown, Md., May 18 and 19 next, have thus early received so many requests for entry blanks as to warrant the claim that the run will be one of the largest, as regards the number of contesting cars, ever held in this part of the country. Not less than 75 cars is the committee's claim. The route as finally selected provides for controls at Coatesville, Lancaster, York, Frederick, Md., and Hagerstown, Md., the overnight stop—190 miles—and at Gettysburg, Harrisburg, Lebanon, Reading, Pottstown, and finish at Hotel Montgomery, this city—210 miles.

Two classes of entries are provided for—the trade and the laity. All manufacturers and agents are eligible to the former class, which is sub-divided into touring car and runabout divisions; the latter class is open to any club member or non-trade member of the A. A. A. The details of the run will be looked after by the following officials: Referee, John H. Rex; business manager, Oliver F. Lenhart; starter, Wayne Davis; assistant starter, A. D. Hallman; chief checker, Earl Wentz; associate member A. A. A., Harry Lasher. At the conclusion of the run the cars will be impounded and critically examined by the following technical committee: Linn De Haas, Henry Lewis and Lawson Ballard. A "pathfinding" expedition will go over the route on March 31, April 1 and 2 to arrange for checking stations, hotels, accommodations and other matters.

SYRACUSE CLUB HOLDS SEVENTH BANQUET.

SYRACUSE, N. Y., March 15.—Few automobile clubs in this country can boast of sufficient age to hold a seventh annual banquet, but the Syracuse Automobile Club is able to do so, and on last Wednesday evening had its seventh celebration, there being about 200 guests present, and the affair was a success from start to finish, all checking in at the windup without a penalization. C. Arthur Benjamin was toastmaster, and in his remarks predicted that the present membership of 230 would be increased to 450 before another year has passed.

President Hurlburt W. Smith made an interesting address, telling of the history of the organization since its inception in 1901, when the first run was held over the State fair boulevard, and one man reached the toll gate.

Mayor Alan C. Fobes, Professor W. K. Wickes, Rev. D. B. Thompson and others also spoke. The committee in charge was composed of H. W. Smith, W. L. Brown, D. E. Brown, C. E. West and Forman Wilkinson.

MARYLAND AUTOISTS AFTER JOY RIDERS.

BALTIMORE, March 15.—The Automobile Club of Maryland, at its regular semi-monthly meeting, decided to furnish the police department with slips, containing the names of chauffeurs and the number of cars, so that the policemen can report any of those seen in questionable localities. By this means the club expects to be successful in ending the persistent joy riding by chauffeurs.

GRAND RAPIDS CLUB PLANS HILL CLIMB.

GRAND RAPIDS, MICH., March 15.—The Grand Rapids Automobile Club has decided to promote a hill climb, with an A. A. A. sanction, to be held some time in the near future. The events will be divided into several classes, under the direction of W. D. Vandecar, chairman of the tours and contest committee.

ROCHESTER HAS ITS SECOND ANNUAL SHOW.

ROCHESTER, N. Y., March 15.—Rochester's second annual automobile show was opened by Mayor Edgerton this afternoon in Convention Hall, under the auspices of the Rochester Automobile Dealers' Association, with eighty cars upon the floor. Every automobile dealer in the city is represented, and around the galleries and balconies are located the accessory and supply exhibits. The whole structure has been brilliantly decorated and illuminated for the occasion. The exhibition has proven to be of great interest to automobilists, not only in this city, but also in a great many surrounding towns. To the dealers and visitors, alike, not only in point of decorations but also in the merits of the machines shown, the event gives promise of being highly satisfactory. The building has been so arranged as to give the tradesmen as much space as possible, and it is expected that still more machines will be added to those now in place as the week goes on.

A number of the cars were shipped directly to this city from Boston, while others have been going the rounds of the shows in the Middle West. Two Rochester factories are represented, the Selden and the Cunningham, the latter a newcomer. Herewith are the car exhibitors:

Hollis-Rand Company—Overland.
D. M. Dorman—Winton.
Gabel & Hill—Babcock electric.
C. E. Hartson—Mora.
C. L. Whiting—Bulck.
Arthur McNall—Peerless, Pope-Hartford, Rauch & Lang electric.
L. B. Kirkpatrick—Oakland.
Genesee Motor Vehicle Company—Maxwell.
Benson & Hughes Motor Vehicle Company—White, Rambler.
Rochester Automobile Company—Packard, Baker, Lansden.
A. M. Zimbrick—Stoddard-Dayton, Kissel-Kar.
Thomas J. Northway—Ford, Reo, Marion.
Union Motor Company—Mitchell, Chase motor wagon.
Selden Sales Agency—Selden.
Mabbett-Bettys Motor Car Company—Cadillac, Stevens-Duryea.
Caledonia Avenue Auto Company—Detroit electric.
Smith Sash & Door Company—Welch.
James C. Dryer—Cunningham.

The show will continue throughout the week, during the afternoons and evenings a number of social features being scheduled to accompany it, and concerts given by the Fifty-fourth Regiment orchestra and band will tend to heighten the festivities.

MILWAUKEE SHOW REVEALS LARGE SALES.

MILWAUKEE, WIS., March 15.—After the closing of the big show at the Hippodrome, last Saturday night, the dealers and exhibitors, to a man declared it the best ever. The number of cars sold has surprised even the most sanguine of exhibitors, whereas the croakers have vanished into thin air.

The automobile club is rejoicing, too, because the large and well sustained attendance, totaling over 25,000, will result in swelling the club treasury by several hundred dollars. Had it not been for the unfavorable weather on the closing night, a record for attendance would have been made then with a corresponding effect on the receipts.

Saturday, however, was the big sale day and despite the bad weather the demonstrators were kept busy from morning to night, and a big bunch of orders were booked.

The first result of the enthusiasm has manifested itself in the decision to repeat next year. If this is held, it will be next fall at the time when the new models come out.

ALL SYRACUSE DEALERS WILL EXHIBIT.

SYRACUSE, N. Y., March 15.—If all the automobile dealers of this city could be given the amount of space for which they have applied, there would have to be an overflow meeting in connection with the show which will be held here from March 24 to 27. All of the members of the local trade have asked for space, as well as numerous supply men and accessory dealers, and all will be given just as much room as possible. Dai H. Lewis, who will have entire management of the event, is expected to arrive shortly and take charge. Mayor Alan C. Fobes will open the exhibition.

LATER APRIL DATES FOR NEW YORK CARNIVAL.

For a number of important reasons, conflict with Easter and Holy Week, the desire for more settled weather conditions, and the need of more time for preparation, has influenced the carnival committee of the New York Automobile Trade Association to postpone the week of festivities from April 5 to 10, as at first planned, to the week of April 26, closing upon May 1. The local trade seems much pleased with this move and more hearty support than ever has been promised.

At a recent meeting of the committee a number of important matters were considered. One of them is the determination to give as prizes for decorated cars \$2,000 in cash, and to allow in line only those makes of machines whose metropolitan representatives have contributed to the carnival fund, although at the same time it has been deemed advisable to prohibit any car from carrying any name or mark, except its number. R. G. Howell will have charge of the parade this year, as he had last.

Headquarters for the carnival committee has been located at the main store of the American Building, at Columbus Circle, through the courtesy of W. R. Hearst, with Secretary Walter C. Lee in charge. In electing the king and queen of the carnival, to preside over and lead the pageant on the Saturday afternoon, it is probable that a popular vote will be taken.

The dates as they now stand are as follows: Monday, April 26, hill climb; Tuesday, April 27, straightaway races and speed trials; Wednesday, April 28, souvenir day on automobile row and banquet; Thursday, April 29, gymkana games, obstacle races, etc.; Friday, April 30, endurance run; Saturday, May 1, afternoon carnival parade.

Alex. Schwalbach, chairman of the endurance run committee, has named the following as the members of the committee: Herman Kuntz and C. F. Clarkson, A. L. A. M.; Alfred Reeves and L. M. Bradley, A. M. C. M. A.; E. L. Ferguson and H. C. Harbach, secretary, Quaker City Motor Club.

MINNEAPOLIS HAS NORTHWEST SHOW.

MINNEAPOLIS, MIN., March 15.—What is the greatest exhibit of automobiles ever held in the Northwest opened Saturday night in the Minnesota State Armory, and will continue throughout this week. The Minneapolis Automobile Show Association, an organization of local dealers, after having dropped out of the show business for a year came to the front this year with an exhibition which is the biggest kind of a success. Over 40,000 square feet of space was sold, and a score or more of tardy applications were turned down, because of the lack of space. Manager Walter Wilmot, the ex-big league baseball star, prepared things with a lavish hand, and the decorating and lighting schemes are elaborate and harmonious.

The entertainment features of the show this year surpass anything before attempted in Minneapolis. The First Field Artillery band, a celebrated national guard organization, gives concerts twice daily, and besides this a dozen artists, both vocal and instrumental, have been engaged. In addition to these attractions, there is continuous vaudeville in the portion of the ballroom, on the third floor, not been turned over to exhibitors.

BROOKLYN TO HAVE ITS FIRST SHOW.

BROOKLYN, N. Y., March 15.—This section of Greater New York will have its first individual automobile show, under the sanction of the Long Island Automobile Club, at the Clermont Rink from April 10 to 17, and the prospectus sent out by the managers, C. H. Green and E. J. Rowe, says that "it will be the most beautiful show ever held in America." The floor space has been divided so that there are thirty-one large spaces for exhibits of automobiles, and twenty-five for accessory booths. The large spaces average about 15 by 18 feet in size, and enough have been secured in options to show the interest taken in the event by Long Island tradesmen.



Packard 3-Ton Truck Used for Hauling Ice.

This truck has recently been placed in service by the Union Merchants' Ice Company, of San Francisco. This marks another branch of service to which the commercial car is being applied.

NEW BOSTON SALESROOM FOR PACKARD.

BOSTON, March 15.—Expansion of the local automobile trade beyond the bounds in which it has heretofore confined itself is indicated by the announcement just made by Alvan T. Fuller, agent for the Packard and the Cadillac, that he has purchased 87,500 square feet of land on Commonwealth avenue, near Cottage Farms, upon which he is to erect a building 300 by 70 feet, ground measurements, and five stories high, to contain his salesrooms, offices, shops and repository. Mr. Fuller for several years has been located in the Motor Mart in Park square, where he occupied a very large amount of space with his salesrooms and shops. His business has outgrown even these commodious quarters, and for this reason he is to erect the new structure.

The lot of land has a frontage of 271 feet on Commonwealth avenue, the principal automobile thoroughfare to the west of the city. It also has a frontage of 356 feet on Malvern street, 260 feet on Gardner street and is 304 feet long on the rear line. The frontage on the avenue is on a curve, which will give Mr. Fuller's establishment a conspicuous position. The building probably will be of reinforced concrete, and it will be equipped for making every part of an automobile.

ANOTHER ADDED TO YORK'S FACTORY.

YORK, PA., March 15.—The three plants at York now devoted to automobile manufacture will soon be augmented by the works of the New Departure Motor Company. This is a Western concern, with headquarters in Lansing, Mich. The head of the firm, J. C. Montgomery, has been in the city for several days negotiating for a site, and has practically decided upon the one he wants.

Upon this will be built a large modern plant, to accommodate 500 men. The output will be a lower-priced car, of which 1,500 will be turned out for the 1910 season. The principal product will be taxicabs, of which two-thirds of the output will consist, the other 500 being commercial cars. The principal office will remain in Lansing, the new works here being but a manufacturing branch.

MAXWELL PLANS 10,000-MILE NON-STOP.

In order to boost the non-stop run records as high as possible, the Maxwell-Briscoe Motor Company has determined to start a 10,000-mile non-stop test, using one of the four-cylinder 30-horsepower runabouts, and within a few days this will be started. It is probable that the first trips of the car will be in and out of Boston, covering the roads for many miles around that city, and, it is reported, an A. A. A. sanction will be asked, naming this as an endurance contest. Carl W. Kelsey will have charge of the performance.

WITHERBEE IGNITER MOVES TO SPRINGFIELD

SPRINGFIELD, MASS., March 15.—No sooner did the regulars in the vicinity of the New York Motor Mart discover that the Witherbee Igniter Company had something up its sleeve than there came from Springfield news to the effect that the company had taken possession of a large, modern brick factory building on Birne avenue, at the corner of Arch street, this city. With upward of 40,000 square feet of floor surface, in one of the most important automobile centers in New England, it is learned that the company proposes to cut loose with its highly specialized devices with a view to reaching a far higher level of production, hoping, perhaps, to ultimately keep pace with the demand.

The new plant is equipped with up-to-date machinery, and such apparatus as will facilitate in the processes by which the well-known Witherbee accessories are made. Among the new endeavors, under the most happy auspices, will be the pushing of Wico commutators, spark plugs, ignition wire, batteries and Volta magnetos. The general office of the company is now at the plant, in Springfield, but the Motor Mart quarters will remain the New York City branch office of the company.

'09 RAINIER CARS SOON DUE IN NEW YORK.

From the old factory of the Rainier Motor Company, which has resumed operations at Saginaw, Mich., the first of the 1909 models of the Rainier cars will be sent to New York, and will be shown in the new headquarters of the company at Broadway and Sixty-fourth street next week. Having acquired the rights, title, and interests of the Rainier Motor Car Company, the new corporation, with a capital stock of \$350,000, has been duly registered at Albany, N. Y., and the production of Rainier cars will now proceed without interruption. The incorporators are Paul N. Lineberger, George C. Comstock, and Frederick H. Van Houten, and the management will be in the hands of John T. Rainier and Mr. Lineberger, the president and vice-president, respectively. In addition to taking the corner store for its metropolitan headquarters, the firm will have the entire top floor of the same building, with over 22,000 square feet of floor space, giving room for repair and paint shops.

At the Saginaw factory it is the Marquette Motor Company which is producing the cars for the Rainier Company. The Marquette company is capitalized at \$300,000, and it is understood that it has the backing of the General Motors Company, in which Buick and Oldsmobile interests are merged.

ACME REVIVES OLD COACHING DAYS.

Over the same roads that many years ago were the routes taken by the mail and passenger coaches on regular schedules, in lumbering from New York to Philadelphia, an Acme limousine has now started on a regular service between the hyphenated hostelrys of these two cities.

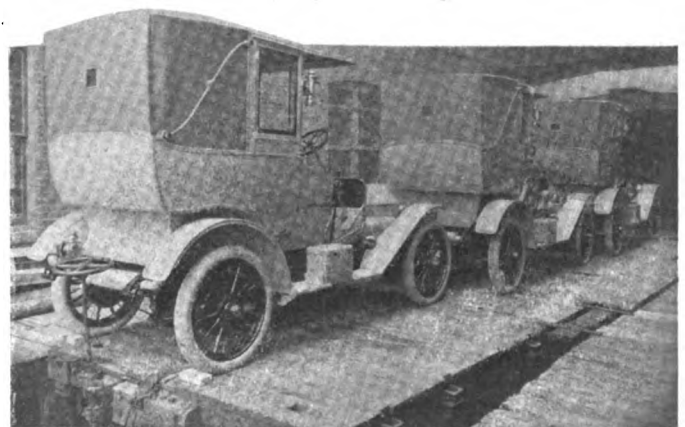

First Shipment of Cartercar Taxicabs from Factory.

The Cartercar Company, of Detroit, which has taken up the manufacture of taxicabs in addition to its regular line, is equipping these cars with the friction transmission, and the new chain-in-oil drive.

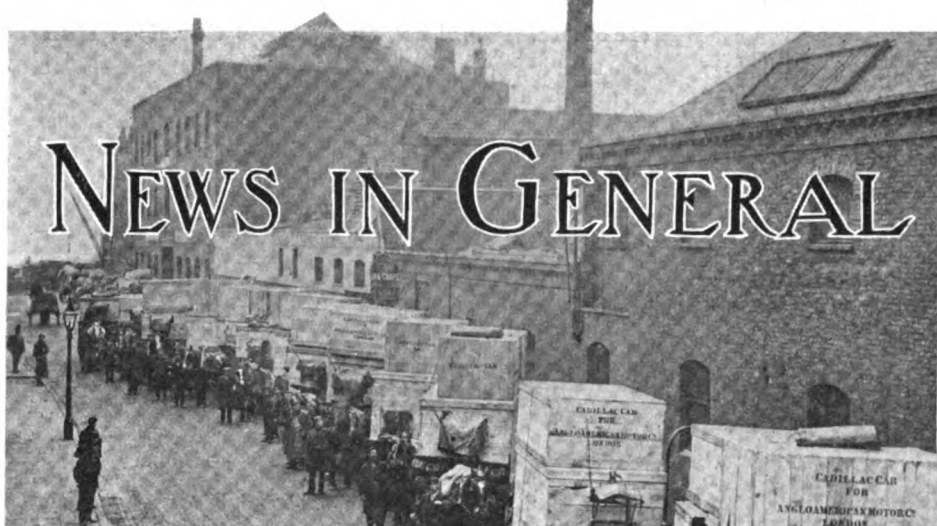

Cadillacs Arriving in London.

The illustration shows a shipment of Cadillacs from the Detroit factory to the London branch, which have just been unloaded from a transatlantic liner, and gives an idea of the company's increasing export trade.

Proper Tire Inflation.—Perhaps the first to recognize the special importance of proper inflation was Edouard Michelin, the well-known tire manufacturer, who is a skilled scientist and has made a life-long study of rubber and its peculiarities. Mr. Michelin once observed that, although over-inflation was a common fault, fully 50 per cent. of the tires tested at the Michelin factories and branches were insufficiently inflated. "Don't be afraid of bursting the tires," said Mr. Michelin, recently, "the tires will stand as much pressure as an ordinary tire pump can put into them." The air pressure in the tires should be proportioned to the weight of the car and its occupants, the size of the tires and the horsepower of the motor. A booklet issued by the Michelin Tire Company, Milltown, N. J., contains tabulated instructions for determining the proper tire pressure, and is of value to any car owner, regardless of what particular tires he may be using.

One Thousand Magnetos a Week.—With 4,000 magnetos sold on minimum specified delivery for March, and orders increasing rapidly, the Remy Electric Company, of Anderson, Ind., has decided to try to produce 200 high-tension motor ignition systems every day, the present capacity being about 1,000 per week. In addition to making equipments for automobiles the concern is rushed with work from stationary and marine-engine manufacturers and a number of magnetos are being built especially for the big gasoline motors employed by the Union Pacific and other western railways. New men have been added to the office and factory force, and educated in the building of magnetos as rapidly as possible, and new machinery is being installed as fast as it can be secured. The Remy Company claims that it is the first to ship magnetos in carload lots, as it has done recently.

Quaker City Also Has a Non-Stop Run.—Just as a sort of Quaker City annex to the main show in Boston, the Philadelphia Maxwell agents, the Longstreth Motor Car Company, started one of their little \$500 "junior" runabouts on a 2,000-mile non-stop stunt last Saturday morning. Up and down Broad street and around the suburbs the compact little "junior" will plug away until its task is



finished. Drivers will work in eight-hour shifts, and relays of observers have been arranged for. No attempt at speeding will be made, and the arranged-for 12-miles-an-hour schedule should enable the car to complete its journey in about seven days. On Wednesday evening the car had completed 1,000 miles.

Pennsylvania Racing Team Formed.—With the intention of being represented in all important automobile contests during the coming season, a racing team has been established by the Pennsylvania Auto Motor Works, of Bryn Mawr, Pa. Len Zengle, the young driver who piloted the cars in most of the events last season, will have charge and will have three machines, a six-cylinder stock car of 75-horsepower, which has a guaranteed speed of 85 miles per hour, and will be used in all open events, a 50-horsepower, four-cylinder car and one of the small ones, 25-horsepower, which will be used in their respective classes.

Cause of Tire Heating and a Preventative.—Although after a long day's run the tires become considerably heated up so that the warmth is noticeable to the hand, the cause for this is not well known. According to a Goodyear expert tire-maker this is the direct result of the frictional action between the outer shoe and the inner tube. It cannot be wholly avoided, but by rubbing French chalk over the tube before it is inserted in the shoe it can be materially reduced. The chalk acts to reduce the friction to a minimum, and therefore diminishes the amount of heat generated and the wear resulting from it.

Marion Cars Not Discontinued.—In final contradiction of the report which became general some five months ago, that the Overland Company had purchased the Marion plant, and that the latter make of cars would be discontinued, the Marion Motor Car Company has announced its intention of producing 400 four-cylinder cars during the coming year, of 35-horsepower, and in

three styles, five-passenger touring cars, roadsters and toy tonneaus. The Marion Motor Car Sales Company, of Indianapolis, will have the sale of the entire output of the factory.

Anderson After Overland Factory.—The Overland Automobile Company and a committee representing the city of Anderson, Ind., are negotiating for the removal of the Overland factory to that town. It is reported that the company has signified its willingness to move providing the town furnish a factory site and a \$60,000 cash bonus. The committee are reported as favorably disposed toward the proposition but the deal has not yet been closed.

Night and Day Work Necessary at York.—Busy is hardly the word to apply to the York Motor Car Company, of York, Pa., for it is even better than that. So great has been the demand for Pullman cars that a night shift has been a positive necessity. With the factory working twenty-four hours a day, the officials hope to catch up with the orders. The present plans include 100 more cars than were originally planned for this year.

Chicago Dealers' Ticket.—The nominating committee of the Chicago Automobile Trade Association, through its chairman, E. Q. Cordner, has named the following ticket for the annual election a week from Friday: For president, N. H. Van Sicklen, Sr.; for vice-president, H. C. Tillotson; for treasurer, Henry Paulman; for secretary, F. E. Sparks; for directors, Thomas J. Hay, E. Q. Cordner and Walter L. Githens.

Unit Coil Company Buys Patents.—The Unit Coil Company, of Jersey City, N. J., owner of the Varley and Williams unit coil patents, announces that it has recently purchased the Brigham and Lawton buck-proof coil patents, and also two basic master vibrator patents issued to Miller and Dow in 1904.

Pardington Moves Parkway Offices.—A. R. Pardington, second vice-president and general manager of the Long Island Motor Parkway, Inc., has announced the removal of the offices of the corporation from 527 Fifth avenue, New York City, to the Denton building, Mineola, Long Island, where they will be located in future.

Busy Overtime Making Sparks.—The K-W Ignition Company, Whitney building, Cleveland, reports that it is so pressed with orders that a night shift has become an absolute necessity. The big plant is therefore working night and day to keep up with the requirements of its customers.

IN AND ABOUT THE AGENCIES.

Hoyt Electrical Instrument Works, New York.—The Hoyt Electrical Instrument Works, of Penacook, N. H., has opened an office at 1931 Broadway, New York City, to facilitate handling of its export business and to take care of its trade in the territory contiguous to New York. R. V. Sutcliffe, formerly superintendent of the Dayton Electrical Manufacturing Company, has been secured as branch manager.

Several KisselKar Agencies.—The Kissel Motor Company has announced the establishment of the following agencies for the KisselKar: Concul Bluffs, Iowa, Bertschy Motor Company; Jacksonville, Ill., Dick Y. Rowe; Kankakee, Ill., E. A. Jeffers; Ashkum, Ill., Richard Meents; Ottawa, Ill., C. A. Miller; Bedford, Ind., A. E. Dickinson.

Warner Auto-Meter, Seattle.—The Warner Instrument Company, manufacturers of the well-known auto-meter, have just opened their fourteenth branch house at 914 East Pike street, Seattle, Wash. This office will be in charge of H. L. Worthen, recently connected with the Los Angeles branch.

Rambler, Hartford, Conn.—As a direct result of the recent show, Mansuy & Smith have signed up to handle the Rambler. This firm is the largest horse dealer in the city and for some time has been doing motor car work. The large place of business at 17-19 Elm street is well equipped for the purpose.

National, Chicago.—Charles P. Root, chairman of the contest committee of the Chicago Motor Club, and a prominent figure in Windy City automobile circles, has taken the agency for the National cars in that city, in addition to handling the Truscott motor boats.

Moon, Milwaukee.—The State agency for the Moon line of cars has been taken by the Riverview Automobile Company, which will move into its new garage, May 1. The latter is located at 325 East North avenue, and is one of the most up-to-date in the northwest.

Winton, Cincinnati.—L. C. Denison, of Cleveland, has secured the Winton Six agency for Cincinnati and opened for business, March 15th, on Ninth street, between Vine and Sycamore, in premises lately occupied by the Cincinnati National Bank.

Chalmers-Detroit, Grand Rapids.—The Imperial Auto Company have received their 30 horsepower demonstrator and are busy exploiting the merits of the Chalmers-Detroit, for which they have taken the local agency.

Oldsmobile, Milwaukee.—The Olds Motor Works of Lansing, Mich., has established a branch in Milwaukee, with temporary headquarters with the Excelsior Motor Car Company, 621 Grand avenue, that city.

Brush, Hamburg, N. J.—An agency for the Brush runabout and delivery wagon has been established in Sussex County, N. J., with Reeve Harden, of Hamburg.

Ford, Fond du Lac, Wis.—P. B. Haber has been appointed agent for the Ford line at Fond du Lac, Wis., and surrounding territory.

Lozier, Wisconsin.—Willard V. B. Campbell, of Horicon, Wis., has been appointed State agent for Wisconsin of the Lozier.

E-M-F, Morristown, N. J.—Willard B. Smith, of Chatham, has been appointed agent for the E-M-F in this city.

Apperson, Milwaukee.—The American Automobile Company has taken the agency for the Apperson line.

RECENT BUSINESS CHANGES.

Chicago Trade Changes.—The tendency on the part of Chicago dealers to extend the row to the south has become even more pronounced, and last week it was announced that two more of the agencies would move from their present location in the heart of the row to the southern part of the line, where already the Stearns and Packard have secured sites. H. Paulman & Co., Chicago representatives of the Pierce-Arrow, now at 1430 Michigan avenue, have secured a lot 50 by 187 feet at 2420 Michigan avenue, where will be erected a two-story building which will be ready for occupancy by June 15. The Locomobile branch, now at Michigan avenue and Four-

teenth street, has leased property 75 by 171 feet at the southwest corner of Michigan and Twentieth street, and will build a three-story building of concrete and steel.

A. M. C. M. A., New York.—New and more commodious headquarters were last Monday occupied by the general offices of the American Motor Car Manufacturers' Association, on the fifteenth floor of 505 Fifth avenue, New York, half a block from the former office at 29 West Forty-second street.

Rutherford Rubber Company, New York.—The Rutherford Rubber Company, manufacturer of Sterling tires, has removed its headquarters from 253 West Forty-seventh street to Broadway and Fifty-third street.

Dow Tire Company, Boston.—The Dow Tire Company announces that its Boston office is now located at 893 Boylston street.

PERSONAL TRADE MENTION.

Some Ajax Trade Changes.—More changes in the Ajax-Grieb Rubber Company's sales forces have been announced. H. M. De Silva, who formerly traveled for the factory through the western territory, has been installed as manager of the Chicago branch. Leon B. Smith has been succeeded by Joseph S. Gibbs as manager of the New York branch, and the latter will have charge of the New York and Connecticut territory.

A. Eugene Michel has just opened new offices at 1572 Hudson Terminal Buildings, New York City, where he will act as advertising engineer for the promotion of automobile accessories, steam apparatus, power transmission appliances and machine tools. Mr. Michel is a graduate engineer, Associate Member of the A. S. M. E., and has had eleven years of advertising and engineering training.

Bertram Bailey, formerly general manager and engineer of the Tour Traction Auto Company, of Mankato, Minn., has resigned from that position to accept one as chief engineer of the Schurmeier Wagon Company, of St. Paul and Minneapolis.

OBITUARY.

Henry Bausch, of the Bausch & Lomb Optical Company of Rochester, N. Y., died in Augusta, Ga., on March 2, where he had been since early in January for his health,

his illness lasting for nearly a year. Mr. Bausch was the third son of J. J. Bausch, who, with Henry Lomb, organized the immense optical plant which bears their names, and in which Henry Bausch has been actively interested and engaged since 1875. He is survived by Mrs. Bausch and one daughter.

RECENT BUSINESS TROUBLES.

Pneu L'Electric Company, New York.—Schedules in bankruptcy of the Pneu L'Electric Company, dealers in automobile supplies in New York City, have been announced, showing liabilities of \$31,338 and nominal assets of \$12,856, consisting of stock, \$3,000; accounts, \$9,082, and cash on hand, \$774.

NEW TRADE PUBLICATIONS.

Ferro Machine & Foundry Company, Cleveland, O.—This is not a catalogue, as an extensive general catalogue is published separately, but is really a text-book for owners and operators of marine engines. Realizing the fact that so few people owning or interested in marine engines really understand the construction and operation of the motors thoroughly the Ferro company, the large marine engine builders, publish each year "A Practical Treatise" on the subject. The 1909 "Treatise" is the most exhaustive work ever published on the subject of marine gasoline engines. It tells in simple language and with the aid of more than 300 illustrations all about the construction, installation and operation of these motors. The book is compiled by some of the most practical motor experts in the country and is something every one interested in marine engines should have.

Trenton Rubber Mfg. Co., Trenton, N. J.—One of the neatest and most attractive bits of advertising literature that has come to hand recently is the product of the advertising manager of the Trenton Rubber Mfg. Co., makers of Thermoid brake lining. It is in the interest of this that the book is sent out, but one would have to search it through several times to find the advertising portion, so cleverly is it hidden. The book is 8½ by 11 in size, large enough for an excellent series of pictures, and the title is "The Automobile of 1909." Following the attractive frontispiece in colors, which shows a beautiful female bather ankle deep in the surf over the caption "A critical inspection invited," are illustrations of some forty motor cars with detailed specifications. The latter occupy the right hand pages of the book, while upon the left hand and facing the cars, are various beautiful and interesting scenes. These are not confined to any one section of the country, but are selected at random from the best the country affords. The only trace of advertising which mars this beautiful work from the point of view of the art connoisseur is the simple statement that each car uses Thermoid brake lining. It is a very effective piece of catalogue art.



Car Lot of Remy Magnetos Ready for Shipment from Factory.

The photograph shows a car being loaded at the factory of the Remy Electric Company, Anderson, Indiana, with high-tension magnetos for shipment to Eastern automobile factories. The Remy shipping department states that several carloads of magnetos and coils with special parts are shipped every month.

INFORMATION FOR AUTO USERS

Little Giant Air Compressors.—Every garage has a need for air in some form, it may be used to inflate tires, for starting stationary gas engines, for operating heating and brazing machines, for pneumatic tools, sand blasts and many other every-day purposes. In order to have air pressure for these purposes, a first-class compressor is a necessity. The Orange Machine & Mfg. Co., 10-14 Statson street, Orange, N. J., has brought out the Little Giant to meet this need. This is a small and inexpensive machine built in a thorough, workmanlike manner, the small details being given

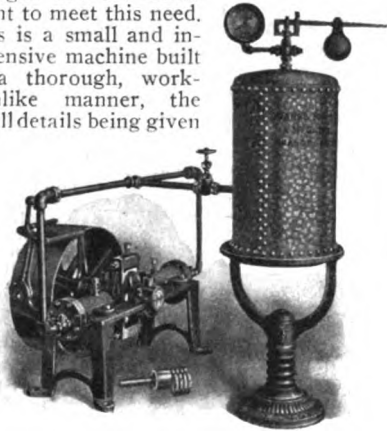

LITTLE GIANT AIR COMPRESSOR OUTFIT.

a maximum amount of attention. It may be arranged for direct connection to a revolving shaft or can be belt-driven. The makers not only furnish the compressor, but the storage tank, piping, etc., so that a complete outfit may be obtained from them if desired.

Simms Magneto Switch Starter.—Now that magnetos have become deservedly popular, and well nigh universal, some form of a starting device is almost a necessity. The makers of the Simms magneto have come to the front with such a device and automobilists will doubtless welcome it with open arms. This has a special contact-breaker on the magneto, the switch starter on the dashboard and an ordinary accumulator.

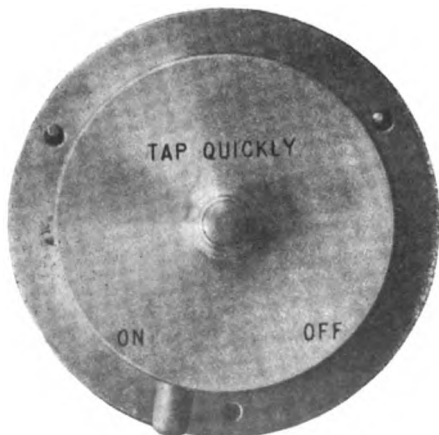

SIMMS DASHBOARD STARTING SWITCH.

Aside from these, the equipment is exactly like any other magneto outfit. The contact breaker is so designed that the points are normally separated, causing the armature primary circuit to be opened rather than closed. Then, by means of a special switch, a make-and-break current is instantly passed through

the primary winding, a very quick break causing an intense spark, which invariably starts the engine. After being started this runs on the magneto in the ordinary manner. Albert R. Miller, 42 Broadway, New York City, is the sole American representative of the Simms Magneto Company.

Triple Action Carbureters.—The woods are full of carbureters, some good, some bad, and some, neither the one nor the other. The Triple Action just brought out by the American Carburetor & Improvement Company, 1660-1668 Bushwick avenue, Brooklyn, belongs in the first class, and has the additional distinction of being different, that is, it works on a different principle. This device has no needle valve to regulate and practically no float:

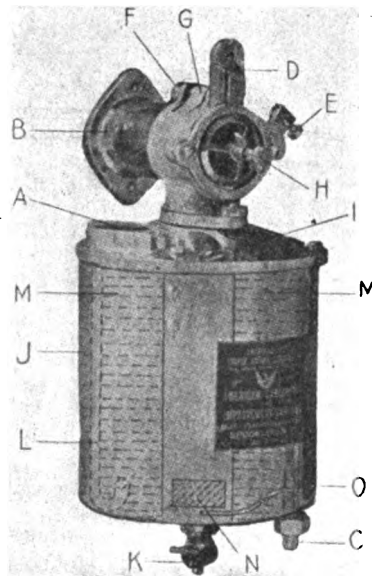

DETAIL OF TRIPLE ACTION CARBURETER.

that is, there is a very small metal float but it is used for a different purpose than the ordinary. In the cut is shown the barrel-shaped portion which forms the body of the Type M carbureter. This is marked J and contains a series of concentric plates M, spaced just enough to make room for the spray tubes L. In the center is formed a round chamber, which leads to the mixing valve. The last, which is also the throttle, is mounted above the other chamber, and carries two adjustments. The first of these is for slow and the other, for high speeds. F is the regulating screw for the former and H, for the latter. The position of both is one that gives ready accessibility. In action, the gas enters at the bottom and is gasified by the air passing upward through it from the multitude of air tubes L. The plates are so arranged that a uniform quantity of gas must pass between them for their entire height before it can enter the central gas chamber. This rich gas is mixed with the proper quantity of air at the aforementioned valves and passes thence directly to the inlet pipes. Hot air from the exhaust pipe may be led in if desired at A. The float valve is seen at O, just above the gasoline inlet C. At K is the drain cock and all other parts are self-explanatory.

Auto Cap Purse.—The Gloversville Purse Company, Gloversville, N. Y., are bringing out a novelty in the line of leather purses intended primarily for automobilists. This is called the auto cap purse from its resemblance to the ordinary leather cap, but is a practical purse for coin or bills. These purses

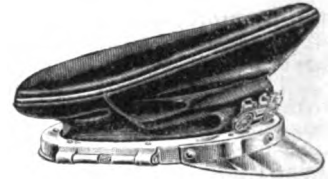

AUTO PURSE RESEMBLING A CAP.

are made in a variety of leathers and colors. The large, flat surface of the top gives a space for letters, names or advertisements. The purses can be stamped in gold or colors which in combination with the novelty of the shape makes a very attractive article.

The Auto Wind Shield.—As the illustration depicts, the device answering to the above title differs from wind shields in general, in that the driver looks over, and not through, the transparency, which is celluloid in this case. The shield is of a suitable grade of water-proof fabric, stretched over bows just as a cape top is fashioned, and besides warding off the wind and dust, which is deflected above the head of the driver, the shield keeps out the cold and the rain as well. Every autoist knows how futile it is to try to keep lap robes in place in such a way as to ward off the wind.

The shield puts an end to all the mechanicians of the wind and harbors the lucky autoist in a manner quite in keeping with the needs, which are indeed strenuous under certain conditions of inclement weather.

The wind shield fits closely around the driver's seat, buttons into place with but small effort, and folds back out of the way when it is desired to enter or leave the seat. It is a neat device, made strong, to



NEW TYPE OF WIND SHIELD.

withstand hard usage, and it in no way "badgers" the looks of a well designed automobile. The cost is very low indeed, considering the great utility of the shield, and the Auto Wind Shield Company, of Brattle Square, Cambridge, Mass., is to be congratulated in having invented and patented this excellent shield, the demand for which is so very brisk as to tax the facilities of the company to the utmost.

THE AUTOMOBILE

FLORIDA'S SPEED CARNIVAL HAS A VARIED FIELD

by R. F. Kelsey

DAYTONA, FLA., March 22.—Varied in character, yet withal interesting, the Florida meet promises a substantial success, conducted as usual under the auspices of the Florida East Coast Automobile Association, with W. J. Morgan, the originator of the series, the man at the helm, though this time with headquarters located entirely at Daytona.

The program includes automobiles, and motorcycles, and bicycles, not forgetting the presence of a real aeroplane.

Monday, while in practice on the beach, H. J. Kilpatrick, whose Hotchkiss racer is entered for all the high-powered car events, threw a wheel. Kilpatrick sustained no injury, but the accident prevented further practice work by the machine to-day, as it took considerable time to make repairs.

Robertson in the Benz, and De Palma in the Fiat *Cyclone*. They will also be paced by motorcycles in a separate series of trials. A bad fall in a motor-paced race at Atlanta last week prevents the attendance of R. A. Walthour, who was entered.

Referee S. A. Miles was on the ground early, and is doing yeoman service in assisting in the completion of the preliminaries. "Senator" Morgan is displaying his characteristic energy in arranging the details, and imbues every one with enthusiasm. He is ably assisted by Alex Schwabach, who is looking after the press and its representatives. Fred J. Wagner, the veteran clerk of the course and starter, is as usual at the post of duty, alert and watchful.

Representatives of the trade are quite numerous from the

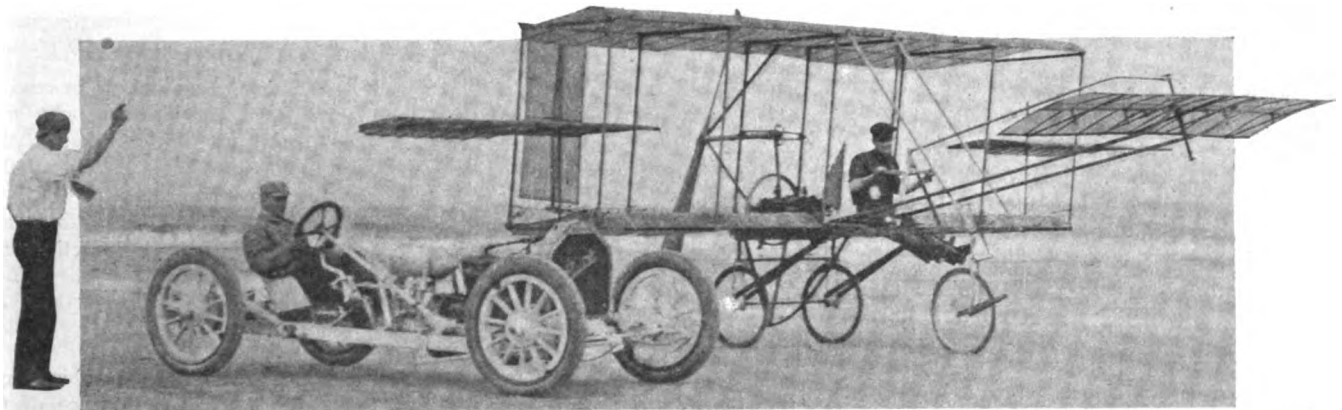

In the afternoon the motorcyclists were out in full force, Oscar Hedstrom with a new Indian machine of about ten-horsepower creating a sensation with his phenomenal burst of speed. Fred Hill, of Boston, who is after professional honors for the U. S. U., also reeled off some miles well under the minute mark. Among the amateur motorcyclists who are present for the races, are A. G. Chapple and Walter Goerke, of Brooklyn; Robert Stubbs, Birmingham, Ala.; William Wray, Jr., and Eugene Gaestel, New York. President Earl Ovington of the Federation of American Motorcyclists will officiate as referee for this class of events.

Many prominent racing cyclists are entered for the cycling events, including E. L. Collins, Joseph Fogler, George Wiley and E. F. Root, and will compete for the mile record, paced by

North, and among those who have arrived are A. M. Mayo, of the Fisk Rubber Company of Chicopee Falls, Mass.; W. B. Wise, Flint, Mich., sales manager of the General Motors Company; Ralph Pope, manager of the Cleveland Automobile Company; W. H. Pickens, publicity manager for the Buick; Inglis M. Upperco, president of the Detroit-Cadillac Motor Car Company, of New York City, and the Motor Car Company of New Jersey. Leonard D. Fisk, the Hartford, Conn., representative of the Locomobile, is also in attendance, as are "Doc" Maxwell, publicity manager for the Benz Import Company, and J. Wilbur Hobbs, the Michelin tire representative. Others are known to be on the way.

Carl Bates, the aeronaut, has his aeroplane tuned up and has made a few practice flights successfully. He is expecting to



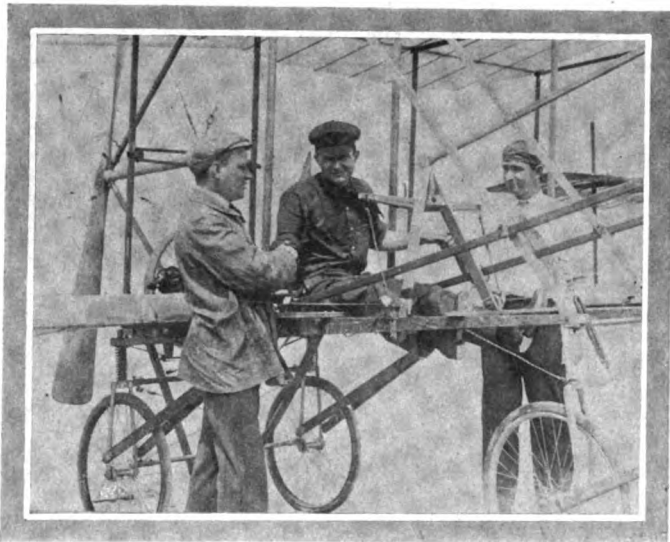

Strang and Burman Talking with Aeronaut Bates.

make good here, and one match race may be between his aeroplane and Strang in an automobile. Bates is confident.

Three World's Records on Tuesday.

DAYTONA, FLA., March 23.—Three new world's records, one professional and two amateur, were the result of the opening day of the Florida East Coast Automobile Association's seventh annual meet. The most sensational performance was that of David Bruce Brown, who lowered the world's amateur record for the mile to 33 seconds, a rate of over 109 miles per hour, in the trials for the Sir Thomas Dewar trophy. He drove Hugh McIntosh's 120-horsepower Benz racer, with which Hemery finished second at Savannah. In the other two of his three attempts, Brown's times were 33 1-5 and 33 2-5 seconds. The Fiat *Cyclone*, driven by Ralph De Palma, was the only other competitor, and his best time was 36 seconds, which was considered good, in view of the 60-horsepower.

Monday's high winds put the beach in fine shape, but made the tide high, and inasmuch as the race to-day was late in starting, it was necessary to cut the 200-mile event to half that distance. This race brought a Cadillac, driven by Herbert Lytle, and three Buicks, driven by Burman, Strang, and Dewitt to the tape. Dewitt had a Baby Buick, and was in a separate class, running at the same time. Burman led the first round of 20 miles, in 18 minutes 17 seconds, but on the second lap he lost his carbureter, and was cut out of it. Strang took the lead and held it to the end of the race, 100 miles, the high water then calling a halt. His time was 1 h. 34 min. 1 4-5 sec., breaking Burman's 100-mile record of 1:42:26, made last month at New Orleans. Dewitt, of course, won his class, as he was the only competitor, his time being only ten minutes more than Strang's, 1:44:34. Strang's intermediate laps were: 40 miles, 36:56 4-5; 60 miles, 55:02; 80 miles, 1:15:20 3-5.

Walter Goerke, of Brooklyn, captured the honors in the motorcycle time trials for the mile, making a new amateur record of 45 1-5, by breaking the former record of 46 2-5.

Eventful Happenings on Wednesday.

DAYTONA, FLA., March 24.—A magnificent beach and a wind-straight-up course was productive of records galore to-day. Two of these—the five and ten-mile events—went to Hugh McIntosh's Benz. In the five-mile invitation race George Robertson drove, winning in 2:45 1-5 from the Fiat *Cyclone*, breaking both the steam and gasoline car records for that distance. In the ten-mile free-for-all Bruce Brown drove, winning from the Fiat driven by De Palma in 5:14 2-5. The Fiat made a close run, with half the horsepower, 29 4-5 seconds separating them.

In the motorcycle record trials Walter Goerke made a new amateur record for two miles, 3:30 1-5. The Southern five-mile price handicap was won by a Pope-Hartford car, with a Cleveland second and a Locomobile third. Fogler won the half-mile bicycle race in 47 1-5 seconds, setting a new record, and he also won the two-mile race in 3:45 1-5.

Darkness and a fast incoming tide soon made it clear to Referee Miles and the others present that the 200-mile piston displacement race, which had been started rather late, would not be finished, so when conditions made it absolutely necessary, the cars were flagged. There were three starters in the class, for cars with over 400 cubic inches displacement, and when the leader, De Palma, in the Fiat *Cyclone*, was stopped he had covered 120 miles in 1:33:44 3-5. The Benz racer, driven by Robertson, broke a piston soon after the start and had to withdraw. Strang, the third starter, in a Buick, stopped after going 100 miles when he was in second place.

The phenomenal five-mile record made by Brown broke those held by Marriott, in a Stanley, for steam cars, of 2:47 1-5, and that made by Lancia, in a Fiat, for gasoline cars, of 2:54 3-5.

GRINNON LEAVES SAVANNAH HOSPITAL.

SAVANNAH, GA., March 22.—After many months of inactivity, an aftermath of the Grand Prize Race, Joe Grinnon, who was seriously injured when Burman's Buick car was smashed in the practice for the International Light Car Race, riding as the driver's mechanic, has just left the Savannah hospital to go to Daytona. Although still unable to do any work he has been attracted to the Florida beach by the reports of fast practice, and to see the races. It is said that it will be more than a year before his arm will permit him to do anything but the lightest kind of work.

Chatham county road commissioners now have two highways under consideration, one to Beaufort, S. C., a distance of 60 miles, and another to Tybee, Ga., 18 miles. Both have been indorsed by the merchants and the city officials. It is probable that the county will commence work on the road to Beaufort first, as the one to Tybee has been put up to the government to build. At Tybee there are more than a thousand soldiers, and the only means of communication is by railroad.

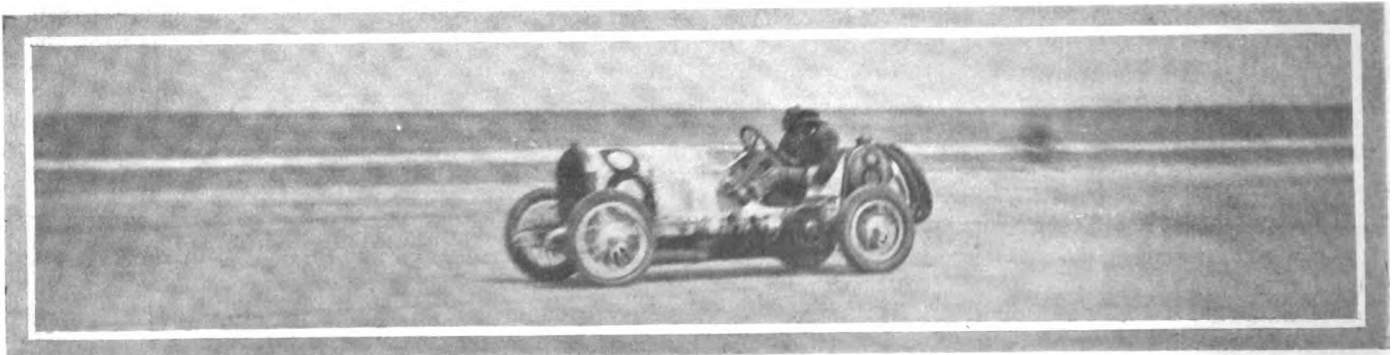

Hemery's Benz, Second at Savannah, Traveling the Florida Course, Driven by Amateur Brown, in 33 Seconds.

Picking the Route for the Coast-to-Coast Contest

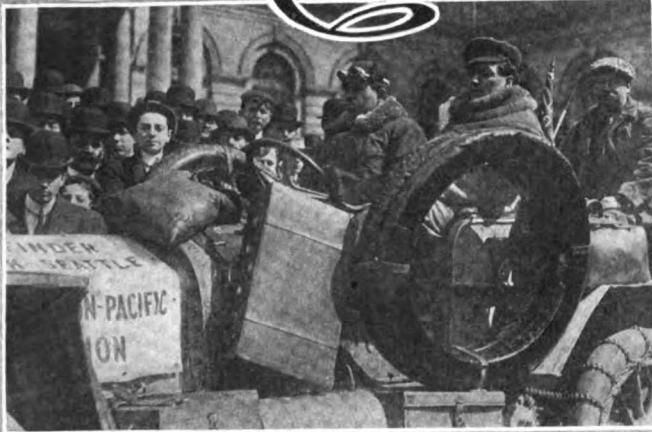

CALLED AT CITY HALL FOR MESSAGE



STARTING FROM THE HOTEL ASTOR



STOPPED AT THE A.C.A. FOR A FLAG

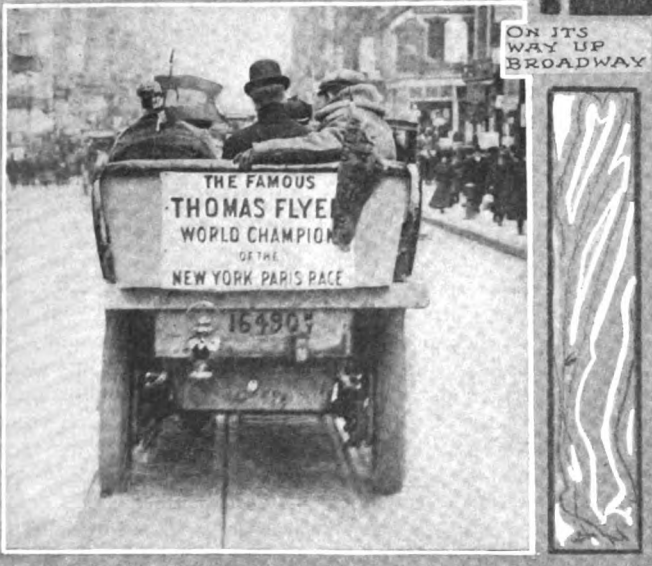

the present acting head of the Thomas factory, went to the City Hall, where they were tendered an informal reception, and given a letter from Mayor McClellan to the Mayor of Seattle. Finally, emerging from the immense crowd surrounding the car, it was driven to the Hotel Astor, where W. H. Hurlburt, the recently appointed manager of the local Thomas branch, gave a luncheon to the crew, and others involved in the run.

At half-past two in the afternoon, preceded by a Zust car, given the position as leader as a compliment to its being a competitor, and a finisher, in the race

to Paris, the big car started, and its escort fell in behind them. All of the machines were gaily decorated with flags bearing the letters "A. Y. P.," standing for Alaskan-Yukon-Pacific exposition, on account of which the run will be held. The first stop was at the Automobile Club of America, where Robert Lee Morrell, representing the club, presented the crew with a flag, admonishing them to carry it safely across the continent. Continuing up Broadway a great deal of interest was manifested along "Automobile Row," and a number of the cars, including the Zust, stayed with the Thomas as far as Yonkers, where a final farewell was said.

Poughkeepsie was the stop on Saturday night, after an uneventful run, and arrangements made with a hotel to sign the cards of the cars which will start from City Hall, New York, on the first day of June. Sunday was spent in running from Poughkeepsie to Little Falls.

From Little Falls to Syracuse, the itinerary on Monday was one continual reminder of the start of the race to Paris last Winter, for the snow was deep and heavy, and for 100 miles the car had to plow through drifts, and seek its way along poorly marked roads. Batavia was reached on Tuesday evening by a fast run of 160 miles, and Miller and his party wanted to push on to Buffalo, but on account of a prepared celebration, waited until Wednesday morning. A short trip took them into the Thomas' home town, where every one vied with one another in greeting the tourists, who will keep the usual route to Chicago.

CONVEYED to the city limits by enthusiastic New York automobilists, the Thomas car, which won the race from New York to Paris, last Saturday afternoon commenced another long, arduous trip, in laying out the route for the contest which will be held this Summer from coast to coast, starting in the metropolis and finishing in Seattle. Driven by George Miller, who was the mechanic upon the car in crossing Europe and Asia, with C. W. Eaton as his mechanic in the new venture, J. S. Sley representing the Thomas company, and L. W. Redington as official pathfinder, representing Mills and Moore, under whose management the event will be conducted, the car was given a rousing send-off wherever it appeared in the metropolis. In preparation for the transcontinental run, the machine was slightly changed from its former self, by the addition of a wide seat at the rear, but in general the equipment is the same that it carried around the world, even to shovels, ropes, and tackle. Of course, some 'round-the-world mud was missing.

And when Miller waved good-by to his escort, the first part of what promises to be a contest of widespread interest was begun. In the morning the party, including Edwin L. Thomas,

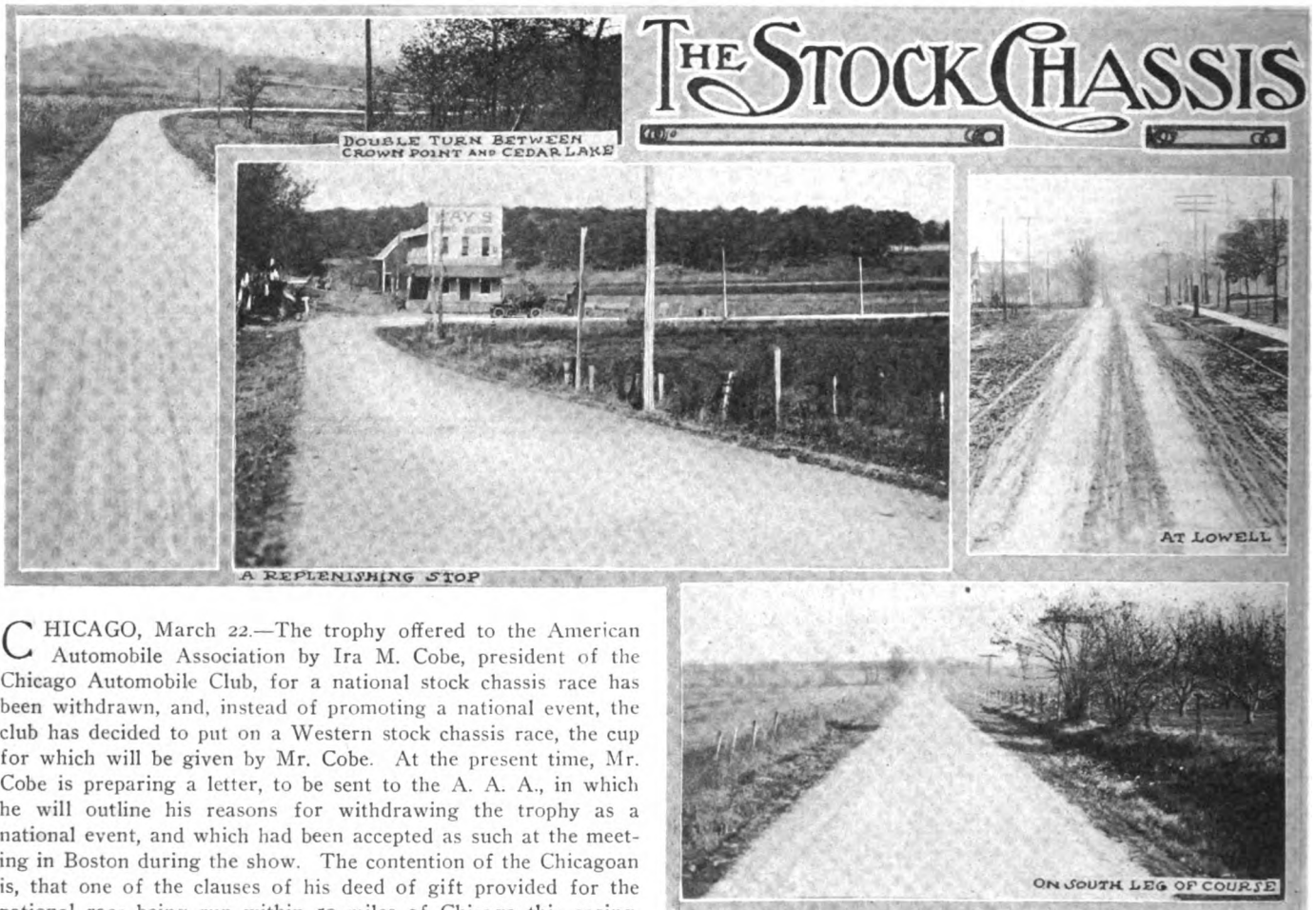

CHICAGO, March 22.—The trophy offered to the American Automobile Association by Ira M. Cobe, president of the Chicago Automobile Club, for a national stock chassis race has been withdrawn, and, instead of promoting a national event, the club has decided to put on a Western stock chassis race, the cup for which will be given by Mr. Cobe. At the present time, Mr. Cobe is preparing a letter, to be sent to the A. A. A., in which he will outline his reasons for withdrawing the trophy as a national event, and which had been accepted as such at the meeting in Boston during the show. The contention of the Chicagoan is, that one of the clauses of his deed of gift provided for the national race being run within 50 miles of Chicago this spring, but that it is impossible to carry out this provision because no one in Chicago is willing to undertake the promotion of such an event, because of the restrictions.

Chairman Hower's visit to Chicago last week brought matters to a climax. When the race was first broached here few understood what it meant to run a national road race, so all were enthusiastic over the proposition. The route had been picked, entries solicited, an organization perfected, and it looked as if everyone would work hard for the success of the event. But when Chairman Hower came on and explained that it was to be an A. A. A. event pure and simple, and that the national organization would control it all the way, there came a change of opinion. The local workers objected to doing all the preliminary work, such as financing the race, preparing the course, building the grand stand and the like, and then dividing profits with the A. A. A., letting it name the officials, make the rules and take the credit. Some of the executives chosen by the local club balked, refusing to work under such conditions, and the directors of the club themselves could not see any possible benefit to be derived from such a partnership. Therefore Chairman Hower was requested to come on and talk it over.

Several sessions with the chairman of the contest board were held, the deciding one being held last Thursday, at which time it practically was decided to give up the idea of running a national race. On Friday decisive action was taken, President Cobe looking at the matter in the same light as did his colleagues on the board, and by a unanimous vote it was settled that the Chicago Automobile Club should not undertake the promotion of the Cobe trophy national stock chassis race. Instead, Mr. Cobe announced that he would withdraw his deed of gift, and hang up a cup to be competed for in a Western stock chassis race, which the club would put on.

Following this decision the directors and the contest board discussed the plans for the Western derby. It was held that May 29 and 31, the dates selected for the light car race and the Cobe event, would not do, because of probable unsettled weather

and the desire for better road conditions. Also, little more time was needed to perfect the organization. Therefore, the board changed the dates to Friday and Saturday, June 18 and 19. On the first day will be run a race for light cars at probably 200 miles, while on Saturday the main event at about 400 miles will take place. As soon as the necessary formalities, such as providing for the guarding of the course, and the securing of the permits to use the roads are taken up, an application for a sanction will be made to the contest board of the A. A. A. Chairman Hower has promised to push through the rules as soon as possible, going from here to Detroit, where he had a conference with H. E. Coffin, chairman of the rules committee of the Manufacturers' Contest Association. Piston displacement will be used in dividing the fields, but as to what the figures will be, is not known as yet.

The announcement of the decision to run a Western road race stirred to enthusiasm many members of local organizations, and as a result of this there was a joint run of the Chicago Automobile and Chicago Motor clubs last Sunday, the combined forces making the trip to Crown Point, in the vicinity of which is located the course, over which it is proposed to run the two races. Fifteen cars were in the run and a critical examination of the circuit was made. A subsequent canvass of the drivers and passengers revealed a great deal of favorable sentiment.

Starting from Crown Point, it was found that the circuit branched a trifle to the southwest, there being several bends and turns in the 5-mile stretch between the Hoosier Gretna Green and Cedar Lake. One of these is a spectacular S which will have to be negotiated with care. At Cedar Lake the course straightens up and runs 6 miles straightaway to the little town of Lowell. Going into the village, the entrance upon the main street is made through a narrow opening between two buildings. It is a square corner and the cars will have to slow down. It is the one bad spot on the course. From Lowell east about 3 miles, is the south leg of the course, where the highway is broad and smooth, and instances are known where one car has passed another while

RACE OF THE WEST FOR THE COBE TROPHY

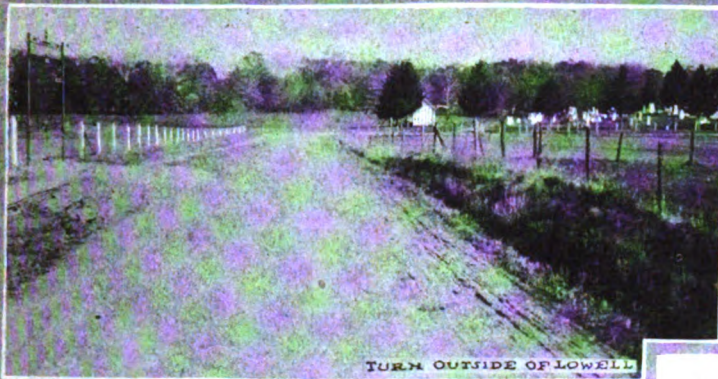

TURN OUTSIDE OF LOWELL



S TURN THREE MILES OUT OF CROWN POINT



BETWEEN CROWN POINT AND CEDAR LAKE



TURN AT CROWN POINT

going at 70 miles an hour. The east leg of the circuit is perfectly straight and is about 10 miles in length. There is here a 3 1-2-mile stretch of new road which, however, will be in prime

shape by June. On this leg will be located the start and finish, the committee having picked out a location for the grand stand, about 1 mile from Crown Point

There are eighteen turns in all on the course, fifteen of which are left-handed ones. The road itself is stone the entire distance of 24 1-2 miles; there is not a single railroad crossing on the circuit and but two towns. Crown Point will permit the racers to go through, and so enthusiastic are the residents that they will, in all probability, consent to the streets through which the races pass being boarded up and a bridge erected over which it will be possible to get inside the course.

Entries are assured by so many concerns and individuals that there is more danger of there being too many cars nominated, instead of too few. Thomas, Knox, National, Locomobile, Palmer & Singer, Apperson, and many other makes are known to be looking forward to competing.

DETROIT GETS THE START OF THE GLIDDEN TOUR

DETROIT, March 22.—Detroit has won, and Detroit automobilists are justly proud of the fight which they put up in securing for this city the start of the annual tour of the American Automobile Association, for the Glidden and other trophies. Upon the Detroit Automobile Dealers' Association fell the brunt of the task of convincing those who decide upon the route of the contest that this city should be honored with the beginning of the great national event, but it was ably backed up by the Manufacturers' Association, the Board of Commerce and other organizations, and last, but not least, by the promise of fifteen entries for the tour. Headquarters will be at the Hotel Pontchartrain.

Holding the undisputed title of the "Center of the World," in the automobile industry, and never having been visited by the Glidden tour, the manufacturers and dealers of this city banded together to secure the start, and Chairman Hower has agreed that the cars shall line up on the Campus Martius, when they start, about July 7. In addition to the promise of fifteen entries, the fees, \$3,000, have been actually paid by President Lane, of the D. A. D. A., this city will also furnish the pathfinding car and the pilot car, the E-M-F factory offering this inducement, in order to get the tour to commence its trip across half the Continent, from the "City of the Straits."

The fact that Detroit will be the start, is practically the only point in the preparations for the tour that has been definitely decided upon, except that Dai H. Lewis will leave here in the E-M-F pathfinder on April 1. It is known, too, that he will direct

his course to Chicago, where the tourists in the summer will be royally received, but as to the route beyond that point there is no information forthcoming, and it is admitted that the Contest Board is in somewhat of a quandary itself over the matter. There is little doubt but that Denver will either be the final checking station, or be an important one en route. If it is the former, it is possible that Minneapolis will be included on the itinerary, and autoists from that city point out its many advantages as a Sunday stopping place, with Minnehaha Falls, Minnetonka and Lake Calhoun, whereas if Denver is not the final destination, it is possible that Dai Lewis will wend his way straight across Iowa, through Omaha to Denver, and then back to Kansas City, visiting Colorado Springs en route.

The most troublesome point is to get accommodations for the tourists, and Chairman Hower and his assistants are trying to solve the problem with the aid of a service of Pullman sleeping and dining cars.

It is felt here that even more than fifteen cars will be entered from this city and vicinity, for the E-M-F Company promises three, the Cadillac and Chalmers-Detroit will probably send three each, the Regal is considering the rules, the Ford Company is sometimes said to be thinking seriously of putting its little four-cylinder machines in the tour, and the Olds Motor Works is sure to enter three. The Buick, Jackson, Welch and other factories are still to be heard from. The Packard Company will probably have Ralph Estep and Tom Fetch out with a press car.

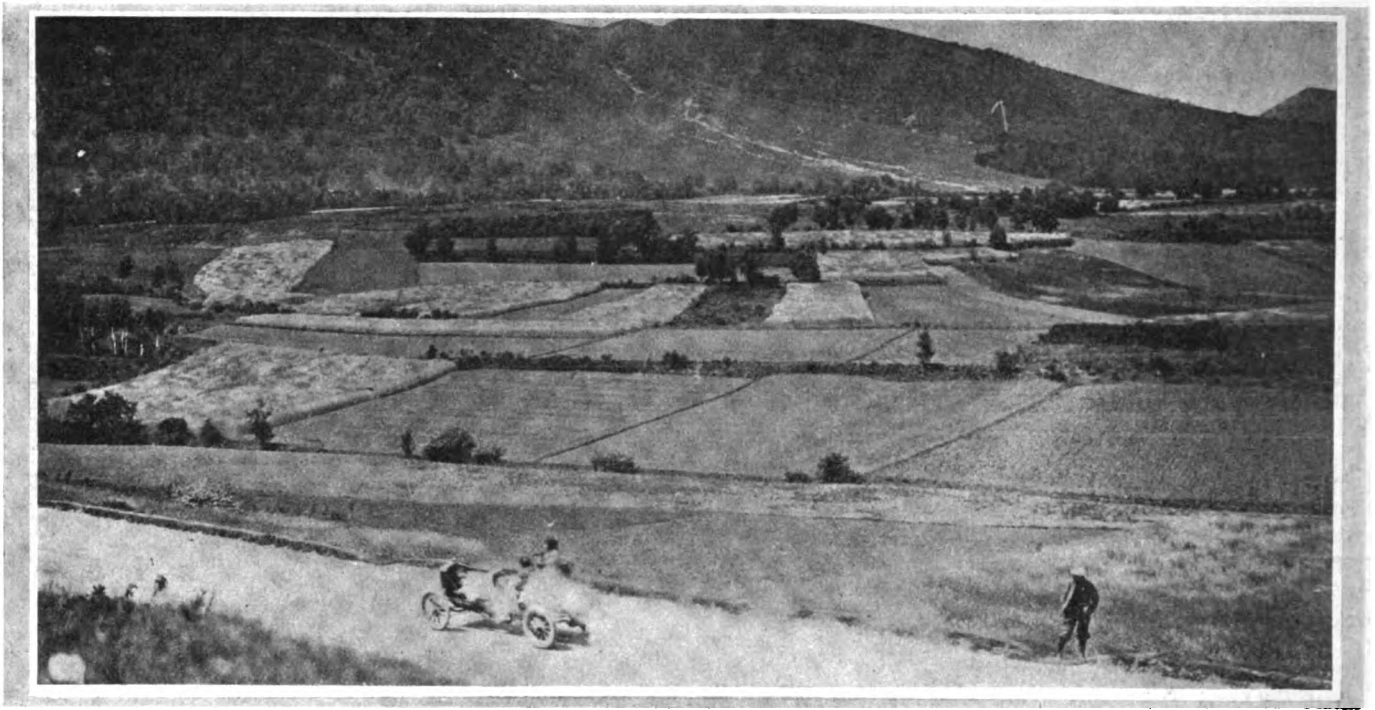

IS ROAD RACING NEAR ITS CONCLUSION?

By W. McKean White

EVER since the first automobiles were constructed, even when they were in very uncertain stages of development, there has been perhaps no phase of automobile affairs which has elicited such widespread and general spectacular interest, both in Europe and America, as automobile racing, the high speed of big-powered cars being a subject of interest at all times. The question is still extant, but the answer is not; and in the present chaotic condition it certainly appears as if road racing, at least, were nearing a conclusion.

There is a wide difference of opinion as to whether a continuation of this form of extending the interest in motor-driven vehicles is advisable and economical or not. But that is not the problem at present, for there are enough manufacturers, dealers and owners of automobiles who enjoy racing from the purely sporting viewpoint and who believe in it from a business standpoint to make a success of it. At the same time, both in this country and across the Atlantic, there are certain manufacturers who do not race and who do not want their competitors to do so, and, moreover, are strong enough to throw a very serious obstacle in the way of speed contests. Still another condition exists, for certain large makers, composing a majority of entrants in most of the big events, in recent contests beaten, decline to enter further and have caused a number of big events of international character to be postponed for this year or permanently abandoned.

In the United States this sentiment has not been so strong, but there has been another cause that has brought trouble. So few agree upon proposed rules that it has been impossible to frame regulations for contests, and this has caused events to be practically dropped. Summed up, it is more or less a question of rules in this country. As to who shall interpret the rules, and have final jurisdiction and national authority over the events, has been settled by the formation of the Manufacturers' Contest Association and its alliance with the A. A. A.

The conditions in France, the nation whose manufacturers in the past few years have led in building special cars for racing, have kept expensive drivers, and have spared no expense in promoting and holding the meets, which drew to them the interest and patronage of the world, calls for comment. French cars held premier honors until the past two years, when Italian

makers came very strongly to the fore, taking first place in a number of exceedingly important races. Then the Germans regained some of their former supremacy. The Grand Prix, won by the German Mercedes, disheartened the French; the Florio Cup race, appropriated by Nazarro in the Italian Fiat, was another blow; the Four-Inch race in England, taken by a Hutton car, wasn't encouraging, and, finally, the French hardly figured in the Grand Prize at Savannah. Then it was that a number of prominent French makers decided to combine for the "common welfare," first having the rules for the 1909 Grand Prix made with the stipulation that there should be forty entries at the beginning of the next year. When these did not appear, as it was planned, that great international race was declared off.

It is generally known, now, that at least seventeen firms, the majority French, were in the agreement and bound to one another so firmly that any one dropping from the number would have to pay a heavy forfeit. Those in the combination were: Dietrich, Germain, Motobloc, Berliet, Leon Bollee, Panhard, Renault, Brasier, Bayard-Clement, Delauney-Belleville, Isotta-Fraschini, Minerva, Pipe, Darracq, Peugeot, Mercedes and Benz. At least five other prominent concerns were asked to sign, but would not, being Mors, Fiat, Itala, Opel and De Dion. These were ready to take part in any good races. Although the whole autoing world fully expected to see this come about, it was nevertheless startled by the action in race-loving France. Inasmuch as these manufacturers in the agreement would not build any special cars this season, the Florio Cup race, proposed for the Bologna circuit, was promptly dropped, and the whole aspect of the situation became uninviting.

This situation has extended to this country to a large extent. In 1908 there were 21 American road races, with 199 entries. Of these one was international, one a free-for-all, without any limitations of consequence, several were for stock chassis, several more were cross-country races with no prepared course, and the remainder were class races, in which machines of some certain price, size or other characteristic were admitted.

Plans outlined for the coming season show that at least one international race may be put upon the calendar, the second contest for the A. C. A. Grand Prize cup, and it may be again held at Savannah. Hardly any one knows what will become of

the once blue-ribbon race, that for the Vanderbilt cup, nor, for that matter, whether there will be one for the Briarcliff trophy. Two stock car races of prime importance are even now being arranged, that in Fairmount Park, Philadelphia, and the other for the Cobe trophy, to be run near Chicago. Lowell, Mass., had a successful stock car contest last year, and sometimes there is an echo there as if another one would be acceptable. There is a vague report that Suffolk county, Long Island, is looking for a course and wants a race.

To be sure, this does not consider track or beach races, confining itself to those held upon public highways set aside for the purpose. The condition in this country, deep down beneath the surface, is not far different from that in Europe, except that here it is not a question so much of different countries as of different manufacturers within the country. For some time racing affairs have been in a turmoil, so that even if races were wanted it was almost impossible to hold them with any unopposed sanction. It was after the A. A. A. and the A. C. A. had apparently buried the hatchet and the hammer, and settled upon a definite line of joint action, that the manufacturers themselves formed the Manufacturers' Contest Association.

It should be understood that the popular wish for road racing is not declining, and the clubs so much realize such to be the case that at present two notable organizations, the Quaker City Motor Club and the Chicago Automobile Club, are making plans for their big events.

But even they are apt to run up against a very serious snag in the definition of a stock car, just as did the hold-over Briarcliff committee, though perhaps with less disastrous results. However, there will be a goodly number of makers to enter both

contests. At the same time there are many who wonder what kind of race will be held for the Grand Prize, for there are no cars being built which will conform to the so-called 1909 international rules, limiting the bore of cars in international contests to 130 mm.—5.1 inches. The big cars which took part last year have a bore one inch greater than that. Unless something can be done, either to get the use of last year's rules, or to get cars for the new ones, it is likely that road racing under "international" rules is near a conclusion. Even in the stock car races it is probable that the bore of the engines will be allowed to go slightly beyond 5.1 inches, perhaps to 5 1-4 or 5 1-2, but the stroke may be limited, or still another opening is secured through the use of a piston displacement sliding scale, so that designers may use almost any bore and stroke they desire, just so the total displacement remains under a certain limit.

The Long Island Motor Parkway is being continued, but little is heard about the Vanderbilt race, and it is hard to make any prediction about that event. So that it can be seen that instead of twenty-one road races in this country during the coming season, there are just three positively scheduled after one-quarter of the year has passed. There will undoubtedly be some kind of a race at Savannah, and it is likely that something will be raked up to take New Yorkers out to familiar scenes around Garden City, Jericho and the parkway. This will give, then, only four high-speed contests. At the same time endurance runs and reliability contests are increasing in number, and it is not at all unlikely that last year's figures of 29 runs with 676 entries, will be exceeded. Still another prospect appears, that of increased track racing over courses built especially for automobiles. Indiana is going to have a real racecourse.



Tarascon, Cottin-Desgouttes, Rounding Curve of Cote de Bormes in Recent Hill Climb of Automobile Club of Toulon, France.



Photo by Drucker & Company, New York.

Third Annual Successful Banquet of the Aero Club of America, Held at Hotel St. Regis, New York City, Saturday Night, March 20.

FROM autoing to aeronautics is but a step, and the fact was accentuated again at the third annual banquet of the Aero Club of America, held on the evening of March 20 at the Hotel St. Regis, in New York City. With Cortlandt Field Bishop at the toastmaster's place, and other such well-known autoists as Jefferson de Mont Thompson, Robert Lee Morrell, Peter Cooper Hewitt, Colonel John Jacob Astor, William McAdoo, Robert Graves, Charles J. Glidden, Alan R. Hawley, Dave H. Morris, Alfred Reeves, Augustus Post, Henry Sanderson, Dr. S. S. Wheeler, Waldron Williams, Dr. C. T. Adams, and a host of others in evidence, the occasion might have been transformed into an automobile function without the least embarrassment to the majority of those present.

Of course, the diners included a goodly number who possess distinctive aeronautical reputations, the prominent ones embracing Glenn H. Curtiss, of *June Bug* fame; Captain T. S. Baldwin, of dirigible airship excellence; A. M. Herring, whose new aeroplane is soon to have a government trial; Charles Levee, hero of many ascensions; Charles Walsh, who has gone aloft frequently, and Albert Triaca, who teaches aerial flight.

Captain Homer W. Hedge, who figured first as one of the active spirits in the formation of the Automobile Club of America and later did similar effective work in the organizing of the Aero Club of America, sat at the same table with Philip T. Dodge, president of the Engineers' Club, who took a keen interest in those speeches dealing with aerial advance.

An interesting exhibit at the dinner was the two large gold medals which the club will present to the Wright brothers upon their return to this country. The obverse sides show portraits of the brothers with an inscription giving their records:

"Orville Wright, Fort Meyer, 1 h. 14 min. 25 sec., Sept. 12, 1909."

"Wilbur Wright, Le Mans, 2 h. 18 min. 33 3-5 sec., Dec. 31, 1908."

The reverse sides show an exact miniature of the Wright aeroplane. These medals were designed by Victor D. Brenner

and cost \$2,000, being shown for the first time at the dinner. Replicas in silver and bronze have been struck and will be distributed among those who contributed to the medal fund.

Out in the lobby there was displayed a model of the Wright aeroplane. Over the guests' table hung a model of Baldwin's dirigible, while on the table itself reposed the *Scientific American* trophy which the *June Bug* won. The Lahm trophy also adorned the scene, and members were urged to go after it.

Among other things, President Bishop entertainingly said:

"When we started with the first banquet of this club three years ago it was a grave question whether we would be able to make the banquet an annual event. It looked as though we would have to wait several years for interest in aeronautics to grow in this country, but the attendance here to-night would seem to indicate that pretty nearly everybody now is interested, and in a serious way. A year ago I stood in this same place and made some predictions. I am happy to say that most of them have come true, and I may go a step further and say that developments have even outrun my prophecies. To-night I make the prediction that most of us here will live to see the Aero Club of America the strongest sporting club in the country."

Robert D. Davis, editor of *Munsey's Magazine*, supplied the humor of the evening. When Mr. Davis said that there was one thing about a flying machine that he was sure he should like, it brought forth spontaneous laughter. "When you get up in the air," said he, "and something breaks, nobody is going to come around and tell you how to fix it." Martin W. Littleton contributed the rhetorical fireworks, and James W. Osborne also indulged in the higher flights of oratory. Colonel Henry W. Sackett, of the Fulton-Hudson Celebration Commission, told of the preparations for that event, which will include a \$10,000 aeronautical plum; and John E. Parsons described the air journey of Wilbur Wright in France which brought to the famous American the kingship of the heavens and some \$50,000. Then came the moving picture entertainment.

SAFETY AND UTILITY OF AUTOMOBILE STEERING SYSTEMS

By Thor. J. Fay Part III

MECHANICALLY, there are many things to take into account before it can be said that the steering equipment of an automobile will be up to a fitting standard, and it will interest the designer, the constructor, and the ultimate owner of the car, to go over steering details at some length, reviewing the several features, hoping thereby to gain an advantage. It has been shown how cars should be handled on the road, but the mechanical details are still unexplored.

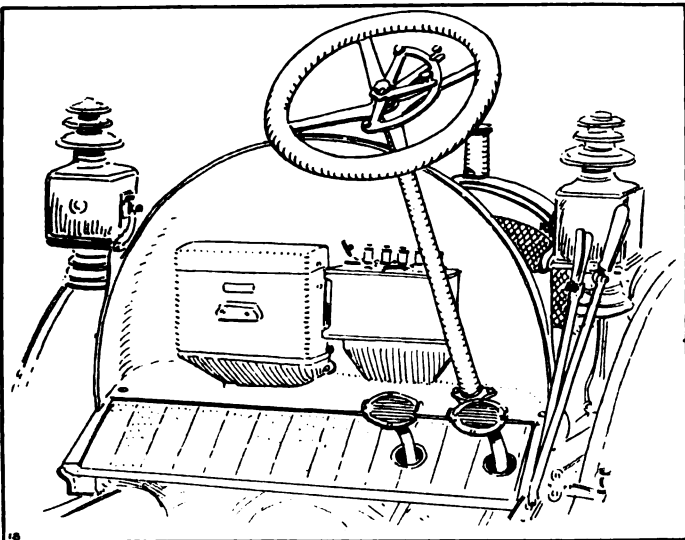

Fig. 18.—Characteristic steering wheel showing spark and throttle.

Familiar as the steering wheel is, even so, for the sake of completeness, it will be necessary to use illustrations, if clearness is to be a property of the text. Fig. 18 illustrates a typical steering wheel on its post showing the relation of the foot pedals, besides the spark and throttle levers mounted on the wheel. The wood rim of the wheel is oval instead of round, in order that the grip will be improved, and the hands will not fatigue so quickly as when the section of the wooden rim is round. The tilt of the wheel is usually such that the relation of the wheel to the driver's seat is as shown in Fig. 19, in which the distance from the seat to the rim is 9 inches.

The radius OB is usually about 28 inches, and, if the seat is less than 18 inches from the deck, which is the value allowed in the figure, the seat must move back so that the edge (front) of the seat will be bisected by the arc of the circle AC , in order that the radius OB will never be less than 28 inches, which seems to be the minimum allowable foot room. The tilt of the wheel will have to do with the strength of the column, provided the wheel is in the vertical plane, as shown in Fig. 20, for trucks, and the strains will be in the nature of bending moments. If the wheel is not strong and well braced it is likely to cause trouble, since the pressure will cause the same to bend. In the same figure it is shown that the tilt of the wheel, as it is designated for roadsters, affords the greatest advantage, since the work comes on as in a column. Likewise the figure shows the tilt of wheel columns for touring cars in which the moments are partially in bending, and the balance as in a column.

Lateral Location of the Steering Wheel.—Equestrians, when they mount a horse, with a view to experiencing a long, hard ride, sit up straight, and avoid all tendencies such as will

cause curvature of the vertebra. In automobile work, owing to the overhang of the seats, it is not uncommon to observe that the steering wheel is not in the center of the driver's seat. The result is as might be expected; the driver is much fatigued in the course of a long ride, due to the ungainly position which he is compelled to assume, and Fig. 21 shows the approximate dimensions of the driver's seat as it obtains in some of the well-designed cars, in which it will be observed that the steering wheel is in the center of the seat.

In some of the earlier designs of automobiles it was the practice to employ what is known as tilting wheels, placed for the purpose of enabling the driver to more readily leave the seat. This plan looked like a good theory, and for a time it was regarded as a regular thing in automobile work. In the long run, the best results were due to a rigid steering wheel, and it was also found that the anchorage of the steering column could not be too good. Fig. 22 illustrates the manner in which the steering post is passed through the footboard, and when the proper angle is ascertained the separate plate, which is sometimes in the shape of a flange, is bolted down to the footboard. It may seem unnecessary to go into details of placing of the steering column to this extent, but autoists are in a position to tell of the large number of cases extant, in which the steering posts were not securely fastened. There is nothing which will disturb the nerves of an autoist so much as a steering column that is not securely anchored, and, if the fastening at the footboard is insecure, the lower fastening at the chassis frame will ill serve the purpose.

The Vertical Steering Post in Truck Work.—If the steering column is vertical, as shown in Fig. 23, care must be exercised to have the tubing of good diameter substantially flanged at the deck, and it will be quite an advantage to have a brace, or tie, further up. In this case the motor is under the deck, which form of construction permits the builder of the truck to offer a larger platform for goods, without the excess overhang at the rear, which is so prone to influence the tire bill, for the reason that the rear wheels have to sustain under more than a fair share of the burden.

Having thus indicated the extent to which lost motion is undesirable, as this lost motion relates to a flimsy fastening of the steering column, it may be well to go on with the discussion of lost motion as it relates to the mechanism for steering.

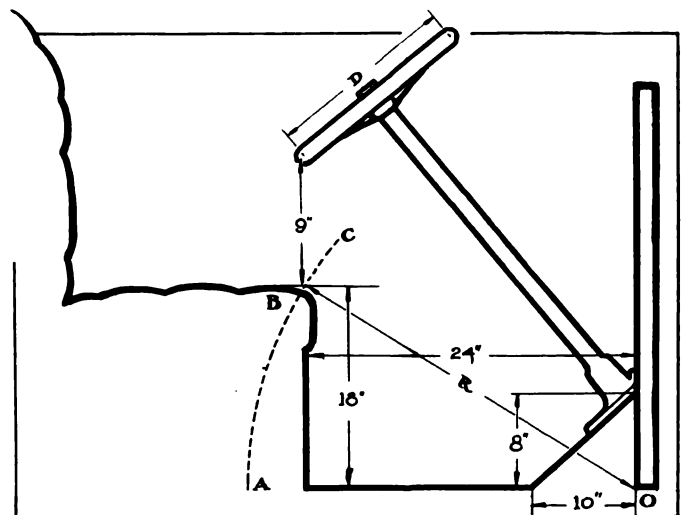

Fig. 19.—Showing height of steering wheel from driver's seat.

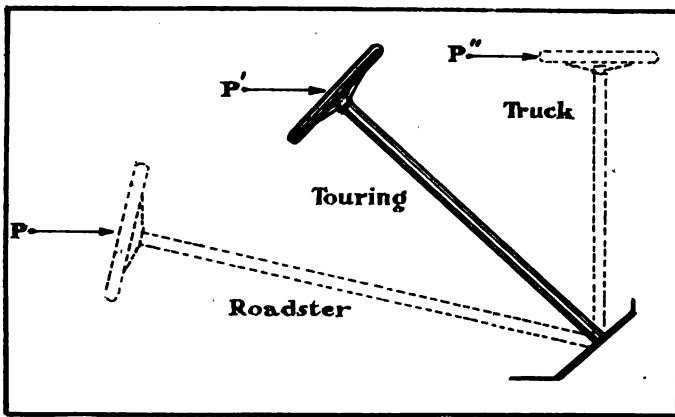

Fig. 20.—Indicating the advantages of tilt of steering columns.

Lost Motion in the Steering Mechanism.—There are three sources of lost motion in the mechanism as follows, *i. e.*:

- (a) In the reducing gearset of the steering post, due in some cases to inferior designing, and again if the gear is absolutely irreversible.
- (b) In the buffer spring placed in the dragrod for the express purpose of minimizing shock, hence requiring lost motion.
- (c) In the joints and bearings through the system.

Some lost motion must be tolerated, since it is even desirable, and in its absence the parts will be subject to shock components that will engender fatigue in the metal, which in turn will be rendered manifest by crystalline (structural) formations in the body of the same. As an illustration of this crystalline growth, it is fair to call attention to the practice of annealing crane-chains at least once a year, for the express purpose of correcting the structure, rendered crystalline in regular service by the series of little shocks due to the chain rolling over the drum, under strain, which shocks are intensified by the unevenness of the links which bump against the periphery of the drum. It is the series of little shocks that have to be feared, as they abound in the steering system, in the cases in which no provision is made to dampen them. A spring, placed in the dragrod, in the manner shown in Fig. 24-a, will afford the dampening effect, but it is at the expense of some lost motion.

In order to have the dampening effect of the spring without excess lost motion it is necessary to include considerable stiffness and few turns. It is not desirable to have the steering interfered with, as it will be if a spring of many turns is used, and if the section of the spring is such that but little pressure will be required to compress the same. The spring shown in the section, Fig. 24-a, is made from square wire of a fine grade of spring

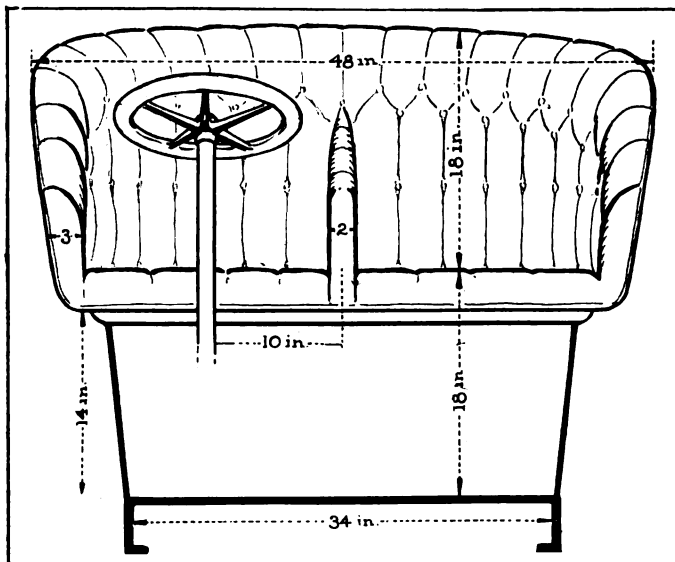

Fig. 21.—Illustrating the right lateral position of steering column.

steel, and, with four turns of the wire, the amount of play is reduced to very little, even under the most severe conditions of pressure. Even so, it is due to this stout spring that the metal in the steering parts will sustain in service, and a crystalline structure will be avoided.

Incidentally, and while the matter is on the tapis, it will be well to point out the manner in which brazing is avoided, in the process of assembling the dragrod, which details are also applicable to the tierod. Fig. 24-b shows the exterior appearance of the structure, and, as will be observed, the tube is threaded to receive the socket forgings, which does not prevent reinforcing the tubing at the ends, near the socket forgings, if the tubing used is thin. This operation can be avoided if the tubing is made thick enough to afford an adequate wall, despite the thread.

In automobile work it has been well demonstrated that nuts and studs will back off even if the thread is fine, and despite the use of tapers, or if the thread is a tight fit. Nuts have to be locked on, and in the case of the drag and tierods, in the steering system, it is necessary, nay, imperative, to relieve the situation of all risk, which can only be done if the locking question is extended almost to the extreme. Fig 24-a shows the manner in which the socket forgings are split, and how a clamping bolt takes care of the locking, which clamping bolt is, in turn, prevented from drifting off since castellated nuts are used, in which cotter-pins are placed to keep the nuts from backing off.

In this case the buffer spring is provided with a means of reducing the lost motion. If the spring is found to be too weak, adjustment is by means of a stud, with a locknut in the end of the socket forging, as depicted in Fig. 24. The socket faces are hardened, and the ball is also treated to render it hard. In this way the wear on the ball and sockets falls off to a minimum, and adjustment comes only at long intervals. Fig. 25 indicates the need of a fairly heavy section in crankarms (level-arms), and, since the ball generally comes at right angles to the axis, it will be well to take up the detail involving the hardening process.

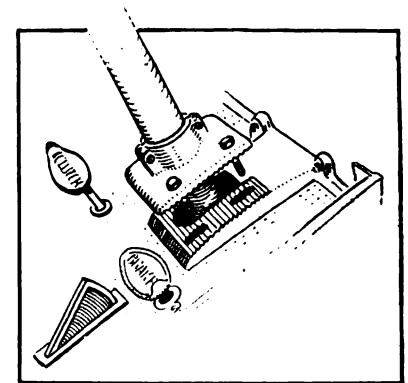

Fig. 22.—Bolting flange for column at footboard.

Quick Methods of Hardening Fail in Service.—Heating a part to a red heat (or any other heat), and applying cyanide of potassium, will not grow a depth of carbon sufficient to be of any avail, on the ground that the time required for the penetration of carbon is greater than that which will obtain in the process as here suggested. Fig. 26 shows the rate of penetration of carbon in steel if the heat of cementation is 850 degrees centigrade, on the one hand, and 1,000 degrees centigrade on the other. If a piece of cementing steel is raised to 850 degrees centigrade, and if the same is packed in cementing material, the curve shows that it will take slightly more than 4 hours to grow a depth of carbon of 0.030 inch. If the same steel is heated to 1,000 degrees centigrade, the depth of carbon will increase to slightly over 0.050 inch, but if the heat is applied for a few moments, as it is in the cyaniding process, sometimes adopted in shops, it is assured that the depth of carbon will be but slight, say, 0.005 inch. This depth of the carbon, in density sufficient to assure that the surface will quench to hardness, is not enough to be of any service. In the meantime, taking into account the importance of the parts, such as the steering crank, which, it will be remembered, has to sustain under severe conditions, and considering the neck, under the ball, of small section, it is extremely dangerous to cement the same at high temperatures, and 900 degrees centigrade is probably the safe limit, allowing that the steel will be of a suitable grade. Owners of cars will find it to their ad-

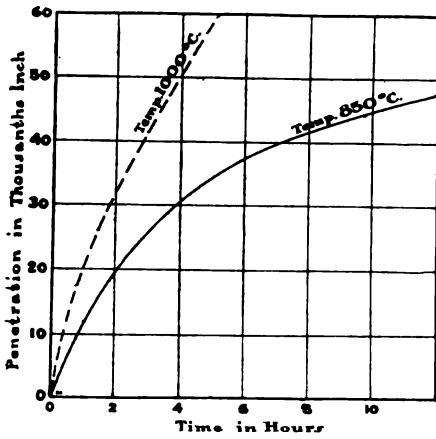

Fig. 26.—Curve showing penetration of carbon in cementing steel, in given time.

vantage to look into this phase of the question before they allow any repairs to be made, if the repairs have to include heat treatment of the steering crank or like parts.

If the ball and sockets are not hardened in a suitable manner, it will be but a short time before the ball will wear down to an elliptic shape, and lost motion will be present in consequence.

All along the line this question will crop out, and it is the accumulation of little increments of lost motion that, added up, renders steering so disagreeable, if not unsafe, that autoing becomes quite out of the question. If lost motion follows in the cases involving inferior hardening of the bearing surfaces, securing the cranks to their respective shafts will lead to additional trouble of the most disagreeable sort if the work is not well done. Figs. 27-a and 27-b show one way in which the cranks are secured to the shafts with a view to eliminating trouble. In this case the crank is fitted in a taper, and the clamping bolt cuts through the shaft in the manner shown at *a* and *a'* to prevent the crank from floating off of the shaft, even if the nut *b* should come off. The nut is used to pull the crank up on the taper, and the key *c* is for the purpose of preventing the shaft from rotating in the hub of the crank.

A second method is sometimes used, in which the clamping

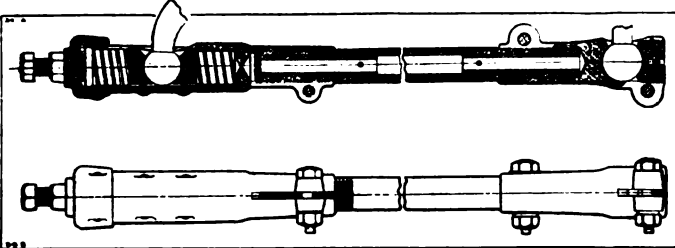

Fig. 24.—Section and plan of drag-rod, and manner of placing bumper spring.

bolt, shown in Fig. 27, is excluded, and Fig. 28 illustrates the point. In this case it will be observed that the crank is drawn up on a taper, and is prevented from drifting off by the nut used to draw the hub up on the shaft. The square shaft, as shown in Fig. 29, is much used, and if the work is well executed the scheme has the merit of serving well for the purpose. In this case the clamping bolt keeps the crank from floating off of the shaft, and if the bolt is drawn up tight there is small danger of lost motion.

It must be remembered that the clamping bolt is required to sustain under quite severe pressure, and that it will elongate a little at first is generally true. Under the circumstances it is necessary to take up on the bolt after a car has seen a little service, and it will be the height of folly to apply a long-armed monkey-wrench to the nut and pull until the bolt is partially twisted off, for, in all truth, it will come off of its own accord the very next day, and it cannot be said that the incident will transpire under the most favorable conditions.

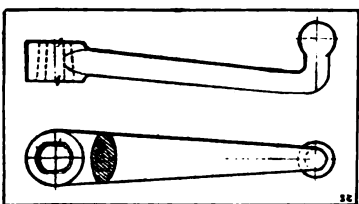

Fig. 25.—Steering wheel crank of usual form, with curved neck.

Care and Maintenance of the System.—It is unfortunate that all the

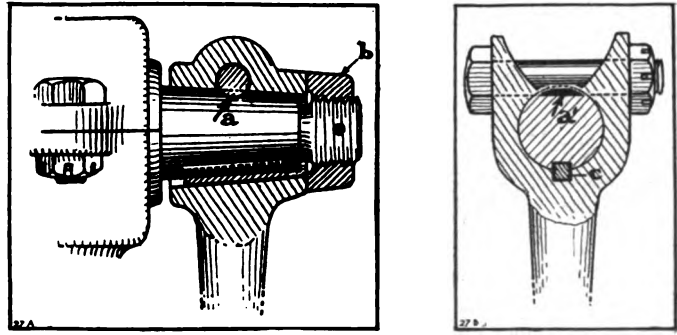

Fig. 27.—Longitudinal and cross-section of steering crank.

joints in the steering system have to be exposed to the dust of the road, and to such mud accumulations as are bound to splash up, and on the parts when the going is bad. But this is all the more reason why the system should receive every possible care, and if leather protectors are not used, as they should be, it is necessary to clean out the joints at frequent intervals, apply hard grease to the surfaces, and pack the same into the cavities, on the theory that when the grease is in, the dirt is out. If the links and levers are so placed that they will be high off of the ground, in the manner as shown in Fig. 30, the amount of attention required will be a minimum, and the parts will be protected from damage due to a road obstruction to the maximum degree. In town work this is not so important, and as a rule the systems are so nicely devised that little is left to discuss. In touring work on unimproved roadways, however, it is with a fine sense of feeling that the location of the parts for steering are discovered up, out of harm's way.

There is still one unexplored field in which lost motion can become a serious factor, and in which repairs are serious to contemplate. This lies in the gearset in the steering system, the prime function of which is to enable the driver to steer the car, on a basis of safety, taking into account the angle of cant of the road wheels for a given rotation of the steering wheel. In most cars it is the practice to rotate the steering wheel $1\frac{1}{2}$ revolutions in order to cant the road wheels the whole (combined) angle, and, considering some of the smaller cars, it is not uncommon to find that the combined angle of cant of the road wheels will follow one revolution of the wheel. Lost motion adds to the revolution of the steering wheel and introduces a lag in the response of the same, which becomes dangerous, if the amount is overmuch.

If the steering gear is absolutely irreversible, it is because the worm and sector in the gearset is cut to such a low angle as to

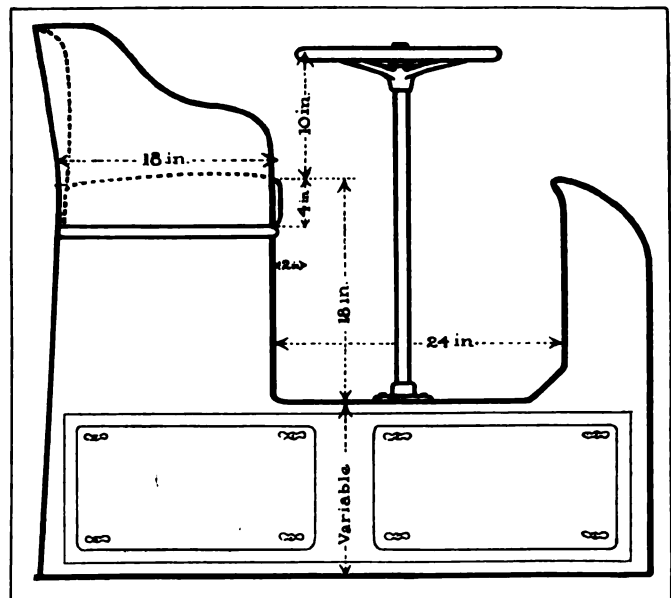

Fig. 23.—Vertical steering column used on certain classes of trucks.

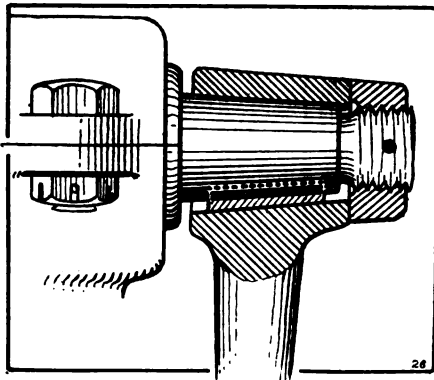

Fig. 28.—Common form of fastening of steering crank to the shaft.

render the same capable of responding in one way only. If the angle of the thread is about 10 degrees, the gear will hold to the irreversible principle, and since it is true that the movement of the wheel will then be a maximum, considering the resultant cant of the road wheels, it follows that lost motion will be the more

noticeable. The best practice is in favor of such an angle as will make the gearset nearly irreversible, which angle is about 12 degrees, referring, of course, to the worm and sector types of gearsets.

In the screw and nut types there is the same condition to be met, but it is disposed of in quite a different manner, as will be shown at the proper time. If the system is absolutely irreversible

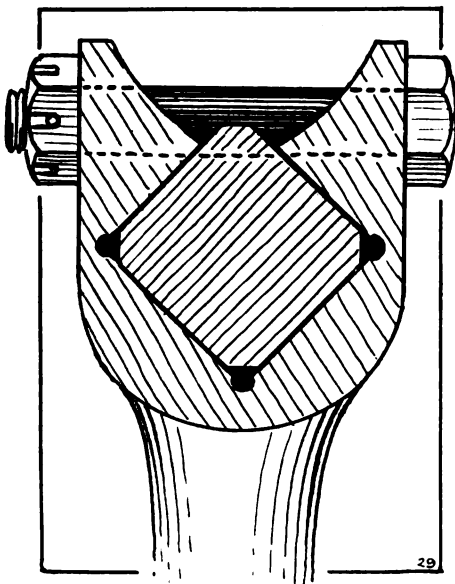

Fig. 29.—Conventional form of square shaft, illustrating means of clamping crank securely.

great strains will be put on the members when the road wheels strike an obstruction such as will produce a reaction in the gearset. The very fact that a system is irreversible is proof of the blow which can be struck, and the damage may result, since, if there is a limit to the "give," there is almost no limit to the effect of the blow.

If the system is not absolutely irreversible, then, when a blow is struck, utilizing the road wheels to transmit the energy of the same, the lack of rigidity will soften the effect of the blow, and the system will thrive without the presence of any factor such as would react against the same. Absolute irreversibility then is not wanted, and a little lost motion is better than none at all.

(To be continued.)

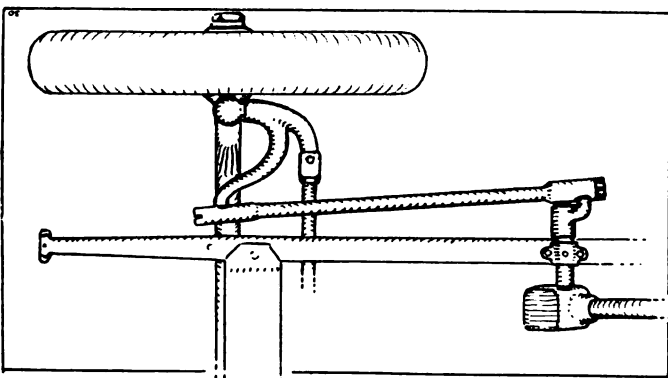

Fig. 30.—Plan by which the steering arms and links are connected.

ALUMINUM SOLDERING EXTREMELY DIFFICULT.

FREQUENTLY the question is asked, What is a good solder with which to solder aluminum? Generally the answer is, There is no good solder for the purpose. The "inhabitant in the woodpile" belongs to the genera which will respond to treatment in relation to which soldering is but a detail. Aluminum cannot be soldered in the ordinary way, and the failures which are made in the attempt are due to lack of appreciation of the difficulties encountered.

The general properties of aluminum are as follows:

- Specific gravity.....2.6 to 3.00
- Atomic weight (pure).....27.1
- Melting point (pure).....1160° F.

The aluminum alloys with which the automobilist has to deal hold about 90 per cent. aluminum and the balance is copper, manganese, zinc, and a trace of iron. The proportions of the alloying elements differ in the respective specimens, and as a result the characteristics reflect the differences. On the whole, however, the soldering problem, so called, will be very much the same, because the aluminum is in so much presence that it is the characteristics of this strange metal that will have to be coped with.

Primarily, aluminum on account of its low melting point, will not stand prolonged heating, as the case with copper, which is perfectly amenable to the soldering process. Then, aluminum suddenly "wilts" under the heat application, hence it requires careful treatment or it will be placed beyond the pale of soldering if it is to return to its original shape.

Fluxing and tinning is the process which renders soldering easy under ordinary conditions, and it is because aluminum will not mind this process that half of the trouble is experienced. It is fortunately a fact that zinc has a slight tendency to flow, and if the surfaces are clean and dry the chances of being able to make a fairly satisfactory repair will be eminent, provided the solder used is with zinc in pronounced quantity, alloyed with tin, and since aluminum is capable of entering into the solder it will be possible to use a slight amount of the same with a view to aiding in the process.

But since it is quite out of the question to keep aluminum surfaces clean enough to sustain a "tinning" process, even for a short period of time, it is plain to be seen that the addition of aluminum to the solder in any considerable quantity will tend to the very trouble which makes the operation so very difficult. The solder, then, must hold but a trace of aluminum. Even with solder of the character as above outlined, it will still be difficult to accomplish the task in the absence of due preparation of the parts to be soldered.

Since dampness is the bane of the process, assuming the surfaces are properly prepared, the safe method of proceeding will include the drying of all the surfaces, as well as the solder; this can be done in an oven at a temperature almost high enough to melt the solder. When the parts are dry and held at the drying heat, the next thing to do is to scratch the surfaces so vigorously with a metal brush as to bring out the real untarnished virgin metal, thus removing all traces of oxide.

The next process will include heating the metal to a point above the melting point of the solder, and after applying the solder to the surfaces actually brush it into intimate relation with the metal brush. If the solder refuses to adhere to the aluminum surfaces it is because the oxide is still present in sufficient quantity to defeat the aim. When the surfaces to be joined are well coated with the solder it will be a simple process to join them under the heat, high enough to melt the solder, and from that point on all the rules of ordinary soldering work will apply.

What is wanted for the purpose of heating is a good bunsen burner, although it is possible to do a fairly good-sized job with a good blow-torch; soldering irons are valueless for the work. Finally, it is necessary to perform the operations with dispatch. The surfaces must not only be cleaned as stated, but they must be free from aluminum oxide as well.

ECONOMY RESULTS FROM UNDERSTANDING ACETYLENE

EFFECTIVE lighting is quite as necessary as a good automobile if one desires to travel under pleasurable conditions and if safety is to be present on the journey. Without attempting to compare the respective methods of lighting in vogue, it will be the aim to discuss the phases of lighting by means of acetylene, with particular reference to the calcium carbide used in the process. The first cost of the material is something to consider, but it is unfortunately true that the lighting will fail if the use of carbide is not attended with proper conditions.

Acetylene is produced by dissolving calcium carbide in water just as salt is dissolved, excepting that the carbide does more than salt, in that it combines with the water in such a way as to produce acetylene gas, the chemical formula of which is C_2H_2 , and the residuum of which is slaked lime, for the most part. True, "commercial" calcium carbide is not chemically pure, and it is for this reason that the residuum is not pure slaked lime, barring the chance of introducing impurities, such as may reside in the water that is put into the generator for the purpose of making the gas.

That all carbide is even up to a commercial standard of purity is scarcely to be believed, nor is it desirable to try to use the cheaper grades of carbide, since they are not nearly so good for the purpose, and there is the danger of clogging up the burners as well as the piping and such other constricted passageways as will be found in the average lighting system in automobile work. Then, there is the question of the deterioration of the generator to be considered if the carbide is not pure, since corrosion may follow the use of the inferior grades.

Heat Is Generated When the Gas Is Formed.—A crude diagram of the generator is that depicted in Fig. 1, which has the advantage of simplicity and saves complication, thus rendering explanation free of extraneous detail. As will be observed in the figure, the carbide is placed in the chamber C and water is put in the chamber A. The water is free to drip through the passageway E into the middle chamber B. When the water fills the middle chamber up to the top of the pipe F it will pass down through the same to the carbide in the chamber C. When the water contacts with the carbide, gas will form, and when the pressure of the gas equals the water pressure, due to the head of water, the water will cease to flow because a condition of balance will then obtain. Upon opening the cock D the gas will be free to flow to the burner G. If the gas as it flows out of the burner, due to the pressure from the water "head," is contacted with a flame, as a lighted match, the gas will burn. In the meantime the pressure in the chamber B will fall and more water will then flow through to the carbide and the gas supply will be maintained. The process will also be attended by the generation of heat in the carbide and steam will form sufficiently to cause considerable condensation in the piping system, which, together with such other formations as may abound in the piping, makes for trouble before the system is very long in service unless provision is made to guard against it.

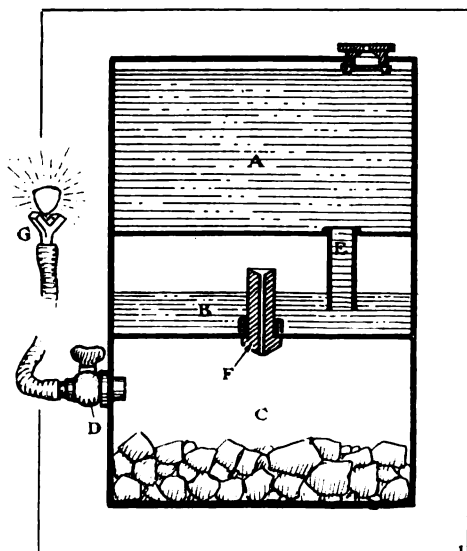
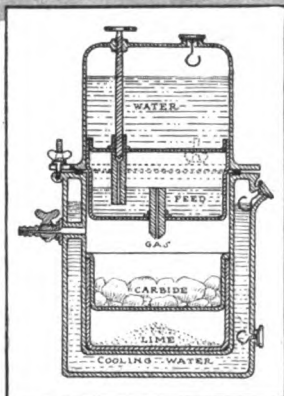

Fig. 1.—Characteristic illustration of automatic carbide generator.

Overheating is likely to be the source of considerable trouble, for the reason that, besides the impurities which will abound in the carbide under normal conditions, the excess heat will introduce activities that will result in soot, and products of a tarry nature will clog up the burners. The presence of this tarry residuum, coke, and, in fine, carbon in any form, will induce further additions of the same materials, since it seems to be the property of carbon under these conditions to augment the process.

The soot and tarry residuum which collect on the burner will adhere to the surfaces with a tenacity which will resist all attempts to dislodge the same, and the burners so incumbered will fail to perform further in a satisfactory way. The temperature at which this tarry residuum is formed is that which will form coke, as an outside figure, and the trouble begins at a temperature as low as 500 degrees Fahrenheit, which is easily reached in an ill-devised system of lighting.

Commercial Form of Calcium Carbide.—This base of acetylene is made in the electric furnace from raw materials consisting of lime and coke and the temperature of fusing is from 5,000 to 7,000 degrees Fahrenheit. The fused carbide is then crushed and the several sizes are selected out in a manner unlike that which is used in the grading of coal. The grades are known as follows:

- Lump**, which consists of large sizes of carbide, ranging between 3 1-2 and 2 inches.
- Egg**, which is a medium-sized product, ranging between 2 and 1-2 inches.
- Nut**, such as will serve in carbide feed machines, ranging between 1 1-4 and 1-2 inches.
- Quarter**, which is the small pieces with dust removed, ranging between 1-2 and 1-4 inches.

Chemically pure carbide can be made in small quantities, but in the regular process, in which the carbide is made on a large scale, it is the "commercial" grades that are produced, and, as a rule, they are quite free from such impurities as will lead to excess trouble. The color of the "commercial" carbide is a dark brown, verging into the gray. There are grades of the carbide which are black with a red cast or strain. Carbide is hard and brittle, hence it lends itself to the process by which it is crushed and very little of the carbide goes to waste.

Calcium carbide is deliquescent, and to preserve its qualities it must be kept in tight packages so that water will not be absorbed by it, thus reducing its ability to form acetylene. It comes in tight drums in various sizes, and care should be exercised in its storage, since it will add flame to a fire if water is allowed to come into contact with it. As a matter of fact, the insurance regulations as they relate to this material are so very stringent that they preclude the right to keep even small quantities in insured structures without a permit.

Acetylene Burners Have Special Forms.—For burning coal or water gas the burners are of the "fan" shape, in

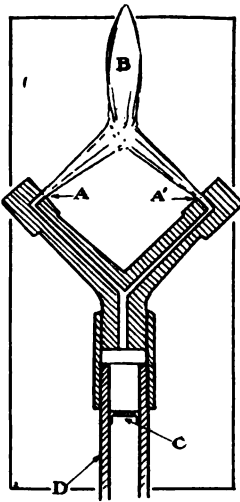

Fig. 2.—Section of acetylene generator.

which the orifice is in the form of a narrow aperture, and the amount of gas which will pass under the usual pressure, which is about that due to 4 inches of water, ranges from 3 to 5 cubic feet per hour. This is vastly more than is required in acetylene lighting, and besides the burners have to be so devised that too much heat will not be in evidence, and it is also desirable to arrange the aperture that the gas as it flows out will be well intermingled with atmospheric air to assure complete combustion and to abort the formation of soot.

The life of the burner depends upon how cool it keeps and upon the purity of the gas as it flows through the same. Fig 2 shows a characteristic form of acetylene burner in which *A* and *A'* are two small holes in the cheeks of

the two prongs of the burners, producing the flame *B*, which rises above the burner, thus serving to bring the flame into the right relation to the mirror lens in the searchlight as well as keeping the burner as cool as possible. The screen *C* serves as a safety and to keep impurities out of the small holes in the burner. The tube *D* is a sleeve fit for the burner.

Acetylene requires about 12 1-2 parts of atmospheric air to one of acetylene for complete combustion, and it follows that every provision must be made to afford the requisite quantity of air if it is desired to prevent the burner from clogging and if the light is to be steady and bright, which is an absolutely essential incidental of the process from the economic point of view.

In actual practice it is not so much the candlepower of the light as it is a question of a short focus, and a symmetrical concentrated beam of light can only follow if the gas is burned in a burner of the right shape under the conditions in which the flame is steady and white. In order to be sure that the gas will be pure and in fettle to give the best result it is necessary to keep the pipes drained and clean. This is only possible if the piping is large enough to stand handling, and if it is so placed that it will drain to a low point, at which level a cock should be placed in order to be able to drain off the liquid accumulations.

The generator, should be so designed as to afford an adequate supply at the right pressure, cool and free from soot, sand, tar and steam. This will be true if the generator is big enough for the work and if provision is made to scrub, cool and purify the gas as it is delivered into the piping system. In the meantime it is well to take into account that water in the generator, either to cool the same or for use in dissolving the carbide, will freeze in cold weather and care must be exercised to maintain the same below the freezing point unless calcium chloride is used in the system for the purpose of preventing freezing from taking place.

If calcium chloride is used for the purpose it must be chemically pure, and it should then be lined slightly to remove any acidity which may be in its composition. Fig. 3 is a curve of the freezing point of various compositions of calcium chloride in water, and, as a general rule, the less of the chloride used the better, all things considered. If the generator is water-jacketed it will be possible to use glycerine and water in this part of the same in the proportions of 3 parts water to 1 part glycerine, which will afford immunity, unless the weather is extremely severe. If zero weather is to be encountered it is only necessary to add more glycerine and a half-and-half mixture will be the limit. In so far as the water in the tank proper is concerned, the best plan is not to have it there until the lights are in actual demand, and it will be easy enough to add water out of the cooler system of the power plant, just when the lights are to

be put into service. If the water is a little hot it will be well to allow it to cool off, although it will soon get hot in the carbide generator, as a result of the heating which accompanies the dissolving of the carbide.

Under no circumstances should the "sludge," which is the lime (residuum of the dissolved carbide), be allowed to stay in the generator after the lights are turned off finally for the day. It takes no longer to clean out the generator one time than another, and the generator will fall apart soon enough without hastening the process in this way. Such impurities as may reside in the carbide will do no harm until they are released by the water and allowed to float around in intimate contact with the surfaces of the generator. Electrolytic action is bound to take place, and in this process it takes but little time to reduce the generator to a state wherein it will make a better sieve than it will a generator. In contact with copper it has been found that a scale of an explosive nature forms, the character of which is not well established, although it is claimed that the formation is a carbide of copper. This formation is in small presence, and it has never been proven that it amounts to anything worthy of more than passing notice.

In conclusion, it will be proper to urge cleanliness and a full observance of the cautions which it has been the aim to spread out through this article, and if the generator is provided with valves, by means of which the water can be shut off, it will be well to keep them in good order, and use them for their intended purpose. Rubber piping serves very well indeed as the flexible connection for the piping, but it should be replaced when it is rendered *hors de combat*, and the joints should be kept tight lest the lighting will be poor, and it is also true that carbide costs enough to require that it be preserved.

The Piping Should Be Secured in Place.—In some of the cars, as they were put out in the past, it was the custom to allow the piping to go until the last, and in the hurried attempt to put it into place, after the completion of everything else, it was merely thrust into the chassis in a haphazard way, frequently without any attempt to fasten it into rigid relation, with the result that the joints would not stay tight. The pressure under which the gas is caused to flow to the lights is very little, and a small leak will suffice to put the lights out. With slipshod piping, and of small diameter, it is not to be expected that any good results will be experienced by the unfortunate owner of the car.

In view of the extreme importance of good lighting, and the utter impossibility of realizing the same if the piping is not fastened into place, it does look as if economies, if they must be practiced, should come from some other quarter. It would even be better for the purchaser to buy cars, less lamps, than to accept the lighting equipment if it is not installed in a proper and satisfactory way. Fortunately, the cars of the present day are in much better shape in this regard, and it only remains for owners to maintain the same.

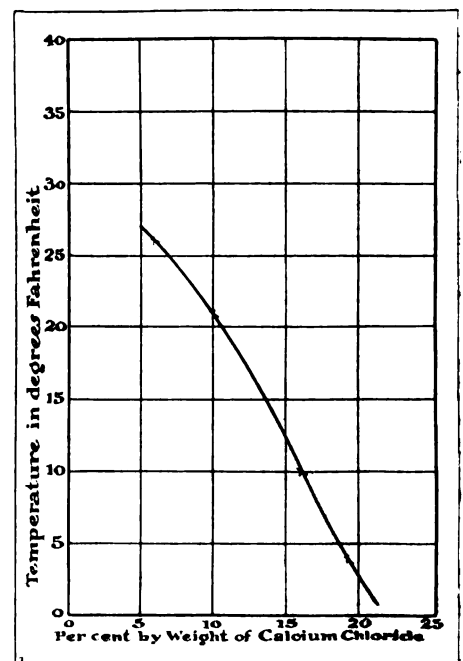
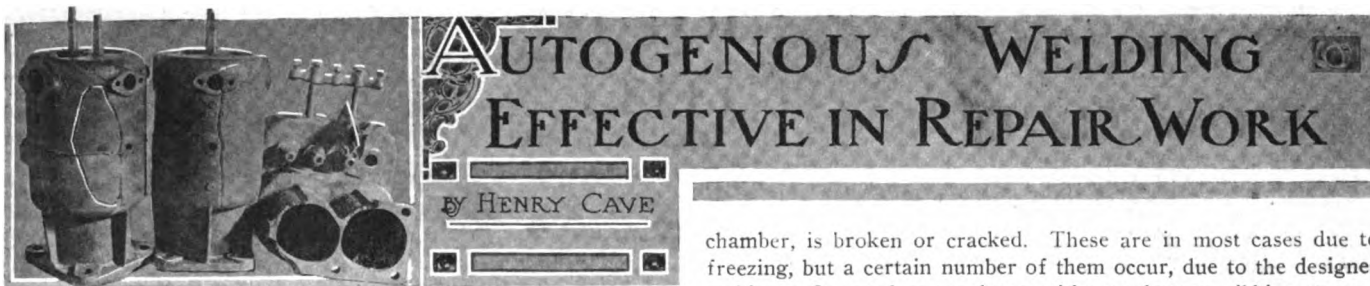

Fig. 3.—Chart of calcium carbide freezing temperatures.



AUTOGENOUS welding is proving a great boon to those who are unfortunate enough to have their cylinders broken, as they can be satisfactorily welded, and in the majority of cases, with a little trimming off, the repair will not show. In fact, some people require this, as they wish to sell their cars without the fact of the repair having been made being noticed. Cylinders with cracks are sometimes brazed, but, owing to it being necessary to heat the whole cylinder to a good red heat to even up the contraction strains, so as not to crack when cooling, the bore of the cylinder is generally warped, the job requiring a lot of finishing as the spelter and flux spreads considerably and is hard to remove. Also, owing to dirt and rust being deposited in the crack, it is difficult to get a braze below the surface. The heat used will sometimes crack the cylinder somewhere else.

Many Broken Water Jackets Traced to Freezing.—Cylinder breakage is due to carelessness or misfortune, probably in most cases the former, since, allowing the water in the jacket to freeze up, results in a fracture of the water-jacket wall. This cannot always be termed carelessness, as I have known an automobile to have all its water jackets cracked as early as the middle of October, when the owner had no thought of such a thing being possible. I have also known of cars being "hung up" on the road in cold weather, the driver opening the drain cocks before he left to summons help, upon his return found the water frozen with the usual results, this probably being due to too small drain cocks. Also, it is quite frequently the case that when shipping a car by rail in winter time the drain cocks will be opened, but due to some pocket in the water system (in some cases very small ones), which did not drain, the cylinders have become fit subjects for the autogeneous welder.

Curiously enough, the majority of cylinders cast from the same patterns will break in just the same place when frozen up. In a number of cases the break causes a piece of the wall of the water jacket to be entirely detached, and the breaks occur so near alike, in similar cylinders, that it would be possible to take the detached piece from one and weld it into another, even the smaller irregularities coinciding.

When a break of this nature is autogenously welded, by means of the oxy-acetylene flame, the crack or edge of the broken part is prepared so as to leave a groove nearly through the metal. The whole part is then heated to about 500 degrees, uniformly. This is not enough to warp the bore, as has been repeatedly proven by careful measurements before and after treatment. The sides of the groove are fused together and filled from a rod of cast-iron, the resulting weld being very neat in appearance, not generally requiring any finishing, and is as strong as the original wall.

Breakages Traced to Defective Designing.—The next class of breakages, in order of frequency of occurrence, are those in which the wall of the cylinder, combustion or valve

chamber, is broken or cracked. These are in most cases due to freezing, but a certain number of them occur, due to the designer making a flat surface too large without adequate ribbing to support the intermittent pressure of the explosion.

Another case is the breakage of the connecting rod, allowing the piston to strike the top of the cylinder. Damage due to this cause occurs more frequently in two-cycle engines as the deflector on the piston readily punches a hole in the combustion chamber wall. This kind of break also often occurs, due to foreign substances, such as the head of a broken valve getting between the piston and the cylinder head. This class of breakages are the most difficult to repair, as it is necessary in most cases to cut a section of the water jacket to be able to work on the inner wall, the only deviation occurring when the break happens to be opposite a large hand hole. This operation could be well called "laparotomy," from an operation performed on the human body.

It can readily be seen that it is impossible to save cylinders when the break occurs between a pair, or behind the valve chamber, as it is impossible to reach these parts with this small flame. If the crack occurs in the bore it is necessary to be careful to weld only to within a sixteenth of an inch of the bore, or the finished surface will be spoiled, the crack left in this way being of small importance. Sufficient metal is built on the outside so that there is no doubt about the strength. After welding the break, the section of the water jacket which was removed is welded back in place.

Some Skill and Judgment Required in the Process.—As it is often impossible to determine the length or exact locality of the cracks before cutting away the jacket, and it is desirable to remove as small a section as possible, it is found necessary to cut additional pieces out, necessitating welding a number of small pieces back in place when finishing the job. This is sometimes impossible, and a sheet steel substitute must be hammered out and welded in place. The next series of breakages, in point of number, are those in which all, or a portion of the flange which holds the cylinder to the crankcase, is broken away, either due to there being insufficient metal to withstand the strain or to carelessness in assembling. These breakages occur in two ways: the wall of the cylinder may be broken away, or part of the flange may be cracked off. In the latter case it is an easy matter to make the repair, but when the break runs through into the bore of the cylinder, considerable care is required, it being first necessary to consider whether it is desirable to weld in the bore, which would then require machining, or, at any rate, filing out, as against a groove, and weld from the outside, to within a sixteenth of an inch of the face, sufficient metal being added to the outside to insure ample strength. This, of course, leaves the crack on the inside, which, however, can be smoothed down, and is not objectionable for a repair job, not interfering with the satisfactory operation of the motor in any way, providing a man of fair skill takes into account the Davis-Bourbonville system of autogeneous welding, used by the Autogenous Welding Equipment Company, of which I am the president.



AUTOMOBILE COOLING SYSTEMS ANALYZED

BY MORRIS A. HALL

PART II

THERE are two methods of fluid circulation, the so-called natural method and the forced process. Leaving the former for the present, the forced circulation of the fluid may be accomplished by the use of a pump. These are, generally speaking, of two kinds, the rotating and the reciprocating. In the rotating class there are three further sub-divisions, the vane type, the centrifugal style and the gear pump. The other class is not so diversified in that there are no further divisions, the plunger type being the only reciprocating pump used.

Analysis of the Various Types—The Plunger.—Without going into the efficiency of the various classes, the plunger type is not popular because of the nature of its action, making it noisy. To get a large volume of water from this type it must be of a very large diameter, have a long stroke or run at an exceedingly high rate of speed. The first and second make a very large and consequently heavy outfit. The last will not have these faults, but in starting large bodies of water, always an immobile liquid, from rest to a high velocity in a short space of time, will consume a great deal of power. In use, however, the smaller sizes are very satisfactory for motor work, as the writer can testify. An additional point against this form is the inertia of the moving parts of the pump itself and entirely independent of the volume of liquid moved. This inertia is defined as that property of a body, by virtue of which it tends to continue in the state of rest or motion (in which it may be placed) until acted on by some external force. It is therefore a function of the motion and the velocity, and the greater either one of these the greater will be the inertia.

As the weight of the moving parts increases, this becomes greater; similarly, with increased velocity, this increases. Water being very incompressible, a strong and therefore heavy piston is used to work it, from which it is easily deducible that the inertia is great. The idea previously advanced of the necessity

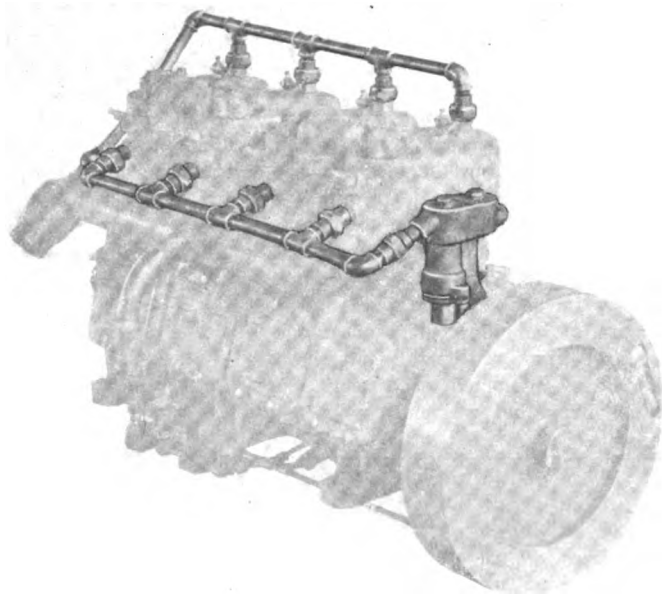

The Plunger Pump is Well Adapted to Marine Work.

of speed to produce quantity, bears this out, from all of which it is plain that the internal losses in this type are very high. Fig. 1 shows a four-cylinder engine equipped with a plunger pump driven by an eccentric on the prolongation of the camshaft. In the next figure, No. 2, the detailed construction of this is shown, from which will be noticed the angled valve seats, eccentric drive and other prominent features.

Advantages and Disadvantages of the Rotating Type of Pump.—The rotating form of liquid circulation is in common use, and without accurate detailed figures it would be impossible to say which one of the three forms enjoys the most popularity. The vane probably would be assigned the last position. As used, this consists of an eccentric, rotating within a cylindrical chamber, to one side of which the water has access. This eccentric carries on its axis a pair of sliding vanes, which give the type its name. As the eccentric rotates and sweeps out the volume of the fluid chamber, the vanes, by sliding back and forth in the rotor, maintain the tightness and prevent leakage. The springs which keep the vanes tight against the case really act as a stuffing box to retain the fluid, and upon the spring-tension depends the amount of "slip" and friction. Considering that there is not only the hydraulic loss to consider, but also the high friction loss, it is not strange that this form is not increasing. On the other hand, it has many friends. Fig. 3 shows the component parts of a pump of this type.

The available figures for one of the recent shows indicate that 25 makers using rotating pumps were divided as follows: Gear type, 8; centrifugal type, 18. This hardly indicates the relative popularity, for those who did not give figures are mostly classified with the former division.

The Gear Type Is Marked by Simplicity.—Taking up the gear pump, it is found to be simple to care for, simple in principle and cheap to manufacture. The essentials of this type consist of a pair of gears, a pair of shafts for them to rotate on and a case to house the gears, act as bearings for the shafts and convey the water to and from the gears in a proper manner. The gears may be and usually are of the same size, but this is not a necessity. It is a necessity, however, that they mesh correctly, so as to rotate together without grinding or unnecessary friction. This is effected by correct cutting of the teeth and exact spacing of the shaft centers. The shafts are usually straight pieces of round stock, preferably bright stock which is commonly called cold-rolled steel. Gear cutting is done on an automatic machine and many, or at least several, gears are cut at once. The case is a simple casting, with very little machine work on it, from all of which it is easily seen that the statement above as to manufacturing cost of this style of pump was not far-fetched nor an exaggeration.

In this case the losses must be low for two reasons: First, the frictional loss due to the movement of the water or fluid used and, second, the nature of the pump itself with its form of motion. To enlarge on the first, the liquid, as may be seen in Fig. 4, is not started and stopped with consequent high internal friction and power losses, but is led in a continuous stream around several easy curves. These, of course, entail some frictional losses, but they are as nothing compared to the same quantities in the previous case. The form of the rotor is such that it does not slide over or, in fact, touch the sides of the

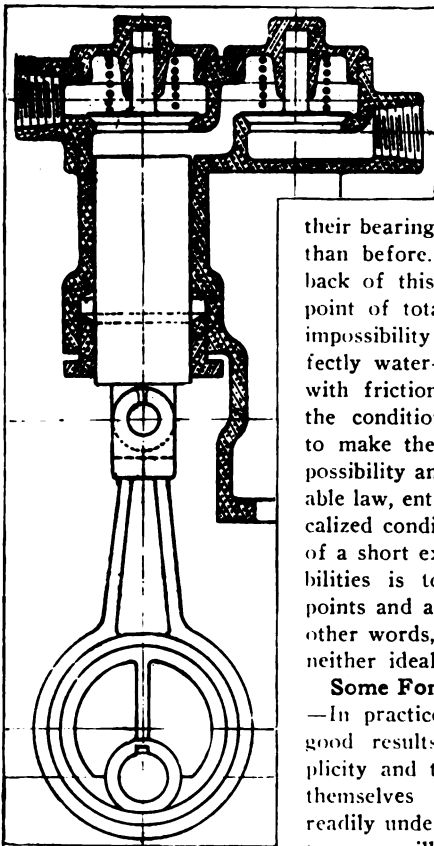

Fig. 2.—Plunger pump section

chamber within which it rotates. This at once eliminates the high friction losses due to that cause, and the efficiency of the shafts rotating in their bearings is but slightly greater than before. However, the drawback of this type from the standpoint of total efficiency lies in the impossibility of reconciling a perfectly water-tight rotating member with frictionless rotation. This is the condition which has operated to make the rotary engine an impossibility and is a fixed, unchangeable law, entirely independent of localized condition. The result, then, of a short excursion into the possibilities is to indicate some good points and a few shortcomings. In other words, this form is good, but neither ideal nor perfect.

Some Forms in Practical Work.

—In practice the gear pump gives good results because of its simplicity and the fact that the parts themselves and their action are readily understood. A few hints as to care will not be out of place. First of all, like all rotating bodies, the shaft bearings must be lubricated to reduce friction to its lowest terms. This sounds simple, but is not, for the fact is that the flowing fluid has a tendency to wash away the lubricant. For this reason alone oil will not do. It is too easily carried away by the water. Another reason is that the heat in the fluid, particularly after a prolonged run, is great and will rob the oil of its lubricating qualities. A lack of lubricant, allowing the bearings to heat, will have the effect of burning up oil when it is put in.

Now, to overcome this a substance must be used for pumps which will not burn out and will be so immobile or unchangeable in its form that the water can not alter it nor wash it away. Such a substance is hard grease, but care must be exercised in selecting it for its lack of mobility, else the purpose of its use will be defeated. Fig. 5 shows a cross-section of one of these pumps and also indicates an excellent method of lubricating the same. The gears, in order to keep them light, are cored out. In assembling, this interior space is filled with a grease, of the quality just described, which flows out through the hollow shaft to the bearings. In this manner the pump is self-lubricating, and by putting in the proper grease at the start the manufacturer is sure of the desired results.

Centrifugal Type Has Many Good Features.—The centrifugal type is perhaps the easiest of all to understand. It consists of a rotating member, which may or may not be integral with the driving shaft, and a case, usually for manufacturing convenience divided into two parts, the case and the cover. In operation this is rotated at a high speed, and the water entering at the center flows out the arms, and at the extremities is thrown off by centrifugal force. This throwing-off action is restricted by the case, so that the effect is to throw the water into the outlet pipe, which is but another way of saying that the velocity has been increased over what it was at first. That is, the speed of fluid circulation has been increased by the pump. This speed is predetermined in the design, and varies with different designers, an average figure much used in practice being the same speed as the crankshaft. This is convenient to use and in gear-cutting also.

This force acts in a straight line tangent to the circle of ro-

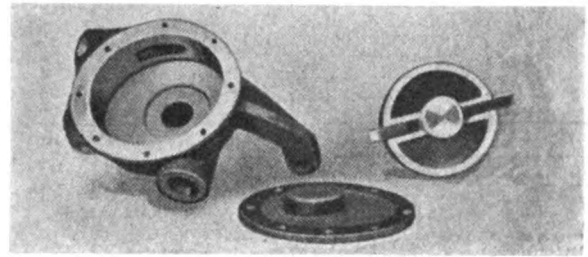

Fig. 3.—One form of vane pump, showing simplicity.

tation and can be very simply expressed. Thus:

$$(8) F = \frac{W v^2}{g R}$$

in which

F = the centrifugal force.

W = the weight of the rotating body in pounds.

v = the linear velocity of the center of gravity of the body in feet per second.

g = the force of gravity = 32.16.

R = the radius in feet of the path of rotation.

Of these, g is known to be a constant; the radius of the path R cannot vary, nor can the weight of the rotating body at any instant. Now, the velocity of rotation may for convenience be expressed in terms of the number of revolutions, thus:

$$(9) v = \frac{2 \pi R N}{60}$$

This introduced into equation (8) gives:

$$(10) F = \frac{4 \pi^2 N^2 R W}{3600 g} = \frac{W R N^2}{2933}$$

By removing the constant quantities in this, it may be simplified to:

$$(11) F = K N^2$$

This simple equation shows at a glance the advantage of the centrifugal type of pump and the condition necessary to obtain it. The centrifugal force F is the measure of the output, and this varies with the square of the number of revolutions. So, if a pump at 100 r.p.m. produces 2 gallons of water, the same at 400 will give 32 gallons, and at 800 the production will go up to a total of 128 gallons.

Fig. 6 shows the dissembled parts of a centrifugal pump and the outfit put together, ready for use. This gives an idea of the number and simplicity of the parts. In comparison with this is given Fig. 7, which shows a pump in position, with the water piping from it to the various cylinders and from these to the radiator, only a hose connection from the upper pipe to the top of the radiator and another from the bottom back to the pump

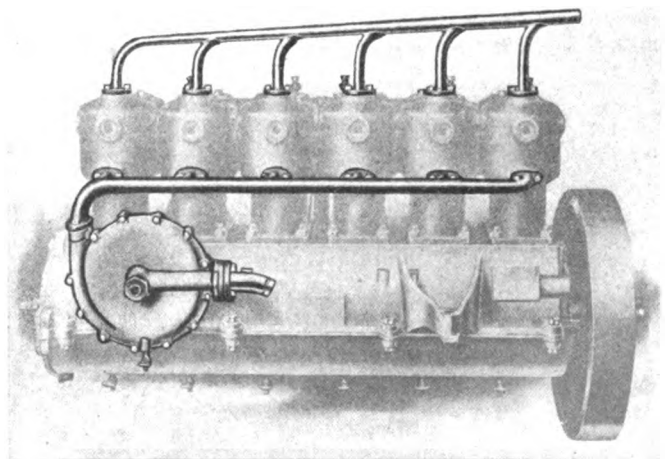

Fig. 7.—Centrifugal type applied to a "six."

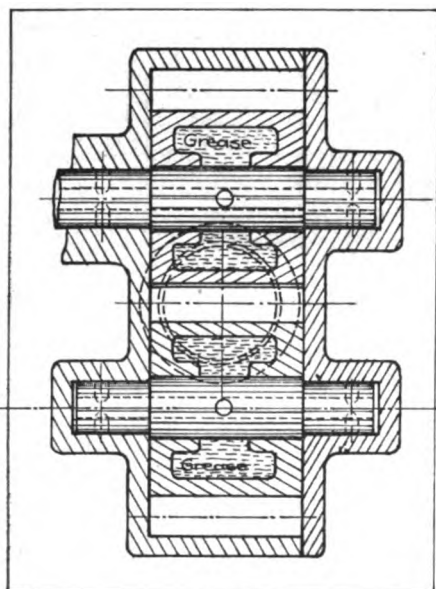

Fig. 5.—A simple lubrication method.

being necessary to complete the entire water circuit.

This figure also shows the variation in the size of pipes which accommodate more water as more flows in. On this point designers differ, but it seems reasonable, that an increase in quantity should call for an increased cross-section. As the quantity should be equal in each cylinder, the amount flowing is multiplied by the number of cylinders. Thus, in the case of a "six," the

area of the pipe at number six would be six times that at number one. That this does not mean as ugly a construction as one would think is shown by figures. Starting with a 7/16-inch diameter, six times this area is obtained in a 1-inch pipe.

Radiator Wipes Out Heat from Water.—Having covered briefly the subject of fluid circulation, and the means in common use for effecting it, it will be well to turn to the types and functions of the radiator. Going back to the subject of heat losses, a moment's thought shows that whatever heat is communicated to the water in the cylinder jacket, regardless of the means of moving this water around, must be wiped out by the radiator so that the water may be used over again. In a motor boat this necessity does not exist, for the same water is not used continuously, but flows away and is replaced by fresher and cooler water, the supply being unlimited. Now in the automobile engine the supply is not only limited, but, in addition, is reduced to its lowest terms. That is, as little water is used as will do the work and no more on account of its excessive weight.

In fact, the former practice of using a surge tank, to which the water flowed from the radiator and from which the pump drew its supply, has been entirely abandoned. One fact which was unknown at the time the tank was used, and which would have caused its abandonment ultimately, was brought out in the first part of this article, viz., that it is possible to have too much water and thus keep the engine too cool, which materially reduces the efficiency of the latter.

At any rate, whatever the amount of fluid used or the method of circulating it, the fact remains that the radiator must cool it down to the temperature it had previous to going to the jacket. This is what the opponents of the fluid-cooling method have

for the basis of their argument that these are indirect methods. They are indirect, for the water first cools the cylinders and then air is used to cool the water.

Specific Heat of Air and Water Enter Into the Problem.—Here, that is in the indirect method of cooling, the specific heat of the substance used, enters. The specific heat is the measure of the heat required to raise a certain weight of the given substance 1 deg. as compared to the same ability of water, the latter being taken as the starting point or unity. This term is not relished by some as being inaccurate, so there is the alternative term, coefficient of thermal capacity.

As stated before, this figure for water is 1. For air at constant pressure, as in this case, the coefficient is .2375. Expressed otherwise, the ratio of the heat to raise air 1 deg. is to the

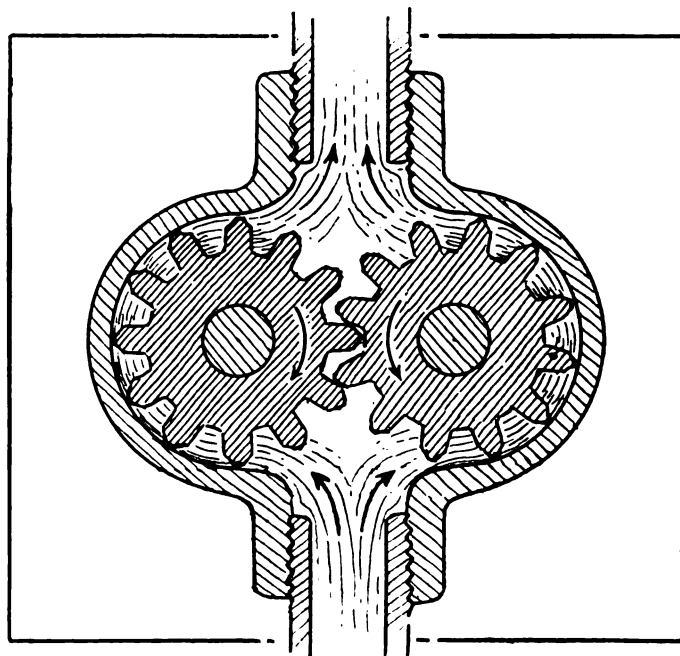

Fig. 4.—The easy curves improve the efficiency.

heat to raise water 1 deg. as .2375 is to 1. This renders it apparent at once that air has less cooling ability per unit of volume than does water, therefore to do the same work, or, more correctly, to remove an equal amount of heat, a greater volume of the air will be required in the inverse ratio of the specific heats. That is, the heat required to raise air 1 deg. is to the heat required to raise water as 23 is to 100. From this, the volume of air equivalent to the water in heat removing ability is to the latter as 100 is to 23.

- (8) $\frac{\text{Thermal capacity of air } .2375}{\text{Thermal capacity of water } 1.0000}$
- (9) $\frac{\text{Volume of air for equal heat-removing capacity } 1.0000}{\text{Volume of water for equal heat-removing capacity } .2375}$
 (To be Continued.)

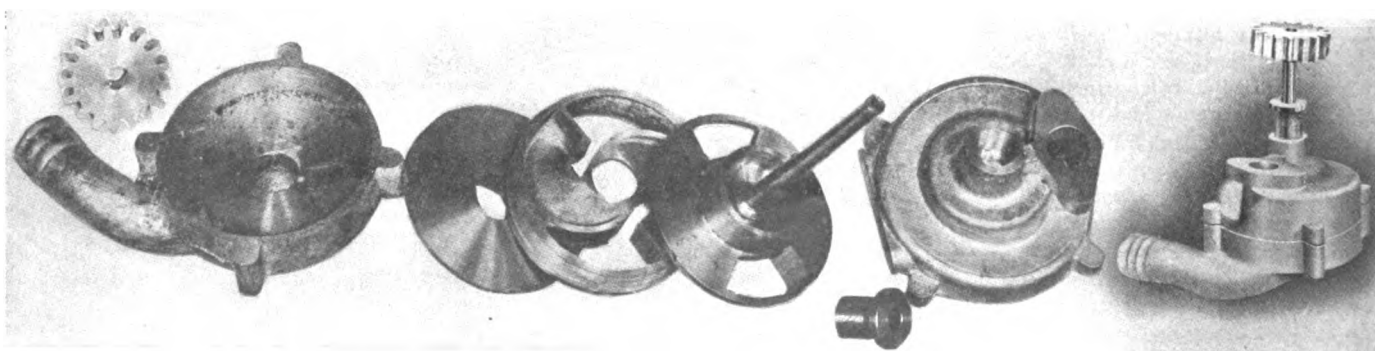

Fig. 6.—Detailed parts and complete assembly of a form of centrifugal pump.

Letters Interesting and Instructive

WANTS GEAR RATIO FOR HILL CLIMBING.

Editor THE AUTOMOBILE:

[1,802.]—Will you kindly advise me through the columns of The Automobile on the following: I expect to install a 14-horsepower horizontal motor in a car, weight about 1,000 pounds empty, and would like to know the best gear ratio to have on jack shaft; also how many teeth the small sprocket should contain, and also the sprocket on rear wheel.

Will use sprocket and brake drum combined; sprocket will have either a 10½" or a 12½" hole. I presume one-inch pitch is usual?

Want to have a strong going car and a perfect hill climber; speed is secondary consideration.

Will you give me slow and fast speed on ratio you suggest?

New York City.

W. COOPER.

If you adapt a lateral "jackshaft" on the chassis frame and a sidechain drive, which information you do not give, the bevel gearset can be with a ratio of 3 to 1, and the driving sprocket wheel can then be but little smaller than the driven sprockets on the rear wheels. It is of the greatest advantage to have the sprocket wheels of a good diameter, and the best results will be realized if the smallest sprocket has not less than 18 teeth.

In your case it is believed that the rear road wheels should run about 30 per cent. of the speed of the motor, which question is a little obscured by the failure on your part to state the diameter of the rear road wheels. At all events, it is possible that the best results would follow if the high speed is approximately 30 miles per hour, and if there are to be but two speeds ahead. It is then that the low speed should be about eight miles per hour. If the motor will deliver maximum power at about 1,200 revolutions per minute, and if the tires are 30 x 3½ inches, which will be the minimum size to use on the front and rear wheels of the car, the high speed, with a ratio of 3½ to 1, will afford a speed closely approximating 30 miles per hour.

If the car is to be equipped with a gearset with three speeds, which would be a good idea, the speeds might be graded in this manner: Low speed ahead, 8 miles; intermediate speed, 16 miles, and direct on high, at say, 32 miles per hour. If a planetary gearset is used, it is not believed that it will be possible to take any considerable advantage of the suggestions here offered, and the chances are that the driving sprocket will have to be used under conditions involving less teeth than the number stated. If it does become necessary to use a sprocket with a small number of teeth, it will be desirable to have the same cut with great accuracy, using a fine grade of steel for the purpose, and it would even be an advantage to put the sprocket through a suitable case-hardening process.

THE CORRECT NUMBER OF BATTERIES.

Editor THE AUTOMOBILE:

[1,803.]—In one of the recent issues of "The Automobile" there is an article on batteries being connected in series multiple, four in series. I have a six-volt coil. Should I use six in place of four? Do you think vaseline a good lubricant for ball bearings on front wheels?

LOWELL S. ELLIS.

Warren, Mass.

The number of batteries is still a mooted question, and if you re-read the article in question you will see that the author did not decide upon the proper number to use in any given case, but simply selected four because of the economy. The average dry cell of small size will give 1.4 volts. Connected up in multiple, the voltage is multiplied by the number of cells. If

6

you wish to get six volts, then you will use $\frac{6}{1.4} = 4.8$, you may

1¼

then use the next largest number, 5, or if you prefer, an even number, which is usual, 6.

Vaseline is a good lubricant, but a good grade of grease is usually considered better.

TO OBTAIN BEST IGNITION RESULTS.

Editor THE AUTOMOBILE:

[1,804.]—Please tell me through "Letters Interesting and Instructive" what to install to get the best ignition results from a four-cylinder motor; a single vibrating coil and distributor, or a four-unit vibrating coil and a timer, and why? The old coil throws the ignition out of time, as some of the vibrators don't seem to get busy until the rest are all done. When put in good order, it will not hold out for more than a hundred miles. Use a storage battery for current supply.

A SUBSCRIBER.

New Richmond, Wis.

Either system has some disadvantages. The apparently simpler system, the first, has the disadvantage that the work of the coil is quadrupled, and the trembler must operate in the same ratio. For this reason, it is likely to get out of order or wear out much quicker. With the other method, it is difficult to get the four tremblers tuned just exactly alike. The result of this is to vary the spark and consequently the power, so the engine will run irregularly. A four-unit coil with a single trembler for all the units is preferred by some.

VERTICAL AND HORIZONTAL MOTORS COMPARED.

Editor THE AUTOMOBILE:

[1,805.]—Kindly advise through your paper as to whether a horizontal motor of four-cycle is stronger than the same in two-cycle? Also, if an 18-horsepower horizontal motor is simpler in construction than an 18-horsepower vertical? Which of the two, providing their make is A No. 1, is less foolproof; that is to say, which would give the less trouble in the general running; both have shaft drive and all things equal, as to magneto, etc.?

New York City.

A. C. TONNING.

As to power, there is no difference between a horizontal and a vertical motor, the advantages being aside from this question. The advocates of the vertical type claim accessibility, while those who prefer the horizontal kind say that it takes up less space. Between the two and four-cycle motors, the power varies. Theoretically the two-cycle should give twice as much as the four-cycle of the same size, but in actual practice this decreases to about 1.3, owing to internal losses which up to date seem to be insuperable. The opponents of this type say that this advantage is partly offset by a lower fuel economy and the inability of this type of motor to run either very slow or very fast.

CONCERNING CREDIT DUE THE LANCIA "LAMPO."

Editor THE AUTOMOBILE:

[1,806.]—In your issue of January 21 last, on page 167, I have found, upon my return from abroad, an article which has placed our car, the Lancia, in a very unfair light, and has given your readers a false impression of the "Lampo" runabout, which won the Savannah Light Car race. I see no reason why there should be such a lack of sporting spirit in the American automobile fraternity. To be specific, this article informed your readers that the Lancia car was

"a special one, built for racing, lightened even to the extreme of a frame drilled full of holes, fresh from tests and trials in England, and sent over here in perfect condition, in ample time to work over the course—this car in a distance of 196 miles, and a total elapsed time of 3 hours 43 minutes 33 seconds, gained a total of 6 minutes 12 seconds over its nearest competitor, an American stock chassis, and 10 minutes 22 seconds over its third competitor, also an American stock chassis. It is a matter of record how much delay from tire and other trouble was experienced during the race by the three cars."

I wish, therefore, to make this statement, which I am willing to back up satisfactorily, to make it worth while investigating by the writer of this article.

The Lancia car which won the Savannah race was not a special built car in any sense of the word. The bore and stroke of the motor are identical to a millimeter with the cars we sell out of stock; the bevel gears in the rear axle have the same number of teeth as our stock runabout chassis, and, with the exception of the drilling of the frame and the addition of a hand spark advance,

differed absolutely in no respect from our regular stock runabout as offered to the public. This chassis has never been on English soil; was never in any test or trial there, and, as a matter of fact, was not received in this country in perfect condition. It was sent to Savannah by Adams Express, and received there only three days previous to the running of the race, and had it not been that we had a very competent corps of mechanics at our disposal, I feel sure our car never could have won the race, owing to the hurried manner in which it was put together at Lancia's factory. At the time we cabled we would enter this event, there being no runabout chassis in stock, it was necessary for them to build one in a very limited time.

Our cabled order for this car was sent from New York October 15; that car was then assembled and tested by Lancia himself, not exceeding 20 miles; the car was then shipped on "La Savole," arriving November 14, and then sent South by express. I think, under these circumstances, that the victory of this little car is extremely creditable, and would refer you to our issue of December 3, where, I think, justice was done and the secret of our victory was explained, namely, that we did not stop for a single mechanical adjustment or repair during the entire race—which was not true of our most disappointed competitors.

In further consideration of the statement to which I object so seriously, may I point out that the car that ran second, in this event, was of special build, in that the frame was underslung; the cylinders were exactly up to the limit permitted by the rules, being one-quarter of an inch more diameter than our cylinders. It was also lightened up so that its weight was at least 300 pounds less than our entry. This car, with its team mates, and most of the other entrants, had been upon the ground at least a week in advance of our arrival, and were consistently practicing every day.

What difference, may I ask the writer, does it make which of the first three cars had the greatest power? The race was run at a pace that killed, as shown by the condition of some other cars which finished the race. The writer further informs the public that the third car did not win the race, being handicapped because it had to reduce its bore. Did not the entrants in this race know that the event was intended for cars of 3-3-4-inch cylinders; and if, knowing this and that their cars would be seriously handicapped, why did they enter the contest?

I sincerely hope that we have another such event next year, and, knowing the rules beforehand, if it is not advisable to enter cars because of changes which have to be made, let us abstain from racing, and not make the changes the basis for our excuses for not winning. Or, if our cars do not win because of defective material, or their inability to negotiate the roads set apart for the race, because of the design or construction of the cars, do not let us blame the tire manufacturer or blame the winner in an effort to distract the attention of the public from our faults. Under such conditions and keen for clean competition, I shall be glad to enter a Lancia car in any event in which I believe it has a chance to win, or will at least show the public that it has the kind of stuff their dollars ought to buy.

C. H. TANGEMAN.

New York City.

LANCIA LAMPO'S USE OF PANHARD OIL.

Editor THE AUTOMOBILE:

[1,807.]—An unusual situation has arisen in connection with the Light Car race at Savannah which we should like to explain. Immediately after the race, acting on information received from the Hol-Tan Company, the entrants of the winning Lancia car, we advertised that Panhard oil was used on the winner, and, simultaneously with our announcement, appeared the announcement of one of our competitors to the same effect. We believe it unjust to your publication, to your readers, and especially to ourselves to have these two contradictory statements appear without any explanation.

We therefore wish to state the facts and beg of all to draw their own conclusions, bearing in mind the methods which have been employed by some manufacturers to get their products used on racing cars, and that we have never made any special effort to do this, the present case arising merely as the result of a regular annual contract.

The firm of George A. Haws, manufacturers of Panhard oil, had, and still has, a contract with the Hol-Tan Company calling for the exclusive use of Panhard oil by them. We have proof that a supply of Panhard oil was shipped by the Hol-Tan Company to Savannah for the race, and arrived in time for it. The president of the company, and also the Lancia mechanic, assure us that Panhard cans were carried and used on the car during the race, the tops having been cut out to make pouring easy, so that if any other brand was used it was done by emptying our cans and refilling them. The driver of the car, with whom our competitor claims to have had an understanding, has stated, in writing, that he does not know what oil was used, and the Hol-Tan Company absolutely denies having dealt with anyone but us.

We have reason to believe that our competitor has had similar misunderstandings with other oil houses, and are naturally anxious

to have the public set right in this instance at least, thus releasing ourselves from a rather ridiculous position. We certainly would not consider for a moment making a claim to which we did not believe ourselves justly entitled.

New York.

GEORGE A. HAWS—H. E. HAWS.

MISTAKEN NOTION WORKED TO A FRAZZLE.

Editor THE AUTOMOBILE:

[1,808.]—I should have been more pleased had you published my letter in full, instead of running the editorial blue streak through some of the most salient points, as for example, the table of carrying capacities. I think it is only fair to me to ask you to publish my last letter in full. The letter, as published, has been mangled beyond recognition. It is very fine to be in a position to dismiss arguments with a wave of the editorial mailed fist and to talk of my taking license with figures. Why don't you publish the table I sent? This proves my argument. Also, I should like to have you answer the question I asked: "How would you proceed to properly select a bearing without a full complement of balls that would be more effective than a bearing with a full complement?"

I quite agree with Mr. Bretz that the carrying capacity of a ball bearing is approximately related to the number of balls. Otherwise, manufacturers would specify carrying capacities to the pound or even to the ounce.

I shall ask you again to publish my last letter without chopping it up. Let's have a square deal, Mr. Editor, and fair play.

New York City.

ASHER GOLDEN.

"Letters Interesting and Instructive" are intended to serve a certain useful purpose, and, as the caption implies, the letters have to be edited if they do not conform to the demands in original form. Any such editing should not be construed as indicating "the editorial mailed fist"; on the contrary, it is not to be expected that every correspondent will qualify to the extent of having copy accepted and given space without editing. Take the table, for illustration; it proves nothing, whereas the Stribeck formula, properly interpreted, would be accepted in many quarters, as of some competence. The formula was given space because it does represent something, and if, as you said, the formula is looked upon as a classic (language originally used by Henry Hess in one of his papers before a society), it would seem as if a table out of a catalogue would add but little, if anything, to the value of your statement. Under the circumstances, considering the value of space, the table was left out. So many of your questions were taken up and discussed in the letter by J. S. Bretz, that a mere repetition or further discussion along the same lines would be of no avail. You seem to be imbued with one idea which cannot be encouraged, the purport of which is to induce the editor to engage in a discussion involving the relative merits of the respective makes and types of bearings. There may be some such relation as you intimate, but since both types of bearings are in use to a vast extent it does look like a waste of time to deny the facts. In the selection of bearings for a given undertaking, having decided to use some one type, the way to proceed is to purchase bearings big enough for the work to be done, having in mind the influence that quality of material and workmanship will have upon the result.

To make a comparison then, such as you suggest, would seem to be just about as good practice as the rest of your suggestions, and it is recommended that you take into account the difficulty involved in adding apples to oranges.

SUBSCRIBER WANTS THE "BEST" CAR.

Editor THE AUTOMOBILE:

[1,809.]—Please tell me what you consider the best touring car made for \$1,500 or less. I do not care for a speedy car, but I want one that will last a long time in good hands. Also mention what you consider the best magneto and tire equipment to put on the car.

A SUBSCRIBER.

Morristown, N. J.

Your question is a hard one to answer for you ask to know the best and, of course, there is no absolute best, that being only a relative term when applied to automobiles. Similarly with the magneto and tires, although in the case of the former, the practically universal adoption of one make should speak volumes in favor of it. Your attitude toward the speed question is a very commendable one.



An Automobile Through *LIGURIA*

By ~FRANCIS MILTOUN~

OF ALL the Italian gateways, that via the French Riviera and the Mediterranean coast road is the most delightful. Mont Cenis, coming from Paris, cuts the distance considerably, but offers no remarkable interest, save the superb run through Savoie,

while the Saint Gothard, a splendid mountain road, is rather roundabout unless one is bound only to the Italian Lakes.

The obvious and most splendid entrance of all from France into Italy is via that superb strip of Mediterranean coastline whose equal for sheer, ravishing beauty is not to be found in all the world. The coast road, the old Roman way from Spezzia to Genoa, and beyond through the Italian and French Rivieras, is bound to become one of the world's greatest automobile thoroughfares, if indeed one may not reckon it such even now. The Italian section is not as good as the French portion, but it is the best seacoast road in Italy. It has a width of 36 feet for the most part, but in places narrows down to half that width, and here and there overhangs a precipice on one side and is half roofed by a shelf of rock on the other.

This makes for picturesqueness and novelty to those who are used only to the broad boulevard like "Routes Nationales" of France, or the leafy lanes of England. There are drawbacks, however—the awful surfaces here and there, and the still more awful exits and entrances of the cities like Genoa, Spezzia and Livorno. But take it all in all the scenic charms are so varied that it is worth the doing.

From Menton in France all the way to Genoa—177 kilometers—the road is a continual rise and fall with sharp turnings and bad going for five, ten or fifteen kilometers at a stretch. Rain, an exceedingly dry spell, an automobile that for the moment is not pulling well, or a cycle of punctures or blow-outs which are apt to be more prevalent here than elsewhere in Europe, can considerably discount one's appreciation of the charms of this otherwise delightful road by the sea.

The combination nearly did for us—the author, the artist and one other—and a level railway crossing (there are seemingly a hundred of them in as many kilometers) nearly brought disaster many times, though fortunately we escaped.

Think of a great tree trunk, like a well-sweep, swinging automatically, or at least pushed by some hidden hand, out over the roadway without a warning of any kind and you will put it down as the most barbaric "safety appliance" ever thought of by civilized man, at least so far as a road obstruction is concerned. It is like the toll-gate bars of old, though here they appear every mile or two and are always half hidden by a nearby turn of the road. One passes close to the danger line only too often. Italy must wake up or keep its level crossing guardians on the *qui vive*, which they are not at the present time.

One must hope for the best when traveling in these parts, and if conditions are favorable, and all does go well, the itinerary

should prove delightful. Bordighera and San Remo are mere resorts for semi-invalids and are not worth a live man's consideration, and anyway they do this sort of thing much better in France. Porto Maurizio (Hotel de France) for lunch—which the Italians call *collazione* not *déjeuner*, remember—is better than the resorts further west where one gets imitation Parisian fare only. The town is the most typical and characteristic of Mediterranean fishing ports on the Italian Riviera. It is like Cassis in Provence, only more so, and the fleet of ships in harbor fly the flags of all Mediterranean nations. There are *balancelles* from Malaga and *feluccas* from Barbary, besides the Italian kind of sharp-prowed craft with low-hung latteen rigs, giving the whole scene a cosmopolitan air.

Eastward from Porto Maurizio we set out immediately after lunch, expecting to reach Genoa that night. Fate, those eternal railway crossings and bad roads willed otherwise, and Finale Marina (Albergo Garabaldi) was our stopping place that night. Alassio might have held us, but it, too, is a blatant resort in a small way, and we would have none of it.

Just before Alassio, juts out the Capo delle Mele, dividing the Riviera de Ponente into two equal parts. Here everything on the Italian Riviera changes, the geological formation of the soil and the quality of the crops, particularly that of the olive, and for the reason.

Finale Marina is a monumental nonentity. Its site is nothing remarkable save that it is on the seashore, and it has no history worth speaking of, but all the same its quaint, straight streets, its old *palazzo*, its monumental *chiesa*, its fortress and its palm-bordered *quai* make it a delightful stopping place.

Noli, just beyond Finale Marina, is not a stopping place for tourists of convention. An artist who wanted to paint old towers, fortification walls, rooftops and olive groves all in picturesque juxtaposition would not fare so badly here. It's an advantage to be an artist and see many things that others pass by.

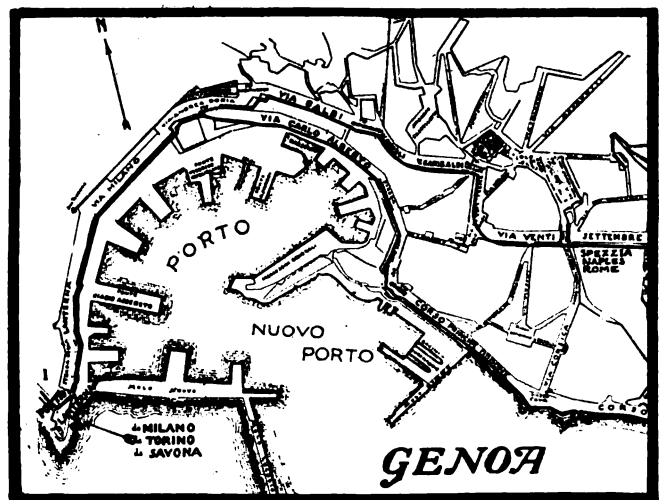



VENTIMIGLIA ~ PISA

PORTO MAURIZIO	<i>Hotel de France</i>	40.3 Kil
FINALE MARINA	<i>Hotel Garibaldi</i>	92.4 Kil
VAREZZE		120.5 Kil
GENOA	<i>Hotel Union</i>	166.3 Kil
RAPALLO	<i>Hotel de l'Europe</i>	31.6 Kil
SPEZZIA	<i>Hotel Croce di Malta</i>	109.1 Kil
	<i>Hotel d'Italia</i>	
MASSA	<i>Hotel Massa</i>	37.7 Kil
PISA	<i>Hotel Nettuno</i>	84.1 Kil

Genoa is still a long way off, though its cloud of smoke has hung on the horizon ever since the Capò di Noli was passed. Savona is a miniature Genoa, the third busiest port on the Riviera, coming directly after Genoa and Nice, though the Genoese did their best to strangle its prosperity in the sixteenth century, when they blockaded its harbor and filled the entrance with débris. On a tower on Savona's port is a great statue of the Virgin, before whose shrine the sailor folk say their prayers. Beyond its smoky picturesqueness, its broad flagged streets and its shocking pitfalls of getting in and out of town, Savona is nothing to be remembered of the automobilist.

How One Waits at Railroad Crossings.

We remember it because we waited three-quarters of an hour at a level crossing just before entering the city. The Nord-Sud-Brenner-Rapidé, from Vienna to Nice, bringing a trainload of Franz Joseph's subjects to the sunny Riviera, was nearly an hour late, and the incumbent whose duty it was to open and shut the railway barriers shut them, according to orders, when the train was due, and would only open them after it had passed. Had it run off into the ditch and never arrived we should probably have been waiting there still.

We were not able to reach Genoa for lunch even, owing to this delay, but did very well at Varazza, dining in a vast *salone* which must have seated a couple of hundred people. The proprietor ran a sort of side industry in recruiting Italian immigrants for the "two Americas," as he called the New World. The majority of his clients bought their tickets straight for New York, however—"Nuova Yorka bella citta!"

Cogoleto, between Varazza and Genoa, is another of the apocryphal birthplaces of Columbus, and the house where he was born bears a sufficiently convincing inscription to that effect.

Voltri, a dozen kilometers further on, has for centuries supplied printers all over the world with fine old hand-made and water-marked papers. Paper making, like beer making, depends largely upon the water used in the process, and here the water is of such a specious purity that the shrine of the "Madonna della Aqua Santa" of Voltri is famed throughout all Italy.

Still one does not get to Genoa. The road seems interminable and gets worse all the while, with tramways, ox-carts and five tandem horse trucks. Pegli must be passed, and Pegli for the

automobilist is as nothing, though for a fact it is a resort as full of Germans as Hyères is of English. Pegli has a sight in the shape of the Villa Pallavicini, with elaborate gardens, which the Italian residents call a "meraviglia d'art." That judgment depends entirely upon one's individual taste and his ability to express it in words.

Genoa's Awful Main Road.

Genoa, with its awful railway and tramway-lined main road, is a nightmare. Genoa is one of the finest cities of palaces on top of the earth, but the automobilist entering the city via San Pier d'Arena will need a period of repose after circumnavigating the port, past the four hundred year old lighthouse, "La Lanterna," before he does a round of sight-seeing.

Genoa's hotels are of all ranks and all excellencies, some with garages and some without. We found an astonishingly good thing—after half an hour's busy hunting—the Hotel Union, on the Piazza Campetta, whose only access was by a ten-foot alley, a bad hill coming down and a worse one getting out. The F.I.A.T. garage was at least a mile away, but we were glad we came, nevertheless. All things considered, the little Hotel Union at Genoa was about the best thing in the hotel line that we found in Italy, and the garage accommodations, when they were finally located, were superb.

The road out from Genoa is by the magnificent Via Settembre and is a little improvement over that by which we entered, but given a rainy day and no anti-skids and the greasy, slimy pavement, with two lines of tram track all the way to Nervi, and the driver of an automobile will have considerable excitement and some risk in getting out of town. Nervi is what the guide books call "a mild winter station for invalids." It is that, but it possesses no shrines for sentimental travelers save the garden of the Villa Grapello, and the hotels hang out signs of Pilsener and Munich beer instead of tea and whiskey. The omnific German has appropriated all the Italian Riviera, as the Americans and English have the Côte d'Azur.

Why German Aspect Is Good.

The only really good thing in the way of a resort hereabouts is the little bunch of towns clustered around the mountain promontory of Portofino. Here, too, the whole aspect is German, but that's a good thing in itself. It keeps down prices. The German en tour doesn't squander his gold; he asks the price beforehand and gets as good as we do, perhaps better, and for less money. From Recco the coast road climbs up the mountain side to Portofino-Kulm, but it is nothing difficult, and the road

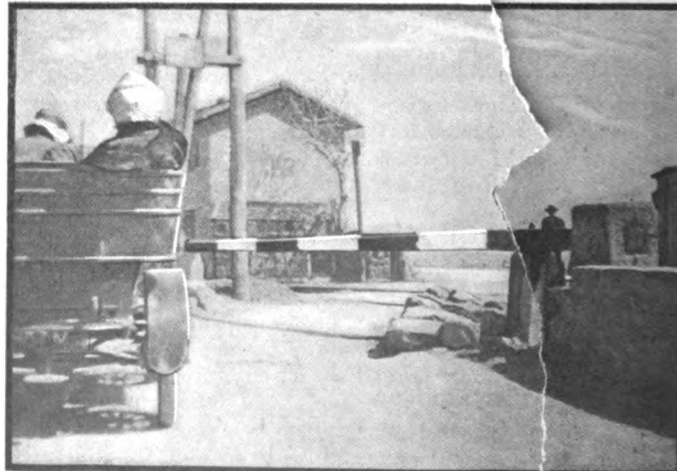
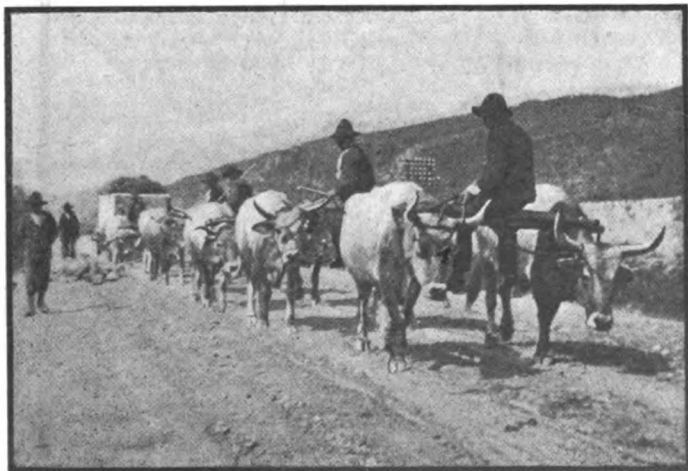

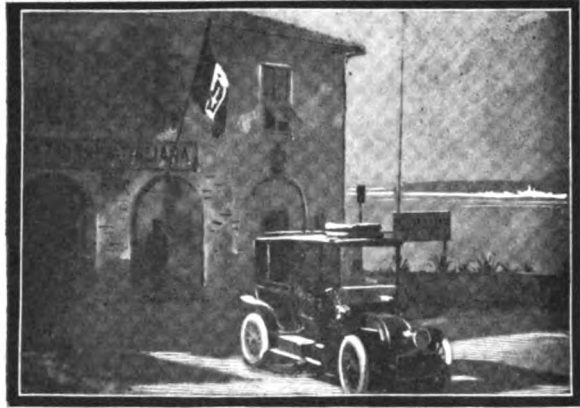
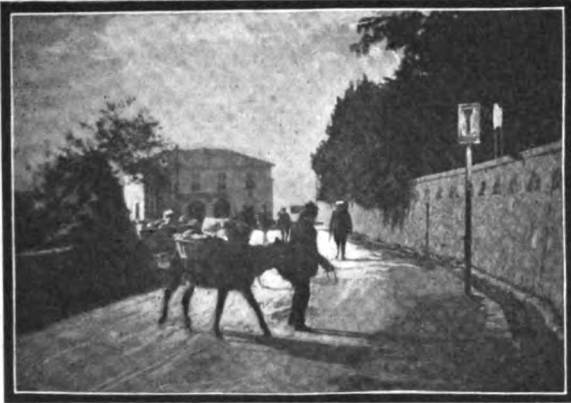

DOGANA

DOUANE

ON THE FRONTIER

here is the best on the whole Italian itinerary. Portofino is reputedly the most beautiful spot on all the Italian Riviera. The honors lie easily on its head, and the title "Queen of the Mediterranean" is only in dispute between the cities of Portofino and Monaco.

Ten minutes in an automobile, leaving the grand route at Santa Margharita and continuing by a little side road which rises and falls and twists and turns at the very edge of the shore, and one passes the ancient monastery of Cervara, where François Premier was confined for a time by Charles Quint after he had lost "all save honor" at the battle of Pavia. Almost before he knows it the automobilist drops down into Portofino and takes his choice of the Hotel Splendid, with prices according to its name, or the Hotel Piccolo, also with prices in accord with its nomenclature.

Rapallo, on the mainland, is a typical little Ligurian seaport, with an old watch-tower, or donjon, a defence of the days when every little coast town lived in a tremble for fear of the descent upon its quais of some pirate hoard from Barbary. The Hotel de l'Europe (with a French name, albeit that it is an Italian albergo through and through) is a seedy-looking seaside hotel which caters for the automobilist well enough, though its garage accommodation is limited. In its "Libro d'Oro," where you sign your name as from Kalamazoo or Kickapoo, you also note that Queen Margharetta has inscribed hers, as well as various other lesser lights of the European noblesse.

From Rapallo to Chiavari are thickly peopled hillsides, with gleaming white houses and square whitewashed campaniles of churches everywhere peeping from among the olive trees and vines. Chiavari is one of the ancient towns of the Genoese territory, built up in the genuinely romantic medieval fashion, with tall houses stilted on great stone arcades and rising like skyscrapers. The streets of Chiavari are more like canyons than anything east of Wall Street. The specialty of Chiavari is the making of chairs, though where they all go to it is hard to say, as no one ever saw the like of these particular chairs elsewhere.

Sestri-Levante is also an up-and-coming resort, with numerous hotels and pensions, a delightful situation, a mild climate and no architectural monu-

ments worth speaking of, much less writing of. It is the last of the Riviera resorts as one goes east.

The road now deserts the shore and runs the last sixty kilometers inland by the Coll di Bracco. It climbs up and up, like the

road over the Col de Quatre Chemins back of Nice, with the sea frequently in sight below the sloping olive orchards. It grimps along in places on a mere terrace or shelf of rock, and as one headland juts out into the sea farther than another the farther away from the actual shore runs the road.

At the crest, at the actual mountain pass, seven hundred odd meters above the sea, the road is still twisting and turning on itself until Bracco, the old diligence station, is reached. Even here the view of the distant sea and the coast villages is still superb. Down drops the road by gentle sweeps and curves to Borghetto and finally Spezzia.

Out from Spezzia the road grows worse and worse until, in a dozen or twenty kilometers, it descends into a mere slough. It is, the writer verily believes, the worst road in Europe.

After a couple of hours of brain- and nerve-racking driving, and heartbreaking fears for your automobile, you will be glad enough to lunch in the garden of the Hotel Massa at Massa, when, perhaps, you will have the courage to proceed further.

You pass Viareggio as fast as the road will allow, and sweep at last on to a good stretch of highway which draws slowly up over the plain and finally around Pisa's lone leaning tower, its duomo, and its campo santo. It is with a real relief that you at last settle down in the Albergo Nettuno at Pisa, remodeled out of the old Palazzo Agostini.

Garage accommodation is limited at the Albergo Nettuno, and you pay two or three francs a night for it, but as far as it goes it is satisfactory. Have nothing to do with the local mechanic or his garage. Buy your benzina (as the Italian calls gasoline) at a drug store or a grocer's, or you will get unmercifully stuck. You ought to pay fourteen francs for a five-gallon can, say thirteen kilos, but you may pay twenty if you don't watch out.

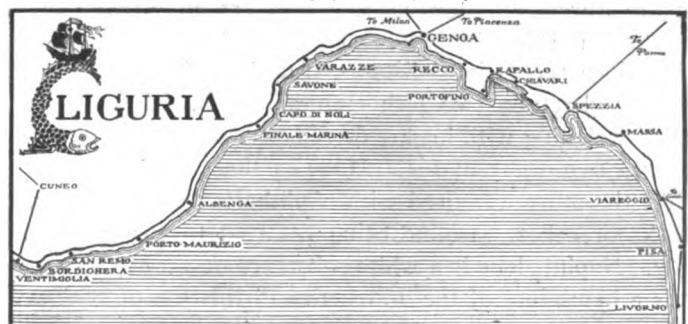

THE AUTOMOBILE

Vol. XX

Thursday, March 25, 1909

No. 12

THE CLASS JOURNAL COMPANY

H. M. SWETLAND, President

231-241 West 39th Street, New York City

EDITORIAL DEPARTMENT

A. G. BATCHELDER, Managing Editor

R. F. KELSEY, Associate Editor

THOS. J. FAY

MORRIS A. HALL

W. McKEAN WHITE

F. BRADLEY, Foreign Representative

BUSINESS DEPARTMENT

A. B. SWETLAND, Business Manager

LOUIS R. SMITH

FRANK B. BARNETT

W. I. RALPH, 1035 Old South Building, Boston, Mass.

C. H. GURNETT,

F. W. VAN SICKLEN, 1200 Michigan Ave., Chicago, Ill.

H. H. GILL, Detroit, Mich.

T. B. VAN ALSTYNE, Philadelphia, Pa.

Cable Address - - - - - Autoland, New York
Long Distance Telephone - - - - - 2046 Bryant, New York

SUBSCRIPTION RATES:

United States and Mexico - - - - - One Year, \$3.00
 Other Countries in Postal Union, including Canada - - - - - One Year, 5.00
 To Subscribers—Do not send money by ordinary mail. Remit by Draft,
 Post-Office or Express Money Order, or Register your letter.

FOREIGN SUBSCRIPTION AGENTS:

ENGLAND:—W. H. Smith & Sons, Ltd., 186 Strand, London, W. C., and all book-
 stalls and agencies in Great Britain; also in Paris at 248 Rue de Rivoli.
 FRANCE:—L. Baudry de Saunier, offices of "Omnia," 20 Rue Duret, Avenue
 de la Grande Armee, Paris.
 GERMANY:—A. Seydel, Mohrenstrasse 9, Berlin.

Entered at New York, N. Y., as second-class matter.

The Automobile is a consolidation of The Automobile (monthly) and the Motor
 Review (weekly), May, 1902, Dealer and Repairman (monthly), October, 1903,
 and the Automobile Magazine (monthly), July, 1907.

FUEL ECONOMY IS A LIVE TOPIC.

The rapidly increasing price of motor fuels, taken in conjunction with their rapidly decreasing quality, is giving the progressive manufacturer plenty of food for thought, and should be, if it is not actually, the big point for thought on commercial motor trucks. In this connection truck builders should be working on cheaper fuels and bringing out engines especially adapted to burn these fuels, for the answer to this fuel question is bound to become more and more difficult as time passes and as the number of vehicles in commission increases.

Aside from the agitation of a few years ago relative to denatured alcohol, which quickly died down, nothing has been done. On the other side of the Atlantic this question is even now assuming large proportions, and the manufacturers are showing that they are alive to its future possibilities by experimenting with other fuels. Thus, in a recent long-distance trial from Paris to Versailles and return, two 40-horsepower trucks of the same make, weighing with load over 19,000 pounds, were fitted to burn two different fuels. One of these used gasoline, while the other was fired with naphthalene, used in solid blocks or cakes, gasoline being resorted to for starting only. Naphthalene is a white substance of very little use. It is a byproduct of the destructive distillation of coal as

practiced by the gas companies. As such, it was thrown away, until three years ago, when a use was found to pay for saving it.

The results are of more than passing interest. The truck operating on gasoline consumed for the whole trip an average of 16 liters, costing 14.2 francs (\$2.75) per hour, while the other used up 29.2 kilograms of naphthalene, worth 4.22 francs for running and 3.2 liters of gasoline, costing 1.18 francs for starting. The total, then, for the latter was 5.4 francs (\$1.04) per hour. These figures are based on the retail prices paid at Paris, which, reduced to English units, amount to 65 cents per gallon for gasoline and 12 1-2 cents per pound for naphthalene. The results, showing that fuel cost, using gasoline, may be improved upon to the extent of 62 per cent., or, looked at from the other side, showing a loss of 162 per cent., should afford our progressive manufacturers opportunity for reflection.



MAKING LAWS FOR AUTOMOBILING.

Despite occasional indications of unprogressiveness in various parts of the country, the general tendency is towards more rational and sane legislation in regard to the running of automobiles. Once upon a time the automobilist had to accept with as good grace as he could summon whatever laws were made for his "benefit." But he has taken a lesson from the experiences of the lowly cyclist, who grew in numbers until the "servants of the people" learned to respect his rights and wishes, of course providing there was no interference with the real rights of other road users.

While it is an unfortunate fact that not more than one in a score of automobilists joins his local club or otherwise becomes identified with organized efforts to bring about a better state of affairs, it has followed that with the instituting of clubs in localities, conditions have bettered, as has been the same result in the State when the clubs have worked as a unit. It follows as a natural sequence that the State bodies should be associated, which gives the reason for the existence of the American Automobile Association.

No matter if differences of opinion may arise as to the actions and rulings of any one of its boards, the national association is a necessity of the hour and deserves the support which it is obtaining from the amateur owner, as well as from the automobile trade itself. If the best way to insure peace is to prepare for war, it is likewise true that with the automobilists thoroughly organized there will be less hostility from agitated legislators, who are ever wont to be influenced by the greatest and most influential number of voters.

If the automobilist has his say in the making of the law, he owes it to himself as a good citizen to obey, and, as far as lies in his power, to compel others of his kind to obey the law in which he has had a hand in the making. Therein lies an excellent characteristic of the Englishman, who insists that he must help make the law, but, once having made it, he obeys it as though it were a religion closest and dearest to his heart.

JERSEYMEN HOLD SIXTH ANNUAL BANQUET.

NEWARK, N. J., March 22.—No autoing organization in the entire country wields more influence and shows more progressiveness than the New Jersey Automobile and Motor Club, and its sixth annual banquet, held Thursday night last in Krueger's big auditorium, proved the banner event of the kind in the history of the body. Nearly three hundred faced President Paul E. Heller when he introduced the first speaker of the evening. Preceding this feature of the function there had been an in-ning of songs, some of which were composed for the occasion, and all present participated in the singing.

H. D. Bowman made a most efficient chairman of the committee in charge, which included A. B. LeMassena, James R. English, J. H. Wood, W. C. Crosby, H. A. Bonnell, Guido O. Greebe, G. H. Simonds, W. S. Sheppard, Albert Schurr, and Charles W. Baker.

First of the speakers of the evening came former United States Senator James Smith, Jr., whose topic was "The Automobile as a Civilizing Influence." In the course of his remarks he said:

"When the automobile was first introduced like many others, I looked upon it with great disfavor. This was because we were led to believe that it was a vehicle designed only for speed and had come to replace that noble animal, the horse. This feeling has all changed, however, and we now see the automobile in its right light. A motor car when properly handled is one of the most joyous things of life. While we have made wonderful progress with the auto in the past it has a greater future. There is no recreation that gives more health, vigor, enjoyment and beneficial results than automobil-ling. Every improvement that tends to make life pleasant and distances shorter is an improvement that brings the people close together and makes of them better citizens."

Ex-Congressman L. Irving Handy, of Delaware, who supplied the humor of the occasion, said that he liked banquets, for he was built that way, and was pleased with the opportunity to come to such a spread as he had before him. The ex-congressman belongs in the heavy-weight class. A. G. Batchelder's topic was "Some Autoing Reminiscences"; J. B. R. Smith, State commissioner of motor vehicles, did some "Looking Forward"; and Vivian M. Lewis had as his topic "Our State."

Assemblyman Austen Colgate, who has not hesitated to espouse the cause of the automobilist at Trenton, was a popular speaker, whose views met with unanimous approval. Mayor Haussling referred to the good roads of New Jersey and said that there were none better anywhere.

There was considerable reference to the present treatment of outside automobilists, especially in the matter of reciprocity, and if the matter could have been left to the vote of those present, the automobilists of the other States would have no difficulty in entering the commonwealth of New Jersey as freely as the Jerseymen now visit New York and other States.

NEWSPAPERS INSTALL MOTOR TRUCK SERVICE.

NEW YORK CITY, March 22.—The New York *Herald* and the *Evening Telegram* to-day installed an automobile delivery service of five cars, which will be used to distribute the papers to retail and branch offices. This installation will be followed by the addition of as many more next week, and the total, taken with the number of heavy trucks now in the service, will give these two papers one of the largest installations in the country and easily the largest of any newspaper. In the newspaper business, time is essentially money, and the prime idea back of this new move is the possible saving of time which the service is expected to make.

The cars are of the Renault make, the chassis and tires only being imported, while the bodies were made in New York City. The cars are of two types, two-ton trucks which have four-cylinder engines and one-ton machines with two-cylinder motors. The former weigh 3,400 pounds and the rating is 14-20 horsepower. On the other hand, the smaller cars only weigh 2,200 pounds and deliver but 10-14 horsepower. A feature of these cars is the use of twin pneumatic tires on the rear wheels of both trucks.

NEW LAMP COMPANY FORMED IN DETROIT.

DETROIT, March 22.—The latest addition to the long list of automobile and accessory manufacturers claiming Detroit as home, is one that will help materially to add to the fame of the City of the Straits. This is the C. M. Hall Lamp Company, and is composed of a small group of the city's most influential business men. As soon as the temporary organization had been formed, officers were elected as follows:

John W. Leggett, president; Thomas J. Wetzel, vice-president; J. F. Hartz, treasurer; C. M. Hall, secretary and general manager; and with these, D. M. Newbro, of the Herpicide Company; J. L. McDonell, superintendent of the House of Correction; and E. H. Broadwell, vice-president of the Fisk Rubber Company, will serve on the board of directors.

The company will manufacture high-grade automobile lamps only, including acetylene, electric, and oil lamps of exclusive patterns covered by patents. Among others is what is known as a "dimmer," which partly shuts off the light from a headlight when necessitated by city or other ordinances, and saves the annoyance of stopping and extinguishing the lamp.

Mr. Hall, the manager, was for five years with the Badger Brass Company, as salesman, while many of the others interested in the concern have also been with this company. The capital of \$150,000 was all subscribed and most of it paid in, so that preparations were made to start business at once, this including the purchase of a two-story building, 60 by 180, on Rivard street.

DEATH OF HENRY TIMKEN, IN CALIFORNIA.

CANTON, O., March 22.—It is with deep regret that the Timken Roller Bearing Axle Company, of this city, announces the death of its president, Henry Timken, which occurred on March 16, at San Diego, Cal. Despite his advanced age, 76, his death was a surprise to his friends, as he has been unusually sturdy and rugged, and his illness lasted but a few days. He was buried in San Diego yesterday, and on Saturday the factory in this city was shut down in tribute to his memory. Mrs. Timken died last December.

A pioneer in the manufacture of carriage, wagon and later automobile roller bearings, Mr. Timken began his business career in St. Louis, when that city had but 25,000 inhabitants. His first patent was the Timken spring, which he manufactured and put upon the market, followed by his own invention of the roller bearing which bears his name. He was one of the first men to be elected to an office in the National Carriage Builders' Association, and for years served it with the same ability and faithfulness which he gave to his own affairs. After a successful business career of more than 45 years he retired and went to live in San Diego, where he has spent the last 12 years.

FERNAND RENAULT DIES IN FRANCE.

NEW YORK, March 22.—Fernand Renault, one of the famous Renault brothers, the makers of the Renault automobiles, died to-day at his home in Paris, according to a cablegram received by Paul Lacroix, the manager of Renault Frères Selling Branch. Mr. Renault had been in poor health for some time, and it was just announced that he had retired from active participation in the affairs of the big concern on the Seine. He was the oldest of the three brothers who first formed the company, being born in Paris on November 28, 1864, was a copartner in the firm, vice-president of the Automobile Section of the Syndical Chamber of the A. C. F., and president of the Renault Frères Selling Branch which has charge of sales in this country and Cuba.

The death of Fernand Renault leaves but one surviving member of the trio, Louis Renault, the youngest, who was born in 1877, who is also a copartner in the firm, and one of the most prominent figures in Continental automobiling affairs. Marcel Renault, the third of the brothers, and the one between the other two in age, died two days after an accident in the disastrous Paris-Madrid race in 1903.

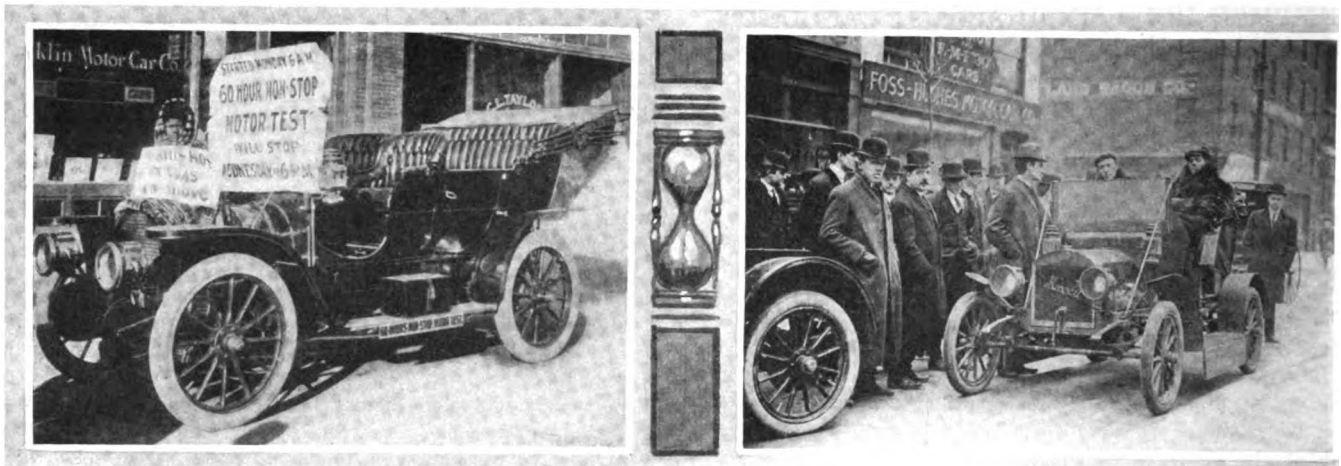

Franklin Non-Stop Engine Shown to Be Cool.

Maxwell Junior of Philadelphia, Non-Stop, Performer.

NOVEL EVIDENCE THAT FRANKLIN KEPT COOL.

"Tain't hot; if 'twas I'd move." So read a sign displayed recently by a small colored boy, seated upon the hood of a 28-horsepower Franklin touring car, during a sixty-hour non-stop run of the car's engine in Kansas City. Throughout the daylight hours of the test he stayed on his perch, and so far was the air-cooled engine from overheating that it failed to keep the boy comfortable, and he wrapped himself in a blanket to keep warm.

The test was made in the street in front of the headquarters of the Franklin Motor Car Company. It began Monday morning and did not end until Wednesday night; during this time only 1 1-2 gallons of oil and 28 gallons of gasoline were used, although the motor was run at a good rate from start to finish. At all times during the sixty hours the cylinders of the engine were so cool that they could be touched with the hand. A sixty-mile as well as a sixty-hour test was made. In running the sixty miles the car carried five people about Kansas City, the run being made in eleven hours at the rate of 5 5-11 miles an hour. The entire course was covered on the low speed, which is geared at twelve to one. Had the run been made on the high speed with the engine making the same number of turns, the distance covered would have been 225 miles.

SYRACUSE SHOW SPACE MUCH IN DEMAND.

SYRACUSE, N. Y., March 22.—With every inch of space in the State Armory Building already taken, automobile makers and dealers are still clamoring to Chairman Kerr of the Show Committee, for space at the local automobile show, which will be opened by Mayor Alan C. Forbes on Thursday. Over 100 applications came in and twice as large a building could have been used, though the armory is the largest available in the city.

Fourteen firms and individuals are allotted space on the main floor and 100 different styles of cars will be shown. The basement will be given over to the showing of accessories, there being a score of exhibitors in this class. Syracuse is fast becoming an automobile center and every factory of importance in the country has been asked to send famous cars and polished chassis.

ALABAMA WILL HAVE AN AUTO FACTORY.

BIRMINGHAM, ALA., March 22.—Plans have been made in this city for the early establishment of an automobile factory to build six-cylinder cars, and the first complete factory of its kind in this State. As yet, not all of the details have been completed, but it is known that the product will be called the "Great Southern Six," and will be sold at a moderate price. The concern will be incorporated and capitalized at about \$250,000. The only official known definitely is E. F. Enslin, who will be the secretary-treasurer, and he states that full information will be ready in a week. The location of the plant will be on Avenue B.

MAXWELL, JR., NON-STOP RUNS TO PITTSBURG.

PHILADELPHIA, March 22.—Finishing its 2,000-mile non-stop task early last Friday morning in 5 days 16 hours and 45 minutes, the little Maxwell Junior runabout, which during the better part of last week tirelessly ate up the miles, up and down Broad street, was reshod with Ajax tires, and, without stopping the engine, was headed for Pittsburg, where it will be put on exhibition at the show to be held next week. The little car averaged a trifle over 24 miles per gallon of gasoline, and maintained a schedule throughout of a little less than 15 miles an hour. Relays of drivers from Lancaster, Harrisburg and other intermediate points took the little pluggie across the mountains to the Smoky City.

BOSTON MAXWELL AFTER NON-STOP RECORDS.

BOSTON, March 24.—In an attempt to establish the world's record for non-motor-stop runs, a Maxwell touring car of 30 horsepower, at noon to-day had traveled 2,606 miles of the 10,000 which it has started out to cover, its engine humming merrily, and no signs of trouble. The machine was started at 10 o'clock last Thursday morning from the clubrooms of the Bay State A. A., when President L. R. Speare, of the A. A. A. and the Bay State A. A., cranked it, and it was driven off by Lucius J. Tyler of the Maxwell-Briscoe-Boston.

Under the direction of the local Maxwell dealers, and the auspices of the Bay State A. A., this contest will be run on the roads surrounding this city. Mr. Tyler, accompanied by C. E. Goldthwaite, and Adam Schneider of the Maxwell factory drove the car the first day two round trips over the route to Worcester and return, and then was succeeded at the wheel by Ralph Coburn of the local branch, who was accompanied by Arthur See and Joseph George of the factory. The third relief was composed of William S. Simonds of the Boston branch, Ellery Wright and C. F. Lawrence. Before the start all the drivers and observers were sworn to observe the rules of the test.

The first 1,000 miles of the journey was completed when the car finished its twelfth round trip to Worcester and return. It is planned to continue on the Worcester route for several days more and then to change the route to Providence or Newburyport. The car is equipped with Ajax tires, on demountable rims.

WARNER COMPANY CLAIMS AN INFRINGEMENT.

BELOIT, WIS., March 22.—The Warner Instrument Company, manufacturers of Warner Auto-Meters, has announced the institution of a suit against the Stewart & Clark Manufacturing Company, of Chicago, claiming infringement by the latter. The Warner company holds a patent, No. 745,468, granted December 1, 1903, on magnetic speed indicators, and it claims that the Chicago concern is now making one with magnetic action, thereby infringing upon Warner rights.

INDIANAPOLIS HAVING SPRING CELEBRATION.

INDIANAPOLIS, March 22.—Automobile manufacturers and dealers of this city are celebrating their annual spring opening week, beginning with to-day, exhibiting new models, and joining with each other in festivities, which will tend to arouse interest throughout this section of the country.

The event is held under the auspices of the Indianapolis Automobile Trade Association, which is affiliated with the Automobile Club of Indiana. There are special features for each day, and the city authorities have united to make the week a successful one. To-morrow there will be a tire-changing contest, for clincher, quick detachable, and demountable rims, and a ladies' egg race. Both of these events will be held on the North Capitol avenue boulevard, the Board of Park Commissioners having given special permission. On Wednesday the feature will be a parade, in which several hundred cars will participate. Mounted bicycle officers will lead, followed by the several cars in municipal service, carrying city officials. Behind these will come a Rapid truck, carrying the Indianapolis Military Band, and trucks carrying children from the orphan asylums. Then will come the 1909 models of the different dealers and manufacturers.

The closing feature will be a banquet, Saturday night, at the Denison Hotel, and Mayor Charles A. Bookwalter will be one of the principal speakers.

The general show week committee is composed of B. W. Twyman, Motor Car Sales Co., chairman; F. I. Willis, Willis-Haywood-Holcomb Co.; F. L. Moore, Fisher Automobile Co.; D. B. Sullivan, Indianapolis Automobile Co., and Cecil E. Gibson, Gibson Automobile Co. Other committees are: Press committee: P. D. Stubbs, Overland Automobile Co., chairman; A. R. Kling, Indiana Sportsman; Ray Holcomb, Willis-Haywood-Holcomb Co. Parade committee: F. I. Willis, Willis-Haywood-Holcomb Co., chairman; Paul Smith, Indianapolis Motor Car Co.; Olin S. Peck, Cadillac Co., of Indiana. Contest committee: F. L. Moore, Fisher Automobile Co., chairman; Harry Freeman, Finch & Freeman; George Weidley, Premier Motor Manufacturing Co. Entertainment committee: Howard Marmon, Nordyke and Marmon Co., chairman; Charles R. Newby, State Automobile Co.; R. H. Losey, Buick-Losey Co.; W. H. Brown, Overland Automobile Co.

ACRE OF SPACE USED BY TOLEDO SHOW.

TOLEDO, O., March 22.—With an acre of floor space, in the gaily decorated and brilliantly illuminated Coliseum, devoted to the exhibition of over eighty automobiles, and samples of accessories arranged around the balconies, the third annual automobile show held in Toledo, was this evening opened by Mayor Brand Whitlock. In the eighteen booths dividing the main floor, all of the dealers in this city have for the week placed the latest models of their cars, and for the first time since automobile shows were undertaken here, are a unit in supporting the annual function, a condition brought about by the organization of the Toledo Automobile Dealers' Association.

With all of the preceding shows of the season lending new ideas, those in charge of the decorations have tried to combine the best features seen in other cities, with some distinctive ones planned here. The result is a wonderfully beautiful hall, where pastoral scenes have been combined with those of forests, fourteen large forest trees having been brought into requisition.

The attendance this evening was greater than expected, and it is believed that the show will be an important one throughout this section of Ohio. It has been extensively advertised, and a great many small dealers, as well as owners, from out of the city have expressed their intentions of visiting the exhibition. In addition, the event occurs during the annual opening week of all Toledo merchants. The newly formed trade association has been a prime mover in the preparations, and its officers have been especially active. They are: president, A. A. Atwood; vice-president, W. H. McIntyre; secretary, S. C. Fisk; treasurer, E. A. Kirk. The concerns exhibiting autos follow:

Gamble Motor Car Co., Stearns, Peerless, Baker electric, Rauch & Lang electric; Atwood Automobile Co., Premier, Regal, Stoddard-Dayton, Velle, Overland, Waverly electric; Lichtie Automobile Co., Winton, Cadillac; Standard Garage Co., Brush, Hupmobile, Jewel, Ford; Union Supply Co., Stevens-Duryea, Chalmers-Detroit, Pierce-Arrow; Roberts-Toledo Auto Co., Ford; Central Auto Co., Maxwell, Mitchell; Olds Motor Works, Oldsmobile; Buick Motor Co., Buick; Banting Automobile Co., Carter Car; Kirk Bros. Automobile Co., Thomas, Knox, Studebaker, E-M-F, Columbus Electric; L. L. Blood, Detroit electric, Jackson; The White Co., White steamers; Apperson-Toledo Co., Apperson-Toledo; Harry Overmeyer, Glide; MacInnis Bros., MacInnis cars; Peter J. Lune, Gramm-Logan; H. J. Adams. Reo, KisselKar.



White and Maxwell Automobiles Take Pacemaking Part In Notable Athletic Stunts.

Pugilist Jim Jeffries tries a practice run in New York suburbs, conveyed by a White steam touring car.

Edward Payson Weston, the famous pedestrian, on his walk to the Pacific Coast, is accompanied by a Maxwell touring car.



HELPING OUT THE LATE HORSE



HOISTING THE FLAG ON THE "SNOWBALL LIMITED"



JUST NATIVES OF PENNSYLVANIA



"MEPHISTOPHELES" & THE PILOT.



GETTING PICTURED

Regal "Snowball Limited"

Detroit, Mich. to Syracuse, N. Y.

JUST as "time and tide wait for no man," so "rain and mud have no regard for automobilists," according to the crew of the Regal "Snowball Limited," which recently plowed through the blizzard, from Detroit to Syracuse, N. Y., and thereby proved itself capable of running under the most trying conditions, and winning an interesting wager. During the automobile show in the "City of the Straits," George D. Wilcox, of the Mora Sales Agency, of Syracuse, N. Y., remarked that it would be impossible for a moderate-priced car to make a first-class endurance run over roads that were considered impassable, and he was promptly challenged by a Regal Motor Car Company representative.

The wager was that Mr. Wilcox, selecting any car in the Regal factory, should start, with a driver, for Syracuse, and if the car made good, should take the agency for the car in central New York, contracting for 25 machines. If, on the other hand, the car gave any trouble en route, or failed to reach its

destination, the Regal company would stand the expense of the trip. The start was at noon on Washington's Birthday.

The roads were terrible all through the trip, the car taking on, hour by hour, a deep coating of mud, snow and ice, and the crews sharing in the same dressing. Toledo was reached through a sea of bottomless mud at nine o'clock that night, after driving for 26 miles on low gear without overheating. The next day, running to Cleveland, first a lake had to be forded and the rain was fast thawing out the mud, so the "Snowball Limited," as it was called, met unusual conditions. All through Ohio there were telegraph poles and trees across the roads, soft swamps to be crossed, tires to be changed, and at Fremont the little car had to take to trolley tracks and bridge, to cross a river, where the road was minus a bridge.

That night was spent in a barn, and Elyria was reached before noon on Wednesday, by which time the car resembled a steam shovel at work excavating roads. With 167 miles to the good the party, consisting of Mr. Wilcox, William Smith, who drove, and Richard Byrne, passenger, reached Cleveland at one o'clock on Thursday, and pushed through that afternoon to Ashtabula.

On Friday morning an early start was made for Erie, but at 3 o'clock that afternoon, still fifteen miles from the Pennsylvania city, the party was out of new tires, having used up six new shoes that morning, and a delay occasioned until others were secured, so that the Regal was not headed toward Buffalo until Saturday morning, when a blinding snowstorm was holding forth: 100 miles was covered in 12 hours to Buffalo, and the crew determined to push on to Batavia, which was reached at 10:30 p. m. Batavia to Auburn, via Canandaigua, was sufficient for a Sunday run, and at noon Monday the car reached Syracuse in perfect condition, not an adjustment having been made.

HOW ONE CONCERN SYSTEMATIZES ITS SELLING

By C. W. KELSEY.

CAPTAINS of trade sit up and marvel at the growth of the automobile industry, the gigantic strides direct the attention of Wall street, the throbbing center of the United States Steel Corporation, and the small army of banks throughout the country. The labor world thinks keenly upon the problem, labor leaders realize that the wave of financial depression that swept over the country, and was nearly a year in passing, would have been infinitely worse had it not been for this new manufacturing enterprise, for the larger and stronger companies felt not the financial stringency, and the demand for their cars was greater than ever, with the consequent results that large contributory companies, the manufacturers of steel, aluminum, bronze, leather and rubber goods were all able to keep their plants going on account of this new demand. Even the billion-dollar steel corporation is permitted not to overawe the automobile industry.

Experts who are getting at the roots of things in their efforts to present data to the Ways and Means Committee of Congress, to make able presentation in the interminable arguments over tariff, and the protection of the American automobile maker against the European rival, startle everybody but themselves with the totals they dig up. It is estimated that, with the stupendous development of the American automobile industry, there are now invested in plants for automobile building, and all nec-

there were 166 firms in the industry. There are more than 250 firms now engaged in the industry, and capital is seeking a place in them as well as in the embryonic firms that soon may be launched.

Estimates based on the most conservative figures indicate that there will be added to the visible supply of automobiles during 1909 by these United States concerns no fewer than 90,000 automobiles. "And the commercial vehicle problem has only been scratched on its surface at that," remarked the manufacturer of pleasure vehicles. "We dislike to attempt to mark the boundaries of the motor industry when the commercial car comes into its own."

Automobiles are factors in the daily life of the nation—the schoolboy recognizes this as an axiom. The automobile industry, in itself such an important adjunct of that billion-dollar staple industry—the Steel Corporation—becomes daily more of a twin to the latter. For that reason, captains of industry pause and think hard before they attempt to prognosticate the probable gigantic proportions that both are likely to achieve. The nation has changed its mind absolutely inside of a decade about the automobile being for the rich. It is a feature of the political economy that makes for more economies and more pleasure—it's the greatest necessity of modern times.

Realizing that the keynote of the industry had become "the maximum of motors for the maximum number of people," some manufacturers concentrated the efforts of their designers on products that would appeal to the masses. The result—the medium-priced car. Another result—the enterprising makers who read the handwriting on the wall have gone forward on a wave of success. It is no exaggeration to say that their problems now have become those of enlarged plants, night and day shifts, and purchasing supplies for the use of the busy plants. Seriously, if the business continues to grow with such leaps and bounds the makers of the cars that the people most desire will have to give more thought to supplies. Any momentary paralysis of the allied steel industries would mean serious trouble in the great consuming centers of the makers of popular-priced cars.

The larger organizations correctly interpreted the course of growth from the start. It was the judgment of the factors of these organizations' policies adhered to strictly, and designs produced by competent engineers, combined with a perfection of system as intricate as the United States postal service, yet as effective as a small organization, resulted in the Maxwell-Briscoe Motor Company becoming the largest manufacturers of automobiles in the world. So enormous have the proportions of the automobile industry become that only by meeting them with prodigious organization can a motor manufacturer expect to keep up with the procession, to say nothing of leading it. The strongest links of the automobile organization, in all the phases of the industry, must be as strong as those of the steel corporation. There must be no weak links. In the Maxwell-Briscoe Motor Company there are no weak links. The organization is such that the factory units may be increased in blocks of two, four, ten or a dozen, and still the output may be put where it will be assimilated by the market—or, to be correct, the people.

What would you say if I should tell you that the president of the Maxwell-Briscoe Company, or any leading factor in the department executive work, could not only tell where every Maxwell car is, and who owns it, but also give a short history of the manner in which the machine was assimilated in the market? All this could be done upon a moment's notice. If the inquisitive critic wished to further test the completeness of the Maxwell-Briscoe system, he could ask other questions. He could find out what parts and repairs were needed, the cause of the repairs, and how the matters were adjusted. Anything that passes either through or out of a Maxwell factory leaves its imprint on the records. They know what is doing, and what everybody should

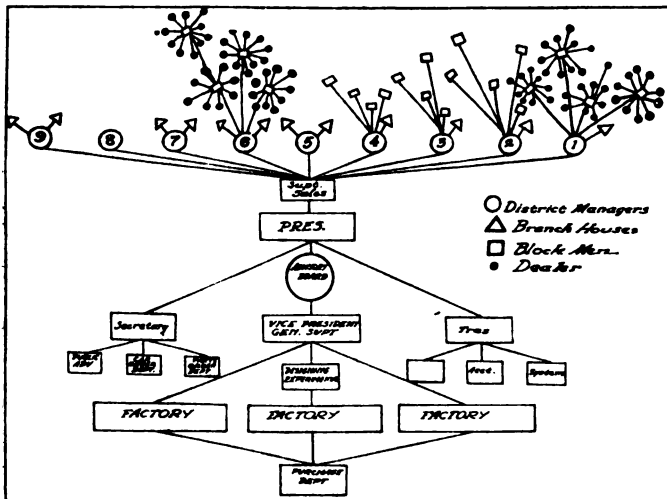

Factory Organization Diagrammatically Shown.

essary kindred industries, such as the plants making accessories, leather for machines, parts, etc., more than \$300,000.

Less than a decade ago the automobile industry in the United States was an apology. The maker of an automobile at that time unhesitatingly paid tribute to Europe. France was the center of the motor universe, with Germany playing a good eccentric second, but in five years the United States began to be a factor of no mean consequence. "Beat out France in the amount of automobiles turned out" was the slogan. But there were "doubting Thomases," who considered this an almost impossible task. In 1902 there were fifty-one firms in the industry in the United States, and eighteen of them discontinued business, leaving thirty-three plants for the nucleus of the 1903 business. This number was increased to seventy-four, although thirty firms fell by the wayside in the race to get into the world-wide movement for producing automobiles. Fifty-four new concerns essayed entering the field in 1904, and forty gave up the ghost, leaving eighty-eight firms in the trade at the end of the year. In 1905 fifty-one new companies came into being, and thirty-eight discontinued, leaving 101 for the opening of 1906. During the latter year there were forty-three new concerns, while only twenty-nine gave up the sponge, leaving 115 concerns in business. At the end of 1907

do. The system of an army head constantly in touch with his chiefs of corps, divisions, brigades, etc., is no more effective than that which obtains in this factory. The executive, his immediate aids, and the advisory board are at all times in direct touch with every department. The factories themselves come under the direct supervision of the vice-president, who also is chief engineer and designer.

Suppose, for instance, that a year's work is to be planned. The advisory board is called into session. The district managers, superintendents of sales, secretary, treasurer, general superintendent, and vice-president compose this effective board. The president presides. At this important meeting the policy of the company is outlined. This is a tremendous advantage, for, heading the district managers, who are in touch with the pulse of the trade, the factory is able to produce the type of car that the public demands. In short, here is reflected not only the judgment of one man, or several, but the desires of the American public, voiced through hundreds of dealers.

Following the recommendations of this advisory board, the chief engineer, together with the designing department, work the new models on paper, after which they are built in the experimental department and thoroughly proved, until every detail has been worked out and found satisfactory. Orders are then given to the purchasing department for material. Each of the several factories work in competition to produce the best results and to stimulate this, prizes are offered to the leading superintendent and foremen. Records are kept in the car-order department showing the rate at which cars are coming through at each factory, each department at the same time keeping an accurate account of the cost of each part; also the cost of the completed car. After a thorough testing on the road, the cars are repainted, equipped and shipped the same day they are completed.

In connection with the manufacturing department is the sales department, which must be built on lines broad enough to market a great output in the most economical manner. The building up of the sales department of a big automobile plant reads almost like a fairy story. The sales department logically comes under the direct supervision of the president, who is assisted by the superintendent of sales. Under these two men are what are known as district managers, each of which controls a certain section of the country. In the principal cities of each department are located branch houses, which are directly controlled through the district manager by the parent company. Following out the system still further, under each district manager are a number of men known as block men, and under each block man are from twelve to twenty dealers; part of the work of these block men is to circulate among these dealers, assisting them when possible and seeing that the cars are being sold in accordance with the policy of the company; that prices are not cut, and that customers are treated with fairness and consideration. Such block men make daily reports to their chiefs, the district managers, who in turn make weekly reports to the factory, where complete records are filed. Thus the moment a car is sold the name of the owner is recorded, the name of the dealer who sold it, and the number of the car is put on the card.

Believing that competition keeps all departments of the organization working at its highest efficiency, every dealer works in competition with his neighbor, the branch-house managers in competition with themselves, while still higher up the ladder each district manager fights it out with his neighbor to see who shall lead. Every two weeks a pamphlet is issued, showing the relative standing of every member of the sales organization, with a statement showing his percentage of sales, which is based upon the dollars' worth of sales made in proportion to the population and selling expense. Every four months the leading district managers, branch-house managers, block men and dealers, and, in fact, every one who helps to make up the success of the organization receive prizes as an appreciation of their efforts. The whole organization can be likened to a gigantic spider's web. The United States is the web and so carefully supervised that the smallest report comes to the office with telegraphic rapidity.

TIRE INFLATORS SAVE MUCH HARD WORK.

By having some form of compressed gas or means of compressing it, automobilists can save themselves a great deal of hard labor and, what is of fully as much value, considerable time. The tire-makers are all advocating high-tire pressures, and to produce these with the ordinary hand pump is a back-breaking and time-consuming task.

So, with the advocacy of increased inflation, there have been a number of devices brought out for producing gas under pressure. These vary all the way from the air or carbonic acid gas bottle, which simply stores the compressed gas, to the various mechanical air pumps. Considerable attention has, of late, been given to the problem of utilizing the waste pressure of the exhaust. This pressure may vary from 40 pounds per square inch upward, and by providing proper storage tanks and connecting pipes with valves to regulate the flow to and from the tank what was previously a waste can be made to do useful work.

The latest contrivance utilizes not the exhaust, but the compression pressure. Moreover, this is cooled so that it enters the tire cold and gives a true, not a fictitious reading on the gage. As shown in the illustration, it is very simple, consisting of an attachment to the cylinder, cooling coil and a petcock on the dashboard. To inflate a tire the petcock is turned on. This permits the compressed gas to flow through the pipe, a hose attached to the dashboard end of the latter being fastened to the

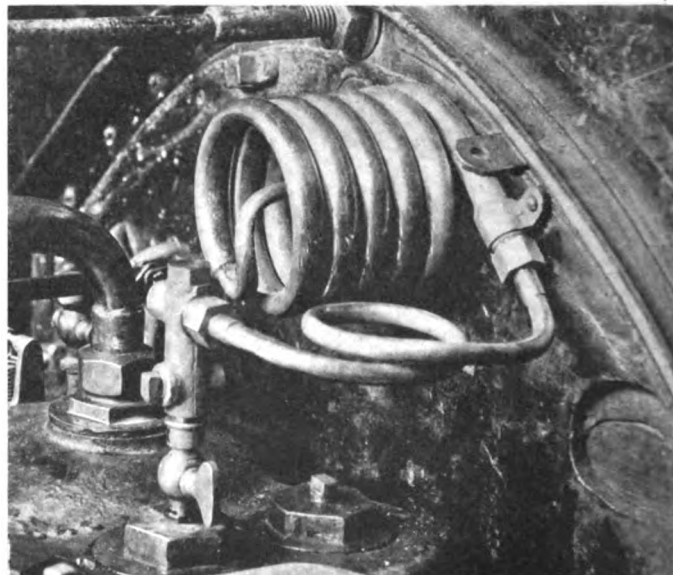

Maxim Tire Inflation Apparatus Is Very Simple.

tire. Then as the engine rotates the gas is compressed, passes through the small pipe, the coil surrounding this cools it, and from the petcock on the dash, by means of a flexible hose, it is led to the tire, to be inflated.

The very apparent simplicity of the apparatus and its operation will appeal with peculiar force to the non-technical, non-mechanical driver. The small plain petcock cannot be objected to by the most radical advocates of a clean dash. Nor could the carrying of a ten-foot length of flexible hose be classed as a hardship. The engine is running idle at the time, so that the power loss, if any, is not of moment. The attachment of the whole outfit to a car is such that any man with the ability to use a screw driver or a wrench can put it on. Taken as a whole, this device seems to be one that will fill a long-felt want.

A strong detachment of the Airship Battalion, with Captain Von Jena in command, is at Friedrichshafen for a several months' instruction course with *Zeppelin I*, the airship owned by the German Government. The sixty men and officers will make no less than thirty-two trial ascents, which are to be completed the first of May, the weather being propitious.

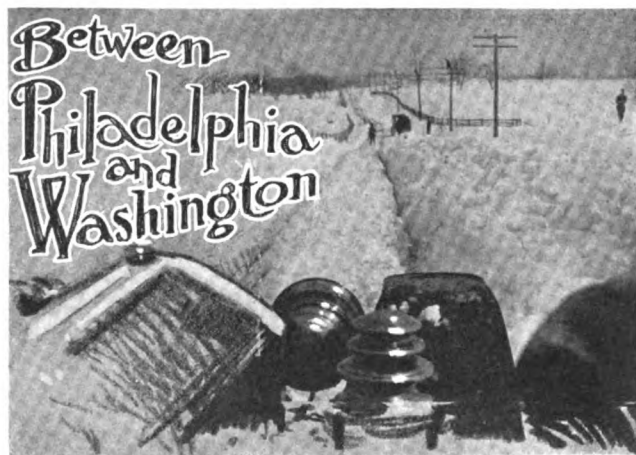

WHEN an automobile lands in a ditch, with its flywheel in such intimate contact with the ground that the motor cannot be cranked over, and when, for miles at a time, the same car has to buck deep snowdrifts, climb fallen telegraph poles, or break through fallen telegraph wires, it may be considered as having a pretty extreme test. And if, when it finally reaches city streets, its motor runs as sweetly as ever, and the car glides along as if it had never tackled a Midwinter blizzard, it is a machine that is worthy of the admiration given it. This is not the tale of a run in Alaska or on the Siberian steppes, but the experience of "Jim" W. Florida and a party which tried to tour from Washington to Baltimore, a distance of about 45 miles, three days after the inauguration, in a 30-horse-power shaft-driven Locomobile.

This car was the only one which was able to get between the two cities, although several tried, and its experiences, as related by Mr. Florida, are not those generally undergone in this part of the country. In describing the trip, he says: "We provided ourselves with shovels, axes, extra sets of Weed tire chains, starting off at ten o'clock Sunday morning, and for about three miles the roads were fair, until we reached the road to Ashton, and then for two miles we had to open a way through snow waist deep. Soon we saw a driveway into a ploughed field, which farmers had been using as a road for about two miles, because the snow on the latter was up to our shoulders. To get into the field we had to jump a ditch about two feet wide.

"Our first attempt was a failure, for our rear wheels fell in up to the hubs, and the fly-wheel was tight upon the ground, but we took a dozen fence rails, raised the car and built a road under it, to get it over the embankment and into the field. We started on low gear, and when about half way from the road the car fell into a big hole, again laying upon the fly-wheel, so that we had to start road building again. In two hours we had gained two lengths, and we decided to return to the roadway and we were able to jump the ditch, but were buried right away in the snow. For a mile and a half we had to shovel snow, and then we had a chance to travel for a short distance, until we were up against another choice, of either shoveling as far as we could see, or of taking to a field. We headed for the latter, first clearing away about 50 yards of snow, tearing down some wire fence and chopping through a telegraph pole.

"Another mile, and then more miserable roads, where the telegraph poles were hidden by the snow, one of which we

struck so hard that we thought that the engine had been torn loose from the frame, but an examination showed that no damage had been done. We had to chop through a great many, so that by 4 P. M. we had gone only 19 miles and it was getting dark. Just about that time we struck another long, endless stretch of tightly packed, waist-deep snow, with the alternative of climbing five feet up into a field, so down came the fences, and a kind of stairway was built. The incline was so steep that the rear wheels just threw the rails out behind them, and it was a case of rushing, after six ineffectual attempts at climbing, for the rails were out of sight in the mud. We found another entrance, and finally worked around the field, lighted our lamps, and started through more snow. We spent three hours in a nice, soft field of mud, shoveled snow for two and a half miles further, and then found a hospitable farmer with whom to spend the night.

"We stayed at the farmhouse over night and started early. The going was very slow. We shoveled for practically two miles, into Clarksville, taking us two hours, but from that point to Baltimore we had 24 miles of fairly open roads, and this distance we covered in fifty minutes, showing that the car was not injured by its strenuous experience. It was a delight to finally reach the streets of Baltimore, and the motor hummed along as if nothing had happened, and the driving mechanism did not show, in the least, the terrific strain which it had undergone. We were given quite a reception in Baltimore, for it was known that we were trying to get through, and four other cars had failed."

Subsequently Florida renewed his journey homeward to Philadelphia, conquering added rough roads, but more easily because of the absence of snow and the unusual conditions attending the Washington-Baltimore section.



A STUDY of the new Herreshoff brings the conclusion that in this work of producing a car with carefully interrelating parts, the cost has been made subservient to the main functions of utility and ability. This being the case, the result is a product which displays the maximum total efficiency. The motor is of the four-cylinder vertical type, with the cylinders cast in pairs. With this form, too, the three-bearing crankshaft is used. Here again is a deference to the popular prejudice against the use of two bearings, one at each end of the shaft. To the lay mind this presents opportunities for trouble, without any offsetting advantages.

Absolutely Straight Line Drive.—The motor is placed very low in a sub-frame in order to get an absolutely straight line drive to the rear axle. This is based on the reasoning that if a small angle reduces the friction losses in the use of universal joints, an absence of any angle whatever must reduce these losses still further, possibly to zero. Inlet and exhaust valves are on one side, mechanically operated by a single cam-shaft. The valves are interchangeable, 1 5-8 inches in diameter, and the valve springs are very large. The push rods, which lift the valves, are fitted with spiral springs which deaden the impact of the push rod meeting the valve stem. An absolutely automatic carbureter is employed and gives a range of speed of the car from 7 to 45 miles an hour with five passengers. Range of mileage on one gallon of gasoline is between 15 and 18 miles, depending upon the nature of the country over which the car is driven, and the quality of the fuel.

The lubrication of the motor is by self-contained continuous oil-feed, the crank-case having a reservoir below which holds the surplus oil. An oil pump operated by worm gear sends the oil through a sight feed on the dashboard, oil running back from the sight feed to the crankcase proper, from whence it is splashed up throughout the motor. The crankshaft is fitted with three F. & S. ball bearings.

Cooling is thermo-syphon system, without water-pump or fan, thus insuring a constant temperature in the motor. The radiator is of the vertical tube type fitted with horizontal fins, and is made larger than is necessary to cool the motor, in order that the hood lines will conform with the lines of the body, which are convex.

Bosch Magneto Will Supply the Sparks.—Double ignition is supplied from a Bosch high-tension magneto and a storage battery with coil and

commutator, each with a separate spark plug, making the ignition separate and distinct, one from the other. Control is by switch, placed on the coil box on the dash and has three points—one for the magneto, one for the neutral point and the third for the battery. The coil is of the four unit type.

Engine and transmission are constructed in one unit, the transmission case being bolted to the case which encloses the fly-wheel and clutch. The motor pan extends under the motor and is fastened in place by four clips, such as are used on racing cars being very quickly operated.

The clutch is composed of 25 discs, which are of steel saw-blade material: entire clutch running in a bath of oil and kerosene—one pint of each. The clutch casing is fitted with a cover bolted in place with four studs.

Transmission gears, three forward and one reverse, are on the same lever—progressive type—thus insuring compactness and eliminating chance of disarrangement. The gears are projectile steel, accurately cut and very stubby. Located back of the transmission is the foot brake, lined with Thermoid, the very latest brake lining material which is almost indestructible. Between the motor and the transmission there is one joint and between the transmission and the front part of the drive-shaft there is a very large ball-and-socket joint, containing another square joint, which gives an absolute universal movement and takes up all undue strains from the motor.

The frame of the car is narrowed at a point just back of the dash board, in order to insure close turning, and is widened on the top and deepened at the point where it is narrowed. There is also fitted a cross member, because the frame gets its greatest strain at this point. The motor and transmission unit is hung in a sub-frame, which is connected with a side frame by pressed steel plates, thus taking any strain from the motor and transmission, which might come from one side of the frame being higher than the other. Drive to the rear axle from the transmission is by tubular shaft, thus insuring lightness and great strength, and fitted with ball thrust bearings. Control of the motor is by throttle on top of the steering wheel, which is 16 inches in diameter, and by foot accelerator, both working directly on the carbureter. The point of ignition when running on the magneto is fixed to suit all speeds of the motor, while in the battery ignition the commutator is advanced by spark lever on top of the steering wheel. The former makes for simplicity while the latter is a necessity.

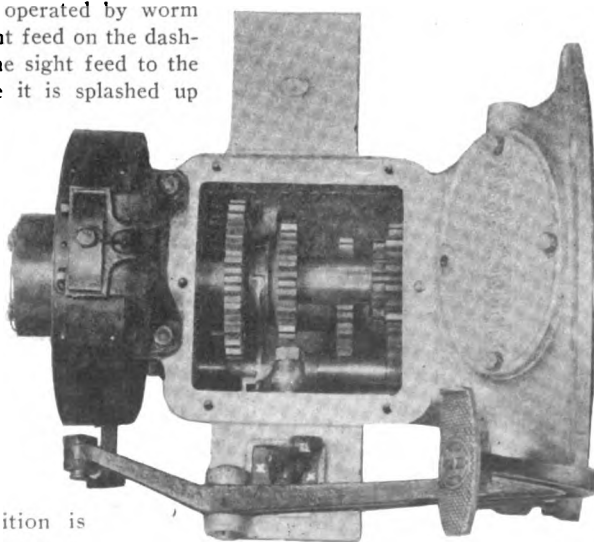

Top View Shows the Few Gears Used.

Ball and Roller Bearings Are in Profusion.—Both front and rear axles are by Timken and are fitted with roller bearings. The front one is of high carbon steel of the well-known Timken alloy heat treated, and is drop-forged in one piece. Steering arm is placed over the front axle and the coupling rod is back of the axle. Nine and three-quarter inches road clearance is permitted by the front axle. Rear axle is semi-floating, the live axles being secured where they fit into the differential case and tapered and keyed into the hub. The rear part of the case over the differential is removable and held in place by four bolts, thus allowing the differential to be taken out on the road after the live axles have been removed.

Provisions for keeping the driving strain of the motor away from

of the well-known Mercedes type in the runabout. Each car is equipped with a muffler cut-out, operated by a pedal placed convenient to the heel of the right foot. Front floor boards are beveled where they fit together and are fitted with brass, thus eliminating any chance of the floor boards swelling.

The emergency brakes are one on each rear wheel, internally expanding—shoes lined with Thermoid and are actuated by the emergency brake lever. Brake rods from the emergency lever to the brakes have two points of adjustment, which can be taken up before it is necessary to reline the brakes.

The Herreshoff is built at Detroit, but the sales have been taken over in their entirety by Harry S. Houpt, of New York City. It is understood that the output is practically sold.

CONGRESS REGULATES TAXICAB CHARGES.

WASHINGTON, D. C., March 22.—Acting under authority given by the District appropriation passed by Congress during the last session, District Commissioner West will have a conference this week with the managers of the several taxicab companies regarding taxicab rates. The section regarding taxicab rates provides, in part, as follows:

“That the Commissioners of the District of Columbia be authorized and directed to put in immediate operation, subject to change from time to time, a reasonable scale of

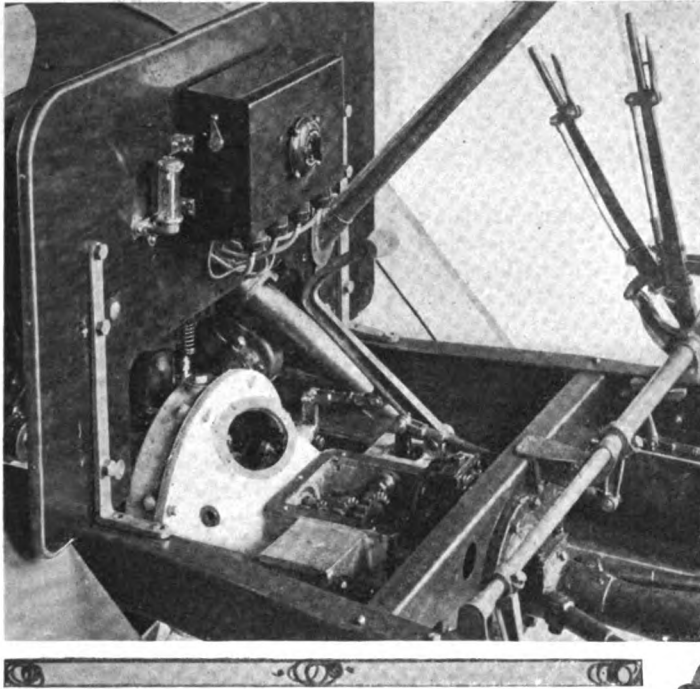

Note the Clean Dash, Nothing But the Coil.

the springs are composed of two tie-rods running diagonally from the extreme ends of the rear axle to the front end of the torsion tube, and combined with the torsion tube, which encloses the driving shaft, braces the rear axle at either end and also in the middle—the springs doing the work which they are designed to do, that is, to give an even rise and fall of the body on rough roads, without lifting the rear wheels from the road.

Half-elliptic springs of the flat type are shackled on the front end as well as on the rear. Wheels are second growth hickory, 32 inches in diameter, with 12 spokes in the rear and 10 in front. The car has 100-inch wheelbase, the rear cushion of the body is 48 inches in length, 18½ inches depth and 6½ inches high. Foot room in the tonneau is 27½ inches, as against 25 inches in other cars at the same price, and the rear cushion is one inch longer than in other cars of the same price and of equal wheelbase.

Springs are of the same quality steel as is used in cars at three times the price. They are not bored in the center and fastened with a bolt, but are pressed out in the center, so that the projection of one leaf fits into the depression of the leaf below it. The springs seats are so shaped that the springs cannot shift. F. & S. ball bearings are used throughout the car with the exception of the axles.

Simple Control Attracts the Novice.—One pedal operates the clutch and brake on the transmission, thus eliminating any chance of a novice applying the foot brake, without having disengaged the clutch. Gasoline feed in the touring car ins by gravity; in the runabout, forced feed, using the one-way valve

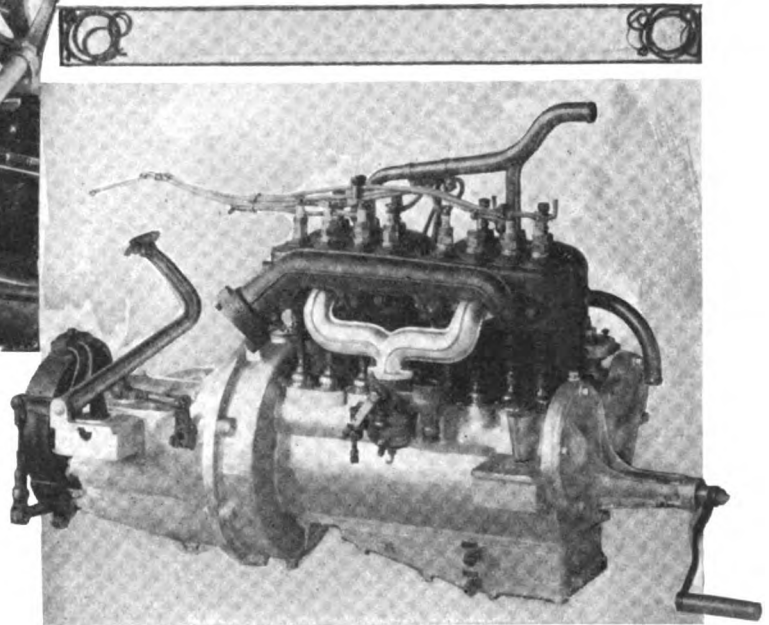

The Valve Side of the Motor Looks Neat.

charges by cabs, taxicabs and public vehicles for the transportation of passengers in the District of Columbia, and the tariffs so prepared shall be the maximum charges in the District of Columbia.”

It is understood that the taxicab companies are going to “stand pat” on their present rates, while the Commissioners are said to favor lower rates, so it is likely that a tug of war will ensue. The Commissioners have prohibited the use of any inaccurate taximeter, and provided for the test of meters in use by the police. The enforcement of this regulation will be taken up at once, the hack inspector being official tester.

CHAUFFEURS WANT EXAMINATION.

PHILADELPHIA, March 22.—The Professional Chauffeurs’ Club of Philadelphia is actively canvassing local motordom in an effort to boost a bill, which is to be introduced into the Legislature by Representative Marvin, of Pike County, requiring every professional chauffeur to pass a rigid examination before being licensed to drive a car. The local chauffeurs ascribe the bulk of the recent deplorable accidents to incompetent chauffeurs.

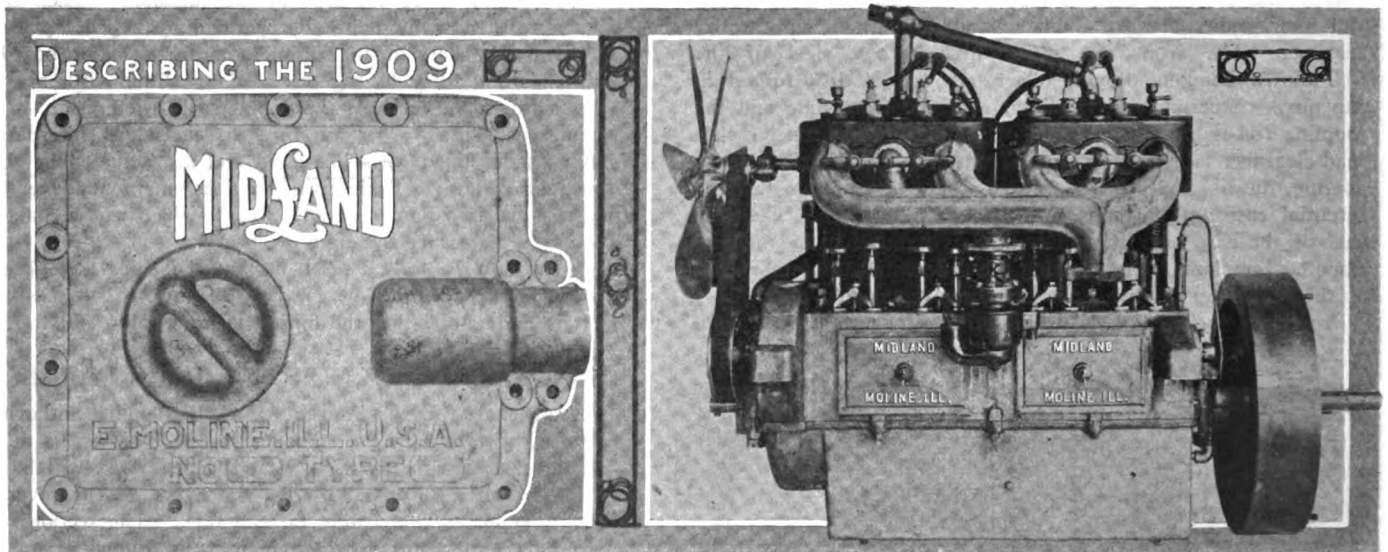

MOLINE Ill., March 22.—The sterling mark used by the Midland people in place of the letter "L" in the name, is accepted as indicative of the quality of the product, which is essentially of sterling worth. The company has decided to concentrate its energy on two models. Model G-9, which will be described, and Model E, a 30-horsepower car of the same general style, but smaller in every way and intended to sell for a lower price. This will be \$1,800, while the larger model retails at \$2,250, thus covering the whole range of the medium-priced medium-powered class.

As might be expected of a car thus heralded, the features which stand out and make the ensemble different from others which might resemble it externally are numerous. These, as the prospective purchaser might be glad to know, are of a mechanical nature, and such as the most advanced practice would stamp approval upon. Among the excellent features may be mentioned the offset crankshaft, which in combination with the long stroke gives superior power results with longer life; the three disc cork insert clutch, which makes for easy gradual action and positive engagement; the torsion shock absorber inserted in the driving shaft to absorb the jerks and irregularities of the driving torque; the patented gear shifting mechanism, by the use of which it is absolutely impossible to engage two speeds at once for the simple reason that the single lever is so restrained as to be unable to pick out more than one at a time; and the shaft brake which acts to prevent spinning when the clutch is applied, the effect being to render gear-shifting easier and more certain.

Details of the Power Plant.—To go into the details of the car, it will be advisable to start with the most important part, namely, the motor. This on Model G-9 is a four-cylinder verti-

cal, water-cooled motor, with $4\frac{1}{2}$ -in. bore and $5\frac{1}{4}$ -in. stroke. The cylinders are mounted with three-quarters of an inch off-set toward the side of the power stroke. This system of mounting cylinders greatly reduces angularity of thrust, and delivers the full power stroke to the crank with the least possible loss. It means smooth, even running of the motor, and the maximum of power at slow motor speeds. Cylinders are cast in pairs with valves on one side. The water jacket is liberal and is so arranged that the cooling water entirely surrounds the valves. These operate through push rods with rollers at the lower end. The upper ends of these push rods are made adjustable. Each piston is carefully fitted by grinding to size, and carries four rings which insure a tight compression and, therefore, the full force of every explosion.

The crankcase is of aluminum and in two pieces. The upper part carries the crankshaft bearings. These are made of the best nickel babbitt and are all split bearings so as to be readily adjustable. The bearings in the connecting rods are also of nickel babbitt and adjustable. The lower part of the case is divided by partitions into four oil pockets.

Good Lubrication Is an Essential Point.—The lubricating system is contained entirely within the crankcase. It consists of a positively driven plunger pump which maintains a constant level in the oil pockets. The constant dipping of the connecting rods in the oil pockets insures a continuous bath of oil to all interior parts. The pistons are provided with the usual oil grooves for lubricating the walls, and small pockets on the main bearing supports are provided to collect oil and convey it to the main bearings, which are grooved so that the oil after passing through them is returned to the crankcase.

The ignition system consists of a Reiny high-tension magneto with dry cells for use in starting. A four-unit coil is placed on the dash, with the exception of which the latter is clean.

Water circulation is made positive by the use of a gear-driven pump. The radiator is of the vertical flat tube type and thoroughly efficient. The fan runs on ball bearings and is driven by a flat belt from a pulley on the end of the camshaft. A neat device in the nature of an eccentric serves as a means for the adjustment of the belt.

The carbureter is of the latest float feed type, and is exceedingly simple. The air adjustments are permanently set at the factory, and the needle valve is the only adjustment necessary on the carbureter, for immediate use.

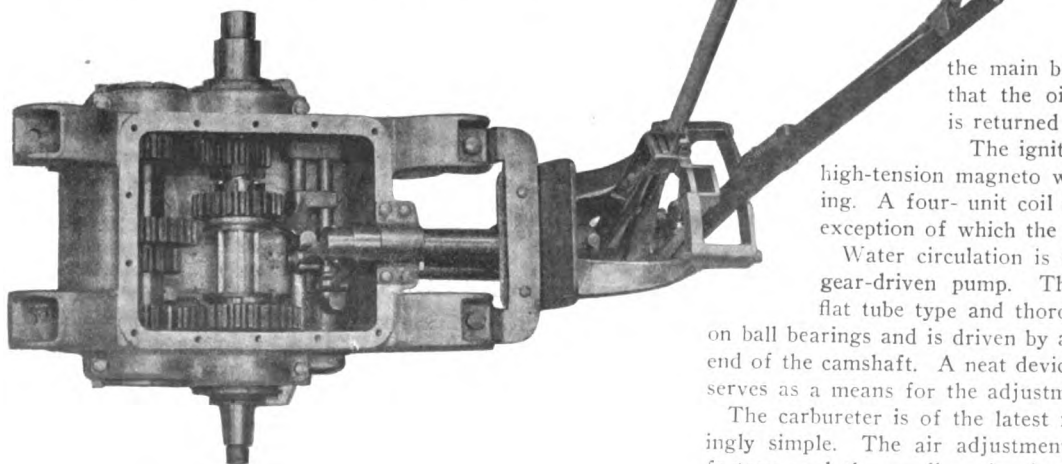

View from Above of Gears and Shifting Levers.

Perfectly Smooth Clutch Action.—From the motor, the power is transmitted through the clutch and a spring shock absorbed to the three-speed selective transmission. The clutch is of the three-disc type, the central or bronze plate carrying the cork inserts. A coil spring of easy external adjustment is utilized to press the steel discs into engagement. The usual ball thrust bearing is provided. Between the clutch and the transmission, acting as a universal joint, is a torsion shock absorber. It consists of two yokes attached respectively to the rear end of the clutch sleeve, and to the front end of the transmission driving shaft, and having coil springs between the outer ends. This arrangement acts as a cushion in the driving system and materially lessens the shocks, not only on the transmission and driving gears but on the tires as well.

Believing strongly in the use of good material, the Midland company have made the transmission gears out of the best of nickel steel accurately cut and carefully hardened. The nickel steel shafts are mounted on Timken roller bearings. The outer ends of these bearings are protected by dust-proof and oil-tight stuffing boxes which prevent the grease from working out and dirt from getting in. Roller bearings are used where part of the main drive shaft telescopes into the other part, thus reducing friction to a minimum and preventing sticking at this important part. The shafting fingers are contained within the case and there are no rods which slide through the sides of the case. The cover is the entire size of the gear box, so that when it is removed, the gears are thoroughly accessible. In fact, this question of accessibility has been carefully considered throughout the car. The gears are shifted by means of the inner hand lever which is arranged on a pivot at the lower end. When rocked inwards, the finger is picked up which operates the low and reverse. Rocked in the opposite direction, it catches the lever controlling the second and high speeds, the latter being the direct drive. The mechanism controlling this selective feature in the quadrant is distinctively Midland design, the strong feature being that the action is absolutely positive. With the hand lever thrown to one side, in order to engage one pair of gear combinations, the small lever which locks the finger for the other two combinations is positively forced into locked position without the use of springs of any sort. It will be readily seen that a positive action in this particular place makes it absolutely impossible to get two combinations of gears into mesh at the same time.

Roller Bearing Axles Well Proportioned.—The front axle is a one-piece drop-forging of liberal I-beam section and is mounted on roller bearings. The rear axle of the full floating type is of heavy gage drawn steel tubing with the differential housing in a separate piece to allow of ready removal.

The brakes are of both internal and external types and both are lined with thermoid lining. They may be applied in either direction, the external being applied by the hand lever, while the foot pedal operates the other. Both braking systems are equalized, as the chassis view shows.

Full-sized artillery wheels are used with the number of spokes proportioned to the work to be done. Convenience on the road is affected by using the same size of tires all round, 36 by 4. Wide open springs are fitted throughout, semi-elliptic in front and full elliptic in the rear.

Simplicity Marks the Control.—The control arrangements are very simple, two hand levers at the side, four pedals and the usual spark and throttle levers being the sum total. The pedals operate, in order from right to left, the service brake, the foot-throttle, muffler cut-out, clutch.

The chassis is fitted with a handsome touring body finished in Midland red, while the running gear is done in a lighter shade of the same. The tonneau, intended for three, is long and spacious for that number. Extra folding seats may be fitted to the rear part if desired.

The upholstery is of real leather, number one quality, and handsomely tufted. The seat and back cushions are made over coil springs of the highest grade of spring steel and consequently afford the maximum amount of comfort and long life as well.

The fenders are attractive in design yet protect the car and occupants perfectly. The usual space between them and the frame is absent, being covered by splash plates. A dust pan covers the underside of the mechanism and is quickly removable.

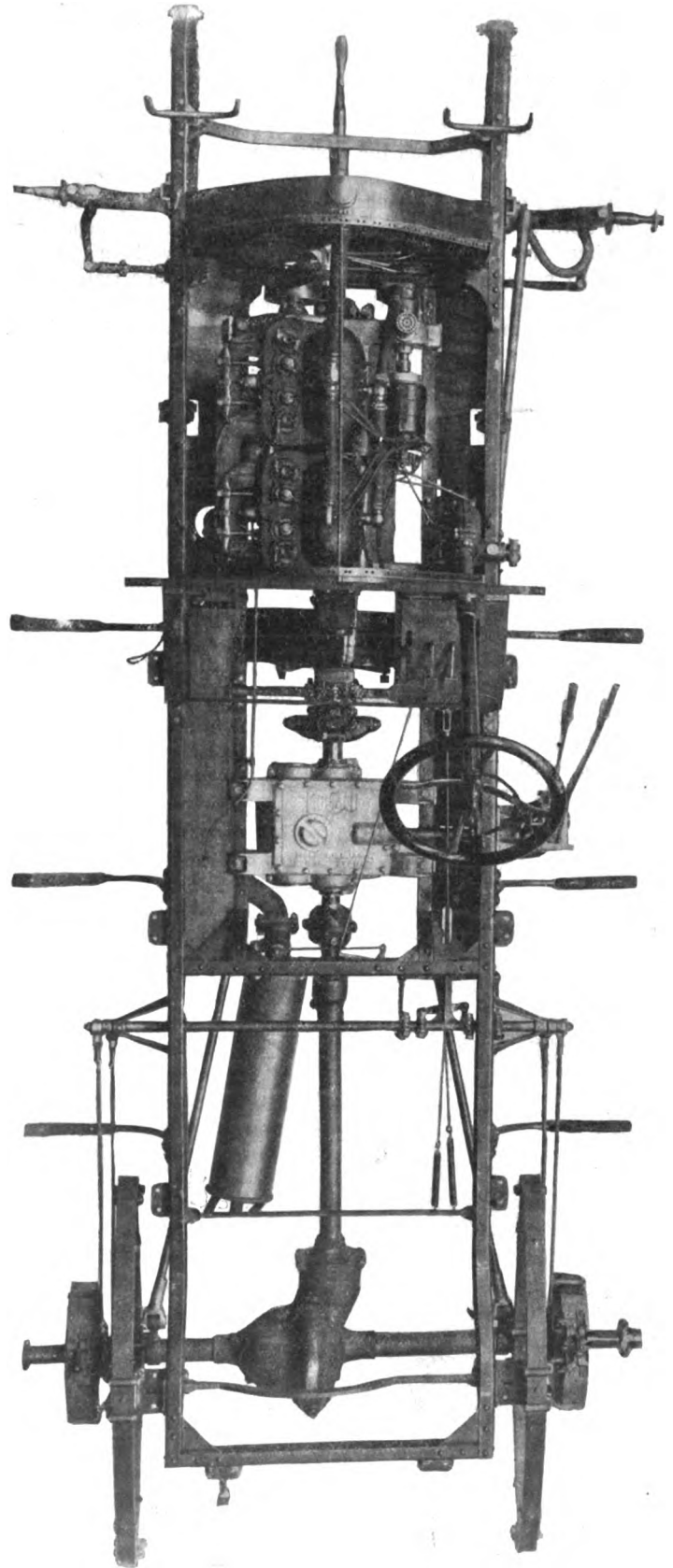

Chassis Has Both Strength and Beauty.

All bodies are ironed for tops and the included equipment is complete with oil side and rear lamps, acetylene headlights with a generator, tool kit and extra spark plugs.

REPUBLIC TIRE'S NEW HOME IN NEW YORK.

The Republic Tire Company of New York is now thoroughly settled in its new home at 229 West Fifty-eighth street, just off Broadway, and is better able to handle its increasing business than ever. The four floors have rapidly been arranged to best accommodate the firm in its trade, both in pneumatic tires, solid and mechanical rubber goods, and in repairing. The first floor is given over to the offices of the local concern, and at the rear to the shipping room. The mechanical goods and solid tires are handled direct from the Youngstown (O.) factory, and the second floor is used by this department. A large stock room, containing over 1,500 casings, valued at \$60,000, occupies most of the third floor and the fourth is used by the repair shop. Vulcanizers and machinery for caring for tires have been installed, so that nearly a complete new tire could be made right in the shop. In the basement there is space for storing mechanical goods, such as belting. There are large windows and skylights.

H. W. Pratt, as president of the New York firm, is assisted by Frank G. Hill, sales manager, and by C. R. Morceau, office manager. These men handle the bulk of the retail and wholesale trade themselves, and report that an increase is noticeable every week, although, of course, there is not the great picking up in spring business that there used to be before automobiles were used all winter long. The fact that the cars are used at all times, they say, is responsible for the steady amount of business done, and the Republic factory, at Youngstown, is working to the limit to supply the demand, not only from the metropolis, but from other cities as well.

FIRE DESTROYS MUCH IN RANDS FACTORY.

DETROIT, March 22.—Damage to the extent of between \$25,000 and \$30,000, partly covered by insurance, was suffered by the W. C. Rands Manufacturing Company, of this city, recently, in a fire which destroyed a large amount of stock awaiting shipment. Automobile tops, cushions and accessories, made by this concern, ready for shipment, were burned. The origin of the fire is unknown, but it started in the stock room. The entire factory will be rebuilt.

Dallas, Texas.—The Dallas Mfg. Co., handling Baker electrics in that portion of the State, has recently placed a contract for a fine up-to-date garage, which will be the best equipped in Dallas.

GOODYEAR COMPANY WINS LEGAL FIGHT.

AKRON, O., March 22.—A decisive victory in a long-drawn-out legal battle has been gained by the Goodyear Tire & Rubber Company, over the Consolidated Rubber Tire Company, in the denial by the Supreme Court of the United States, March 8, of the certiorari petition made to it by the Consolidated company for the second time.

The suit was begun in the spring of 1899 by the Consolidated company, and a decision adverse to the Goodyear company was appealed. In May, 1902, this was upheld by the circuit court of appeals. The Consolidated interests carried the case to the United States Supreme Court, and their petition was denied. About two years ago they obtained a favorable decision against another concern in the New York district, and opened the case with Goodyear, but for the second time their petition has been denied, so that the Goodyear company is free to sell solid tires in any part of this country, without itself or its customers being annoyed. This, however, does not affect other rubber tire manufacturers or their users, who are still assailed by the Consolidated company.

HANDSOME PIERCE TO TOUR EUROPE.

BUFFALO, N. Y., March 22.—One of the handsomest automobiles ever built, and one of a type that has never before been turned out in this country, was last week delivered to George K. Birge, of this city, by the Pierce-Arrow Motor Car Company. It will be used in touring Europe during the Spring, and has already been started on its journey, to join Mr. Birge, who sailed on last Saturday.

The car has a regular six-cylinder chassis of 60 horsepower, and it is in the body equipment and finishing that the art is especially shown. The body is of the landaulet style, with lines that are similar to those of old English stage coaches, seating two, three, or four people, in addition to the chauffeur. Behind the body there is a large permanent baggage boot, which holds three trunks of various sizes, in a black leather casing. The car is painted a brilliant chrome yellow, with just enough touching of black to form a pleasing contrast, and the interior is upholstered in hand-tooled leather, of a golden russet hue. The driver is well protected by a glass front set back several inches from the dash and a separate victoria top so shaped as to conform to the body lines. Many conveniences, not ordinarily provided, have found places in this admirable outfit.

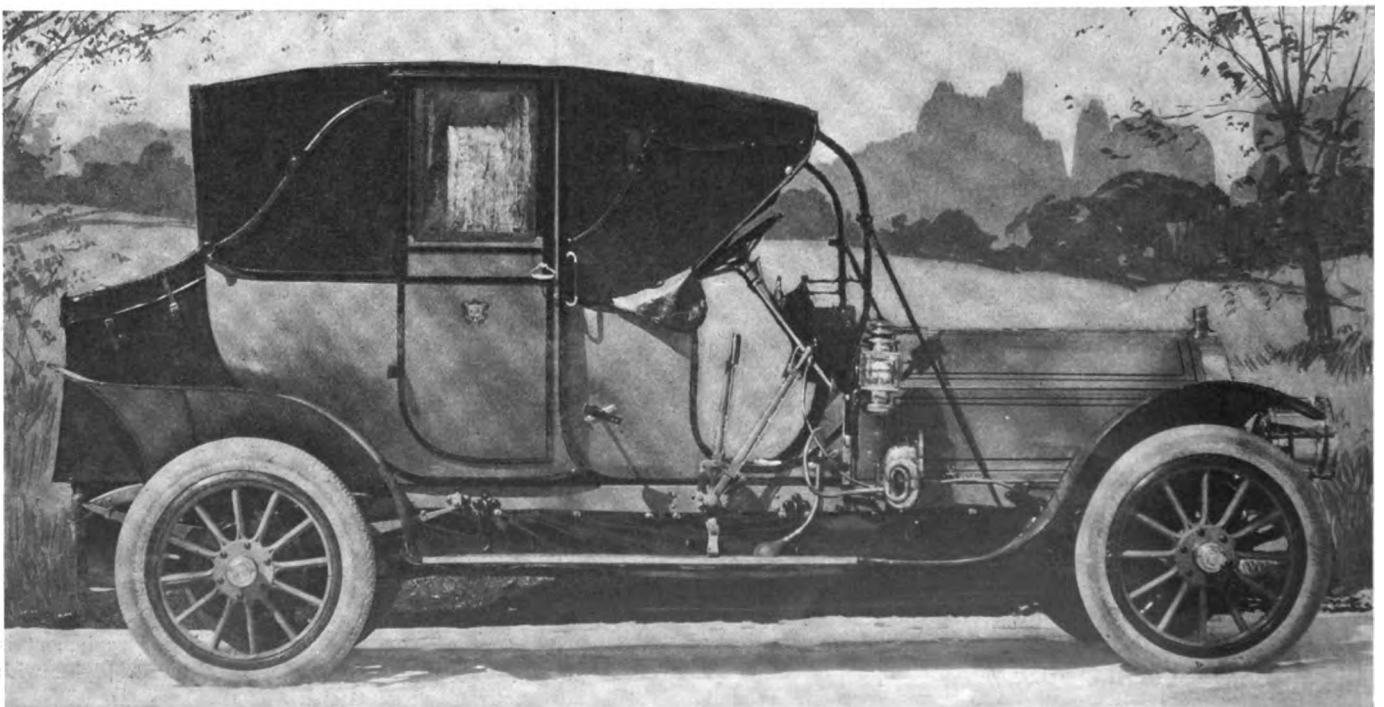

Pierce Great-Arrow with Old English Stage Coach Body, to Be Used on Continental Roads by George K. Birge, Buffalo, N. Y.



Rambler Touring Car Converted into a Garden Produce Truck.

J. Q. Adams, of Eagle Rock, Cal., has changed his 40-horsepower Rambler touring car into a truck capable of carrying nearly a ton of garden produce, the load formerly needing three wagons, at a much faster rate of speed.

Hints on Care of Tires.—"It is not sufficient that a careful driver should examine his car to see that the tires are not underinflated, and provides against overloading and remedies any defect in the rims; there are other things to be considered if one wishes the tires to last long," says G. M. Stadelman, of the Goodyear Tire Company. "The dashing driver who starts with a jump, throws on the high gear within a short distance and then drives almost to the desired point, stops, then slams on the brakes, will find that his tires will not last long. To put on a high rate of speed suddenly on a slippery pavement, or a sandy road, so that the wheels fly around, while the car is barely moving, is not conducive to long life of the tires. The man who runs his machine in the ruts along a country road, so that the sides of the tires scrape against the side of the ruts, and the man who bumps the sides of his tires against the curbing of the pavements will find that his tires die a sudden death."

Whitney Mfg. Co.'s Benefit Assn.—The annual meeting of the Whitney Manufacturing Company Mutual Benefit Association was held recently in the factory smoking room, Hartford, Conn., and officers for the coming year elected. They are as follows: President, Warren J. Belcher; vice-president, John J. Smith; secretary, Arthur L. Brown; treasurer, J. H. Triesbach; trustees, C. A. Pease, Chas. Johnson and R. J. Grady. The reports submitted showed a cash balance of \$500, and it was voted to admit the women workers in the shops, the present membership being limited to men, and 97 of these are on the roll.

Making a Big Hit in England.—There seems to be evidence at hand to prove that American automobile products are gaining a strong foothold abroad. A recent writer on the subject of brakes and brake lining in the London *Sporting Times* said in part: "I have an old-fashioned brake system on my car which has never been satisfactory until lately, when I lined them with a new stuff called Raybestos. Oil will not burn it out or carbonize. The braking efficiency is wonderful; I believe I could pull up on a one-in-four grade without the foot-brakes. The stuff is not cheap, but this is compensated by the wearing qualities."

Wheeler & Schebler Offer Trophy.—An order for a silver trophy, to be awarded by the Indianapolis Motor Speedway, has been placed with Tiffany & Company by Wheeler & Schebler, carbureter manufacturers of Indianapolis. It will cost about \$5,000, and will be 81-2 feet high, of dull-finished sterling silver. A figure representing Victory, holding out a laurel wreath, standing on a winged wheel, depicts the nature of the contest in which it will be won, while its international character will be shown by two other figures, one an American Indian and the other a European athlete.

More Americans for Philadelphia.—With its first allotment of 25 American cars sold, the Stoyle-Vogel Auto Company, of Philadelphia, has secured ten additional cars from the factory, making a total of 35, which, as Mr. Vogel says, "Is going some for a comparatively unknown product in old Phillie." The company has found its new show room, at the corner of Broad and Race streets, a success, using its former location on Spring street for storage and supplies.

Half of Winton Output Delivered.—More than half the season's output of Winton Sixes has already been delivered to purchasers, and of the remainder but few are available for sale. The Winton Company does not regard agents' blanket orders as sales, otherwise the announcement could be made that the output has already been oversold.

Ex-Secretary Newberry to Tour Europe.—T. H. Newberry, who was the Secretary of the Navy with ex-President Roosevelt, will sail for Europe on March 31, taking with him a Packard car. With his wife and daughter he will tour through France, Germany and Italy, spending months in these countries.

'Twas a 20-30 Renault Runabout.—Paul Lacroix, the general manager of Renault Frères Selling Branch, Inc., states that the car which he used in the run from New York to Boston was a 20-30-horsepower runabout and not one of 35-45-horsepower, as published.

Oakland Chassis Used for Instruction.—At the Rock Hill College, Ellicott City, Md., a chassis of an Oakland car is being used as a model for instruction in a mechanical drawing class.

BECKERS CHANGE POSITIONS.

CLYDE, O., March 22.—A change has been made in the management of the Elmore Manufacturing Company of this city, whereby B. A. Becker and J. H. Becker exchange the positions which they have been holding up to the present time. By a new arrangement the former becomes secretary and general manager and the latter treasurer. This is a change to duties more congenial to each and in no way will it alter the policy of the concern. The management of the entire factory, offices and sales departments will continue in the hands of these two men.

TAXICABS AND TRANSIT.

Atlanta, Ga.—This city now has a taxicab service, eight machines having been installed recently by the Atlanta Taxicab Company. This number, however, represents only the beginning, intended to show the people what the cab can do. More machines will be added later.

Los Angeles, Cal.—A new taxicab service has been started in this city, known as the Red Line. The Western Motor Car Company, responsible for this move, have put into service twenty Chalmers-Detroit taxicabs.

Menardsville, Tex.—An automobile line has been established between this town and Brady by Decker & Benchoff. A 30-horsepower Cadillac will make a round trip every day.

BUSINESS CHANGES.

W. J. Kells Manufacturing Company, New York.—The W. J. Kells Manufacturing Company, makers of the Kells honeycomb water coolers, has moved from its location in Jersey City to 726 and 728 Eleventh avenue, New York City, near Fifty-second street. Its facilities have thus been much improved and enlarged and in addition to making radiators and coolers it will also produce other automobile supplies, such as mufflers, hoods, mud guards, tanks, etc. An especially equipped repair department has been opened.

Bruns Automobile Company, Brooklyn, N. Y.—The Bruns Automobile Company, the agent for the Chalmers-Detroit, has moved from its quarters at 31 Grant square to its new salesrooms and offices at 1295 Bedford avenue. The old location will be used solely for garage purposes.

Midland Motor Car Company, Kansas City, Mo.—The Midland Motor Car Company, the Kansas City agent for the Peerless and Oldsmobile cars, has moved into its new quarters at 1606 Grand avenue. Spacious salesrooms and offices and increased garage facilities are thus secured.



Where Ajax Holds Forth in Boston.

IN AND ABOUT THE AGENCIES.

Thomas, New York.—Thomas cars will be sold in New York City hereafter by a branch of the E. R. Thomas Motor Company, under the management of W. B. Hurlburt and C. R. Teaboldt. This has been arranged through a mutually satisfactory agreement between the Thomas company and the Harry S. Houpt company, the latter having had the agency for these cars for several years. The branch management has already taken charge of the selling end of the business at Broadway and Sixty-third street, but the garage business will be continued by the Houpt company until April 1. The branch will be organized as the E. R. Thomas Motor Company of New York, and will carry on a business not only in the selling of automobiles, but also in supplying parts, and a fully equipped repair shop and garage will be conducted.

Crawford, Philadelphia.—The Thomas M. Twining Company, 326 North Broad street, has given up the Philadelphia agency for the Crawford, and will hereafter devote all its energies to popularizing the Regal in the Quaker City.

Cadillac, Aberdeen, S. D.—Northwestern Cadillac Company, formed by L. E. Horton, of Minneapolis, and Porter J. McCumber, of Wahpeton, N. D., to operate in States of North and South Dakota and Minnesota.

Crawford, Kansas City, Mo.—The Etwain Motor Car Company, 3701 Main street, has been appointed agent in this city for the Crawford car.

Premier and Reo, Chattanooga, Tenn.—Tennessee Automobile Company. H. Blacklock, president; R. A. Brantley, secretary and general manager.

Marmon, Chicago.—Adams Automobile Company, formerly agent for the Austin, 1420 Michigan avenue.

Smith, Kansas City.—The Hollister Motor Car Company have taken the agency for the Smith car, made in Topeka, Kan., by the Smith Motor Car Company.

Kisselkar, Kansas City, Mo.—Kisselkar Company, 1122 East Fifteenth street, C. A. Post, manager.

Ford, San Antonio, Tex.—Ford Automobile Agency, 124 Avenue D, for southwestern Texas.

Marion and Midland, Boston.—New England Sales Company, B. F. Blaney, manager.

Studebaker, Boise, Idaho.—Studebaker Bros. Vehicle Company, factory branch.

Lozier, Portland, Ore.—H. L. Keats Company, distributors for the State.

Chalmers-Detroit, Gloversville, N. Y.—J. A. Schmidt, for Fulton County.

Moon, Tulsa, Okla.—Wallace Automobile Company.

Moon, Louisville, Ky.—Kennedy Automobile Company.

PERSONAL TRADE MENTION.

Monte Cross, Autoist.—That the management of a baseball team, the covering of shortstop and automobiling make a good combination is averred by Monte Cross, the manager and shortstop of the Kansas City team of the American Association. After spending the winter in the Philadelphia branch of the Winton Motor Carriage Company, working in the shops, he has become a full-fledged automobilist and has just completed a trip from Pittsburg to Kansas City, Mo., with S. T. St. Clair, of the former city, in Mr. St. Clair's Winton touring car. A fast run was made in order to see the Kansas City show before its close, and also to start preparations for spring baseball practice, and not a bit of trouble was experienced, although Monte feels sure that he can repair anything that may happen to a car. He expects to sell automobiles when not playing baseball.

F. R. Bump, sales manager of the H. H. Franklin Manufacturing Company, is making a five weeks' trip through the Rocky Mountain States and along the Pacific slope, visiting Los Angeles, San Diego, San Francisco, Portland, Vancouver, Victoria, Spokane, Walla Walla, Pendleton, Boise, Salt Lake City, Colorado Springs and Denver, with stops at Omaha, St. Louis and Chicago.

George W. Squires, long identified with the automobile trade in Indianapolis, has accepted a position as city sales manager of the Finch & Freeman Auto Company, the agent for the Haynes, Richmond and Auburn cars.

William T. Skeggs, formerly with the Chicago Buick branch, has joined the sales force of the Centaur Motor Company, the agent in Chicago for the Oakland and Moon cars.

Frank G. Lowry, until recently advertising and publicity manager of the Moline Automobile Company, has now returned to his former occupation as automobile editor of the Indianapolis Star.

Alexander Winton, president of the Winton Motor Carriage Company, and Mrs. Winton are expected home from Scotland about March 27.

C. B. Smyth has become superintendent of the McKee Motor Car Company of Omaha, Neb. He was formerly with the Union Pacific.

RECENT INCORPORATIONS.

Wonder Manufacturing Company, Syracuse, N. Y.—Capital, \$40,000. To manufacture motor boats and automobiles. Incorporators: W. D. Boyle, G. T. Hurd, Bertha C. Cornwell.

Bi-Cal-Ky Auxiliary Spring Company, Buffalo.—Capital, \$100,000. To manufacture auxiliary springs for automobiles. Incorporators: C. H. Bicalky, C. H. Lockwood, F. J. Bommer.

Dow Rim Company, New York.—Capital, \$100,000, to manufacture vehicles, motor cycles and bicycles. Incorporators: F. J. Erwin, W. H. Heagerty, Emma W. Renne.

Napier Motor Company of America, Portland, Me.—Capital, \$1,000,000. To manufacture and deal in engines, motors. Incorporators: H. B. Clarity, F. T. Fagan.

Fiat Automobile Company, Chicago.—Capital, \$100,000, to deal in automobile supplies. New York corporation.

NEW TRADE PUBLICATIONS.

Firestone Tire & Rubber Company, Akron, O.—The latest book from the Firestone press is called "Progressive Locomotion," and, as its name would indicate, is devoted to the progress in vehicle construction made from the time of the Egyptian chariot down to the modern automobile. It is handsomely illustrated with decorative panels. The second section is given over to the oft-told story of the rubber tire, which is here told in a very interesting way. The methods used in gathering the juice from the tree and in preparing it after its arrival at the tire factory are described in detail with a series of well-chosen illustrations. One most interesting fact given is that the number of acres of trees now under cultivation is so large that there is no danger of a rubber famine. This conclusion might have been reached in another way by inspecting the views of the Firestone factory as it was originally and as it is to-day.

B. F. Goodrich Company, Akron, O.—Under the attractive caption of "What Tires Have Done as Well as This?" the Goodrich people are sending out a little book of 38 six by eight pages. This, as its title would indicate, is a record of the meritorious performances of Goodrich tires in the past season, although a pretty small book to chronicle such wholesale achievements. The series of very interesting vignettes scattered through the book picture the various routes over which the contests took place, the effect produced by the use of brown outs on white with a dark gray outline being excellent and most effective. Reproductions of letters and telegrams give a matter-of-fact appearance which is very convincing.

Diamond Rubber Company, Akron, O.—The opening sentence of the new motor truck tire catalogue is descriptive of the whole book. This says "getting right down to the ungilded facts . . ." Then follows a short, terse statement of the desirable qualities in motor truck tires, followed by an equally short and to the point statement of the good qualities of the wire mesh base tires. Sizes are given together with a description of the tire applying machine. A chapter on the proper care of tires and the various codes used complete the 32 pages of this 5 by 7 book.

Winton Motor Carriage Company.—"Price vs. Value," a book just issued by the Winton people, presents in detail the method adopted by the manufacturer in deciding upon a selling price and presents some inside facts not previously published.



One Shipment of Forty Reos in Front of the Poppenberg Motor Car Company's Building, Buffalo, N. Y.

INFORMATION FOR AUTO USERS

Ferro Two-cycle Motors.—One of the "stunts" of the Ferro Machine & Foundry Company, of Cleveland, O., has been the filing of suggestions for improvements. By taking the best of these, many improvements have been produced for the 1909

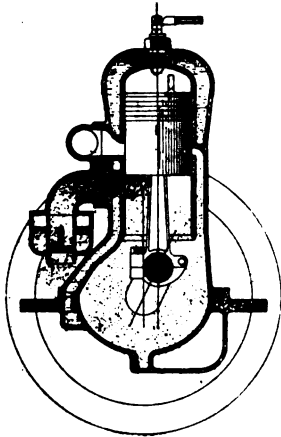

SECTION FERRO TWO-CYCLE MOTOR.

motors. Among the notable changes in the new Ferro motor is its offset crankshaft. This construction provides a slight deviation in the alignment of the cylinder center with the center of the crankshaft, so as to give the connecting rod practically a vertical position on the downward or impulse stroke. The merit lies in the transmission of energy from the piston directly down upon the crankshaft, reducing the

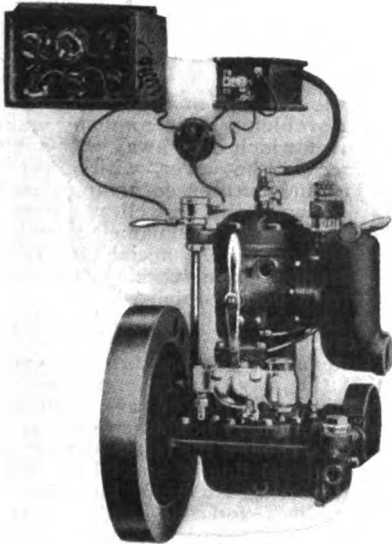

EXTERIOR VIEW FERRO MOTOR.

side thrust of the piston upon the cylinder wall, and, therefore, reducing the friction and wear upon these parts. It follows that greater power development is possible, which is evidenced in exhaustive tests made. Another marked improvement is the counter-balanced cranks on both single and multiple cylinder motors. This practically eliminates vibration. To withdraw the piston and connecting rod requires but the removal of the cylinder head and a plate in the crankcase. Through this hole the bearing is disengaged and the piston and rod can then be removed through the top of the cylinder, and the motor otherwise need not be disturbed from its foun-

ation. The bearings are so constructed as to be quickly replaced or adjusted. Briefly, they consist of babbitt metal, the lower half being made in the crank base, with ample length and diameter. The upper half is a bronze cup poured with babbitt and mounted upon several brass liners. To those patrons who desire make-and-break ignition, the company is ready this season to supply it. It is an extremely simple mechanism with a control lever, which also permits of reversing the motor. It is made attachable to all Ferro motors. After a series of thorough tests upon several designs, a clutch that will stand up to the full requirements of a marine motor without being a constant source of attention and worry has been produced. The company has installed new machinery especially adapted to produce their clutch, which is constructed so as to be directly attachable to the base of the motor, making it a rigid part of the engine frame, and not possibly giving rise to any lost motion between them. The adjustment of both forward and reverse brake bands are outside, easy of access, and a ball thrust bearing upon the after end of the clutch frame removes pressure from the working parts. Another appreciable attachment is the rear chain starting device.

Nightingale Whistle.—This whistle is manipulated by a foot pedal, and has a response which, for agreeable and vigorous effectiveness, appears to be all that the autoist can desire. It is manufactured by the Nightingale Whistle Company, 1693 Broadway, New York City, which calls attention to the fact that the whistle is in wide use, with an ever-increasing clientele. The whistle is connected with the exhaust of motors between the motor and the muffler in each case, and means are provided for effectively allowing the right amount of exhaust gas to enter the whistle



THE NIGHTINGALE WHISTLE.

and serve the end. Back pressure is avoided in that the exhaust is "shunted" into the whistle, hence the excess can go to the muffler. The whistle is of a convenient size, and while a rich melody is the sound which the whistle gives in normal town work, the fact remains that the autoist can project "a mile of sound" of the kind which will awaken a sleepy farmer who goes into a trance on his way home, leaving it to his horses to find the way.

White Tire Company.—Punctures, blow-outs and skidding; the gamut is run and the man with the car punctures the atmosphere in his vehemence. But this can all be as history, according to the makers of the "White," and as the illustration here given shows, years of experimenting in this direction ended in a tire which is so well protected as

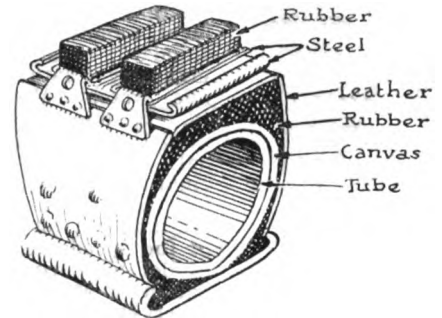

CROSS SECTION OF WHITE TIRE.

against the happenings of the road that autoists can well afford to sit up and take notice, as the saying goes. At the show room of the company at Broadway and Seventy-second street, a tire will be found on exhibition, and the genial representative of the company will be glad to explain. In the meantime it will be wise to settle down to the firm conviction that the tire is armored in a most effectual way, and the means of preventing skidding are in the fullest accord with pyramided knowledge.

Latest Warner Auto-Meter.—The latest additions to the line of products of the Warner Instrument Company, Beloit, Wis., are the models O and P, as shown in the accompanying cut. Model O is equipped with a 60-mile scale, while the other is for higher speeds and has a 100-mile scale. The speed indicator consists of the latest 1909 model with 100,000 mile total and 1,000 mile trip odometer. The clock is of the same high grade as, and is a fit companion for, the well-known Warner Auto-Meter. It is an eight-day movement with a special winding attachment, which does away with the necessity for carrying a key. The construction is such that the light from the reflectors is thrown on the dial only. It is claimed that with this method of illumination, the light is diffused evenly over the four-inch silvered dials, none being lost by outward reflection from the glass, as is the case when the light is placed outside of the instrument or clock.

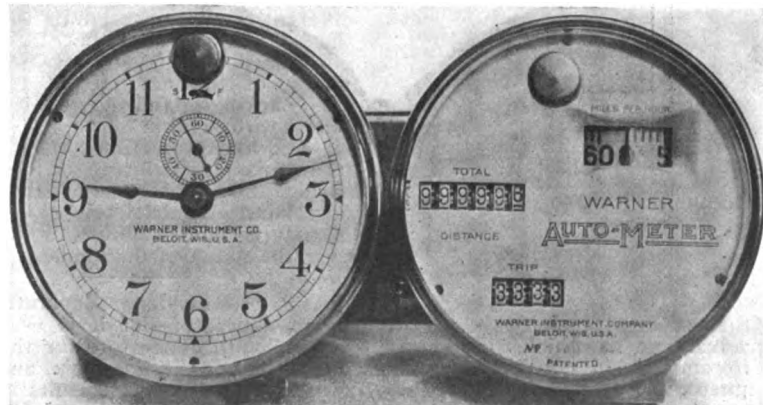

THE NEW MODEL O WARNER AUTO-METER, WITH 60-MILE SCALE.

New Models of Stewart Speedometers.
—In addition to Models 4, 5, 9, 10, 11, 12 and 13, already well known to the trade, the Stewart & Clark Manufacturing

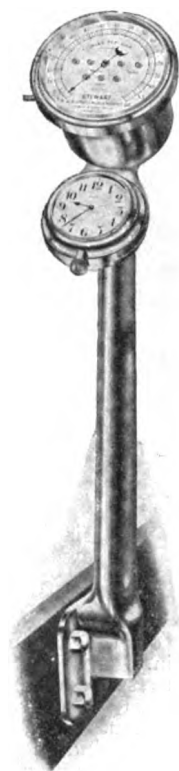

STEWART SPEEDOMETER, MODEL 14, AND SUPPORTING ARM.

Company, Chicago, has added the following speedometers to its line: Model 14, a combination of Model 11, sixty-mile multipolar instrument, mounted on a standard with an eight-day automobile watch; Model 15, a combination of Model 12, centrifugal type, and an eight-day automobile watch, the latter mounted on top of the speedometer; Model 16, a combination of Model 11, ninety-mile multipolar instrument, and an eight-day watch (this speedometer is equipped with diamond bearings); Model 17, a combination of Model 11, ninety-mile multipolar instrument, with Chelsea clock and electric light. This speedometer is also equipped with diamond bearings.

The standard used with Model 14, and which is shown in the cut, is a distinct innovation. It lifts the instrument away from the dash, with the view of making it more easily seen and read. A steel core runs through the standard to the instrument, which has a bevel gear connection with the flexible shaft at the bottom of the standard. This arrangement eliminates the necessity of bends in the shaft, and it runs straight to the wheel of the car. The standard is handsomely finished in brass.

Fawn Magneto Shows Nice Detail.—Of the open-circuit type, with a shuttle-wound armature, so divided that the control is automatic, in order to afford the same voltage at low, as at high speed. The timing of the spark is to a nicety,

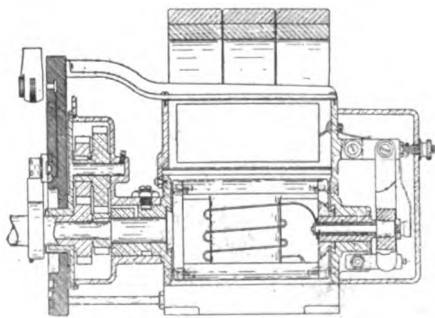

CROSS SECTION OF FAWN MAGNETO.

due to the use of a contact system, the further advantage of which, lies in the ability to employ, in conjunction with the magneto, any desired spark coil. For the purpose of advancing and retarding the spark a device called a timer-

box is used, and incorporated into the magneto. This device consists essentially of a system of gears and a sleeve arrangement by means of which the feat is accomplished, and the details of the plan are shown in the accompanying cross-section of the magneto. This magneto is made by the Fawn River Mfg. Co., of Constantine, Mich., whose literature is most complete and instructive.

Auto Repair Truck.—The latest product of the Motor & Manufacturing Works Company, Geneva, N. Y., is designed to save the chauffeur from getting his back full of oil and grease from the dirty floors of the garage. This auto repair truck, as it is called, is provided with casters, thus allowing the operator to lie on his back on it and propel him-

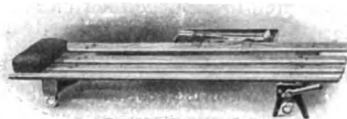

ADJUSTABLE AUTO REPAIR TRUCK.

self under the car to the place where the work is to be done or anywhere else in the room. A hand lever, which controls the back casters, may be thrown over, raising the latter from the floor and thus, anchors the outfit in the desired position. The truck is provided with a sliding shelf to carry tools and small parts. This is clamped to the side of the truck and may be removed, placed on the opposite side or in any desired position. The head rest is of real leather. The slats, which form the main part of the structure, are glued and screwed, making a strong, durable and light construction. As designed for the chauffeur or owner, adjustments and repairs may be made more quickly and more comfortably than could be done with a pit.

A Low-Priced Quality Spark Plug.—It is true, there are good spark plugs, but they run into money. What the Standard Sales Company, of 1779 Broadway, New York City, is engaged in, according to J. Stewart Smith, is the production of a superior spark plug, at the price of the other kind. The shell or body of the plug is made of machine steel in all standard sizes, as A. L. A. M. and metric-pitch threads. The Fry plug is made in open and closed types to suit the different requirements, and the insulation is either mica or porcelain, at the option of the purchaser. The packing gland is of brass with a thin annular ring-like projection at its inner end which acts as an equalizing spring, allowing for the expansion of the porcelain. An absolutely gas-tight joint is assured and stability is written all over the plugs of this make.



FRY SPARK PLUG.

Ashton Acetylene Separator.—It is not a generator but it is used in connection with generators, for the purpose of rendering the gas pure and capable of delivering the best results. The separator is attached to any part of the car between the generator and the lights,

but not so close to the radiator as to be influenced by the heat from the same. The separator is cylindrical in shape, 5 inches long by 1½ inches in diameter, and is provided with a bracket by means of which it can be secured into place. The principle in which the separator depends for its efficient action takes into account the property called inertia, in conjunction with the gravitational phenomena. The impurities in the crude gas, as it leaves the generator, are heavier than the gas, and they are shaken out, due to changes in direction in the separator, and the fact that the heavier compounds bombard the surfaces against which they strike. When the gas shakes off the heavy substances it is passed through a drying process and it is then fit to go to the lamps, for the purpose of delivering a steady, clear white light. The separator is to be had from W. E. Ashton and Dorr Company, 1415 Race street, Philadelphia.

Allen Tire Holding Specialties.—Several different kinds of tire holders, covers and locks have been exhibited at the shows by the Allen Auto Specialty Company, of New York, makers of these devices for overcoming a serious trouble to autoists. Extra tires are carried by all cars and how to do so without exposing them to the weather or to being taken

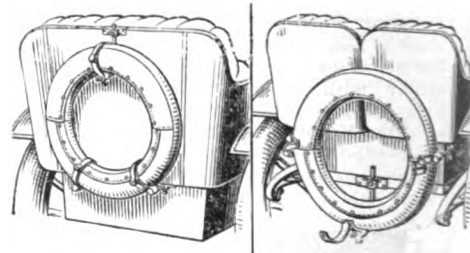

MODELS OF ALLEN TIRE HOLDERS.

from the cars when standing alone has been a problem. This company makes a tire cover which does away with the first nuisance in the cover, with a reversed overlap and buttons so arranged that it will fit a worn tire as well as a new one. These are made of enameled duck and are water-proof. A special type is made for Stepney spare wheels. To prevent tires from being stolen several types of locks are made for large and small sizes, that can be fitted in a running board set or fastened at the back of the car and out of the way. In order to accommodate different styles of cars a number of kinds of ordinary holders are made, without locks, though the latter may be fitted. An additional line of specialties is made for protecting steering knuckles, universal joints and gas and oil lamps. These are of leather or enameled duck.

Crown Sanitary Flooring for Garages.—Sanitation, in connection with a garage is quite important but it is of small purport as compared with sanity, as it relates to the dangers which lurk in an oil-soaked wood floor. Robert A. Keasby Company, of 100 North Moore street, New York City, makers of sanitary flooring, made a study of the conditions which abound in garages and reached the conclusion that it is the height of folly to take such risks as must be present if the floor is of wood, and if oil is allowed to saturate the wood, as it is sure to do, if the wood is not protected. Crown Sanitary Flooring is fire, water and acid proof and it is widely used in garage work.

THE AUTOMOBILE

TEAM SCORES IN ATLANTA'S MEET

By Percy H. Whiting

ATLANTA, GA., March 27.—Roaring and whistling like a tea-kettle run mad, a Model K White Steamer, driven by "Bob" Lambert, hurled itself up the nine-tenths of a mile of the Stewart avenue hill this afternoon in 45.4-5 seconds, peeling 5.2-5 seconds off the best previous mark and winning the free-for-all of the Fulton County Automobile Club's third annual climb.

A Stearns Six, 1908 model, owned by Ed Inman, president of the club, and driven by A. H. Almand, which was the only other starter, was an entertaining second, covering the distance in the rattling good figures of 48.2-5 seconds, 2.4-5 better than the same driver drove a 1907 Stearns four-cylinder last year, when he won the free-for-all and put a second leg on the Atlanta *Journal's* big cup.

So impressive had been the time trials of these two cars during the two weeks' practice to the climb that they had the free-for-all to themselves. The race was run at the close of a six-event program and evening was closing in before the White got away. With Lambert at the wheel and Stupka cuddled down behind the dash, the car got away to a whirlwind start, reaching full speed in an incredibly short time and keeping or increasing it every inch of the way up the incline. Like the proverbial "lost soul," it whistled and howled, emitting much humming from its burner and most impressive snorts from the exhaust, but its speed seemed to increase even on the stiffest part of the grade and as it charged across the finish line and down the other side of the hill toward Atlanta it was clear that all records were broken.

The free-for-all in Atlanta appears to bear a charmed existence; that is, charmed for misfortune. Last year it was marred by a disagreement over the actual time made by one contestant that resulted

in much unpleasantness at the time, and afterwards in a row at Atlanta's most exclusive club that occasioned much scandal. This year the timing apparatus, which had stood a hard day's service without an error being charged against it, went "out of whack" after the White Steamer started. The automatic timing "jigger" received the signal that the car was off, but never one that told of its arrival. However, the many watches at the finish, which were used as a check on the official record, caught the White in 45.4-5.

Then followed much wrangling as to whether or not the White should run the race over again. Before the argument was settled the Stearns came up. It was garage gossip that Almand was exploding equal parts of gasoline, picric acid, dynamite, profanity and nitroglycerine in his motor, and certain it is that it sounded like a goodly battery of gattling guns as it popped and flew up the incline.

The official clock, back in running order again, caught the Stearns in 48.2-5 seconds. After this time was flashed there was more argument, but finally Ed Inman, owner of the Stearns, withdrew his claim on the cup, afterward qualifying this withdrawal by protesting the White on the ground that it was not a stock car. This protest subsequently was dismissed by the contest committee.

Aside from this annual "incident," the day was without mar or blemish. The weather, though not sunny until toward the end, was warm, and there was little wind. Such efforts as Boreas put forth were directed straight up the hill.

All these things conspired to make the day a perfect one from the spectators' viewpoint, and the onlookers came as never before for a climb in Atlanta. Despite the fact that the hill is nearly two miles from the nearest car line, several thousand people

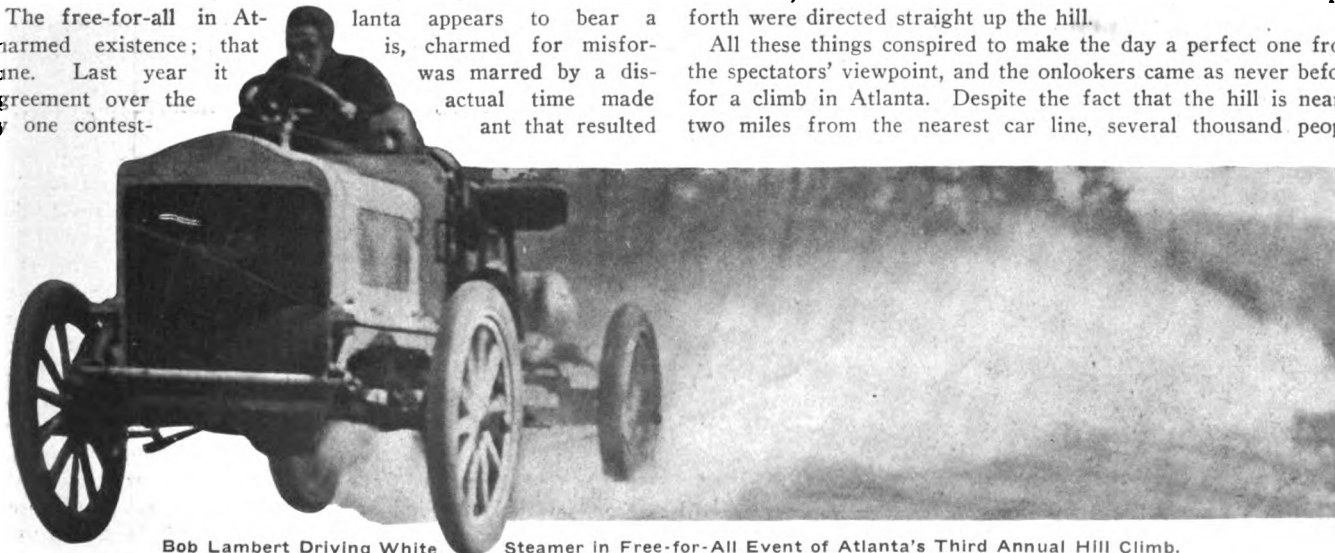

Bob Lambert Driving White Steamer in Free-for-All Event of Atlanta's Third Annual Hill Climb.

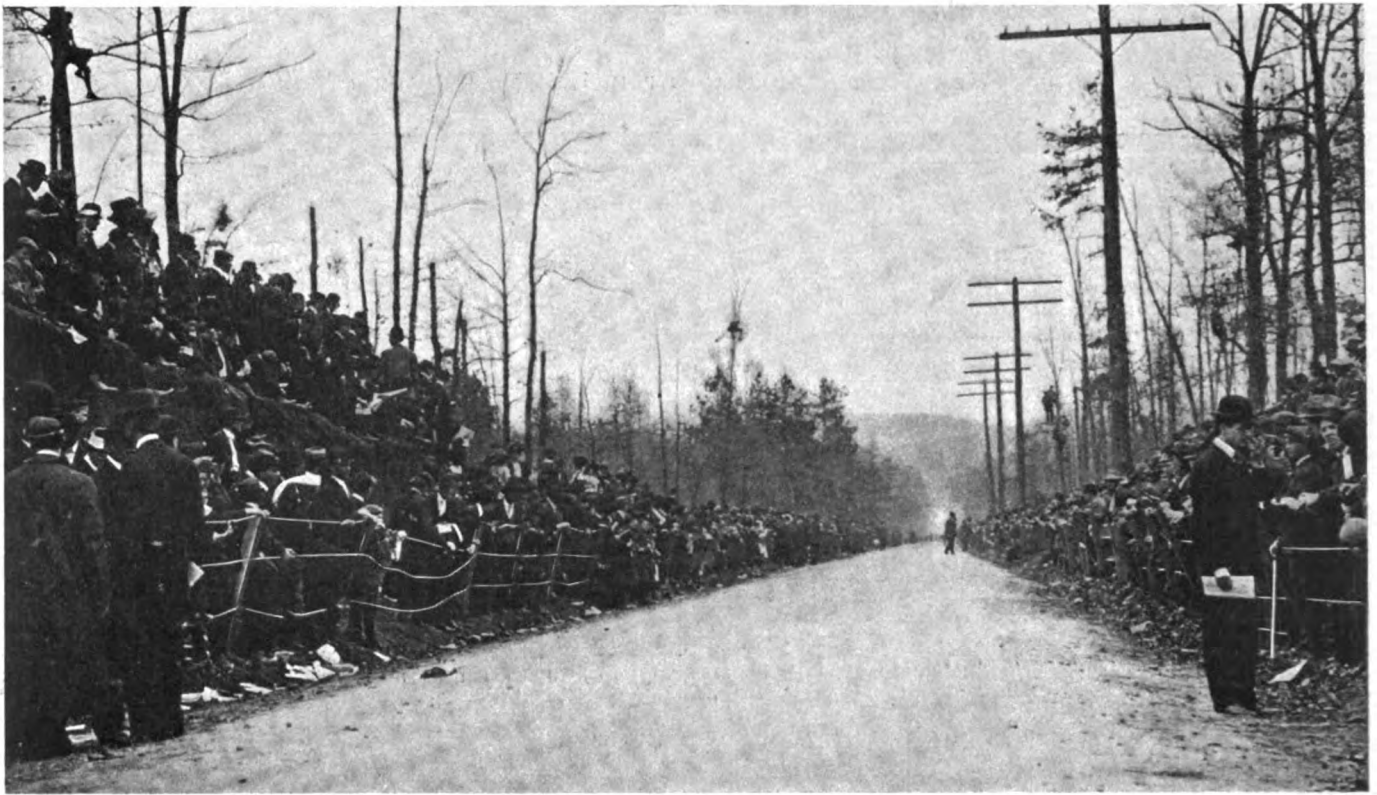

Excellent Guarding of the Course Was One of the Marked Features of the Atlanta Hill Climb.

trudged out to the finish line, and these, with the reinforcements that came in autos and other vehicles, brought the number up to 5,000 at least. As for automobiles, verily, the woods were full of them. They lined both sides of the course, and certainly no such gathering was ever before seen in Georgia, save for the notable exception of the Savannah Grand Prize.

The officials broke all Atlanta records by getting away the first event in good time. This was a motorcycle affair and was followed by the first automobile class, for cars costing \$900 or less. From that time forward to the free-for-all it was somewhat of a field day for the Buicks, which were hauled into Atlanta on the tail of the "Florida Flyer" the day before the race. With such old celebrities as Strang and Burman, and with the newest discovery, Dewitt, all fresh from Daytona, they swept away three out of five firsts in the "limited price" classes. A little E-M-F. won in the big second class, covering the hill in 1:08 and defeating a field of ten starters.

Class 3 for touring cars costing \$1,500 or less, was a safe victory for a Pope-Hartford. The individual hero of the day was Jones, nicknamed "Daredevil," a local boy, who drove the two winners last named.

Here is the summary:

Class 1 (cars costing \$900 or less).—Buick, Travis, 1:15, first; Buick, Cantrell, 1:21, second; Ford, Hule, 1:23, and Ford, Brown, 1:23, tied for third; Lambert, McNeal, 1:49 4-5, fourth.

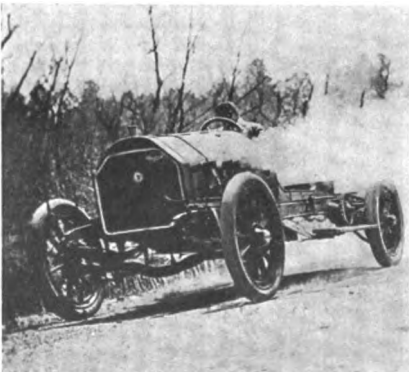

Stearns, Almand Driving, Best Gasoline Performer.

Class 2 (cars costing \$1,500 or less).—E-M-F. Jones, 1:08, first; Buick, Chalker, 1:11 1-5, second; Buick, Travis, 1:14, third; Buick, DeWitt, 1:14 2-5, fourth; E-M-F. Atkins, 1:15 1-5, fifth; Ford, Brown, 1:21 1-5, sixth; Chalmers-Detroit, Smith, 1:22 1-5, seventh; Lambert, McNeal, 1:24, eighth; Ford, Hule, 1:28 1-5, ninth; Overland, Stewart, 1:29 2-5, tenth.

Class 3 (for touring cars costing \$3,000 or less).—Pope-Hartford, Jones, 1:04 4-5, first; Pope-Hartford, Stoddard, 1:05 1-5, second; Buick, Burman, 1:08, third; Selden, Woodam, 1:19, fourth.

Class 4 (for runabouts costing \$3,000 or less).—Buick, Strang, 1:05 3-5, first; Stevens-Duryea, Henderson, 1:02, second; Ford, Hule, 1:05 4-5, third; Maxwell, 1:15 2-5, fourth.

Class 5 (for touring cars costing \$5,000 or less).—Buick, Burman, 1:04 4-5, first; Pope-Hartford, Stoddard, 1:05, second; Pope-Hartford, Jones, 1:06, third.

Class 6 (for runabouts costing \$5,000 or less) called off for lack of three starters.

Exhibition, Buick runabout, Strang, :59.

Class 7 (free-for-all).—White Steamer, Lambert, :45 4-5, first; Stearns, Almand, :48 2-5, second.

White Wins San Francisco Hill Climb.

SAN FRANCISCO, March 29.—In the hill climbing carnival held here to-day, a 20-horsepower White Steamer made the fastest time of the day. It was barred from stock car events, but a special match race was arranged between it and the winners of the stock races. This it won, its time for the mile being 1:12 2-5.

DATE SET FOR LOOKOUT MOUNTAIN CLIMB.

CHATTANOOGA, TENN., March 29.—Chattanooga's great mountain climb, up historic Lookout Mountain, has been set for April 23, and active preparations are now being made by the Lookout Mountain Automobile Club for holding the event, and for entertaining the large number of visiting autoists. The contest has been given the support of the Chamber of Commerce of this city, and six handsome trophies have been donated by large social and commercial organizations. The program will include events for seven different classes of stock machines and a free-for-all.

Lookout Mountain stands over 2,000 feet above the city of Chattanooga, and the course will be from the bottom to the summit, a distance of four miles by a road which is replete with hairpin, triple S and W turns. It is pronounced as the most dangerous and difficult climb ever scheduled, and will rival those of Giants' Despair at Wilkes-Barre, Pa., and of the Climb to the Clouds upon Mt. Washington, N. H. It will be equally picturesque.

INDIANAPOLIS HAD A BIG WEEK.

INDIANAPOLIS, IND., March 30.—Local dealers estimate that the number of automobiles sold during the annual spring opening last week had an aggregate value of \$450,000. Not less than 300 cars were sold during the week, and of these a large proportion were touring cars costing above \$2,000.

The show concluded Saturday night with a banquet at the Denison Hotel. Mayor Charles A. Bookwalter was the guest of honor, and delivered the principal address. Other talks were made by dealers, manufacturers, and their friends.

Under the auspices of the Indianapolis Automobile Trade Association, an egg race and tire changing contest were given Tuesday afternoon, while a parade and an obstacle race were held Friday afternoon. Inclement weather necessitated changes in the program. The results of the various contests were:

Egg Race—Buick, driven by Mr. and Mrs. W. V. Peterson, first, time, 33 $\frac{3}{4}$ seconds; National, driven by Thomas Kincaid and Miss Mary Aitken, second, time 35 seconds.

Demountable Tires and Rims—Won by Edgar Apperson, driving an Apperson equipped with Diamond demountable tires and rims; time, 1:43.

Clincher Tires—Won by Charles Starr, driving a Premier equipped with Diamond clinchers; time, 2:59.

Detachable Tires—Won by T. K. McCune, driving an Auburn equipped with Goodrich detachable tires; time, 2:09.

Obstacle Race—Won by George L. Bixby, driving a Waverly electric, distance two squares, perfect score; time, 1:06.

Because of rain it was necessary to postpone the parade until Friday afternoon. More than 350 cars were in line, including everything from \$500 runabout to a three-ton truck. The Indianapolis Motor Car Company was represented by 50 Rapid trucks that are in daily service in the city. These included the police patrol wagon. The city dispensary ambulance, just completed by The Waverly Co., was also shown for the first time.

There were two bands, both riding on trucks. One of these was a "rube" band in grotesque costumes.

There were 47 Overland cars in the parade, entered by the factory and by the Fisher Automobile Co. These included all of the models manufactured by the company.

The Premier, National, Marmon, and American factories, as well as the Cole Carriage Company, were well represented. Each car was filled with its full quota of passengers, while the commercial cars were loaded with merchandise.



E-M-F Which Scored in Class Costing \$1,500 or Less.

CLEVELAND'S QUOTA FOR GLIDDEN TOUR.

CLEVELAND, March 29.—Cleveland may take an active part in the 1909 Glidden tour, although if the local manufacturers do not display more interest than at present, it is doubtful if the entry list from the Forest City will be overly large. What the Peerless people will do is not yet known, but the general impression is that the Peerless will not be found in the 1909 run. No definite announcement has been made to this effect, however. Nothing is expected of the Stearns, although the influence of Chas. B. Shanks may alter things somewhat. The Winton people are out of all contests, of course, while the Royal is looming up as a dark horse. It is said that considerable pressure will be brought to bear on the officers of the new company to enter the contest.

Entries are confidently expected of the White sterner. Last year the Whites were ready to start for Buffalo when a change in the plans were made. The White people, following their usual custom, will make no formal announcement of their plans, but to see Walter C. White and others in White cars cross the starting tape will surprise no one. At least one entry, that of Paul Gaeth, is assured, and he may increase this. Mr. Gaeth had a perfect score last year, and is in favor of entering again this season. There is a chance that the Studebaker entries, if they are made at all, will be from this city.



There Were Those Who Must Be Exactly at the Finish Line, which,

of Course, Was the Storm Center.

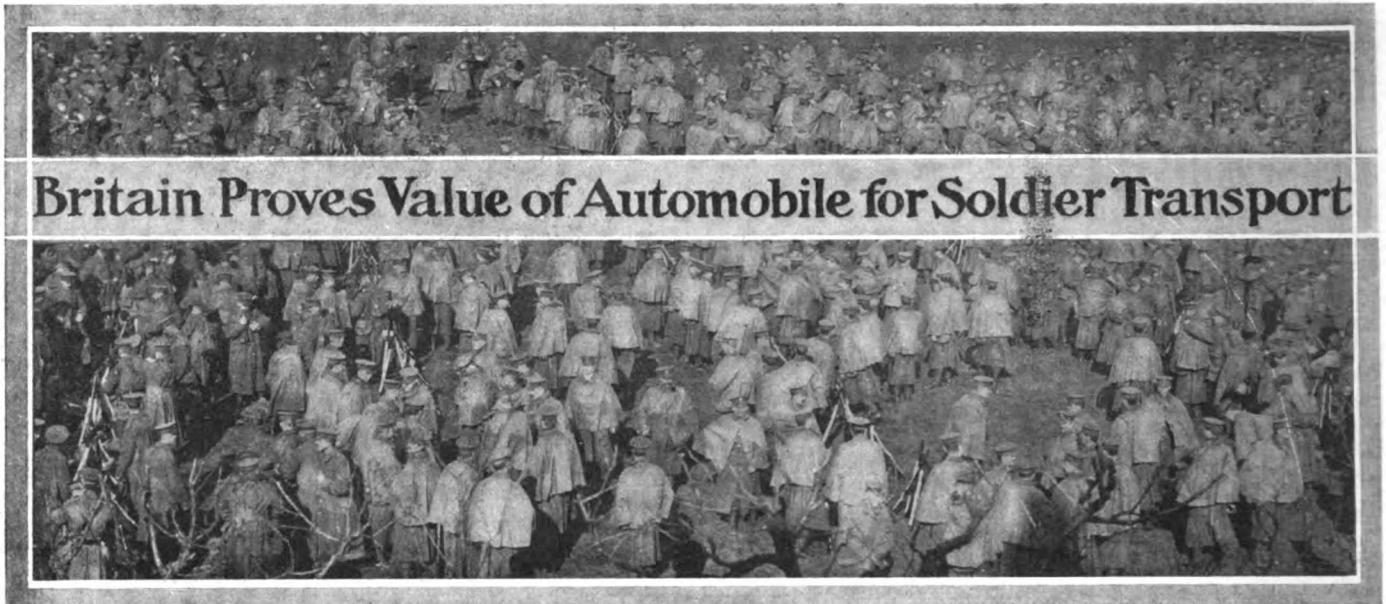

Britain Proves Value of Automobile for Soldier Transport

Troops Assemble in Preparation for Overland Journey to the Southern Coast of England.

LONDON, March 18.—To prove the extreme value of automobiles for the rapid transportation of troops in time of war, the Automobile Association yesterday conducted what was probably one of the most important happenings in the history of all England, by conveying a detachment of 1,000 troops, with full stores and equipment, from this city to Hastings, on the South coast, and return on the same day. The presumption was that an enemy had landed, where "William, the Conqueror" put in his appearance 813 years ago, and had occupied the railroad, so that there would have been no quick method of transportation without the use of automobiles.

The War Office showed a great interest in the scheme, and a battalion of His Majesty's Guards was detailed for the experiment, consisting of over 1,000 men, with machine guns, baggage, food and stores, weighing over 30 tons. The automobile trade and members of the Association responded to a really remarkable degree, and actually over 400 cars were assembled, to take part in the wonderful demonstration, not only of the practicability of the machines, but also of the thorough organization of the Association. The big squadron was divided into eight sections, each with a different colored flag to designate the cars, and there was hardly a hitch in the plans for the day. Even the farmers and others on the route, who were requested to refrain from traveling upon the highways, complied with the request, and almost no vehicles obstructed the progress.



Start of Automobiles from London.

The first section, A, consisted of 12 automobiles, used by Lieut.-Col. Erskine, scouts and headquarters of the battalion; with the commanding officer, his adjutant, signaling officers, and bugler in one of them, and two vehicles were reserved in case of breakdown. Section B consisted of 65 automobiles, carrying two companies of the 1st Scots Guard under Captain Van der Weyer; section C included 66 cars, with Captain J. B. Arbuthnot and two companies of the 2d Scots Guards; section D was also made up of 66 cars, with one company each of the 2d and 3d Grenadier Guards, under Captain Vivian, of the former; section E, 66 cars, with two companies of the Coldstream Guards, under Captain Stewart, completed the division with the main body of troops. Section F was composed of 7 touring cars and 21 light lorries, and was known as the machine gun section, inasmuch as it carried the reserve ammunition, light artillery, personnel, all stores for the first line transports and two water carts, under the command of Lieut. Maitland of the 2d Grenadier Guards. Section G had four touring cars and 7 three-ton lorries (trucks), to carry the personnel and stores of the second line of transports, under Lieut. Barrington-Kennett of the 2d Grenadier Guards. The eighth section was really a free-lance one, carrying officers of the General Staff and other military authorities.

The first preparation for the event was made on Tuesday afternoon, when in 45 minutes 21 light lorries, five 'bus chassis with platform bodies, and three large three-ton vehicles were loaded with the stores, ammunition, etc., at the Chelsea Barracks, and then put under shelter for the night. These machines carried all kinds of impedimenta, such as kitchen utensils, trenching tools, bedding, the commissariat department, besides the guns. The first move on Wednesday, yesterday, morning was made by section G, which left the Barracks at 7.30, and proceeded to a point near the Crystal Palace where mobilization was to take place; joined soon after by sections A, B and C, which left the Wellington Barracks at 8.45, 143 cars being in line. In divisions B and C there were half a dozen empty cars for emergency.

Section D, E, F and the others soon formed and at 9.45 the bugle was sounded for the first car to get under way, the organization being so well regulated and completed that by 10.15 every one of the nearly 400 machines was en route to Hastings, and there had been little friction in getting them off. One car had a puncture, another caught on fire and a third had motor trouble, and the spare cars then had a chance, but these incidents were almost unseen in the great number. Only once did a section get out of place, a part of D leaving slightly ahead of its position, but this was quickly rectified, and the trip successfully continued. All along the route the soldiers were heartily cheered by towns-

folk and countrymen, and the men in the cars seemed to thoroughly enjoy the novelty of their outing. A great many of them were having their first ride in automobiles, and little appeared to realize that there was another significance in the performance, other than that of a mighty pleasant day's ride to the coast. The drivers of many of the cars were well-known autoists, business men and sportsmen, who seemed to enjoy the run as much as the Guards. Of course there was a large delegation of professional chauffeurs. The majority of the cars were donated by the private members of the Association, as distinguished from the trade, and there was little effort made by dealers represented to advertise their cars.

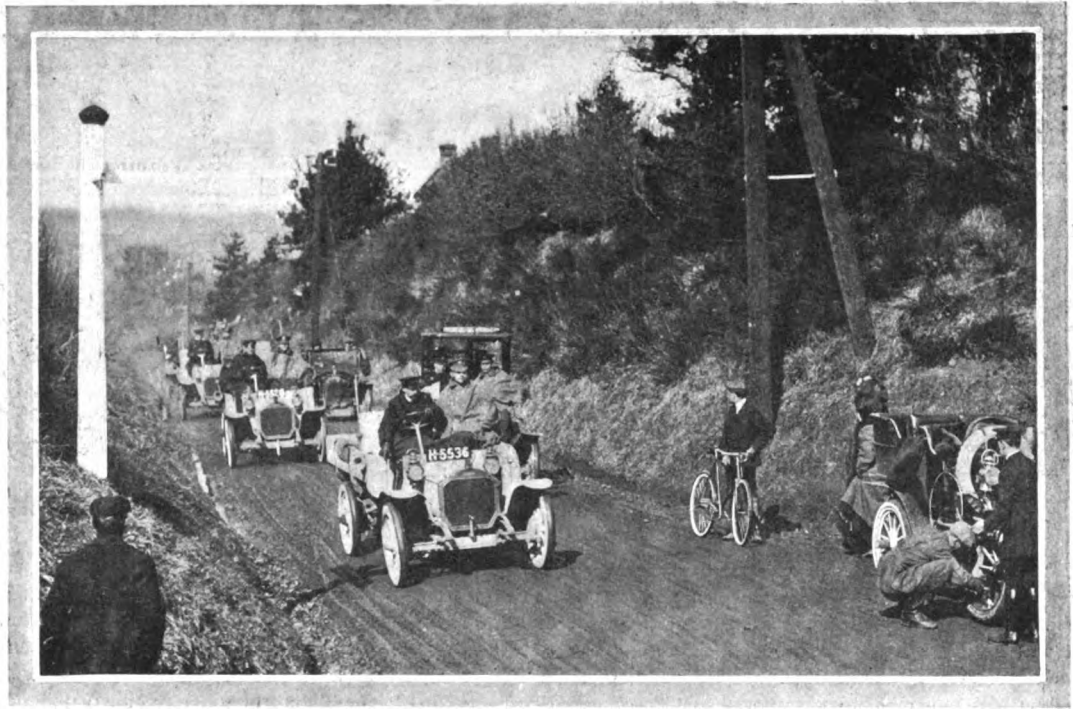

Part of Artillery Section, in Commercial Cars, near Penbury.

Arriving at Hastings, the troops quickly left the machines and formed in company lines along the roads. A short drill showed that they would be immediately ready for action, if necessary. The whole body of men was entertained at dinner, not a single cent having to be expended by the War Department in the entire program. The troops reassembled on the Cricket Grounds, and the return to London started at 3 o'clock, reaching the barracks by seven.

The strong outcry last year against the use of racing cars on public roads is having a marked effect on the prices of second-hand automobiles of this type. During the past season many of the famous victors of previous years' contests have changed hands at low figures, but the limit was about reached at a sale here last week. A 135-horsepower Mercedes which ran in the 1907 Grand Prix changed hands for \$2,700, while a 120-horsepower Mercedes, dating from the 1906 race, brought \$2,350. The price of a runabout—\$1,200—made some speculative individual the proud possessor of a 90-horsepower Mercedes of no great age, and at the same figure a 100-horsepower Darracq, which won the Montague cup at Brooklands, is still awaiting a buyer. If the speed craze is still in vogue in the United States, buyers will find much to interest them on this side of the water.

BRITAIN'S BIG CLUB ISSUES EDICT.

LONDON, March 18.—For several years the Royal Automobile Club has barred all trials and non-stop runs, save those held under its direct supervision. There have been occasional evasions of this rule, but now the Royal Automobile Club has taken a firm stand, and any maker who advertises the result of an unofficial trial, whether such trial was run by themselves or not, will be debarred from entering for any future competition of the club.

In addition to the annual reliability trials of the Scottish and Irish automobile clubs, a small car trial will probably be organized by the Royal Automobile Club this Summer. The trial of headlights will also be held. During the coming week an interesting trial is to be made of the new Daimler engine. Under close supervision of the club officials a 38-horsepower engine will be run on the bench at full load for seven days and seven nights without a stop. At the end of this time the engine will be erected on a chassis and run for 2,000 miles at Brooklands at top speed.

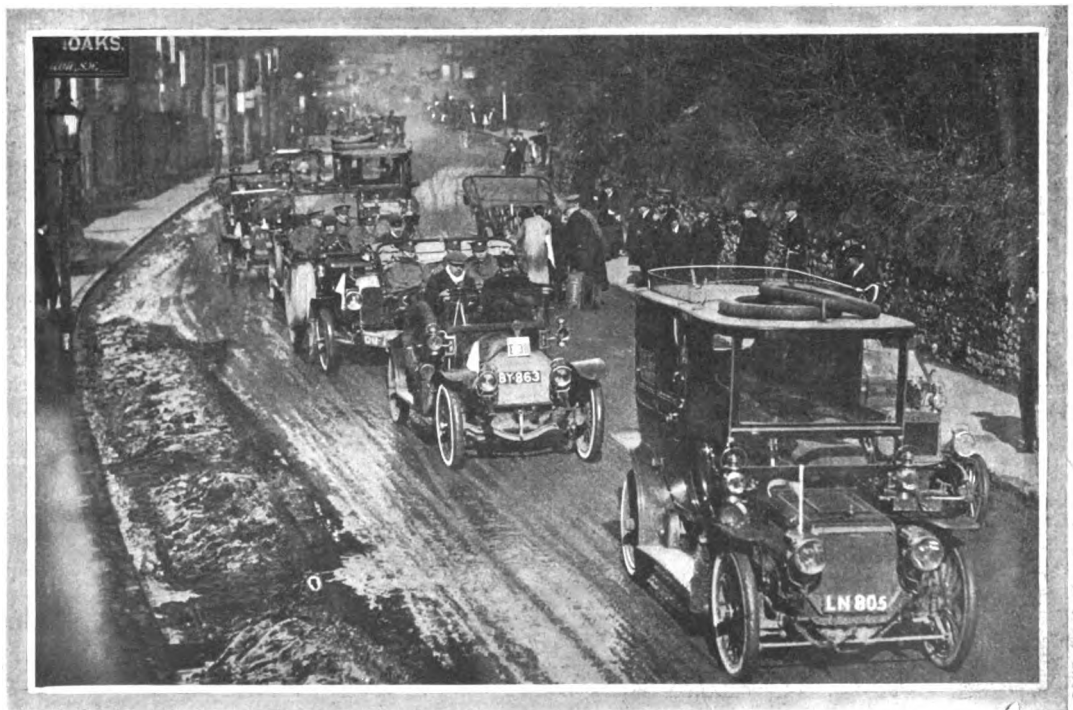

Military Rush of Men and Cars Through the Town of Penge.

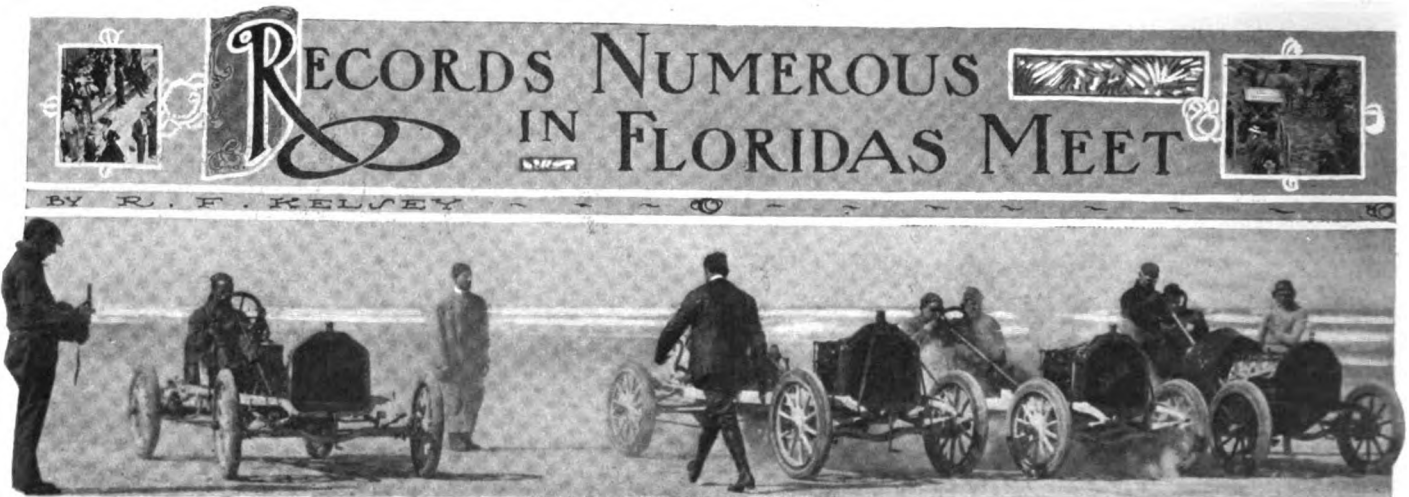

Where the Cars Lined Up for the Start of the 100-Mile Stock Car Race on the First Day of the Meet.

DAYTON, FLA., March 27.—If the breaking of records is the standard by which the seventh annual tournament of the Florida East Coast Automobile Association is to be measured, it will go down upon the pages of history as one of the best of its class. Certain is it also that the attendance of the general public was never as large. In the matter of entries of the "big fellows" the field was small but "classy," though in the stock car race and the handicaps there was plenty of competition of a highly exciting nature. The motorcyclists and bicyclists added much to the entertainment, and made some good competition, as well as accomplishing much in the matter of establishing new records.

Certainly Mother Nature was in active sympathy with the management, and did her best to place the hard-sand course in the most perfect condition. A stiff northeasterly breeze on Monday tossed the breakers high on the beach and made it as smooth as though it had been shaved with a planer. On Tuesday, the opening day of the tournament, the wind veered to the south and came straight up the course, and this condition continued Wednesday. Thursday the wind was from the west, but it was limited in quantity and of no particular aid or detriment to the contestants. The day the programme was completed, Friday, there was a breeze directly from the east, which was at times chilly, and which later veered to the southeast and helped some to bring the competitors up the stretch in very fast time.

Where and to Whom the Honors Went.

To the 120-horsepower Benz, which successfully captured three world's records, belongs the first honors of the meet. It went out of commission with a broken piston at the conclusion of the second day, but not until David Bruce Brown had set a new world's mark in the amateur class for the mile of 33 seconds flat, and had placed the professional competition record for ten

miles at 5:14 2-5, an average of 31 and 44-100ths seconds to the mile, and at the rate of 114 1-2 miles per hour. George Robertson, who last fall drove the Locomobile to victory in the Vanderbilt Cup race, piloted the Benz in one race, the five-mile invitation, and set a new competitive mark of 2:45 1-5. True, the Benz did not have an opponent that was in its class, Kilpatrick's Hotchkiss having become disabled early in practice work, and the Fiat *Cyclone* was its only competitor, but this fact detracts nothing from its notable speed accomplishments.



Louis Strang's victory in Class D, in the stock-car race, was well earned, and his new mark of 1:34:00 1-5 for 100 miles justifies the judgment of the Buick people in engaging him for the coming season. Robert Burman, his teammate, had hard luck in the stock-car race, the flywheel of his engine coming off and making a bee line for the ocean. He escaped without personal injury, but the car was placed *hors de combat*.

Excellent Work of the Two-Wheelers.

The riders of the two-wheeled motor-driven machines have every reason to look with pride upon their achievements. Premier honors went to Walter Goerke, of Brooklyn, who, on Wednesday in the five-mile straightaway trials, reduced the record to 3:30 1-5 for that distance. This was followed on Thursday by another successful onslaught on the record table by Goerke, his first performance being a lowering of the kilometer mark to :27 4-5, and his second the winning of the one-hour record race for motorcycles, in which he clipped a large slice off the Brooklands track record of 68 miles, 1,380 yards, by traveling an even 69 miles in 58:25 4-5. The course was measured with a view of timing the competitors at 69 miles, and there was no means of knowing what distance Goerke had covered at the end of the hour, though there is little doubt but that it was over 70 miles. A. G. Chapple, of New York, suc-



The Crowd that Lined the Beach and the Grand Stand, as Seen from the Stairway of the Club House Landing.

ceeded in lowering the ten-mile competition mark on Friday by placing new figures at 17:25 1-5. He also won the five-mile open on Wednesday. New record for the mile straightaway was set by Robert Stubbs, an amateur from Birmingham, Ala., on Thursday, the time being :43 2-5. All of these records were made on Indian 7-horsepower machines.

Much interest was shown in the bicycle events which were sandwiched into the programme, as most of the officials and drivers have been at one time or another identified with the time-honored cycle, either in the industrial or competitive field. On the last day of the meet DePalma fitted up his Fiat *Cyclone* with an improvised windshield, and a series of trials were made at the mile straightaway, the bicyclists using the auto as a pacemaker. Elmer L. Collins, of Lynn, Mass., riding close to the pace, covered a mile in :58 3-5, just four-fifths of a second away from the record of Charley Murphy, of 0:57 4-5, made behind a railroad train on Long Island some years ago. The competition between the cyclists was good, and several records were established, the most notable of which was by Joseph A. Fogler, of Brooklyn, who won the flying start half-mile from a field of ten in :47 1-5.

The Aeroplane That Did Not Fly.

Aeroplanist Bates, who brought his flying machine all the way from Chicago to try a flight over the beach, secured but one chance to try out his "white wings" during the tournament. This

and the third prize was carried off by Miss Bessie Bingham, in her Cadillac, which was decorated in red, green and white. The parade was the best thing in that line that Daytona has ever witnessed, and Chairman White, who headed the committee in charge, handled the affair admirably.

Happenings of the Two Closing Days.

Thursday's programme of automobile events promised to go by the board, after the disaster to the Benz piston. Work was continued all Wednesday night to make repairs, but there were not sufficient mechanical facilities to get the car into working order, and as Kilpatrick's Hotchkiss was still out of commission, the Fiat *Cyclone* had a walkover in the one-mile invitation. De Palma drove over the course in :37 2-5. As the Buick team left town early in the morning to attend the hill climb at Atlanta Saturday, the management became busy and organized two four-mile handicap events with impromptu entries. These races proved to be the most interesting of the meet in a competitive sense. Start was made at the tape, and the course was two miles south and return. Inglis M. Uppercu, the well-known New York Cadillac representative, won the first handicap with a 30-horsepower Cadillac, his allowance being 1 minute 5 seconds; time, 5:03 2-5; M. Hotchkiss, 30-horsepower Pope-Hartford, 50 seconds handicap, was second, and Mr. Seamans, 30-horsepower Stoddard-Dayton, 30 seconds handicap, was third. The second



As the Parade Started from the City Hall.

was at the close of the races on Friday, when the wind had died down to practically nothing. When the aeroplane emerged from its shed a great crowd gathered to watch the trial. The machine started smoothly and ran upon its carrying wheels down the beach for some distance, but failed to rise. The motor worked intermittently, and the gathering darkness made adjustment impossible. The aeroplane was run back to its house for the night Mr. Bates expects to make further attempts at flight before he leaves Daytona. The heavy winds the first part of the week made an earlier attempt impossible.

Automobile Parade Was a Wealth of Color.

The automobile parade of Wednesday morning was a decided success. There were over fifty cars in line, and the procession left the City Hall at 10 o'clock in the morning, moving through the principal streets and continuing across the bridges to Daytona Beach and Sea Breeze, came to a termination in front of the clubhouse of the Florida East Coast Automobile Association and official stand. The first prize, a handsome trophy offered by the *Daytona Daily News*, was awarded to M. B. Aultman's Buick, which was decorated with heliotrope. Second honors went to Miss Jessie Brown, whose car was trimmed in luxuriant green,



Passing Over Halifax River Bridge to Beach.

handicap resulted in a win for the Pope-Hartford, after its handicap had been reduced to 30 seconds, in 5:05 3-5; DePalma, driving Fiat *Cyclone*, from scratch, was second, in 3:16; and Seamans, Stoddard-Dayton, 30 seconds, was third.

The balance of the programme was made up of motorcycle and bicycle events, some of which resulted in records, and which are referred to above.

The programme for Friday consisted of the excess of numbers on the programme that had been crowded from the previous days of racing. The event of importance was the 100-mile race for the Minneapolis Trophy, which had to be won twice to insure its permanent possession. Last year the late Cedrino piloted the Fiat *Cyclone* to victory in this event, and this year Ralph DePalma was at the wheel in the same car to secure a second and final hold on the trophy. As it was, he had a walkover, as no other competitors lined up at the tape. He did not go after the 100-mile record, but drove a limited distance over the course, under the instructions of Referee Miles, who awarded him the race. DePalma also had a walkover in the one-mile invitation.

An eight-mile handicap, four miles out and return, brought out a field of eight starters, with DePalma at scratch, conceding



Referee Miles Surrounded by His Official Assistants.

starts ranging from 1 minute and 20 seconds to 4 minutes. He won handily in 8:45, and was followed over the tape by the Hotchkiss Pope-Hartford, which won considerable glory as a persistent starter and finisher. Mr. Aultman's Buick was third.

A neck-and-neck finish was furnished by A. G. Chapple and Walter Goerke in the 20-mile motorcycle race, in which the amateur competition record was broken by the former. It was either man's race up to the finishing line, but Chapple managed to get the best of the Brooklyn favorite.

Next Year Last Week in January.

Formal announcement was made on Thursday that the eighth annual tournament will be held next January, probably during the last week of the month. It is proposed to raise a large sum of money for cash prizes, so as to attract a representative number of world-famous drivers. Major A. D. Foster, president of the East Coast Automobile Association; Secretary T. E. Fitzgerald, and Treasurer Edward White are indefatigable in their efforts to perpetuate the annual contests on the beach, and will undoubtedly be substantially backed by the citizens of Daytona.

At the conclusion of the racing on Friday evening Manager W. J. Morgan entertained the officials of the meet, representatives of the press, and a number of leading citizens at a banquet at the Café Mills, on Beach street. Other guests present included the leading lights of the Brooklyn National League baseball team, which organization came down from Jacksonville that morning to give an exhibition game of ball at Harrison's Park. Referee Samuel A. Miles officiated as toastmaster, and there was speech-making galore. It was a graceful and fitting finish for the week of festivities.

Earlier in the week, on Monday evening, a dinner was tendered at the Café Mills to Robert Burman by the Buick people, at which a handsome solitaire diamond ring, given by the company,

and a gold watch, subscribed for by the other members of the Buick racing team, were presented to him. A typical Southern menu was served.

The *Daytona Daily News*, which is an evening paper, showed sterling enterprise during the week of the meet by issuing a special morning edition devoted almost exclusively to the tournament and the accompanying festivities. Secretary Fitzgerald, of the East Coast Automobile Association, who is also the editor of the *News*, certainly showed an energy characteristic of metropolitan dailies in the general make-up and reliability of his journal.

WILDWOOD WILL HAVE RACES IN JULY.

WILDWOOD-BY-THE-SEA, N. J., March 29.—The Contest Committee of the Motor Club of Wildwood has selected Saturday and Monday, July 3 and 5, as the dates for its first race meet of the present season. The races will, as usual, be run off over the Central avenue boulevard, which provides one of the finest mile straightaway courses in the country, and will include, besides the usual class events, trials for record, open to all.

MAXWELL NOW AHEAD OF WORLD RECORD.

BOSTON, March 31.—In its endeavor to cover 10,000 miles without stopping its motor, the Maxwell touring car which started this contest on March 18, has now accomplished half of that distance without trouble, and has beaten all previous records for non-stop runs. To-day, at noon, its mileage was 5,289, and the car is continuing on its second half as easily as on its first. No stops of any kind have been made except to change crews, repair one puncture, and to replenish fuel. The first week was spent in running between this city and Worcester, making 3,000 miles over that route; then the course was changed to Providence and return, over which it is still running.

ST. LOUIS AERO CLUB MAKES ACTIVE PLANS.

ST. LOUIS, March 29.—For the promotion of aeronautics as a science and sport, the board of governors of the Aero Club of St. Louis has resolved to spend between \$15,000 and \$20,000 this year, instructing a committee to secure at once permanent ascension grounds, with facilities for obtaining coal and hydrogen gas inflation, and to buy a new 78,000 cubic feet capacity racing balloon. This balloon will be entered in the first championship balloon race of the Aero Club of America, from Indianapolis on June 5, with A. B. Lambert as pilot and H. E. Honeywell as aide.

To assist inventors of aeroplanes and dirigibles, the club has decided to purchase an aerial motor, which will be loaned to any inventor, whether a member of the club or not, for use in this vicinity. It will be a water-cooled engine of 30 horsepower, but has not as yet been selected. It is understood that a course in aeronautics will soon be started at the central branch of the Y. M. C. A., and the club will endeavor to aid this in all possible ways. The club plans to hold a carnival during the week of October 4.



Tri-o of Motorcyclists that Annihilated Records on the Daytona Beach Course—Chapple, Goerke, and Stubbs.

SAFETY AND UTILITY OF PART IV
 THOS. J. FAY □ AUTOMOBILE STEERING SYSTEMS

SHOCK to the steering crank, on the knuckle of the front road wheel will be more or less, depending upon the design, an intimation of which was given in the closing paragraph of the last published part of this article, and Fig. 31 is here given to more clearly indicate the manner in which such shocks can be minimized. The section, Fig. 31, is of a design in which it is shown that the center line of the wheel, OA, and the center line of the knuckle O'A' do not bisect at the point of contact of the tire with the road, and the result is that a crank moment will generate, the magnitude of which will be proportional to the difference as shown at O and O'.

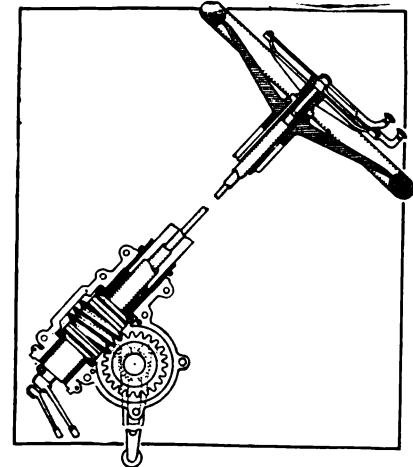

Fig. 33.—Section of steering column, showing concentric parts for advancing spark, and throttle.

as they relate to the height of road obstructions to be negotiated in the regular course of events. In the absence of road inequalities of a magnitude sufficient to influence the situation, it is a matter of no moment as to whether the conditions, as they are depicted in Fig. 31, obtain or not.

It is when the steering road wheels intercept an obstruction of a relative great height that the difference noted in Fig. 31 becomes a menace. On the other hand, it is not convenient to reduce the distance OO' to zero, and it is therefore desirable to use road wheels of a good diameter, and reduce the distance OO' to the minimum besides.

Worm and Sector Types of Steering Gear.—In this type of steering gear it is usually the practice to use multiple thread worms, a good example of which is shown in Fig. 32. The quadruple thread depicted affords good proportions of the teeth, the angle is as close to the irreversible as it is desirable to go, the surface of actual contact is quite enough for good work from the point of view of long life, and this particular gear has seen some nine years' service to its credit in cars that have made and maintained a reputation for minimum upkeep, and good road performance.

In some cases the sector is left out and instead the whole worm-wheel is used, in the manner as shown in Fig. 33, which figure also depicts the section of the steering column, and the way in which the details are worked out. This is illustrative of general practice, in which concentric tubes are used thus:

(a) The outer tube is of thin brass, does not rotate, and serves as a spacer, as well as holding the bearings in rigid relation. Brass is used, and kept polished, to enhance the general appearance of the car.

(b) The second tube is in rigid relation to the worm and the steering wheel, so that, if the wheel is rotated so will the worm rotate, which in turn causes the sector to respond, hence the steering crank, which is also in rigid relation.

(c) The third tube serves for the spark, and is rotated besides connecting with a lever on the top of the steering column, above the steering wheel, for the convenience of the driver.

(d) The inner member in the concentric nest can be a rod, although it may also be a light tube of small diameter, and if the member (c) is connected with the spark, it is then that the inner rod will be for the purpose of controlling the throttle. It is usually a matter of convenience that influences the selection, as between spark and throttle.

It will be understood that a wide variety of worm and sector details will be found in cars as they can be seen in actual practice, and it is probable that the wide selection to be noted in no way interferes with the good results to be expected. In steering equipment the results, like in ball bearings, will depend largely upon materials used and fine workmanship to a vast extent. Likewise, in the operation of a car, if the equipment is not looked after, the details of design will have small bearing on the degrees of satisfaction, since lost motion will soon render itself manifest, and the car will become a source of annoyance to the driver, if not a menace to all who have to do with it.

Some Methods Used in the Design of Worms and Sectors.

—Presupposing a worm and sector for the purpose, it follows that certain of the considerations must be settled upon before it will be possible to intelligently use any formulæ in arriving at the respective dimensions of either the worm or the sector. The arc of the sector will depend upon the canting angle of the front road wheels, and this cant depends upon the afforded room, taking into account the diameter of the road wheels, and the section of the tires to be used, as well as the distance from the wheel to the side of the chassis frame.

It will also be necessary to consider the relation of the steering wheel to the canting angle, in order to determine the number of revolutions of the steering wheel for a given (combined) canting angle. If the steering wheel is to make 1 1-2 revolutions while the road wheels cant the full sweep from right to left, this information must be in hand before it will be possible to apply any formula in the process of designing the worm and sector. Even in repair work it is desirable to review this situation, as well as the other considerations essential to the process.

In some cars it is the practice to so design the system that for one turn of the steering wheel the road wheels will cant the full (combined) angle. The main trouble about this plan lies in the

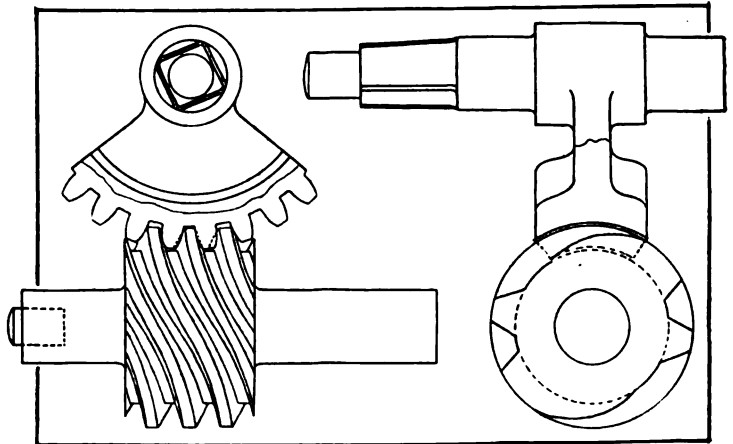

Fig. 32.—Example of worm and sector steering gearset, long used in good cars.

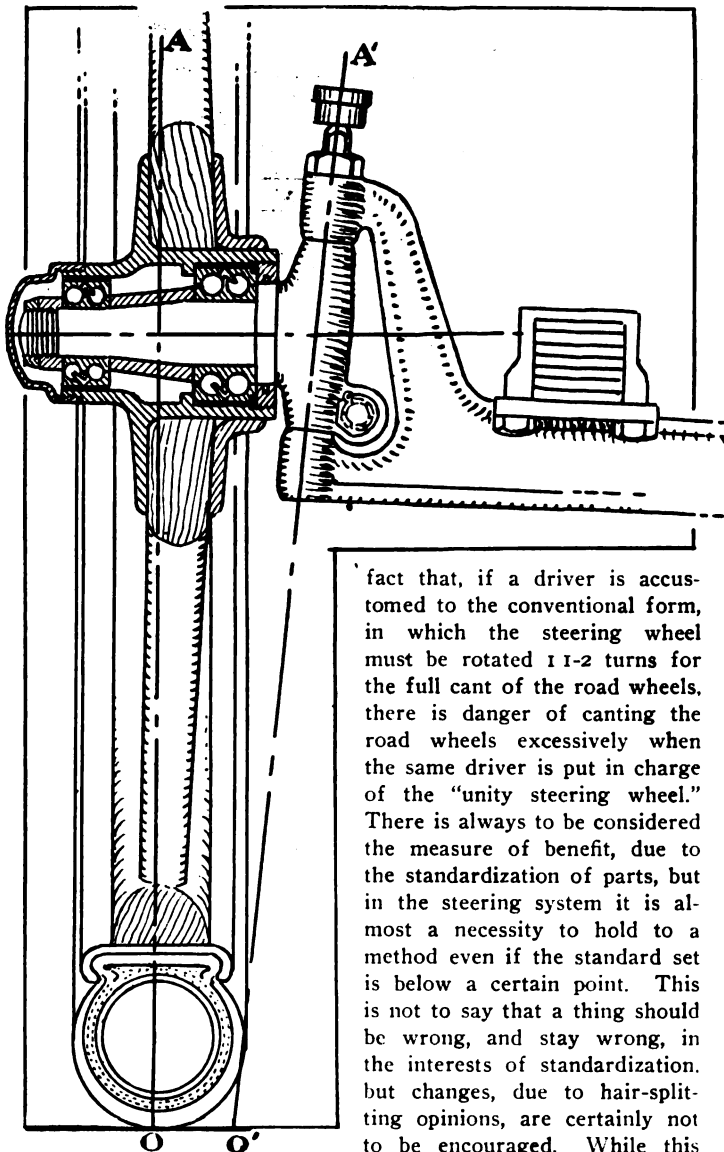

Fig. 31.—Section of front wheel, showing defect in design which affects steering.

fact that, if a driver is accustomed to the conventional form, in which the steering wheel must be rotated 11-2 turns for the full cant of the road wheels, there is danger of canting the road wheels excessively when the same driver is put in charge of the "unity steering wheel." There is always to be considered the measure of benefit, due to the standardization of parts, but in the steering system it is almost a necessity to hold to a method even if the standard set is below a certain point. This is not to say that a thing should be wrong, and stay wrong, in the interests of standardization. but changes, due to hair-splitting opinions, are certainly not to be encouraged. While this phase of the subject is on the tapis, it will be as well to discuss the steering wheel proper. as it relates to the wood rim used. If the rim is not securely fastened to the spider, there is a chance of it falling off at a critical moment, just when an incident, such as this, would tend to disconcert the driver, with such consequences as are prone to be the product of absent-mindedness under stress of strenuous circumstances. But if the rim is to be securely fastened, it is no less a fact that it should be of a suitable section to enable the driver to grip the same firmly, and it has been found that a round section is more likely to set up cramps in the muscles than will be due to an oval shape. As for the wood, it does seem as if mahogany is as good as it looks, and the looks may well be regarded as up to the standard of excellence not readily improved upon, if the mahogany is properly secured to a spider of good design, and suitable material.

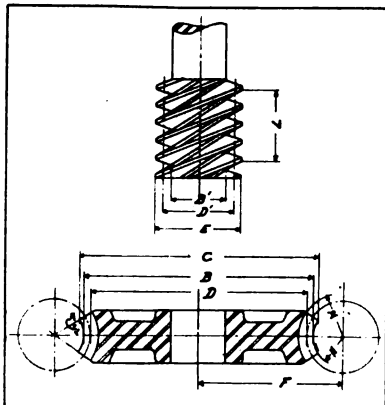

Fig. 34.—Diagrammatic figure of worm and sector used in designing formula.

After considering the details of the service, and having decided on the relation of the steering wheel to the road wheels, it is possible to use the formulæ of the worm and worm gear, one version of which is as follows:

- 8..... $D = \frac{yP}{\pi} = 0.3183 y P$;
- 9..... $B = D + 0.6366 P$;
- 10..... $C = B + 2 \frac{(N - N \cos A)}{D + D'}$;
- 11..... $F = \frac{2}{D'}$;
- 12..... $D' = 2 \frac{F - D}{D'}$;
- 13..... $M = \frac{2}{D'} + 0.368 P$;
- 14..... $N = \frac{2}{2} + 0.3183 P$;
- 15..... $E = D' + 0.6366 P$;
- 16..... $B' = D' - 0.736 \frac{L}{P}$;
- 17..... $\text{Tang. } S = \frac{L}{\pi D}$;
- 18..... $L = P Z$;
- 19..... $P = \frac{L}{Z}$;
- 20..... $Z = \frac{L}{P}$;
- 21..... $y = \text{number of teeth in the worm wheel}$;
- 22..... $P = \text{circular pitch}$;
- 23..... $S = \text{lead angle in degrees}$;

24.....tooth angle = 20 degrees.
The formula of the worm and sector will best be understood if reference is had to the diagrammatic illustration, Fig. 34, in which will be found the reference letters corresponding to the letters used in the formula. In relation to the material to use, it will be understood that there are several choices, as for illustration, the worm can be of cementing steel and case-hardened. The sector can be of phosphor-bronze. Alloy steel may be used for the worm, and the choice of cementing or quenching from some high temperature will fall to the lot of the chooser.

The cementing process has its advantages, and assures a hard surface, which is well worth taking into account. If alloy steel is used and the same is to be cemented, it is then that the carbon content should be low—very low indeed—and this is the kind of steel that is hard to get. Whether or not the material of the worm is to be of alloy or carbon steel, if it is to be subjected to the cementing process, the carbon should not be higher than 20 point, as an outside figure. For the rest it is largely a matter of personal choice, among the respective generic types of steel.

Some Products that Can Be Used.—Considering the cementing process, and allowing that the core of the cemented section should be tough and soft, the steels as follows might be selected:

Carbon Steel for Worms.—The chemical composition should be within the following and the steel should be of the acid process:

Carbon	Silicon	Sulphur	Phosphorus	Manganese
.15-.20	.10-.20	.03-.04	.03-.04	.30-.40

The physical properties should be those due to proper fabrication of the steel, but it is hardly worth while to go over this phase of the question for the reason that the steel will be so altered in the cementing process that it is a well-fabricated

product, the end will be that due to cementing, which is bound to represent a decided improvement.

Cementing Nickel Steel.—In this grade of steel there is so much chance of going wrong that it is a question if it is worth while taking the chances, unless access can be had to some well-known grade of steel in which the imperfections that do abound in nickel steel will be more nearly absent.

At all events the steel should be an acid product with the carbon positively within the limits here given:

Nickel.	Carbon.	Silicon.	Sulphur.	Phosphorus.	Manganese.
4-5	.10-.15	.15-.20	.03-.04	.03-.04	.30-.40

Physical Properties.—The elongation should not be less than that as here given, with the steel in the normal state:

Elastic limit in pounds per square inch (minimum)	60,000
Tensile strength in pounds per square inch (maximum)	90,000
Elongation, per cent. in 2 inches (minimum)	30
Reduction of area in per cent (minimum)	69

In this work the test proof should be 0.5 inches in diameter, and it would be of advantage to experiment with some of the steel, before and after cementing, with a view to ascertaining the extent to which it will become brittle in the heat-treatment. Some grades of nickel steel behave better than others in this service, and in not a few cases it was found that the steel could not be safely used at all. It is in repair work especially that care should be exercised, since in the maker's plant much experience generally eliminates the troubles likely to arise.

Chrome Nickel Steel.—In this product there is ample opportunity to get into trouble due to high carbon, and such other irregularities as can readily fall to dual alloy steel. The remedy lies in not using the steel at all, unless the carbon is low, and provided the physical properties are quite up to the standard here set.

Chemical Composition.—With the understanding that the carbon will be lower, if anything:

	Phos.	Man-
Chromium.	Nickel.	Carbon.
Silicon.	Sulphur.	phorus.
ganese.		
1.4-1.6	4.40-4.60	.10-.15
	.15-.20	.013-.015
	.01-.013	.30-.40

Physical Properties.—Under no circumstances should the elongation be other than the value as here given, for the steel in the normal state:

Elastic limit in pounds per square inch (minimum)	90,000
Tensile strength in pounds per square inch (maximum)	110,000
Elongation, per cent in 2 inches (minimum)	22
Reduction of area, per cent. (minimum)	65

In the cementing process the penetration will not be exactly the same for the several grades of steel, but the chart (Fig. 26, Part II), will afford such information, in relation to the time, that nothing more will need be put down here, especially as this

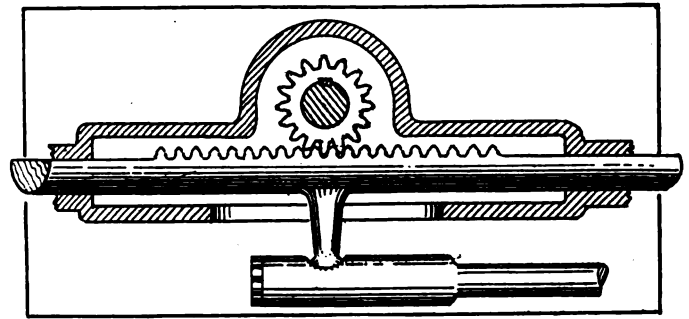

Fig. 35.—Characteristic sketch of rack and pinion.

phase of the subject can be taken up by the interested reader, as a separate matter to be investigated.

After cementation it is necessary to quench, and in the process there is every chance to go wrong. With some grades of steel the "single quench" will do, and the case will be hard, while the core will be soft and tough. In some examples the core will be rendered crystalline in the process that makes the shell hard, and the result will not be good. To eliminate this trouble it is necessary to put the parts through a double quenching process in the manner as follows:

- (a) Quench at 900 degrees centigrade, in oil at the temperature of the surrounding.
- (b) Reheat to 750 degrees centigrade, and then quench in salt water at the temperature of the surrounding.

In this way the core will be rendered tough and soft, while the shell will be quite up to the hardness likely to result from the use of the given grade of steel. As regards the efficiency of quenching baths, the media are given below in the order of merit:

In the cementing process it is not only a question of time that fixes the penetration, but the cementing material as well. It is not desirable to have the cementing material too intense in its action, and if the ground bone, or whatever may be the form of the carbon, is in 60 per cent. presence, the time will be fixed accordingly. At all events, it is the height of good practice to use some one grade of cementing material, and when a product is found for the purpose to get used to it, and stick to its use is in the path of wisdom. It is in making changes that mistakes are frequently made also.

Merit of the Respective Quenching Liquids Used.—The first-named medium (mercury), cannot be used with safety, excepting for very small parts, on account of the poisonous vapors

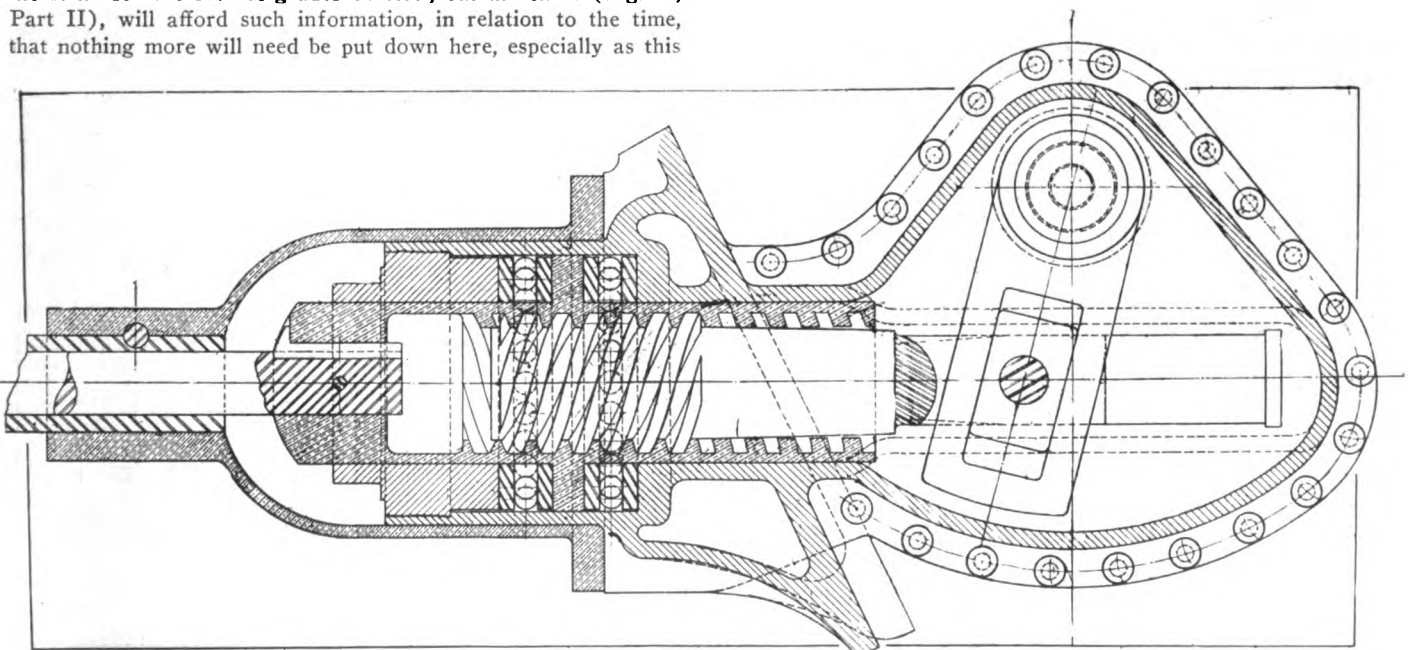

Fig. 36.—Screw and nut design showing one way of transforming the motion as used in exacting truck service.

emitted, and for that matter all heat-treatment work is attended by more or less risk.

- (a) Mercury.
- (b) Acidulated water, ice cold.
- (c) Salt water, ice cold.
- (d) Salt water, at surrounding temperature.
- (e) Water, at surrounding temperature.
- (f) Water, with skim-milk.
- (g) Limewater.
- (h) Fish-oil, or cotton-seed oil.
- (i) Cod-liver oil.
- (j) If some means is at hand for maintaining a constant temperature of the quenching bath, and if the parts are placed in a "jet" of the liquid, to wipe off the globules of steam, the efficiency will be much enhanced.

Since lost motion is the bane of the steering gear situation it is not believed that too much time has been taken in the act of indicating the manner in which the worm can be rendered as serviceable as possible, and the process of repair is certainly one that is well worth more than a little of the most careful attention. When the worm is so worn that flat spots are noticeable on the faces of the threads, it is generally better to cast the worm out and make a new one for the purpose.

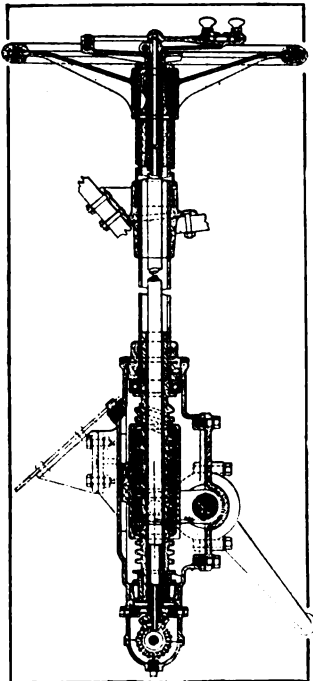

Fig. 39.—Application of the Acme principle to a steering gear set.

Acme standard thread, which is much used in this class of work.

Rack and Pinion Form of Steering Gear.—This form of steering gear is used to some extent in commercial car work and in many respects it is to be commended. True, lost motion must be present to the extent that back-lash is a necessary property in the relations of the rack to the pinion. It is also true that the "lever advantage" will be less than that due to the use of the worm and sector, and irreversibility is entirely absent in this type. Fig. 35 depicts a conventional form of rack and pinion gear, which, with a pinion of the smallest possible number of teeth considering good practice, and a steering wheel of the greatest possible diameter, it becomes feasible to use the idea to fair advantage.

Screw and Nut Much Used in Practice.—While the worm and sector plan does away with any need of sliding bearings, such as are frequently used in connection with the screw and nut type of steering gear, the latter plan is much in vogue, and it has the advantage of a large bearing surface for the threads of the reducing members, and the sliding bearings, when they are used, are made with adequate surface for the purpose, Fig. 39 is a good illustration of one phase of the scheme, and while details of the respective plans are not always along parallel lines, even so, to the owner, and the repairmen, the deviation should not prove of undoing purport, and because the surfaces are a maximum, coupled with good facilities for lubricating, the evil

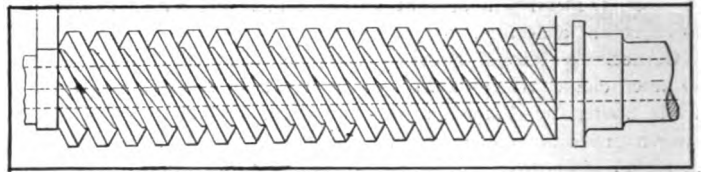

Fig. 38.—Illustrating a multiple thread screw of the Acme standard.

day should be much deferred and repairs should not be past the ingenuity of a man of fair skill, while the tools in the average shop should be adequate for the purpose.

Acme Standard Screw Thread.—In the class of work of the subject it is quite generally the practice to use the Acme 29 degree (included angle) thread, the data of which is as follows:

- Width of point of tool for screw or tap thread,
- $$W = \frac{0.3707}{\text{number of threads per inch}} - 0.0052$$
- Width of screw or nut thread,
- $$W = \frac{0.3707}{\text{number of threads per inch}}$$
- Diameter of tap,
- $$d = \text{diameter of screw} + 0.020$$
- Diameter of tap or screw at root,
- $$D = \text{diameter of screw} - \frac{1}{\text{number of linear threads per inch}} + 0.020$$
- Depth of thread,
- $$B = \frac{1}{2 \times \text{number of threads per inch}} + 0.010$$

In this class of work, in the shop, it is of especial advantage to have at hand a "worm-thread tool gauge" conforming to the Acme standard, which gauge will serve to furnish the correct form in turning the thread or the worm. That this form of thread is quite up to a fitting standard is assured by the large number of steering gears in which it has found a resting place.

Fig. 38 shows a worm cut in accordance with the Acme idea, and Fig. 39 is a good example of the use of a screw and nut steering gear.

Before concluding, it will be the aim to advocate the presence of good materials in the component parts of steering gear, and such fine workmanship that the chances of trouble will be as a remote contingency, and even then under stress of the greatest provocation. Fig. 37 shows a steering system in which the cranks, linkages and the drag, as well as the tierod, are nested high up and back, out of harm's way.

In closing, mention will be made of one more type of steering gear, in which the planetary system is used in the head of the steering column. This form of gear is sufficiently irreversible for all practical purposes, and it nests so closely that it can be placed in the head of the steering column without rendering the appearance of the system nearly as bulky as one might suppose. In the planetary gear system there is little chance for lost motion if the work is fairly well done, and it is an advantage, the fact that the work has to be well done, in order to be able to assemble the gears. This system also affords a large amount of surface, so that the life of the gear is long.

In practice the system has made a good record and road-shock is effectively shielded.

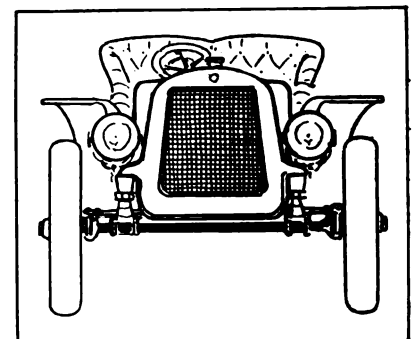

Fig. 37.—Front of a car, showing steering equipment out of harm's way.

AUTOMOBILE COOLING SYSTEMS ANALYZED

BY MORRIS A. HALL PART III

THE matter of the relative volume of air and water for equal cooling ability may be expressed in another way: that is, the ratio of the specific heats of the two being .2375, the ratio of the volumes is the reciprocal of this, or 4.2. The meaning is that to remove the heat from the water in the radiator by means of air it will be necessary to use 4.2 times as much, or if the efficiency of the radiator is taken into account, five times as much.

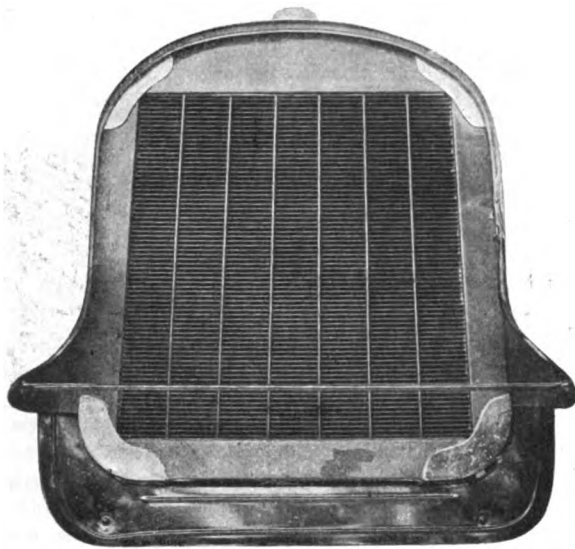

Fig. 8.—Appears like a square tube honeycomb.

Ratio of Air to Water a Big One.—This really is a very large ratio and one that would be difficult to obtain if the air and water passed through the cooler at the same rate of speed. However, that is not a condition that obtains in practice; in fact, the air is passed through at such a high rate of speed compared to the speed of the water that the volumes are very nearly equal. Thus the inherent inability of the air to remove heat quickly and efficiently is more than overcome by using an enormous amount of it passed through at a very high linear speed.

This brings up the question of efficiency per unit of frontal area. The space which can be given up to the radiator is always limited as will be explained later. This, in turn, limits the frontal area. Now, if the area is limited, the efficiency of this area must be increased to compensate for the lack. The latter, is effected in several ways, thus the depth may be increased, within certain well-defined limits. Or, the surface may be lengthened by corrugations, that is the internal surface, so that the water in passing through, must travel a longer passage. If an equal amount of air is presented all along the tortuous passage, the cooling effect must of a necessity, be greater. This works both ways, for if the other side of the tubes are also corrugated there is a greater surface exposed and the whole is more efficient.

The Two Classes of Radiators.—Broadly speaking, there are but two classes of radiators, also called coolers. These are the tubular type, in which the water passes through coils of tubing having a number of metal fins or gills fastened on the outer circumference. The second form is that known as the

cellular honeycomb type. This consists of a flat tank pierced by a multitude of small tubes. In practice, these vary greatly not only among the different makers, but also between the different sizes and for dissimilar uses. The difference between the two types is but a difference in form, the one hot substance passing through the tube and the other, or cooling medium, circulating around the outside. There is, however, this minor difference, that in the two classes of radiators the heated fluid occupies, in one, the inside of the tube, while the cooling substance is outside, and in the other the one to be cooled is outside and the one used to cool passes through the tube.

These two general types have many and varied forms in practice; in fact, until the last year, the leaning was away from anything that savored of the commonplace or ordinary. This tendency resulted in a crop of different coolers, every maker had his own shape, and each one was made primarily distinctive, and secondarily for cooling purposes. Now, however, all that is changed, and with very few exceptions the front view of one car is not unlike that of many others. This has made recognizing a car impossible from a front view.

In Fig. 8 is shown a sample that many will recognize at once. This is of a popular medium-priced car, and the radiator is a clever attempt to produce the looks of the square tube cellular type at tubular price. As the comparative efficiency of the two has never been satisfactorily and definitely proven, this is no crime, but rather a good example of good looks and equal ability for little money.

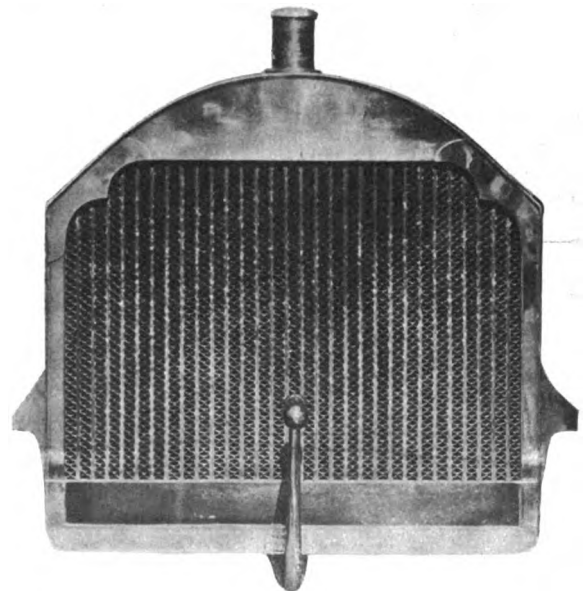

Fig. 9.—Typical modern tubular cooler.

Figure 9 is another of the same kind, although the striving after the square tube is not so marked as before. The incurving corner ornament is more on the modern order of radiator distinction, and is typical of several of the best cars. In Fig. 10 is seen a real cellular with square tubes, and these set parallel to the ground. This, too, has what was called the Mercedes

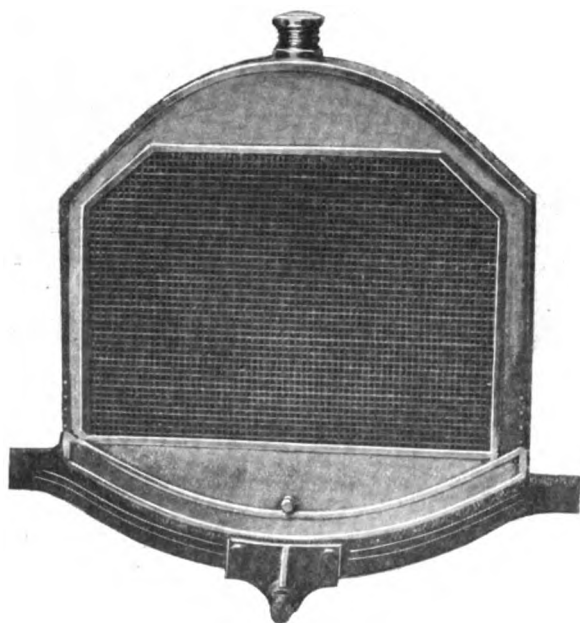

Fig. 10.—Square tube cellular of pleasing lines.

shape, from the firm which brought it out. This shape has now become general, and is no longer called by that name. The conditions which brought about the development of the shape are simple and easily understood.

How the Mercedes Type of Radiator Was Evolved.—When the tee head motor was developed, the ignition wires and water pipes over the top of the engine marked the high point of the outfit. The frame had a definite fixed width, the top of the symmetrical parts of the cylinders came at a certain distance above the frame, which parts had to be cleared by the hood. The high point being fixed, anything that went higher by more than reasonable clearance added unnecessary and useless weight. What was more natural than two straight lines sloping down to clear the cylinders and meet the vertical side lines? Upon close investigation, this is seen to describe the so-called Mercedes type exactly, with the addition of a long radius curve at the top to take off the curse of the straight lines.

This kind of a radiator has long been called honeycomb, and many people have wondered why. In Fig. 11 is shown one of the earlier radiator sections. This, it will be seen, is formed of a series of six-sided or hex tubes, fastened into a header in such a way as to allow of space between the tubes for the passage of water. It is a true honeycomb, and, although the hex

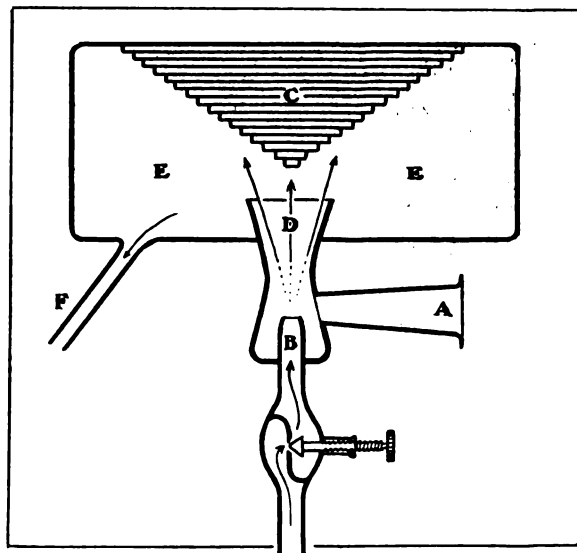

Fig. 12.—"Rex" substitute for a radiator.

tubes proved expensive and did not last, the name stuck and is used to-day to indicate all radiators in which a series of tubes are fixed into a header with water spaces between them.

Innovations Differ from the Standard Shape.—In stating that radiators are fast approaching a standard shape, the exception must, of course, be made that coolers intended to work along new lines or on a new principle usually take on a new and different shape. Thus, in Fig. 12, is seen a device brought out in France less than a year ago which would hardly be recognized as a radiator. That is what it was intended for, however, and a brief explanation of the principle upon which it works will be of interest.

The device consists of an entering tube of the shape of the Venturi meter, whose action is well known. Into this tube, at the proper point, the hot water is forced at a very high pressure, much higher than is ordinarily used, and amounting to perhaps 50 pounds per square inch. This powerful jet of water issuing into the venturi tube *D*, expands suddenly from its high pressure down to atmospheric, while at the same time the rush of water draws in a large volume of cold air at the opening *A*. The sudden expansion of the water, according to a law of physics, gives up the most of its heat to the surroundings and is itself cooled. This cooling action is materially aided by the inrush of cool air through the nozzle *A*. The cooled water impinges upon the step cone and drops to the tank below. In this dropping process, it is further cooled by the ascending currents of cold air. *F* is the drain pipe through which the fluid returns to the cylinders and goes to work once again.

Radiator Small Enough to Go on Dashboard.—

The makers of this contrivance placed it on the dashboard rather than in front and made it very small. In size, three of these—the number necessary to cool a 30-horsepower engine—take up approximately the same space as a three-feed lubricator, viz., 6 inches long, 5 inches high, and 2 inches deep. A single addition to the usual outfit is necessary in the shape of a small tank holding a gallon, to care for the losses by evaporation at the nozzle.

Another novelty, apparently of equal merit, was brought out at the same time. It is shown in place on the dashboard of a large truck in Fig. 13. The line of reasoning which would apply here is that if the device was proven successful on a motor truck, where the radiator requirements are very severe, it could not help but be eminently satisfactory on a touring car. On a truck, the engine must run fast while the vehicle runs slow. The former means a great deal of heat to be dissipated. The latter, on the other hand, means very little air for cooling purposes. The combination expresses the necessity for excessive size, unusual efficiency or a combination of the two. In the two last cases, the device would be applicable for pleasure car use, but never with the former.

The principle and construction are both very simple. As Fig. 14 shows, there are two headers, one at the top where the water enters, and one at the bottom for the outflow. Connecting the two are a series of small diameter copper tubes arranged in semicircular form. This gives the outfit its cylindrical shape, and leaves the central portion for the fan. By making the external diameter large and restricting the number of tubes, the interior space is left large. This allows of the use of a very big diameter fan, which is not the case with the ordinary arrangement. By having such a large fan, and by rotating it at a high speed in the heart of the radiator, so to speak, a high efficiency is obtained. For touring practice, the diam-

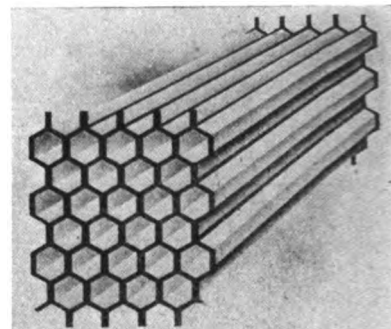

Fig. 11.—Section of a genuine honey-comb radiator.

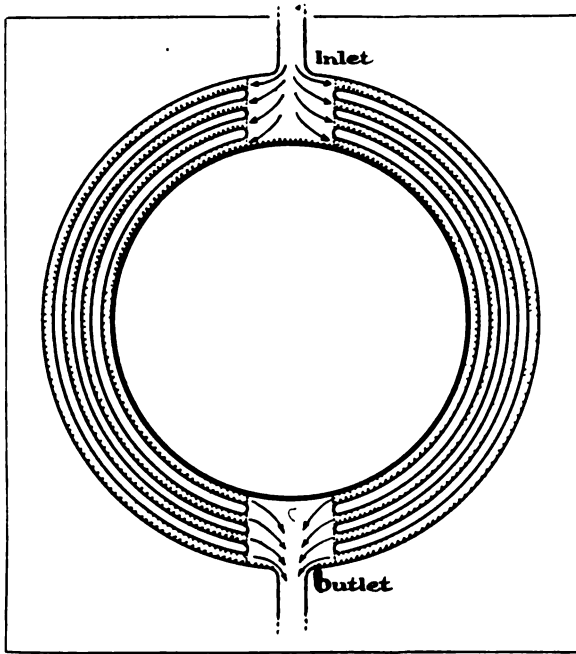

Fig. 14.—Illustrating a new principle.

eter would be smaller than the one shown, but the depth could be greater because of saving the space taken up by the fan.

Convection or Radiation, Which Is Most Important?—In discussing the efficiency of radiators or any other cooling medium, the qualities of radiation and conduction enter. To define these, radiation of heat is that action which takes place between bodies at measurable distances apart and follows the laws for the radiation of light. Conduction is the transfer of heat between bodies or parts of bodies which touch each other. Internal conduction takes place between the parts of one continuous body and external conduction through the surface of contact of a pair of bodies. Convection means the transfer and diffusion of the heat in a fluid mass by means of the motion of the particles. The latter is properly called internal conduction.

Relative ability of any body or substance to radiate and to conduct heat varies. Heat rays proceed in straight lines, and the intensity of those radiated from any one source varies inversely as the square of their distance from the source. The rate at which a hotter body radiates heat depends upon the state of the surfaces of the bodies as well as on their temperatures. The rate of radiation and of absorption are increased by darkness and roughness of the surfaces and the contrary also holds true, diminished by smoothness and polish. The quantity of heat radiated is also a measure of its heat-absorbing power.

The rate of heat radiation of various substances has been measured, and according to one well-known authority is:

Lampblack and water.....	1,000
Ordinary glass.....	900
Silver leaf and glass.....	270
Cast iron, brightly polished.....	260
Wrought iron, brightly polished.....	230
Steel, polished.....	170
Tin.....	150
Varnished copper.....	140
Cast brass, polished.....	110
Brass, brightly polished.....	70
Hammered copper.....	70
Plated gold.....	50
Gold on polished steel.....	30
Silver polished bright.....	30

Tests Show Increased Efficiency for Dry Surfaces.—On the subject of the conditions of the surfaces, a series of tests to show the effect of differences were made, using cast-iron in the form of a cube. These are of interest, and are given below:

Surface.	Oiled.	Dry.
Rough.....	100	100
Planed.....	60	32
Drawfiled.....	49	20
Polished.....	45	18

From which it appears that the oiling of smoothly polished castings more than doubles the loss of heat by radiation, while it

does not affect rough castings, and finished ones only moderately.

The table of relative heat-conducting power of the metals tells a far different story, for here the metal which was low before is high. For the lesson it teaches, these values are given below:

Silver.....	1,000
Gold.....	981
Cast copper.....	811
Cast copper with .25% arsenic.....	771
Same with .5% arsenic.....	669
Same with 1% arsenic.....	570
Wrought iron.....	436
Tin.....	422
Steel.....	397
Cast iron.....	359

Now while these are pertinent to the subject and very interesting, they do not apply directly, for the desired quantity in any comparison of cooling is not an abstract one, but an absolute, definite entity. So one more table is given of the amounts of heat radiated by different substances.

Heat Units Radiated per Hour per Square Foot of Surface for 1 Deg. Fahr. Excess in Temperature:

Polished copper.....	.0327
Polished tin.....	.0440
Polished brass.....	.0491
Polished sheet iron.....	.0920
Sheet iron.....	.5662
Glass.....	.5948
Cast iron, new.....	.6480
Cast and sheet iron, rusted.....	.6868

Relative Value of Detached and Integral Fins.—While on the question of efficiency it will be well to call attention to one very practical deduction which may be made from the above tables, viz.: that a detached fin on a tubular cooler is not the equal of an integral fin. This is seen in the first and third tables. A detached fin would transfer heat by radiation, while an integral one would dispose of it by conduction. Taking any material at random thus, for tin, the radiating power is only 150-1000 of the best medium, while the conducting ability which would be characteristic of the integral tin fin is 422-1000 of the best. A tin fin on a copper tube is not the equal of a copper fin on a copper tube, even if both be soldered.

(To be continued.)

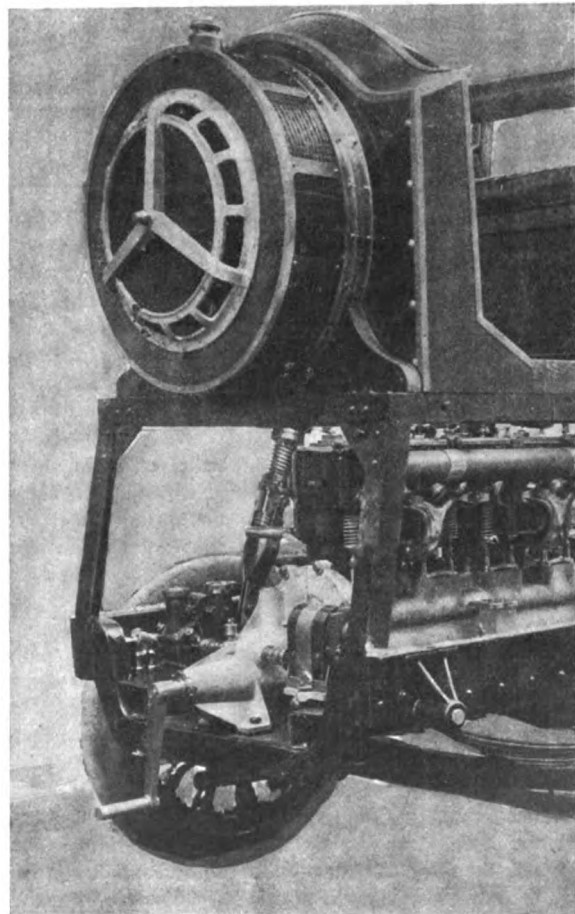

Fig. 13.—Novel radiator in place on a truck.

SELF STARTING DEVICES ATTRACT MUCH ATTENTION

TIME was when a motor that would start in a majority of crankings was something of a wonder. So far has the industry progressed, however, that to-day no one thinks a motor really good unless it will start on the first turn of the crank nearly always, and on the spark about half of the time. From a necessity, cranking is now considered by many as drudgery, so that efficient and reliable self-starting devices are in big demand.

There are not many of these on the market at present, but from all indications the coming and future years will see a gradually increasing number. Manufacturers who have fitted them in the past, even if they desired to discontinue, could not do so now on account of outside pressure. Similarly many makers who have not fitted them in the past are now working on various devices of this nature, in the desire to secure the necessary reliability before giving their stamp of approval.

Speaking broadly, there are two classes of starting devices, under one of which heads all starters come, as a matter of the basic principle and regardless of the details or the manner of working them out in practice.

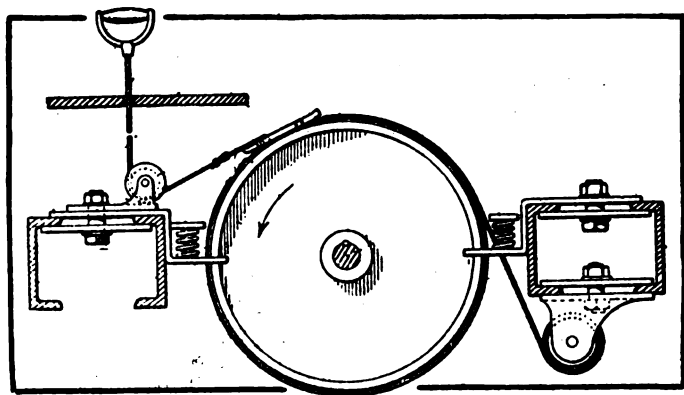

Fig. 1.—Strap used for starting purposes.

These are the mechanical or spring actuated and the compressed fluid actuated devices. In the first class properly belongs any mechanical contrivance by the use of which the driver of the car does not have to "wind up" the motor by means of a rotating lever directly attached to the engine, and, therefore, liable to a "back kick," which is the real objection to the cranking of the engine. This class includes such devices as the coil spring, wound up by the running of the engine after having been once started by hand. This is wound up tight and then the engine automatically cuts itself out, leaving the spring tense. To use, the spring tension is suddenly relieved by a suitable device and then it tends to unwind. This process results in a rotary motion which is utilized to turn the engine over.

Strap Starting Devices Look Very Simple.—In this class also belong that type of starters in which a strap is pulled upwards or sideways, this motion rotating the flywheel or other suitable drum. A spring returns the strap to place, so that it may be used over and over with no appreciable interval. In case the engine backfires or tries to rotate backwards, the strap simply slips on the drum or is pulled out of the operator's hand, with no attendant danger. Fig. 1 shows a commercial form of this type in which the strap is plainly seen. On the right is the drum upon which the strap is normally wound and held by means of a spring. The band or strap is normally held away from the drum by the two clips and springs, one on each side, but, when force

is exerted upon it to turn the engine over, these allow the band to take hold. In this way there are no friction losses from the dragging of the band when it is not in use. The angle of contact is very large, being nearly 450 degrees, so that a small coefficient of friction (such as this device would have) is sufficient to do the work.

This principle is utilized in another starter, which has a side lever in place of the handle, the remainder of the parts being the same. Another one of the mechanical starters uses the side lever, but for the actuating means has a modification of the worm and gear. A deep spiral groove is turned in the prolongation of the shaft and a pair of dogs set into this. The latter are constrained to move in a straight line, so that only the shaft rotates. By operating the hand lever the other lever carrying the dogs is moved, and through the medium of the spiral groove turns the shaft around, the total motion depending upon the length of the spiral and the amount of the lever motion. It may, however, be such as to afford three turns of the shaft, which usually are sufficient for starting purposes. A jaw clutch prevents the rotating of the engine from being retroactive, that is, from working the starting device in the opposite direction.

Very similar to this is the form in which a rack and gear are employed, the latter arranged on the crankshaft with a clutch and the former contacting with it. Motion of the hand lever draws the rack across the car, thus rotating the shaft, and with it the engine. Still other mechanical starters have been brought out and, in some cases, successfully used, but in the main these follow along the lines of some of the above-described contrivances.

Fluid Pressure Systems Are More Popular.—Owing to the fact that all of these require more or less physical exertion, the difference between them and the ordinary cranking being the linear motion instead of circular, and the elimination of all danger, the use of a fluid pressure system in which there is neither work nor danger is more desirable and would be more popular. After cranking over a big motor the notion of pressing a button to start is particularly attractive.

Nearly all of these use the air, but some employ the exhaust gases. The advantage in so doing lies in the elimination of the compressor and the attendant mechanism to drive, connect and disconnect it. As well as making for simplicity, this saves weight, and the elimination of extra parts allows the driver more peace of mind. All this is said with the proviso that the arrangement works and works at the desired time, without which it is useless. The doubt here expressed is a large item, and has proved the downfall of many an apparently good mechanism.

The system just spoken of may take either one of two forms, viz.: the actual exhaust waste gases may be drawn off from the motor, stored in a tank, and used as a source of energy; or the mixture may be taken during the compression stroke, just before ignition, so that the starting fluid is a combustible mixture and differs in the strict definition from carbureted gas only in being under great pressure.

The complaint made against using the exhaust is that the starting gases so weaken and impair the mixture from the carbureter that a considerable number of turns are necessary to start the machine. This in turn means a very large gas storage tank, which adds materially to the weight of the car. The exhaust pressure, in a well designed engine running under normal conditions, seldom exceeds 35 pounds, so that a high pressure may not be obtained from this source.

Any Pressure Possible with Outside Compression.—The method of utilizing the compressed gases has the same detri-

mental feature, but not in so marked a degree, in that *any* pressure is impossible. However, a very high pressure in comparison with the other method is obtainable. The compression usually runs from 70 pounds upward, and it has been known to be as high as 110 pounds, so this would give good, if not maximum results.

With an outside and independent compressor any desired tank pressure can be obtained, and, as a matter of fact, the majority of these systems do use it higher than any of the figures thus far given. In the Saurer system 225 pounds is maintained in the reservoir at all times, while the Renault method utilizes 250 pounds. Others use other pressures, but they are above 200.

As usually constituted, a fluid pressure system consists of a source of pressure or compressor, a storage tank, a distributing valve and a lever, button or other operating means. In use, the engine must be started by hand in the first instance. This creates a source of power, whether it be exhaust gas, compressed gas or air from a compressor driven from the crankshaft or camshaft.

Fig. 2 shows the essentials of a system in which the air-cooled compressor is driven off of the main driving shaft just ahead of the gearcase. The hand lever shown on the dashboard, when forward in the position marked I, throws the compressor clutch in, and it then charges the storage tank. The valve to the latter is set at 225 pounds, and when that pressure is reached the clutch is automatically cut out.

A Simple Touch on a Lever Starts the Engine.—When it is desired to start the car the lever, shown in larger size and more detail in Fig. 3, is pulled backwards as to position III, the compressed air from the tank flows up through the governing valve and thence to the distributor. The latter is situated high up between cylinders 2 and 3, and is driven by miter bevel gears from the crankshaft, so as to have the same speed of rotation as the latter. This consists of a revolving sleeve in which are cut ports, one for each cylinder. As the sleeve turns (with the crankshaft) these ports register in turn and in the proper firing order, with passages which connect to the individual cylinders. The air under pressure is admitted by the governing valve, on the dash previously spoken of, to the interior of this sleeve, and thence to the proper cylinder.

As shown in Fig. 4, this is open to cylinder number 2, and in this situation the air will pass into that one and drive the piston down. This must necessarily turn the crankshaft around, and with it the distributing valve, which thus registers with the cylinder next in the firing order, number 4, or whatever it may be.

From this it is plain that the tank will continue to feed air to the cylinders until all of the supply has been exhausted or the engine has been started.

A feature prominent in another system may be mentioned briefly. This is essentially the same as the one just described, but the control of the compressor differs in that the air-suction valve has a flexible diaphragm which is in contact with the tank, or rather to which the compressed air has access. As the pressure rises

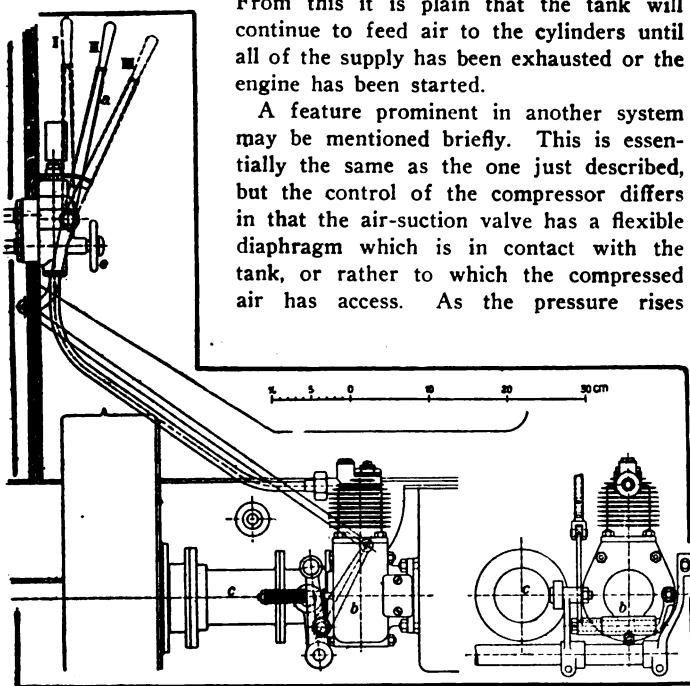

Fig. 2.—Essentials of a successful air starter.

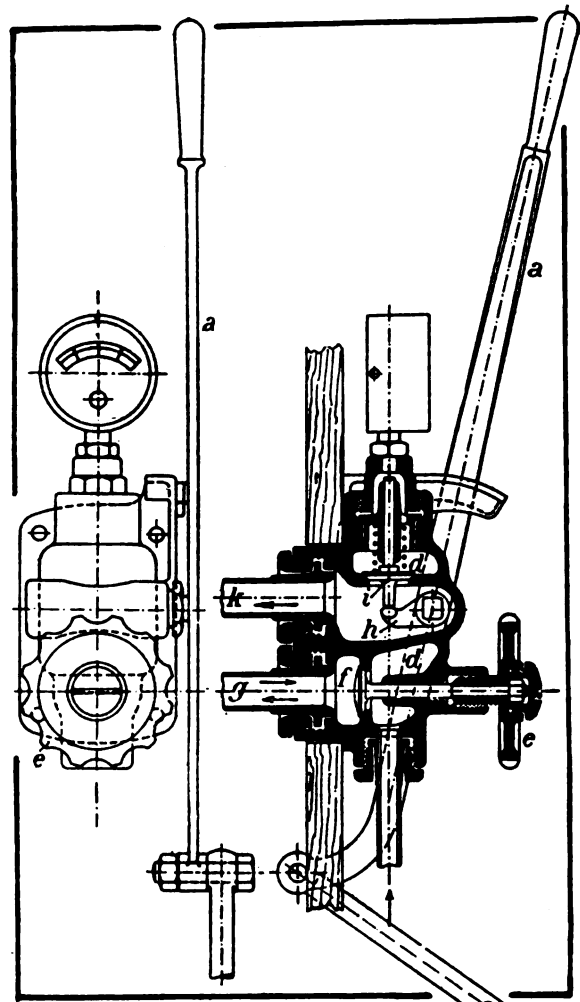

Fig. 3.—Details of the dashboard control.

this distends until, at the predetermined maximum, it holds the air inlet open, thus preventing compression and consuming no power. Of course, as the pressure falls off from leakage or the use of air the diaphragm changes its position to correspond, until at a certain fixed minimum pressure the suction valve will be allowed to close on the compression stroke, and thus the tank will be automatically replenished.

Pressure Useful in Other Ways.—Having a large tank of highly compressed air handy is useful in many other ways. For instance, for inflating tires, the autoist would take a chance on starting with less air and utilize a part of the tankful to inflate his tires. In many other ways this would be useful, but with exhaust gases in the tank most drivers would hesitate to use this source of pressure.

There are other systems which while using a part of the apparatus above described, do not use all of it, and consequently differ somewhat in their action. One that was given publicity recently is based on the assumption that when the spark and throttle are correctly manipulated just before stopping all of the cylinders but one will contain an explosive mixture. Granting that this is so, all that is necessary is a spark in the cylinder in which the piston is in the proper position for firing. This spark is effected by disengaging the driving gear and throwing the magneto armature around to a contact, the arrangement being such that on starting, the magneto gear drops back into its proper position and ignition proceeds as usual.

Latest Device Combines Electric and Pressure Methods.—The most recent starting device is in the nature of a combination of the stored pressure and the electrically operated devices. This is an American product, made in the Middle West, and very recently placed on the market, after two years of experimentation and successful tests.

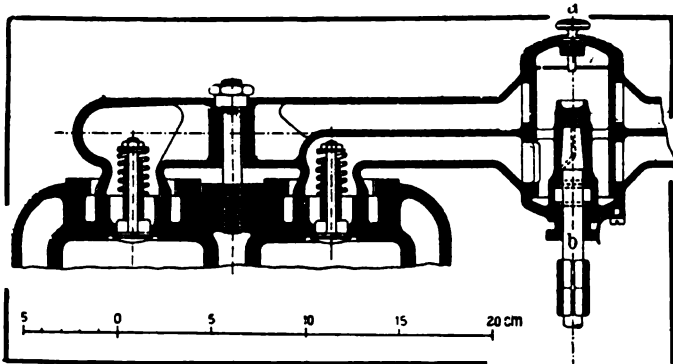

Fig. 4.—Distributing valve and air pipes.

The basic idea is a source of pressure, which is admitted to the cylinders by means of a system of magnetically controlled valves. The pressure utilized is that of the explosion, not the compression; not the exhaust, but the explosion. This, through the medium of a pressure-reducing valve, is reduced to 200 pounds, at which value the tank is filled. With a full tank, the valve cuts out the supply and the driver can then close off the valve communicating with the cylinders.

For starting, this fluid pressure is admitted to the cylinder through the medium of the distributing valves, which are placed on top of the engine as shown in Fig. 5, this being a view of the apparatus applied to an automobile engine. These valves are operated by means of an electric current, diverted from the regular ignition source, the only necessity being a direct current. This current is led through an ordinary timer and from there to the distributing valves in the cylinder heads. Thus it is that the valves are opened in proper rotation, each at the top of the piston stroke, which, while it is the correct position for the igniting spark in ordinary running, is also the correct position for the starting effort. So through the medium of the magnetically controlled valves the pressure is introduced to the proper cylinder at the proper moment. In the figure, *AA* are the magnetically controlled valves, to which the wires *DD* lead. *B* is the supply pipe from the storage tank. The shutoff valves are operated by a hand lever on the dashboard. *C* shows these, and just above them may be seen the operating rod. If a car has a double ignition system, the battery-timer system may be used for the starting by putting the starting switch in that circuit. Then by throwing the ignition switch to the battery and timer, and the starting switch to the starting position, the gas is admitted to the proper cylinder, the engine is started, and the ignition switch

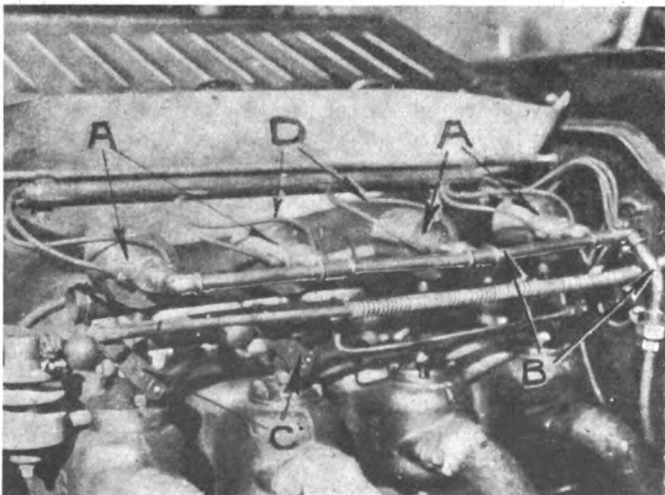

Fig. 5.—Combination system applied to an engine.

may be thrown over to the running position, whatever that may be, and the starting switch may be cut out.

This describes briefly the important features and method of operation of the principal forms of self-starting devices now in use. From a survey of these it is a safe prediction that from this time on each succeeding year will see more and more self-starters fitted to cars and working successfully.

CLEVELAND'S TRADE BAROMETER O. K.

CLEVELAND, March 29.—Things are "looking up" in the trade in this city, and from present indications 1909 will be the finest selling season ever enjoyed by the trade in northern Ohio. Every retailer, no matter whether he is selling cars or accessories, is doing good business, while the factories are all pushed to their limit.

The trade barometer in this city is steadily on the upward trend. No clearer indication of this is to be found than in the altered appearance of Cleveland's "auto row." The empty stores are gone, and in their places are appearing new concerns, already doing a good business. Enlargements and alterations are under way, while many companies heretofore located further down town are moving onto the avenue. Among the latter are the Pennsylvania Rubber & Supply Co., now located at 1843-45 Euclid, and the D. E. Foote Rubber Co., whose new address is 1837 Euclid. The new Firestone Tire & Rubber Co. is about ready to open its doors at 1930, while the Hammer & Hull Co. have located at 1841, the latter concern doing a general plating and repair business, devoted chiefly to fenders, pans and other metal parts.

One of the new concerns to exploit a car is the Avenue Motor Car Co., 1806 Euclid, agents for the Oakland. The Weddel House garage has taken the agency for the Inter-State in addition to the Regal. A number of other machines are scheduled for an early appearance, it is said. But the best of all is found in the fact that good, solid business is being done, although the weather does not allow of suitable demonstrations.

MAXWELLS NEED MUCH RAW MATERIAL.

Few people realize the tremendous quantity of raw material used by a large automobile concern; nor is this material confined to metals and those materials ordinarily associated with automobiles. To give an idea of the size of this business, the Maxwell-Briscoe Motor Co. is soliciting bids on material for the building of 12,000 cars. Among the articles enumerated are 200 tons of aluminum castings and 150 tons of brass castings. The babbitt metal that goes into the bearings alone is in excess of 50 tons, while the brass tubing that is used so extensively in automobile construction figures up something like 126,000 feet, or approximately 25 miles. In other words, enough tubing will be used on Maxwell automobiles to extend from New York to Tarrytown. The rivets alone will weigh over 30 tons.

Nor are the bids confined to metals. For example, 13,000 hides will be used for upholstery and trimming. Materials for tops call for over 40,000 yards. Then there is the iron and steel, of course, the biggest factor, 1,000 tons of steel bars, 800 tons of malleable iron, and so it goes. In special steels which play such an important part in the building of an automobile, the bids call for 50 tons of chrome nickel steel and 50 tons of nickel steel.

Although various modifications have been agreed to by the German Government commission in discussion on the Motor Liability law, yet the resolution agreed to prohibiting racing on the road will come as a severe blow to the sport, should it be passed by the imperial diet. The spirit controlling the diet is on the whole not favorable to automobilism, and should this measure go through, it will mean a very scanty European program. This season would probably not witness any big road racing in the Fatherland.

Letters Interesting and Instructive

TO VAPORIZE POOR GASOLINE.

Editor THE AUTOMOBILE:

[1,810].—Please advise me through "Letters Interesting and Instructive," why gasoline at 72 gravity is better than that of a lower gravity, say 64, and if there is any way of doctoring up poor quality or low gravity gasoline to a higher point of efficiency.

G. A. J.

San Francisco.

The density, or, as you have called it, the gravity, of the fuel really measures the vaporizing ability. This may be stated otherwise by saying that if the fuel is heavy, the work of converting it into a gas will be more difficult and will require more oxygen. It may be supplied in the form of any substance known to be rich in that element, as, for instance, picric acid. While this will allow the use of a low grade fuel for equal results, or if used with ordinary fuel (72 degrees), will give superior results, its use should be discouraged, as the resultant mixture is highly explosive under all conditions. Also, the other constituents of the acid are left in the cylinder as a deposit and the liquid itself is very expensive.

You can help yourself with low-grade fuel by the use of pure oxygen as put up in tanks, feeding it to the carbureter in small quantities. Air, as you know, carries only 20 per cent. oxygen by volume, or 23 per cent. by weight, the rest being foreign matter as far as vaporizing the fuel is concerned. Why use this medium, when you can use a pure oxygen with no foreign matter and a consequently improved efficiency? All this, providing you are willing to pay the bill.

NEW AIR PROPELLER BRAKE.

Editor THE AUTOMOBILE:

[1,811].—I wish to call your attention to the article that appears in "The Automobile" of March 18, page 469, entitled, "Features of new air propeller brake." If I understand this article right, the air propeller is driven by the roadwheels through the gearset and propeller shaft.

Further on is stated, "There is one other advantage to be taken into account in connection with brakes which receive their 'purchase' by way of opposition in the air, i.e., it does not matter at all if the wheels lose their tractive ability, since the fan brakes would still be in a position to work, regardless of the tractive ability of the road wheels. Indeed, the car, fitted out in this fashion, could be controlled even if the wheels might slip, so that the conventional brakes would fall to work, due to loss of traction on a grade."

Now, if the "fan" is driven from the rear wheels and these slip, does it seem reasonable to you that the "fan" should have any effect on the car? The way I understand that the "fan" is constructed, it is not its resistance to the air that has the desired braking effect on the car, but the resistance to the turning of the rear wheels caused by the power consumed in running the "fan."

On the other hand, if the "fan" was driven by the power of the motor, the "fan" would not have any effect on the car at all, as far as I can see. In the latter case, the only effect that the "fan" would have on the car proper would be a tendency to turn the car in the opposite direction to that of the "fan" if it is of large capacity. In my experience of hilly driving, I have always found it most economical to use the engine as a brake, and I believe it just as effective as the "air propeller" referred to. The "fan" would also be a bad "dustmaker."

I also wish to answer letter No. 1,795 in the same issue regarding signals, I have used the following around here with good results; one blast for request to pass; two, for turning out or turning corner to the right; three, for turning out or turning corner to the left; two long and two short for road or street crossing.

ARTHUR BEIJER.

Phillips, Wis.

To correct you on the subject of this new brake, it will be necessary to state that the article relative to it from our Paris correspondent was rather misleading, in that the driving mechanism was not fully explained. The fan brake is driven through the transmission and the lever controlling it allows the use with any speed provided in the gearbox. So it is plain that whether the wheels slip or not, the brake continues to work, providing the engine is running.

Now, as to the action of the propeller, it is so set as to tend to propel the car in a backward direction just as the reverse speed would. Descending a long hill, the force of gravity urges the car along at a considerable speed. In this case, the air brake lever is thrown into low speed and the power of the motor exerted against the downward tendency. If this were not sufficient, the second or higher speed would be thrown in, and the air brake rotated at a higher speed, with consequently greater retardation of the car. Ultimately, if necessary, the high speed can be used and the whole power of the motor applied to the purpose of braking. The device thus has an enormous advantage over the ordinary practice of shutting off the spark and using the compression strokes of the engine as a brake, in the ratio of the total maximum power to the comparatively small amount of power required to compress the charge.

In addition, the method of driving as you understood it will operate correctly. If the wheels slip, and the car momentarily accelerates, the extra speed turns the fan faster, which in turn increases the backward tendency, and thus offsets the slight gain in the forward direction. To sum the matter up, the engine turns the rear wheels and through them the fan. For the slope to increase this, it must increase the fan speed, which makes it necessary to increase the engine speed, which is apparently impossible.

STEEL TUBING FOR CYLINDERS.

Editor THE AUTOMOBILE:

[1,812].—Will you please state in your valued paper if it be possible to use cold-drawn steel tubing in motor cylinders?

WILLIAM HILLIARD.

Chicago, Ill.

Yes, steel tubing not only can be but has been used on some French racing motors. Its use necessitates an attached cylinder head and applied water jackets. The former is a construction which all designers do not favor. Another point is that while the action of cast-iron pistons at high temperatures rubbing on cast-iron cylinder walls is known, the same cannot be said for iron pistons on steel walls. The reverse of this, steel pistons in iron cylinders, has been tried and abandoned by several noted French firms.

This trouble is brought about by the difference in the two coefficients of expansion, the linear coefficient for cast iron being .0000556; for steel, .0000689. The cubical coefficient is three times this, or iron, .0001668; steel, .0002067. From this a piston which was just right for a four-inch cylinder at 70 degrees (.004 inch small), would be loose (.006 inch small) at 470. With larger cylinders and higher temperatures, it rises in proportion.

SHOULD FRONT WHEELS TOE IN?

Editor THE AUTOMOBILE:

[1,813].—On page 464, March 18 issue, in the article on steering gears by Mr. Fay, appears the statement that "if one (front) wheel toes in and the other is parallel with the roadway it will be very difficult indeed to steer the car." Also the statement that each of the front wheels should be adjusted to toe in exactly the same amount.

Will Mr. Fay please state what direction the car will tend to follow under the condition first named above, and will he please explain in what respect this condition differs from that of an intentional deflection of one degree, or thereabouts, produced by the driver to alter the course of the car? Are we to suppose that the car will steer perfectly when running straight ahead with each front wheel toeing in one degree, but will become partially unsteerable as soon as the driver turns the steering wheel till one of the front wheels is "parallel with the roadway"? When it comes to that, what has the direction of the roadway to do with the matter at all?

The article on acetylene generators in your issue of March 25 is full of inaccuracies. Calcium carbide is not soluble in water; it is not deliquescent, and the color of the commercial article is not dark brown, but gray. Overheating is alluded to as a probable and important source of trouble, but nothing useful is said about its cause or how it may be avoided. A good generator will not overheat under any circumstances. The drawing of the "conventional type of generator" shows a water jacket, but nothing is said in the text regarding the utility or otherwise of this jacket. The statement is made that a generator will afford an ade-

quate supply of gas at the right pressure, "cool and free from soot, sand, tar, and steam," provided the generator is big enough for the work and if provision is made to "scrub, cool, and purify the gas as it is delivered into the piping system." This is simply rubbish. No automobile generator, within the writer's knowledge, contains any provision whatever for scrubbing the gas, nor any further provision for purifying it than the usual hair filter. A correctly designed generator does not need such provisions, and a poor one is not helped by them. Neither is it true that the size of the generator has anything to do with its ability to maintain the correct pressure on the gas line, except that in a small generator the water is more rapidly consumed and the pressure therefore falls faster than if the generator be of good size.

The statement that the water soon gets hot as a result of the heat generated by the "dissolving" of the carbide, is equally incorrect. The water gets slightly warm; no more.

The allusion to the "sludge" resulting from the action of the generator suggests that possibly the author's experience is limited to the generators in vogue five years ago, or to the cheap brass cans which are "thrown in" by the makers of the cheap class of cars, and (usually) thrown out by the purchaser after one or two attempts to make them work. In a good modern generator no sludge is formed, the lime taking the form of a dry powder.

In warning the reader against slipshod piping, the author forgot to state that a trap should be provided at the lowest point of the piping system which should hold two or three teaspoonfuls of water without interfering with the flow of gas. Such a trap rarely needs to be drained, as the condensed moisture evaporates between runs.

HERBERT L. TOWLE.

New York City.

In the Fay article in relation to steering, it is clearly indicated that the front road wheels should be set to toe in slightly, rather than to be set indifferently. In another part of the same article it was pointed out that instability begins when a car is diverted out of its straight course. Any statement in an article should be weighed in the presence of other statements bearing on the subject and intended to amplify.

Account must be taken of acetylene generators of a class that do not come up to Mr. Towle's standard. If a generator is so good that it will not give trouble, the possessor will be wasting his time on the article to which reference is made.

TIRE CAPACITY EXPLAINED.

Editor THE AUTOMOBILE:

[1,814].—Will you kindly give me the rule or formula by which the carrying capacity of an automobile tire is determined? I have seen tables published from time to time, but am unable to arrive at a hard and fast rule for calculating weights from sizes. Take, for example, three tires: 36 by 3 1-2, 32 by 3 1-2, and 30 by 3 1-2. In actual experience, the last size will wear the other two, but in running over small depressions, the larger tire is easier on the passengers.

I believe it would be interesting to your readers to have a full discussion of this subject, as the wearing properties may be vastly different from the weight sustaining powers. For instance, a 36 by 3 1-2 tire might sustain more weight while standing

idle than a 30 by 3 1-2, yet the smaller diameter would outwear it.

CHARLES V. CRITCHFIELD,

Mt. Vernon, O.

There are two questions to be considered: The ability of the tire to withstand pressure from within, and the weight-carrying ability when properly inflated. The wearing qualities vary with different makes, with different sizes, and with different diameters. This, too, being a question of relative ability cannot be discussed in these columns.

The fabric used in tires varies, but in general good fabric will stand a breaking strain of about 350 pounds per square inch. In a tire having six plies, there is a strength of six times this, or 2,100 pounds per square inch. From this it is apparent that there is very little danger from any ordinary pressure.

The weight on a tire is carried not by the tire itself, but by the air pressure within, the tire simply acting as an envelope to retain this air where it is wanted. If there is not sufficient air pressure to bear the weight, the tire must suffer. Tire manufacturers seem to agree very closely on the carrying capacity for the sizes herewith mentioned:

Size.	Carrying Capacity.
30 x 3½	450 pounds 500 pounds 450 (front) 550 (rear)
32 x 3½	550 pounds 600 pounds 500 (front) 625 (rear)
36 x 3½	600 pounds 600 pounds 600 (front) 750 (rear)

These figures are from three firms, differing as to location, style of tire made, and quality of the same.

HINTS FOR WORTHY CONTESTS.

Editor THE AUTOMOBILE:

[1,815].—Having just read an article in the March 18 issue entitled, "The More the Haste, the Less the Speed," I would like to make a few suggestions along the same line. We will all agree with the writer of the article that in road races and hill climbs, where speed is the main object, the direct benefit to the buying public is very small; still, at the same time, we must realize that the strength and endurance of a car is tested under these circumstances more than under any other. Therefore, it is a positive fact that the designer is greatly benefited by long, high-speed races and hill climbs, and if the manufacturer will use the material and design in his commercial car that he does in his racer, granting, of course, he makes minor changes to conform to the two distinct purposes involved, the purchaser can rest assured that the car he builds will be one of the best.

Speed contests serve their useful purpose and give a sporting interest to the business; so let them continue, but at the same time give the prospective buyer a contest that will be of special benefit to him. The endurance contest is all right, but the bystander cannot see it clear through. He can see one car, then another pass, but unless he is very much interested he never knows who won, or why. He wants a contest wherein he can see the start and finish and knows who wins, finally.

The coasting contest suggested is along the proper line, but too easily imposed upon. We all remember the old coasting contest of bicycle days when the machines weighed several times what a standard stock machine would be permitted to weigh, bearings were adjusted so loose that they would not have stood up to one hour's hard work, chains were left loose, and in many cases dropped off the sprockets while coasting. All this was done to eliminate friction, and the same things and many more would be done to an automobile under the rules suggested. If the clutch was disengaged, wherein would the motor, the vital part of a car, and its attachments be tested? If the clutch were engaged, there would be a hundred ways to beat around the rules, so that the contest would demonstrate nothing.

One of the most desirable things in an automobile is a flexible motor and power at motor speed. To bring out these points, I would suggest a hill climb run as follows:

Let each car climb the hill for speed on high gear; then let each car climb the hill on high gear at slow speed. Make it necessary that cars start on high and keep the clutch in after it is once set, the touching of clutch, pedal, or lever being cause for disqualification. The result of the contest would be determined by proportioning of the results of the two climbs.

Another method would be to have the time of the cars taken at a half-way mark; also at the top of the grade under the following conditions: Compel the cars to start on high gear at the foot of the grade and proceed as slow as possible to the half-way mark, from there on make it a speed contest, but require that the high speed be used all the way. The final showing would be computed on the times shown at both places.

In working up a formula for either of these contests, the writer would favor one giving the advantage to the car that made the best showing at slow speed, because we all know that the motor that is so built that we can drive in deep mud or gravel, or on a grade for a long distance on high gear without having to race through at a dangerous pace, is to be preferred to the one that must use a lower gear or high car speed to get engine speed in order to obtain power. Therefore, give the motor that can develop power at slow speed a chance to show its worth. But it must have a reasonable amount of speed; therefore make it work at both. In fact, in order to prevent exceptionally low gear ratios on high, it might be well to compel the cars to compete in short speed trials on the level and use this time in the final results. Such a contest would not only test the cars in every respect, but also the skill of the driver and be beneficial to all.

Peru, Ind.

H. M. CONROW.

VALUE OF COASTING TEST.

Editor THE AUTOMOBILE:

[1,816].—Your March 18 issue with the article, "The More the Haste, the Less the Speed," by C. E. Duryea, if more than casually read suggests many pertinent thoughts. His article contains some of the ideas in my letter, published a year ago.

It occurs to me now that a "coasting test" might be further enhanced by the following: Take the speed of the car over the last 100 feet by approved automatic methods and compare it with the reading of the speedometer taken by an official observer. When the car crosses the finish wire of the speed test, automatically fire a gun, and measure the time and distance required by the driver to bring his car to a stop.

Comparisons are often odious, and might sometimes be so in tests like these.

Chicago. Dr. M. A. MARTIN.

Spring's Advent Stimulates Club Activity

LONG ISLANDERS INITIATE NEW CLUB HOUSE.

BROOKLYN, March 29.—Situating literally "at the gateway of Long Island," at the entrance to Prospect Park and the Eastern Parkway, the new club house of the Long Island Automobile Club was opened officially on last Friday evening, with a "biggest" smoker and a vaudeville entertainment. Fully five hundred persons attended, members bringing their friends, the new rooms inspected, and the varied programme thoroughly enjoyed.

For several years the club has been located at 360 Cumberland street, but recently the new home was secured at 920-922 Union street, a well equipped garage being taken, the four floors and basement renovated and rearranged so that the second floor could be used for the club members, while the other three floors and the basement are used for storing and caring for the machines. This means of combining the two features of the club has given a great deal of satisfaction, and already the garage space is pretty well taken. Cars have been stored in the building for nearly a month but the club rooms have just been finished.

The second floor is spacious enough to be divided into four parts, a billiard and pool room, a reading and writing room, a dining room and offices. They are all separated by portable partitions, and when entertainments are scheduled, these are removed so that the whole floor can be used, and stage is wheeled into position. The color scheme is green and white, with a choice selection of automobiling pictures on the walls, cabinets for trophies included in the furniture, and nothing left undone to provide for the comfort and pleasure of the members. The kitchen installed is large enough to handle a banquet, and regular dinners will be served from it.

Once a month, or nearly so, a vaudeville entertainment is given, under the direction of Edward Melvin, who is chairman of the house committee. President Frank G. Webb opened the club rooms with an address of welcome. The other officers are William P. Schimpf, vice-president; Charles T. Cuff, treasurer; Herbert G. Andrews, secretary. A ladies' night is set for April 16.

WILKES-BARRE GETS NATIONAL HILL CLIMB.

WILKES-BARRE, PA., March 29.—That the annual hill climbing contest of the Wilkes-Barre Automobile Club on the Giant's Despair Mountain will be an event of national character has been confirmed through the receipt of the sanction for the national hill climb from Frank B. Hower, chairman of the A. A. A. Contest Board. With this in the hands of President George F. Lee, of the local club, the enthusiastic autoists of this city will at once begin the preparations for the contest, which will undoubtedly be one of the most important events in the automobile world.

As May 30 comes this year on a Sunday, it has been decided to hold the contest on Monday, May 31, and it is expected that not only the usual quota of powerful cars and drivers will be present, but many new ones, and perhaps some foreign cracks, Fred J. Wagner, the famous A. A. A. starter, who has officiated in that capacity with great success here before, will have that position this year, and will be given more authority and more of the preparatory work than heretofore.

GRAND RAPIDS CLUB CHOOSES NEW HOME.

GRAND RAPIDS, MICH., March 29.—The members of the Grand Rapids Automobile Club unanimously decided at their meeting recently on Cascade for their new clubhouse. This is the same house used two years ago, but a new road leading from the Thornapple River to the house has been built, and the house will be completely refurnished. It will be ready for use May 1.

HARRISBURG CLUB MAY HAVE TIRE TEST.

HARRISBURG, PA., March 29.—In response to the frequent proposal of combining a tire contest with an endurance run, the Motor Club of Harrisburg is considering having this feature in connection with its annual contest next May. Secretary W. R. Douglass has taken up the matter of rules with some manufacturers, and George M. Stadelman, secretary of the Goodyear Rubber & Tire Company, has suggested the following:

All tires used in the contest should be purchased on the open market, which prevents the use of special tires made for the purpose, and which are not sold regularly to the trade.

Each tire manufacturer should have the right to designate the particular style of tire he manufactures to be used in the contest.

[By way of explanation, we wish to state that this company makes two forms of tires: detachable with straight sides, and clincher with beaded sides. We make the former because we believe it to be the most practical, durable and trouble-proof design. We make the latter because there is a demand for a tire to fit regular clincher rims, on which our detachable form of tire cannot be used. For this reason, it would be unfair to compel this company to enter clincher tires in the contest, when we are positive that our detachable form of tire is better suited for the purpose, and is the one that we are urging automobilists to buy.]

All time lost for stops occasioned by tires should be penalized a certain number of points for delay occasioned by punctures; a heavier penalty occasioned by blow-outs; and a still heavier penalty for loss of time occasioned by tires blowing off the rim.

We would allow each car three tires for rear wheels, and three tires for the front wheels, which would provide one spare for each wheel without penalizing for anything but time lost; but should a car have to use the seventh casing, or more, a very heavy penalty should be inflicted for each additional casing in addition to time lost for charging.

There should be official observers to check the tire losses in a similar manner to the way each car's losses are checked. The tire companies competing should have representatives in the races, but not on cars equipped with their own tires.

A duplicate set of rules has been sent by Mr. Stadelman to the Contest Board of the A. A. A., suggesting a similar tire contest for the Glidden Tour.

WHAT ONE CLUB HAS DONE IN ITS VICINITY.

PHILADELPHIA, March 29.—Chairman W. O. Griffith, of the routes, maps and signs committee of the Automobile Club of Philadelphia, has outlined a comprehensive campaign for the coming year. Four sections of the club's map scheme are under way, and will probably be published in the course of a year.

The new club route book of 213 pages contains 180 pages devoted to new routes and maps. An idea of the enormous amount of work done by this committee last year may be had from the annual report of the board of governors, which showed a total of nearly 1,100 signs of various classes placed in position, including mileage, direction and warning signs. This means that no less than seven main through routes and about a score of minor routes out of this city have been clearly and thoroughly marked at all crossroads and forks, dangerous hills, sharp turns, and with warnings where the authorities are particularly severe. The end of the coming year will see this result multiplied by two, if Chairman Griffith can secure money to carry on the work.

GERMANTOWN'S CLUB AFTER OFFENDERS.

PHILADELPHIA, March 29.—In an effort to put a stop to the numerous gross violations of the speed ordinances in this city and suburbs, the committee on Automobile affairs of the Automobile Club of Germantown is urging members of the club to inform Chairman C. H. Wheeler immediately of all such violations, giving the number of the car and the particulars.

NOW BALTIMORE PLANS AN ENDURANCE RUN.

BALTIMORE, March 29.—These are busy days for the members of the Automobile Club of Maryland. They are now making preparations for holding a tour, or efficiency contest during the month of May, and Secretary Frank Darling has already prepared a tentative plan and route. He proposes that the course be from this city to Ridgeville, and thence to Frederick, a distance of 48 miles, taking the cars over roads that at their best are only fair. On the return trip, at Eccelston station, there is an exceedingly steep hill, and Mr. Darling's plans call for timing the cars on the mile and a half climb.

The cars on the outbound trip would pass through Lewistown, Catoctin, Thurmont, Emmitsburg and Gettysburg, a distance of 33 miles from Frederick. The road from Emmitsburg to Gettysburg is rather rough, and would be a good test for the cars. Returning the cars would go through Littlestown, Westminster and via the Valley road, which comprises about 35 miles. This would make the entire distance of travel about 115 miles, which the cars would be expected to make within seven or eight hours. The rules specify that all hoods shall be sealed and the cars placed in a garage, under the care of the contest committee, until the machines have been examined for loose parts and other mishaps that might occur in consequence of the run.

QUAKER CITY M. C. WANTS A TRACK RACE.

PHILADELPHIA, March 29.—The most surprising bit of news from the various local clubs' headquarters the past week was the announcement by the Quaker City Motor Club that a 24-hour track race would be run off under its auspices—probably at Point Breeze track—on June 11 and 12. In the light of the A. A. A.'s announced determination to discourage racing on mile circular tracks, this looked very much like open rebellion or a decidedly marked change of opinion on the part of the National Contest Board. Certainly the Quakers appear to be cocksure of securing the necessary sanction, and are already at work on the preliminaries of the race, for which it is claimed a sufficient number of entries had previously been promised to insure its success from that standpoint.

NEW JERSEY RUN FOR AMATEURS ONLY.

NEWARK, N. J., March 29.—For amateur drivers only, members of the club who are not connected with the trade, the New Jersey Automobile and Motor Club, is arranging to hold its third annual endurance contest over a ninety-five mile circuit, with two laps, giving a total distance of 190 miles, on May, 22, if plans as already outlined prove thoroughly feasible. At this time of the year when the trade members of the club are particularly busy, it has been decided to put them all on an equal footing, by making the affair for private owners.

The scheme as considered best by the club, is to have the cars start from this city at 8 o'clock in the morning, running on a schedule of 19 miles an hour, and checking in at two places on each round, first Hackettstown and then Newark, arriving in this city on the first lap at 1 p. m., and on the final round at 6 o'clock in the evening. Pathfinders will go over the route to finally map it out, and as at present suggested, the ones chosen will be very popular, inasmuch as almost all kinds of road conditions, except very soft mud, will be found. There will be plenty of pleasant touring over the fine macadam roads, some strenuous traveling over rocky roads in the country, and at least one good hard climb on each trip over Schooley's mountain.

Hackettstown is 42½ miles from the start, exactly half way, and the proposed route would take the contestants out of Newark, then through Irvington, Chatham, Madison, Morristown, Mendham, Chester, German Valley, over the mountain and down into Hackettstown. The second stretch would take them up to Allamuchy, where a turn is made and the beaten path left for time, while the road is rocky enough to give the cars and drivers a good test. The course leads to Stanhope, through Port Morris and Dover. At this point there would be a choice of routes, one leading to Morristown and thence to Newark over the out-bound route. It is more likely that one leading from Dover through Rockaway, Denville, Pine Brook, and Montclair will be taken. This course would be covered twice, and a number of valuable prizes will be given for the best performances.

The committee in charge of the contest is: H. A. Bonnell, chairman; F. A. Croselmir, A. B. Le Massena, H. A. Bowman and D. C. Reynolds.

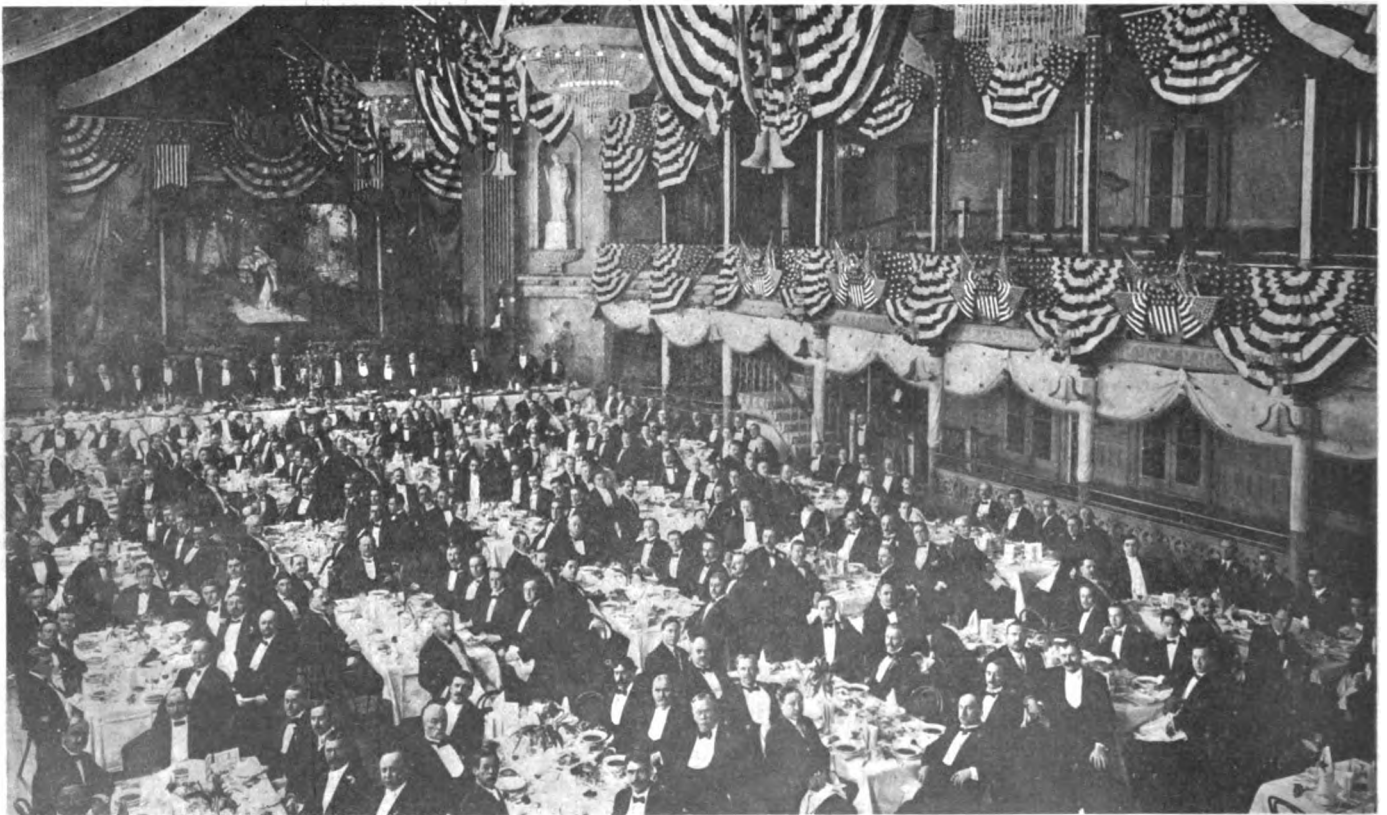

Sixth Annual Banquet of the New Jersey Automobile and Motor Club, Krueger's Auditorium, Newark, March 18.

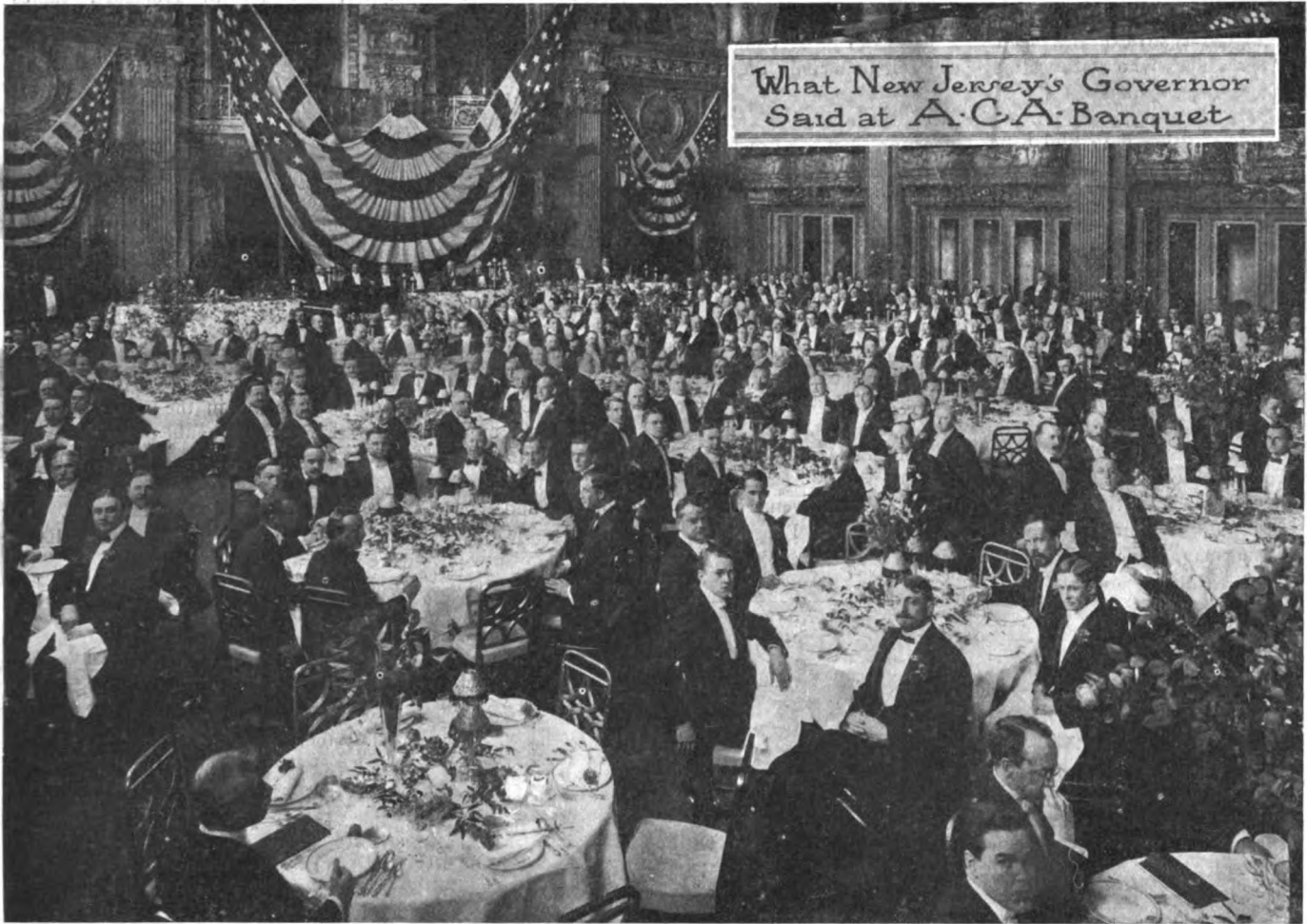

Tenth Annual Banquet of the Automobile Club of America, Held March 25, at the Waldorf-Astoria, New York City.

UNDETERRED by the necessity of taking out a license and unmarked by a traveling number, the Governor of New Jersey on the evening of March 25 crossed the Hudson River and entered the adjoining commonwealth of New York State. Comfortably conveyed in a motor-driven vehicle to the Waldorf-Astoria, Governor Fort became the guest of honor at the tenth annual banquet of the Automobile Club of America. Speaking more or less impromptu, 'tis possible that New Jersey's chief executive may have been carried away by the enthusiasm of the moment and given utterance to sentiments to which heretofore he had been a stranger, for certainly his ideas have undergone considerable modification since the night a year ago when at the dinner of the New Jersey Automobile and Motor Club he then president of the American Automobile Association, William H. Hotchkiss, handled the New Jersey law so scathingly that the Governor impetuously took it upon himself to defend a law in the making of which he had had nothing to do. Then he said he believed in uniform laws, and that this could be brought about by the other States copying New Jersey's excellent statutes. At the A. C. A. function Governor Fort said:

I want to help, as I believe the New Jersey Legislature does, every reasonable act for the bettering of the automobile interests and of the operation of the automobile in our State. The problem is only to be solved in my judgment in one way. We have been doing too many things in this republic of ours by single States.

Interstate agreements are provided for under the constitution of the United States. With the consent of Congress any two States may make any agreement they please between themselves, and if New York and New Jersey and Connecticut and Rhode Island and Massachusetts and Maryland shall agree together on a method of travel by automobiles and a uniform fee for all these States, and it shall be approved, we shall need no further legislation on the subject, and we shall have one fee for all these States in the East.

Recently, through the initiative principally of Governor Hughes,

there was held a conference of the commissioners on uniform laws of New York, New Jersey, Connecticut and Massachusetts, the result being the drafting of an automobile law intended to be acceptable to those commonwealths. This measure, it is stated, is shortly to be introduced at Albany, with chances favorable for its passage, though perhaps modified in minor particulars.

In the course of his talk of half an hour Governor Fort said among other things:

The automobile is here to stay, and Legislatures and all others may as well recognize that fact. That being a fact, we must have laws on the subject of speed that are clear and simple. They must be so that every man can read and understand them and make no excuse when he violates them.

We must have a speed limit such as shall not create a race of lawbreakers. I am opposed to putting in the statutes of our States or in the acts of Congress that which every man knows nobody intends to observe. It is not fair to the man who uses the highway, it is not fair to the public morality of the State to put restrictions in laws that cannot ordinarily be observed, I would have the laws fair and just to every man, and then I would enforce them. Every vehicle upon the public highway should carry a light of some kind. Every drunken driver should be deprived of his license and punished in some way for being drunk.

No summary arrest should be permitted upon the highway of a man driving an automobile, continued Governor Fort. He should only be stopped for the purpose of taking his number, and let the orderly proceeding in court go on later. No trap should be set anywhere for the purpose of catching people on the highway.

Our fees over in New Jersey I believe have been criticized. I believe the sentiment in our State to-day is in favor of making the laws so that you can come without paying extra license fees. Why shouldn't you come to New Jersey?

A Voice: "Because you rob us!"

We want you to come, and we are going to try and make it so that you will come.

Resentment at the attitude of the New Jersey lawmakers in ref-

erence to automobiling has been undisguised on numerous occasions, and the reference to being robbed met with approving laughter from parts of the big ballroom, as did other comments of irrepressibles who at times may have felt financially the sting of the Jersey constables.

Judge E. H. Gary, president of the A. C. A., divided the guests' table, those sitting with him being Governor Fort, ex-presidents Dave Hennen Morris, Winthrop E. Scarritt and A. R. Shattuck; Colonel John Jacob Astor, George F. Chamberlin, William G. McAdoo, William Pierson Hamilton, Cortlandt Field Bishop, Henry Sanderson, Robert Lee Morrell, Dr. Schuyler Skaats Wheeler, William H. Barnard, Colonel Austen Colgate, Duncan McDonald, of Montreal, and the Hon. Beverley Robinson.

J. B. R. Smith, commissioner of motor vehicles for New Jersey, was an interested listener, and others in evidence included Jefferson deMont Thompson, Charles J. Glidden, Robert Graves, Alan R. Hawley, Captain Homer W. Hedge, R. A. C. Smith, Philip T. Dodge, H. K. Burras, W. D. Gash, H. H. Law, C. J. Obermayer, Alfred Reeves, E. P. Chalfant, H. M. Swetland, Benjamin Briscoe, J. D. Maxwell, S. T. Davis, Jr., A. L. Riker, R. D. Garden, S. E. Stevens, Carl H. Page, Percy Owen, Horace DeLisser, Walter Christie, Frank Eveland, John Van Benschoten, F. D. Dorman, General John T. Cutting, Harry G. Fisk, Peter

Fogarty, E. Rand Hollander, William B. Hurlburt, James Joyce, J. M. Lansden, A. L. McMurtry, E. J. McShane, F. E. Moscovics, E. S. Partridge, H. W. Nuckols, K. C. Pardee, Orrel A. Parker, A. P. Palmer, John F. Plummer, Jr., C. R. Teaboldt, Harry Unwin and A. H. Whiting.

Aside from the general remarks of Judge Gary about the club and the rather unexpected expressions from Governor Fort, there was no speechmaking, the others scheduled failing to appear. These were the Hon. Chauncey M. Depew, Congressman J. Van Vechten Olcott and State Senators Allds and Hill. But Chairman Ely of the banquet committee had provided several grand opera singers and artists who may have met the needs of the occasion in a manner more pleasing to the majority than would have been after dinner words of wisdom on automobile legislation, which subject the many are ever inclined to leave in the hands of those who find satisfaction in working for the good of the cause. One big disappointment came in the announcement that at the last moment Miss Mary Garden could not be present owing to a hard cold. Madame Doria and Mlle. Trentini, one a contralto and the other a soprano, were substitutes, with Signor Sammarco and Herr Meizel also contributing brilliantly, the first with some exquisite violin playing. Some 450 attended the banquet. The souvenirs were elaborate menu cards.

THE AUTOMOBILE CALENDAR

AMERICAN.

Shows.

- April 10-17.....Brooklyn, N. Y., Clermont Rink, First Annual Automobile Show, Long Island Automobile Club.
 April 17-24.....Montreal, St. Lawrence Hall, Fourth Annual Automobile Show, auspices of Automobile Club of Canada. R. M. Jaffray, Manager.

Races, Hill-climbs, Etc.

- April 22.....Chattanooga, Tenn., Hill Climb on Lookout Mountain, Lookout Mountain Automobile Club.
 April 24.....Philadelphia, Roadability Run to Atlantic City, Quaker City Motor Club.
 April 26-May 1...New York City, Second Annual Automobile Carnival, New York Automobile Trade Association.
 April 26.....New York City, Second Annual Hill Climb, Fort George-New York Automobile Trade Association.
 April 28-30.....Pittsburg, Pa., Gazette Times-Chronicle Telegraph Three-Day Endurance Run. Indorsed by Automobile Dealers' Association.
 April 30.....New York City, Endurance Run, New York Automobile Trade Association.
 May 3-6.....Harrisburg, Pa., Third Annual Endurance Run, 700 miles, Washington, Baltimore, Scranton, Motor Club of Harrisburg.
 May 10-13.....Detroit, Mich., Four-day Endurance Run, Detroit Automobile Dealers' Association.
 May 11-15.....Philadelphia Reliability Run to Pittsburg and Return, Quaker City Motor Club.
 May 18-19.....Norristown, Pa., Second Annual Endurance Run, Norristown Automobile Club, to Hagerstown, Md.
 May 22.....Hartford, Conn., 200-Mile Endurance Run, Hartford Automobile Club.
 May 22.....Newark, N. J., Third Annual Endurance Contest, New Jersey Automobile and Motor Club, 190 Miles.
 May 31.....Wilkes-Barre, Pa., Annual Hill Climb, Giants' Despair Mountain, Wilkes-Barre Automobile Club.
 May 31.....Bridgeport, Conn., Annual Hill Climb, Sport Hill, Automobile Club of Bridgeport.
 June 1.....New York City, Start of Transcontinental Contest to Seattle, for Alaska-Yukon-Pacific Exposition, M. Robt. Guggenheim Trophy.
 June 11-12.....Philadelphia, 24-Hour Track Race, Quaker City Motor Club.
 June 12-14.....New York City, Catskill-Berkshire Endurance Contest, New York Automobile Trade Association.
 June 18-19.....Chicago, Stock Chassis Race for Cobe Trophy and Light Car Race.
 June 21-26.....Binghamton, N. Y., Fourth Annual Endurance Run, Albany, Boston, Hartford, Newburg, Binghamton Automobile Club.

- June 22-28.....Albany, N. Y. Fifth Annual Tour, Bretton Woods, Portsmouth, Boston, Albany Automobile Club.
 June 24-26.....Montreal, Blue Bonnets Track, Race Meet. R. M. Jaffray, Manager.
 July 3 and 5.....Wildwood, N. J., Straightaway Races, Motor Club of Wildwood.
 July 4.....Los Angeles, Cal., Southern California Automobile Dealers' Association. Road Races, 250 Miles for Large Cars; 150 Miles for Light Cars.
 July 7.....Detroit, Start of Sixth Annual A. A. A. Tour for Glidden Trophy.
 Sept. 15.....Denver, Col., Start of Flag to Flag Endurance Run to Mexico City.
 Oct. 7.....Philadelphia, Second Annual Stock Chassis, 200-Mile Race, Fairmount Park, Quaker City Motor Club.
 Dec. 29-30.....Philadelphia, Fourth Annual Mid-Winter Endurance Contest, Quaker City Motor Club.

FOREIGN.

Races, Hill-climbs, Etc.

- March 31-Apr. 14..Italy, Monaco, Annual Motor Boat Regatta and Championships.
 April 11-18.....Austria-Hungary, Prague, Automobile Exhibition, Hill Climb at Koenigsaal, Automobile Club of Tcheque.
 April 22-30.....France, Paris, Small Commercial Vehicle Competition.
 April 26-May 13..Germany, Commercial Vehicle Competition, Kaiserlicher Automobile Club.
 April 29.....Sicily, Volturette Races.
 May 2.....Sicily, Targa Florio, Automobile Club of Italy.
 May 6-9.....Austria, Small Vehicle Competition, Automobile Club of Austria.
 May 8-23.....Belgium, Antwerp, Sixth International Automobile, Cycle, Maritime and Fluvialle Exposition.
 May 10-15.....Sweden, Industrial Vehicle Competition, Automobile Club of Sweden.
 May 20.....Spain, Coupe Catalunya Race for Light Cars, Royal Automobile Club of Spain.
 May 26.....Russia, Moscow-St. Petersburg Race, Automobile Club of Russia.
 June 10-18.....Germany, Prince Henry Cup Competition.
 June 14-19.....Scotland, Annual Scottish Reliability Trials.
 June 20.....France, Boulogne-sur-Mer Course, Volturette Race, Auspices "L'Auto."
 July 13-17.....Belgium, Ostend Automobile Race Week.
 Aug. 22-29.....France, Reims, Aeroplane Races and Grand Prix, Aero Club of France.
 Sept. 5.....France, Mont Venteoux Hill Climb.
 Sept. 19.....Austria Semmering Hill Climb.

M. C. A. WON'T SUPPORT CROSS-COUNTRY TEST

NEW YORK, March 30.—Manufacturers and importers of automobiles, in a regular meeting of the Manufacturers' Contest Association, held in this city to-day, after considerable discussion and hearing representatives of the Alaska-Yukon-Pacific Exposition, the Automobile Club of America, and the *New York Times*, decided not to give the support of the recently formed organization in the promotion and running of two proposed transcontinental contests. The M. C. A. stated, however, that it was not opposed to such contests, but inasmuch as the rules for the run to Seattle did not meet with its approval, it did not feel that it should sanction another event, as a rival to the one sanctioned by the Automobile Club of America. This meant the proposed contest of the *New York Times*, the management of which clearly stated that it did not intend to promote any such event, except that it met with the approval of a substantial portion of the automobile industry.

These are the resolutions officially promulgated:

WHEREAS, The Manufacturers' Contest Association advocates and will lend support to races and contests that furnish to the public a basis of the comparative merits of cars and that demonstrate to the manufacturers where improvements can be made in material and construction, to the end that only the best in motor cars may be offered to the buying public; therefore, be it

RESOLVED, That the Manufacturers' Contest Association in meeting decides unanimously that for the following reasons it cannot lend support to the proposed race from New York to Seattle, although sanctioned by the Automobile Club of America, whose right to grant a sanction for this event is unquestioned:

First—The entry blanks distributed among the manufacturers state that it is a "race," and as such it cannot but place a premium on speeding in violation of State laws, which is contrary to the position automobile makers have taken with the various State Legislatures.

Second—The rules on the entry blank, which, among other things, provide that engines, axles, gears, etc., may be changed twice and only the original frame brought to Seattle, are not for the betterment of motor car manufacture.

Third—The entry blank statement, "The first car arriving at Seattle will be declared the winner" presupposes a road race without regard to speed regulations, the prize going to the car whose drivers most consistently and persistently disregard the conditions and laws under which the authorities permit the use of motor cars.

Fourth—Another rule provides that the crew of a car may drive continuously from New York to Seattle, or as nearly so as the endurance of the crew, relaying each other, will permit. The contest would therefore be strung out over a period of hours and days, making it impossible to safeguard the highways and the public for the continuous time necessary.

Fifth—The rules as a whole, or the explanation of the race representatives, do not assure the Manufacturers' Contest Association that the contest will advance either the pastime or the industry.

Sixth—The excellent record of the Automobile Club of America in the sport and industry makes it a matter of regret that it should have given its sanction to the rules that are offered for the government of this proposed race.

Questions of speed and of changing parts of cars seem to be the reasons predominant in influencing the M. C. A. against the contest. The rules do not place a time allowance which would make the contesting cars keep within the various speed laws; and engines, axles, gears, etc., can be changed twice in the trip across America, only the original frame having to be used throughout. While Mills and Moore and Robert Lee Morrell, of the Automobile Club of America, express regret that the manufacturers and importers have taken a stand against the event, they state that nothing shall deter them in the holding of the contest. The management claims positive assurances of enough cars to make the event a success.

Benjamin Briscoe, president of the Association, presided at the M. C. A. meeting, while Howard E. Coffin, chairman of the Rules Committee, was in charge of that section of the organization. A constitution and by-laws were adopted, and the following directors elected: Benjamin Briscoe, Maxwell-Briscoe Motor Co.; William E. Metzger, Everitt-Metzger-Flanders Co.; H. O. Smith, Premier Motor Mfg. Co.; H. E. Coffin, Chalmers-Detroit Motor Co.; Windsor T. White, White Company.

The rules for the Cobe Cup Contest in Chicago and other contests came in for consideration, and the Rules Committee had a prolonged session, which lasted until after midnight. An announcement is expected through the A. A. A. Contest Board.

Those in attendance at the meeting were:

Edgar Apperson, Apperson; A. P. Brush, Buick; H. E. Coffin, Chalmers-Detroit; E. H. Tangeman, Lancia; C. M. Hamilton, Isotta; H. G. Farr, Knox; A. L. Riker, Locomobile; H. A. Lozier and C. H. Emise, Lozier; Benjamin Briscoe, Maxwell; R. H. Croninger, Pennsylvania; G. A. Weldely, Premier; Paul Lacroix, Renault; F. B. Stearns, Stearns; F. A. Barker, Stoddard-Dayton; Walter C. White, White; E. P. Chalfant, A.L.A.M.; Alfred Reeves, A.M.C.M.A.

There were also represented by proxy: Mitchell Motor Car Company, National Motor Vehicle Company, and the Pierce-Arrow Motor Car Company.

Telegrams and letters were received from the following makers, voting against supporting the proposed New York to Seattle contest:

Mora Motor Car Company, Palmer & Singer Mfg. Company, Peerless Motor Car Company, Winton Motor Carriage Company, Hudson Motor Car Company, Bartholomew Company, Nordyke & Marmon Company, Dorris Motor Car Company, Walter Automobile Company, York Motor Car Company, Gearless Motor Car Company, Brush Runabout Company, Moon Motor Car Company, Reo Motor Car Company and Packard Motor Car Company.

SEATTLE PATHFINDER REACHES CHICAGO.

CHICAGO, March 30.—Striking good roads for almost the first time since leaving Albany, N. Y., the around-the-world Thomas car, which is laying out the route of the transcontinental contest to the Seattle Exposition, reached the Windy City this evening, having run from Ligonier, Ind., 114 miles, to-day. In the run from Cleveland, checking stations were established at the Hotel Secor in Toledo, and The Oliver in South Bend. Great enthusiasm was shown all along the route, crowds and cars meeting the tourists everywhere. They intend to push out toward St. Louis to-morrow.

DISCUSSING THE USE OF CHAINS.

ALBANY, N. Y., April 1.—A hearing is taking place to-day at the City Hall, under the auspices of the State Highway Commission, primarily for the purpose of discussing the question as to whether the use of chains on tires of automobiles should be regulated or prohibited, and with reference also to other anti-skid devices. Automobilists are well represented.

LACROIX'S RENAULT GIVEN CLEAN SCORE.

NEW YORK, March 29.—A fifteenth perfect score car has been added to the finishers of the mid-winter run from this city to Boston, March 11, for the Contest Board of the A. A. A. at a meeting this evening, gave Paul LaCroix, who drove his Renault, a clean score. The decision of Referee L. M. Bradley was upheld, in penalizing Mr. LaCroix 16 points for lateness at Hartford, inasmuch as the rules provided for that contingency. But it was shown that the Renault was held up by police on a charge of which he was cleared, and inasmuch as he was not at fault, the board voted to restore the lost points. Mr. Bradley, as referee, did not have the authority to do this.

DECIDES MOTORCYCLES ARE VEHICLES.

LANSING, MICH., March 30.—The State supreme court to-day decided that motorcycles are vehicles, within the meaning of the law relative to automobiles and motor vehicles, and upheld a conviction of H. G. Smith, of Detroit, for violating that law with a motorcycle. Smith had appealed his case.



Vol. XX. Thursday, April 1, 1909 No. 13

THE CLASS JOURNAL COMPANY

H. M. SWETLAND, President

231-241 West 39th Street, New York City

EDITORIAL DEPARTMENT

A. G. BATCHELDER, Managing Editor R. F. KELSEY, Associate Editor

THOS. J. FAY MORRIS A. HALL W. McKEAN WHITE J. BRADLEY, Foreign Representative

BUSINESS DEPARTMENT

A. B. SWETLAND, Business Manager

LOUIS R. SMITH FRANK B. BARNETT

W. I. RALPH, 1035 Old South Building, Boston, Mass. C. H. GURNETT, 1200 Michigan Ave., Chicago, Ill. F. W. VAN SICKLEN, H. H. GILL, Detroit, Mich. T. B. VAN ALSTYNE, Philadelphia, Pa.

Cable Address - Autoland, New York Long Distance Telephone - 2046 Bryant, New York

SUBSCRIPTION RATES:

United States and Mexico One Year, \$3.00 Other Countries in Postal Union, including Canada One Year, 5.00 To Subscribers—Do not send money by ordinary mail. Remit by Draft, Post-Office or Express Money Order, or Register your letter.

FOREIGN SUBSCRIPTION AGENTS:

ENGLAND:—W. H. Smith & Sons, Ltd., 185 Strand, London, W. C., and all book-stalls and agencies in Great Britain; also in Paris at 248 Rue de Rivoli. FRANCE:—L. Baudry de Saunier, offices of "Omnia," 20 Rue Duret, Avenue de la Grande Armee, Paris. GERMANY:—A. Seydel, Mohrenstrasse 9, Berlin.

Entered at New York, N. Y., as second-class matter. The Automobile is a consolidation of The Automobile (monthly) and the Motor Review (weekly), May, 1902, Dealer and Repairman (monthly), October, 1903, and the Automobile Magazine (monthly), July, 1907.

THE LICENSING OF ALL OPERATORS.

Anyone, owner or hired chauffeur, entrusted with the driving of a motor-driven vehicle should be required to take out an operator's license, such license to be revocable for criminal or grossly inconsiderate use of the highways, is the opinion that comes from the annual meeting of the New York State Automobile Association, a body containing some 4,600 members distributed among forty-five clubs located in various parts of the State. This expression is qualified by the demand for concurrent action in substituting "reasonable and proper speed" for the present unsatisfactory miles-per-hour limitations. In the same resolution, and interrelated, is the proposition to accept an annual registration fee if the money is expended upon improved roads and motor vehicles are not taxed as personal property.

Upon the question of licensing all operators there is now a striking unanimity that has gained ground rapidly in the past twelvemonth, owing probably to the great increase in the number of automobiles on the roads. The inconsiderate must be punished and the incompetent must not be permitted to drive.

It is urged with much degree of logic that the drivers of all vehicles—motor or horse-drawn—should be licensed, especially in the large cities, where traffic is heavy and varied, and the same argument is put forth in connection with an annual registration fee. Decided by legal interpretation alone, it would appear that there

could be no doubt that the ruling of the courts would say in both instances that it was unfair discrimination against one class of road users to exact the fee from automobilists alone.

However, this might not prevent legislatures in which the farmer has a big voice from imposing retaliatory measures for having his horse-drawn vehicles placed upon the same basis as automobiles in the matter of registration and licensing of drivers. While both vehicles use and wear out the roads, the new vehicle has to meet with antagonistic progress, as has always been the case with any innovation. But the newcomer is demonstrating its superiority for all purposes, which means that its supremacy is nearing complete achievement at a pace astounding even to those who have believed in it from the outset.

There is timely need of suppressing the reckless driver, and it is a task for the automobile associations themselves to come forward and aid in clearing the highways of these few, who bring such great discredit upon the many and also prompt legislation which interferes with the intelligent use of the pleasurable necessity of the age. Only by taking them from their places at the steering wheel, occasionally with jail sentences, and in outrageous instances inflicting a permanent revocation of license, can the law-abiding autoist secure for himself the road rights of an American citizen.



STARTING DEVICES REVEAL PROGRESS.

A casual glance over the field of self-starting devices shows that progress has been made in the past year. This advance has been made in the face of much popular opposition. At first sight, it would seem that owners and drivers would be the best friends of these contrivances, but history proves that the reverse is true. In fact, it is no stretch of imagination to say that the people most interested have been the worst enemies.

This opposition takes two forms, passive indifference and active hostility, of which the former is by far the more dangerous. If the automobiling public wants starting devices, all that is necessary is to indicate that want in clear unmistakable language. The history of the automobile business shows that whatever has been demanded has been forthcoming.

An article in this issue calls attention to the mechanical features of a number of self-starters, but the list of makers who are now fitting them or will do so upon demand is not included therein. If this were so, readers would be astonished at their prominence and large numbers. On the other side of the ocean, Renault, Saurer, Mors, Hallford, Brasier, Safir, and others are all prominent; in our own country, Winton and other Western cars have equally good reputations, yet all these have put out self-starting arrangements. In placing their stamp of approval upon these, the makers have taken the chance that if the devices failed their own business would be seriously affected.

The gradual tendency of the times, the signs of the public awakening, may be seen by following the advertising of the firms mentioned, and noting therein what is featured. This featuring of a device whose necessity should be self-evident is the mark of the campaign of instruction now being carried on.

BELIEVES ALL OPERATORS SHOULD BE LICENSED

ROCHESTER, N. Y., March 29.—The New York State Automobile Association at its annual meeting to-day placed itself squarely upon record as being in favor of requiring the issuing of licenses to the operators of all motor-driven vehicles, with penalties for revocation, and the imposing of an annual registration fee, providing automobiles are not taxed as personal property and "miles-per-hour" is eliminated and "reasonable and proper speed" substituted.

While the majority opinion of those present was in favor of having the amount of the registration fee decided by the diameter of the vehicle's largest tire, there were expressions in favor of both horsepower and weight classifications. Concerning the wisdom of licensing all operators, however, there was unanimity that the time had come for such a requirement, concurrent, however, with the disappearance of the miles-per-hour conditions which make trapping and unfair arrests a most tempting proposition for many rural communities.

After a three years' occupancy of the presidency of the State Association, Oliver A. Quayle declined a re-election and was succeeded by Herbert A. Meldrum, of the Automobile Club of Buffalo and one of its former presidents. The other selections were: First vice-president, Frank G. Webb, Long Island Automobile Club; second vice-president, M. L. Ryder, Albany Automobile Club; third vice-president, S. C. Tallman, Automobile Club of Auburn; treasurer, H. W. Smith, Syracuse Automobile Club; secretary, Bert Van Tuyle, Automobile Club of Rochester.

C. D. Hanks, who has been secretary during Mr. Quayle's administration of affairs, also declined re-election.

Morning and afternoon sessions were necessary to dispose of the routine and special matters. The most important action is expressed in the resolution offered by President J. M. Satterfield, of the Automobile Club of Buffalo, which reads as follows:

PRESENT CONNECTICUT LAW "SAFE."

HARTFORD, CONN., March 29.—Opinions as to the status of the present automobile law in the State of Connecticut and the general situation in the State in reference to legal matters held the attention of the members of the Automobile Club of Hartford at their dinner on last Friday evening. Arthur L. Shipman, an automobilist and prominent lawyer, was the first to voice the sentiment that the present law is "safe," meaning that there is not a strong likelihood of its being changed, and his remarks were concurred in by Harrison B. Freeman, Jr., another autoist and member of the bar. Mr. Freeman, who was for some time the prosecuting attorney of the local police court, was especially desirous that the club members should obey the present statutes. The club will do all in its power to maintain the present law.

NEW YORK STATE PROTECTIVE ASSOCIATION.

ALBANY, N. Y., March 30.—The National Highways Protective Association was incorporated in this city to-day, its purpose being to prevent the improper use of public highways by vehicle owners, to secure better roads, and more uniform laws for their use. The incorporators were: Lawson Purdy, Gilford Hurry, G. W. Burleigh, J. H. Coit, E. S. Cornell, M. J. Einstein, W. H. Llewellyn, A. D. Middleton, and J. F. Potter, all of New York.

CAPITAL CLUB GETS SHERMAN; AFTER TAFT.

WASHINGTON, D. C., March 29.—Vice-president James S. Sherman has just been elected a member of the Automobile Club of Washington, which is an A. A. A. club. The members of the club, in view of President Taft's readiness to use motor vehicles, expect within a short time to receive his consent to be enrolled as a member of the club.

RESOLVED, That the New York State Automobile Association places itself on record as being in favor of the issuing of licenses to the drivers of all motor vehicles, with the instituting of penalties for suspension or revocation of such licenses, and, furthermore, agrees to an annual registration fee for motor vehicles, based upon the diameter of the largest tire used on the vehicle, the fee not to exceed \$10, provided that such money be expended in the maintenance of improved highways and such motor vehicles are not taxed as personal property and the miles-per-hour restriction is eliminated and reasonable and proper speed substituted.

Ex-President Quayle will continue as chairman of the State legislative committee, his Albany residence making him a particularly valuable man in the position.

In the evening the visiting directors were guests at the annual banquet of the Automobile Club of Rochester, to the presidency of which H. G. Strong was re-elected at the annual meeting in the afternoon. The banquet was held at the Genesee Valley Club, and was attended by fully one-half of the nearly 600 members of the automobile club. President Strong, after telling of the progress of the club in the past and prophesying as to its future, turned the toastmaster's roll over to "Starter" John H. Siedman, retaining for himself the rôle of "Pacemaker."

There were songs in plenty, and the invitation that everybody should sing was vociferously followed. Well-known local politicians brazenly gloried in their presence, and one of them, Police Justice Chadsey, was elected to honorary membership.

Those who talked included President-elect Meldrum, and ex-President Quayle, of the State Association; George H. Diehl, chairman of the A. A. A. Good Roads Board; President J. M. Satterfield, of the Automobile Club of Buffalo; A. G. Batchelder, editor of THE AUTOMOBILE; F. H. Elliott, secretary of the A. A. A.; and D. H. Lewis, secretary of the Automobile Club of Buffalo. Of course Judge Chadsey had something to say.

The State association has 45 clubs and about 4,500 members.

IN HONOR OF PRESIDENT L. R. SPEARE.

BOSTON, March 29.—In honor of the election of Lewis R. Speare to the presidency of the A. A. A., the Bay State Automobile Association will give a banquet to him, April 6, at the Hotel Carlton. Prominent automobilists from different parts of the country have been invited to attend.

At a meeting of the directors of the Bay State Automobile Association, held March 25, Mr. Speare asked that he be relieved of the presidency, in view of his increased A. A. A. duties. This was accepted with regret, and Frederic Tudor was elected.

Mr. Tudor is an enthusiastic automobilist, owning several cars, and was one of the pioneers in the sport in this part of the country. He holds the first operator's license ever issued by the Massachusetts Highway Commission, and since 1903, when the first automobile law was passed, has cars have had the distinction of bearing registration No. 1. He was formerly secretary of the Massachusetts Automobile Club, is president of the Automobile Owners' Association, and is an officer of one of the local taximeter cab companies.

NEW LAW IN JERSEY PASSES HOUSE.

TRENTON, N. J., March 30.—Automobilists felt justly happy to-day when the Bradley Senate bill passed the House, although rural assemblymen vainly sought to amend it. This bill allows automobiles a speed of 25 miles per hour, provides that violations of the law must continue for one hour to warrant arrest, and cuts the fees of justices of the peace in two. Now that this measure has been safely started, it is felt certain that the Frelinghuysen measure, which permits the State to recognize the licenses of other States, will go through the Legislature. The Colgate bill has been withdrawn.

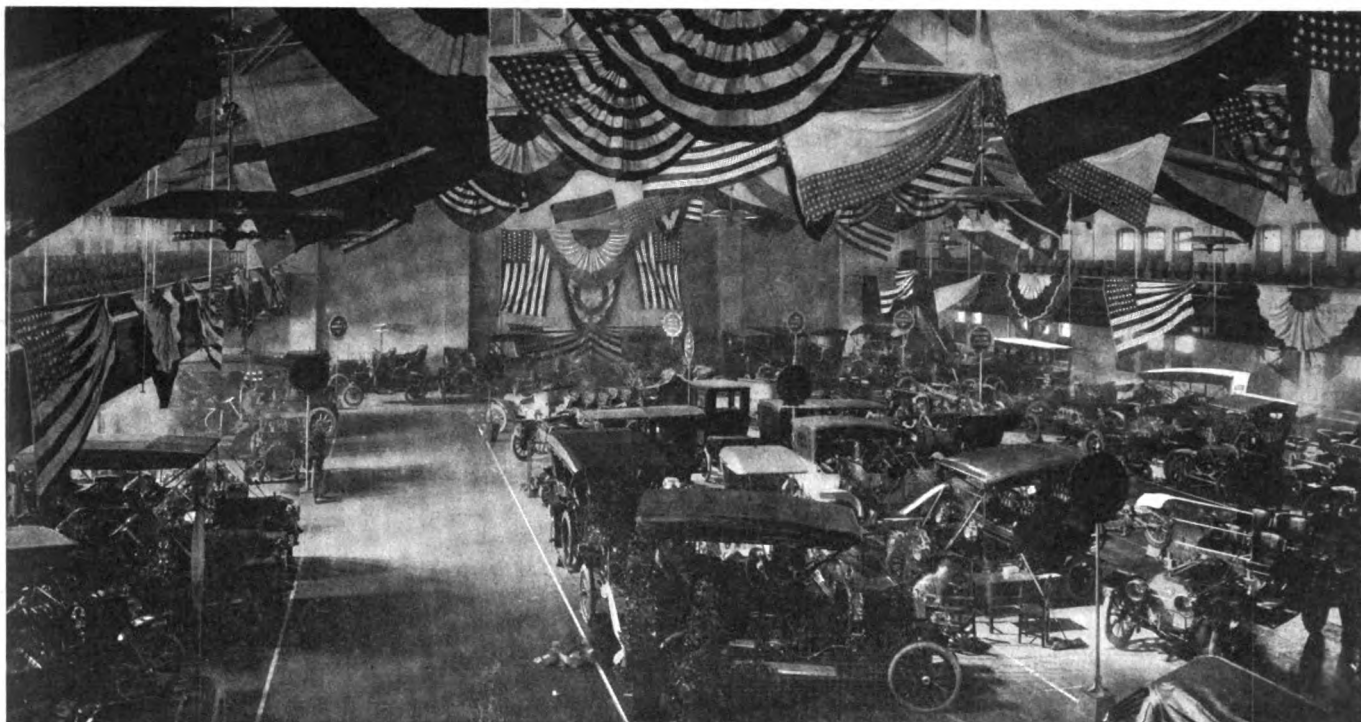

SYRACUSE SHOW SUPERLATIVELY SUCCESSFUL

SYRACUSE, N. Y., March 27.—Starting under most unfavorable weather conditions, snow, rain and sleet, but which did not seem to have an appreciable effect upon the attendance, the first automobile show ever held in this city was opened last Wednesday evening by Mayor Alan C. Fobes. For three full days thereafter the State Armory was crowded, and a strong note was sounded for a still greater exhibit next season.

At the opening every exhibit, both in the main hall and in the basement, where the accessories were shown, was in its place. The exhibits contained many novelties. One was a little Brush runabout, with "Cleo," the wax man, at the wheel, who defied the crowd to tell at first glance whether he were alive or not. Immediately after the opening ceremonies Mayor Fobes inspected the building, accompanied by Manager Lewis, President of the Trade Association C. Arthur Benjamin, Chairman M. W. Kerr, of the show committee; Vice-President H. D. Van Brunt and H. H. Franklin.

Thursday and Friday it became evident that all Northern and Central New York was interested in the Armory exhibition. Every train brought visitors from Watertown, Utica, Rome,

Oswego, Auburn, Binghamton, Elmira, Rochester, Buffalo, Albany, Ithaca and scores of nearby villages and towns. With a total of 4,000 attending the automobile show on Saturday, the closing day of the exhibition, the show came to an end. Already plans are formulated for a bigger and better one next year. The show "caught on" with the public, and its success surprised and delighted the men responsible for it. The total attendance for the four days was upward of 12,000.

According to figures given by the dealers there have been eighty cars disposed of, the prices averaging \$2,000 each, making a total of \$160,000 spent for the machines. Over \$5,000 worth of accessories and supplies have been purchased from the basement, where the purveyors have been writing orders for tires, engines, speedometers, lamps, oil, etc. Every dealer had his sales department reinforced by all the sub-agents throughout Central New York. Sales have included everything from the \$500 runabout to the \$5,000 limousine. There was an especially big business done in motor trucks. Those who exhibited were:

AUTOMOBILES.

Amos-Pierce Automobile Company: Chalmers-Detroit, Stevens-Duryea, Lozler.

Oldsmobile Automobile Company: Oldsmobile.

Bulck Motor Company: Bulck.

Syracuse Autocab Company: Thomas Selden.

H. H. Franklin Mfg. Company: Franklin.

Leon Conde, Inc.: Brush.

C. Arthur Benjamin: Packard, Elmore, E-M-F.

Maxwell-Briscoe-Syracuse Company: Maxwell.

Mora Sales Company: Mora, Regal.

Genesee Motor Car Company: Peerless, Cadillac, Pope-Hartford.

F. L. Wightman: Winton.

Syracuse Motor Car Company: Ford, Overland, Pullman.

W. E. Hookway: White.

Chase Motor Truck Company: Chase.

C. E. Wethey: Reo.

ACCESSORIES.

Atlas Sales Company.

Syracuse Supply Company.

E. B. Van Wagner Mfg. Co.

C. A. Benjamin.

Bulck Motor Company.

J. A. Seltz.

W. F. Polson.

Central City Oil Company.

C. E. Mills Oil Company.

F. L. Reed.

Amos-Pierce Company.

O. M. Edwards Company.

Clinton Vulcanizing Company.

Syracuse & Elbridge Glove Co.

Maryland Casualty Company.

Wonder Mfg. Company.

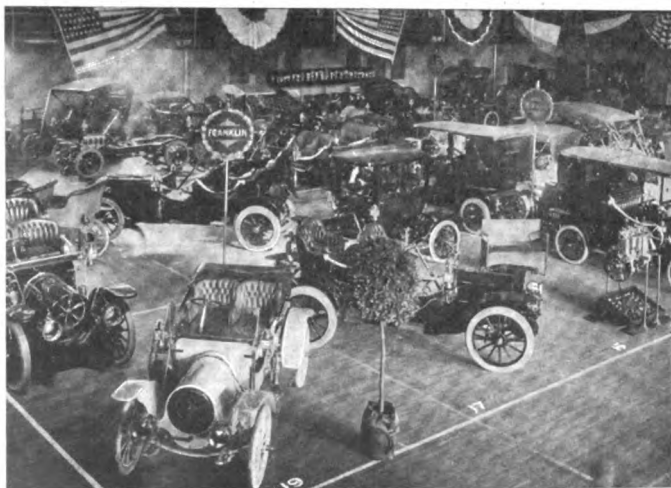

Exhibit of Air-Cooled Franklins at Syracuse Show.

PITTSBURG'S THIRD SHOW A RECORD BREAKER

PITTSBURG, PA., March 29.—Smoky City automobilists, and thousands of people who are not automobile owners, are being treated this week to one of the most successful automobile shows of the season, proven to be such not only by the enthusiasm shown when the doors of Duquesne Garden opened on last Saturday evening and by that seen to-day, but by the exhibitors and exhibited themselves. This is the third annual show, held under the auspices of the Pittsburg Automobile Dealers' Association, better staged than ever, with more extensive and harmonious decorations, increased number of exhibitors, more evenly divided spaces, and consequently a far more pleased attendance.

Indeed, not one of the 8,500 persons who crowded into the big hall on the initial evening expressed anything but delight at the scene, and those automobilists who have gone from city to city in their annual tour around the show circuit have voiced the same sentiments with regard to this one. The brilliant lighting, and the white, green and gold colors in the decorative scheme please everyone, and the 100 or more exhibitors, the ones who are so often hard to satisfy, are enthusiastic in their praise of the setting and general management. Chairman W. N. Murray and his associates, Robert P. McCurdy, C. F. McLaughlin and G. P. Moore were the recipients of many congratulations, and they seemed thoroughly well pleased and repaid for the long period of preparatory work.

It is felt that this show will be the winner for several reasons: far more interest has been shown during its preparation, more exhibitors than on previous occasions have taken space, more space was sold than at any other Pittsburg show, more high-class cars and complete lines of accessories are represented, the arrangement of the hall has been improved, and, perhaps more than these, the show committee has worked harder, been better organized, and has accomplished more than has any other body which has had these festivities in charge. Moreover, there was

an unbroken line of exhibits seen when the visitors were admitted, and there are no late comers to disturb the present splendid arrangement. On either side of the long promenade space on the main floor of the Garden are ranged the automobiles. Above and around the tiers of boxes are the accessory exhibits. The stage and the foreground are well filled with exhibits of cars, and up to the very hour of opening applications were made by agencies who desired space for their cars.

The walls of the big Garden are beautifully decorated with great mural paintings of natural scenery, with the automobile always in the foreground. Immense folds of silkline, set electric figures, bas-relief work, splendid silver trophies won at other shows or other races, and a profusion of costly potted plants and palms make the Garden a very wilderness of beauty. A band is on hand to furnish music, but the crowds have shown a great partiality for the big 36-note Gabriel horn, which was such a welcome addition to the New York, Kansas City, Cleveland and other shows, and the big horn would have been kept busy if it had responded to all the encores. Every effort has been made to have the show a source of genuine profit to the exhibitors.

The display of cars is magnificent, there being all sizes, styles, colors and prices, so that everyone has a chance, and the polished chassis have been the centers of interest here, as they have been elsewhere, dividing the crowds between those who are mechanically inclined and those who look only at the finishes. It is hard to imagine the business depression of the recent financial stringency in this city, and, although it has taken two shows to warm up the buying public of one of the busiest cities in this country, it is apparent that the awakening has been a strong and pleasant one. All over the show there are reports of growing trade, and it is expected that a number of retail sales will be made, in addition to the placing of a few sub-agencies. The suburbs of the city offer excellent roads, and autos are increasing.

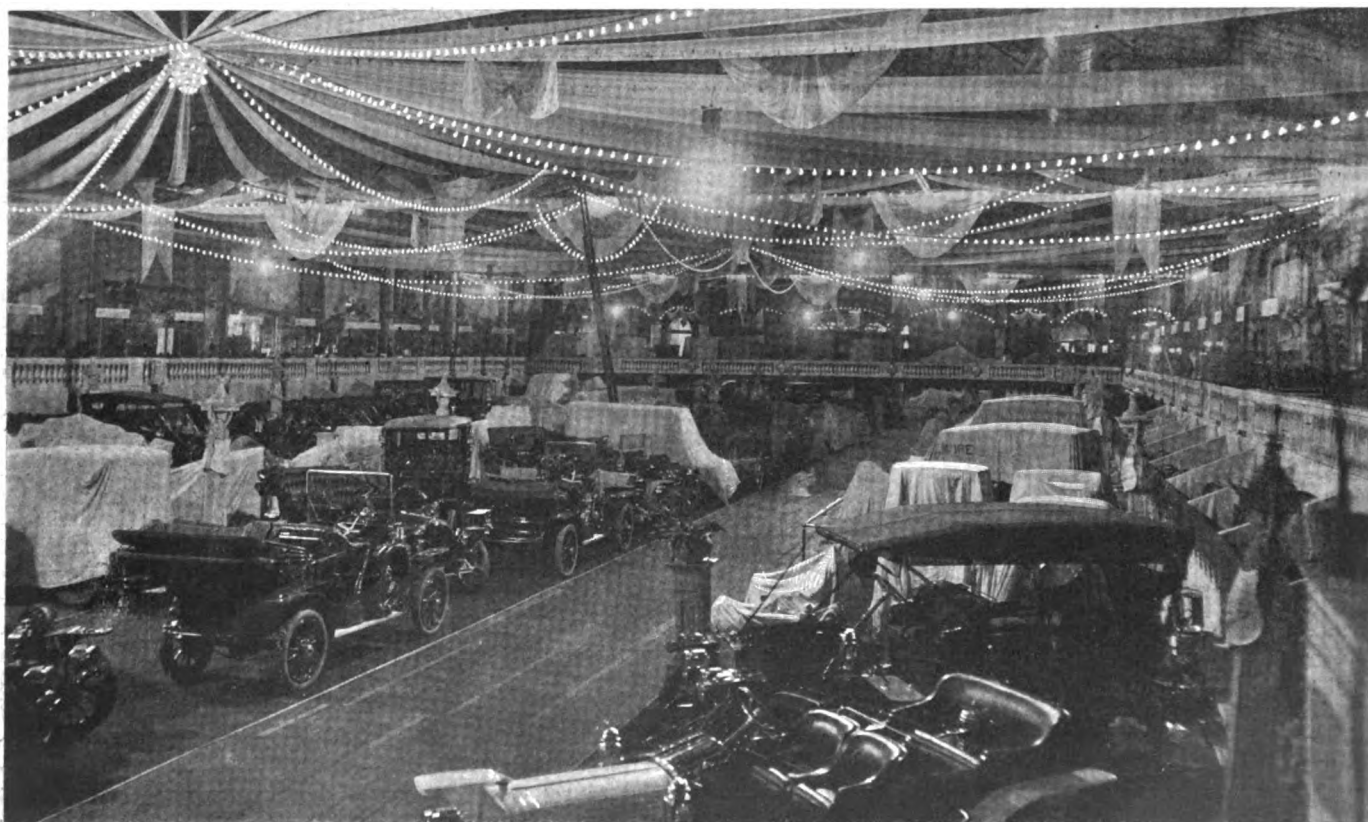

Duquesne Garden, Scene of Pittsburg's Third Annual Show, Contains a Representative Collection of the Industry's Best Productions.

Another respect in which the show is noteworthy is in the matter of accessory exhibits, for, although unsanctioned, every available corner where a display of accessories could be planted is taken, and around all of the booths are seen interested crowds, discussing with the dealers, for Pittsburgers have found that economy in up-keep is due in a great measure to the kind and grade of accessories purchased. Special displays of oils, tires, bodies and windshields are on hand.

A number of automobile celebrities have arrived to attend the week of celebration, among them being: E. L. Thomas, E. R. Thomas Motor Company; Walter C. White and R. H. Johnston, White Company; Harry Fosdick, Hol-Tan Company, Lancia importers; C. J. Jamison, Dayton Motor Car Company; W. C. Churchill, Winton Motor Carriage Company; Frank Pierce, Gaeth Automobile Company. Mayor Reyburn, of Philadelphia, sent his greetings across the mountains to Mayor Guthrie, of Pittsburg, in a Maxwell, Jr., car, which is known for its 2,000 and more miles non-stop tendencies, and arrived at Duquesne Garden Saturday morning. Agents, salesmen and prospective buyers of Western Pennsylvania, Eastern Ohio and West Virginia are arriving in good numbers to take in the show, and by midweek it is expected that the nightly attendance will be much larger.

Pittsburg has some products of its own in the Belden, Pittsburg-Six and automobile bodies. The Belden Motor Car Company has so far manufactured its car only upon a small scale, but it is now preparing to erect a plant which will have an immense output. The Fort Pitt Motor Manufacturing Company shows its "Pittsburg-Six," manufactured at New Kensington, a short distance up the Allegheny River. The concerns exhibiting bodies are the L. Glesenkamp & Sons Company and the E. J. Thompson Company. Accessory makers of this city included are: The Union Automobile Tire Repair Company, Manchester Automobile and Machine Company and O. J. Brackney.

The complete list of exhibitors of both automobiles and accessories is given herewith:

AUTOMOBILES.

Arlington Motor Car Co.: Pittsburg, Jackson.
Anderson Automobile Company: Wilkinsburg, Atlas.
Banker Bros. Co.: Stevens-Duryea, Chalmers-Detroit, Pierce-Arrow.
Bellefjel Motor Car Co., DeLuxe, Woods Electric, Couple Gear, Oakland.
Belden Motor Car Co.: Belden.
Buick Motor Car Co.: Buick.
Benson, B. F.: Studebaker.
Collins, D. P.: Lozler.
Eastern Automobile Co.: Atlas.
East End Automobile Co.: Waverley Electric, Pope Hartford.

Fort Pitt Automobile Co.: Locomobile.
Fort Pitt Motor Manufacturing Co.: Pittsburg-Six.
Hamilton Automobile Co.: Kissel Kar, Middleby.
Hiland Automobile Co.: Peerless, E-M-F.
Imperial Motor Car Co.: Cadillac.
Speedwell Automobile Co.: Speedwell Schacht.
Keystone Automobile Co.: Welch, Stoddard-Dayton, Velle, Columbus, Electric.
Maxwell-Briscoe Co.: Maxwell.
Mutual Motor Car Co.: Stearns, R. & L. Electrics.
Overland Motor Co.: Overland.
Olds Motor Works, Pittsburg Branch: Oldsmobile.
Premier Sales Co., Ltd.: Premier Reo.
Pittsburg Automobile Co.: Thomas.
Regal Agency, Wagner & Feicht: Regal.
Standard Automobile Co.: Packard-Franklin.
Winton Motor Car Co.: Winton.
Wilkinsburg Automobile Garage: Elmore, Baker Electric.
The White Co.: The White Steamer.
Milhuish & Hemphill: Palmer-Singer and Simplex.
F. W. Fisher: Mora, Jewell, Marmon.
Co-Operative Automobile Co.: Mollne.
Acme Motor Car Co.: Acme.
Pittsburg-Mitchell: Mitchell.
Matheson Agency: Matheson.
E. J. Thompson Co.: Automobile Bodies.

ACCESSORIES.

Air Tight Steel Tank Company.
Atlantic Refining Company.
Atlas Rubber Company.
Auto Specialty Co.
Banker Wind Shield Company.
Doubleday-Hill Electric Company.
Dressing, Chas. H.
Eyler & Henry.
Clark, W. L., Company.
Ennis Rubber Company.
East End Cycle Company.
Eagle Lubricating Oil Company.
E. Fleintjes.
Gibney, Jas. L. & Bro.
Independent Tire Repair Works.
Morton, Frank U.
McGraw-Burgess Vertical Fabric.
Kent, A. E.
Pittsburg Post.
Pittsburg Auto Equipment Company.
Pittsburg Rubber Company.
Perfection Wrench Company.
Royal Equipment Company.
Pittsburg Rubber Company.
Reinforced Brazing & Machine Company.
Rider Hotel.
Salman, John A.
Saunders & Bremer.
Standard Automobile Company.
Westinghouse Company.
Woodwell, Jos. Company.

RUSSIAN GOVERNMENT BUYS THE CLEMENT AIRSHIP

PARIS, March 25.—Adolphe Clement's aerial yacht, *Bayard-Clement*, has just been sold to the Russian government to be used for army purposes, and is now undergoing trials previous to delivery. The airship, which was only launched a few months ago, and was announced to have been built for Mr. Clement's own personal use, is of the improved Partie type, and was produced by the Astra Company. The Bayard-Clement factory attended to the fitting of the engines, the power plant being a 120-horsepower, four-cylinder racing motor used on one of the 1906 Grand Prix cars. It drives a two-bladed propeller placed forward, and commanded through a reducing gear. Since then a six-cylinder engine of about the same power has been built, but had not been placed in position when the sale was effected. Up to the present the balloon has been used for pleasure trips, Mr. Clement on several occasions traveling from his country residence to his Paris factory by means of his aerial yacht. It has also been a very effective means of publicity, for on several occasions, notably during the holding of the annual Salon, it was flown over the city of Paris at noon, sufficiently low for the

flaming characters on its side and rudder to be visible to all the frequenters of the boulevards.

A second French airship for the Russian government is under construction at the Lebaudy establishment at Moisson, near Paris, and is expected to be ready for delivery about the month of May. Orders have been placed with Melvin Vaniman, the American engineer, responsible for the construction of the mechanical portion of the Wellman polar airship, for two portable sheds to house war balloons. These sheds, which are of a special design, can be erected in four hours and taken down in half that time. They are specially designed to be mounted on automobiles in order to travel over country to a new headquarters that may be designated by the pilot of the airship.

Walter Rutt, Germany's well-known cycle racer, has turned aeronaut; a patron has ordered a Wright aeroplane for him, and he will take a course of lessons from the one and only Wilbur. A Wright aeroplane has been bought by the Strassburg firm of E. E. Mathis, and will be exhibited at the Frankfort show.

LANCASTER CLUB ELECTS OFFICERS.

LANCASTER, PA., March 29.—With the record of a successful year behind them, and the prospects bright for the success of the coming year, the members of the Lancaster, Pa., Automobile Club held their annual meeting at Lancaster on a recent evening and elected officers for the coming year. A banquet preceded the meeting. One of the features of the evening was an address by Hon. Frank B. McClain, ex-Speaker of the Pennsylvania Legislature, in which he is still a member. He showed the futility of hoping for the passage by the present Legislature of the bill providing for the State highway from Philadelphia to Pittsburg, on account of the depleted condition of the State treasury, and urged the club to support the efforts being made to raise \$50,000,000 by a bond issue for the construction of State highways. New York will soon have the best roads in the United States, he said, and this is the manner in which they are being secured.

There was a spirited contest for the offices, indicating keen interest in the club. The officers elected were: President, H. C. Schock, Mount Joy; vice-president, Dr. J. F. Trexler, Lancaster; secretary, J. D. Rider, Lancaster; treasurer, Dr. W. H. Trout, Lancaster. Directors: Fred F. Groff, Lancaster; Geo. W. Kinzer, New Holland; Dr. Donald McCaskey, Witmer. The report of the secretary showed that during the year the membership increased from 107 to 153, exclusive of the ten elected at the meeting.

Dr. F. Magee, Esq., a member of the State committee on good roads, made an address in which he strongly urged the use of the King drag on dirt roads. Its adoption has met with successful results, and the Lancaster Club decided to conduct several public demonstrations to interest the farmer and show him how cheaply good roads could be had. Assurance was received from several turnpike companies that the roads of which the club complained would be repaired upon the advent of seasonable weather.

PETREL TO BE MADE IN MILWAUKEE.

MILWAUKEE, Wis., March 29.—An announcement of more than ordinary interest was made in Milwaukee early this week, when negotiations were closed by the Petrel Motor Car Company, of Kenosha, Wis., for a long-term lease of the Pfister & Vogel Leather Company's Virginia Street Foundry in Milwaukee, and that on May 1 the Kenosha works will be moved to Milwaukee. The company has been occupying the former Visible Typewriter Company plant at Kenosha, Wis., now owned by the Badger Brass Manufacturing Company. The Petrel friction drive car has been successful from the start. The demand is fully equal to the supply, and is expected to greatly exceed it before long.

HORSE FIRM TAKES AUTO AGENCY.

Realizing the great field for the sale of automobiles by a house which has an established reputation, although in a directly opposite line, the Fiss, Doerr & Carroll Horse Company, of New York City, has secured the sole Eastern distribution for Columbus electrics, and a complete line has been placed on exhibition in the salesrooms of the concern on East Twenty-fourth street. It is not stated how this will affect the interest of the company in horses, but it is probable that the equine will not be altogether superseded, at least not for the present.

LOGAN TRUCK PLANT GETS NEW LEASE OF LIFE.

COLUMBUS, O., March 29.—John H. Blacker and Mortimer Renick last week purchased the plant of the Logan Construction Company at Chillicothe, O., at auction. The purchasers announced that they would continue the manufacture of automobiles in the plant. Commercial machines only will be made.

Port Jervis, N. Y.—Alfred Munnich has begun work upon an extension of 100 feet to his garage on Pike street. It is planned to use the present garage as a store and salesroom.

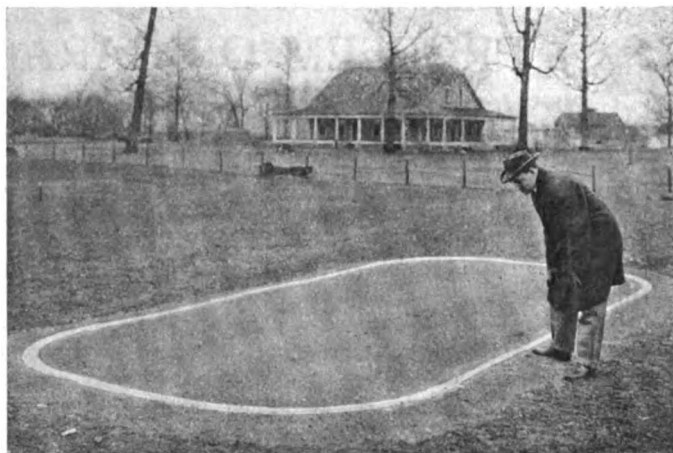

Strang Inspects Indianapolis Speedway Model.

To show the plan of the Indianapolis Motor Speedway, a concrete model has been laid out. There will be a course within a course, so that either a two-and-a-half-mile track or a five-mile track can be used, with space for a balloon starting ground inside.

CATSKILL-BERKSHIRE TOUR OF NEW YORKERS.

Instead of a two-day tour next June, up to Catskill, N. Y., and return, the members of the New York Automobile Trade Association, and their friends, who so enjoyed the novel run to Montauk Point last Fall, will this Summer be given a treat in a tour through the Catskill Mountains and Berkshire Hills.

The route is a beautiful one, and early in the morning of June 12 the machines will assemble and run to Tarrytown, where a special ferry will carry them across the river to Nyack, and then the route will lead them to Arden, in the Highlands of the Ramapo. This is said to equal in scenery the Scottish Trossacks, and a picnic luncheon will be provided. Through Tuxedo the cars will journey, if permission to enter this sacred precinct can be secured, to Kingston, where the night stop will be made. On the following day, June 13, the course will lead through the Catskills to Albany, thence through the Berkshire country to Great Barrington, an all-night stop.

The third part of the run will lead the cars by easy stages through Lakeville and Dover Plains to Paulding for lunch, and in the afternoon through Paterson and White Plains to New York City. The committee in charge is composed of C. P. Skinner, chairman; Harry Fosdick, Richard Newton, Peter Fogarty and Walter R. Lee, manager.



Studebaker Finishing Denver-Chicago Run.

Sent from Denver by the Denver "Post," in the interests of automobilists to have that city upon the Glidden tour route, this car was driven by George Smithson through blizzards, snowdrifts, and long stretches of deep mud, in its hard trip. He was accompanied by W. H. Fairbanks, Jr., who bore the official messages.

PROBLEM OF GARAGE GASOLINE DRAINAGE

THE rapid increase in the use of automobiles using gasoline as fuel requires a solution of a problem which is comparatively new, says *Domestic Engineering*. A careless chauffeur upon running his machine into the garage may fail to shut off the gasoline. This drips on the floor, collects in the drain and may find its way to the sewer. It is a danger to be apprehended, either in the garage, in the floor drain trap or in the sewer, as its exceptionally volatile character permits it to vaporize rapidly at a low temperature, and this vapor coming in contact with a burning match, gas light or an electrical spark may cause an explosion dangerous in character and destructive in effect.

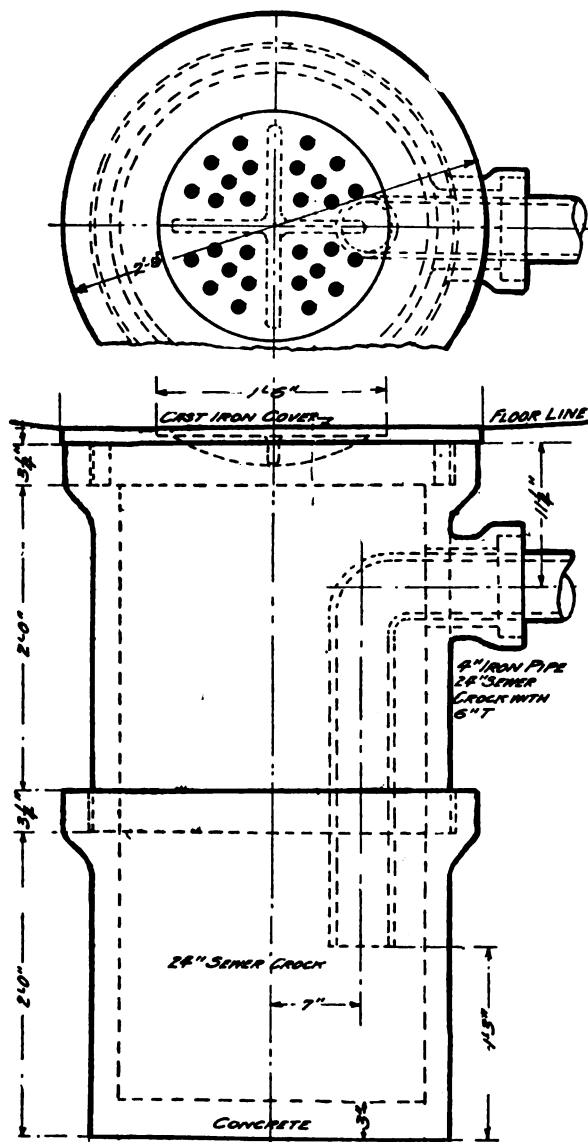

Sketch of Home Made Safety Drain Pipe.

From the sewer, gasoline may find entrance into house drainage systems, and thus cause damage.

What is the best way to prevent the entrance of gasoline into the sewer and the proper way to care for it in the drainage of the garage? A few samples of what is required in different cities will prove interesting:

W. G. Williamson, inspector of plumbing, Detroit, Mich., recommends the accompanying method of constructing a catch basin in an automobile garage, believing that it will safely care for any accumulation of gasoline and prevent its getting into the sewer. In explaining his plant, Mr. Williamson states that the

method he suggests will prove more satisfactory, or at least fully as satisfactory, as more expensive methods of construction. As will be seen by reference to the drawing, the method calls for the use of one section of 24-inch sewer crock set on its spigot end in a bed of three inches of concrete to make a perfectly water-tight base. In the hub end of this two-foot length of sewer crock he places a 24-inch sewer crock with a 6-inch tee, the joint being made of concrete. A 4-inch iron pipe elbow is carried through the 6-inch tee opening of the upper section of the crock, the joint to be made with concrete, and the elbow turning down so that its lower end will come within one foot of the bottom of the catch basin, which ought to provide ample space for sand and settlings so that the basin would not require cleaning too frequently. The seal provided for this elbow is nearly two feet, which should be ample to prevent any gasoline ever getting into the sewer. Whatever gasoline finds its way into this catch basin will be vaporized and the vapor passes through the perforated cast iron cover of the catch basin into the garage, and thus makes the presence of the gasoline known and causes caution on the part of the attendants. The cover of the catch basin as shown consists of a cast iron cover ring with an annular ring which sets into the hub of the upper section of crock pipe and which can be set with concrete, and would probably be best so set, as the ring would remain rigid when wheels passed over it. The removable cast iron cover is perforated with 1-inch holes set in rings 4 inches apart, and this ring is made with ribs on the underside to strengthen it. The entire catch basin is set so that the floor will drain to the perforated cover.

Geo. R. Stolz, inspector of plumbing, Milwaukee, Wis., writes that there is no special way used in his city of taking care of gasoline which might drip from automobiles and find its way into the sewer. He permits the use of an ordinary catch basin with elbow turned down and with its mouth high enough in the catch basin to allow about 2 feet of depth for sand or dirt settlings. Gasoline being of a light specific gravity will gather on top of the contents of the catch basin and be dissipated into the garage through the perforated catch basin cover.

SMOKE ORDINANCE INOPERATIVE ON HILLS.

PHILADELPHIA, March 29.—“On the level” you must not smoke, unless you desire to pay \$5 and costs, but you may smoke going uphill without digging into your jeans—such is the dictum promulgated last week by the Park Commission, through Magistrate Harris, who had a score or more of offenders before him at the Ledgely guard house. The rules of the commission make it a finable offense to drive on the Park roads an automobile which “emits offensive quantities of smoke or disagreeable odors,” and the gray-coated guards have been busy for the past fortnight keeping tabs on the tag numbers borne by all “smokers.” Those who were able to convince the magistrate that they were going uphill at the time were discharged with a warning; the smokers “on the level” were fined the \$5 and costs which the statute provides.

It developed during the hearings that the majority of the offenders were demonstrators from the various establishments along “Gasoline Row,” who invariably take their “prospects” up and down Sweet Briar and Tam o’Shanter hills a few times to show off their cars’ abilities in the hill climbing line.

AUTOISTS WAR ON WATERBREAKS.

WASHINGTON, D. C., March 29.—The Automobile Club of Washington has started a vigorous campaign against waterbreaks, which abound in all the roads leading out of the capital city. A committee, consisting of Robert B. Caverly, A. Ward Evans and Fulton R. Gordon has been appointed to deal with this subject and are receiving enthusiastic support.



A Bevy of Pretty Girls in an Anderson Electric.

CHICAGO TRADESMEN ELECT TOM HAY.

CHICAGO, March 27.—The annual election of the Chicago Automobile Trade Association resulted in a victory for the member's party, which put into office all its candidates with the exception of one, the successful slate being made up as follows: President, Thomas J. Hay; vice-president, Joseph F. Gunther; secretary, F. E. Sparks; treasurer, Henry Paulman; directors, N. H. Van Sicklen, A. J. Banta and H. P. Branstetter.

DUCASSE GETS DARRACQ AMERICAN AGENCY.

With the whole United States as territory, Henry Ducasse & Company, located at 140 West Forty-second street, New York City, has secured the American agency for Darracq cars, controlling not only the importation and sale of touring cars and chassis, but also of taxicabs. By the terms of the agreement with A. Darracq & Company, of Suresnes, France, the new agents will make large importations, and sub-agents started in all of the large cities.

CHALMERS NAMES QUALITIES FOR SALESMEN.

DETROIT, March 29.—Hugh Chalmers, president of the Chalmers-Detroit Motor Company, recently addressed the Detroit Ad-craft Club at its noonday luncheon, on "The Relationship of Salesmanship to Advertising." Asserting that there are ten essential qualities in successful salesmanship—health, honesty, ability, initiative, tact, sincerity, industry, knowledge of the business, open-mindedness, and enthusiasm—he declared that nine out of ten of these qualities had to do with the man himself. "Salesmanship is nine-tenths man and one-tenth goods and territory," said Mr. Chalmers.

NEW JERSEY TRADESMEN RE-ELECT OFFICERS.

NEWARK, N. J., March 29.—At the annual meeting and banquet of the New Jersey Automobile Trade Association, last Thursday evening, the officers who have guided the association so well during the year just closed were re-elected. The gathering was the largest and most successful yet held, and was productive of much good toward strengthening the organization. The officers re-elected were: George Paddock, president; J. W. Mason, vice-president; W. H. Ellis, secretary; R. A. Greene, treasurer. F. L. C. Martin and L. B. Zusi were elected members of the executive committee for three years.

PROPOSED TOLEDO DEAL OFF; ANOTHER PLAN.

TOLEDO, O., March 27.—After the Apperson deal for the Pope Motor Car Company has progressed so far as to name this year's cars Apperson-Toledo, announcement has just been made by Henry L. Thompson, of this city, that the deal is off and that another was being considered. When Mr. Apperson took an option on the local plant, one of the conditions was that \$250,000 be put into the plant by Toledoans. The option taken at that time expired a week ago, but was extended till March 27, and now Mr. Thompson, who has been in charge of raising the \$250,000, says that the deal is off for the present and that another proposition whereby the plant may be retained in this city is being considered. Just why the deal fell through is not made public.

Receivers A. L. Pope and George A. Yule have been discharged as receivers for the local plant, although they are yet under a nominal bond of \$20,000.

COMMERCIAL VEHICLE FACTORY AT ANN ARBOR.

ANN ARBOR, MICH., March 29.—Under the name of the Triple Motor Truck Company, a new concern, capitalized at \$340,000, is about to close with local business men for the establishment here of a large plant to manufacture commercial motor vehicles. F. O. Paige of Detroit, Andrew Bachle and H. A. Wilcox of Owosso, formerly connected with the Reliance Motor Company of Flint, are named as the principals in the negotiations.

ANOTHER AUTO BUGGY FACTORY PLANNED.

TOLEDO, O., March 27.—The Auto-Bug Company, of Norwalk, O., has just been incorporated with a capital stock of \$100,000, and will manufacture high-wheeled auto buggies and other motor vehicles. Incorporators are: I. W. Goodell A. E. Skadden, C. F. Jackson, J. R. McKnight and W. G. Gilger. It is the intention of the concern to occupy an unoccupied factory building for the present, but an entirely new structure will be built within a year.



Renault in Front of the Coliseum at Rome.



A London Bus Feeling Its Way Through Flooded Streets.

Bursting water mains in the city of London recently made street traffic impossible for all but motor vehicles. The buses pushed their way through thoroughfares wheel-deep with water, that was filled with wooden paving blocks and other obstructions, and carried passengers to and from their homes in safety.

Cadillac Company Gives a Banquet.—To celebrate the arrival in this country of the famous Dewar trophy the Cadillac Motor Car Company a few evenings ago tendered a banquet to about eighty of its employees, composed mainly of heads of the mechanical departments, at the Hotel Ponchartrain, Detroit. The celebrated cup occupied the center of the table, the first time that it has been won by an American concern. It is one of the most coveted trophies in Europe, because it is awarded each year by the Royal Automobile Club to the manufacturer accomplishing the most noteworthy performance toward the advancement of the industry, and was given to the Cadillac because of its remarkable standardization test at Brooklands track last year. At that time three single-cylinder Cadillacs were selected at random, disassembled, their parts intermingled, 89 withdrawn and substituted for by extra parts from the stock supply, and when they were reassembled the machines were taken right out on the track and run 500 miles without any trouble. The dinner was given by the management of the concern to thank and commend the heads of the departments who made this possible. Among the guests was W. R. Warner, of Cleveland.

Meeting of Engineering Societies.—On Tuesday, April 13, will be held the presentation of the John Fritz medal for 1909 by the four national engineering societies, A.S.M.E., A.S.C.E., A.I.E.E. and A.I.M.E. The board of award, especially chosen for the purpose, has selected Charles T. Porter, honorary member A.S.M.E., as the recipient of the honor, for his work in advancing the knowledge of steam engineering and in improvements in steam engine construction. Besides the simple ritual of the presentation of the medal, there will be addresses by representatives of the four groups of the profession most concerned. Attendance is not restricted to the members, but the public is cordially invited.

Automobile Factories Wanted.—Watertown, N. Y., in a little booklet which has

been sent out to automobile manufacturers, is calling attention to its facilities as the situation for an automobile factory, with water power, railroad sidings, and established industries which are closely allied with the automobile. These are body building plants, spring makers, builders of gas and gasoline engines, copper and nickel plating plants, and many others. Loren R. Johnston is a moving spirit in seeking for new industries, and invites any one interested to communicate with him.

Hartford Rubber Works Officers Change Positions.—At a meeting of the board of directors of the Hartford Rubber Works Company, held in Hartford, J. P. Krogh, chief of the credit department, was elected treasurer to fill the vacancy caused by the resignation of Henry F. Plow, who has accepted a position with the Mitchell Motor Car Company. D. W. Pinney was elected assistant treasurer, and Franklin Kesser, sales manager, and former manager of the Philadelphia branch of the company, was elected assistant secretary. The office of secretary was left vacant.

Farmers Are Converts to the Automobile.—So great is the interest taken in the automobile in Michigan, particularly by the agriculturalists, that the State Agricultural College proposes to establish a course and give instructions in its general uses and adaptability. This will be a short winter course and the students will be taught the structure and operation of engines as well as dismantling and assembling of cars. When they have mastered this, they will be taught to drive. It is said that the State schools of Iowa and Kansas will follow suit and establish similar courses.

Rambler Spare Wheel Contests.—Keen rivalry has arisen among owners of and dealers in Rambler cars to lower records of the time needed to substitute the spare wheels for the regular ones. At present the record is held by one of the mechanics of the Cleveland agent, who changed one wheel in fifty-nine seconds, first jacking up the car and letting it

down after completing the operation. All four wheels were changed in four minutes and a half. W. K. Cowan, of Los Angeles, claims 1:45 as his record time, while a novice in that city made the change in 2:50.

Selden Car as Gift to a Prelate.—As a mark of high esteem and regard, on the occasion of the 25th anniversary of his ordination, Rt. Rev. Thomas F. Hickey, D.D., of Rochester, N. Y., was presented with a Selden touring car by his parishioners. His duties call him over a wide area of the country surrounding the city, and for this reason the practicability of such a gift was appreciated by those who gave it. At the presentation a copy of the New York State automobile law was also given to the prelate, much to the general amusement.

Statistics of Goodyear Detachable Rims.—The Goodyear Tire & Rubber Company, to show the growth of the popularity of quick detachable rims, has compiled statistics, taking as a basis the fourteen automobile shows held in the principal cities of this country since the opening of the Palace show, New York City, January 1. There have been on exhibition 1,885 automobiles, and of these 1,371, or 72.73 per cent., were equipped with quick detachable rims. The Goodyear quick detachable rim led in eleven out of the fourteen shows.

Making a Bigger Jewel.—The Jewel Motor Car Company, located at Massillon, O., has found the present factory space so much too small for the amount of work being done that an addition has become a necessity. As now planned, this will be 55 by 80 feet and two stories high with a saw tooth roof. This increase in the plant has not only been planned, but work has actually commenced on it. When this work is completed it is expected that 250 men will be employed.

Fisk Tires on Fire Apparatus.—Success in equipping automobile fire apparatus with Fisk tires in the past has influenced the Fisk Company to give especial attention to this branch of the trade, and recently the Fisk tires have been adopted as equipment by the Robinson Fire Apparatus Manufacturing Company, of St. Louis, and the La France Engine Company, of Elmira, N. Y. The pneumatic bolted-on type has been popular, as well as solid tires.

New York Carnival Prizes.—The plans for the automobile carnival week of the New York Automobile Trade Association are fast being put into shape, and it has been decided that the \$2,000 to be given as prizes for the cars in the parade shall be divided into \$500, \$250 and \$150 for decorated pleasure vehicles; \$500, \$200 and \$100 for the decorated floats or displays, and \$200 and \$100 for grotesquely decorated cars.

Holsman Factory Running at Night.—According to the Holsman Automobile Company, this year will be a record breaker in the amount of business done in high-wheeled automobiles, for already the pressure of demand has been felt. The Holsman factory in Chicago is now working at night as well as day and is still behind orders. The demand for the 1909 cars with direct drive from the motor to the wheels is very great.

New Factory for Rothschild & Company.—An old four-story building at the corner of Eleventh avenue and Fifty-seventh street, New York City, has been purchased by Rothschild & Company, and will be altered from a flax mill into a thoroughly renovated automobile fac-

tory. The building is a large one, 200 by 167.8 feet, with a frontage of 100 feet upon Fifty-sixth street.

New Navy Secretary Buys a Waverly.—The new administration at Washington is showing interest in the automobile industry. Following the conversion of the White House stables into a garage and the purchase of touring cars for the President, the new Secretary of the Navy, George Von L. Meyer, has purchased a Waverly Victoria phaeton for his personal use.

Arseno Electric Company Opens Boston Store.—The Arseno Electric Company, wholesale and retail dealers in electric and automobile equipment, has established a store at 819a Boylston street, where it will make its headquarters. C. B. Arseno, the manager, has had 25 years' experience in the electrical field and 18 in the bicycle and automobile work.

McCue Moves into New Factory.—The McCue Company, builders of the McCue Hartford car, are now moving into their new factory on Pliny street, Hartford, Conn. The building is two stories high, and will give facilities for a much increased output.

Minneapolis Car's Name Changed.—The H. E. Wilcox Motor Car Company of Minneapolis, which has been manufacturing the Wolfe touring cars and trucks for the last four years, has announced that hereafter the name of its product will be called the "Wilcox."

IN AND ABOUT THE AGENCIES.

Fisk Tires: Philadelphia.—Upon the completion of extensive alterations to the new building at 258 North Broad street, the Philadelphia branch of the Fisk Rubber Company, under the management of K. B. Harwood, will move from its present quarters at 1309 Race street.

Dow Tire Company Has Boston Branch.—The Dow Tire Company has opened a branch in Boston at 889 Boylston street, where it will handle all of the New England trade to dealers, as well as the retail trade.

Crawford, Philadelphia.—The Philadelphia agency for the Crawford has been taken over by the Crawford Automobile Company, of Philadelphia, with headquarters at Broad and Ridge avenue, under the management of Henry R. Hoopes.

Knapp-Greenwood Company Opens Salesroom.—The Knapp-Greenwood Company, manufacturer of shock absorbers, with a factory at Farmington, Me., has established a salesroom at 998 Boylston street, Boston.

KisselKar: Philadelphia.—Rogers & DuBois, owners of the Rittenhouse Motor Company, at 214-220 South Twenty-third street, have been awarded the Philadelphia agency for this car.

Lozier: Northern California.—S. G. Rayl, distributor, with headquarters at the Broadway garage, San Francisco.

Lozier: Milwaukee, Wis.—Williard V. B. Campbell, Farwell avenue and Brady street, State agent.

Locomobile: Hartford, Conn.—L. D. Fisk, Hartford Automobile Station, 43 Wells street.

Moon: Milwaukee, Wis.—Riverview Automobile Company, 325 E. North avenue.

Velie: Kansas City.—Evans Automobile Company, 1927-1929 Grand avenue.

TAXICABS AND TRANSIT.

Hartford, Conn.—The Capital City Auto Hack and Livery Company, local agent for the Mitchell, will start a line of taxicabs shortly. This will make three different lines in this city, the Maxwell, which is doing well, and the Elmore, inaugurated about a week ago with satisfactory results, and the Mitchell. The local public seems to be losing the idea that a taxicab costs a fortune. Considerable trade is picked up at the local hotels, and both the Elmore and the Maxwell make headquarters at a garage. When the Maxwell was first started it was put on the public vehicle stand, but was later withdrawn and put in the garage. The Elmore has been kept busy and has not had time to be on the public service stand more than three times.

Long Auto Line in Texas.—Road work has now been completed upon the extension of the automobile stage line from Seminole, Tex., to Carlsbad, N. M., so that now the total length of the line from Midland, Tex., to Carlsbad is 240 miles. Merchants of the latter place have offered a bonus if the schedule is fixed and maintained at ten hours. This is said to be the longest automobile line.

New Line to Yellowstone Park.—Orders for several Mason cars, made in Des Moines, Ia., have been placed by the Wyoming Transit Company, Inc., for use in service between Rock Springs, Wyo., and the Yellowstone Park, to make trips of 100 miles daily on a regular schedule.

Traverse City, Mich.—A rapid transit company has been given a license to operate an automobile 'bus line in this city on a regular schedule and a five-cent fare. During the Summer months the service will be extended to the resorts.

North Birmingham, Ala.—This city has just received its new automobile fire engine. The machine arrived lately and after a satisfactory public demonstration by Chief Bennett was permanently located at the central fire station.

Ilion, N. Y.—A motor 'bus company is arranging to establish a regular automobile service covering Otsego street, West hill, Barringer and Armory hill.

RECENT BUSINESS TROUBLES.

Missouri Valley Auto Co., Kansas City, Mo.—Harvey E. Rooklidge, president of the Missouri Valley Auto Company, 1112-1114 East 15th street, Kansas City, Mo., has made application for a receiver for the company.

RECENT BUSINESS CHANGES.

Stromberg Branches Move.—The New York branch of the Stromberg Motor Devices Company will move about April 1 to the new Automobile Building at Broadway and Sixty-fourth street, where offices will be combined with the installation department. The San Francisco branch has been moved to 307 Golden Gate avenue from its former location at 426-428 Van Ness avenue.

Hess-Bright Manufacturing Company, New York.—The New York office of the Hess-Bright Manufacturing Company has been moved from 90 West street to 1974 Broadway, where a store has been opened to carry complete lines of HB-DWF ball bearings and Hess-Bright magnetos. George T. Gwilliam is the resident manager.

New York Knox Branch Will Move.—The Knox Automobile Company has leased the salesroom at 1966 and 1968 Broadway, New York City, formerly occupied by the S. P. O., and its metropolitan branch, under the management of H. M. Davis, will move into it on May 1.

Hayes Mfg. Company to Enlarge.—The Hayes Manufacturing Company of Detroit, manufacturers of automobile sheet metal parts and forgings, has found it necessary to erect an addition to its plant on Maybury avenue.

PERSONAL TRADE MENTION.

Irving J. Morse, until recently the manager of the Philadelphia branch of the Locomobile Company of America, has received a promotion in being assigned to the management of the San Francisco branch of the Locomobile Company, having in charge not only all of the business in the Western and Coast States, but also of the export business to Japan and Hawaii. Philadelphia automobilists gave him an enthusiastic send-off, expressing at luncheons their regret at losing him, but congratulating him upon his enlarged work. Mr. Morse's successor is S. de B. Keim, who has been connected with the Locomobile Company for nine years in various capacities.

P. K. Larter, for many years a prominent feature in New York automobile circles, and well known as a driver of Mercedes and Renault cars, has become identified with the Allen Auto Specialty Company, of 1926 Broadway, N. Y., makers of Allen tire covers, as Eastern traveling representative.

W. A. Woods, formerly general manager and treasurer of the Cleveland



First Holmans Take Part in Family Reunion.

Four of the first cars made by the Holman Automobile Company recently took an active part in a family reunion at Spirit Lake, N. D. The cars are owned by the family of A. P. Halstead and traveled distances varying from 20 to 100 miles for the gathering. They are over six years old and still in service.

Motor Car Company, of Cleveland, O., has joined the staff of Manager William B. Hurlburt, of the New York branch of the E. R. Thomas Motor Company.

William W. Taxis, who has been connected for several years with the White Company, has been appointed assistant sales manager in the East to assist George W. Bennett, the Eastern sales manager.

Henry Plow, secretary and treasurer of the Hartford Rubber Works Company, has resigned, to take effect on April 15. He will then become the assistant treasurer of the Mitchell Motor Car Company.

C. S. Bugbee has been appointed district sales manager for the City of Detroit by the Rapid Motor Vehicle Company, with salesrooms located at 467 and 469 Woodward avenue.

Peter Fogarty has re-entered the metropolitan sales business as sales manager for George C. John, who now handles the American Mors, the Marmon and the Interstate.

John H. Rosen has been appointed general manager of the Autolight and Motor Supply Company, Inc., Broad street, above Spring Garden, Philadelphia.

STEWART & CLARK EXPANDING.

Owing to the vast increase in its speedometer business, the Stewart & Clark Manufacturing Company, of Chicago, has found it necessary to con-



Factory of Stewart & Clark Mfg. Co.

stantly expand its manufacturing facilities. The illustration shows the company's plant as it appears to-day, a new addition having just been completed and occupied. This recent addition, although large in extent, must be followed shortly by another still larger. The company reports an unprecedented demand for all the models of the Stewart line, including those recently added and shown at the recent New York and Chicago shows.

SPIRAL SPRING PATENTS.

"Supplementary Spiral Springs," made by the Supplementary Spiral Spring Company of St. Louis, will hereafter be sold exclusively to the trade, as well as retail, by the St. Louis Supplementary Spiral Spring Company, Inc., of New York. The latter concern has just been incorporated, and has established its offices in the Motor Mart Building, 1876 Broadway. It will take the entire production of the St. Louis factory. William Young is the president of the firm.

By an injunction restraining Graham's Automobile Spring and Appliance Company of Boston from imitating in any way the product of the St. Louis Supplementary Spiral Spring Company, Inc., the latter has won a victory in a long suit for infringement of its patents, and gives it the patent rights in the manufacture of its shock absorbing springs.

RECENT INCORPORATIONS.

Herring-Curtiss Company, Hammondsport, N. Y.—Capital, \$360,000. To manufacture motors, motorcycles, boats, vehicles, balloons and flying machines. Incorporators: A. W. Gilbert, Brooklyn, N. Y.; Chas. Heitman, Forest Park, N. Y.; W. B. Denton, New York City.

Mason-Seaman Transportation Company, New York City.—Capital stock, \$500,000; will run a livery and boarding stable, automobile passenger and baggage transfer. Incorporators: Henry Schwed, Wm. H. Corbitt, Arthur Frank and John J. Harris.

Welch-Forrester Company, New York City.—Capital stock, \$25,000; will manufacture motors, vehicles, engines and machinery. Incorporators: A. R. Welch, Pontiac, Mich.; Allen P. Hallett and Mark M. Solomon, New York City.

Munsing Motor Car Company, Hoboken, N. J.—Capital stock, \$1,000,000; will manufacture automobiles, motors, engines and trucks. Incorporators: W. H. Buresmith, J. B. Franklin and C. H. Bellows, Jr.

Dart Engineering Company, New York.—Capital, \$10,000. To manufacture automobiles, auto cars, motorcycles. Incorporators: J. R. Del Rio, New York; G. C. Autenrieth, Westchester; P. S. Tice, Brooklyn.

Cordner Motor Car Company, New York.—Capital, \$25,000. To manufacture, lease and sell horseless vehicles. Incorporators: A. B. Cordner, Robt. E. Graham and W. H. Flinn, Broadway and 76th street.

Wonder Manufacturing Company, Syracuse, N. Y.—Capital stock, \$40,000; will manufacture motor boats and automobiles. Incorporators: William D. Boyle, George T. Hurd and Bertha C. Cornwell.

Valley Boat and Engine Company, Baldwinville, N. Y.—Capital stock, \$20,000; will manufacture gasoline motors and engines. Incorporators: D. S. Simpson, R. H. Hubbell and J. Tallmadge.

Auto-Car Manufacturing Company, Buffalo, N. Y.—Capital stock, \$250,000; will manufacture automobiles, motor vehicles. Incorporators: John B. Pierce, G. W. Atterbury and G. D. Pratt.

Barnes-Curtiss Company, Inc., New York City.—Capital stock, \$25,000; will manufacture, rent and deal in automobiles. Incorporators: H. B. Barnes, Jr., A. L. Curtiss, New York City.

Premier Motor Car Company, Chicago.—Capital, \$12,000. To manufacture automobiles and accessories, 100 Washington street. Incorporators: Webb Jay, W. E. Stalnaker, Robt. Eveland.

Connecticut Motor Vehicle Company, New York City.—Capital stock, \$50,000; will manufacture motors, engines and machinery. Incorporators: C. M. Gilpin, H. A. Shuart and H. C. Murray.

Reliable Auto Company, Ayer, Mass.—Capital stock, \$25,000; will do a general automobile business. F. H. Williams is the president and W. L. Preble is also interested.

Robert-Carleton Company, Boston, Mass.—Capital stock, \$45,000; will deal in fire wagons, police ambulances, etc. Incorporators: O. M. Carleton and Albert Robart.

American Auto Appliance Company, Chicago.—Capital, \$200,000. To manufacture and deal in vehicles. Incorporators: E. A. Garvey, C. A. Garvey and F. R. Belt.

Bilbro Auto Company, New York City.—Capital stock, \$20,000; will manufacture autos and maintain a garage. Incorporators: J. E. Troy, W. L. Brown and E. Mayer.

Consolidated Rubber Company, New Haven, Conn.—Capital stock, \$250,000; will deal in rubber, rubber products or stock and properties of similar companies.

Louis Geyler Company, Chicago.—Capital stock, \$60,000; will manufacture automobiles and accessories. Incorporators: L. Geyler, L. R. Geyler and J. L. McNab.

Bendix Company, Oak Park, Ill.—Capital, \$200,000. South Dakota corporation. To manufacture automobiles and accessories, 423 South Humphrey avenue.

Badger Four-Wheel Drive Auto Company, Clintonville, Wis.—Capital stock, \$45,000. Incorporators: Otto Zanchow, W. A. Benedict and W. H. Finney.

Wadhams Oil Company, Milwaukee.—Increase in capital stock from \$350,000 to \$500,000; will enter the automobile field with automatic tanks.

White Star Automobile Company, Atlanta, Ga.—Capital stock, \$150,000. Incorporators: Clarence Houston, Harry W. Anderson and Frank J. Long.

Pioneer Automobile Exchange, Los Angeles, Cal.—Capital stock, \$25,000. Incorporators: J. W. Mitchell, F. E. Edwards, H. F. Duck and R. E. Moir.

SELECTED AUTO PATENTS.

Issue of March 23, 1909.

915,733. Motor Vehicle with Three Axles.—Auguste E. Brillié, Paris, France, assignor to Société Anonyme des Automobiles Eugene Brillié, Paris, France. Filed Nov. 7, 1907.

915,769.—Motor Vehicle.—Russell Huff, Detroit, Mich., assignor to Packard Motor Car Company, Detroit, Mich. Filed May 18, 1908.

915,825. Differential Mechanism.—Bluford W. Brockett, Cleveland, O., assignor, by mesne assignments, to Ross Gear & Tool Company, Lafayette, Ind. Filed Nov. 29, 1905.

915,828. Rotary Engine.—Everett S. Cameron and Forrest F. Cameron, Brockton, Mass. Filed April 14, 1908.

915,839. Attachment for Tire Treads.—Frank A. Fox, New York City, assignor to Fox Metallic Tire Belt Company, New York City. Filed Sept. 9, 1908.

915,840. Tire Tread Attachment.—Frank A. Fox, New York City, assignor to Fox Metallic Tire Belt Company, New York City. Filed Sept. 12, 1908.

915,841. Attachment for Tire Treads.—Frank A. Fox, New York City, assignor to Fox Metallic Tire Belt Company, New York City. Filed Oct. 9, 1908.

915,842. Attachment for Tire Treads.—Frank A. Fox, New York City, assignor to Fox Metallic Tire Belt Company, New York City. Filed Oct. 10, 1908.

915,843. Antiskid Device for Tires.—Frank A. Fox, New York City, assignor to Fox Metallic Tire Belt Company, New York City. Filed Oct. 24, 1908.

915,891. Spark Timer for Internal-Combustion Engines.—Henry Schaake and John T. Cowie, New Westminster, British Columbia, Canada. Filed Feb. 7, 1908.

915,920. Rear Axle Driving Mechanism for Automobiles.—Alexander Winton and Harold B. Anderson, Cleveland, O., assignors to Winton Motor Carriage Company, Cleveland, O. Filed Sept. 7, 1905.

915,954. Pneumatic Tire Mounting.—Charles G. Hawley and Erle K. Baker, Chicago. Filed April 11, 1908.

915,976. Route Indicator for Automobiles.—Frank D. Lindenthal, Glens Falls, and John Protz, New York City. Filed Nov. 30, 1907.

916,032. Universal Shaft Coupling.—Charles Schmidt, Cleveland, assignor to Peerless Motor Car Company, Cleveland. Filed Jan. 2, 1909.

916,073. Starting Device for Internal Combustion Engines.—Arthur C. Wells, Amityville, N. Y. Filed Oct. 7, 1908.

916,086. Friction Clutch.—Albert N. Woods, Corvallis, Ore. Filed Feb. 4, 1908.

916,103. Carbureter for Explosive Engines.—David J. Cartwright, Boston. Filed Dec. 5, 1904.

916,118. Hub for Automobile Wheels.—Alfred A. De Mars, Lakewood, O., assignor of one-half to Harry Coulby, Lakewood, O. Filed Aug. 25, 1906.

916,214. Controller for Carbureters.—Alfred C. Stewart, Los Angeles, Cal. Filed April 27, 1908.

916,224. Motor Vehicle Drive Gear.—Wald H. Thomas, Taylor, N. D. Filed Dec. 21, 1908.

916,296.—Starting Mechanism for Internal Combustion Engines.—Edward C. Gentzler, Columbus Junction, Iowa. Filed Jan. 5, 1909.

916,312.—Ignition Gear for Internal Combustion Engines.—Rudolf, Zweibrucken, Germany. Filed March 3, 1904.

916,313.—Spark Plug.—A. W. S. Herrington, Madison, N. J. Filed May 7, 1908.

916,390. Terminal Connector.—Charles Cuno, Meriden, Conn., assignor to Connecticut Auto Engineering Corporation, Meriden, Conn. Filed March 28, 1908.

THE AUTOMOBILE

BROOKLANDS NOW HAS A HILL TO CLIMB

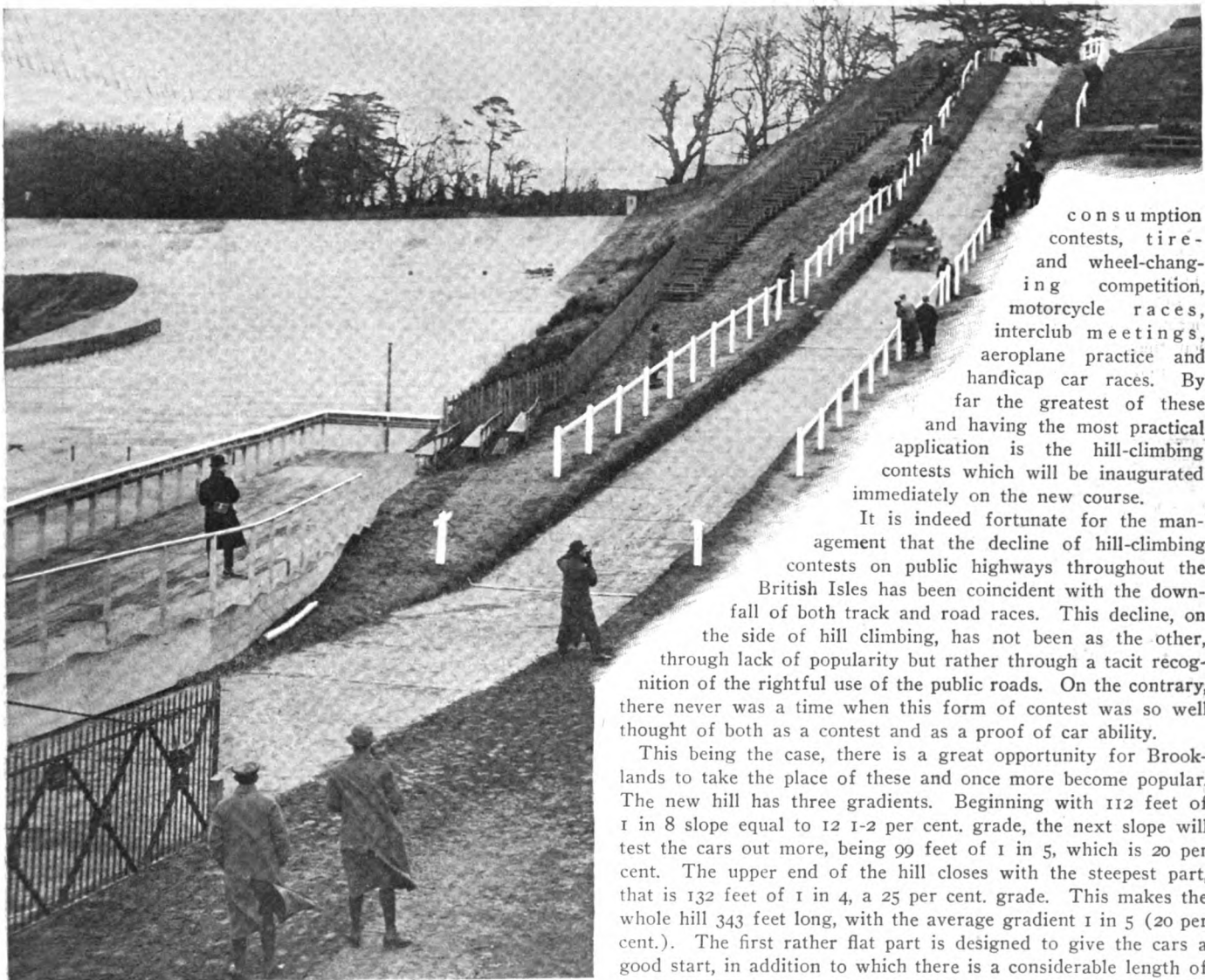

consumption contests, tire- and wheel-changing competition, motorcycle races, interclub meetings, aeroplane practice and handicap car races. By far the greatest of these and having the most practical application is the hill-climbing contests which will be inaugurated immediately on the new course.

It is indeed fortunate for the management that the decline of hill-climbing contests on public highways throughout the British Isles has been coincident with the downfall of both track and road races. This decline, on the side of hill climbing, has not been as the other, through lack of popularity but rather through a tacit recognition of the rightful use of the public roads. On the contrary, there never was a time when this form of contest was so well thought of both as a contest and as a proof of car ability.

This being the case, there is a great opportunity for Brooklands to take the place of these and once more become popular. The new hill has three gradients. Beginning with 112 feet of 1 in 8 slope equal to 12 1-2 per cent. grade, the next slope will test the cars out more, being 99 feet of 1 in 5, which is 20 per cent. The upper end of the hill closes with the steepest part, that is 132 feet of 1 in 4, a 25 per cent. grade. This makes the whole hill 343 feet long, with the average gradient 1 in 5 (20 per cent.). The first rather flat part is designed to give the cars a good start, in addition to which there is a considerable length of straightaway on the level, which will be used for contests with a flying start. Thus high and low gear can be reckoned with in contests.

Above the flat lower part of the grade increases as the upper end is approached until the final part is the steepest of all. Beyond the top there is a slight bend and then the course leads past the grand stand in the general direction of one of the bridges over the main track. All this allows of unlimited speed on the hill with prospects of being able to run beyond.

For testing purposes this will be ideal and the time will doubtless come when this famous place will lose its identity as a race

LONDON, April 2.—Brooklands, the famous English automobile race course, in which thousands of dollars have been invested, is making another important bid for support, which means another effort to insure some sort of return to the stockholders. A special course has been laid out up the hill in front of the clubhouse, and its already incessant use indicates its attractive value, especially to the man who drives his own car and wants to know what it can do actually.

There have been, and now are, many other plans for popularizing this great but unprofitable enterprise, including fuel-

course and become the national testing grounds, all kinds of tests being provided instead of the single-speed opportunity of the past and the dual idea of speed and hill climbing of to-day. When this comes to pass certificates will probably be issued which set forth the ability of the car under test. According as the track management acts wisely or otherwise these certificates will have a very real value. In fact, viewed in this light, it is not hard to imagine the average Englishman, ignorant of automobile mechanism, buying on basis of a Brooklands certificate.

The surface of the hill, like the main track, is of concrete about 6 inches thick. On either side are banks of turf 2 feet wide and about 3 feet high, on top of which is a hand rail some 2 feet high. This puts possible spectators quite a distance away from the track and far enough above the cars competing to counteract this. By this arrangement those looking on are in a position to see well without any danger to themselves should the railing give way. The width of the concrete surface is 12 feet, cambered at the center about 2 inches.

The timing arrangements provide for electrical timing at the foot and at the end of each strip of the hill so that total time and individual time on any one part may be taken.

The hill idea took hold very rapidly, only having been proposed the latter part of January. The manager of the track took to it at once, secured the necessary money and proceeded with the construction with all speed. The result is that the hill, conceived less than 10 weeks ago, is now a reality.

One of the minor problems of construction was to lay the concrete in such a manner as to prevent it from flowing both when laid and under the severe work which the use of it entails. This was effected by the use of very heavy cross timbers of oak, which were themselves set in concrete, the latter being in cross trenches some 3 feet deep. Above these timbers come the main ties and finally smaller wooden slats which act as spacers. The concrete foundations fill in between the ties and just cover them. Then there is the top dressing formed of very fine concrete with small granite chips imbedded in it to provide the "hold" necessary on a gradient as steep as this one.

STEAM SCORED BEST IN 'FRISCO CLIMB.

SAN FRANCISCO, March 29.—The initial event of the San Francisco Motor Club, held yesterday, was a hill climb up what is known as Nineteenth Avenue Street Hill, which has a 6 per cent. grade. The course was a mile long, and the cars were sent away with a standing start. The event also brought out a new timing apparatus designed by a local autoist. This worked perfectly, and made it possible to pull off the whole programme in two hours. The record for the hill went to the White steamer, which climbed in 1:12 2/5.

The fastest time made by a gasoline car was that of the Comet, the California built car, which covered the mile in 1:15 1/5.

CARS COSTING \$1,200 OR LESS.

1. Buick "White Streak"	Frank Murray	1:24 4-5
2. Mitchell	A. E. Hunter	1:35
3. Auburn	G. C. Murray	2:00 2-5

SPECIAL MATCH RACE BETWEEN \$2,000 WHITE STEAMER AND \$1,580 STODDARD-DAYTON.

0. White		1:12 2-5
0. Stoddard-Dayton		Did not finish
(Declared no contest by judges.)		

CARS COSTING MORE THAN \$1,800 AND LESS THAN \$3,000.

1. Thomas "40"	I. L. de Jongh	1:21 2-5
2. Buick	C. S. Howard	1:25 2-5
3. Comet	Frank Free	1:26 1-5

CARS COSTING MORE THAN \$3,000.

1. Stearns	D. A. Bonney	1:20
2. Pope-Hartford	Jack Fleming	1:20 2-5
3. Palmer & Singer	C. Onthank	1:23 3-5

CARS COSTING OVER \$1,200 AND LESS THAN \$1,800.

1. Stoddard-Dayton	Fred J. Wiseman	1:20
2. Oakland	W. W. McDonald	1:40 2-5
3. Overland	Bob Fowler	1:54 4-5

FREE-FOR-ALL.

1. Stanley Steamer	O. C. Joslyn	1:13 3-5
2. Comet	Frank Free	1:15 1-5
3. White Steamer	Gus Seyfried	1:16 1-5
4. Stearns	D. A. Bonney	1:18 1-5
5. Stoddard-Dayton	Fred Wiseman	1:19
6. Pope-Hartford	Jack Fleming	1:20
7. Palmer & Singer	C. Onthank	1:23 2-5
8. Acme "Six"	Fay Sheets	1:24 4-5
9. Buick	Frank Murray	1:25 3-5
10. Rambler	L. B. Harvey	1:31 3-5
11. Mitchell	A. E. Hunter	1:32 3-5

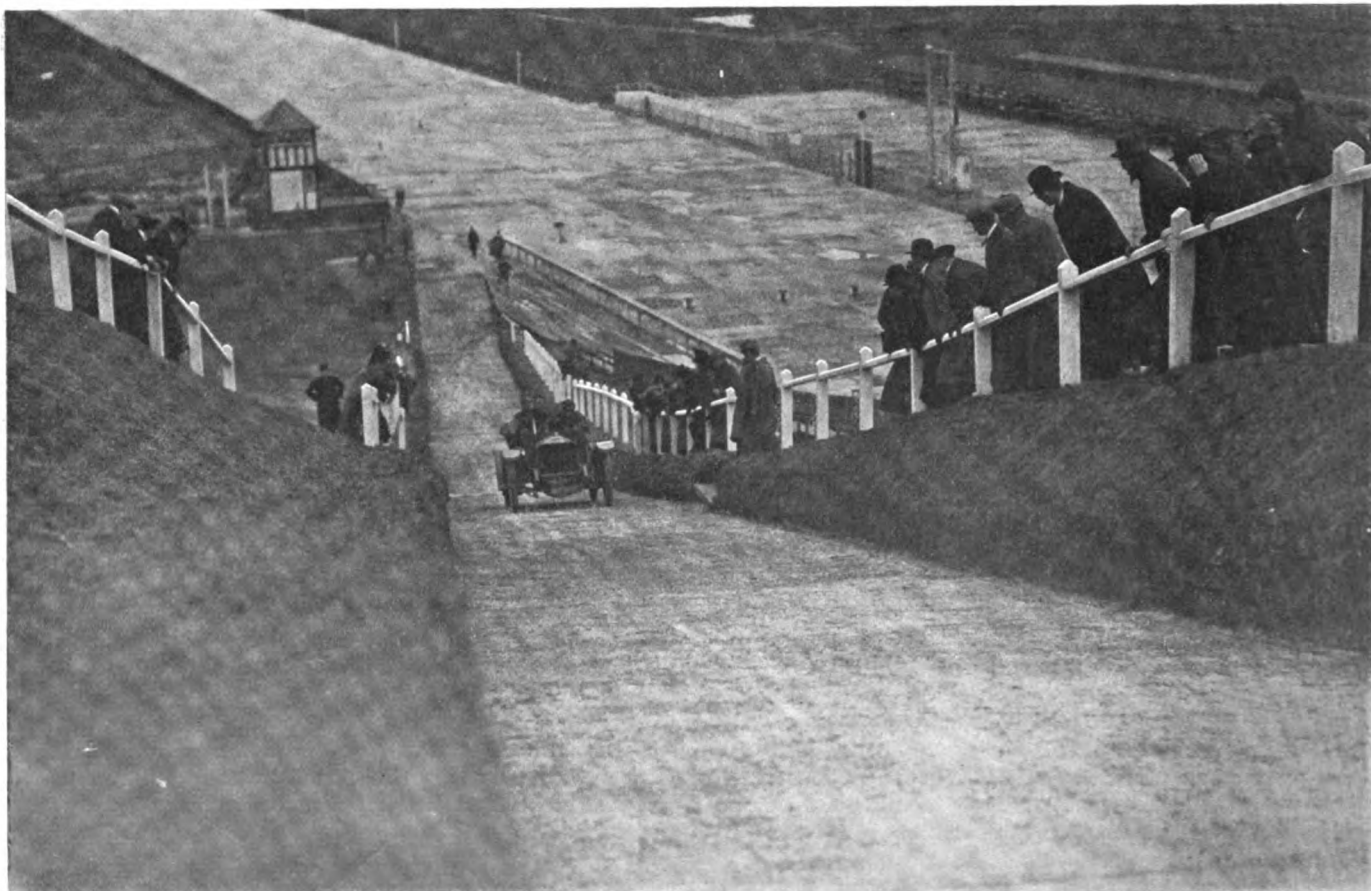

Looking Down from the Top of the Brooklands Hill During a Recent Private Test of Its Grades.



INDIANAPOLIS, IND., April 5.—Active work in building the Indianapolis Motor Speedway has been commenced by the contractors and carpenters, and in a very short time it is expected that the fifty feet wide course will be completed. The contractor in charge of the grading has on the scene machines which gather and dump a wagon load of dirt every half minute, with the scrapers, scoops, rollers, traction engine, and wagons necessary to do the work. The track will be sixty feet wide on the banked turns. The carpenters are busy building the fence, and the buildings, and a uniform color scheme has been decided upon for their finish. A view of green, trimmed with white will greet the visitors next Summer. A club house and a two-story restaurant are expected to be completed by June 1.

There are 328 acres in the enclosure, and the first plan of having two courses, one within the other, the outside one three

miles long, and the inside one two, giving a five-mile course by using them combined, has been changed. The new plans call for an outside track of two and a half miles with curves that will permit a speed of 105 to 112 miles an hour, and the inside course is the same length, so that together the five miles can be secured. Under the present arrangement the cars will pass the grand stand three times on one lap, and it will be possible to see all of the contestants all of the time, at any part of the course.

The Indianapolis Gas Company will soon have a pipe line laid to the space for filling balloons, and in ample time for practice for the international race of the Aero Club of America, which starts on June 5. G. L. Bumbaugh, aeronautical captain of the Aero Club of Indiana, returned from the West this week to accompany Indianapolis balloonists in their flights necessary to become pilots in the national club.

ST. LOUIS PLANS CONCRETE RACE COURSE.

St. Louis, April 5.—A project to build a reinforced concrete automobile race course and balloon ascension grounds has been started by the Million Population Club of this city, and has made rapid and substantial progress. The track will be oval and two miles in length, with the ascension grounds in the center, and a grand stand will be erected to accommodate 10,000 people. The Missouri senators have become members, and a large number of wealthy men have joined in booming the plans.

NO WILBRAHAM CLIMB THIS SUMMER.

Springfield, Mass., April 5.—The Automobile Club of Springfield has decided not to hold the Wilbraham mountain climb this year on account of the high expense incurred by the event. Last year it cost the members about \$1,200, and it is the opinion here that the money could be spent better toward improving roads and in erecting signs. A committee has been appointed to inspect the road between Holyoke and Smith's Ferry and to report upon its condition, looking toward its reconstruction.

CAVALRY WILL GUARD LOOKOUT MOUNTAIN CLIMB

CHATTANOOGA, TENN., April 5.—So much interest has been taken in the hill climb which will be held by the Lookout Mountain Automobile Club, on Lookout Mountain, that it has been found necessary to make the affair of three days' duration instead of one, and perhaps the most important action in preparation for the event is the securing of Government troops to guard the course. Absolutely everything that can be thought of has been outlined and will be arranged.

The three days chosen are April 22, 23 and 24 and entry blanks have already been sent out to prominent manufacturers and dealers, there being eight races on the list, two free-for-alls, four for various classes of stock cars and two for motorcycles. Inasmuch as the hill is four and a half miles long and only a few cars will be allowed on it at a time and perhaps only one at a time, it will probably take some time to run off the eight events. It was this fact which influenced the club in setting three days for the festivities. While the troops have not

been definitely secured, promises have been made to the club that the Government cavalry will be supplied, for there are a couple of thousand stationed at Fort Oglethorpe, Dodge, Ga.

Already work has commenced upon the course and a force of men is banking up the turns. The highway itself is a stone pipe and needs little repairing. Owing to the frequent windings of the hill a system of block signal is being installed. The following is the list of events and prizes:

- Event 1.—Free for all, no restriction as to weight, motive power or other construction. C. E. James Trophy.
- Event 2.—Free for all stock cars. W. J. Ollver Trophy.
- Event 3.—Stock cars listing at \$4,000 and under. Hotel Patten Trophy.
- Event 4.—Stock cars listing at \$3,000 and under. Chamber of Commerce Trophy.
- Event 5.—Stock cars listing at \$2,000 and under. Manufacturer's Association Trophy.
- Event 6.—Stock cars listing at \$1,000 and under. Mountain City Club Trophy.
- Event 7.—Motorcycle, up to 30 1-2-inch piston displacement. Chattanooga Automobile Club Trophy.
- Event 8.—Motorcycle, up to 61-inch piston displacement. Lookout Mountain Automobile Club Trophy.

France Now Keen After Small Car Market

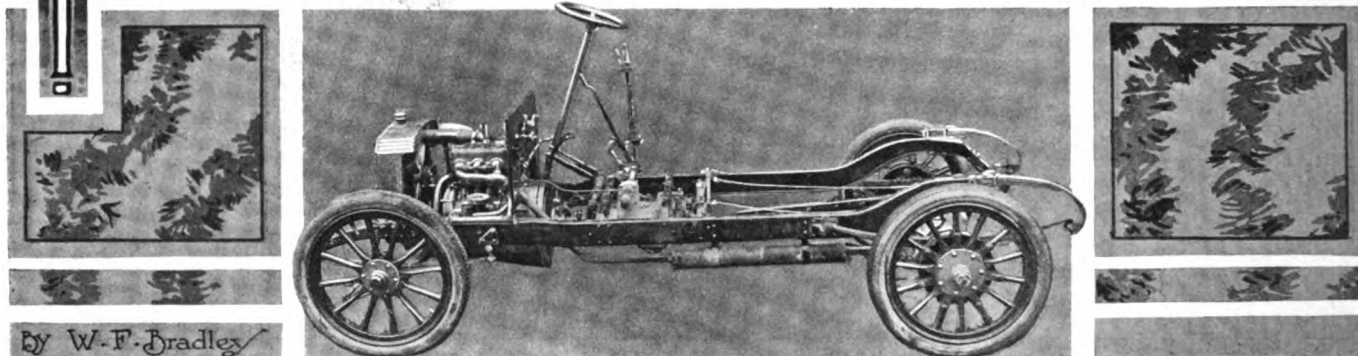

Panhard's Bid for the Small Car Business Shows Fine Proportions.

PARIS, April 1.—An epochal announcement has emanated from the big Panhard factory on Avenue d'Ivry, and the details of the new light car are now public. This is in the nature of a wide departure for the house of Panhard, in that it relates to the production of the first two-cylinder car brought out in the past ten years, the last one dating back to 1899. By many persons in a position to know, this is thought to be a bid for the small car market, now so much larger numerically than the big touring car business. This first impression is further strengthened by the announcement that this new chassis will be produced in very large numbers. An inspection of the lines of the chassis show that without alteration it will be available for taxicab use, which contingency was doubtlessly considered by the far-seeing engineers of the "Anciens Etablissements," and which swells the possible field greatly.

Whatever the intention, the fact remains that here is a little, light, low-powered car with Panhard materials and workmanship, built to sell at a low price. At least it is reasonable to assume that the price will be very close to its natural competitors of the same power, which would put it in the class of 6,000 francs or less. This would bring it into the United States at just under \$1,800.

Inaugurates Many New Features for Panhard.—Despite the number of characteristic features, such as the shaft drive, live rear axle, Krebs carbureter, usual spring suspension, typical radiator, deep section pressed steel frame, long stroke motor and many other Panhard earmarks, there are also evident numerous new features of sterling worth. Thus, it has long been characteristic of this house to cast the cylinders individually and

with valves on opposite sides. The new engine has these in pairs with integral water jacket, and valves placed side by side on the left. This allows the use of a single camshaft, simplifies the construction and cheapens it not a little.

Following in their ordinary lines, the engine has a long stroke. The bore is 80 mm. (3.15 inches) by 120 mm. (4.72 inches) stroke, a ratio of 1 to 1.5. This size easily gives the rated 8 horsepower without unduly high piston speed; in fact, it would be the A. L. A. M. rating for this bore.

Thermo Siphon Cooling Adopted.—Another departure which also makes for simplicity is the abandonment of the pump. In thus approving the natural circulation of the water, the tendency of the times is concurred in by one of the most conservative firms in existence. The radiator is unchanged, but the water pipes are enlarged in size, bends are eliminated or made of a large radius, while their length is reduced to a minimum. The outlet is on top midway between the cylinders, and the water enters at the front side of the jacket at an angle.

A large diameter fan is placed between the engine and the radiator. This is cast as a unit, blades, hub and all. It is of aluminum and the blades are ribbed for strength on the under side. A wide belt drives from the pulley on the crankshaft so that the fan speed will be high. The fanshaft is hung on one end of a rocker, the other being spring retained in position. This arrangement is such that the spring automatically tightens the belt and keeps it tight.

Careful Yet Simple Piping Arrangement.—The exhaust valves are placed at the front and back of the motor. This brings the two inlets together in the center and allows a simplified inlet pipe without in any way complicating the exhaust header. The latter has been carefully studied out and is given a slight downward slope to the rear. The diameter is increased at the junction of the second part and the flange at the rear is set on a diagonal, which allows the pipe to be dropped as soon as the two bolts have been removed.

The inlet is very short and stubby, leading down to the Krebs carbureter, placed midway between the feet of the crank case. The pipe for the hot air supply is readily seen on the valve side.

Single ignition is fitted with a magneto as the source of current. The latter is placed crosswise of the motor in front of the forward foot of the case, and rather low down. But two plugs are provided, placed over the inlet valves. This makes the ignition system one of marked simplicity.

Lubrication Shows Simplicity, Too.—The lubrication has been worked out as carefully as any other feature, and while presenting few new ideas, is noticeable for its simplicity. An oil reservoir is placed between the crank case feet on the right side and has a capacity of sufficient oil to take the car 150 miles. The oil is forced by pressure to an indicator on the dash from which it flows to the various bearings and thence into the bottom of the case. Interior lubrication is by splash.

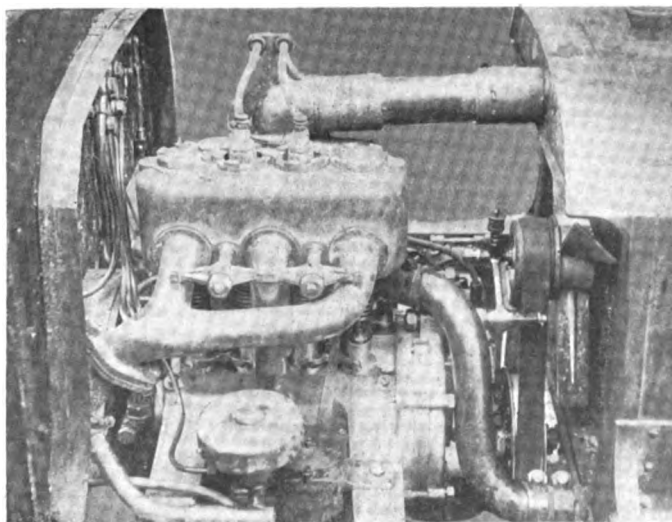

Valve Side of the 8-horsepower Motor.

The engine is attached directly to the main frame, but the transmission is carried on a pair of cross members. The former is a departure from ordinary practice. The frame itself is of pressed steel of a very deep section and is narrowed in two directions. In front, the side members are brought close together to dispense with the usual engine sub-frame and also to allow of a big steering lock. At the rear this narrowing takes the form of an uplift or drop, as you chose to call it, which lowers the center of gravity, with plenty of clearance over the axle.

The spring suspension shows the same as other Panhard models of late years, viz., flat semi-elliptic springs in front, shackled at the rear end only, and three-quarter scroll elliptic at the rear attached directly to the frame at both ends. The forward end is attached through the medium of a dust proof joint which allows of slight rotation.

Radical Change in the Clutch.—From the engine, the drive is through the medium of a clutch, which shows a wide departure from past practice. Formerly the clutch used was of the multiple disc type and was carried in an extension of the gear-case. On this car the clutch is of the inverted cone type, leather lined. This is readily removable for the purpose of renewing the leather or adjusting the tension of the spring, the latter being placed between the flywheel and the cone. Thus it is hidden from view, but this procedure has the virtue of also keeping out all dust and dirt.

The gear box provides three speeds and reverse, operating on the selective principle. The gears are of large diameter, with wide face and coarse module pitch. They are operated by the usual hand lever, which is the inner one of the two.

The control is by means of foot accelerator and throttle lever only, the spark advance being fixed. There are two pedals, the right one being connected to the brake on the driving shaft back of the transmission. The other is the usual clutch pedal.

Between the clutch and the transmission is a split shaft coupling with a square hole, a squared shaft working within this, and thus allowing the ready removal of either the clutch or transmission without disturbing the other.

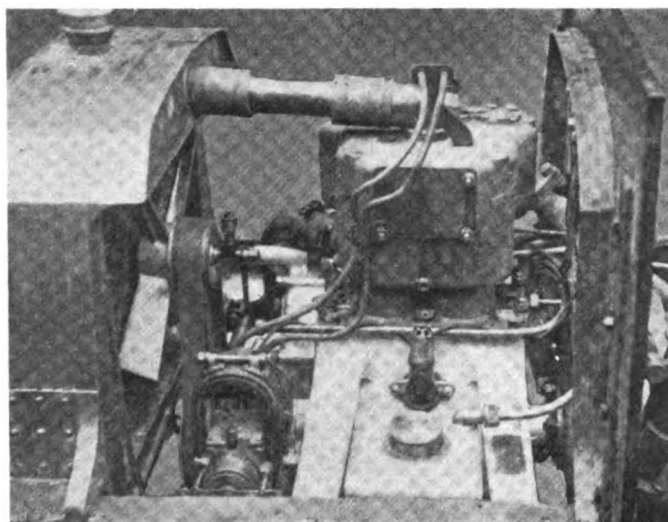

How the Magneto is Placed on the Motor.

The transmission shafts all run on ball bearings, but the engine bearings are plain. The balls are liberally used throughout the car on wheels and other parts.

Between the transmission and the rear axle carrying the differential case, the cardan shaft has two universal joints, one at each end. The differential case shows a bold stroke in the utilization of aluminum, this being a place where steel is ordinarily used. This is riveted to the steel tubes which carry the weight of the car and to which the springs are attached.

Ball Bearing Wheels Are Carried by Tubes.—The rear wheels, which are upon ball bearings, are carried by the tube within which the shaft proper does the driving by means of clutches at the outer ends. These allow some freedom of motion and in this way the axle neither carries any weight nor receives any of the destructive road shocks.

A BRIEF HISTORY OF THE HOUSE OF RENAULT

PARIS, April 1.—The union of the Renault Frères has been broken by the death of Fernand Renault, eldest of the three brothers who at one time formed the world-famed firm of automobile constructors. An attack of cancer, aggravated by the decomposition of the blood, brought about the end of Fernand Renault at the age of 44 and at a moment when he was about to enjoy the fruits of his rapidly earned fortune.

Fernand Renault was only introduced to the automobile industry through his brother Louis, who now remains at the head of the huge factory on the banks of the River Seine. The three brothers, Fernand, Marcel and Louis, were all destined by their father to succeed him in a wholesale linen drapery establishment on the Place des Victoires, Paris. Louis rebelled at the idea of passing his life behind a counter, and at 19 years of age quit his father's establishment to enter the Delaunay-Belleville firm as a draughtsman. At that time the automobile hardly existed, even in France, and was altogether unknown at the Delaunay-Belleville shops. Being interested in the budding method of road locomotion, Louis Renault applied to Panhard-Levassor for a position as a draughtsman, and was bluntly refused by Levassor with the remark that "No amateurs were wanted."

The amateur returned home, appealed to his mother for a small workshop adjoining the family dwelling at Billancourt and began the construction of automobiles. His first machine embodied the principle of direct drive by cardan shaft and revealed to the world that a master mind had tackled the problem of the automobile. Success in speed contests came as early as 1899, when the little vehicles, driven by 2 3-4-horse-power De Dion motors, won practically all the events of the year.

Marcel Renault soon threw down the tape measure and ran to assist his brother in the new industry. It was not an important industry at that time, for when the firm was constituted in 1898 the number of workmen employed was six, the factory area about 350 square yards, and the annual production six small cars. Louis Renault was responsible for the engineering branch of the industry, while his brother Marcel took charge of the commercial end and drove the small cars in all races. This continued until 1903, when in the ill-fated Paris-Madrid race Marcel Renault met his death, and his elder brother Fernand took full control of the commercial end of the factory.

A 10 years' contract of partnership between Fernand and Louis Renault expired last December. The elder brother, feeling that his health was not satisfactory, decided not to renew the agreement, but for the rest of his life to enjoy the fruits of his toil. At 43 years of age he was wealthy, decorated with the Legion of Honor and apparently destined to a long life. At the end of last year, therefore, he quit the factory, which had grown from an area of 350 square yards to nearly 60,000 square yards, from an output of 6 cars to 5,000 per annum, and from a staff of 6 to an army of 2,600 workmen regularly employed.

At 32 years of age "Monsieur Louis," as he is familiarly called at the factory, remained at the head of the works he had created alone 11 years before. A few months later and death ratified the dissolution of the partnership by the removal of the elder brother Fernand. Now Renault Frères has become Louis Renault, and one of the world's most important automobile factories is controlled by a young man whose success has been phenomenal, but to whom fate has been cruel.

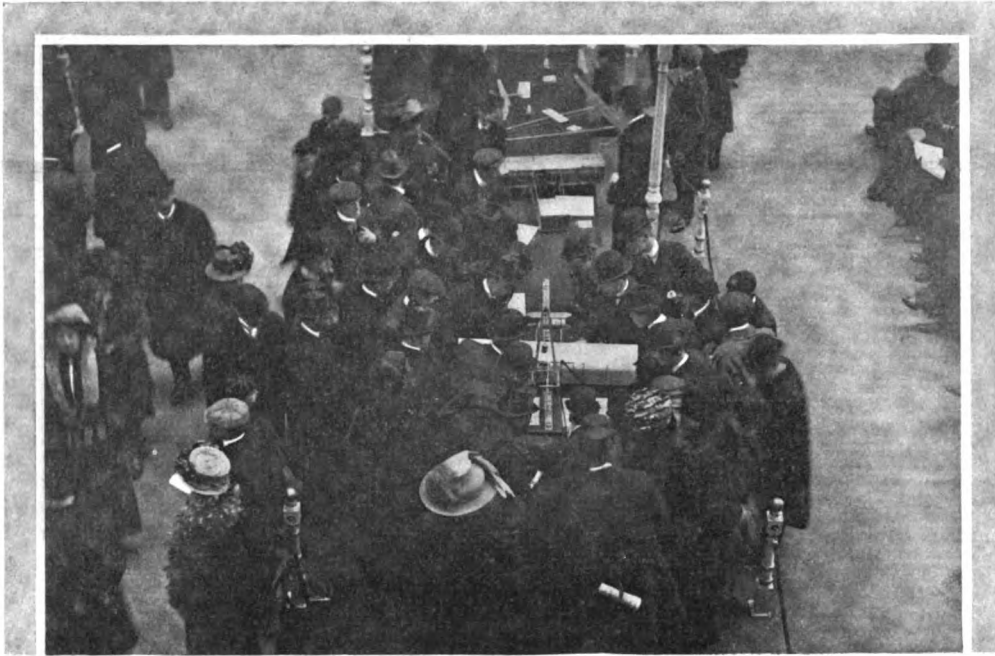

Britain Intently Studies Aerial Flight Progress

By Joseph A. Mackle

LONDON, April 1.—The exhibition of flying machines and their accessories, organized by the Society of Motor Manufacturers and Traders, and which opened its doors at Olympia on March 19, has already proved a gratifying success. Right from the first there has been evident a keen interest on the part of the public, while representatives of the military and naval authorities, together with many of the foreign attachés, have been devoting considerable time to a detailed study of the exhibits. This afternoon the Prince of Wales paid an extended visit and, altogether, these marks of distinguished favor and interest cannot but have a stimulating effect on the progress of aviation in this country.

As an exhibition the present collection is generally admitted to be quite as imposing as the earlier Paris Salon, for while the number of machines is somewhat less, the French show suffered from the scattered nature of its exhibits, due to the commercial vehicles.

Wright Among Absentees.

The collection of full-sized machines numbers 11, compared with 16 at Paris. The absentees comprise the Bleriot and Antoinette monoplanes, the Clement dirigible, several of lesser importance, but also—and its non-appearance is the cause of much disappointment—the Wright flyer. Fortunately there is a large scale model of this machine included in the excellent and extensive collection of models which occupies several stands in the center of the building. This section was specially organized by

the Aero Club, under whose auspices also the show is being held, and it serves well to demonstrate to the public the construction and differences of the various machines in a much clearer way than is possible with the full-sized and more cumbersome flyers.

The engine and accessory sections are likewise fully representative. The special lightweight motors of the French makers, such as the R. E. P. and the Guome, are staged along with the more substantial Belgian productions of E. N. V., Vivinus and Metallurgique. There are also many creditable productions of British firms who have for the most part favored reliability and endurance rather than extreme lightness of weight.

To deal with the full-sized machines first of all, the center of attraction, doubtless on account of its size and central position, is the Wellman airship, designed for the Wellman Arctic expedition by Melvin Vanniman, who is busily in attendance. To-day's report of the almost complete success of Lieutenant Shackleton's expedition to the South Pole, doubtless greatly assisted by his motor-propelled sledges, has caused even greater interest than before to be shown in this Wellman dirigible, with which an attempt will be made to reach the North Pole late this year.

Voisin Biplane Shown in Several Examples.

Three examples of the Voisin biplane are shown. F. R. Simms, as sole concessionaire, exhibits the standard Voisin machine, which has undergone no change in design. The engine, however, is the production of the Simms Works and is of the V type with six cylinders rated at 50 horsepower. The second example is the actual machine with which Moore Bra-

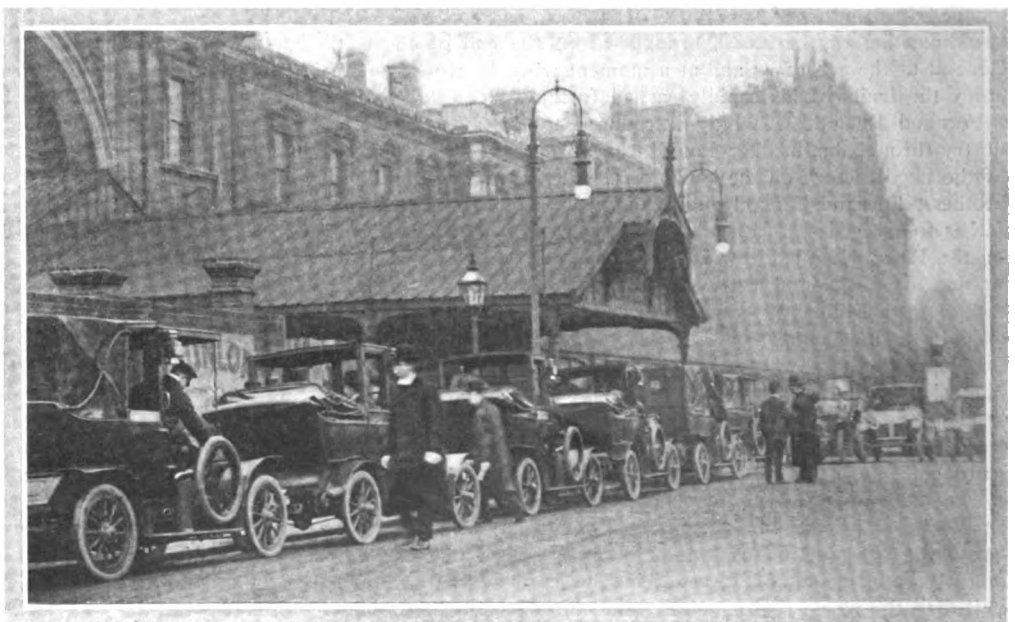

Taxicabs Outside the Aero Show, at Olympia, London. Note Spare Wheel Carried.

bazon has flown at Issy with such success. In this the distance between the main planes has been increased to 2 meters from the 1.5 meters, which is the figure for the standard machines. "The Bird of Passage," as it is styled, is equipped with an eight-cylinder E. N. V. engine of 65 horsepower, driving a twin-bladed propellor direct at 1,000 revolutions per minute. After the close of the exhibition this machine will be flown in this country at a place of favorable location.

The third Voisin is also a modification of the standard machine and is now known as the Delagrange biplane. The usual four vertical planes joining the main surfaces are absent in this machine and as they were dispensed with by Delagrange himself after his original flights, it is to be presumed that no loss of stability results. The engine is an eight-cylinder Antoinette of 55 horsepower and of the regular Antoinette design.

The "Short" Wright Machine Is Tailless.

The first of the British machines is shown by Short Brothers, the well-known balloon manufacturers, who are also building the Wilbur Wright biplanes (named thus in full to distinguish from the British Howard Wright machines) for the British concessionaires, Jarrott and Letts. The Short machine is not completed, but sufficient of it is on view to indicate the apparent soundness of its principles—a tribute which cannot be paid to several of the full-sized machines and many of the models elsewhere in the exhibition. It is a biplane, but of the "tailless" rather than of the Voisin type. The machine has also no outstanding rudder, steering being effected by means of four interconnected rudders, arranged in pairs just behind the extremities of the main planes. Where these rudders are situated the main planes are broadened out fore and aft and the lips thus formed can be flexed in opposite directions to control the lateral stability. Propulsion will be effected by an eight-cylinder V type British engine of 60 horsepower driving two rear propellers by chains. The machine is constructed of wood throughout and is a flexible rather than a rigid structure. The trials of this machine, to be held in a few weeks, are looked forward to with more than usual interest.

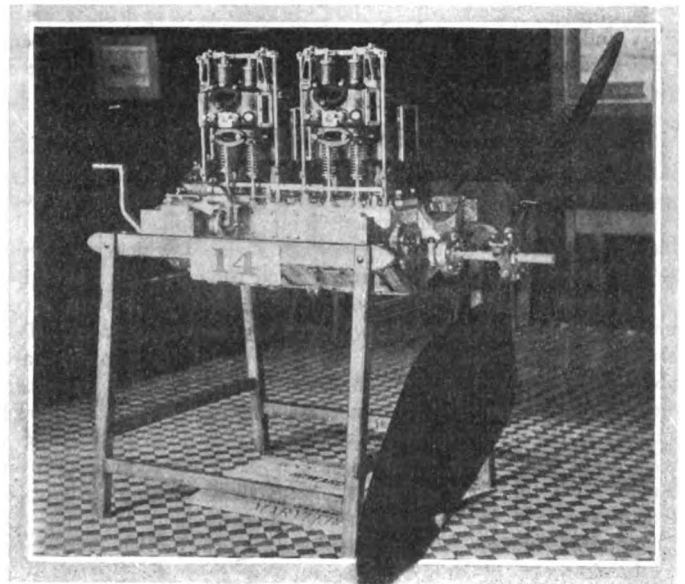

Four-Cylinder, 50-HP. Metallurgique Aero Engine.

The Howard Wright machine, on the other hand, is constructed of steel tubing throughout, the main members having a circular section, while the vertical struts are pear-shaped, to lessen wind resistance. All joints are rigid and have been welded by the oxy-acetylene process. The Voisin machine has been followed in its main lines, but the front elevator is of the biplane type and the main planes have small flexible silerons at the extreme rear corners. Interesting is the arrangement of the chassis on four wheels, diamond fashion, the idea being that the aviator may first drive over the ground until he has become accustomed to the machine. Motive power is supplied by a 50-horsepower four-cylinder Metallurgique engine driving a novel arrangement of a pair of two-bladed propellers in tandem



The Prince of Wales at the Olympic Aero Show, Examining Capt. Windham's Biplane.

at the rear. These two propellers are connected by a differential gear and revolve in opposite directions at one-third of the engine speed. The front propeller is somewhat larger in diameter than that at the rear. It will be interesting to note results.

Bregnet Biplane Has Been Changed Since the Salon.

The Bregnet biplane is quite distinct from the machine of this name exhibited at Paris, which was a combination of helicopter and biplane. The present biplane machine is unusual in having no surface forward of the main planes which are themselves mounted so that they can be tilted for elevating and righting purposes. A set of large planes comes in the rear, three above and one below, with two vertical rudders between. The structure is built up of large steel tubes and the members are so jointed that the machine can be easily folded up for transport. Continental fabric is used for the plane surfaces and a novel feature is the strengthening of all the forward or cutting edges with sheet aluminium. The engine is a 75-horsepower Gobron Brillie with the four cylinders arranged X fashion, driving a tractor screw in front—another novel feature for a biplane.

Captain Windham, the founder of the new British Aeroplane Club, shows a biplane machine of his own design built by Pischoff, of Paris. Between the two main planes are small righting planes operated by a movement of the operator's body. A rigid wooden framework connects the main planes with the rear elevating planes, which are almost as large as the main surfaces. The elevators and rudder are controlled by a double movement of a single lever, as in the Wilbur Wright machine. A four-cylinder Dutheil-Chalmers engine is fitted and this drives a single rear screw.

Monoplanes are represented by the R. E. P. and the Weiss, the more successful Bleriot and Antoinette machines being absent. The R. E. P. has been made in England and differs in no way from the one shown in Paris. The Weiss is a more novel production, and, like the Avions of Ader, closely follows bird form. The long monoplane surface has a cane and bamboo framework. No tail is fitted, but two small planes are let into

the rear edges of the main wings. These planes are operated by pedals and are so controlled that they may be used together, to rise and fall and in opposition, for steering and righting. Two rear propellers are chain driven by an eight-cylinder engine.

De La Hault Ornithopter Is a Curiosity.

Two very curious machines complete the list. The De La Hault ornithopter consists of a light upright framework with a pair of fabric-covered blades or paddles connected through a system of gearing to the engine, which is at the bottom of the frame with its crankshaft vertical. The gearing causes the paddles to give an alternate downward beat followed by a feathering motion on the upward stroke. The machine is said to have raised itself vertically from the ground, but a separate means of propulsion would be required for horizontal motion.

Finally the Lamplough machine is quite novel. The main sustaining planes are of the biplane type and in addition there are four longitudinal central planes arranged in pairs. These planes have a rocking movement imparted to them by a link motion. In addition to this rocking motion about the hinges on top of the supporting columns the columns themselves undergo a separate rocking motion so that the planes trace out a figure of eight each cycle with a feathering motion on each up stroke. Apart from this lifting device and the main sustaining biplanes, there are the rear elevating planes and rudders. A separate motor will operate two propelling screws in the rear. These, however, have not yet been fitted. The idea embodied in this machine is entirely novel and its development merits attention.

The present show was undertaken as an educative step and hence the absence of much business will not cause disappointment. Late reports indicate many good inquiries and a moderate amount of sales have been booked by the accessory and engine-makers and to a limited degree by the exhibitors of the Voisin types of machine. It is interesting to note that almost every exhibitor offers to guarantee a set performance for his machine. Usually this is limited to a two-mile flight, but even this much proves the makers' belief in their flyers.

WRIGHT COMPLETES CONTRACT AND PUPILS FLY

PARIS, April 1.—Wilbur Wright has completed his contract with the Lazare Weiller committee by the formation of three pupils capable of handling the American aeroplane alone. This week the pilot left Pau and returned to Paris, giving his pupils before leaving the right to beat any of his records. They were satisfied to commence by winning the Aero Club of France prizes for a flight of not less than 250 meters. Paul Tissandier first mounted the machine and in a few minutes had won the beginners' prize. Pleased with this, he was off again a few minutes later and when he settled down again had made 10 rounds of the course, or a total distance of 18 1-2 miles, in the official time of 27 minutes 59 seconds. Comte de Lambert followed on the same machine, won the 250 meters prize, then also accomplished 10 rounds; time, 27 minutes 11 seconds.

The success of the pupils shows how ill-founded are the reports that the Wright aeroplane can only be handled by professional acrobats after a long training. Of the three pupils only Paul Tissandier is a skilled sportsman, and not one of the trio is such an apt pupil as a score of automobile race drivers who might have been selected. Yet with men of ordinary ability it has been possible in a little more than a month, and by lessons of only a few minutes' duration, to form three aeronauts capable of handling the machine under all normal conditions. As the three pupils are now about to become teachers in their turn, it is certain that Wright machines will play an important part in European aeroplane races this year.

One of the Wright aeroplanes used at Pau has been shipped direct for Rome together with an engine, spare propellers and all accessories. Wilbur Wright has returned direct to Paris, while his brother and sister have stopped at Le Mans on their

way to the capital in order to visit the ground rendered famous by last year's flights. The two brothers and their sister will be in Rome early in the month of April, when Wilbur will make demonstrations before the Italian authorities for a fortnight. After this it is believed that a return will be made to America to complete the army contract interrupted by the accident to Orville Wright.

Just before leaving Pau the King of England paid a visit to the American aeronaut's camp and was given an opportunity of watching the machine at work. Orville Wright undertook to explain the mechanism of the aeroplane and King Edward did not fail to congratulate the brothers on their skill as flyers.

Clement Will Build a Much Greater Airship.

PARIS, April 1.—Adolphe Clement, pioneer automobile manufacturer, having sold his aerial yacht the *Bayard-Clement* to the Russian Government, has given orders for the construction of another one, larger and more powerful than the first. The new Bayard-Clement dirigible balloon will have a capacity of 212,000 cubic feet, compared with 123,000 cubic feet of the present airship. Its length and diameter have not been definitely decided upon, but an idea of its dimensions can be gathered from the fact that an airship garage is about to be built 330 feet in length and 88 feet in height—equal to an eight-story tenement. The balloon will be equipped with two independent engines, each one capable of driving the vessel under normal conditions, and the two together making possible a high rate of speed. With this new dirigible, the largest in the world with the exception of the Zeppelin, it is declared that voyages from Paris to London or Paris to Brussels and return will be quite possible.

AUTOMOBILE GASOLINE INVOLVES COMPLEX PROBLEMS

by Thor. J. Fay

GASOLINE, as the name of the liquid fuel used in automobiles, is a misnomer, in view of the practice in which all the fractions of the distillate, between 125 and 200 degrees Fahrenheit, are used in the mixture, whereas gasoline proper is a closely limited distillate, which comes off between 140 and 158 degrees Fahrenheit. Gasoline, as it is used in internal combustion motors, as they apply to automobile work, holds enough of the more volatile fractions to assure that the motor can be started cold, and if the means for heating are adequate the whole content of the fuel is burned in the process to more or less completeness, with a certain amount of carbon deposited in the combustion chamber, as evidence of any incomplete combustion.

The right name of this liquid fuel, in view of the number of fractions included, is "automobile gasoline," or automobile fuel, and that the fuel will take on many phases in the course of time is proven by the wide range of mixtures thus far used, with fair success, despite the trouble experienced in many attempts to use kerosene oil. True, kerosene oil has been and is used to-day, and the process is attended with good success in the field of its activities. Confining the discussion, however, to automobile work, it is certain that the day has passed when kerosene oil holds forth any further attractions, and what now presents itself is more by way of an adjustment of the details to suit the conditions as they really are.

When, in the early days of the automobile, gasoline (in fact) was used, the average autoist provided himself with a hydrometer, and when the gasoline failed to come up to a fitting standard it was easy enough to put some of the suspected liquid in a test tube, as shown in Fig. 1, and if the test indicated that the specific gravity of the liquid was in the neighborhood of 0.67, the conclusion reached was affirmative. The test was quite accurate, in the main, although it must be remembered that the hydrometer would not distinguish as between gasoline and some other liquid of the same density.

That the test would not disclose the presence of water should have been well understood, since, as Fig. 3 shows, the water would settle to the bottom, and the hydrometer could not very well be at two levels at one time. True, the illustration is a little exaggerated, in that more water is indicated than the amount that would be sold for gasoline even by a merchant of "accentuated oil acumen." Incidentally, this same illustration will help in the process

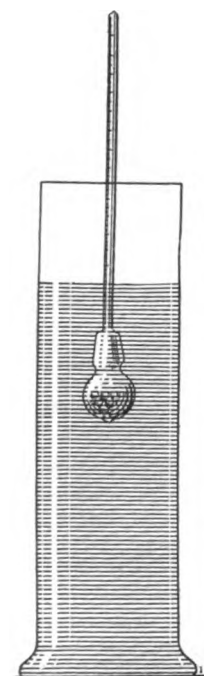

Fig. 1.—Hydrometer in single liquid.

Butane 1°C. B.P.	C_4H_{10} .600 S.G.
Pentane 36°C. B.P.	C_5H_{12} .626 S.G.
Hexane 68.5°C. B.P.	C_6H_{14} .674 S.G.
Heptane 98°C. B.P.	C_7H_{16} .688 S.G.
Octane 120°C. B.P.	C_8H_{18} .707 S.G.
Nonane 150°C. B.P.	C_9H_{20} .722 S.G.
Decane 160°C. B.P.	$C_{10}H_{22}$.738 S.G.

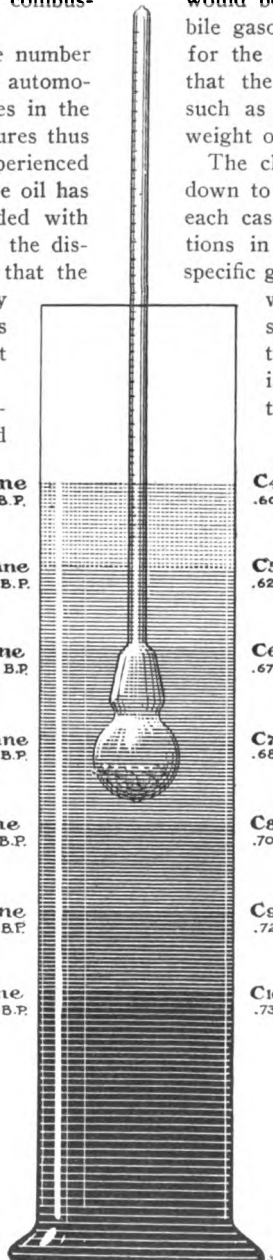

Fig. 2.—Test is valueless if there is a plurality of liquids.

of reaching the conclusion why the hydrometer measurement is of no avail at the present time.

Automobile Gasoline Is a Composite Product.—If it is admitted that oil and water cannot be tested by means of a hydrometer, in the manner as shown in Fig. 3, with a view to determining the specific gravity of the whole, a mere glance at Fig. 2 will be enough to "let the cat out of the bag" when it comes to the testing of present-day automobile gasoline, with a view to determining as to its composition, through the readings from a hydrometer. If water and gasoline cannot be tested, as in Fig. 3, in which there are but two liquids, what a small chance there would be of testing the complex liquid fuel called automobile gasoline in a test tube, using a hydrometer of any sort for the purpose! Referring to Fig. 2, it will be to observe that the several fractional distillates of hydrocarbon oils, such as are almost invariably found in gasoline, differ in weight on the one hand and in volatility on the other.

The chemical formulæ of the respective fractions are set down to the right of the test tube, under which formulæ, in each case, will be found the density of the respective fractions in specific gravity, as, for illustration, C_4H_{10} has a specific gravity (S. G.) of 0.600. On the left side of the tube will be found the customary name given to the respective fractions, and under the name of each of them the boiling point (B. P.) in degrees centigrade is also set down, as, for illustration, Butane (at the top of the list) boils at one degree centigrade.

By no stretch of the imagination can one reach the conclusion that a hydrometer will be of the slightest value in any attempt to determine the composition of a mixture of this character, nor would agitating the mixture help out, so that the license here taken, resulting in a display of the several fractions of the crude oil as laminæ, is in no way to the detriment of accuracy, in this attempt to illustrate the point to be made.

The List of Contents Is Far from Complete.—Besides the seven fractions listed alongside of the test tube, Fig. 2, there is a long list of hydrocarbon compounds that can be and are used in automobile gasoline, to an extent not easy to predict. Some of the remaining fractions, not all of the same school, are as follows:

- Hexahydrobenzine .. C_6H_{12} ,
S. G. 0.760, B. P. 69 deg. C.
- Hexahydrothoulene... C_7H_{12} ,
S. G. 0.772, B. P. 97 deg. C.
- Benzine C_8H_8 ,
S. G. 0.884, B. P. 80.4 deg. C.
- Toulene..... C_7H_8 ,
S. G. 0.871, B. P. 111 deg. C.

NOTE. — S. G. = specific gravity, and B. P. = boiling.

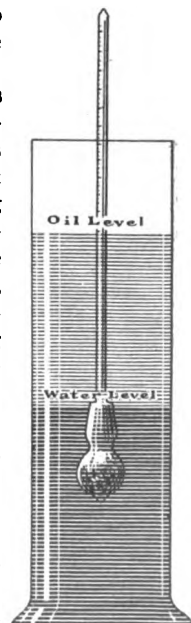

Fig. 3.—Indicating futility of test.

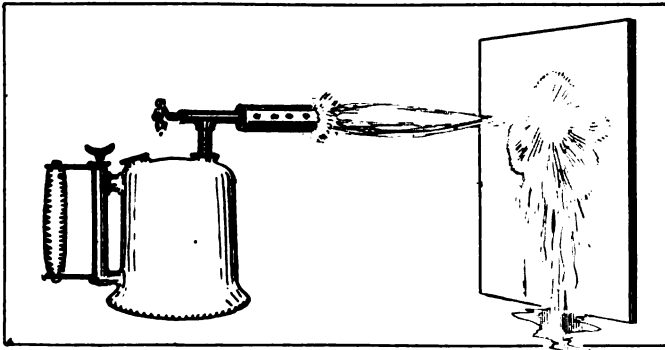

Fig. 4.—Heavy distillates will not burn and will pass over.

No mention has been made of alcohol, of which there are two classes, i. e., (a) methyl (wood spirits), and (b) ethyl (grain) alcohol. Of the alcohol products, it is assured that the only reason why they are not mixed up in automobile gasoline is because the market for alcohol is such as to render the same higher in price than the price which the other contents command at the present time, with small chance of any immediate improvement, considering present commercial conditions.

Let it not be supposed that the distillates, as mentioned, represent even a fair share of all the possible products of the paraffine, or other series, from which volatile hydrocarbon liquids are derived. Nor is it the purpose, at this time, to go into the question, at any further length than to point out the small chance any motorist would have in any attempt to determine as to the quality of the liquid fuel, such as might be purchased for his automobile, putting dependence upon a hydrometer, or, for that matter, any crude means, ready to hand. Of the distillates set down alongside of the test tube, Fig. 2, all are of the paraffine series excepting octane (which is from the methane series), and all are found in gasoline, as a rule, referring, of course, to the product to be had for automobiles.

Some Peculiarities of Automobile Gasoline.—If the several distillates that go to compose a given liquid have not the same boiling point, it requires no stretch of the imagination to see wherein trouble can arise if the conditions are not suited to the difficulties. Fig. 4 is of a simple gasoline torch, such as should be in the repair kit of every autoist, and if this same torch is filled with gasoline out of the tank of the automobile it will enable the autoist to see for himself that the mixture is not with a common boiling point for all the contents, for, if the torch is lighted, and if the flame is directed at a plate (a sheet of steel serves well), some of the gasoline will burn, and the balance will pass through the flame and impinge on the surface of the plate, resulting in a pool of the heavier portions of the fuel, on the ground, under the plate.

What does this show? First, that all the fuel is not of the same volatility, and again that the part that has the highest boiling point must be allowed the most time in which to burn. But if the available interval is the same, as it must be, for all the fractions in the automobile gasoline, there is plenty of room

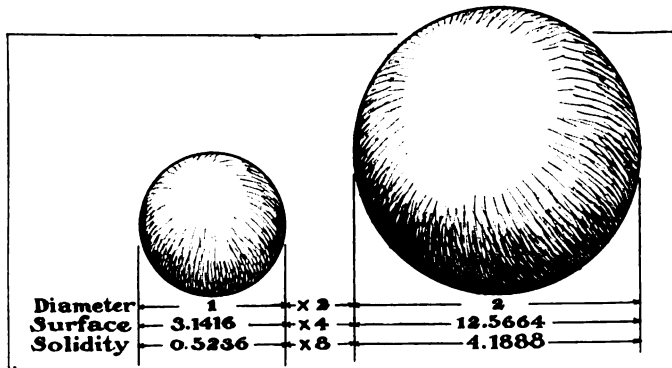

Fig. 5.—Spheres used to illustrate the effects of gasoline.

for speculation, and there is need for one of two things, i. e., (a) either the fuel must be adapted to the work to be done, or (b) the means for the use of the fuel must take into account the complex nature of the same, and the difficulties involved.

Gasoline Streams from the Nozzle of Carbureters.—When the piston in the cylinder of a motor displaces atmosphere, due to the travel of the piston, a partial vacuum is formed in the intake manifold, and because of the difference in pressure between the outside atmosphere and the partial vacuum in the "depression chamber" of the carbureter, gasoline is sucked out of the floatbowl, through the nozzle, into the depression chamber, in a stream, just as water is projected from a nozzle of a fire hose, and in the case of the gasoline, after it lands in the depression chamber of the carbureter, it is picked up by the current of in-rushing air and carried away, in globule formation, in route to the cylinders of the motor.

When these globules are very fine, and the air is well saturated with them, the product is not unlike a "fog," and if all the globules are of the same size, provided they are of microscopic dimensions, the resultant mixture will be good for the purpose, since it will vaporize and then burn, as a sequence, hence the motor will deliver power on a basis indicating that it is a homogeneous gas that is entering the cylinders. Unfortunately, the globules cannot be all of the same size unless all of the liquid is of the same character, so that it will be well to take a look at this phase of the subject and ascertain what will be the normal expectation under such conditions. Fig. 5 represents two spheres alongside of each other, so placed in order to point out the physical properties of spheres of different diameters, it being true that globules of gasoline are as spheres, and for the purpose in hand it matters not at all if the globules are very small, since we are dealing with relative sizes only, in actual practice.

If the two spheres are of one and two diameters, respectively, the surface of the large one will have four times the surface area of the small one, but, unfortunately (in this case), the solidity of the large sphere will be eight times the solidity of the small one. How, in the name of common sense, can eight times a given mass of gasoline vaporize in a given time if the surface is only four times as much? The exchange of heat is necessary in order to vaporize any liquid; to this rule gasoline is no exception, and since heat transfers, (a) in proportion to the surface, and (b) as the difference in temperature. It will require double the time to vaporize globules of double size, when, as a matter of fact, the time allowed is the same for all globule formations in practice, with the result that the larger, and the less volatile globules, enter the cylinders before they vaporize.

Gasoline Is Coked in the Cylinders.—Having traced the liquid gasoline into the cylinders, in which form we know it cannot be made to burn without first being vaporized, the next question is, what is the disadvantage? If wood is put on a stove, and if the drafts are opened sufficiently, the wood will be burned, and the remaining residuum will be ashes. If the wood is put into a sealed chamber *D*, as shown in Fig. 5, and provided a fire is maintained in the grate *E*, if the chamber *D* is sealed, so that air cannot enter through the door *C*, the wood so placed will be reduced to charcoal. If coal is put in the same chamber instead of wood, the product of the destructive distillation (for such it is) will be coke. In this case the fuel burned in the grate *E* is fired through the door *A*, and the ashes will collect in the pit *F*, while the gaseous products will go up the flue *G*. In this same process then we see that fuel is burned if it is allowed to assemble in the presence of its quota of oxygen, which it takes from the air, while it is "coked" if the air (in which oxygen abounds) is choked off.

Since gasoline is composed of carbon and hydrogen, if it is heated sufficiently, under suitable conditions, it too will form coke out of the carbon, and the hydrogen will be driven off. Fig. 7 shows a cylinder of a motor, in which it will be seen that coke *C* has collected in the combustion chamber, above the piston *B*, inside of the walls *A*. Since we know that a carbon crust does form in motor cylinders, it is not necessary to argue

as to the facts, but it is desired to find the reasons for the formation, in order that a remedy can be applied. It takes a little time to reach the conclusion that the process is precisely that which the old charcoal burner has used, for ages back, but, having evolved the idea, it will take more time to get rid of it, unless a means can be found by which liquid gasoline, of the complex mixture now in vogue, can be vaporized before it enters the cylinders.

It might be said that the gasoline burned in the cylinder of a motor is in the presence of atmospheric air, and on this account it should not be reduced to coke. But it is reduced, as is too well known to require further proof, and the reason why the air that enters the cylinder does not prevent the formation of this same coke is due to the mixture of the air with so much readily inflammable vapor of gasoline that the globules of less volatile liquid are not in shape to rob the fine vapor of its oxygen, even though there may be an excess of oxygen present. Further study of the spheres, as shown in Fig. 5, will aid in the process of reasoning, especially if account be taken of the short time allowed the gasoline to do its work.

Comparison of Carbon Deposit to Coke Not Far-fetched.—An examination in detail of the two products of combustion shows that the comparison is not a far-fetched one. The coal is purposely deprived of air in order that coke may result. The gasoline, deprived of its air, either purposely or otherwise, cannot help but produce the despised carbon residue. Not only are the processes by which they are formed very similar, but the

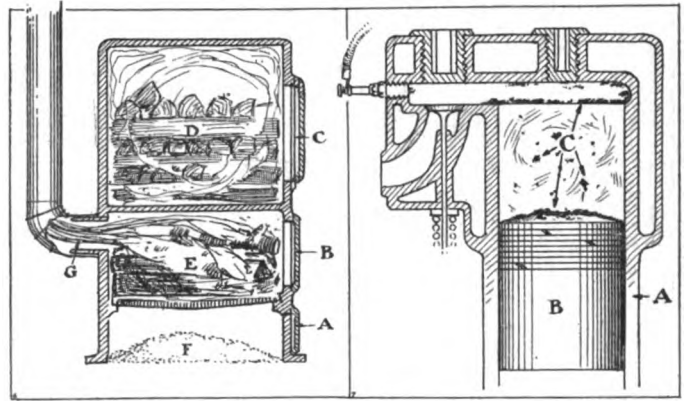

Fig. 6.—Coke is formed out of carbonaceous matter by heat in absence of oxygen.

Fig. 7.—Carbon collects in the cylinders in the same way that coke is formed.

physical and chemical forms of the two are very much alike. Coke is hard, brittle, porous and has a metallic luster. Carbon cylinder deposits are hard, brittle, porous but less so than coke, and have a metallic luster. The former is insoluble in any known liquid; so, too, is the carbon, which lack of air leaves on top of the piston. To dispose of an accumulation of coke it is crushed, being brittle, and washed or swept away. Similarly, to get rid of carbon, it is broken up and then blown out of the cylinder, or it may be combined with oxygen from decarbonizers.

LAWS HAMPER TAXICAB USE IN MONTREAL.

MONTREAL, April 5.—This city would like to have taxicabs, and there are two concerns which would be glad to please the residents, but the laws of the Quebec Legislature are such that the taxicabs cannot get licenses to do a hacking business. The Legislature has ruled that all automobiles and motor vehicles come under its jurisdiction and that municipalities must not pass laws affecting them. Therefore this city cannot pass a statute which would allow of giving licenses to automobiles. If the law is amended, then the city would be able to take the necessary action.

NEW YORK TAXICAB COMPANIES MERGE.

NEW YORK CITY, April 5.—The president of the New York Taxi-Service Company has announced the absorption of the Hexter Taxicab Company. This will swell the number of vehicles operated by the new concern by 50, now in operation, 50 more ordered and 12 touring cars. This added to the previous figures will give Mr. Whipple's company about one-fourth of the total number of cabs operating in the city. One outcome of the combination, according to the officials, is the possibility of still more absorption with ultimate reduction of rates.

SOMETHING DOING IN ATLANTA, TOO.

ATLANTA, GA., April 5.—The announcement was made a few days ago that a second taxicab service would be started in this city. No sooner was this made public than Manager Dunn, of the first cab line, known as the Atlanta Taxicab Company, left for the North to buy more cars. The first vehicles obtained were low priced, but the second installment will be of a very high class. This company has a large force of men at work on its garage on Ellis street, which will soon be ready. This is a very favorable location near the center of the city.

DRIVERS WILL GET STRAIGHT SALARY NOW.

BOSTON, April 5.—A new plan, which is intended to put an end to many of the troubles in connection with the taxicab service here, has just been put into effect. This consists of paying the drivers a weekly salary in place of paying a percentage of the gross receipts and charging for the gasoline. This move of the Taxi-Service Company is expected to give customers better service.

NOVEL AUTOMOBILE REPAIR SHOP.

The most novel repair shop known to the automobile trade is that belonging to the J. F. Thompson Repair Company, of Oakland, Cal. It consists of a platform and enclosed body mounted upon a 40-horsepower Rambler chassis. Within this is located the repair shop, which is well equipped, having a lathe with 10-inch swing, two 12-inch emery wheels, key seater, polishing wheels, glass rack, tool cabinets, benches and complete plumbers' outfit. The power for the machinery is derived from a 3-horsepower motorcycle engine. The owners have selected as their motto, with which the exterior of the vehicle is decorated, "We repair anything from a stewpan to an airship."

This is typical of the firm, which is very progressive and nothing if not hustlers. The outfit itself bespeaks their progressiveness, being not an old cripple, but an up-to-date touring car chassis, while the body is very well built for the purpose and not an adapted dry-goods box. Under the circumstances the tool equipment is a remarkably complete one, including, as it does, many tools, such as a large diameter lathe, not ordinarily seen outside of a good-sized machine shop.

Despite the large number of tools carried and the big enclosed body the total weight is but 4,220 pounds. The owners travel about Oakland, San Francisco, and vicinity, plying their trade and making no attempt at speed.



How a Rambler Chassis Is Utilized for Repair Shop.

AUTOMOBILE COOLING SYSTEMS ANALYZED

BY MORRIS A. HALL

PART IV

CONSIDERING the relative value of detached and integral fins on radiator tubes, it might be said that the efficiency of fins is very nearly equal to that of other radiating surfaces when the fin thickness is restricted to that of the tube and the spacing suitably proportioned, but for any thickness the maximum ratio of the fin diameter to the external diameter of the tube is a fixed quantity, and, if exceeded, the loss is in proportion to the excess.

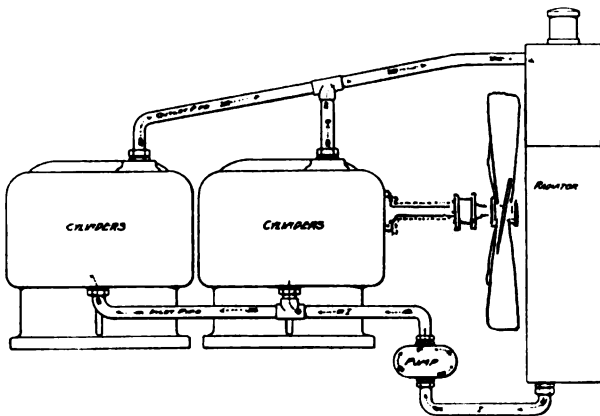

Fig. 14.—Diagram of typical cooling system.

In all of the above the surfaces and substances are treated from the viewpoint of inherent ability of stationary or fixed position. While the volume of heat to be dissipated is not great in the total, the time element enters, in that this dissipation must occur in a very short space of time. To cool a gasoline engine as used in the ordinary car with a cooler of the best possible materials, under the most favorable conditions and most efficiently, would require a radiator bigger than the car itself, if the radiator stood still or the air was allowed to flow through it naturally.

So to reduce the size to something that can be used, the relative efficiency is increased. This is done by an artificial flow of the cooling medium; in this case, air. This increase in flow of air is brought about in two ways, usually working simultaneously. One of these is that the radiator does not stand still, but is moved with the car. This forces air through the cooler at a rate equal to the rate of speed of the car multiplied by the coefficient of loss. This would not be effective with the car standing still but the engine running, so a second artificial circulating means is provided in the fan.

Rapidly Rotating Fan Does the Business.—It is driven from the engine, and so rotates when that rotates. If the engine runs slowly and has little heat to dispose of, the fan runs slowly. When the former turns over at a maximum rate of speed, the fan, too, is making the highest possible number of turns.

Air is such a very bad conductor and metals are so good in comparison that in heating still air, the quantity of heat the air will carry off is practically the same with a number of metals. Even with the air artificially circulated, this remains true up to considerable speeds. For this reason, also, the thickness of the metal has little effect. The rate of transmission is inversely as the thickness, but so high compared to the air that the heat is

supplied even through a thick plate faster than the air can carry it away. This is an added reason for supplying the latter at a very high rate of speed. Experimental data bears out this contention. Thus: heat flow in units per degree per square foot of surface per minute:

In still air.....	.0356
In gentle breeze.....	.0397
In fresh breeze.....	.0750
In fan blast.....	.0900

If any discussion of these results were necessary it would be sufficient to point out that under exactly similar conditions the fan blast removed nearly three times as many units of heat as were taken away at the slower air speed here called "in still air." In this connection it is to be regretted that definite figures corresponding to these rather indefinite phrases are not available, as it is believed that these would bring out even more forcibly the point made above. An Englishman, named Craddock, found that hot water in tubes, moved at the rate of 40 miles per hour, lost heat at 12 times the rate of tubes that were stationary. The inverse of his statement would be that fans and other provisions for circulating the cooling air at the rate of 40 miles per hour would be just 12 times as efficient as no provision whatever or natural air circulation.

This brings up the subject of fans, neglected by many as of little importance. Having just made out a case for the importance, a glance at some fans will be of interest. The fan problem may be attacked in either one of two ways, or perchance both. One of these is the location directly back of the radiator, drawing air through the radiator only. The other is the rear or flywheel location, drawing air through the radiator and thence across the whole of the engine, and thus effecting secondary cooling. Fig. 14 shows a diagram of a complete circulating system, in which the first method is utilized.

Great Variety in the Types of Fans Employed.—Even with this apparently simple and standard cooling arrangement, the appearance, type, and efficiency differ very markedly from one car to another. Thus at one of the recent automobile shows some one statistically inclined found that of 23 cars examined 7 had both forward and flywheel fans; 7 had rims around the outside of the fan; the number of blades varied from 4 to 8 (Fig. 15 shows one that has 12), the width of the blades varied from 3 to 6 inches, and the outside diameter ranged from 14 to 24 inches, the average being about 18 1-2 inches.

With such a wide divergence in current practice there must be something wrong. This lies in the fact that the subject, instead of being handled with the care it deserved, has been shamefully treated. The fans were built, not designed, and when put to work either did the work or failed. In the latter case, a

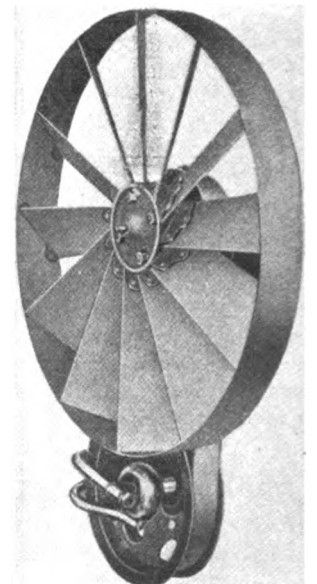

Fig. 15.—Example of the indiscriminate use of very many fan blades, a poor design.

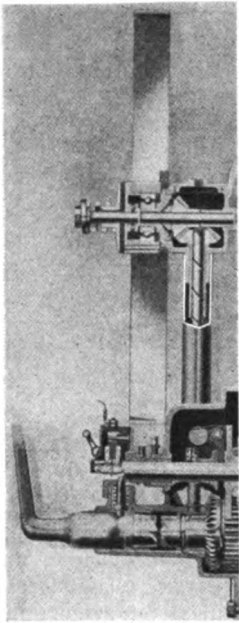

Fig. 17.—Bevel gear drive in section, showing clutch at left.

larger diameter was substituted, or the number of speeds increased, or the whole mechanism speeded up.

In the design of fans, the type enters; that is, whether of the disk or centrifugal style. Then there are the number of blades, width and angle of blades, external and internal diameters, speed of revolution, and a few minor points. For an enclosed fan blower of the centrifugal type the formula holds good:

Capacity, $C = 1.38 r^3 D^3 N$, in which N is the number of revolutions per minute.

D = the outside diameter in feet.

r = the ratio of inside to outside diameter.

This capacity is expressed in cubic feet per minute, under the condition that the full quantity can pass through the opening known as the blast area, without lowering the pressure in the housing. Under these conditions tests have produced quantities which only fell off from the formula rating by 10 per cent., and in some cases equaled

it. From which it might be taken that it represents correctly the desired amount, under proper conditions.

However, this is for a fan with a housing, and unless the ordinary airtight bonnet may be considered as an imperfect housing, this formula will be of no service. By the time that constants have been determined and introduced to care for this, the result would be far from the above and, probably, equally far from right, if not actually incorrect.

Even this difficulty, made clear by the above discussion, does not excuse the lack of an experimental determination of the correct number and arrangement of parts.

Drive Shows Equal Diversity.—The method of driving the fan varies as much as does the type and features. There are the flat, round, trapezoidal, and other forms of belt drive, bevel gear, skew or helical gear and worm drive. In the case of all but the few strictly mechanical arrangements, there is expected to be some slippage, but in the latter case there can be none. So with the various gear drives, a clutch is provided which may slip at the time of starting, and thus preserve the fan from self-destruction, at that time.

The elements of a bevel-gear-driven outfit are shown in Fig. 17. The clutch is at the outer or forward end, and is there seen to be extremely simple, consisting only of a flat plate normally held in engagement by a coiled spring.

With the fan flywheel method of drawing air through, one of two ways is used: either the fan blades are made an integral portion of the interior of the wheel, acting as spokes thereof, or they are found distributed around the circumference, in which case they can be either integral or applied. In the first method, the disadvantage is that the clutch is either reduced to a minimum size by the length of the fan spokes, or, starting with the required diameter of clutch, the external size of the flywheel reaches to a figure which prevents its use. Between the two is the case in which neither one is as large as would be advisable, but the whole is such as to go in the car. Fig. 18 illustrates a flywheel of this type. This was used in connection with a disk clutch of very small diameter, but with a large number of plates. This type has the excellent quality of putting the flywheel weight where it should be and where it is intended to be. This can be stated in different language by saying that this form of flywheel has the greatest ratio of effective effort to actual weight.

The other style of flywheel fan has the blades external to the flywheel proper. This means that they may be applied or removed at will unless cast integral. One disadvantage of this

form is the matter of available space. More clearance must be allowed around the fan than for a smoothly finished flywheel exterior. As this space is predetermined, it means cutting down the size of the effective part. This, in turn, means an increase in the dead weight to give the same flywheel effect. The latter is a permanent addition to the weight of the car. An additional disadvantage is that while the motor is running one must be careful of this rotating part, for with the external blades, it is dangerous and liable to take off a hand or a few fingers.

This is not so of the first mentioned arrangement. An advantage of the external fan blades is that their location is such as to give additional ability as a fan, in that the larger diameter will handle more air, and the same increased size give an increased lineal speed for the same number of revolutions. Summed up, this type gives the maximum fan and the minimum flywheel action. The first type, on the other hand, gives the maximum flywheel action with less weight and slightly decreased fan results. Fig. 19 is a picture of a typical example of the second kind, showing the fan blades cast integrally.

Oil Cooling Presents Some Good Features.—In one of the earlier chapters of this story mention was made of the use of other liquids than water for cooling purposes. In this category would come water with a very large percentage of foreign matter, such as alcohol, calcium solutions, glycerine, or other substances added in such quantities as to alter the boiling and freezing points and the general performance of the resulting liquid. These liquids would be different, but what were referred to were other liquids of an entirely different nature fundamentally, such as oil, or any petroleum product.

This has many times been advocated for cooling purposes, particularly in cold weather, when much stress was laid upon the very low freezing point of oil as compared with water. This means that every cold spell the owner of a water-cooled machine must introduce into the cooling system a solution which will combine with the water and reduce the freezing point of the whole below any temperature that is liable to be met. Otherwise, the chance is taken that the fluid will freeze, and in so doing burst the water jackets. This necessitates new cylinder casting, with consequent expense, work and delay.

With oil this source of trouble would be excluded, for even the thinnest, lightest oil has a freezing point below any temperature met in the temperate zone. So this factor may be eliminated and attention concentrated on the boiling point. It varies

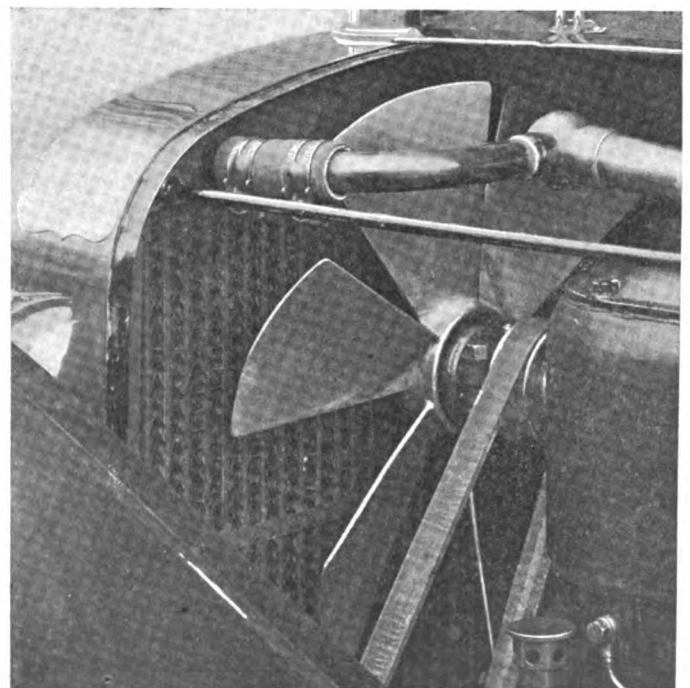

Fig. 16.—Shows a very good arrangement of fan and piping.

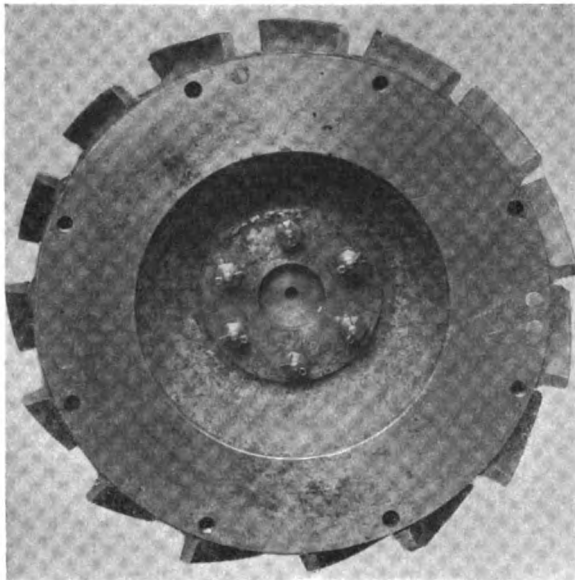

Fig. 19.—An alternate disposition of flywheel and fan.

with different substances, and in substances of the same general character varies with the chemical composition. In the distillation of petroleum the products have the same general composition, but the boiling point differs. Then a table of boiling points will look like this:

Ethyl Alcohol	173	degrees Fahr.
Water	212	" "
Saturated Brine.....	226	" "
Light Lubricating Oil.....	383	" "
American Mineral Oil.....	383	" "
Dodecane (Paraffin Series).....	385	" "
Tridecane	421	" "
Tetradecane	457	" "
Triamylene (Olefine	478	" "
Pentadecane (Paraffin	491	" "
Linseed Oil	597	" "

It should not be taken from this that these temperatures are advocated or even advisable. The point to be brought out here is that any substance whose boiling point is above that of water will be more useful. If the temperatures such as those at the end of the table were used the engine would be hopelessly ruined. Moreover, the use of vegetable oils is not recommended, although they are given in the table.

There are several firms in the Middle West using oil as a cooling medium, one of which has been using it for three or four years with the best of success. These people put their machines out into the hands of persons who have absolutely no mechanical skill and very little mental capacity. This being the case, there is a great necessity for a machine that is fool-proof. Oil as a cooling medium seems to fill the bill in this respect, for no amount of neglect can do the slightest harm. Cold weather will not affect it, at least not in any dangerous or destructive way, heat has no injurious results, care of the whole system is reduced to a minimum, a big point when the class of labor just mentioned is employed, in fact the only real necessity is the replenishing of the oil lost in natural and unavoidable ways, such as small leaks, slight evaporation losses due to inequality of the oil, and other minor ways. So it may be said, without fear of contradiction, that this cooling medium is ideal.

Radiators Are More Efficient with Oil.—Another claim made for oil used for this purpose has to deal with the fact that with water or other low-boiling-point fluid, the radiator is not worked to its full efficiency. It is said of honeycomb radiators, in particular, that they are too efficient; that is, they cool the water too much. This objection would be met squarely by the use of any liquid which had the power to remove a greater amount of heat from the engine, this being restricted in the case of water by its low boiling point. Oil would do this, and coming to the radiator with a greater initial temperature, would require the same final temperature, thus calling for an increased efficiency on the part of the radiator.

Tests which have been made upon oil bear out this contention. Fig. 20 shows the arrangement of the apparatus used in the test.

In the foreground is the engine, and beyond it and slightly above is seen the fan housing. At the right is the prony brake, and beyond it the starting rheostat for the electric motor which drove the fan. At the left are the pump and tanks to measure the weight of the oil, set upon scales. Some of the results obtained were:

RADIATOR NO. 1.			
Fluid	Heat Dissipated Units	Temp. Drop	Degrees.
Water	490	25	
Oil	700	12	
RADIATOR NO. 2.			
Water	490	40	
Oil	700	18	

From these results the conclusion is drawn that all radiators are at least 50 per cent. more efficient with oil than with water. This, as stated above, allows of abstracting more heat from the motor, which in turn allows of working it at a much higher temperature, and thus a greater thermal efficiency.

An indirect advantage of oil-cooling is the decrease in the mechanical losses with increased temperature. This latter is a mooted question, but the majority of evidence seems to favor the statement that higher temperature means greater mechanical efficiency. The writer's own experience in this matter showed for the same load and speed, same general conditions throughout, an increase of from 10 to 15 per cent. in mechanical efficiency was possible by increasing the temperature of the outgoing water from about 160 degrees Fahr. up to boiling point, or as close thereto as could be maintained using water. One test, to prove this point, resulted as follows:

Water Outlet Temp.....	69	150	185	203	220
Horsepower Loss.....	7.1	5.5	5.0	4.5	4.2
Mechanical Efficiency.....	85.0	88.0	89.0	90.0	91.0

The last set of results was obtained by plotting the others as a curve and taking a more advanced point from that curve.

The data necessary to plot a complete curve of this nature being at hand, it is believed that this appreciation of mechanical efficiency and depreciation of horsepower loss will reach a high point or peak at or near 250 degrees outlet temperature, the statement of a well-known authority on cooling to the contrary. With this temperature it would be easy to maintain efficient lubrication, which could not be said for more advanced degrees of heat. In this connection it must be carried in mind that the temperature mentioned is that of the outlet and not of the cylinder walls which will be higher in proportion.

The whole seems to make out an excellent case for the use of oil, but, strange to say, with the exception of the two Western firms mentioned, a couple of French tractors and a few German builders of heavy cars, these advantages have not been put to a practical use, despite the

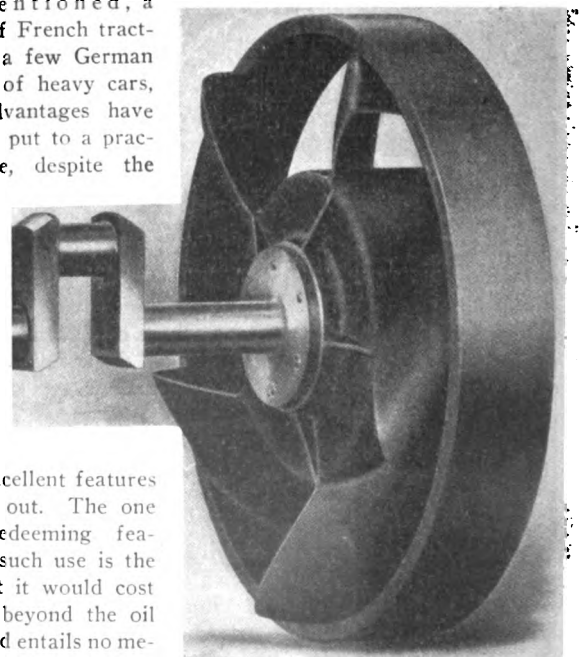

Fig. 18.—Efficient arrangement of both fan and flywheel in a unit.

many excellent features brought out. The one large redeeming feature of such use is the fact that it would cost nothing beyond the oil itself, and entails no mechanical complications. A pump is practically a

necessity, but any car already so equipped may be changed over to an oil cooler in the length of time it takes to tell about it.

Natural or Thermo-Siphon Method of Cooling.—The thermo-siphon system of cooling depends for its action upon the fact that water when heated becomes lighter, and therefore in a large body of water the heated portion tends to rise or the cooler part to sink. Thus a change in temperature will cause internal action which, if carried far enough and with proper inlet and outlet pipes, will result in a continuous circuit—at least the circuit will be continuous as long as there is a source of heat. As indicative of the difference that the temperature makes, the table of relative volumes of water at different temperatures is given from maximum density to boiling point:

Temp. Fahr.	Volume.	Temp. Fahr.	Volume.
39.1	1.0000	122	1.0118
50	1.0003	149	1.0196
77	1.0029	176	1.0287
86	1.0043	194	1.0357
95	1.0059	203	1.0395
104	1.0077	212	1.0434

As a large difference in the temperature would be necessary to cause any considerable flow in a closed system, such as an automobile cooling system, the motor must necessarily be run rather hotter than the same motor and cooling system could be run with the water mechanically circulated. This is not only true, but the advocates of this method consider it an additional advantage of their system for the reason that a hotter motor is more efficient thermally and mechanically.

One very prominent advocate says that the engine is hotter when the water is boiling rapidly than when it is boiling slowly and it is a fact that because the water is absorbing more heat units proves not that the engine is cooler than before, but that it is doing harder work. It is certain that when the water is boiling very rapidly there is more difference in volume and more positive circulation than when it is boiling slowly.

Water Allowed to Boil and Steam Condensed.—The same authority goes on to say that he favors boiling water as the proper temperature and a gravity circulation as the proper method because this method insures a fixed temperature for the engine to work at. In this view he does not stand alone, for a prominent French house not only agrees, but has carried the principle still farther in practice. The Gillet-Forest system allows the jacket water to boil and produce steam. This is then condensed in the radiator. The cylinder jackets are kept filled by means of a float valve, which allows water to enter in such a quantity as to replace that turned into steam.

If the cooling medium is kept at any temperature below the boiling point this temperature will necessarily vary as the work varies. In the case of air-cooled engines this temperature will vary with the speed of the car, engine and the velocity of the wind. In the case of pump circulation, on the other hand, this will vary as the speed of the pump varies. With boiling water, however, this remains constant, permits of the finest adjustment of the mixture and the least amount of necessary variation in the point of most advantageous spark.

The rapid spread of this system in the past two years, previous to which it had but a couple of advocates, speaks volumes for the favorable results obtained. The very latest car announced, a small light car at a popular price, by one of France's most famous constructors, has used this system. While this particular case may only mean that the manufacturing cost on this specific model has been reduced as low as possible, its success on the light car will result in its adoption on larger models.

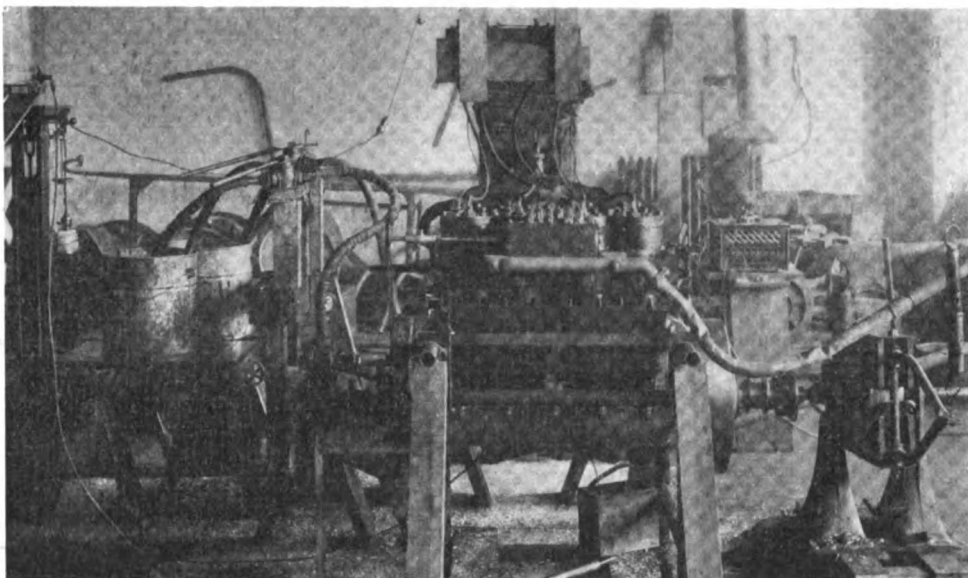

Fig. 20.—Oil testing apparatus ready for the test.

The direct cooling by means of air, forced or blown directly against the cylinder walls, which are increased in radiating power by the addition of fins, has many friends and, perhaps, many more enemies. The fact remains that it works and works continuously on several makes using this method. The French originally tried this way of cooling, and after testing it out, would have none of it. The fact is to-day that one would have to search France over pretty thoroughly to find a reputable manufacturer building air-cooled engines for cars only. That really proves nothing, but the fact that many American builders of that style of engine have been obliged to bring out a water-cooled model in addition, is good evidence of the attitude of the people toward it regardless of its theoretical or practical advantages.

NECESSITY IS THE MOTHER OF INVENTION.

INDIANAPOLIS, IND., April 5.—Necessity being the mother of invention, this fact is again illustrated in the accompanying photograph, which shows the expediency adopted by the Nordyke & Marmon Company to get a large Marmon landaulet through a low door into its salesrooms in Indianapolis.

The 36-inch wheels were removed and 18-inch wooden wheels, with cotton belt tires, were substituted, the car then being driven, by its own power, over pavements two squares, and into the building to its place. The large expanding brake shoes, 17 inches in diameter, had only ½ inch clearance.

The Marmon salesroom is a large, well lighted, finely appointed room in the new office building of the Central Union Telephone Company, corner of New York and Meridian streets. This location is to be permanent, and the company has also secured splendid quarters, within one-half block of the salesroom, for storage of demonstrating cars, and with every facility for the care and attention of the cars of Marmon customers.

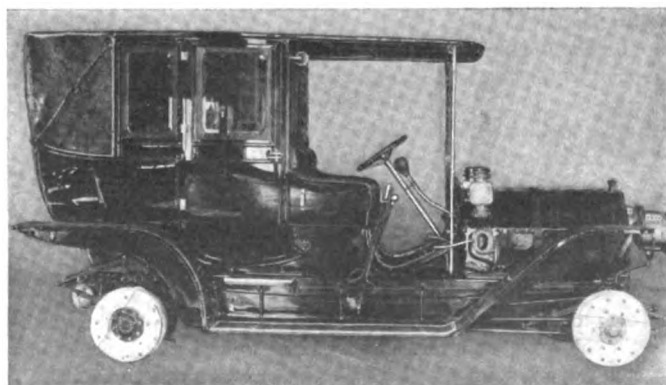

Wooden Wheels on Marmon that Passed It Through Low Door.

Some Aids in Proper Care of Tires

By Stillman Taylor

THE pneumatic tire is a very pertinent subject for discussion, and while much has been written upon the choice of size, proper inflation, and care of the "rubber tube," this subject is by no means generally given the careful attention it deserves. That the average owner and driver is very prone to treat with careless indifference this important detail of the car, is very apparent to any observer who is at all familiar with the subject. Why this should be so, is something of a mystery, when we consider the very large amount annually invested in tubes and shoes. Although it is an almost universal custom to lay the blame upon the manufacturer when anything happens *en tour*, it does not necessarily follow that the tires are defective. Indeed, the real source of trouble is far more likely to be found with the driver himself, and may be often directly traced to lack of proper care and abuse. The manufacture of pneumatic tires has long since passed out of the experimental stage, and a score or more concerns are to-day turning out tires that are as near mechanical perfection as the best materials and skilled labor can produce.

Common Causes of Rapid Wear.—While a tire may be injured in a variety of ways, the common causes of rapid wear may be said to be due to improper and insecure attachment, careless driving, and hard service. Any one or all of these things may contribute to shorten the life of the tire. Rim cutting, blowouts, and excessive tread wear are unmistakable evidence of careless driving and may be greatly lessened if not entirely avoided by proper care. Punctures and deterioration caused by chemical action or rotting of the fiber, may also be reduced to the minimum by taking certain precautions.

Selection of Tire Sizes Is Very Important.—That the owner may get the most mileage out of his tires, it is important that high grade tires of ample size be first selected. To equip a car with cheap tires is to invite trouble, which for very obvious reasons also applies if the tires are overloaded. A certain amount of reserve strength is necessary for servability, and unless an amply large size is selected for the work called upon to perform, much annoyance and expense may be expected.

Forty per cent. reserve strength may be calculated sufficient for average driving, but 50 per cent. will not be found wanting when a bad piece of roadway is encountered. It is much better to allow a bit extra than to start out handicapped and "under shod." As the rear wheels support some 75 per cent. of the total load, it is highly important that the driving wheels be provided with tires of generous size.

Too Free Use of Brakes.—A too free use of the brakes is perhaps the commonest source of tire wear. With the exception of those occasions when it is imperative to check the car as quickly as possible, the use of the brake should be dispensed with. Braking is greatly overdone by most drivers, and the habitual use of powerful hand brakes cannot but prove harmful to the tires, owing to the sliding of the wheels which ensues before the momentum of the car is overcome.

Learn to control the car's speed by the throttle and spark and prolong the life of the tires by closing the throttle, disengaging the clutch and allowing the car to coast to a stop. By all means avoid the nefarious practice of bringing the car to a stop by letting the tires rub against the curbing. This slipshod method cannot be too strongly condemned, inasmuch as it rapidly wears out the shoe, loosens up the tread and allows dirt and water to work in to rot the fabric. Driving in car tracks is bad practice, which brings undue wear.

How to Prevent Blowouts.—That bugbear of the autoist—the blowout—may be largely done away with by keeping the lugs screwed up tightly. This is necessary to prevent any side play of the shoe within its rim. Loose lugs not only per-

mit the tire to creep and roll out from the rim when rounding a curve, but the side play is often sufficient to completely shear off the valve stem. For the sake of safety, if for no other consideration, too much attention cannot be given to the tire fastening, and the lugs should be frequently examined and any looseness taken up, both before and after a run.

Rim cutting is generally caused either by overloading or lack of sufficient inflation. If the tires are called upon to carry a greater load than their dimensions are calculated to bear, no amount of pumping will keep them from flattening under the excessive load. This invariably results in the cracking and breaking down of the tire at its weakest point—where the flange engages the clinch. Badly fitting or misshapen rims are productive of the same ill effects as overloading.

Rusty rims are likewise to be avoided, and they should be occasionally gone over and cleaned of any rust that may have accumulated. A coat or two of enamel will often prevent further corrosion, or the rims may be given a coat of wax. This is the better method, and is the only satisfactory way of treating the rusty rims of an old car. To make a thorough job, the metal should be well scraped and sandpapered. The wax (preferably beeswax) should be heated and applied in a liquid state. The wax will not injure the rubber in the slightest, and by keeping out the air prevents further rusting of the metal.

The surface of the rim which comes in contact with the inner tube should be smooth. If rough, it is likely to wear and damage the tube, in which case the rim should be wrapped with a layer or two of tape, the loose ends being cemented in place. This tape may be obtained at any dry goods store.

Precautions to Be Taken After an Accident.—Excessive wear may be attributed to several things, as bad cuts, side slip, excessive braking, and speeding. Accidents are apt to occur to the most careful drivers, and upon such occasions the tire should be replaced at once. A small hole in the shoe will need no repair other than sealing up the aperture with rubber solution. This should be done before dirt and sand have a chance to work inside. In case a tire cannot be repaired on the road and an extra one is not at hand, it should be removed and the rim wound with three or four turns of rope, the ends being fastened to the spokes. Or if preferred, the tube may be removed and the casing filled with rope; this being accomplished by removing one side of the clinch and winding the rope around the circumference of the rim inside the casing. Care should be taken that there is enough clearance for inserting the flange in the clinch of the rim. This will give the requisite support and keep the casing from undue flattening and cracking of its retaining walls.

A convenient way for locating nonparallelism in the steering wheels is accomplished as follows: Turn the wheels in position for straight ahead running, and measure the distance between the front rims or tires. This measurement should be taken at the height of the hub and at the back of the wheel. Procure a stick and mark the spots between measurements. Now push the car forward until the front wheels make one-half a revolution, and take a second measurement at the same point (this will be at the front of the wheel, owing to the half turn forward). If the wheels are parallel, the two measurements should correspond. If there is a variation, the obvious remedy is to take up the lost motion in the parts.

Speeding Has a Very Destructive Effect.—Speeding is another cause of tire wear and the friction created by high speeds will often heat the metal rim uncomfortably hot for the hand to bear. A liberal use of talcum or soapstone will do much to prolong the life of the tire, acting as a kind of lubricant between the inner tube and casing.

Information for the Man Who Drives

EVERY once in so often, the exact time varying with the quality of the original finish and the conditions of use, it becomes necessary to have a car repainted, if it is to maintain a presentable appearance. Ordinarily such work should be entrusted only to an experienced carriage painter, but the excessive charge frequently assessed by such professional talent, often much greater in amount than is asked for an equivalent amount of work on horse vehicles, have caused more than one autoist, especially among the owners of the lower-priced cars, to essay the task without expert assistance.

In deciding to venture upon an amateur job of automobile painting, however, there are several points to be considered. First, it must be understood at the outset that it is not practicable to undertake a high-class coach finish for a number of reasons. Such work requires a great deal of time, not merely in applying the paint and varnish, but in waiting for the various coats to dry and in rubbing them down with polishing materials. The amateur will be wise to satisfy himself with one of the many excellent prepared paints, with the varnish admixed, such as are sold for painting wagons and carriages. These are obtainable in everything but the gray automobile finishes, go on smoothly and dry quickly. It is particularly important that only the best qualities be used, and the highest price that it is possible to pay is a good guide to quality, as well as being economy in the end, because of the superior quality of the high-priced paints. Brushes, too, must be of the very best, since any others will shed bristles on the work and ruin it. No paint with linseed oil in it is to be used, because of the tendency of this oil to cause cracking. If the paint requires thinning, use pure turpentine. Two coats of the right sort of paint should be sufficient.

Of the utmost importance is the preparation of the surface for painting. The least preparation that can be tolerated is to sand-paper down the old paint, evening off all rough edges, and following this by removal of all grease with kerosene and gasoline. Better than this, however, is to remove all paint, which can be most easily and quickly done by some of the chemical preparations sold by the paint manufacturers, thus avoiding the laborious methods of burning and scraping, or the injurious use of lye compounds. The preparations referred to are applied with a brush, and in a few minutes the paint swells, loosens and comes off, a second application hastening the operation.

Striping is a work that ordinarily will justify the employment of an expert carriage painter for a half day, though a man with a steady hand and some preliminary practice, or with the simple striping machines now on the market, will find it surprisingly easy to achieve a very fair result.

Use for Railway Air Hose.—It is not widely advertised by the railway companies, but it is no less a fact that the air hose used to connect the air-brakes and train signal systems of adjacent cars can be made to constitute an excellent substitute for an unserviceable water connection on almost any standard automobile. As is extensively known, these connections generally are made of large-size rubber hose, and are given to leakage and wear as a result of prolonged use. A Western motorist recently found a section of such hose from a freight car that stood on a siding, the solution of a serious dilemma, which might have resulted in a long walk and then a delay for shipment of large enough hose, had not the railroad company thoughtfully provided the cure for his difficulty in the manner stated.

Consideration for the crew of the way freight will dictate that the required few inches of hose be cut not from the middle but from one end of the air connection, thus leaving it possible still to utilize what is left. For the same reason, if more than one

connection is required, the different pieces should be cut from different cars, so as not to shorten the quota of any one unduly. And, of course, the honesty of the average autoist will suggest that the railroad be remunerated by a check, or, better, an anonymous contribution, forwarded to the proper officials.

Adjusting Truss Rods.—With standard types of shaft-driven autos, the normal straightness of the rear axle is, in most cases, maintained by a truss rod, pinned at its ends to the axle tube, bowed at its center by the bevel-gear housing and made adjustable for length by a turnbuckle.

It is inevitable that from time to time such an axle will require readjustment, no matter how well it may be designed or constructed. The long-continued terrific hammering over road inequalities, whether or not it is accompanied by slight wear of the pins and eyes, and at the point of contact with the bevel-gear housing, is almost certain to sag the axle to a greater or lesser extent at the center. On the other hand, contact with a rock or other obstacle in the road may bend the truss rod, thus shortening

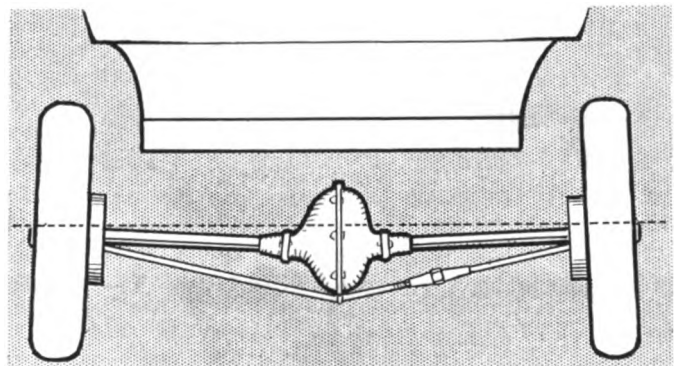

Showing Simple Method of Straightening Axle.

it and throwing the center of the axle up. Either deviation from a straight line is apt to be attended with disastrous consequences—loosening and wear of the rivets by which the axle tubes are held into the housing, wear and breakdown of the floating-axle members, or cutting of the bevel and differential gear teeth.

Bad as it is to run an axle that has become slightly out of line from either of the causes mentioned, a greater danger exists in the frequent ill-advised methods that are employed to effect readjustment, and which often result in a worse condition.

The proper way to secure a correct adjustment is to sight a board or other straight edge against the axle, as shown in the accompanying sketch, thus making it impossible to leave the axle out of true as the result of working the turnbuckle. It is to be noted that the turnbuckle invariably is provided with a lock nut, which must be loosened before adjustment is attempted and set tightly up when it is completed. Beginning with a new car, as the truss rod is adjusted now and again it will come to need adjustment less and less often, unless because of accident, the metal seeming to stretch to a natural limit.

Grinding Fixture for Vibrator Contacts.—In the maintenance of a car equipped with a jump-spark ignition system involving the use of vibrator coils, it becomes very important from time to time that the vibrator contacts be reground to remove the pittings and inequalities occasioned by the unavoidable slight arcing between them. With platinum-iridium contacts of the best quality, the effect of such arcing is reduced to a minimum, but with contacts of poorer quality, it requires frequent atten-

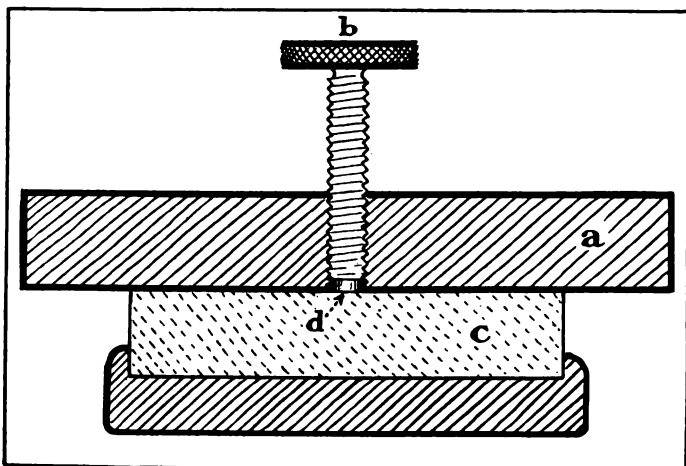

Section Fixture for Grinding Vibrator Contacts.

tion. In any case the problem of securing a perfectly flat and even facing off of the small circular faces of the contact points is one that will trouble the average autoist considerably, as, indeed, it troubles many a very fair machinist. A simple solution of the problem, however, is the use of a grinding fixture approximating the lines of the accompanying sketch, in which (a) is a flat metal plate perforated with a threaded hole for the reception of the trembler adjusting screw; (b) bearing the contact at its point, and (c) is an oil stone for effecting the resurfacing. With this device, the finest possible adjustment can be had of the amount of metal removed, while at the same time the new surface is kept at exact right angles to the axis of the screw.

THOMAS TEST SHOWS EXCELLENT RESULTS.

LAFAYETTE, IND., April 5.—A recent unofficial test of a big Thomas car was made at Purdue University to satisfy the owner's curiosity as to what it would do on the testing stand. The car was a 1909 model 4-60 Thomas Flyer, rated by the manufacturers at 53-horsepower. The motor has a bore of 5-3/4 inches and a stroke of 5 1/2 inches. On the testing stand the drawbar pull, speed and horsepower delivered at the wheels were measured each time and a large number of readings were taken. That is, at certain fixed drawbar weights the speed and power were measured. A few of these readings taken at random are given, these being selected so as to show the possible variation in power with the speed:

Drawbar pull in lbs.	Max. speed in M.P.H.	Horsepower at Wheels.
150	82	32
250	53	36
300	48	38.5
On the second gear, the above being on direct drive		
660	24	41
On the first or low gear		
1,050	13.2	36

The car was geared down 2.23 to 1. The greatest power was developed on the second, which is intended as the hill climbing speed. This was 78 per cent. of the A. L. A. M. rating, a very high rate of efficiency.

After the test the owner, A. L. Sheridan, expressed himself as very well satisfied with the car's performance. No special preparation was made; the car was simply driven over to the laboratory and tested, so that the results here given are not exceptional.

AUTOMOBILE STATISTICS FROM AUSTRALIA.

Consul-General John P. Bray, of Sydney, transmits the following detailed information relative to the importation of motor vehicles into Australia:

According to a customs return recently issued, 3,559 motor vehicles were imported into Australia from 1901 to 1907. Of this total, 1,175 went to New South Wales, 1,436 to Victoria, 132 to Queensland, 496 to South Australia, 224 to Western Australia and 96 to Tasmania. The total import value of these vehicles was \$3,392,125, and the duty paid on them amounted to \$701,105.

Of the total number of automobiles imported during the years stated, no less than 398 were imported from the United States. In the year 1903 the United States sent to Australia 71 automobiles, valued at \$35,262; in 1904, 161, valued at \$75,586; in 1905, 122, valued at \$63,799, and in 1906, 44, valued at \$37,841. The figures for 1907 are not yet complete, nor is it possible to get the figures for the first three quarters of 1908.

Bodies for automobiles, motor trucks and wagons, valued at \$135,011, were imported during the same period, the duty amounting to \$45,954. There were further imported during the nine months under review chassis for automobiles, motor trucks and wagons of a total value of \$933,394, and the duty upon these amounted to the total sum of \$22,439.

A NEW ONE IN CLUTCHES.

Anyone who has ever heard the taxicabbies mesh gears will appreciate to the fullest extent any device designed to ensure easy or gradual clutch releasing. The newest idea in the clutch line comes from Morris Ireland, of New York City, and his invention relates to a clutch between two shafts, which automatically releases upon a predetermined load being applied to the driven shaft whereby damage may be prevented.

More particularly it relates to an automobile clutch in which the road shocks are not transmitted to the engine when the clutch is engaged, and the breaking of the gears in changing speed and reversing as well as in starting is prevented. For instance, the driver frequently attempts to start upon too high a gear, which strains the gears, slips the wheels with damage to the tires, or overloads the engine. By means of this invention, in case the vehicle is started at too high a speed, the engagement is automatically released to such an extent as to permit a certain amount of slip between the driving and driven shaft, and thereby the vehicle starts slowly and without straining. The clutch being engaged, it will be seen that the driving torque tends to revolve the clutch cone on the worm backwards and the big spring opposes this force, thus tending to balance it and permit the small spring to hold the clutch in engagement. If the backward component exceeds the forward component the clutch member will be rotated on the sleeve, causing it to screw through the clutch cone until the operating collar has drawn the lever against the set screw, which causes all movement to stop. When this has taken place the clutch member will rotate backwards along sleeve away from clutch, thus causing disengagement. It can thus be seen that the clutch disengages gently as well as engages gently, which is an important advantage of this invention. The adjusting screw allows of a variation in the spring tension, which may be experimented with until the clutch "floats" on the shaft.

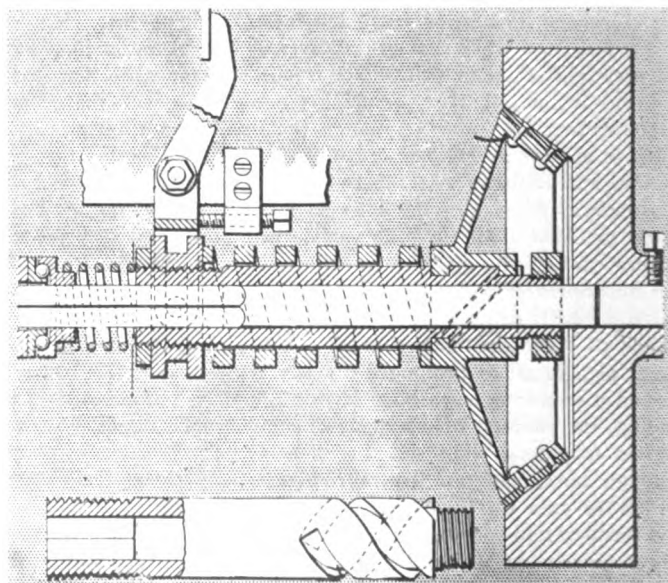

Section View of the Ireland Easy Release Clutch.

Letters Interesting and Instructive

FLAT-SEAT VALVE ADVANTAGE.

Editor THE AUTOMOBILE:
[1,817.]—Please advise me through "Letters Interesting and Instructive," what are the advantages and disadvantages of square seated valves. I understand that a square seated valve is now being used exclusively on a number of the highest grade imported cars.
CHARLES J. CHABOT.
Dallas, Texas.

The statement that these valves are used on a number of imported cars is subject to proof, as is also any statement of the advantages. In both types the volume of the opening is equal to the circumference of the effective opening times the

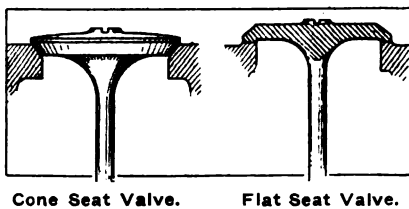

sine of the angle of the valve seat times the lift. In the flat seat construction this angle is 90 degrees and the sine is 1. With the taper seat the angle is usually 45 degrees and the sine is .707. From this it is seen that for the same effective opening and lift the flat seat gives a larger volume of gas than the cone seat in the ratio of 1 to .707. This is utilized by reducing the lift in the same ratio, which ought to give a more quiet action. Users of this type of valve claim that the form reduces the amount of corrosion, and therefore the re-grinding necessary.

IN RE MAGNETO WINDINGS.

Editor THE AUTOMOBILE:
[1,818.]—Please tell me through "Letters Interesting and Instructive" how to calculate the size and number of turns of wire for a magneto such as the W. & S. to give an amperage and voltage great enough to run an ordinary spark coil as used on automobiles, the magneto to run three times the normal motor speed. Also, please tell me the voltage and amperage necessary to run an automobile spark coil.
L. E. B.
Chicago, Ill.

(a) The electromotive force impressed in the secondary circuit of a spark system may be as high as 30,000 volts.

(b) The current in amperes, at this high voltage is probably very slight. If the source of supply will afford 50 watts, the current will then be $50/30,000 = 0.0016 =$ current in amperes.

(c) If the secondary conditions are as above stated, it is then possible to say if the primary circuit will hold to a slightly higher wattage, in view of the losses in the coils, and if 60 watts is taken as the primary value, the same rule will work to find the current, i.e.:

$$60/5 = 12 \text{ amperes.}$$

(d) In the above, if the measurements are taken, as for an alternating current in

one case, the same measurements must hold for all, and in view of the irregular shape of the waves of electromotive force, it will be understood that there can be much uncertainty to contend with.

(e) The primary current in amperes, as given, looks a little high, but it will be remembered that this does not mean 12 amperes out of the battery, which gives a direct current, and there is a correction to be made which might bring the direct current down to about 8 amperes, on a basis of 5 volts, electromotive force.

(f) The calculation of the windings of a magneto must take into account the design of the magnetic circuit, which would take much more space than can be given in the "Letters," but it is proposed to publish an article on this subject within a few weeks. In the meantime if you can use the formula of the electromagnetic induction class, it will be possible to make some headway through the use of the same, which is given as follows:

Considering a rotor of a dynamo electro machine, of which the magneto is a type, the formulæ, in a general way, may be written:

$$E = \frac{t s \theta}{10^8} \dots \dots \dots (1)$$

$$t = \frac{10^8 E}{s \theta} \dots \dots \dots (2)$$

$$s = \frac{t \theta}{10^8 E} \dots \dots \dots (3)$$

$$\theta = \frac{10^8 E}{s t} \dots \dots \dots (4)$$

When,
E = Electromotive force in volts;
t = Turns of wire on the rotor;
s = Speed of the rotor in revolutions per second;
 θ = Total of the magnetic flux, passing across one air gap between the rotor and the polar face.

From the electromotive force as found above the drop in volts in the windings must be deduced, and the balance will be available for useful work. In a magneto, it is probable that fully one-half of the impressed voltage in the windings of the rotor will be lost, due to the resistance of the wire used in winding the same. The problem is one in which it is the aim to wind as many turns as possible, of the wire of the least possible resistance in ohms, taking into account the greatest possible speed of the rotor, and the highest attainable flux (magnetic) density in the airgap. Consult a table of double cotton covered copper magnet wire, to determine space required for the windings.

GASOLINE MILEAGE RECORD.

Editor THE AUTOMOBILE:
[1,819.]—Please advise me what car holds the record for the greatest mileage on one gallon of gasoline and what the record is?
San Antonio, Texas. C. H. DEAN.

In the two-gallon efficiency contest held in New York City May 5, 1906, a Franklin 16-horsepower car carrying two passengers made 87 miles, which is 43.5 miles per gallon. The system of figuring adopted gave the Franklin first place, while second went to a Frayer-Miller car with five passengers, which covered 47.9 miles, an average of 23.95 miles per gallon. If, on the other hand, the award had been based on the number of ton-miles or passenger-miles, first place would have gone to the Mack observation car, which carried 19 people 17.13 miles. This works out 8.56 miles per gallon, but the passenger-miles per gallon would be 171.3, against 119.75 for the Frayer-Miller and 87 for the Franklin. The ton-mileage per gallon was 39.94 for Mack, 39.16 for Frayer-Miller and 32.62 for Franklin.

Your question brought out the point that mileage alone is not the only desirable feature, and we have gone into this at some length to prove that point. To our knowledge, no similar contest has ever been held, nor have these figures been exceeded.

STANDARDIZATION OF PARTS.

Editor THE AUTOMOBILE:
[1,820.]—It has been stated that the Licensed Association has done a great deal of standardizing of automobile parts. Will you please tell me just what they have done in this line.
Port Jervis, Pa. H. A. MORRIS.

The association has made only a small start toward standardization thus far, but it hopes to do more in the future. In fact, aside from the yoke ends, which were standardized as a matter of getting lower prices on forgings, screw threads, nuts, bolts and screws, little or nothing has been done towards the really important matters of standard wheels, axles, control parts, etc. As for the fine-screw threads, this really is a complication, for there previously were accepted standards, and the one added in no way conformed to those. Of all the subjects worthy of investigation, prior to standardization, no one is more meritorious than the control. Any man who has ever driven in a strange car will appreciate the full force of this. What was the spark advance before is now the retard, the reverse is actuated by the movement which formerly threw in the low speed, and many other inversions which are sure to be a source of trouble.

Some work has been done towards standardizing spark plugs, but the new standard created much trouble in that it was different from all previous sizes. A little

work has been done on wheels and rims, while the engine rating formula was a help, but the real big problems of standardization have not been touched as yet.

TO FIGURE RADIATOR SURFACE.

Editor THE AUTOMOBILE:

[1,821.]—Will you kindly tell me how to figure the radiating surface for an automobile engine, using the tubular form of radiator?

Pottstown, Pa.

G. S. H.

A very good empirical rule for this is: multiply the bore by the stroke, times the number of cylinders, and the result will be the number of feet of length of 3-4-inch tubing necessary. To use 5-8-inch tubing, add 1-5; for 1-2-inch tubes, add 1-2; while for 3-8-inch tubes, it will be necessary to double the original figures, and for 1-4-inch size, to triple them.

All this is for tubes spaced three times the diameter apart, and not more than five tubes deep.

So, if you want to figure for a 4 1-2 by 5, four-cylinder engine, you will multiply $4 \frac{1}{2} \times 5 \times 4 = 90$ feet of 3-4-inch tubing. Then to use 3-8-inch size, multiply by two, giving you 180 feet. By the rule you are limited to 1 1-4 inches center to center. If your space restricts you to, say, 18 inches high, that will allow of 14 spaces, or 15 tubes. For five tubes deep, the limit by the rule, this would give a total of 75 tubes. To have 180 feet of length with 75, you must have them $180/75 = 2$ feet 5 inches long. If your car will not allow this length, you must use a larger sized tube.

SERIES MULTIPLE ADVANTAGES.

Editor THE AUTOMOBILE:

[1,822.]—In a recent issue of your magazine, The Automobile, was an article advocating the use of batteries in series multiple for purposes of economy. Will you please advise me whether the coupling of a series of new batteries with a series of partly used batteries will cause deterioration in the new ones, and if so, whether the used batteries will appreciate in the same proportion as the fresh ones deteriorate?

New York City.

E. C. D.

The writer of this paper made the point, as you will notice if you read it again, that the other cells will build up one dead one in discharging through it, with no appreciable losses. If this takes place in one series, why would not the same thing take place with a weak series connected in series multiple? Reasoning forward from this, it is apparent that partly used cells could be used with new ones without excessive depreciation on the part of the latter.

KNIGHT MOTOR AGAIN.

Editor THE AUTOMOBILE:

[1,823.]—I have heard considerable about a new engine called the Knight. Can you tell me anything about it and where I may obtain a good description of it?

Charlestown, W. Va.

J. H. DONOVAN.

The Knight engine has the ordinary valves replaced by two sliding sleeves. This was described very fully in THE AUTOMOBILE for October 22, 1908, on pages 572-573. In this week's issue is given a description of a French two-cycle motor with a sleeve in place of valves on the same principle as the Knight.

EXHAUST GAS AND RUBBER.

Editor THE AUTOMOBILE:

[1,824.]—Please advise what is the effect on rubber tires, and what would be the result of using the gas from the exhaust for inflating tires by means of such a contrivance as mentioned in your issue of March 25 under the name of "Maxim Tire Inflation Apparatus."

Zanesville, O.

J. B. MORRIS.

The principal constituents of the exhaust gases are carbonic oxide, whose presence indicates incomplete combustion, carbon dioxide, and nitrogen. It is thought that both of the former have a bad effect on rubber, although this has never been proven. If this is not so, the use of the gases for tire inflation would have no injurious effect. That this is the case may be inferred from the fact that some of the tire companies are putting out tanks of compressed carbonic acid gas for this purpose. The other components of the exhaust vary, and some of those occasionally present have a bad effect on tires or any form of rubber. Thus, oxygen is sometimes present and rots rubber. The hydrocarbons, when on hand, act just as does any oil. Others have no bad effect on the fabric, but readily pass through it, so that they only temporarily inflate the tire.

POWDER PREVENTS FRICTION.

Editor THE AUTOMOBILE:

[1,825.]—Is there any way in which the heating of tires can be prevented or lessened, particularly on long runs? I have often worried about this, for on long Summer tours my tires would get so hot that they were uncomfortable to the hand.

Portland, Ohio.

A. B. SEE.

This cannot be wholly prevented, but can be lessened very materially by introducing some antifriction powder between the shoe and the inner tube before starting on a long run. Then, in case you have to stop with a puncture, it is a good idea to put in more powder. Some use ground talc, known as talcum powder. Others get a stick of soapstone and rub it over the shoe or tube, or both. There is mention in this issue of a new form of powder for this purpose which is neither talc nor soapstone. Be sure never to use oil, which attacks rubber.

NAPHTHALENE AS CAR FUEL.

Editor THE AUTOMOBILE:

[1,826.]—I read in your editorial, "Fuel Economy Is a Live Topic," in the March 25 issue with a great deal of interest, especially since I have been endeavoring for some time to run my engine more economically. Your figures, 62 per cent, are startling; but do you consider naphthalene blocks adaptable for use on a pleasure car? I have been laboring under the impression that gasoline was the ideal, as well as the most available, fuel for this purpose, and I would appreciate some advice through your "Letters Instructive" department.

New York City.

J. L. HERTRAIS.

Naphthalene blocks are fully as applicable to touring cars as to trucks. In the case of the latter, however, economy is the keynote of all truck installations and, consequently, must be of their operation. To sell a truck at all you must first convince the man that it will save money.

The plan might well be worth a trial, but you must remember that gasoline will still be necessary for starting purposes. Gasoline

is a good fuel, but the supply is decreasing in the face of an enormous increase in the number of consumers. This will necessitate the use, in the near future, of some other fuel, primarily not quite as good.

HONEYCOMB RADIATOR AREA.

Editor THE AUTOMOBILE:

[1,827.]—Please advise me what area of air space per square foot of frontal area I should get in buying a high grade honeycomb radiator, and how this figure is arrived at?

Pittsburg, Pa.

JOHN R. DAVIDSON.

As to the figures you request, 9,000 square inches should be the minimum for a really high-grade cooler. This is figured as follows: inside circumference of tubes times the number of tubes, times the depth of the radiator, which is really the length of the tubes. This will give the total air space area. Now figure the frontal area of the radiator and divide the total air area in inches by the total radiator area in feet and the result will be the air surface per square foot of frontal area. With a square tube, the method is the same, but the length of the square plus the depth times two will replace the circumference in the case given above. If the sides of the tube are corrugated, the length of the corrugated line will have to be figured accurately.

REACTIONS OF ACETYLENE.

Editor THE AUTOMOBILE:

[1,828.]—Please advise what chemical reactions occur when pure compressed acetylene gas explodes from concussion, without the presence of oxygen? What fluid is used in acetylene gas tanks to absorb the gas, which I believe is not a trade secret? What is the essential chemical used in the various decarbonizers? Carbon is usually considered as insoluble, is it not? If so, it would seem as if the action of a decarbonizer was merely the breaking down or dissolving of the binding agent between the particles of carbon and the metal, and then mechanically blowing out these particles. Is this so?

La Salle, Ill.

V. A. MATHESON.

The first named reaction is impossible. Although acetylene is regarded as unstable it cannot change its chemical composition without some other element to combine with, as it cannot of itself break down. The formula for acetylene is C_2H_2 , and when it combines with air or burns the reaction is expressed as follows:

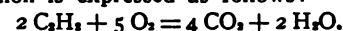

The usual solvent for the compressed gas is acetone or pyroacetic acid, which has the chemical formula $3 (CH_3) O$. Your understanding of the action of decarbonizers is correct.

PATCHING CELLULOID.

Editor THE AUTOMOBILE:

[1,829.]—Some time ago I noticed in Letters Interesting and Instructive a recipe for patching the celluloid windows in an automobile cape top. But now on wanting the recipe, I cannot find it. Will you kindly give it to me?

Ludington, Mich.

M. E. CARTIER.

We do not find the recipe in question, but as acetone is a solvent for celluloid, get a little of that and apply it just as you would any cement.

FRENCH ROTATING SLEEVE TWO-CYCLE MOTOR

THE Ledru two-cycle motor was brought out some time ago, but the excitement incident to the introduction and use of the Knight motor has again drawn attention to it, says Louis Lacoïn in *Omnia*. This motor has no valves but just as the Knight has two sliding sleeves, which take their place, so too, this has a single sleeve which replaces valves. There is this difference, however; in the Knight motor the sleeves reciprocate as the piston does and are driven off of the camshaft by a pair of eccentrics, while in the Ledru engine, the single sleeve rotates, being driven by a worm on a special shaft.

The figure shows a section through the cylinder and exhaust pipe, the inlet not being shown. *A* is the piston driving through the connecting rod *K*, the crankshaft *Q*, of which the center of rotation is at *P*, the split in the crankcase *R*. Upon the crankshaft is mounted a gear *F*, meshing with the gear *E*. The shaft which carries the latter also has a worm *D*. This drives the worm gear *C* which is fixed to the sleeve *B*. In this manner the proper speed of rotation (which in this case is a reduction) is obtained, as is also the rotative motion itself. This rotating sleeve has at its upper end a series of three slots or ports which the turning motion brings successively to register with the inlet and outlet, the latter being shown at *H*. These ports are marked *G* in the figure.

A series of circumferential grooves *M* and longitudinal grooves *N* are used to retain the tightness, no rings being provided. Near the top of the sleeve, and running from each slot to the top as well as some distance below, are cuts, marked *L* in the illustration. To reduce the friction to a minimum, the walls are cut away or relieved up to the immediate region of the inlet and outlet. To go farther would be to endanger the gas tightness which is questionable even with the construction shown. The engine is water jacketed, and the head of this presents a depression very similar to the Knight engine.

In operation the sleeve carrying the three equidistant ports must turn during a complete cycle of the motor through such an angle as will bring one of the ports at the end of the stroke to the place occupied by the port immediately before it. This being the case, it must turn six times more slowly than the crankshaft, a cycle corresponding to two turns. If, then, the motor runs at 600 revolutions per minute, the sleeve must run 100 r.p.m.

The position, size and spacing of the ports together with the speed of the sleeve are such as to follow any predetermined timing. In this way is attained a result never before reached in a two-cycle engine.

Lubrication and cooling seem to offer no difficulties, although in the problem of gas-tightness is a source of real trouble, perhaps the only one, of any consequence. This marks the only real apparent advantage of the Knight over the engine in question, the gas-tightness of the former being beyond question. As to the friction of the rotating sleeve, the point is made that this

is less than it would be with the same sized sleeve reciprocating, because the unit pressure is the same in both cases, while the surface must be greater with the sliding sleeve. It is also apparent that the power consumed, aside from friction, is less, be-

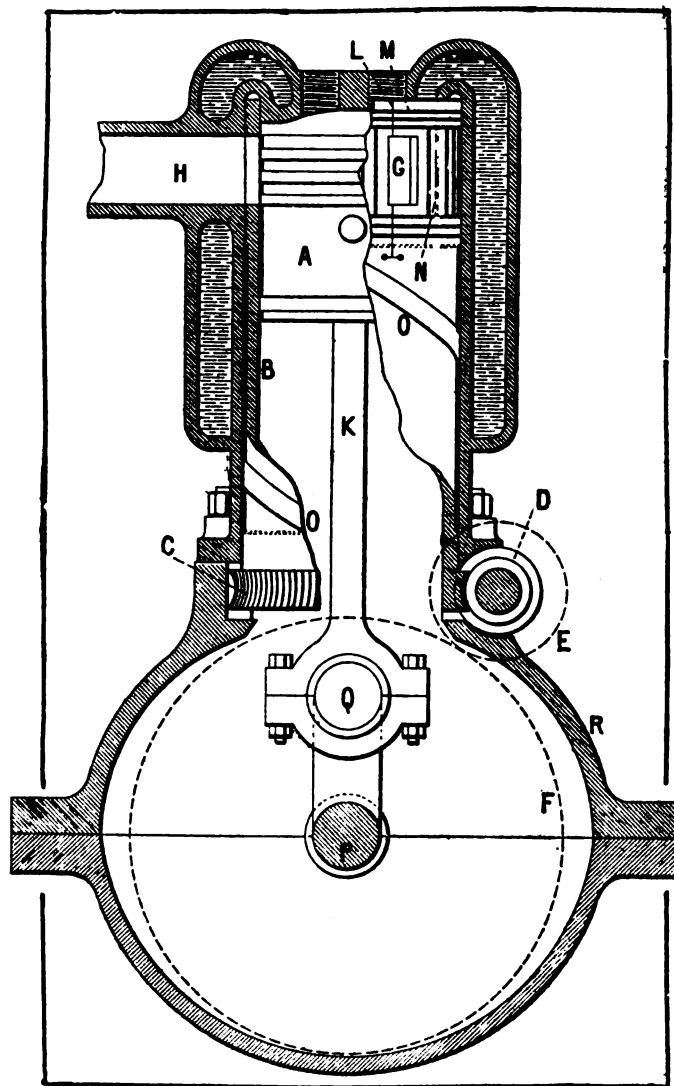

Section Through Ledru Motor Showing Sleeve.

cause the weight of the sliding part is not started and stopped with every revolution. This is an entirely new and original idea which seems to possess much merit. The whole story can only be told by thorough practical experience.

At the annual general meeting of the Imperial Automobile Club of Germany, it was announced that at the commencement of the year the club possessed 42 honorary, 12 life, 1,240 ordinary, 51 women, and 349 extraordinary members. The expenditures amounted to \$89,460, the income to \$89,831, only leaving a sum of \$371 to be carried over. This small sum, compared with \$31,295 in the previous year, is due to the non-holding of a motor show in 1908. The club issued 5,200 triptyques for the United States, France, the Netherlands, Austro-Hungary, Italy, and Switzerland, nearly 2,000 more than in 1908, while up to now 2,318 danger boards have been distributed among the affiliated clubs at a cost of about \$525. It was also announced that the club is interested in the "Automobile Traffic and Training Roads, Ltd.," to the tune of about \$60,000.

The three-point handicap in the Prince Henry Tour regulations has been protested by several of the big South German clubs, and the Society of German Motor Manufacturers and Traders has also stated its disapproval of so sweeping an embargo, which will keep a number of experienced amateurs away from the start. As the propositions have been, however, out for so long, the Society thinks it best not to absolutely upset the race by a protest, but there will be an alteration in next year's race, the third and last of its kind.

Krupps of Essen, the great German firm of gunmakers, have just concluded a series of tests with a gun destined to burst balloons. The trials ended most satisfactorily. They are also building a new repeating gun to be fitted into an airship.

TOURS FOR REAL TOURISTS CERTAIN OF POPULARITY

By W. C. MARMON.

WITH the passing of Winter and its blizzards, bad roads, high winds and other inconveniences that make touring anything but ideal, and with the incoming of Spring, bringing numerous pleasures to the automobilist, naturally the car owners' thoughts are centered on the various tours and race meets which will be held during the warm Summer months.

That 1909 is to be a banner year for the automobile industry, not only from a manufacturing standpoint, but from one of pleasure, sport and pastime, has been evidenced by the shows. Manufacturers are exerting every effort to meet the heavy demand made on them by the dealers. Dealers are being practically deluged with rush orders from the buyer; and the mails and telegraph and telephone wires are burdened with messages begging for earlier shipments and asking for additional consignments.

"There will be a shortage of cars," is the statement daily heard along "automobile rows" of the big cities. Manufacturers were unprepared for any such great demand for cars as has been the case since the American Motor Car Manufacturers' Association started the first of this year's shows in the Grand Central Palace in January. The other big shows which followed the Grand Central Palace affair have added to the makers' burden of keeping pace with the demand.

All this means that there will be thousands of new owners, and as new blood and new enthusiasm become mingled with the old, there is bound to be more individual touring and more interest and a larger list of entries in the competitive events.

It would appear that 1909 will see a record-breaking number of tours of all classes, but instead of having all tours of a com-

petitive nature, with set schedules and long daily runs, why not have national tours similar to that held last Summer through fascinating New England by the Automobile Club of America?

Such enjoyable tours as these would create a great deal of interest. There is no question but what there are many owners who believe in and would enter such tours and who do not care to participate in a more strenuous contest such as the Glidden Tour. A tour running without schedule, in other words, a go-

as-you-please event, would arouse interest, especially with women and children. It would arouse interest in the territories through which the great caravan of cars passed.

While such a tour would not necessarily demonstrate the good and bad points of a car for the benefit of the manufacturer, such as is the case in the Glidden, it would demonstrate to the buying public and prospective buyers that the present day car can travel under regular touring conditions over all manner of roads.

If such events are held it would mean that the entrant could stop whenever and wherever he liked, could eat his lunch in the shade of stalwart trees or in a hotel. It would mean that women and children would not become

tired out with the day's journey, and that the country and scenery could be better enjoyed than if the car was traveling under schedule and had to arrive at controls at a given time. The elimination of penalizations would leave the mind of the drivers and passengers free to enjoy every bit of the journey.

Many members of the American Motor Car Manufacturers' Association are in sympathy with such tours, and believe that they would instill into the entrants a firmer belief in the automobile and the joys of touring would be better exemplified.



Picturesque Fremont Pass in Southern California.

This noted mountain pass in the San Bernardino Range is 28 miles from Los Angeles, at an altitude of 1,770 feet above sea level. The grade of the road is 45 per cent. and the sides of the walls of the pass are 70 feet high.

INCREASE IN EXPORTS OF AMERICAN AUTOS.

WASHINGTON, D. C., April 5.—In the monthly summary of the Department of Commerce and Labor, published for the month of February of this year, an increase in the number of automobiles exported is noted, while at the same time there has been a decrease of the amount of imports over that done in the same month of the previous year. In the matter of imports there were 59 automobiles brought into this country last February, as against 79 in 1908, the total value decreasing by \$34,610, the figures being: 1909, \$128,190; 1908, \$162,800. The average for the month of this year is \$2,172.71 per car. Of the countries sending cars to the United States, France leads with 33, Italy is second with 13, Germany third with 12, and England is represented by 1. There were no other nations on the list, and this is true also of the month of February, 1908. The falling off is shown by the statistics for last year: France 60, Italy 15, Germany 3, and again England 1. There has been an increase, however, in the importations of parts for foreign automobiles, the figures being: 1909, \$61,579; 1908, \$36,173.

American-built automobiles to the number of 208 were shipped out of this country during the month of February, an increase

of 57 over those sent away in that month of last year, and the average value of this year's product was \$1,668.11. The total value was \$346,967, as against \$301,240, but there were less spare parts needed by American cars this year than last, as shown by a falling off of the value of these by \$2,285, the amount sent out this year being valued at \$44,839, or \$16,740 less than the amount of foreign parts imported. Of the exportation, British North America took by far the largest part, nearly one-third of the total going to Canada. This is the way in which the various countries, leading in the importation of American cars, stood last year: England, Italy, British North America, France, other European countries, West Indies, Mexico, and smaller ones. The change in the standing for 1909 is shown thus: British North America, England, Italy, West Indies and Bermuda, Mexico, France, South America, other European countries.

As far as numbers of cars are concerned there was no change in the exportation of foreign cars between the two months, both registering four, but there was an appreciable difference in the value, for in the recent February the total value was \$20,009, as compared with \$14,100 for 1908.

AIDS IN THE EXPORTATION OF AMERICAN AUTOS

THOUGH many American automobile manufacturers are at present unable to supply the demand for their product in this country, yet there are concerns looking forward to a time when perhaps there will be a lessened demand here, and these have gone into foreign fields. The United States consular service has been instructed to report frequently upon the conditions in the various countries as to the opportunities for the sale of American automobiles, and the following reports may be found of interest and advantage in building an export trade.

Good Car Demanded by Natives of Bombay.

Consul E. Haldeman Dennison, of Bombay, makes the following suggestions relative to the introduction of American motor cars into India:

The American automobile is little known in India, and still has to prove itself the equal of the Continental makes used. There are now 1,000 cars registered in Bombay, and not one of these is of American make, with the exception of a few "cripples," the remains of a lot of cheap runabouts which were dumped on this market some years ago. This market is well worth the best efforts of American manufacturers and exporters. Among the well-to-do natives the automobile has become popular, and the Continental manufacturers have been reaping a rich harvest from the ever-expanding trade. The native as a rule is unfamiliar with machinery and desires a car that is going to give him the least trouble possible. He is quite willing to pay a good price for a superior machine, and American exporters would do well, when they really determine to exploit this market, to introduce only their best machines.

There is only one road in India that approaches the standard of those in Europe and that is the "trunk line" between Bombay and Calcutta. This would seem to give the American car some advantage, as it is built to negotiate even the roughest sort of roads. Until American manufacturers are ready to expend considerable time and money in developing their trade they might as well not attempt to enter this market, as the writing of letters and sending of catalogues is a waste of time.

America Not Represented Among Many Cars in Burma.

In stating that there are nearly 150 motor cars in Rangoon and probably 50 more at other places in Burma, Consul E. A. Wakefield gives the following trade particulars:

These cars are, with a few exceptions, made in England, selling at prices varying from \$500 to \$4,000. One French car cost \$8,000. A few years ago an American one-cylinder car was sold in India, which gave very poor satisfaction. To-day there are no American cars sold in the province of Burma and to successfully reintroduce them it would undoubtedly be necessary to practically demonstrate their serviceability and durability in a most thorough manner.

It is very questionable if American manufacturers could sell a car here without having the machine on the spot to be thoroughly tested. One car in successful operation would be worth more here than all the correspondence and advertising matter they could send. The roads in and near Rangoon are excellent for touring, so that the number of cars in use is steadily increasing. This is true of Mandalay, Moulmein and Bassein to a more limited extent. If an American manufacturer could secure a Rangoon firm of unquestioned reliability to act as his Burma agent it should be easy to secure a foothold which would lead to a continually increasing business. [A number of Rangoon firms which might represent automobile builders are listed at the Bureau of Manufactures.]

Large Field for Hill Climbers in Portugal.

Vice-Consul-General Charles F. La Serre, of Lisbon, has the following to say about the introduction of American automobiles in Portugal:

There are in Portugal about 1,200 automobiles. Nearly 600 of these are registered at the Governo Civil of Lisbon. Lisbon is a city of over 400,000 inhabitants and of considerable wealth. The automobile business is growing rapidly, and if the American manufacturer intends to make a bid for the business, now is the time to do it. There is only one American automobile in Lisbon; this is a runabout and is in the hands of an agent newly established. One reason why there are no more American cars here is that American concerns have not displayed any energy in demonstrating their machines in this market. Again, the dealers hesitate to try cars of American make because an automobile was imported three or four years ago that did not meet with the requirements demanded here.

Lisbon is very hilly, and cars that are used here must be climbers. The lowest horsepower required is 15-20. There are no electric cars or cars of the steamer type in use in Lisbon. It is the experience of the dealers that the former are not suitable for hilly country, and recharging is very expensive.

There are some German and English automobiles sold here, but the favorites are the French and Italian makes, the French being the most popular. The style of car mostly used is the double phaeton or touring car. They vary in price from \$1,800 to \$5,000. The import duty is comparatively low. According to a recent government report there are in Portugal 8,920 miles of macadamized roads and 2,461 miles in construction.

Tires a Prominent Factor in Australian Trade.

Consul Henry D. Baker, of Hobart, makes the following suggestions to manufacturers of automobiles and parts who desire to share the trade of Tasmania and other Australian States:

American manufacturers of automobile tires, if they desire to cater to the trade in Tasmania, should make the goods destined for this market of millimeter sizes and should have their goods shipped with greater care than at present. Most of the cars in use in Tasmania are of British or French make and are all equipped with metric-size rims. It is easier here to get good English or French tires than American tires; even the owners of American cars have nearly all gone to considerable expense in having the rims on their wheels changed to metric sizes. American manufacturers should supply tires in conformity with the sizes in local use and should take care that their goods reach Tasmania in good condition. Their goods might then be sold not only for American cars, but for British and French cars as well.

A common fault with American tires on Tasmanian roads is that they blow out around the edges, due to deterioration of the rubber on the long transit out here, the tires not having been placed in the coolest and driest places possible on the freight ship. The English and French tires arrive in much better condition, being shipped with a notice, "Do not stow near boilers." Owing to the present poor reputation of American tires here, those manufacturers who wish to improve their trade should be liberal in their guarantees and be willing to replace tires which prove faulty or damaged in transit. The sizes most commonly in use in Tasmania are the 880 by 120 or 125 millimeters (the last two being interchangeable with the 880 rim), 820 by 120 or 125 millimeters, 760 by 90 or 100 millimeters, and 815 by 105 millimeters.

Road Improvement for Autos in Afghanistan.

Consul-General William H. Michael, of Calcutta, furnishes the following information concerning the proposed establishment of an automobile postal service in Afghanistan:

It was reported some months ago that the Amir of Afghanistan intended to improve the roads en route from the Khyber to Kabul, in order to permit the use of automobiles. Orders have just been issued that the section from Dhakka to Jellalabad is to be taken in hand at once. The idea seems to be to establish an automobile postal service to and from Kabul, but progress is likely to be slow in this matter, as heavy expenditure will be required on the hill section between Gandamak and Buthak.

American Cars Have Large Sale in Java.

Consul B. S. Rairden, of Batavia, replying to an inquiry from an American manufacturer, has the following to say about the sale of automobiles in Java:

Within the last two years sales of automobiles have rapidly increased in Batavia and adjacent districts of the Javanese capital. The importations of automobiles in 1905 amounted to \$48,000, and in 1907 to \$360,000. The agent for an American automobile company reports that he sold over 100 cars in twenty months. The machine he handles sells for about \$2,000. [The addresses of Batavia automobile dealers are on file in the Bureau of Manufactures.]

Large Demand for Cars in Other Countries.

Similar reports from other consular stations indicate that throughout Asia, Africa, and parts of Europe, there is a growing demand for automobiles which might readily be filled by those made in this country. Both European and Asiatic Turkey need light cars with ample power and hill climbing ability, such that will carry five people, with engines of from 15 to 20 horsepower. The best is required, however, and demonstrations must be given by operators who are able to show the quality of the cars.



Vol. XX.

Thursday, April 8, 1909

No. 14

THE CLASS JOURNAL COMPANY

H. M. SWETLAND, President

231-241 West 39th Street, New York City

EDITORIAL DEPARTMENT

A. G. BATCHELDER, Managing Editor

R. F. KELSEY, Associate Editor

THOS. J. FAY

MORRIS A. HALL

W. McKEAN WHITE

W. F. BRADLEY, Foreign Representative

BUSINESS DEPARTMENT

A. B. SWETLAND, Business Manager

LOUIS R. SMITH

FRANK B. BARNETT

W. L. RALPH, 1035 Old South Building, Boston, Mass.

C. H. GURNETT, } 1200 Michigan Ave., Chicago, Ill.

F. W. VAN SICKLEN, }

H. H. GILL, Detroit, Mich.

T. B. VAN ALSTYNE, Philadelphia, Pa.

Cable Address - - - - - Autoland, New York
 Long Distance Telephone - - - - - 3046 Bryant, New York

SUBSCRIPTION RATES:

United States and Mexico - - - - - One Year, \$3.00
 Other Countries in Postal Union, including Canada - - - - - One Year, 5.00
 To Subscribers—Do not send money by ordinary mail. Remit by Draft,
 Post-Office or Express Money Order, or Register your letter.

FOREIGN SUBSCRIPTION AGENTS:

ENGLAND:—W. H. Smith & Sons, Ltd., 186 Strand, London, W. C., and all book-
 stalls and agencies in Great Britain; also in Paris at 248 Rue de Rivoli.
 FRANCE:—L. Baudry de Saunier, offices of "Omnia," 20 Rue Duret, Avenue
 de la Grande Armee, Paris.
 GERMANY:—A. Seydel, Mohrenstrasse 9, Berlin.

Entered at New York, N. Y., as second-class matter.

The Automobile is a consolidation of The Automobile (monthly) and the Motor
 Review (weekly), May, 1902, Dealer and Repairman (monthly), October, 1903,
 and the Automobile Magazine (monthly), July, 1907.

STANDARDIZATION VITALLY NECESSARY.

Standardization of automobile parts has become a most vital question, and one that now is worthy of the most conscientious attention. This is a matter that affects the owner and driver more than the factory man, because it will cost the latter much money to make changes of this sort. On the part of the buyer, however, there should be no hesitancy in demanding such reforms as standard control systems. There should not even be any necessity to call attention to this, as it is self-evident to anyone who has ever driven two different makes of cars.

In one, the forward movement of the lever on the outside gives the low speed. Get into another car, get into crowded or congested streets, and then upon involuntarily throwing the outside forward speed, instead of going slowly forward the car goes backward into another rig, and the driver, probably a very careful operator, has a bill of damages to pay. And all through no fault of his own nor through any lack of care or ability.

Then there is the matter of the spark and throttle. On one car the former is uppermost, on the next the throttle is above. In the habit of driving the former, you retard the upper lever, and when you crank the motor it throws you over into the next county. Result, doctor's bills and other expenses through no fault of your own.

Moreover, the number, location and operation of the foot pedals are worthy of standardization. When used

to operating the clutch with the left foot, it is more than disappointing to apparently declutch and try to change gears, only to find that the left pedal operates the brakes. So, instead of declutching you have put on the brakes and spoiled your gears.

That the importance of this subject is partly appreciated by the buying public is apparent from the statement that one of the foremost American car builders, turning out one of, if not the finest car in the country, was obliged at the beginning of the present season, by outside pressure, to change the form and location of the gear shifting lever. The former position was a good one and the shifting arrangement was excellent, but the public would not have it. As a result, the distinctive position was abandoned in favor of the commonly accepted one.

So, too, with the progressive gearset, this was markedly simple, comparatively lower priced to construct and install. But most of the people wanted and would have the other form and it became in a sense the standard. This necessitated that many firms change their construction, which has been done to a great extent, until to-day there is but one very prominent firm using this form of gear box, and, if rumor can be believed, even that will be changed for next season.

Instances might be cited, ad infinitum, but that is unnecessary. The idea is that many of the present forms which automobile parts take should be so altered, not to be interchangeable, that would be asking too much, but to be standard so that the operation of all cars will be alike. Then, and then only, will the danger and worry, with consequent expense, be eliminated.

This millennium can only be brought about by a strong and urgent demand from the people. To make such a demand efficacious, it must be widespread or universal. Previous to that must come a full realization of its advantages and the disadvantages now existing.

* * *

THE DIFFERENCE IN THIS YEAR'S CONTESTS.

There will be races this year, there is no question about that, but there will be a decided difference and it will be apparent to even a casual observer. Racing in the past has been racing pure and simple, sport for sport's sake. The contests of to-morrow will not be races in that sense of the word, but will be more tours on the order of a modified Glidden tour, which will be useful and serve a purpose in pointing out the good, bad and indifferent forms of construction as "shown up" by many miles of running under the ordinary conditions of road, speed, wind, weather, etc.

The other form of races which will be brought before the public in the coming season will also be of a useful nature, but at the same time more on the order of races. Just as the first named class will show up defects in the course of ordinary running, so the second class will do the same under extraordinary conditions of speed, road, etc. So hill climbing contests with maximum speed prevailing, two-mile track speed races and limited road races will be in order. Just as the British Four Inch race was a very instructive one to manufacturers, by far the most instructive ever held, so similar contests, properly arranged and run, may be expected to be of equal benefit to American manufacturers. The contests of the coming and future years will be of this nature.

HIGHWAY COMMISSION HEARS ABOUT CHAINS AND NON-SKIDS

ALBANY, N. Y., April 5.—Not a single voice in favor of the prohibition of tire chains and non-skid devices was raised in the hearing before the New York State Highway Commission on Thursday last, while prominent automobilists from various parts of the State appeared in opposition to the proposed measures. By their forceful arguments it is probable that they influenced the members of the commission to allow the use of these devices with certain restrictions and regulations. Evidence was adduced showing that chains do little or no damage to road surfaces in wet weather and at the same time increase the safety of the occupants of automobiles, though it was admitted that chains and other non-skids should not be used in dry weather because of possible injury to both tire and highway.

Charles Thaddeus Terry, chairman of the legislative board of the American Automobile Association, was the principal speaker against the proposition. Mr. Terry said that tire chains and other adequate non-skidding devices are necessary for safety and careful operation of automobiles when roads are wet, slippery or covered with snow and ice and that the injury to the road from them, if any, is slight and far overcome by the necessity for public safety.

"As for the tire chain," he said, "it sinks into the tire and only slightly in the road, is easily removed and thus is used only in dry weather. There would be no objection to a statute prohibiting the use of non-skidding devices when the roads are dry, for that is the only time when they can do any damage and automobilists do not need them."

Mr. Terry said further that a prohibition against the use of tire chains in all conditions of the road would be unconstitutional and that the Supreme Court of this State had held such a restriction void; that the provisions of the New Jersey law allowing non-skidding devices only when there is an inch of snow or ice on the road had been condemned by the attorney-general of that State and had been practically repealed by the New Jersey Assembly by a large majority. "All the automobilists of the State and of the United States," he declared, "insist that a prohibition of the chain would deny to automobilists equal rights to the use of highways, because under many decisions of the court it has been held to be a natural and usual use."

Coker F. Clarkson, representing the Association of Licensed Automobile Manufacturers, said: "What is the possible injury due to the use of chains? Only a fraction of the automobiles

in operation ever use chains. Those on which chains are used have them in the tool box nine-tenths of the time—probably only one day in a month are chains used for a short time. Is it possible that this small use can really be the cause of material damage to the roads? During the very small time relatively that chains are used, what happens? On the straight stretches, when running free, the wheels are in perfect rolling contact with the road. The chains are loose on the tire treads, and imbed themselves partially in the tread of the tire and partially in the road. If the road is soft, the chains will compact a small area of it. If the total area of the road could be similarly treated, it would be greatly improved. Thus, far, no objectionable feature is present in the use of chains. On the contrary, every horse that passes, every moment it is on the road, is digging into and disintegrating the road. In addition, it would be well-nigh impossible to start a car on winter roads without the use of chains."

Henry Edmund, of London, England, a member of the Institute of Civil Engineers, said that he had much experience with the use of chains abroad, that in some parts of England they are required by law because the effect of chains upon roadways was less injurious to the roads than steel-studded tires, which had been experimented with.

Others who appeared were: H. A. Meldrum, president, and Oliver A. Quayle, ex-president, New York State Automobile Association; Frank G. Webb, president, and H. G. Andrews, secretary, Long Island Automobile Club; Bert Van Tuyl, Automobile Club of Rochester; F. H. Elliott, Bronxville Automobile Club; G. H. Stillwell, Automobile Club of Syracuse; F. A. Kately, Mount Vernon Automobile Club; Albert A. Shattuck, ex-president, Automobile Club of America; George C. Diehl, engineer of Erie County; Hiram Percy Maxim, Hartford; Peter D. Kiernan, Albany; Arthur F. Phelps, Watervliet; John M. Bruce, Yonkers; Edw. M. McMahon and James Hemstreet, New York.

When the opposition, the automobilists, had finished their arguments, Chairman Hooker, of the commission, gave those who were in favor of the proposed law a chance to speak, but no one appeared. Those who attended the meeting are inclined to believe that the commission was favorably impressed with the arguments of the automobilists. The absence of any champions of abolition of non-skid devices certainly diminishes the force of their argument—if they have any.

NEW YORK INTENDS TO REGULATE AUTO SPEED

CONDITIONS in New York regarding the reckless, injudicious, and criminal use of automobiles have brought about the formation of the National Highways Protective Association, to make a determined war against the persistent speeders and joy riders who have aroused the city authorities during the past week. A number of serious and fatal accidents have been caused by automobiles operated at a speed far above that considered reasonable, and an active crusade against the automobile "hog" is the result. This is supported by automobilists, the police, the professional chauffeurs, and others vitally interested, for the stigma of the wild driving has been felt by all users of automobiles in the vicinity of the metropolis.

The newly formed association has been incorporated under the laws of the State of New York, and its particular objects stated in its articles of incorporation are:

To prevent the improper and unreasonable use of the public highways and public roads and places by the owners or users of horses, carriages, bicycles, automobiles, and all other vehicles; to enforce and protect the rights of the members of this corporation and the public in the reasonable and proper use of such public highways, public roads and places; to endeavor to secure the construction and maintenance of good roads by public authority, and

in furtherance and not by way of limitation upon the objects above enumerated; to endeavor to bring about reasonable and uniform rules and regulations for the use of the public highways, roads and places throughout the United States of America; to aid in the enforcement of laws in respect thereto, and so far as may be lawful to aid in securing any such changes or modifications thereof as may be found necessary or proper.

The plans for the campaign call for the stationing of twenty men on thoroughfares, used by automobilists, who will note the numbers of cars which are speeding. Where there is sufficient evidence convictions will be pressed, and for constant offenders jail sentences will be asked. By a card index system an account of the law breakers will be kept, and after being reported to the headquarters, the owners of the cars will be notified, so that if their chauffeurs have had the cars out without permission they will be apprehended. If, on the other hand, the owners themselves have been indulging in bursts of speed, the notice may tend to prevent recurrences. It is thought that by this means joy-riding may be stopped, and one of the greatest evils wiped out, at the same time making all chauffeurs more careful.

One contention that will undoubtedly be successful will be the efforts to prevent young boys from driving horses in crowded

streets, who, it has been declared, cause nearly as many accidents as reckless automobile drivers. The safeguarding of pedestrians, and sane users of the highways, is a worthy object, and the national association has already been praised by the police authorities. The bicycle squads in the city have been reorganized, and additional men put on, until the wave of criminal driving subsides. The detectives who are put upon the trails of the guilty will be no respecters of persons, and those who usually have enough influence to "beat" their cases will find that the influence will be of no avail.

Charles S. Whitman, a former judge of the court of general sessions, has been retained as counsel, and will have charge of the prosecutions for the society. The officers are: President, Henry Clews; vice-president, A. D. Middleton; secretary, Edward C. Cornell; treasurer, Gilford Hurry. Besides these officers, the incorporators are: F. Augustus Schermerhorn, Cleveland H. Dodge, George W. Burleigh, R. Fulton Cutting, Joseph H. Coit, Frederick N. Lawrence, Everitt P. Wheeler, J. Forbes Potter, Lawson Purdy, William H. Llewellyn, Milton I. D. Einstein, Ackley S. Schuyler.

CONNECTICUT MAY HAVE A COMMISSIONER.

HARTFORD, CONN., April 5.—Legislative action regarding automobile laws is at present in a peculiar situation, for a bill has been presented providing for the appointment of a commissioner of motor vehicles, and it is stated that until this bill is either accepted or rejected the proposed automobile legislation will not be considered. Therefore affairs are at somewhat of a standstill. The commissioner, if appointed, would look after the enforcement of the present automobile law or its successor and would issue the licenses and certificates of registration. At present this is done by the Secretary of State's office. There is considerable opposition to the new measure, although automobilists are generally in favor of it. If action is taken on the commissioner matter the present law may be revised. Another amendment likely to pass is one requiring registration of autoists from other States. This is opposed, and will be fought, unless it recognizes licenses of States which reciprocate those of this commonwealth.

ILLINOIS MAY EXAMINE AND LICENSE.

CHICAGO, April 5.—Examination of and licensing of drivers of automobiles in Illinois is contemplated by Senator Dellenback, who has introduced a bill which provides for the examination and licensing of all persons driving or operating motor vehicles propelled by electricity, steam or gasoline.

If this amendment passes it will also amend the motor-vehicle act so that all cities and towns in the State will be privileged to examine drivers and also to license them. Chicago evidently anticipates favorable action on the Dellenback bill, for its city council already has passed an amendment to the revised municipal code which in addition to the examination feature also provides for each car carrying a city tag. At present this extra tag cannot be carried without violating the State law.

STATE LAW FOR GEORGIA AUTOMOBILISTS.

SAVANNAH, GA., April 5.—Automobiles in the State of Georgia will probably soon be regulated by a uniform law which is now being prepared by the Secretary of State Philip Cook. Members of the general assembly have requested the drafting of the bill, and it is expected that it will be introduced into the Legislature at its next session in June. Mr. Cook has copies of a number of Northern State laws and is endeavoring to take the best parts for use in the Georgia statute.

HEARING TO-DAY FOR NEW YORK BILLS.

ALBANY, N. Y., April 5.—It has been arranged by the chairmen of the Senate and Assembly committees on internal affairs to hold a joint session on all bills relating to automobiles in any way before their committees for Thursday next.

OVERLAND BUYS POPE-TOLEDO FACTORY.

One of the largest automobile real estate deals which has taken place in this country for some time was consummated in New York, on Tuesday of this week, when papers were signed by John M. Willys, president of the Overland Automobile Company, of Indianapolis, Ind., and Col. Albert Pope, president of the Pope Manufacturing Company, Hartford, Conn., for the purchase of the mammoth Pope-Toledo manufacturing plant, at Toledo, O.

The Pope-Toledo factory is one of the largest and best equipped automobile manufacturing plants in the United States. It comprises twenty-four buildings of modern construction, having floor space of 400,000 square feet and covering twelve acres. It contains hundreds of thousands of dollars' worth of modern machinery. With its present factories at Indianapolis and the new Pope-Toledo plant, the Overland Automobile Company will be one of the largest manufacturers of automobiles in the country. The output of the Overland concern will be practically unlimited, and the 1910 product will be broadened with a larger range of models and prices.

In speaking of the new deal, Mr. Willys says: "The growth of the Overland company has been so rapid that we were forced to look to larger quarters. While for many reasons we would like to have increased our manufacturing facilities in Indianapolis, the Pope-Toledo location is the only one in the market which meets our requirements. When we secured control of the Overland Automobile Company we knew that the concern would grow, but did not expect that it would enlarge with such rapidity and in such a short period. Between 1903 and 1908, during the experimental days of the Overland, 250 cars were sold. During 1908 more than 500 Overlands were built and delivered. With only three months of 1909 passed, 1,350 cars have been built, and to-day we are 1,500 orders behind. The success of the Overland has swept us off our feet, and we were simply forced to secure larger quarters. The headquarters of the concern will remain at Indianapolis."

BIG MARATHON VICTOR WAS A CHAUFFEUR.

Chauffeurs may now take notice of a new road to fame, that of Marathon running on courses which take no cognizance of speed laws, for the style has been set by one Henri St. Yves. This youthful Frenchman made many thousand followers of this sport try to pronounce his name by winning the world's championship Marathon race in New York, last Saturday. It was heralded that he had been a waiter in the Hotel Cecil, in London, before coming to this country, and for that reason had given no "tips" upon his ability as a runner, inasmuch as he was in the habit of receiving only. It has developed, however, that the occupation of St. Yves was that of a chauffeur, and perhaps that accounts for his speed. His experience in his present line is a short one, covering but eight months, in which time he took prominent parts in four races in England and France, in which he scored a series of victories that have placed him in the front rank of the world's greatest runners.

GENERAL MOTORS COMPANY PLANS.

LANSING, MICH., April 5.—It was announced to-day by W. C. Durant, of the General Motors Company, who is visiting Michigan plants, that the new main factory of the General Motors Company is to be located at Flint, instead of at Lansing, as rumored. The new building will be 1,021 by 365 feet, and will be of brick, all under one roof. It will be located near the Buick plant, and represents an investment of \$1,000,000. It is estimated that 3,000 men will be employed, in addition to the 5,000 now employed by the Buick company. It is intended to have the plant completed by early Fall.

It was also stated that the output of the Olds Motor Works will be greatly increased, and perhaps new buildings will have to be constructed this spring.

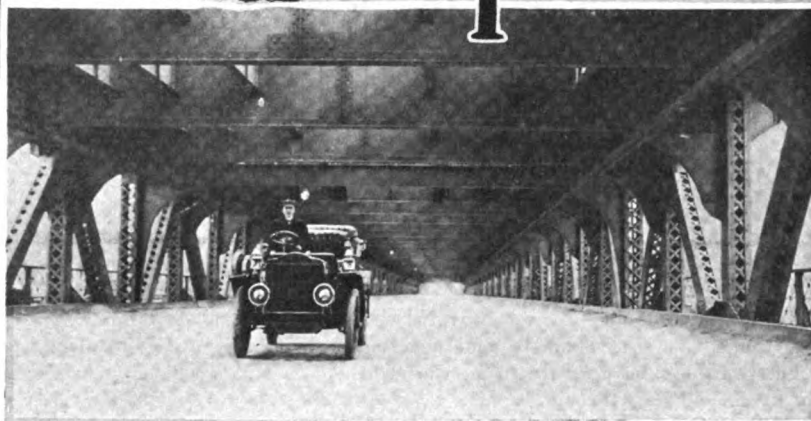
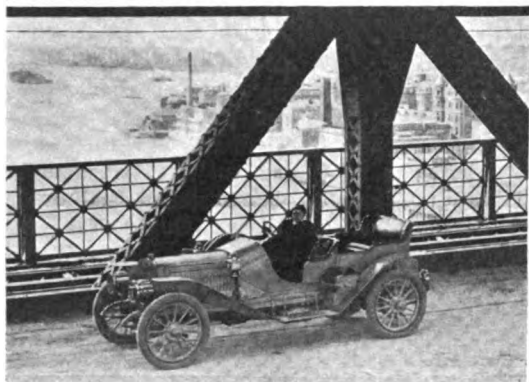

METROPOLITAN automobilists, through the opening recently of the new Queensboro bridge between Manhattan and her sister borough, Queens, have acquired a short route to points on famous Long Island, doing away with the necessity of a roundabout trip to the Williamsburg bridge or the use of the now obsolete ferries. The saving in time will be very appreciable, for it is possible to leave the center of the automobile district and in a few minutes enter the gates of the Queensboro bridge, without having to go through congested traffic routes.

Incidentally there was a spirited contest among automobile dealers and owners to see what car would be the first to cross the bridge. White, Lozier, Franklin and others claim the distinction. Through the courtesy of the Department of Bridges a representative of the touring bureau of the White Company was allowed the privilege of driving his steamer over several hours before the roadway was formally opened by Mayor McClellan. The purpose of the trip was to secure data for those desiring to use the new structure, as it was believed that all autoists traveling between New York and Long Island City would make early use of the new bridge instead of the Thirty-fourth street ferry. The White touring bureau then issued the following circular of routes:

The best way for New York autoists to reach the new Queensboro bridge is to go through East Fifty-seventh street to Second avenue.

Here turn left into Second avenue, and two blocks beyond turn right into the driveway of the bridge. The toll for an automobile is 10 cents, as on the other bridges. There is but one driveway on the new bridge, but it occupies the middle of the structure and is at least as wide as Fifth avenue. The bridge is 14-10 miles long.

On reaching Long Island City side, keep straight ahead through the plaza, and at the end of the plaza turn right into Jackson avenue. Continue on Jackson avenue until one block before reaching the court house, and then turn left into Nott avenue. One hundred yards beyond, bear left again into Thompson avenue, and continue over the new viaduct spanning the Long Island railroad yard. The distance from Fifth avenue and Fifty-seventh street to Thompson avenue by the route given is 27-10 miles. Thompson avenue, as is well-known to most automobilists, is the thoroughfare to all the principal roads on Long Island used by tourists. On returning to New York, retrace the route given except that, in leaving the bridge, it is best to go through East Sixtieth street.

Mayor McClellan, in crossing the bridge and officially opening it, rode in a Franklin touring car, but he was preceded by several hours by ex-Chief of Police Devery in his car. The Lozier comes forth, however, with the statement from C. A. Emise, of that company, that this car was really the first over, for Mr. Emise secured a special permit to use the bridge on Monday, the day previous to the announced opening, and that he crossed twice in his Briarcliff roadster. On going over en route to Flushing the main roadway was deserted and less than two minutes were consumed in covering the distance.

MOVEMENT FOR ATLANTA-WASHINGTON ROAD.

ATLANTA, GA., April 5.—Definite movements towards building a road from this city to the national capital have been started here, through the application of Frank Weldon and A. W. Smith for a charter, asking to be incorporated as the Interstate Highway Association. A capital of \$1,000 is given, but the right to increase that to \$100,000 is asked, and the objects of the association are stated to be several: the promotion, construction, and improvement of continuous highways from one section of the country to another; the right to organize local associations; to accept donations and contributions for the building of roads.

The principal office of the association will be in Atlanta, and it is planned to promote the road from this city to Washington before taking up those between other cities in the South.

COLUMBUS ASSOCIATION ORDERS ROAD SIGNS.

COLUMBUS, O., April 5.—The Columbus Automobile Association, which recently opened luxurious clubrooms at the Northern Hotel, has awarded a contract for the furnishing of a large number of danger and distance signs. The club will soon declare a "sign day," when they will be erected. For erection over garages twenty-five club monograms of blue have been received.

The club maintains a private secret service department, employing a detective to recover stolen machines and accessories. Since this department was founded twelve stolen cars have been recovered and also numerous other articles. There is a standing reward of \$100 for the arrest and conviction of any person bothering the car of a member of the association. Another feature of the association is the information bureau.

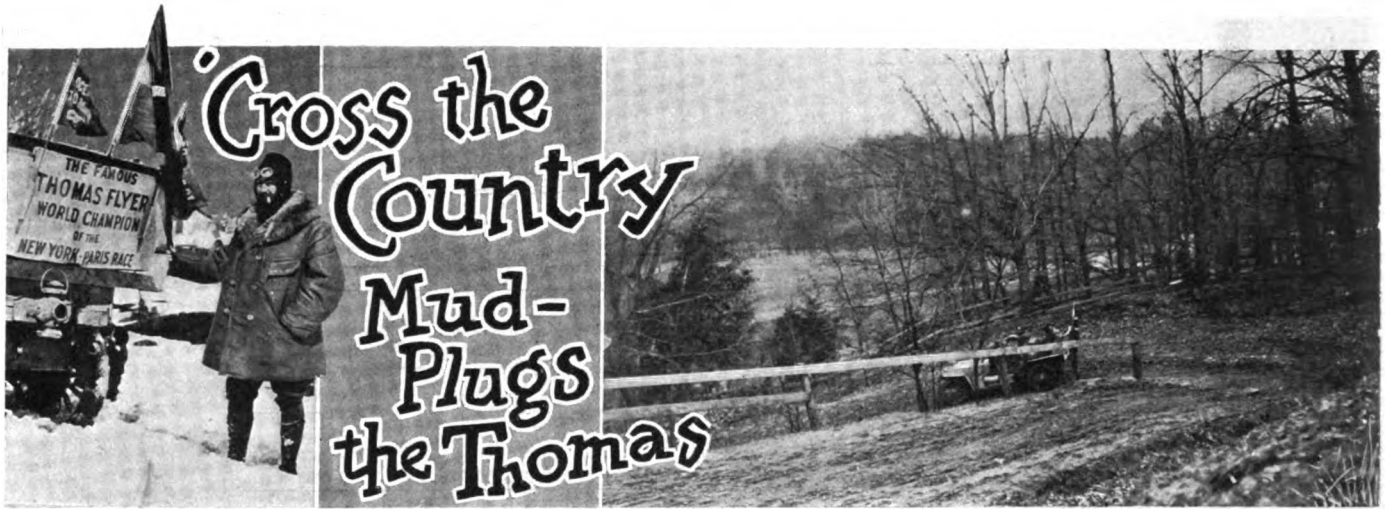

PATHFINDING for an international contest, of the trans-continental variety, in the Middle West, is one continual round of hearty receptions and celebrations, when it is not a case of plowing through deep mud, or running over dusty roads. This has been the experience of the crew of the Thomas car, which is marking out the route to be taken by the contestants, in the endurance run from New York to Seattle next June. The pathfinder is now near Kansas City, Missouri, and has found that automobilists, and everyone else in that great country, are looking forward to the time when the participants in the event will pass through.

The Thomas left New York on March 20, reached Chicago on March 30, and left on April 1 for St. Louis. On the first day it reached Bloomington, 130 miles, running over roads that surprised the crew by their excellence, in comparison with some covered in Ohio. St. Louis was reached on Friday evening, by making the longest run of the trip, 190 miles, and the roads were found to be good, until within 20 miles of the Mound City, but there were many places where they were misleading. The big car had a triumphal entry, with a dozen other cars in line, and the general enthusiasm exhibited by everyone surpassed that seen anywhere. Saturday was taken for rest and the general interest in the contest grew apace. Business and automobile interests raised a purse of \$1,000, to be given to the car which reaches St. Louis first in the run, and in the evening a banquet was given in honor of the pathfinding crew, nearly 100 members of the St. Louis Automobile Manufacturers and Dealers' Association attending, and the Postmaster, Frank Wyman, gave a letter to L. W. Redington to be delivered to the Postmaster of Seattle. Governor Hadley shook hands with the crew, as the official send-off, on Sunday morning.

NEW YORK WILL HAVE 24-HOUR RACES.

NEW YORK, April 5.—Prospects for three 24-hour track races were promulgated to-day at a meeting of the Motor Racing Association, at the Automobile Club of America, resulting in the appointment of a committee to inspect the various courses around the city, and to secure the best. This organization of metropolitan dealers held two successful round-the-clock events last fall, on the track at Brighton Beach, but the cutting up of part of this into building lots will prevent its use again. The Aqueduct and Jamaica tracks will be considered, and a programme arranged at an early date.

A. C. A. SMOKER TO CONCLUDE CARNIVAL.

NEW YORK CITY, April 5.—The Automobile Club of America has extended its hospitality to the automobile trade and will give a smoker and entertainment as the concluding feature of automobile carnival week, April 26 to May 1. At this smoker the prizes will be distributed. Carnival headquarters have been opened by Secretary W. R. Lee at 1789 Broadway.

Two days were allotted for the trip across the State of Missouri, to Kansas City, and daylight of the first was consumed in running to Mexico, 50 miles short of the distance it should have covered. The roads were good, but twisted and turned, so that it was hard to keep the right direction, and the car had to retrace its course several times. Other delays were caused by fractious horses, and many times the car had to stop until the equines were unhitched and taken off the road. Unwilling to lose time, the crew pushed forward to Centralia.

Kansas City would have been reached by daylight on Monday if it had not been for the turbulent condition of the Missouri River at Glasgow, where there were only two means of crossing—a ferry, which could not be operated on account of the rough water, and an open railroad bridge, 100 feet above the river. George Miller looked at the latter, but the wind was so high that it was deemed best not to attempt the bumping across. As an indication of the interest shown all through the West, on Monday morning Moberly automobilists actually kidnapped the pathfinders, and made them put that town on the route, necessitating a short detour.

The river was crossed late Monday evening, and the night spent at Blackburn, about 50 miles from the river. A terrific storm forced the tourists to stop, and it turned the roads into seas of mud. On Tuesday afternoon the car reached Kansas City, having taken seven hours to travel 74 miles, the last 30 being over good rock roads, but the others were through deep mud. The trip was resumed towards Denver on Wednesday.

Two entries have been announced, a Simplex by H. B. Brosel, Jr., general manager of the Simplex Automobile Company of New York; and a Stearns by Oscar Stolp, of New York, who will be accompanied by H. Davis Webster.

ANOTHER TRACK MEET ASKED FOR.

BOSTON, April 5.—The contest committee of the Bay State Automobile Association has requested a sanction from the A. A. A. for a track race meeting to be held on the Readville track on June 17. Memorial Day, May 30, has in the past been the date usually selected for the spring races at Readville, but it was impossible to secure that date this year. The track has recently changed hands and improvements will not be completed in time to permit its use before June 17. The committee of the Bay State Association is headed by Dr. J. F. Hovestadt.

MAXWELL NEARING 8,000-MILE MARK.

BOSTON, April 7.—Well ahead of the 7,500 mile mark, the Maxwell four-cylinder touring car, which is running to make a 13,000 mile engine-non-stop record, is expected to cover the required distance within the week. Shortly after noon yesterday it had completed the 7,500 miles, and at noon to-day was 400 miles beyond that. It is expected to pass the 8,000 mile mark before nightfall to-day.

ADAPTING THE THREE-TON TRUCK TO FARM SERVICE

CONYERS MANOR, nine miles from Greenwich, Conn., is one of the notable estates in the East, being not merely ornamental, but a great farm operated on a commercial basis. It represents 1,300 acres of reclaimed land and is the home of

arate garage for commercial vehicles, which it is proposed to use extensively. The basis of work in the commercial vehicle line, now on the farm, is a Packard three-ton truck.

The principal work of the truck is in running back and forth between the farm and the town. Its regular platform body has a special grain body inserted inside the regular stakes. By removing this inside body when it is not desired to haul grain to Greenwich the truck is ready for use in its other work of carrying fertilizer, coal, machinery and general supplies. Mr. Converse is an enthusiastic advocate of motor vehicles for hauling and makes no distinction between hauling in the city and in the country. He argues that with suitable roads such vehicles as this truck are particularly well adapted to farm hauling. Their greatest efficiency is in the carrying of approximately full loads for long distances, with infrequent stops. Agricultural hauling meets these requirements exactly.



E. C. Converse's Packard Truck Leaving the Manor for Town.

E. C. Converse. Aside from being a beautiful estate, it is typical of the great advancement which has been made in modern farming, and especially in the way of applying scientific and commercial methods to agriculture. Motor cars are common at Conyers Manor. Not only is there a large and well-equipped private garage for the several pleasure cars, but there is a sep-

horse-drawn truck, makes up for the small load and more than compensates for the abbreviated distance. In the matter of stops, the gasoline vehicle is at no disadvantage, either, for it can be stopped in a shorter distance, and stopped or started in a shorter time than can the equal sized horse trucks. This agility, more than offsets the advantages, if any, accruing to the horse.

INCREASING USE OF THE AUTO FOR HOSPITAL SERVICE

THE illustration shows a White steamer recently put into service by the Bellevue Hospital in New York City after a prolonged trial of speed, easy riding qualities and silence, the last feature being of equal rank with the first in the final decision. This is a well-known quality of steamers and of this particular make. The advent of automobiles into this service marks another *new* departure, and a startling one, as it was freely predicted a few years ago that there was one field that the auto would never invade. This was the one in which a conquest is now being made by the car shown. There have been ambulances before this, but they have been mostly electrics, until the manufacturers of that type of car have come to look upon this field as particularly their own. The present instance shows that they are not very secure in their position and that it is time for them to look to their laurels. With the invasion of this division by the steamer as well as the elec-

tric, it would be a very hard matter to pick out anything in which some form of self-propelled vehicle is not applicable, or in which there is not a form of commercial vehicle working.



One of the New White Steamer Ambulances for Bellevue Hospital.

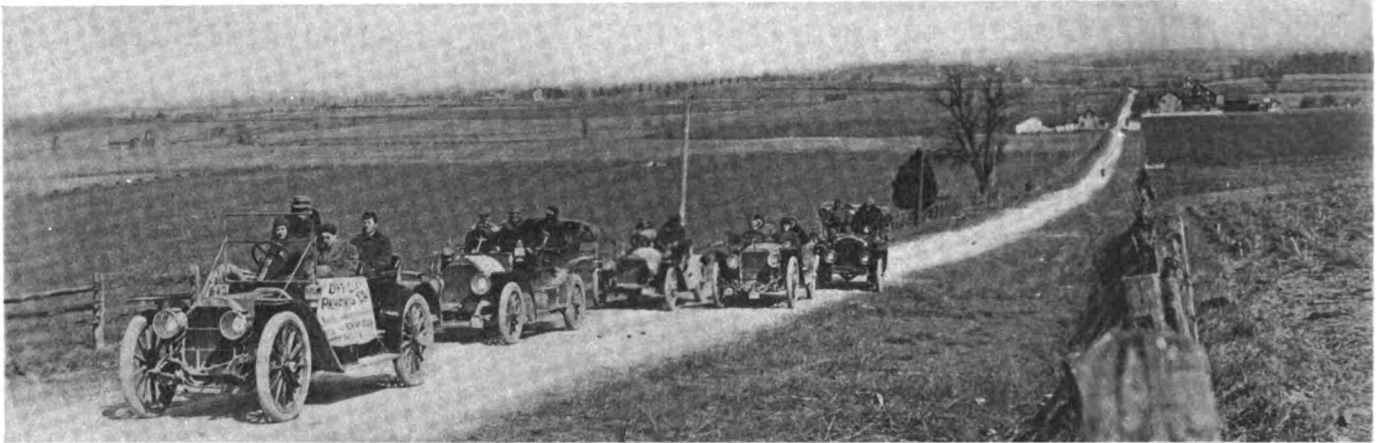

A Good Stretch of Pennsylvania Highway Between Lancaster and Harrisburg.

PENNSYLVANIA'S GOVERNOR GIVES TROPHY FOR CONTEST

HARRISBURG, Pa., April 5.—Gubernatorial participation in automobile endurance runs is something altogether new and exceedingly pleasing to automobilists, and the Motor Club of Harrisburg is the organization which is the first to secure this honor. Governor Edwin S. Stuart, of Pennsylvania, a friend of autoists and an experienced tourist, has donated the principal trophy for the four-day endurance run of the club, to be held from May 3 to 6, and perhaps may take an active part in the first lap of the contest.

A route of about 700 miles in length has been selected, and the pathfinders have already mapped out the first half of it. The party, headed by Dr. J. R. Overpeck, of Philadelphia, last week covered the roads of the first and second day, from this city to Washington, and return. From Harrisburg the route leads to Gettysburg, where the first checking station will be established, after a short run through the battlefield. From this famous place roads through more historic country were taken, over the South Mountains, to Hagerstown, Md., where the noon control will be made. The next stretch is to Frederick, where the checking station will be but a short distance from Barbara Fritchie's house. The Cooksville route to the national capital has been selected. The checking station has been arranged for at

the New Willard Hotel, on Pennsylvania avenue, where the Washington Automobile Club will give a reception in the evening.

For the second day the run will start toward Baltimore, over a road that will surprise many, for it is a beautiful boulevard, and one of the best highways in the country. The entire distance to Baltimore was especially delightful to Pennsylvanians who know what bad roads are. The entrance to the city is made through the business section, and the checking station placed at the fine quarters of the Automobile Club of Maryland, on Mt. Royal avenue. Leaving the city the route leads through Druid Hill Park to the Reisterstown pike, on a run to Westminster, thence to Littlestown, where a second control will be placed, continuing through Hanover to York, where a noon stop will be made on May 4. The next station is at Lancaster, after crossing the mile-long bridge over the Susquehanna River at Wrightsville. At Lancaster a turn is made for the final spin back to Harrisburg for the second night stop. The roads on the preliminary trip were found to be excellent everywhere.

The remainder of the route will be covered this week, going to Wilkes-Barre and Scranton, and then returning via Delaware.

In addition to the Governor's trophy, there will be a National Capital Cup, donated by the Washington automobilists.



Crossing the Columbia Bridge at Columbia, Pa., Which is One of the Longest Railroad Bridges in the Country.

CLUBS PREPARE FOR THE SEASON'S FUNCTIONS

NORRISTOWN CLUB HAS SPLENDID HOUSE.

NORRISTOWN, PA., April 5.—After two years of meetings in hotels, or at the offices and homes of its members, the Norristown Automobile Club now has a completely equipped and furnished home of its own, situated on the Reading Pike, a mile and a half from the town, large enough to hold banquets, and at the same time so arranged as to be a cozy meeting place for a few members at a time.

The building of brick is constructed in a bungalow style, so that the second floor is really the main one, and a broad stairway leads to it from the ground. The entrance from the porches which surround it is into a large Bohemian hall, finished and furnished in Mission style, with a wide stone fireplace at one end. On the same floor, which is forty feet square, are the ladies' parlors, the governors' room, cloak room and steward's quarters. Polished hardwood floors, handsome rugs and deep window seats give a homelike appearance to the big room, while



New Home of the Norristown (Pa.) Automobile Club.

the ladies' quarters are daintily furnished. The ground floor is a big rathskeller, with its stone open hearth, polished kitchen and grill, and a room for the steam heating and pumping plant.

At the rear of the lot on which the clubhouse stands there is a temporary shed which will cover a score of cars, and it is the intention of the organization to build a permanent garage ultimately. The building itself, and the future plans, are all in the hands of the house committee composed of William B. Hart, chairman; L. E. Taubel, Andrew H. Root, Harry C. Wilson and H. C. Carney. The club is indebted for its present location to L. E. Taubel, the treasurer, who purchased the property when it was a farm, and induced the club to build upon it. A housewarming was held recently and was attended by automobilists from Philadelphia and miles around Norristown.

LOWELL PLANS TWO RACES FOR NEW COURSE.

LOWELL, MASS., April 5.—Rumors that Lowell would have another stock-car race similar to the one held here last year have been set at rest through the announcement by the Lowell Automobile Club that both a light car and a large car race will be held on a specially prepared course greater in length than the one for the previous contest as features of an automobile carnival week. The dates have been set for next September 6 to 11 and the two speed contests will be the most important happenings of that Labor Day week. At present only the preliminary arrangements are being made, but the members are ready to push the whole matter as soon as John O. Heinze, the president of the club, returns from New York.

In addition to the automobile races there will be motorcycle contests, bicycle races, motor boat races and aquatic sports upon the Merrimac River. The interest aroused by the stock-car event last year has assured the club of the substantial backing of all local influence.

ALBANY CLUB OUTLINES MOUNTAIN TOUR.

ALBANY, N. Y., April 5.—Touring for pleasure only, with no form of a contest, is the plan outlined by the committee of the Albany Automobile Club which has charge of the club's fifth annual tour. This year a route has been chosen that will undoubtedly be a favorite one, taking in some of the most picturesque parts of New England, with short daily runs and frequent stops for sight-seeing. In fact, there are no rules, and the participants may stop as often as they like. The committee requests that the club members all stop at the hotels and garages with which arrangements will be made to give minimum rates.

The tour will commence on Tuesday, June 22, with a run of 132 miles to Woodstock, Vt., covering some beautiful country through Cambridge and Salem. On the second day the run is to the Bretton Woods, 110 miles, through Lebanon, Groton, Plymouth, N. H., the Flume and Franconia Notch, passing Echo Lake. Thursday will be given over to going to the summit of Mt. Washington, and on Friday there will be a run of 116 miles to Portsmouth, N. H., through Crawford Notch and Intervale. On Saturday the run will be another short one, 64 miles, to Boston, over ideal roads and through wonderfully beautiful and historic country, skirting the shore. On Sunday the tourists will travel over Massachusetts' splendid highways to Springfield, 95 miles, stopping en route to visit the old Way Side Inn. The run of the last day is over a new and very picturesque route, following the Connecticut river northward, through Holyoke to Northampton, passing Mt. Tom, and then bearing left through Goshen, Windsor and Pittsfield to the finish at Albany. This run is 98 miles in length and the total distance to be covered in the six days of touring is 615 miles.

HUGHES NOW WILKES-BARRE PRESIDENT.

WILKES-BARRE, PA., April 5.—At the annual meeting of the Wilkes-Barre Automobile Club, held here to-night, the following officers were elected: President, James H. Hughes; vice-president, Guy W. Moore; secretary and treasurer, P. S. Ridsdale; governors, Thomas A. Wright and George W. Lewis. The racing committee having the annual hill-climbing contest on May 31 in charge will be George F. Lee, chairman; T. A. Wright, P. A. Meixell, W. E. Steelman, Dr. E. C. Wagner, Guy W. Moore and George W. Lewis.

President Hughes, in his address, advocated increased activity in good roads work, efforts to secure sane legislation for automobilists, opposition to excessive speeding and vigorously advocated building a road up the Wilkes-Barre Mountain out of the Wyoming Valley to replace the old Easton turnpike. This has an average grade of 12 per cent. and a maximum of 22, and is so steep that there have been numerous breakdowns and accidents upon it. A preliminary survey has been made for a road with an average grade of 6 per cent. and a maximum of 11, and President Hughes will work hard to get this built.

A. C. A. WILL RE-ELECT OLD OFFICERS.

NEW YORK, April 5.—The Automobile Club of America, at its annual meeting, to be held Tuesday, April 13, will re-elect all of its present officers, with the exception of the treasurer, as nominated by the board of governors. No opposition will arise, for the constitutional time limit for the proposal of another ticket has elapsed, and therefore the officers for the coming year will be:

President, Judge E. H. Gary; first vice-president, Henry Sanderson; second vice-president, William G. McAdoo; third vice-president, Robert Lee Morrell; treasurer, Alfred Ely. The three governors whose terms expire this year have been nominated to serve for three years more, constituting the class of 1913. They are Horace Porter, George F. Chamberlin and Colonel John Jacob Astor.

ACTIVE CLUBMEN OF MANITOBA.

WINNIPEG, MAN., April 5.—At the annual meeting of the Winnipeg Automobile Club the election of officers resulted as follows: Patron, Sir Daniel McMillan; honorary president, J. C. G. Armytage; president, R. M. McLeod; first vice-president, W. R. Bawlf; second vice-president, P. C. Andrews; secretary-treasurer, W. L. Wright; executive committee, E. C. Ryan, D. B. Sprague, F. R. Newman, W. C. Power, W. A. T. Sweatman, H. M. Belcher, and C. Newton.

A resolution was passed admitting women into full club membership on payment of an annual subscription of \$1.

The surplus proceeds from the race meet held last fall were distributed between the various hospitals in the city, each of which benefited to the extent of \$35.

The secretary reported the offer of a free site for an automobile clubhouse by a well-known real estate firm, and the offer was left in the hands of the executive committee for consideration.

Fourteen new members were elected, bringing the total close to the 200 mark. It is proposed to hold two race meets during the 1909 season, and to arrange an extended tour during the fall.

WAUSAUTES FORM WISCONSIN VALLEY CLUB.

WAUSAU, WIS., April 5.—Owners of automobiles in this place have decided to form an organization under the name of the Wisconsin Valley Automobile Club. Up to this time the owners have been content to be individual members of the Wisconsin State Association, but the number of machines is multiplying so rapidly that it has been found to be of more interest to form a separate club. It will be affiliated with the W. S. A. A. and the A. A. A. Its main purposes will be to secure legislation for good roads; to keep a check on violators of the laws, and to maintain guide posts. H. G. Flieth, cashier of the German-American bank, will probably be elected president. Neal Brown, president of the W. S. A. A., is a prominent resident of Wausau and will be a member of the local organization.

UTAH AUTOMOBILE CLUB WILL JOIN A. A. A.

SALT LAKE CITY, UTAH, April 5.—Directors of the Utah Automobile Club have decided to apply for membership in the American Automobile Association in order to bring the State organization into closer touch with national movements in automobile affairs and to hold race meets, hill climbs and tours under national sanction. At present the club is chiefly interested in the good roads work under the provisions of the recent enactment of the Legislature, by which it is hoped to establish a system of improved highways throughout the State. As soon as weather conditions become settled actual work will be commenced.

HARTFORD POSTPONES CLUBHOUSE IDEA.

HARTFORD, CONN., April 5.—It has been decided by the "new quarters" committee of the Automobile Club of Hartford to abandon temporarily the idea of securing a clubhouse and to remain at the Allyn House for the present. This will be taken up for definite action at the annual meeting, which will be held April 14. A number of desirable locations for a clubhouse were inspected and several good offers received.

J. Howard Morse, former president of the Automobile Club, and Mrs. Morse have returned to the city after a two years' tour through Europe. After a visit they will return to Switzerland.

BERLIN, WISCONSIN, AUTOISTS ORGANIZE CLUB.

BERLIN, WIS., April 5.—The Berlin Automobile Club has effected a permanent organization and elected the following officers: President, C. M. Boettge; vice-president, T. S. Rumsey; secretary, Perry Niskern; treasurer, W. N. Crawford; executive committee, Frank H. Russell, H. Safford and Fred Wright. The headquarters will be at the Wilson Garage. The club already has a membership of 35.

THE AUTOMOBILE CALENDAR.

AMERICAN.

Shows.

- April 10-17.....Brooklyn, N. Y., Clermont Rink, First Annual Automobile Show, Long Island Automobile Club.
- April 17-24.....Montreal, St. Lawrence Hall, Fourth Annual Automobile Show, auspices of Automobile Club of Canada. R. M. Jaffray, Manager.

Races, Hill Climbs, Etc.

- April 22-24.....Chattanooga, Tenn., Hill Climb on Lookout Mountain, Lookout Mountain Automobile Club.
- April 24.....Philadelphia, Roadability Run to Atlantic City, Quaker City Motor Club.
- April 26-May 1...New York City, Second Annual Automobile Carnival, New York Automobile Trade Association.
- April 26.....New York City, Second Annual Hill Climb, Fort George-New York Automobile Trade Association.
- April 28-30.....Pittsburg, Pa., Gazette Times-Chronicle Telegraph Three-Day Endurance Run. Indorsed by Automobile Dealers' Association.
- April 30.....New York City, Endurance Run, New York Automobile Trade Association.
- May 3-6.....Harrisburg, Pa., Third Annual Endurance Run, 700 miles, Washington, Baltimore, Scranton, Motor Club of Harrisburg.
- May 10-13.....Detroit, Mich., Four-day Endurance Run, Detroit Automobile Dealers' Association.
- May 18-19.....Norristown, Pa., Second Annual Endurance Run, Norristown Automobile Club, to Hagerstown, Md.
- May 22.....Hartford, Conn., 200-Mile Endurance Run, Hartford Automobile Club.
- May 22.....Newark, N. J., Third Annual Endurance Contest, New Jersey Automobile and Motor Club, 190 Miles.
- May 31.....Wilkes-Barre, Pa., Annual Hill Climb, Giants' Despair Mountain, Wilkes-Barre Automobile Club.
- May 31.....Bridgeport, Conn., Annual Hill Climb, Sport Hill, Automobile Club of Bridgeport.
- June 1.....New York City, Start of Transcontinental Contest to Seattle, for Alaska-Yukon-Pacific Exposition, M. Robt. Guggenheim Trophy.
- June 12-14.....New York City, Catskill-Berkshire Endurance Contest, New York Automobile Trade Association.
- June 14-18.....Philadelphia Reliability Run to Pittsburg and Return, Quaker City Motor Club.
- June 18-19.....Chicago, Stock Chassis Race for Cobe Trophy and Light Car Race.
- June 21-26.....Binghamton, N. Y., Fourth Annual Endurance Run, Albany, Boston, Hartford, Newburgh, Binghamton Automobile Club.
- June 22-28.....Albany, N. Y., Fifth Annual Tour, Bretton Woods, Portsmouth, Boston, Albany Automobile Club.
- June 24-26.....Montreal, Blue Bonnets Track, Race Meet. R. M. Jaffray, Manager.
- June 25-26.....Philadelphia, 24-Hour Track Race. Quaker City Motor Club.
- July 3 and 5....Wildwood, N. J., Straightaway Races, Motor Club of Wildwood.
- July 4.....Los Angeles, Cal., Southern California Automobile Dealers' Association. Road Races, 250 Miles for Large Cars; 150 Miles for Light Cars.
- July 7.....Detroit, Start of Sixth Annual A. A. A. Tour for Glidden Trophy.
- Sept. 15.....Denver, Col., Start of Flag to Flag Endurance Run to Mexico City.
- Oct. 7.....Philadelphia, Second Annual Stock Chassis, 200-Mile Race, Fairmount Park, Quaker City Motor Club.
- Dec. 29-30.....Philadelphia, Fourth Annual Mid-Winter Endurance Contest, Quaker City Motor Club.

FOREIGN.

Races, Hill Climbs, Etc.

- April 11-18.....Austria-Hungary, Prague, Automobile Exhibition Hill Climb at Koenigsaal, Automobile Club of Tcheque.
- April 22-30.....France, Paris, Small Commercial Vehicle Competition.
- April 26-May 13...Germany, Commercial Vehicle Competition, Kaiserlicher Automobile Club.
- April 29.....Sicily, Voiturette Races.
- May 2.....Sicily, Targa Florio, Automobile Club of Italy.
- May 6-9.....Austria, Small Vehicle Competition, Automobile Club of Austria.

SPEARE AT A. A. A. HELM; HOTCHKISS ON NEW JOB

BOSTON, April 6.—Lewis R. Speare, the newly elected president of the American Automobile Association, to-night was tendered a dinner by the directors of the Bay State Automobile Association, the presidency of which he recently resigned because of his increased national duties. The function was made notable by the presence of the Massachusetts Highway Commission and well-known automobilists from various parts of the State, in addition to several from outside the State.



President Lewis R. Speare.

Of course, the recipient of the honor heard many pleasant things said about him, including reference to his unselfish activities extending over a long period of years and expressions of confidence in his ability to increase the power and influence of the national body.

In the enforced absence of President-elect Tudor, of the Bay State club, Secretary Fortescue made an efficient toastmaster. The oratorical fusillade was long and varied. The members of the highway commission, Chairman Harold Parker, Col. W. D. Sohler, J. H. Manning, and Secretary A. B. Fletcher, supplied timely talk, and ex-Congressman Thomas Powers of Newton contributed the real eulogy of the center figure of the feast.

The "also spoke" list included A. B. Bliss, president Massachusetts State Automobile Association; J. O. Heinze, president Lowell Automobile Club; W. H. Chase, president Wachusett Automobile Club; J. P. Coghlin, president Worcester Automobile Club; S. L. Haynes, ex-president Automobile Club of Springfield; F. H. Elliott, secretary American Automobile Association; Charles J. Glidden, the globe girdler; J. C. White, secretary to the mayor of Boston, who was unavoidably absent; J. H. McAlman, president of the Boston Dealers' Association; E. A. Gilmore, president pro tem of the Boston Motor Club; A. G. Batchelder, and several others added to the hilarity of the occasion.

The dinner was held at the Hotel Carlton in the recently acquired clubrooms of the Bay State Automobile Association. Songs there were by an amateur quartette of rare excellence, and songs there were in which all present joined in the singing. Concisely summed up it might be said, as is often stated in the country weekly, that "a good time was had by those present."

REFUSES TO MAKE "JOY RIDING" A LARCENY.

ALBANY, N. Y., April 6.—Assemblyman Robinson secured unanimous consent to-day to the taking up and passing the bill to make it malicious injury to property and a misdemeanor to tamper with or injure a motor vehicle, which measure was similar to the one passed through the House Monday night. At the same time Senator Hill's bill to make it larceny to take an auto for a joy ride without the owner's knowledge or consent was received and referred to the Assembly committee on codes, having passed the Senate Monday night the same time that Assemblyman Robinson passed his anti-joy ride bill through the Assembly. The Assembly bill, however, only makes the crime malicious injury. This bill also contains the anti-tampering with an auto provision, and makes that a misdemeanor as malicious injury to property or interference therewith.

It is doubtful which of the bills gets to the Governor, as the Assembly codes committee would not stand for the bill making the joy ride larceny, and the Senate may amend the Robinson bill so as to make it larceny instead of malicious injury to property.

SURCHARGED with unselfish enthusiasm for a cause, and absolutely free from obligations that might prove embarrassing to his best efforts, William H. Hotchkiss, ex-president of the Automobile Club of Buffalo and ex-president of the New York State Automobile Association, on February 1, 1907, started out to make the American Automobile Association what the majority of its organizers intended it should be—the national body of automobilists of the country. Up to that time the A. A. A. had suffered a spasmodic existence, its demise having been imminent at several periods. But the national idea—first the local clubs, then the State organizations, and finally the whole cemented with a national board of directors and officers—survived because in the belief of the majority it was correct in principle and lived despite an emaciated treasury and leaders who made slow and indifferent progress with the poor tools at hand. There were only six State associations and about seven thousand members, with dues uncollected and requests for payment ignored.

Then it was that the man from Buffalo appeared on the scene, took up the work the others had thrown down, and soon made it evident that a real pilot had seized the helm of the A. A. A. ship, which no longer drifted, but set sail for a definite port. Of course, Hotchkiss antagonized some with his vigorous methods, but for every one lost he added a score to the growing army of automobilists, who were beginning to appreciate what its real work should be. Clubs were born and comatose ones revived by liberal quantities of the administrative juice, State work following as a natural sequence. National boards were formed with functions that were exercised, and while the machinery at first still creaked from its intermittent periods of disuse, the persistent application of lubrication soon had even the smallest cogs in consonant operation. Overseeing the job was the tireless disciple of Blackstone, whose energy often took him into a maze of details and made some of his lieutenants feel that either he should not waste his time in side channels or else their successors should be named.

This, however, was the nature of the man, for to insure success no detail was too small for his personal attention. Results, however, tell the complete story, and when the other week Judge Hotchkiss informed the A. A. A. directors that he could not serve out his third term, he relinquished the head of a national organization that had grown to 27 State bodies and over 21,000 members. Reluctantly the resignation was accepted, for it means the loss of a man who fought for the general good of automobiling and gave to it most generously of his time, which meant services that could not have been bought by any sum within the command of the association.

Called to the important and difficult place of superintendent of insurance of New York State, the Hotchkiss thoroughness and indefatigability will soon make itself manifest. Governor Hughes made no mistake in his selection.

Wheels are to be attached to an aeroplane which W. H. Martin, of Stark County, Ohio, has invented and built. These wheels will be 1 foot in diameter, and other changes have been made in the construction, the front rudder and the frame being altered before the plans for the next flight are arranged. Mr. Martin has been in correspondence with F. S. Lahm, of Paris, regarding engines.



Ex-President W. H. Hotchkiss.



Pathfinding Party of 1907 A. A. A. Tour.

"Phil" Flynn in center, next to him on left are Paul C. Wolff and Dal H. Lewis; on his right, Teddy Day (hatless) and Arthur Banker (leaning on mudguard of Pierce car).

DEATH OF PHILIP S. FLINN, OF PITTSBURG.

Philip Sheridan Flinn, of Pittsburg, Pa., a well-known automobilist, died in Atlantic City, Sunday, March 28, after a long illness, a result of acute stomach trouble, which affected his heart. Mr. Flinn had been especially prominent in automobile circles in connection with the annual Glidden tours. As a member of the touring board of the A. A. A., he took an active part in the pathfinding tour for the 1907 tour, and with his Pierce car made perfect scores in both the 1906 and 1907 tours. In the 1908 tour he did not enter, but he piloted the cars from a point north of Pittsburg to the last ridge of the Allegheny Mountains, east of Bedford Springs. Mr. Flinn was 44 years old.

DEATH OF PROMINENT QUAKER AUTOIST.

PHILADELPHIA, April 5.—Ferdinand M. Johnson, chairman of the contest committee of the Quaker City Motor Club, died this morning after but two days' illness. A slight cold, from which he had apparently recovered, developed into pneumonia. It is understood that Mr. Johnson's death will in no wise affect the schedule of events he had arranged for the coming season.

The dates for the endurance run to Pittsburg and return have been changed to June 14 to 18 inclusive, the former dates, May 11-15, being close on the heels of the Harrisburg run and but a few days previous to the Norristown run. The date for the 24-hour race has also been changed—from June 11-12 to June 25-26. The Orphans' Day run is scheduled for Wednesday, June 9. Entries for the road ability run to Atlantic City on April 24 are coming in rapidly.

DINNER TO DAVID BRUCE BROWN.

Thursday evening, April 1, the yacht room at the Hotel Astor, New York City, was the scene of a banquet, at which David Bruce Brown, the young amateur, who so successfully lowered records on the McIntosh 120-horsepower Benz at the recent Daytona meet, was the guest of honor. The dinner was given by the Benz Import Company, Manager Jesse Froelich acting as host. The guests included Hugh D. McIntosh, the well-known Australian sports promoter, and owner of the car which Brown drove; C. and Levi Weingarten, E. E. Maxwell, W. P. Buckley, Charles Scharfer, Jr., Willis B. Troy, Harry Fosdick, Fred. J. Wagner, C. B. Ames, E. E. Schwartzkopf, Baron William Giennauth, Wm. R. Kass, Ernest Stoecker, C. W. W. Donnelly, T. M. Simons, J. P. Muller, W. J. McBride, Duncan Curry, William Harrison and R. F. Kelsey.

Congratulatory speeches greeted Driver Brown, Manager Froelich and Owner McIntosh after the menu had been served, all of which were gracefully acknowledged by the trio in question. A life-size portrait of the German Kaiser adorned the wall back of the banquet table, and tiny German flags and American beauty roses formed the table decorations.

MRS. TAFT WILL DRIVE BAKER ELECTRIC.

WASHINGTON, D. C., April 5.—Mrs. William H. Taft, the "First Lady of the Land," has gone the President one better, for she will now operate her own car. She has recently placed an order for a Baker Queen Victoria electric with the Washington agent for the Baker Motor Vehicle Company, of Cleveland, and it will be delivered very shortly. The White House garage now has a White steam touring car and a Pierce gasoline limousine, so that the electric will complete the equipment of automobiles that has displaced the time-honored horse and carriage executive mansion outfits.

The car for Mrs. Taft will be the most elegantly appointed car ever built by the Baker company. It will be equipped with Exide batteries, handsomely upholstered in blue broadcloth; the coat of arms of the United States will be emblazoned on the door panels, and the interior will be noteworthy for its daintiness and refinement. That this decision of Mrs. Taft to drive her own machine will set a mark in the national capital is shown by the fact that since this was first known the Baker agents have had two requests for similar machines, one from the wife of an ambassador and one from the wife of a cabinet officer.

OVERLAND CLIMBS TO TOP OF GARAGE.

INDIANAPOLIS, IND., April 5.—Absence of hills, worthy of the name, in this vicinity makes it impossible for dealers to demonstrate the hill-climbing ability of cars which they handle. To obviate this difficulty, the Fisher Automobile Company has erected a structure from the side street to the roof of its garage, the length being 134 feet and the grade 39½ per cent. An Overland roadster made this climb in nine seconds flat, and this stunt was performed three times each day during the recent show week and always drew a crowd. The Fisher Company attributes many of the orders for 40 cars, which it took during the celebration, to this demonstration.



Overland Coming Down the Fisher Company's Artificial Hill.



Through Southern Florida in Premier "30s" with W. J. Bryan as Guest.

Michelin Starts the Racing Year Well.—At the recent speed carnival on the beach at Daytona, Fla., three new world's records were established on Michelin tires and two new world's records were secured last month at New Orleans during the Mardi Gras week contests. At Ormond David Bruce Brown won the DeWar Trophy, and established a new amateur world's record for one mile, and with the same car and Michelin equipment, he lowered the ten-mile world's record made by MacDonald on a Napier car away back in 1906. George Robertson, another Michelin enthusiast at Daytona, not to be outdone, wiped out the old five-mile records made by Lancia and Marriott in 1906 and established a new world's record for that distance. Other Michelin victories at Ormond include the one hundred mile contest for the Minneapolis Trophy; the two one hundred mile stock car events; the one mile invitation and the eight mile handicap. Michelins were again successful in all of the five laps of the interesting one hundred mile piston displacement contest, securing first, second and third place in every lap.

Immense Traffic at Franklin Factory.—As an index of industrial activity, figures are given showing the extent of the work of the traffic department of the H. H. Franklin Mfg. Co. at its automobile factory in Syracuse, N. Y. These figures show that for the past six months, constituting the first half of the present trade year, the shipments from the factory have aggregated 3,376,218 pounds. The shipments received include 2,399,477 pounds of merchandise, which with the addition of over 7,000,000 pound of coal, 1,000,000 pounds of lumber and several hundred thousand pounds of other commodities, makes a total of 11,367,675 pounds. In this period 342 freight cars loaded with Franklins have left the factory.

Times Square Automobile Company Enlarges.—The Times Square Automobile Company, of New York City, through its secretary, Jesse Froelich, has leased for a long-term of years the ground floor and basement of the property at 1591 to

1597 Broadway, at the northwest corner of Forty-eighth street. This will be added to the present quarters of the concern at 1599 and 1601 Broadway with an L to 215 and 217 West Forty-eighth street, giving it one of the largest establishments along the row. It is probable that the company will add several lines to those now conducted, chief of which will be the formation of a taxicab company, with a full line of cars.

Republic Rubber Company Opens Boston Branch.—Success in disposing of its tires in the territory around Boston, making it a principal distributing point, has obliged the Republic Rubber Company, of New York, to open its own office in that city. The branch will be located at 735 Boylston street, and a great deal of its trade will be in the staggard tread, which has proven popular there as well as in other large cities, where there are miles of smooth pavement.

Edison Company Uses an old Pierce Arrow.—After having been used continuously for five years by three different owners a 24-horsepower Pierce-Arrow has been placed in commission as a general utility car by the Edison Manufacturing Company of West Orange, N. J. The car is one manufactured in 1904. The only change made in the car was the removal of the tonneau and the substitution of a platform on which boxes and other material may be carried.

Morgan & Wright Enlarge Factory.—Building operations are now well under way at the factory of the Morgan & Wright Company, in Detroit, which when completed will increase the floor space of the plant by 20 per cent. The capacity of the factory has been taxed to fill orders, and last year it was run at night as well as day, so that additions became necessary.

Addition to Empire Tire Factory.—Empire Automobile Tire Company of Trenton, N. J., has decided to build an addition to its plant, because its trade has opened up so strongly that even by running at night as well as at day, it has been unable to care for its business.

Testing Track for Maxwell Factory.—The Maxwell-Briscoe Motor Company is having a half-mile testing track constructed at its Newcastle, Ind., factory, built of crushed stone, forty feet wide, and with curves well banked. It will cost about \$3,000.

Auto Factory for Council Bluffs, Ia.—The Nevada Motor Car Company has purchased the property at Washington avenue and Main street, Council Bluffs, and will shortly commence the erection of an automobile factory, to produce drays and trucks.

Camden Reduces Speed Limit.—Camden, N. J., has had its little say, and has reduced the speed limit of automobiles to eight miles an hour, and including motorcycles in the same category. The limit was formerly very reasonable—12 miles per hour.

Fisk Company Issues Comic Posters.—The Fisk Rubber Company has issued a set of comic posters in colors, which it has sent by request to a number of automobile clubs throughout the country, attractively framed.

IN AND ABOUT THE AGENCIES.

Crawford, Philadelphia.—The Philadelphia agency for the Crawford, which until a week ago was represented in that city by the Thomas M. Twining Company, has been taken over by the Crawford Automobile Company, of Philadelphia, with headquarters at Broad and Ridge avenue.

Velie: Minneapolis, Minn.—Mich Auto Company, for local trade; Deere-Webber Company continuing with wholesale trade.

Winton and Sterling: Des Moines, Ia.—Strong Motor Car Company, 917-19 West Grand avenue.

Fritchie: Los Angeles, Cal.—Electrical Construction Company, for southern California.

Brush: Freehold, N. J.—Frank Du Bois, for the western half of Monmouth County.

Anderson, Utica, N. Y.—Bailey & Bowne, Whitesboro and Wiley streets.

Oakland: Cleveland, O.—Avenue Motor Car Company, 1806 Euclid avenue.

Matheson: Newark, N. J.—Motor Car Company of New Jersey.

Velie: Los Angeles, Cal.—Standard Motor Car Company.

Matheson: Detroit.—J. P. Schneider, State agent.

American: Trenton, N. J.—Chauncey Van Horn.

Rambler: Opelika, Ala.—Walter Greene.

Moon: New Orleans, La.—E. F. Martin.

Roe: Opelika, Ala.—C. M. Cannon.

PERSONAL TRADE MENTION.

E. Percy Noel, advertising manager of the Moon Motor Car Company, of St. Louis, in addition to writing on technical and aeronautical subjects, is also engaged in lecturing on these subjects. He has spoken on "Locomotives of the Air" before the railroad men's branch of the St. Louis Y. M. C. A., and at the central branch on "Air Travel of To-day," both illustrated.

Willie Haupt, the young Philadelphian who was so successful in hill climbs and races last season with a Great Chadwick Six, has severed his connection with



An Up-to-date Albany Salesroom.

C. S. Ransom is the distributor for the Stevens-Duryea, Lozier and Chalmers-Detroit cars at Albany, N. Y., and has a fine location at 81 Chapel street, opposite the Hotel Ten Eyck. The dimensions, 30x75 feet, afford ample space for offices, a stock of automobile supplies and quite a number of cars.

the Chadwick Engineering Company, and while at present temporarily engaged, is looking for a high-speed car, with which to enter events this year.

Godfrey G. Luthy, secretary of the Bartholomew Company, of Peoria, Ill., the manufacturers of the Glide cars, is receiving the congratulations of his many friends upon the announcement of his approaching marriage to Miss Elizabeth A. Radley, which will occur in that city, April 20.

Ernest L. Ferguson, of New York City, has been elected secretary of the Contest Board of the A. A. A. Dai H. Lewis, who has been secretary has resigned to give all of his attention to his duties as secretary of the Automobile Club of Buffalo.

W. L. Walls, who has been acting manager of the Kansas City branch of the Studebaker Company, has severed his connection with that concern, and has taken a position as manager of the Maxwell-Briscoe Company's branch in St. Louis.

H. E. Rocklege has resigned from his position as manager of the Missouri Valley Automobile Company of Kansas City, Mo., and in the future will act as traveling representative of the Maxwell-Briscoe Automobile Company, of that city.

R. W. Harroun, the inventor of the Harroun bumper, is now associated with the Factory Sales Corporation of Chicago, in a selling capacity.

OBITUARY.

Jacob Neuman.—Jacob Neuman, vice-president and general manager of the Stein Double Cushion Tire Company of Akron, O., died on March 27.

TAXICAB AND TRANSIT.

Detroit, Mich.—The newly incorporated Taxicab Service Company has arranged to use Chalmers-Detroit cabs in its service, and all will have yellow hoods as distinguishing marks. The following officers have been elected: President, T. W. Henderson; vice-president, H. G. Lyle; treasurer, Geo. King; secretary and general manager, L. S. McCreery.

Frederick, Md.—Interests in Frederick, Md., are back of an enterprise to establish an automobile stage line between that city and Emmitsburg, 22 miles distant. Fast machines to Harmony Grove, Hansonville and Mount St. Mary's College will be running by May.

RECENT INCORPORATIONS.

Kissel Motor Car Company, New York.—Capital \$50,000. To manufacture horseless vehicles, motors, engines, carriages and wagons. Incorporators: F. S. Waldo, Andrew Kirkpatrick, J. G. Fitzgerald, 214 West 80th street, New York City.

William Stevenson Garage Company, Morristown, N. J.—Capital \$50,000. To manufacture, repair, etc., automobiles, etc., general automobile garage business. Incorporators: William Stevenson, Annie C. Stevenson, W. W. Crane.

Armstrong Buggy Company, Atlanta, Ga.—Capital \$25,000. To buy and sell buggies and automobiles and other vehicles, and to maintain garages. Incorporators: R. K. King, D. D. Armstrong, Thos. Scrutchin.

Originator Mfg. Company, Jersey City.—Capital, \$125,000. To build automobiles and do a general merchandise business. Incorporators: V. J. Mills, New York; J. C. Inwright and B. L. Inwright, Jersey City.

Phoenix Auto & Raincoat Company, New York.—Capital \$10,000. To manufacture auto and rain coats and female wearing apparel. Incorporators: Jacob and Norman Lederer and Herman Rosenberg.

American Mors Company of Illinois, Chicago.—Capital \$25,000. To manufacture and deal in automobiles and other motor vehicles. Incorporators: E. W. Pottle, Rudolph Goefert, G. J. Meier.

Roy A. Faye Company, Boston.—Capital \$50,000. To do a general automobile business. President, R. A. Faye; treasurer and clerk, F. D. Bennett.

Motor League of America, Syracuse, N. Y.—Capital \$100,000. To manufacture motors, engines, cars and vehicles. Incorporators: A. A. Schlachter, Ernest Woods, T. A. Levy.

Pittsburg Auto Delivery Company, Camden, N. J.—Capital \$125,000. To carry on an automobile delivery business. Incorporators: W. A. Pitts, A. Wood, V. A. Murray.

Pittsburg Auto Delivery Company, Pittsburg.—Capital \$125,000. To construct vehicles of every kind. Incorporators: W. A. Petters, A. Wood, V. A. Murray.

Griswold Garage and Machine Co., Port Jefferson, N. Y.—Capital, \$20,000. Incorporators: F. C. Griswold, L. H. Chambers, F. C. Dildene, J. B. Overton.

Aero Club of Dayton, Ohio.—Incorporators: G. W. Shroyer, Dr. L. E. Custer, G. R. Wells, F. C. Carter, P. M. Crume, William Dennick.

Mitchell Motor Car Company, Racine, Wis., has filed an amendment increasing its capital stock from \$500,000 to \$1,000,000.

SELECTED AUTO PATENTS.

Issue of March 30.

916,465. Carbureter.—Ralph L. Looby, New York City. Filed Sept. 9, 1908.

This device has an entirely new method of vaporizing the fuel, which consists of allowing it to flow down a spiral passage through which the air flows, but in the op-

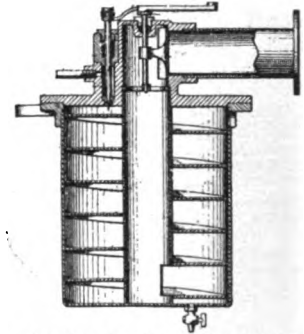

Section Looby Carbureter.

posite or upward direction. The spiral passage surrounds a central chamber in which may be hot air, thus assisting in vaporization. The throttle valve which controls the outflow of gas is at the top, as is also the gasoline inlet. This arrangement makes the whole device exceedingly simple.

916,491. Rotary Engine Valve.—Joseph Rothschild, Bayonne, N. J. Filed Feb. 18, 1908.

916,529. Attachment for Vehicles.—Edwin F. Brown, Chicago. Filed May 6, 1907.

916,678. Automobile Tire.—Bruno R. G. Darre, New York City. Filed Nov. 9, 1908.

916,694. Spark Timer.—Herman W. Gabel, Fond du Lac, Wis. Filed Oct. 14, 1907.

916,784. Vehicle Tire.—Barton Ross, Buffalo, N. Y. Filed Sept. 24, 1907.

916,871. Spark Plug.—Gabriel P. B. Hoyt, New York City. Filed March 25, 1908.

916,888. Axle for Motor Road Vehicles.—Louis Renault, Billancourt, France. Filed Dec. 12, 1906.



Farmer Goepfert in His Rambler Inspecting Corn Bins.

At Abilene, Kan., W. H. Goepfert owns one of the largest corn farms in the State. He uses a Rambler in all his trips about the place. In the background 1,200 bushels of corn are shown in the cribs.

INFORMATION FOR AUTO USERS

A Handy Tire Repair Kit.—A very complete and compact repair kit, suitable for repairing all makes and types of automobile tires, is manufactured and sold by the Michelin Tire Company, Milltown, N. J. This outfit, which is shown in the illustration, includes one elbow lever, one spur lever, one tube of talc, one roll of friction fabric, two tubes of Michelin patching cement in a metal

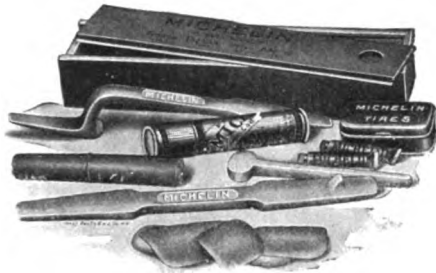

MICHELIN TIRE REPAIR KIT.

box, four red rubber patches of different sizes with beveled edges and one dummy valve. These various components are contained in a substantial and well finished wooden box with sliding cover. Several of the articles mentioned are worthy of special mention, including the Michelin elbow and spur levers, which greatly reduce the labor involved in putting in place or removing clincher tires of all types. These tools are very strong, well finished, and form a useful addition to any repair kit. The illustrated instructions that accompany the Michelin outfit show clearly the various operations in which these tools are used.

Michelin patching cement, two tubes of which are contained in this repair kit, is made of pure unadulterated dissolved Para rubber. It is one of the strongest and most satisfactory cements on the market and may be purchased in larger quantities in both tubes and cans of various sizes for private use and for garages and repair stations.

Casgrain Speedometer.—This instrument employs for its principle one of the oldest-known forces—liquid motion. A certain quantity of liquid is confined within a cylinder with absolutely no chance of escape, as the shaft connections are made above the level of the

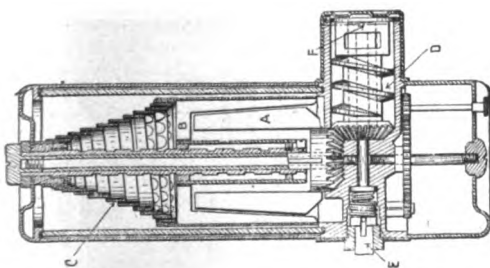

SECTION VIEW CASGRAIN SPEEDOMETER.

liquid; and as a further precaution, the gear marked C in the sectional illustration shown, is fitted with a worm, which when revolved excludes all oil from the tubular projection, within which the only outlet is enclosed. Thus a certain amount of oil confined within a certain space, is rotated by paddles marked A, at a certain speed, thus setting up a liquid motion in suitable proportion to

the speed at which paddles marked A are revolved. This current in turn, sets up a drag on paddles marked B, to which indicating dial is fixed, and it is this drag which causes indicating dial to be rotated on a spiral shaft, marked C, against a compensating spring in suitable proportion to speed at which paddles A are rotated.

By the above means the large individual figure is shown at the indicating point for every consecutive mile on the scale. The scale is 28 inches long, passing four and one-half times round a cylinder of 2 1/4 inches diameter. The absence of any mechanical connection between the driving mechanism and the indicating dial, is, with the view of eliminating inaccuracy that may be caused from wear, and absolute steadiness is claimed because the liquid absorbs the vibration. Each figure on the dial is placed by hand according to individual electrical test, each figure being put in its proper location regardless of its position in relation to another. The Casgrain speedometer is manufactured by the Couch & Seeley Company, 10 Thacher street, Boston.

Bowser Direct Lift Garage Storage.—Gasoline has to be safely housed, and for convenience in drawing supplies from time to time, S. F. Bowser & Company (Inc.), of Fort Wayne, Ind., offer what is catalogued as the "direct-lift" system, which, however, is but one of the many Bowser plans, all of which are fully described in Bowser literature. In the direct-lift system the gasoline is stored in a steel tank under the ground and the pump is placed directly over the storage tank, thus making a low-priced, safe system for the storage of automobile gasoline. In these days when the quality of gasoline is none too good, it is necessary to conserve what is left of quality in it, and it can be done if the gasoline is removed from the package and stored in steel tanks built for the purpose.

A New and Popular Igniter.—The American Igniter, manufactured by the American Electric Fuse Company, Muskegon, Mich., is a combination of timer, coil and distributor enclosed in a single case, dust, heat and moisture proof, and so designed that it can be mounted directly on the cam or timer shaft, thus freeing the dashboard of the coil boxes and vibrators. The coil is a large and powerful one, and is non-vibrating. It is designed to operate any number of cylinders, and has a large winding area. Its makers assert that they have been able to nicely determine in its construction the proper proportion between the primary and secondary coils, thus securing the maximum efficiency with the minimum of current consumption, and an exceptionally hot spark on 2-5 amperes of current is the result. But one adjustment is required to regulate the spark for any number of cylinders. Although this igniter has been on the market for a short time, the makers have found it necessary within the last month to order approximately \$10,000

worth of new machinery to care for the rapidly growing business. As will be seen, the American Igniter is a complete ignition system. The makers guarantee it to be satisfactory in every respect.

Reflex Spark Plugs.—Several new ideas in design are embodied in the spark plugs being made by the Reflex Ignition Company of Cleveland, principally dealing with the core and insulation. The plugs are of the condenser type, the steel electrode and baffle plate being machined integral, and the tip is made of an alloy which will not oxidize or warp. The insulation is double, the inner section being rolled lengthwise on the core from a thin strip of pure mica. The outer sections are simply mica washers, to act as a protection to the inner insulation, and there is no packing required, for the core is held in position by bronze seats. The nose has two ports for escaping gases, and a baffle plate, which is a new feature, inasmuch as it is claimed to keep the oil from reaching the insulation. The shell is machined from cold-rolled steel and tempered, the spark gap having a specially machined beveled rim. The plugs are made in standard, metric, A. L. A. M. and half-inch threads, and interchangeable porcelains can be furnished.



REFLEX SPARK PLUG.

Tungsten Lamps Used.—The new tungsten lamp, in which life, efficiency, and rugged service are as pronounced features, made it possible to consider electric lighting in cars as a permanent thing. Black Manufacturing Company, of Fort Wayne, Ind., taking advantage of the utility of the tungsten lamp and with a fine display of inventive faculty, completed a system of lighting for automobiles, in which the company's very efficient battery plays an important part. Then, the new "Parabolic" reflector, as here illustrated, has much to do with the success of the Black system. The company reports this system of lighting as in brisk demand.

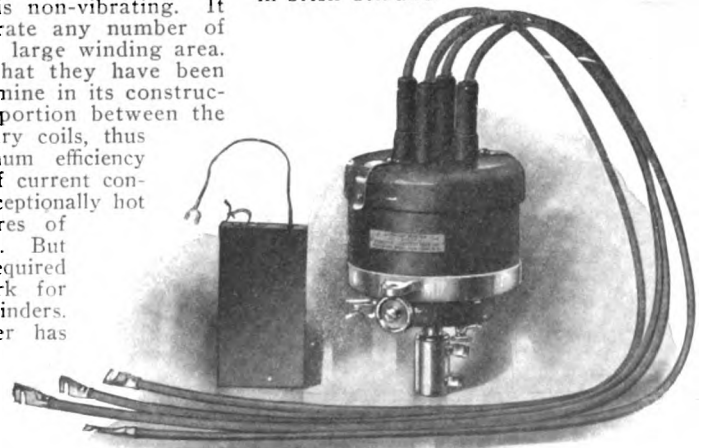

AMERICAN IGNITER AND WIRING TO THE SPARK PLUGS.

INDEX TO ADVERTISERS

Acetylene Gas Illuminating Co. 52
Acme Motor Car Co. 56
Adams Co. 56
Ajax-Grieb Rubber Co. 98
American Ball Bearing Co. 71
American Carbureter & Improvement Co. 82
American Electric Fuse Co. 90
American Motor Car Co. 84
American Motor Truck Co. 75
Anderson Carriage Co. 62
Anderson Forge & Machine Co. 59
Apple Electric Co. 60
Ashton Valve Co. 52
Asphalt Ready Roofing Co. 69
Atwater-Kent Mfg. Works. 96
Austin Automobile Co. 83
Autocar Co. 71
Auto Car Mfg. Co. 91
Auto Tire Security Co. 86
Auto & Supply Mfg. Co. 52
Baker Mfg. Co. 71
Baldwin Chain & Mfg. Co. 59
Banker Windshield Co. 61
Barnrd-Johnson Auto Supply Co. 69
Barrett Mfg. Co. 110
Bartholomew Co. 98
Beilfuss Motor Co. 81
Billings & Spencer Co. 57
Bi-Cal-Ky Auxiliary Spring Co. 51
Bi-Motor Equipment Co. 51
Black Mfg. Co. 64
Blue Book 58
Bongartz Co. 53
Borbeln Auto Co. 57
Borne Schrymser Co. 91
Boston Auto Gage Co. 52
Bowser & Co., S. F. 53
Boyle & Co., John. 70
Brennan Motor Co. 75
Bretz Co., J. S. 61
Brown & Co., S. N. 57
Brownell Motor Co., F. A. 60
Brush Runabout Co. 68
Buckeye Jack Mfg. Co. 62
Buckeye Mfg. Co. 83
Buffalo Specialty Co. 90
Buob & Scheu. 57
Burnett-Compound-Spring Co. 70
Cadillac Motor Car Co. 56
Cameron Motor Co. 84
Canton Drop Forging Co. 59
Car Without a Name. 92
Chadwick Engineering Works. 73
Chandlee & Chandlee. 60
Chicago Auto Top Co. 64
Cleanola Co. 72
Cleveland-Canton Spring Co. 59
Colgan Co., J. W. 46
Collins & Son, G. A. 80
Columbia Lubricants Co. 52
Conn. Tel. & Elec. Co. 77
Continental Caoutchouc Co. 56
Continental Motor Mfg. Co. 62
Corbin Motor Vehicle Corp. 82
Cornish Friedberg Motor Co. 56
Covert Motor Vehicle Co. 56
Cullman Wheel Co. 53
Davies & Co., J. P. 63
Dayton Motor Car Co. 112
Dayton Rubber Mfg. Co. 56
De Luxe Motor Car Co. 56
Diamond Chain & Mfg. Co. 52
Diamond Rubber Co. 93
Dietz Co., R. E. 105
Dixon Crucible Co., Joseph. 62
Dow Tire Co. 71
Driggs-Seabury Ordnance Corp. 59
Duplex Co. 53
Duplex Coll Co. 53
Echo Horn Co. 80
Eclipse Machine Co. 53
Edmund & Jones Mfg. Co. 65
Eldredge Electric Mfg. Co. 52
Elmore Mfg. Co. 103
Empire Automobile Tire Co. 72
Everett-Metzger-Flanders Co. 83
Excelsior Supply Co. 65
Excelsior Tire Co. 60
Firestone Tire & Rubber Co. 70
Fisk Rubber Co. 93
Flentje, Ernst 81
Fort Pitt Motor Car Co. 56
Franklin Mfg. Co., H. H. 84
G. L. Economizer Co. 64
Gaeth Automobile Co. 84
Gearless Motor Car Co. 56
Gilbert Mfg. Co. 66
Goodrich Co., B. F. 104
Goodson Electric Mfg. Co. 73
Goodyear Tire & Rubber Co. 82
Gramm-Logan Motor Car Co. 56
Grand Rapids Spring Co. 53
Grout Automobile Co. 66
Grossman Co., Emil 78
Ham Mfg. Co., C. T. 60
Hardy Co., R. E. 52
Harris Oil Co. 58
Hartford Suspension Co. 82
Hart-Kraft Motor Co. 65
Haynes Automobile Co. 84
Heinze Electric Co. 65
Hemmeter Spark Plug Co. 68
Henricks Novelty Co. 72
Herschell-Spillman Co. 53
Herz & Co. 57
Hess-Bright Co. 59
Hill Dryer Co. 57
Hoffecker Co. 69
Hoffman, Geo. W. 53
Hotel Gibson House. 81
Hotel Woodstock 59
Howard Motor Works. 56
Hoyt Electrical Ins. Works. 60
Hydraulic Pressed Steel Co. 59
Indestructible Steel Wheel Co. 53
Interstate Automobile Co. 84
Jackson Automobile Co. 56
Jacobson Machine & Mfg. Co. 81
Jeffery & Co., Thos. B. 109
Jewell Motor Car Co. 74
K.-W. Ignition Co. 81
Karl Co., Adolph. 52
Kellom Co., Chas. F. 66
Keystone Lubricating Co. 97
Kimball Tire Case Co. 65
Klinsey Mfg. Co. 57
Kirkham Motor Mfg. Co. 85
Kissell Motor Car Co. 83
Kitsee Storage Battery Co. 63
Knox Auto Co. 96
Kokomo Electric Co. 77
Konigslow, Otto 59
Lansing Wheelbarow Co. 80
Larchmont Mfg. Co. 52
Lavalette & Co. 76
Leather Tire Goods Co. 56
Lehman Mfg. Co., J. H. 52
Leland Co., W. H. 81
Lexington Motor Car Co. 69
Life Publishing Co. 52
Lipman Mfg. Co. 53
Lobee Pump & Machinery Co. 53
Locomobile Co. of America. 56
Long Arm System Co. 70
Long Mfg. Co. 68
Loring Appliance Co. 52
Lucas & Co., John. 67
M. & E. Mfg. Co. 69
McCue Co. 56
Manasseh, Levy & Co. 64
Masury & Son, John W. 91
Matheson Automobile Co. 85
Maxwell-Briscoe Motor Co. 79
Mayo Radiator Co. Cover
Metz, Chas. H. 84
Mica Core Mfg. Co. 89
Michellin Tire Co. 56
Midland Motor Car Co. 33
Miller, Chas. E. 38
Mitchell Motor Car Co. 34
Model Automobile Co. 99
Molline Automobile Co. 83
Moon Motor Car Co. 56
Mora Motor Car Co. Cover
Morgan & Wright. 71
Morrison-Riker Mfg. Co. 80
Mosler & Co., A. R. 89
Moss Photo Engraving Co. 89
Moss Photo Engraving Co. 89
Motz Clincher Tire & Rub. Co. 56
Muttly Co., L. J. 57
Myers Auto Top Co. 57
N. Y. Gear Works. 60
N. Y. Sporting Goods Co. 57
National Welding & Mfg. Co. 80
National Brake & Clutch Co. 59
National Motor Vehicle Co. 37
New Departure Mfg. Co. 100
Nightingale Whistle Mfg. Co. 93
Nonkroda Co. 68
Nordyke & Marmon Co. 56
Northway Motor & Mfg. Co. 98
Nuttall Co., R. D. 59
Oakland Motor Car Co. 32
Olds Motor Works. 56
Omar Motor Co. 99
Orange Machine & Mfg. Co. 82
Overland Automobile Co. 94
Owen & Co., R. M. 56
Packard Electric Co. 69
Packard Motor Car Co. 111
Palmer & Singer Mfg. Co. 56
Pantasote Co. 96
Parish & Bingham. 59
Parker, Stearns & Co. 57
Peerless Motor Car Co. Cover
Pennsylvania Auto Motor Co. 83
Perfection Spring Co. 59
Petre Carbureter Co. 75
Petrel Motor Car Co. 84
Peugeot Freres. 59
Picrome Hide Co. 57
Pittsfield Spark Coil Co. 67
Premier Motor Mfg. Co. 101
Prest-O-Lite Co. 107
Price Co., Henry W. 82
Prosser & Sons, Thos. 73
Puritan Gas Tank Co. 52
Quincy-Manchester-Sargent Co. 57
Raimes & Co. 52
Rajah Auto Supply Co. 62
Reflex Ignition Co. 80
Remy Electric Co. 57
Republic Rubber Co. 57
Reynolds, Harry H. 60
Robert Instrument Co. 52
Royal Equipment Co. 57-80
Rushmore Dynamo Works. 51
Sallsbury Wheel & Mfg. Co. 52
Schrader's Sons, A. 52
Schubert Bros. Gear Co. 57
Seiden Motor Vehicle Co. 83
Shaler Co., C. A. 85
Shawver Co. 63
Simplex Motor Car Co. 87
Sireno Co. 52
Skinner & Skinner. 91
Smith Co., A. O. 92
Spacke Machine Co., F. W. 59
Spare Motor Wheel of Amer. 69
Speed Changing Pulley Co. 75
Speedwell Motor Car Co. 61
Spicer Universal Joint Mfg. Co. 53
Splittdorf, C. F. 63
Sprague Umbrella Co. 68
St. Louis Supplementary Spiral Spring Co. 76
Standard Co. 60
Standard Connecting Rod Co. 64
Standard Roller Bearing Co. 68
Standard Sales Co. 52
Standard Welding Co. 73
Stanley & Patterson. 74
Star Speedometer Co. 97
Stearns Co., F. B. 89
Stein Double Cushion Tire Co. 88
Stevens-Duryea Co. 95
Stewart & Clark Mfg. Co. 55
Stromberg Motor Device Co. Cover
Studebaker Automobile Co. 82
Swinehart Clincher Tire Co. 70
Syracuse Alum. & Bronze Co. 59
Syracuse Chemical Fire Extinguisher Co. 76
Thomas Motor Co., E. R. 82
Timken Roller Bearing Axle Co. 100
Tiresole Mfg. Co. 72
Tray Plate Battery Co. 70
Trenton Rubber Mfg. Co. 53
Trimont Mfg. Co. 73
Troy Carriage Sunshade Co. 66
Tucker, C. F. 52
Tudor Mfg. Co. 76
U. S. Fastener Co. 73
Uncas Specialty Co. 66
Underwood Typewriter Co. 92
Universal Tire Protector Co. 81
Vacuum Oil Co. 88
Veeder Mfg. Co. 86
Vehicle Specialty Corporation. 61
Velle Motor Vehicle Co. 76
Victor Clutch Compound Co. 57
Victor Tire Traction Co. 70
Walker Auto Tire Band Co. 76
Warner Instrument Co. 94
Watt-Detroit Carbureter Co. 70
West Chain Tire Grip. 80
Weed Elec. Instrument Co. 74
Western Motor Co. 70
Wheeler & Schebler. 108
White Co. 106
White & Bagley Co. Cover
Whitlock Coll Pipe Co. 73
Whitney Mfg. Co. 70
Wildner Machine Works, C. A. 70
Willard Storage Battery Co. 69
Willett Engine & Carbureter Co. 93
Winship, W. W. 72
Winton Motor Carriage Co. Cover
Witherbee Igniter Co. 52
Wyman & Gordon Co. 51
York Motor Car Co. 61

Advertisement for J. W. Colgan Co. featuring various automobile brands and logos such as Mitchell, Emore, Cadillac, Rambler, National, Acme, Columbia, Pullman, and Haynes. The text includes 'MONOGRAMS AND NAME PLATES', 'ALL STYLES', 'WRITE FOR OUR LATEST CATALOG', 'ALL SIZES', and 'SUDBURY BUILDING - BOSTON, MASS.'

THE AUTOMOBILE

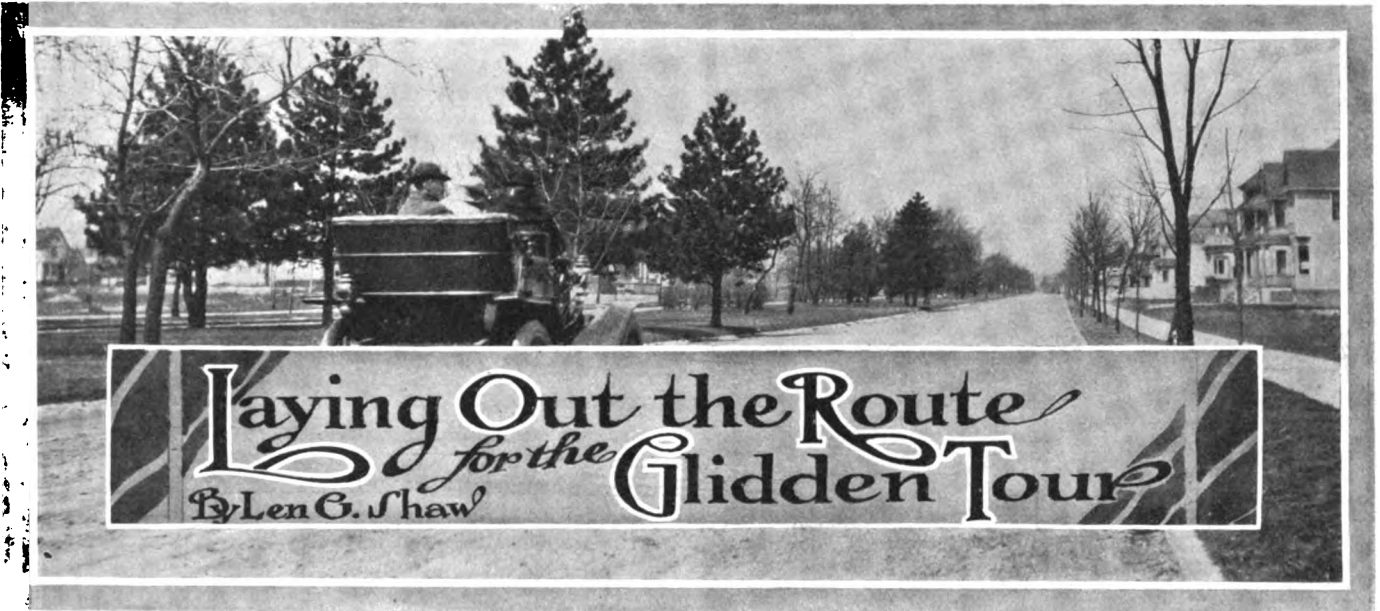

Pathfinding Party of the A. A. A. Annual Tour Before Leaving Detroit on Its Arduous Spring Journey.

DETROIT, April 12.—With great éclat the E-M-F "30" car that will act as pathfinder for the Glidden tour pulled away from the Hotel Pontchartrain this morning and started on the six weeks' grueling trip which will take it to Chicago, Minneapolis, Omaha, Denver and back to Kansas City, where next Summer's journey and contest for the Glidden Trophy will end.

It was a fitting send-off that the car and its occupants received. Members of the Detroit Automobile Dealers' Association, to whose efforts was largely due the securing of the A. A. A. tour start from this point, and a great number of motoring enthusiasts were on hand to wish the tourists good luck and accompany them out of town. The Pontchartrain was thronged with curious mortals for hours before the time set for the start, and the pathfinding car, stationed in Cadillac square, adjoining the hotel, was the center of attraction for a crowd that at times seriously interfered with traffic. It was a good-natured assemblage, and when at last the "pathfinder" and consorts started off on the first stage of the trip a mighty cheer went up.

Secretary Dai H. Lewis, whose fondness for the feathers once he has reached them is proverbial, but who can check his slumber before the alarm clock has finished its get-up song, broke his record by getting up bright and

early. Lazarnick, the snap-shooter, too busy elsewhere, sent his associate, Kron, who will cover the trip. The party got away in good season, the sun coming out from under the clouds long enough to bid adieu, with a 40-mile "zephyr" from the South giving assurance of plenty of fresh air on the opening day, at least.

It is worthy of note that the E-M-F "30" which will carry the pathfinders through to their destination and then make its way back to Detroit came out of the finishing room at the factory at just noon on Saturday last, with never a taste of the road up to that time. Whisked off the elevator, the commutator was given a slight adjustment, and George Meinzingler, the driver, who will take the car through, E. Leroy Pelletier, the advertising manager, and one or two others climbed in and gave the car its first touch of the strenuous life. A run of a few miles, and it went back to the factory to have tire cases, luggage holders, and other appliances fitted, and was ready to start that afternoon, if needs be. No special preparation was made, a stock car taken from the regular factory run being selected, showing the thoroughness with which the E-M-F product is made. President Lane of the D. A. D. A. handed a flag to Lewis to present to the Denver Automobile Club. "Tell them we will come and get it in July," said Lane.



Detroit Possesses Beauty.



Pelletier Entertains Lewis.



AUTO CLUB'S HOME AT PINE LAKE



WHERE THE MOTOR BOATISTS HOLD FORTH



HOTEL TULLER, HOME OF DETROIT DEALERS' ASSOCIATION



HOTEL PONTCHARTRAIN START OF THE TOUR



ENTRANCE WATER WORKS PARK

Of course, Dai H. Lewis, secretary of the Contest Board, will make the entire journey in the car, as will the driver, Meinzinger, no mechanic being carried. Mr. Pelletier will go the greater portion of the way. In addition a member of the local press will be picked up at each important point, continuing with the party until the next man relieves him. This gives variety, and at the same time stimulates local interest.

Six Weeks Required to Lay Out Tour.

Pathfinding, as the initiated know, is no sinecure. The distances must be carefully computed, every distinguishing mark along the route noted, every turn or cross-roads photographed, and an astounding amount of detail looked after. On the six weeks which will be occupied by the pathfinders it is expected that not less than one thousand photographs will be taken. No attempt at breaking records will be made, owing to the exacting nature of the work. The journey will be made by easy stages, as easy stages go at this season of the year. The trip is undertaken fifteen days earlier this year, but no difficulty is anticipated.

Preliminary to the start, a dinner was tendered officials of the Detroit Automobile Dealers' Association, members of the local press and few others at the Hotel Portchartrain, Sunday evening, Dai H. Lewis being the guest of honor and E. Leroy Pelletier acting as host. In the course of his talk Secretary Lewis stated that to date 29 entries had been received, as against six at this time last year, and he fully expected that by the closing date the number would total one hundred.

Now Possible for an Individual to Win Glidden.

This year, for the first time, it will be possible for an individual entrant to win the Glidden trophy. It will not be a competition between clubs, and there will be no teams. The winner of the Glidden prize will have personal custody of it for a year, it being a perpetual trophy. There will be a new Hower trophy for runabouts, which will become the permanent possession of the winner as in former seasons. This year there is also a new prize for cars with miniature bodies, or double rumbles. This is known as the Detroit trophy, it having been subscribed for and presented by the motorists of that city. The Glidden deed of gift had to be altered to permit of its going to an individual instead of a club, and the rules of the contest have been modified accordingly, the changes being such that a single winner is certain to be evolved. The cars will be classified and penalties will be imposed in fractions of a point for repairs and replacements.

The tour will be a little longer than usual this year, but not much more strenuous, except that the rules will be more exacting to prevent the large number of tied scores there have been at the finish in former years. Some poor roads will be encountered west of Chicago, but Glidden contestants will not be surprised at anything in this line and it is expected that the average daily distance covered will be as great or greater than in former years.

The most distinctly novel feature of the tour this year will be the arrangements for the overnight accommodation of the contestants over a part of the distance west of Chicago. Arrangements are being made to have a group of sleeping and dining cars accompany the tour and be sidetracked at the various night stopping places. This is necessary because of inadequate hotel room. It will obviate the annual bickering about "a room and bath" in places where there are not enough for all, and also it will make it compulsory to exclude women from the tour. The cars will afford accommodations at a lower cost than hotels.

What Happened the First Day's Journey.

JACKSON, MICH., April 12.—The first day's grind of the Glidden pathfinder came to a close late this afternoon, Jackson being the stopping point for the night. No attempt at making time marked the journey, but the 75 miles were covered in six hours, including a stop of one hour at Ann Arbor for dinner and numerous halts along the line while Secretary Lewis and Photographer Kron secured data and pictures for the use of the tourists next July. This day's run would not be worth chronicling were it not for its value in showing what can be accomplished over southern

Michigan roads. A 30-mile head-on wind blew all day, at times assuming the proportions of a gale.

But when it was all over to-night Secretary Lewis was jubilant. "Fine roads, as good as I ever encountered, particularly at this time of the year," said the veteran pathfinder. "When you can make a run like that in the middle of April, there is no limit to what you can accomplish in the middle of July."

Pathfinder Encounters an April Snowstorm.

KALAMAZOO, MICH., April 13.—The pathfinder had a most strenuous day, forcing its way through a blinding snowstorm during the greater part of the forenoon. The party reached here this afternoon, after navigating roads that were miniature lakes. South Bend is the destination of Wednesday night.

ABOUT THE CITY OF THE STRAITS.

DETROIT, April 12.—Brief though their stay may be, Glidden tourists who foregather in Detroit in July, making this the starting point of the year's big event in motordom, will long have reason to remember with pleasure their visit here. Every waking hour—and the others will be few—will be monopolized by the local entertainment committee, and from the time the vanguard arrives until the last tourist has left the city, there will not be a dull moment.

Those whose interest centers in the motor industry will find more here that is worth while than in any other city in the world. Detroit is admittedly the hub of the automobile industry, being among the first to produce practical cars, and leading the procession from that day to the present time. It has ten of the largest factories devoted to the manufacture of motor cars ranging in price from a few hundred dollars up as high as the purchaser may desire to go, and a score of smaller plants. This season they will produce all told in excess of 50,000 cars—not press agent, but real ones—all of which will be sold for real money. These cars will have a market value of considerably more than \$55,000,000. If placed end to end they would make a string more than eighty-five miles in length, and would be able to transport an army of 200,000 men at one time.

Will Have Entree of the Big Auto Plants.

The Gliddenites and others who gather here at that time will be given entrée to all these factories, affording them an insight into the magnitude of the industry and what the production of a high-grade automobile involves that they have hitherto lacked.

Motor enthusiasts will find at the Packard Motor Car Company's plant the most complete institution of its kind in America, if not in the world. A stockholder once facetiously remarked that just as often as they got a few dollars ahead orders were placed for a fresh supply of building materials and began an addition to the factory. This isn't quite true; if it was they would be building all the time. However, not a year passes without extensive additions to the plant that, even to the experienced, seems sufficient for all time to come, and which now embraces something like eighteen acres of floor space. It isn't that the Packard Company produces so many cars. It's output this season will be around the 2,000 mark. But—"ask the man who owns one"—it is the infinite care expended on every detail, and the fact that the car in its entirety is made under the Packard roof, that requires such facilities.

The Cadillac Motor Car Company is another concern that manufactures automobiles instead of making them, a distinction too often overlooked. The Cadillac plant is one of the wonders of the automobile world, and it will turn out some 9,000 cars.

There is the Ford Motor Company, pioneer in the low-priced medium-power field, and one of the largest producers of automobiles in the country. Just now every energy is being bent toward getting into its fine new plant at Highland Park, a suburb of Detroit, but in spite of the handicap of attempting to run two places at one and the same time the Ford Company will this season turn out something like 20,000 cars.

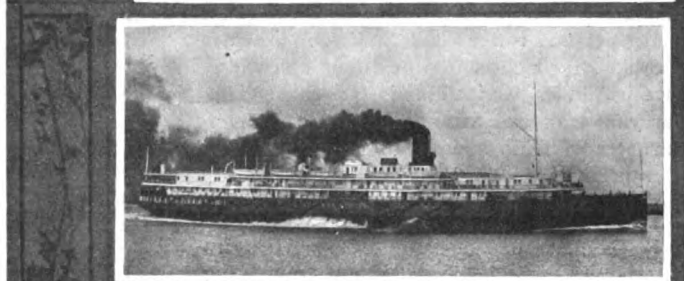

The E-M-F, which since its organization, less than a year ago, has kept the trade guessing, and which will this season put on the market, and sell, some 8,000 of the popular "E-M-F 30" cars; the Chalmers-Detroit, with one of the best equipped plants imaginable and an output in excess of 3,000 cars; the Blomstrom Gyroscope, the Regal, Brush Runabout, and Hereshoff, one of the most recent additions to the local colony, but which has already achieved pronounced success; the De Luxe, and nearly a score of lesser lights, are numbered among the concerns that are making Detroit famous and providing the country with automobiles. One can obtain luxury or practice economy.

Detroit Has Many Notable Attractions.

But it will not be necessary for Gliddenites to confine their attentions to automobiles, nor is it the intention of those in charge of the arrangements that they shall. Detroit has no peer in the matter of attractions. If there were nothing else, the Detroit River has given the city world-wide fame as a summer resort. Forming as it does the connecting link between the upper and lower Great Lakes, it provides a marine pageant the like of which cannot be found elsewhere. Here during the months when navigation is possible, giant freight steamers carrying trainload after trainload of iron ore destined for the furnaces of Ohio and Pennsylvania and grain for Eastern and European mills, or bearing coal and general merchandise for the thriving cities and farming communities of the Northwest, pass Detroit on an average of 10 minutes apart, day and night.

Belle Isle, situated in the Detroit River at the eastern end of the city, is the finest natural park in America. From the shady driveways or the broad verandas of the Casino there is afforded an unobstructed view of the passing fleets, with Detroit, half hidden in the smoke from its multitudinous factories, stretching for miles along the river, while in the opposite direction are the broad waters of Lake St. Clair, with the Canadian shore, dotted by summer homes, in the distance. Nature dealt leniently with Belle Isle, and a thoughtful municipality has supplemented

its efforts in providing a beauty spot that outranks all others in the city where life is worth living.

There is practically no limit to the charming rides that can be taken in the vicinity of Detroit. Grosse Pointe, with its miles of macadam roadway, with Lake St. Clair on one side and "Millionaires' Row," the summer homes of Detroit's kings of finance, on the other, with the magnificent Country Club and golf courses, is one of the most popular points. You can motor out through Oakland County, up hill and down dale, in among the scores of little lakes that dot the district, or take a run to the home of the Detroit Auto Club, at Pine Lake, where every courtesy will be extended the Gliddenites. For a nominal sum the motorist who so desires can "go abroad," crossing the river, and upon the execution of a bond and the payment of a small license fee being permitted to spin—not speed, for such things are not tolerated across the border—along the "king's highways" in Canada.

Forsaking the auto for even a few hours, it is possible to board a palatial steamer and for an insignificant sum enjoy a cruise through the St. Clair Flats, the Venice of America, or, traveling in the other direction, witness from the deck of the steamer a marine parade that has no equal, passing on the way to Bois Blanc Island and other down-river resorts, the Hellgate of the Great Lakes, the Limekiln Crossing, upon which the United States government has spent upward of \$6,000,000, and where the greatest engineering undertaking of its kind in the world is now in progress, involving the expenditure of another \$6,000,000 in cutting in the dry a channel through miles of rock.

Headquarters for the Gliddenites will be at the Hotel Pontchartrain, but they will also be given full sway at the Hotel Tuller, home of the Detroit Auto Dealers' Association, and the other hostelries with which Detroit is so liberally provided. Arrangements for the entertainment of the visitors are proceeding apace, it being the determination of the D. A. D. A., the Board of Commerce, the local auto manufacturers and others to make the occasion a memorable one.



Fifth Avenue, New York, on Easter Sunday illustrated the General Use of Motor-Driven Vehicles.

EIGHT CLASSES ARE PROVIDED FOR BY M. C. A. RULES

EIGHT classes have been provided for by the rules committee of the Manufacturers' Contest Association, and five of these are according to piston displacements with minimum weight limits. The results were first the work of the special rules committee, selected from the general committee of twenty-five, and these were the men who struggled with the knotty problems: H. E. Coffin, Chalmers-Detroit Motor Car Company, chairman; A. L. Riker, Locomobile Company of America; George A. Weidely, Premier Motor Manufacturing Company; F. B. Stearns, The F. B. Stearns Company; Edgar Apperson, Apperson Brothers Automobile Company, and Paul LaCroix, Renault Freres Selling Branch.

The result of their work was then referred to the committee of twenty-five, which now officially announces through Secretary Russell A. Field what has been recommended to the contest board of the American Automobile Association, the adoption of which is foreshadowed in advance. The price classification of the American Automobile Association was readopted, with the stipulation that it apply to stock car events, making the complete classifications recommended for 1909 as follows:

Piston Displacement in Cubic Inches.	Min. Wght. in Lbs.	Class.	Price.
.....	8	Special
.....	7	Open
.....	6	\$ 850 and under
160 and under	1,200	5	851 to \$1,250
161 to 230	1,500	4	1,251 to 2,000
231 to 300	1,800	3	2,001 to 3,000
301 to 450	2,100	2	3,001 to 4,000
451 to 600	2,400	1	4,001 and over

Other changes were recommended, including the designation of a stock car, the new rule for which will read as follows:

STOCK CAR.—A motor car completely described in the manufacturer's catalogue for the current or any preceding year, which is manufactured in quantities of 25 or more, which is on sale by the regular selling representatives of the manufacturer and is manufactured ready for delivery to buyers. Top, wind shields, and extra tires may be removed. The muffler cut-out is optional.

In reference to stock chassis, the present clause reads:

STOCK CHASSIS.—A chassis, which without any changes whatsoever, except that lighter read springs may be used, can, by adding the necessary parts, be assembled into a complete stock car for which it is designed.

To it was added the following:

Vehicles for stock chassis races must be the product of a factory which has, during the twelve months prior to the date of the event, produced at least fifty (50) motor cars regardless of model. The A. A. A. minimum weight clause, with an allowance of 2 per cent., will govern. It is further provided that additions to the oil and fuel supplies, a change of steering gear angle of driving gear ratio and of tire and rim equipment are left optional with the entrant.

It was unanimously voted to recommend to the Chicago Automobile Club that its race for the Cobe Cup and the small car event to precede it both be for stock chassis and held under piston displacement classifications.

In the final adoption of the classes nearly every member of the general rules committee took part in the discussion. There were present at the meeting: Edgar Apperson, Apperson Bros. Automobile Company; A. P. Brush, Buick Motor Company; H. E. Coffin (chairman), Chalmers-Detroit Motor Company; C. H. Tangeman, Hol-Tan Company; C. M. Hamilton, Isotta Import Company; H. G. Farr, Knox Automobile Company; A. L. Riker, Locomobile Company of America; H. A. Lozier, Jr., and C. A. Emise, Lozier Motor Company; Benjamin Briscoe, Maxwell-Briscoe Motor Company; Alfred Reeves (proxy), Mitchell Motor Car Company and National Motor Vehicle Company; R. H. Croninger, Pennsylvania Auto Motor Company; E. P. Chalfant (proxy), Pierce-Arrow Motor Car Company; G. A. Weidely, Premier Motor Manufacturing Company; Paul Lacroix, Renault Freres Selling Branch; F. B. Stearns, The F. B. Stearns Company; F. A. Barker, Dayton Motor Car Company; Walter White, The White Company; E. Lillie, Itala Import Company.

CHICAGO'S TWO ROAD RACES ARE DEFINITELY ANNOUNCED

CHICAGO, April 12.—The sanction for the road racing carnival of the Chicago Automobile Club, June 18 and 19, has been granted by Chairman Hower, of the A. A. A. contest board, the local promoters having complied with all requests as to military protection, permission to use the course, and the financing of the events. In addition to this the A. A. A. chairman has permitted the Chicago club to modify the classifications of the Manufacturers' Contest Association because of the fact the new rules were designed mostly for 1910, while the Chicago events were outlined before the birth of the new organization.

Under this special dispensation the contesting cars for the Cobe trophy will be limited to a piston displacement of 525 cubic inches, while the weight limit has been reduced from 2,400 to 2,150 pounds.

The club has accepted the classification of the M. C. A. for the other event, which will be for light cars instead of being a "baby" race such as was run at Savannah. In this the piston displacement limit will be 300 inches, while in the way of a concession the weight limit has been knocked off entirely.

Probably the greatest triumph achieved by the Chicago Automobile Club is the securing of troops to guard the course, something unheard of heretofore outside of Georgia. The most remarkable part of it, though, is that permission has been given to take Illinois soldiers into Indiana for this purpose, the First Regiment of the Illinois National Guard having been secured for police duty. A camp for the troops will be established near the starting point, which will be on the east leg of the course about a mile and a half from Crown Point. The signal corps

of the regiment will run a military wire round the course, and the hospital corps will be on duty with all its paraphernalia, for ready duty.

Entry blanks for the two road races will be out this week, and of course no time will be lost in placing them in the hands of the manufacturers, most of whom seem eager to give the race strong support. The fees have been placed at \$500 for the first car, \$300 for the second, and \$200 for the third, both races to count in the total number. The classifications for the two races are as follows:

Cobe Trophy Race, June 19.—Open to stock chassis of 1909 models or earlier, of which ten have been built, and 1910 models, of which the parts for ten are on hand at the factory of entrant prior to June 1, 1909, manufacture of same to have commenced. The entrant is to furnish affidavit proving the eligibility of the entry under above conditions, and is to furnish a bond of \$5,000, made payable to the treasurer of the A.A.A., which bond is to be forfeited to the A.A.A. in the event of the entrant failing to construct ten cars according to his affidavit, said cars to be completed on or before October 1, 1909. This race will be approximately 410 miles in length, cover a 24-mile circuit over the public highway. Minimum weight of chassis, with tanks empty, 2,250 pounds; maximum piston displacement, 525 cubic inches in the whole engine.

Light Car Race, June 18.—Open to stock chassis under same conditions as the Cobe trophy race as to number of models built, etc., but not to have over a maximum piston displacement of 300 cubic inches in the whole engine. No weight limits imposed.

Optional Construction.—All must be stock except: Extra gasoline and oil capacity, no change in principle; any angle of steering column and gear; any gear ratio of driving system; any tire and rim equipment.

CONTESTS OF THE CHICAGO MOTOR CLUB.

CHICAGO, April 22.—An endurance run for cars listing at \$1,750 and under is planned for next month by the Chicago Motor Club, which to-day announced its card for the coming season. The opener will be a novelty in that it will be the first time special attention has been given to the popular-type car such as is represented in the division up to \$1,750. It will be a most thorough test, too, it being the idea of the club to ask the cars to go at least 500 miles in two days, fully as stiff a schedule as was used in the 1,000-mile four-day affair last fall. No exact route has as yet been mapped out nor have the rules been adopted, but the technical committee expects to have the regulations in shape for publication the latter part of the week.

In addition to this the Motor Club will stage its annual reliability for all classes between September 10 and October 30 at a distance not less than 1,500 miles. Last year the cars traveled 1,000 miles in four days. The annual hill-climb will take place as near August 14 as possible, and again the hills at Algonquin, Ill., will be used. Other events also are planned. One of them will be a skidding test and the other a taxicab demonstration. No dates have been set as yet for these two.

SAVANNAH'S HOPES TELL UNPRINTED STORY.

SAVANNAH, GA., April 8.—That Savannah is depending upon getting the next Grand Prize race can be seen from the work that is being done on the course.

If Savannah is successful in landing the next race, the drivers will find a complete new race course. Instead of having sixteen turns to make they will have only seven, the turns at Isle of Hope being cut out.

Ferguson avenue, which drivers claim to be the fastest section of the course, has been made 60 feet wide, with only an 11-inch grade from one end to the other, and it will be more than five miles long and will save from eight to ten turns. Seventy more convicts have been put to work on the course, these coming from different parts of the State.

AUTOISTS TO CELEBRATE OPENING OF BRIDGE.

NEW YORK, April 12.—Automobiles will take a very prominent part in the celebration of the formal opening of the new Queensboro Bridge. The week of June 12 will be taken up with various festivities, and Tuesday, June 15, and Thursday, June 17, will be given over to automobile sports. The plans call for a non-technical touring contest on Long Island on Tuesday, embodying some new features; and on Thursday a parade of decorated cars across the structure for three prizes, and a cash prize as a refund for the cost of decorating the winner. A committee has been appointed, of which A. R. Pardington, second vice-president and general manager of the Long Island Motor Parkway, Inc., is chairman.

NEW YORK PREPARES FOR CARNIVAL.

NEW YORK, April 12.—But ten days now remain before the beginning of the second annual carnival of the New York Automobile Trade Association, and dealers, owners and many others interested are making active preparations for the various events. The entry blanks for the hill climb and other contests will be issued at once, and the lists of those who have applied for the necessary blanks is evidence of the numbers which will enter. The voting for the king and queen has become spirited, and thousands of ballots have been cast. Arrangements for the parades, the dinner, the smoker and other festivities are nearly completed. The entire week of April 26 to May 1 will be used.

CLEVELAND TO HAVE DECORATION DAY CLIMB.

CLEVELAND, April 13.—The Cleveland Automobile Club announces that its climb of the Gates Mill hill will take place on Decoration Day.

ECHO OF STATEN ISLAND SPEED TRIALS.

NEW YORK, April 12.—An echo of the automobile race on the West Side boulevard, Staten Island, held under the auspices of the Automobile Club of America, on May 31, 1902, was heard on last Thursday when Judge Stapleton in the Supreme Court opened a sealed verdict of \$2,500 against the city of New York. The suit for \$10,000 was brought by Mary Bogart, wife of John T. Bogart, a spectator who was killed by the fast Baker electric, but the case was never settled until last week.

SEMI-ANNUAL REPORT OF ELECTRIC VEHICLE CO.

HARTFORD, CONN., April 12.—The semi-annual report of the receivers of the Electric Vehicle Company, Halsey N. Barrett and H. W. Nuckols, filed with the Superior Court shows a balance of \$151,356.13. Sales and charges on account for the period amount to \$215,485.91, with purchases of \$187,692.26. Under disbursements, the heaviest item was the pay-roll, which amounts to \$160,762.03, materials cost \$128,656.46, while the A. L. A. M. is credited with \$118,992.64. George B. Selden is credited with \$17,492.86.

VANDERBILT RETURNS FROM EUROPE.

William K. Vanderbilt, Jr., the donor of the famous cup bearing his name, and president of the Long Island Motor Parkway, Tuesday returned on the *Kronprinzessin Cecilie* from his Spring European trip. Mr. Vanderbilt declined to have anything to say to the daily newspaper interviewers, but expressed the intention of remaining in this country for the next eight months. Of course, he will give much attention to the completion of the Motor Parkway, and it would not be surprising if a race were arranged for the famous trophy, to take place as usual in the Fall.

CLEVELAND IS BUSILY SATISFIED.

CLEVELAND, April 13.—"How's business?" "Never knew it to be better." That's an almost daily conversation in the trade in Cleveland. From the agents of high-priced cars down to those selling machines for \$600, and from the largest dealers in accessories to those selling automobile grease on a commission the answer is the same. Business is good in all lines, and the trade is rejoicing as a consequence. The few warm days that Cleveland has experienced have served to start the automobile fever coursing up and down the veins of local motorists, and the stimulus mentioned is the result.

All the local factories are busy, some day and night, while the same condition holds true in many agencies.

SEATTLE PATHFINDER REACHES COLORADO.

Snow and bad roads have hindered the Thomas car which is laying out the route for the endurance contest from New York to Seattle, but Tuesday evening the crew succeeded in reaching Denver. They were delayed by the conditions at a number of places on their run from Kansas City, and were unable to reach Pueblo on account of the deep snow. It is expected that the party will leave Denver to-day for Cheyenne or Laramie, Wyo., and strike the roads toward the Northwest.

Kansas City was left last Thursday morning, and across the State enthusiastic receptions were met, automobilists and farmers joining in the celebrations. An impromptu reception was accorded the transcontinental travelers at Fort Riley and checking stations were established at a number of places. Pilot cars have been accompanying the Thomas since leaving Missouri and will probably be picked up from day to day.

President Taft has accepted the invitation to press the button which will give the signal to Mayor McClellan, of New York, to start the contestants by firing a golden revolver now being made for the purpose. Up to the present, four entrants have been announced, a Simplex, a Stearns and two Ford cars being listed. Henry Ford surprised the trade with the statement that he will enter two of his model T cars.



Official Starting of the Non-Stop Performer in Front of the Bay State A. A. Clubrooms, March 18.

BOSTON, April 12.—At 10:10 o'clock this morning the autometer on the Maxwell touring car that on March 18 began a 10,000-mile non-stop motor run ticked off the last fraction of a mile necessary to make the 10,000 total, and a new record for such a test had been established. The completion of the 10,000-mile total came when the car was near Framingham on the return journey from South Framingham. On board the car were the three drivers who have been at the wheel during the past twenty-five days, C. E. Goldthwaite (who was driving), Arthur See and Ellery Wright, and with them was Charles J. Glidden, of globe-girdling fame. On the car flew an American flag, which was given the car just before it began its last trip by Mrs. Charles J. Glidden. The flag was one which Mrs. Glidden obtained while in Japan on the last motor trip which she and her husband made to the East.

The finish of the 10,000 miles came a little earlier than had been anticipated, the official reception having been arranged for 4 o'clock in the afternoon. On this account the motor was not stopped, but was kept in motion and the car was run about through the suburbs until this afternoon, when the reception incidental to the official completion of the run was held. At 4 o'clock in the afternoon a large number of motorists, including nearly one hundred owners with their Maxwell cars, drove out to Coolidge's Corner, Brookline, about three miles from the city, and there met the car and escorted it into Boston, the procession moving over Beacon street and along Automobile Row, on Boylston street, to Copley square. There, at 4:21 o'clock, in the presence of a large crowd of people, Lewis R. Spears, president of the American Automobile Association, who started the motor on March 18, brought it to a stop.

The autometer then showed 10,074 4-5 miles. The car was at once turned over to a technical committee consisting of Professor Parks, of the Massachusetts Institute of Technology; Secretary James Fortescue, of the Bay State Automobile Association, under whose auspices the run was conducted; V. C. Charles, man-

ager of the Inter-State agency, and C. J. Bailey. This committee is to take down the car, make a thorough examination of all parts, and present its report later.

To complete the 10,000 miles' run the car was engaged just 600 hours 10 minutes consecutively, and all that time, with the exception of the few hours required in the stops to change drivers, take on supplies of gasoline and oil, change tires, and make a few repairs, the car was in motion, averaging while on the road between 18 and 20 miles an hour.

A total of 679 gallons of gasoline was put in the tank, and 388 3-4 quarts of lubricating oil was used. When the car had been running a little more than a week there was trouble with the off rear bearing, and this was repaired, but owing to the damage that had been done by the broken bearing it was necessary last week to put in a new rear axle. This was the only repair of importance made during the run. One spark plug was replaced and one of the push rods on the motor which showed an imperfection was changed. Toward the end of the run the muffler fouled, and it was necessary to do some work on that.

The nearest the motor came to stopping was a few days from the end of the test, when the wires supplying the electric light over the speedometer short-circuited with the wires from the batteries. Fortunately this accident did not interrupt the current from the magneto and the motor did not balk. Though the ignition system was reinforced at the beginning of the run, only the magneto was used while running on the road.

The tire record of the car was remarkable, for in the 10,000-mile trip only eight tires were used, the second set being in good condition at the finish. One of the original shoes was used until the car had been driven about 7,200 miles, and then it blew out. That was the only blowout. There was a small number of punctures comparatively, and they occasioned little delay, for the tires were on demountable rims and inflated tires were carried on the car at all times. Except when the car was in the garage for the work that was done on the axle, and the motor



Justice of the Peace Teale Swearing in the Drivers and Observers of the Non-Stop Run.

consequently was running for some time without a load, it was unnecessary to change or add to the water in the radiator.

The car was driven with care all the way through and the men at the wheel were experienced operators of Maxwells. A high-test gasoline was used and a high grade of oil. With these exceptions and the reinforced ignition system that was not used, the conditions of the run were similar to ordinary operation. No private owner's car, of course, would be subjected to such a test as the constant running of the motor for twenty-five days, and it is figured that the distance covered is at least twice that made in a year by the average owner. The constant vibration of the steady running motor showed its effect toward the end of the test in the breaking of several spring leaves. It was found that the vibration had brought about crystallization of the metal.

The run created a vast amount of interest all through New England, and as Frank J. Tyler, manager of the Maxwell-Briscoe Boston Company, issued a general invitation to people to ride in the car there were few day trips on which there were not one or two passengers. The day and night running was exceedingly trying on the drivers and observers, though there were three shifts, and they were pretty thoroughly tired out this afternoon. They were able, nevertheless, to accept the invitation of Sales Manager Kelsey and the Maxwell company to a dinner given them this evening at the Bay State Automobile Association rooms.

The run began at 10 o'clock in the forenoon of March 18 in front of the quarters of the Bay State Automobile Association, when Mr. Speare cranked the motor. During the first few trips, and when changes of route were made, the car was driven by Lucius S. Tyler, Ralph Coburn and William S. Simonds, of the Boston branch of the company. At other times the car has been piloted by Goldthwaite, See and Wright, of the Maxwell-Briscoe factory force. The official observers were Adam Schneider, Joseph George and C. F. Lawrence. All drivers and ob-

During the first week of the test, in which about 3,000 miles were covered, the car shuttled back and forth between Boston and Worcester. The weather was generally good, and the roads used excellent. On March 25 the route was changed to Providence, and the first night out a bad storm was encountered. The hood was carried away in the wind, and the driver and observer had to repair a puncture in a downpour of rain. The Providence route was followed for five days, bringing the total mileage to about 4,900. Then the car was shifted to Newburyport route, and for three days it was driven back and forth between Boston and that city. April 2, 3 and 4 the car went to Nashua, N. H., and since then it has been running between Boston and South Framingham.

The non-stop performer was fitted with Ajax tires and Continental demountable rims; utilized Splitdorf magneto and spark plugs; its mileage and speed were guaranteed by Stewart and Warner speedometers; and its lubricators were Havoline crystal oil and Keystone grease.

MAXWELL DRAWS THE CAMPBELL TROPHY.

NEW YORK, April 12.—At a luncheon given by L. H. Perlman, the first winner of the Chester I. Campbell touring trophy, Friday, at the A. C. A. clubhouse, Carl W. Kelsey was the successful one in the drawing between the 15 perfect score contestants, and becomes the owner of the valuable cup. The lots were drawn by a disinterested person under the supervision of Referee L. M. Bradley, and the last one drawn, No. 20, was that of Mr. Kelsey. Mr. Campbell, the donor, J. K. Mills and T. F. Moore, the managers, were present, and all of the fifteen either in person or by proxy.

Those at the luncheon were: C. W. Matheson, two Matheson cars; Guy Vaughn, Stearns; M. P. Batts, Stearns; H. A. Street, Cadillac; L. B. Le Duc, Cadillac; A. B. Cordner, Acme; W. W. Burke, Mora; J. I. Miller, Cleveland; V. P. Pisani, Zust; Paul Lacroix, Renault, and C. W. Kelsey, Maxwell. Those represented by proxy were: C. S. Carris, Franklin; Ray McNamara, Premier, and Albert Dennison, Knox.

PIERCE-RACINE MAKERS INCREASE CAPITAL.

RACINE, WIS., April 12.—Articles of incorporation have been filed at Madison for the Pierce Motor Company, of this city. The capital stock is \$300,000, and Charles McIntosh, A. J. Pierce and Frederick Robinson are the incorporators. Mr. McIntosh and Mr. Robinson are heavily interested in, and at the head of, the J. I. Chase Threshing Machine Company, of this city. Mr. Pierce has been for four years at the head of the Pierce Engine Company, and was one of the first builders of gasoline engines in the United States.

The company will take over the entire assets of the Pierce Engine Company, enlarge the plant, and push the sale of Pierce-Racine automobiles, motor boats and motors. Pierce-Racine automobiles are better known in the West than in the East, for the output has always been limited, although Mr. Pierce built his first one in 1893. The marine engines and boats, however, are well known all over the world.

The new corporation starts out under very favorable circumstances; the shops are running with a full force, on full time. There is no liability, and with ample working capital the building of 500 cars will be started at once. The line will consist of one five-passenger car listing at \$1,500, one five-passenger car listing at \$1,250, a runabout and a roadster.

GIVES KNIGHT-DAIMLER STRENUOUS TEST.

COVENTRY, ENGLAND, April 3.—A decisive answer to critics of the new Knight-Daimler slide valve engine has been given by the long endurance trial of two standard engines which has successfully ended to-day. The form of the trial was decided on by the technical committee of the R. A. C. and consisted, first of all, of a continuous full speed run on the test bench for 132 hours, the power developed on the brake not falling below 1.3 times the R. A. C. rating of the two engines, which were standard 22 horsepower and 38 horsepower types.

At the conclusion of this run the engines were erected on cars without any adjustment being permitted, and a distance of 2,000 miles was covered at Brooklands at a speed average of 40 miles an hour. A final run of five hours on the test bench and subsequent examination of the parts by the judges completed the trial. The Daimler company has challenged any other maker to equal this record and have staked \$1,250 with the R. A. C.

CONCERNING THE USE OF A PHOTOGRAPH.

Our attention has been called by the Rushmore Dynamo Works to the fact that the photograph appearing in the advertisement of another lamp manufacturer on the back cover of the April 1 issue was made with Rushmore lamps, not with the lamps advertised, as might be inferred from the use of the photograph in that connection. We have learned that this photograph is one of several taken by a Plainfield motorist last fall and that it is copyrighted in the United States and has been authorized for publication only in *The Car*, of London, from whose pages it was reproduced without inquiry as to its source.

In justice to the concern referred to, we must further state that the advertisement originated solely in the art department of this office. The night scene was reproduced from *The Car* for its pictorial qualities, which were recognized to be very exceptional, and with no suspicion that it had originated so near home.

ELKHART CO. MAKES PRATT MOTOR BUGGY.

ELKHART, IND., April 12.—The Pratt Motor Buggy is the newest output of the Elkhart Carriage & Harness Manufacturing Company, of this city. The machine is constructed with an air-cooled engine of sufficient power to propel the car at a rate of from 25 to 30 miles an hour. The firm has been experimenting for many months with various types, and has given the one adopted a thorough testing on the roads before announcing its manufacture.

Automobile Gasoline and Other Available Fuel

by Thos. J. Fay

Part I

THE amount of gasoline that should be provided will depend upon the design of the car, in any given case, and the motor used. As a concrete example of general practice the following will hold, viz.: (a) single-cylinder motors in runabout types, 5 gallons; (b) double-cylinder motors in light cars, 10 gallons; (c) small four-cylinder motors in roadsters, 15 gallons; (d) light touring cars with four-cylinder motors, 20 gallons; (e) standard touring car work with four-cylinder motors, 25 gallons; (f) the largest sizes of cars with six-cylinder motors, 30 gallons of gasoline.

Radius of Travel of Cars.—Taking the gasoline as above allowed it is an approximation of the situation to say that all the cars will have the same radius of travel, although the following is more nearly in accord with the results obtained in actual practice under average conditions:

NO. CYLINDERS.	MILES PER GALLON.
1.....	30
2.....	20
4.....	15
6.....	10

There are wide deviations from the above, nor can the differences be ascribed to cylinders alone. The six-cylinder motor, although it apparently uses more gasoline, is generally placed in high-speed cars and the weight, as well as the front area (causing a large wind resistance result) all go toward an increased gasoline consumption. The four-cylinder types of cars, some of which are heavy and go fast, use gasoline in quantity, all the way from 9 up to 18 gallons, considering the best results. The average two-cylinder car will not do quite so well as the table shows, and the one-cylinder car would have to be in fine shape to run on 30 gallons.

At all events it is well to have a good supply of fuel on hand, and in order to avoid annoying interruptions of service it is recommended that some means of determining the rate at which fuel is used be provided. There are a number of devices available for the purpose of showing the gasoline level in a tank, at will, and Fig. 1 shows the design of a tank so contrived that only half of the gasoline can flow to the carbureter without opening a second valve. This tank is usually made of cornice copper, the weight of which should be on a basis of 20-ounce copper for the ends and 16-ounce copper for the shell. The baffle plates can be of the lighter material, although they are generally made of the same weight of copper as the heads. As the section, Fig. 1, shows, the baffle plates *H* and *H* are shaped the same as the heads, and, unlike the heads, they are provided with holes of a good size so that the gasoline can find a level equal in all the compartments. The heads, *I* and *I*, are dished outwards and the hangers should be with a considerable surface, so that they will not tear out at the rivets.

Gasoline is put into the tank through the filler, of good size, *F*, and the cap *G* should be so devised that it may be screwed down tight against a leather packing washer. This material is the best packing to use; rubber will not do at all. If the tank is fed with pressure to furnish the means by which the gasoline is forced into the carbureter the cap *G* must be tight or else the pressure will ooze out. If the gasoline is fed by gravity, a vent hole (about 1-32 inch in diameter) must be allowed for in the cap *G* or elsewhere in the tank, the function of which is to equalize the pressure.

If pressure is fed to the tank, which pressure usually comes from the combustion chamber of the motor, it should be brought in through the pipe *K* and to the bottom of the tank in order that the "spent" products of combustion will be cooled by the liquid, and if there is any flame it will be quenched in the liquid.

It is a safety measure to so lead the pressure into the tank, and it will also be prudent to put a screen over the end of the pipe just before it enters the tank.

The gasoline is brought to the carbureter through the pipe *L* and is controlled by the valve *B*. When one-half of the gasoline is used the pipe *A* prevents the flow of any more fuel through the valve *B*, in to the carbureter pipe *L*, so that it will be necessary to open the valve *D* in order that gasoline will flow through the pipe *C* into the carbureter pipe *M*. The carbureter pipe *M* can be joined to the pipe *L* at any convenient point or it would be a good idea to have both pipes lead to the carbureter.

The piping should be large (say, 3-8-inch hole) and of annealed copper. The joints should be limited to necessary terminals and junctions, but all joints should be ground. There are divers forms of fittings to be had, and the joints can be made tight in all of them in which soft packing is not used. In pressure systems especially, it is of the greatest importance to

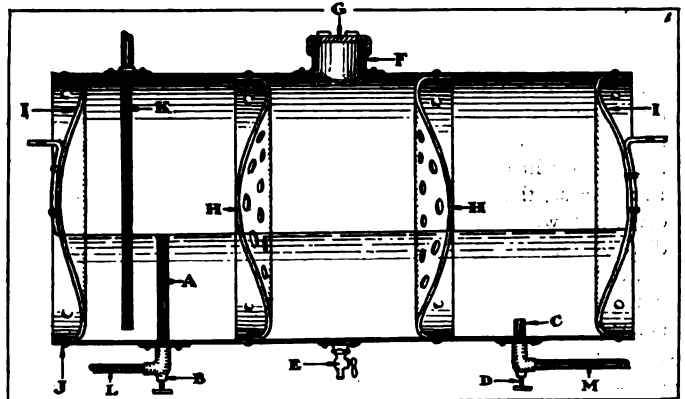

Fig. 1.—Partitioned gasoline tank entrapping a reserve supply.

have secure, as well as tight, joints, for the reason that it is extremely difficult to repair trouble of this nature on the road. The motor will not run without gasoline, and in a pressure system the gasoline will not run up-hill to the carbureter, hence the pressure must be prevented from oozing out through leaky joints, some of which are tight when a car is not in use, but owing to design will not stay tight when vibrations are introduced.

If the piping is small the chances are that "jelly," which forms out of the contents of the gasoline, will be the source of much trouble, and in the cars, such as use small-diameter piping, the same should be so placed that it can be removed and blown out quickly, and on the road. Even in systems using large piping, if the joints are constricted they will be the cause of the same kind of trouble, with even a chance of the trouble being more acute on the ground that the jelly will form more readily at constricted points.

Water in the Gasoline.—Even if the gasoline is strained through a chamois skin when it is emptied into the tank, if the same is with a vent hole, as required in the gravity-feed system, water will make its way into the tank; moreover, it seems almost impossible to keep water out of the tank whether or not the system is of the gravity-feed genera. At all events the water is a source of annoyance in more ways than one in that if the tank is of steel, rust may form on the bottom, which is the natural resting place for the water. In any event, no matter what material is used in the make-up of the tank, water will not burn, under the conditions in which it is placed in the gasoline tank, and it will interfere with the carburetion to a marked degree.

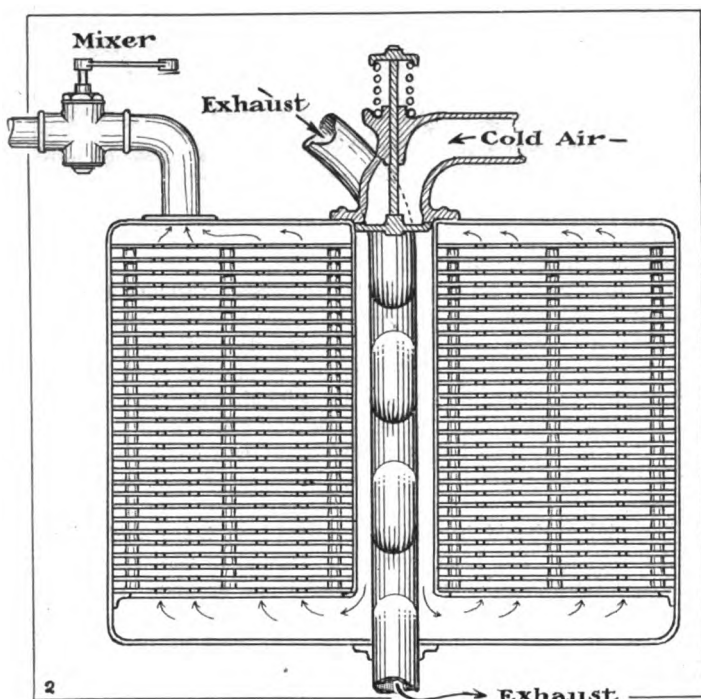

Fig. 2.—Gasoline tank in which the liquid is vaporized by heat.

Since the water will settle to the bottom of the tank—for the reason that it is heavier than gasoline—it is generally the case that the reserve supply is not as good as it ought to be, and the remedy lies in running off the water, through the cock *E*, Fig. 1. In any case, the residuum after a car has been on the road for a couple of weeks is of the heavier fractions of the hydrocarbon distillate, and it should be removed from the tank.

Tanks in Which Gas Is Made.—In view of the uncertain nature of automobile gasoline and the presence of a considerable percentage of the heavier distillates, the ordinary means at hand fall short of the full requirement when reference is had to the complete vaporization of the liquid before it enters the motor cylinder. With a view to the complete vaporization of the fuel before it enters the motor cylinder the gas-producing tank, Fig. 2, is used to quite some extent, and it promises to be a large factor in the future. In this plan, the tank is filled almost completely with wood-fiber boards, superimposed, but slightly separated, so that the greatest possible surface is offered to the hot air as it is drawn through the pile of boards, in which holes are provided for the purpose. The air is taken in through an orifice at the top of the tank, leading to a jacket which surrounds the heater to the bottom and thence upward. The heater itself is devised in a manner not unlike an ordinary radiator, and since the exhaust gases from the motor pass through the heater, the air is adequately heated for the purpose.

The capacity of such a tank is about 55 per cent. of the capacity of the same sized tank, in which no boards are placed. In other words, "voids" in the wood-pulp boards will foot up to about 45 per cent., and the free space makes up the balance. Once the voids in the boards are filled with gasoline, nothing besides can enter, so that there is no danger of an explosion, even when a naked flame is applied to the openings in the tank. True, the mixture, in the space not filled with pulp, could be made "lean" enough to ignite, but it is ordinarily so rich that it will not burn at all. In view of the small amount of space, not filled with pulp, the volume of gas that would be available, assuming it were reduced in richness to the point where it would burn, would not be enough to do damage. In every two-cycle motor mixture is in the crankcase, and the same is rich enough to ignite, as a rule. "Crankcase shots" are not only possible, but they do occur, and what is more to the point, they do no damage. It will be remembered that the compression is but slight in the crankcase of a two-cycle motor, which accounts for the

lack of vigor of the burning mixture, but it is a significant fact that the pressure in the crankcase is more than that which obtains in a gas generator, as shown in Fig. 2.

Economy follows the use of any means by which the gasoline is vaporized completely before it enters the cylinder, and carbon formations are aborted. If, then, the gasoline can be vaporized before it leaves the tank there will be ample time for the excesses to condense and the mixture, properly diluted with air, will be suitable for the purpose, taking into account the best results, in which a homogeneous gas, free from liquid, is the more nearly perfect. In the form of fuel holder, Fig. 2, the rich gas passes from the tank to a mixing valve, the function of which is to alter the proportion of air to rich mixture, at the will of the driver, and according to the road condition, or better yet, the speed of the motor. If the motor is to run at high speed, the amount of air should be increased if a carbureter is used, for then the gasoline will be sucked out in greater proportion and the mixture will be enriched in excess unless air is added sufficiently to dilute the same enough to offset the gasoline increase. With the generator, Fig. 2 (gas tank), the reverse holds to some extent, in that the gas will become lean if the amount of gas passing over is increased enough so that the surface available is relatively deficient, as it will be after a certain point in the process. The mixing valve regulates for all these differences, and the motorist adjusts the same in proportion to the needs without having to consider the source of the variable.

In view of the ability of the generator to deliver a gas rather than air with globules of gasoline entrained, Fig. 3 will serve to illustrate a point that ought to find a residence in the mind of any autoist who expects to drive his own car and be awarded a due measure of pleasure or profit. Referring to Fig. 3, *A* represents a gas in which the air is in excess with the result that the phenomenon known as popping in the carbureter transpires. This mixture is quick-burning, due to excess oxygen, and the intake valves, which are generally set to open with a small difference in time, before the opening of the exhaust valves, open too soon for a mixture of this sort. In some motors the intake valves open before the exhaust valves close, and in such cases, especially at low crankshaft speeds, popping in the carbureter is prone to happen.

To avoid this popping it is necessary to enrich the mixture, which is done by allowing less air to pass through the air-port of the mixing valve, and the condition depicted in *B*, Fig. 3, will follow. There is an entire absence of liquid gasoline, just as in *A*, the essential difference being in the ratio of air to rich mixture. In this case, the motor should be able to deliver power at a high speed, and the relation of gasoline to air should be about that due to 8,000 volumes of atmospheric air to one volume of (liquid) gasoline. The condition in *A* will be about on a basis of 10,000 volumes (or slightly under) of atmospheric air to one volume of (liquid) gasoline. As the motor slows down the auxiliary air must be adjusted, primarily to suit the gasoline ratio, and in order to enrich the mixture if it happens to be the desire to slow the motor down to suit road conditions rather than to carry a heavier load. Enriching the mixture will render it slow-burning, and as this process goes on a motor will be slowed down (although it is better to reduce quantity of the right mixture) in which event the density of the mixture will be increased, after a fashion, somewhat as shown in *C*, Fig. 3. When the mixture is so enriched that it will have 3,500 volumes of atmospheric air to one volume of (liquid) gasoline it will not take fire and the motor will fail to run.

It is generally claimed that the greater the weight of fuel entering the cylinders, the greater will be the power of the motor, but it must be remembered that the fuel must be burned completely in order to make this rule hold true. Take, for illustration, the case in which the mixture is enriched in the process of slowing the motor down, this is not on a basis of increasing power. On the contrary, the power is on the decrease (a) because the speed is decreasing and (b) because the fuel is not in the best state to do the maximum work.

Economy Depends Upon Speed.—Since the power of a

motor depends upon the speed, economy in the use of fuel also depends upon speed. That speed is a settled requirement is too well understood to need proof; on the other hand, the relation of speed to torque will stand exploitation at this time, the formula for which may be written thus:

$$2\pi = 6.28 = 2 \times 3.1416, \text{ in which } 3.1416 = 7/22 = \text{ratio of diameter to circumference of a circle,}$$

R = radius at which torque is measured, taken in feet, can be accepted as unity in this case,

S = speed of motor crankshaft in revolutions per minute,

P = torque = pull in pounds, in this case, at one foot radius,

33,000 = foot-pounds per minute, equivalent of 1 horsepower,

$H.P.$ = horsepower of the motor.

$$\text{when } H.P. = \frac{2\pi R S P}{33,000}$$

$$R = \frac{H.P. \times 33,000}{2\pi S P}$$

$$S = \frac{H.P. \times 33,000}{2\pi R P}$$

$$P = \frac{H.P. \times 33,000}{2\pi R S}$$

The formula shows that, at a constant torque, the power will be directly proportional to the speed; on the other hand, the torque will not remain constant if the fuel is not held to a constant (right) mixture. Taking advantage of this, the fuel is enriched so that it will not deliver the best results when it is desired to slow the motor down in the absence of any considerable power requirement. If the power is to remain in direct proportion to the speed, it is then that the mixture should be held by about 8,000 volumes of atmospheric air for one volume of (liquid) gasoline. When the rich mixture comes from the tank as shown in Fig. 2, it can be "saturated," in which event the

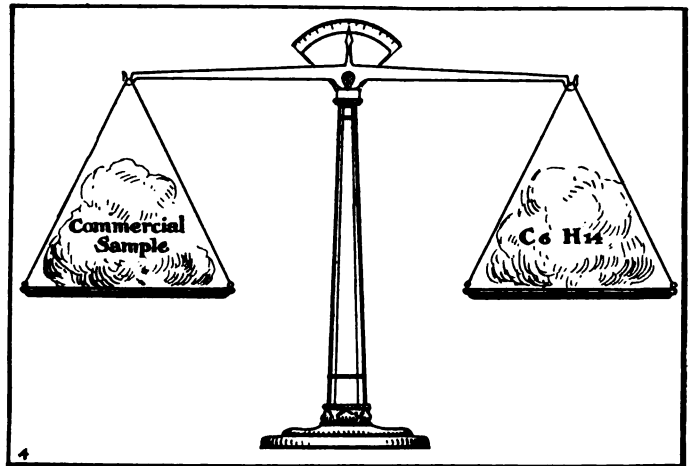

Fig. 4.—Illustrating the principle to use in comparing fuels.

ratio of atmospheric air to gasoline will be on a basis in which 15 per cent. of the whole amount of vapor will be vapor of gasoline. This is a maximum value, rarely attained, and in order to show the great extent to which this saturated mixture would have to be diluted with atmospheric air, to make it burn, it is only necessary to say that, when the mixture holds 8,000 volumes to one (liquid) volume of gasoline, it is then the equivalent of 1.8 per cent. gasoline vapor (the balance atmospheric air) in the whole mixture.

Economy Depends Upon Completeness of Combustion.—

As a rule, when a motor runs slow, the fuel economy is materially reduced, although the adjustments can be so made that but little of the fuel will evolve as carbon monoxide, hydrocarbons, hydrogen, carbon, oxygen, etc. When the products of combustion are carbon dioxide, water and nitrogen as the diluting agent, it is then that the fuel will be regarded as in a state called "complete combustion" and the fuel economy, aside from the utilization of the energy, will be a maximum. The effect of load changes on the combustion of the fuel, taking into account speed changes as well, may be noted in the following table:

PRODUCTS OF COMBUSTION UNDER THREE CONDITIONS.

Products.	Full Load.	Partly Loaded.	Slow Speed.
Carbon Monoxide.....	3.31	6.9
Hydrogen	1.19	2.4
Hydrocarbons	0.30	0.9
Carbon dioxide	11.90	9.9	6.3
Oxygen	0.23	0.3	11.2
Nitrogen	83.07	79.6	82.5
Total.....	100	100	100

Since the fuel value of the partially burned contents is known it is possible to reflect the losses resulting from incomplete combustion. The value of the unburned products can be set down as follows, subject to slight variation in some cases:

FUEL VALUE OF THE ELEMENTS ENTERING IN.

Carbon burned to carbon monoxide.....	4,400 B.T.U.
Carbon burned to carbon dioxide.....	14,500 B.T.U.
Hydrogen burned to water.....	62,032 B.T.U.
Hydrocarbons burned to carbon dioxide.....	20,000 B.T.U.

In the above tests of the state of the fuel after use, it is in evidence that, running slow, the air was in considerable excess, thus showing that, instead of running on a rich, slow-burning mixture, the slow speed was brought about by using a lean mixture in which the actual heat units present were barely adequate for the purpose. As the table shows, the best disposition of the fuel was made with the motor running slow, under which conditions there was no carbon monoxide, hydrogen or hydrocarbon fuel in the exhaust.

(To be continued.)

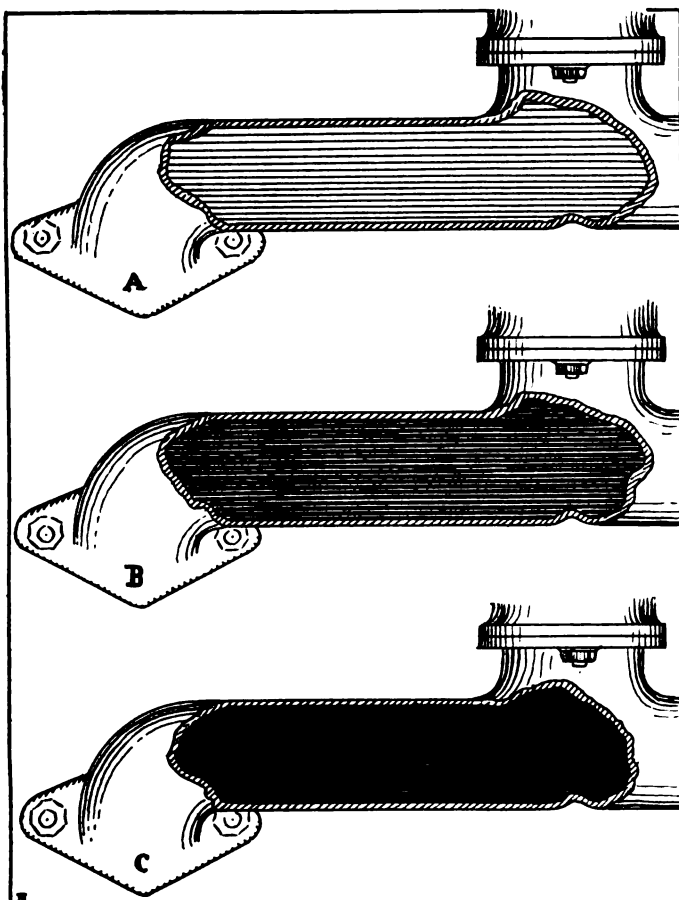

Fig. 3.—Carburetor manifold, (A) showing lean mixture, (B) proper mixture, (C) rich mixture.

Valuing and Selecting a Second-Hand Car

by A. D. Hard.

THE market price of a partly used automobile does not properly indicate its true value for actual use. Unlike most articles bought for use, an automobile may quickly become unsatisfactory to the owner without fault of the automobile itself. The principal source of dissatisfaction among owners is the desire to secure a later and more stylish model. This notion causes the owner of a really good machine worth probably two thousand dollars to offer it for sale for half that sum. Another reason for selling a partly used automobile at much less than its real value is a desire to have a machine just a little faster, or a little finer than the next-door neighbor on the other side of the "spite fence." Again, a touring car is wanted in place of a runabout, or a steamer is wanted instead of a gasoline car, or a limousine may be desired in place of an open car.

In most of these changes the old car is traded in for what it will bring on the more desirable car, and the partly used car then finds its way into the second-hand car dealer's hands. Sometimes the partly used car will be but little used, not injured at all, and in fact will run smoother and better than a new car. The price usually asked for such a car is far below its real value. I saw a well-known touring car in a popular second-hand shop on Michigan avenue, Chicago, last January, that cost \$4,000 less than two years previously, which was marked \$900. I examined it critically and found it in first-class condition. Of course, I bought it. In less than thirty days that car was eagerly sought for by two buyers at \$1,500, but they did not get it.

As an expert I am frequently requested to give my opinion on the value of a proposed purchase, and the necessity at once arises for differentiation between market value and actual value. The price which a buyer should fairly pay for a partly used automobile depends upon the average price charged for such make and quality of machine. The value for use is quite another and a different matter.

Figures from a Bargain List.—Taking the "bargain list" of a large New York dealer as a basis for making averages, the following figures were deduced. I selected six of the most popular makes and found that he had seventy of these cars for sale, some being old models, some being single cylinders, double cylinders, four cylinders, and part being chain drive. There were nineteen Cadillacs, sixteen Wintons, twelve Fords, nine Maxwells, eight Ramblers, and six Buicks. The average cost price of these cars when new was nearly \$1,600. The average price now charged for them as partly used cars was \$503. The average time that these cars had been used was sixteen months. Nearly all of these cars had extra equipment, the average value of which I estimated to be \$30. This left the average selling price of the cars at \$473. From these composite deductions, we find that a second-hand car that has not been used more than sixteen months should sell for not over 30 per cent. of its original cost price. But this must not be a strict assessment of value, for conditions of engine, tires, and amount of equipment must be considered. There are several factors to be considered which do not appear at a casual glance, nor can they be determined by a trial run.

Reliability and Replacements Have an Actual Money Value.

—The repute of the maker of a car for turning out reliable products is a very important feature which should not be overlooked. Another factor of value is the possibility of securing replacements when needed. And the probability of ready sale for a fair price in case that you may wish to dispose of it is worth some attention. The maker who turns out thousands of cars will in all probability have a more even standard of mechanical construction than the one who struggles along with an output of fifty cars a year. The manufacturer who makes all the parts which are vital to the quality of his car will be likely

to make them well so as to derive a good name as an asset of value for future business.

On the other hand, a manufacturer of automobiles may not have the extensive shop equipment to turn out as good an engine as the man who devotes all his capital and ability to perfecting that special part. To say that every part is made in our own factory may or may not be a true estimate of quality. As a rule, the car that has been abandoned by a manufacturer is faulty. It has not proved to be as good as he expected that it would and he has quit making it. The manufacturer who is constantly changing his model is very apt to be uncertain in his judgment of what is really best in methods of construction and design.

Appearances May Be Deceiving, but Dealers Are More So.

—When it comes to examination of the car as a prelude to choice, the man who can buy with his eyes exclusively will be more certain of securing something which will not disappoint him. Not that I mean to say that dealers are all dishonest, but they all look at the transaction from a more or less selfish point of view. Selling second-hand automobiles is fast becoming as proverbial as selling horses, have good eyes and use them.

The cheapest thing on earth is talk, and the next is a catalog with testimonials. The relative cost importance of parts that may be worn and need replacing is a matter of discrimination.

If a car needs a complete new engine, it certainly is not so desirable as one that requires some few inexpensive replacements. Frequently a few of these little replacements will make a car almost as good as new, while without them it will hardly run at all. For want of a minute rubber washer on a tire valve, the tire went flat, the car ran into a tree, and two people were killed. As a rule, lack of compression is considered an awful fault of an engine, when it may be due to worn piston rings which can be replaced for a few cents.

An experienced ear, aided by a physician's stethoscope, will discover burned-out bearings, loose connecting rods, and leaky valves. A noisy transmission may be silenced with thick grease, so remove the cover and look at it. I know of no way to test a differential but by taking it apart and looking at each gear. Nothing about a second-hand car may be so worthless, yet look fairly good, as the tires. The only safe way is to make your bargain so as to cover a new set of tires which are not seconds.

A trial spin in order to see how much power and speed the car may have is of doubtful value to the buyer, although it is a great point for the seller. This applies to new cars as well as partly used ones, for it is an easy matter now to use special fuel for trials in a demonstrating car. The first automobile which a man operates should be a second-hand one, for the first three months' use of a new machine by an inexperienced driver will do it more real damage than the next three years of careful operating. The best way to select a second-hand machine is to get an experienced automobile mechanic to examine the vital parts and make a report as to what replacements are needed to make the car a good serviceable machine, then use your own judgment as to whether or not it suits your needs.

Aeroplanes will beat the Empire State Express, is the remarkable opinion voiced recently by A. M. Herring, president of the Herring-Curtiss Aeroplane Company, during a talk about the future of the flying machine. This concern is now building four machines of a model that is slightly smaller than the Silver Dart, which has flown successfully in Nova Scotia, but with increased power. It is expected that these will be such that they could leave New York City at the same time as the Empire State Express, and beat the train into Buffalo. Experiments will be tried to determine speed attainable.

Which Is Better: Three or Four Speeds?

By Louis Lacoïn

WHICH is preferable—a car with *three* speeds, because of its simplicity and the relative smoothness of its running, or one of *four* speeds, despite its higher initial cost and the supplementary complications of its mechanism? That question does not trouble the purchaser very much; the list price alone interests him. With regard to the reasons that have permitted the builder to reduce the cost, or have compelled him to increase it, he is concerned but vaguely. A certain name, a certain power, details of the mechanism that are *a la mode*, influence far more in his choice than the number of gears that the chassis happens to have in its interior. Pay more and then have more lever shifting to do? Thank you. I prefer at the same price a motor that is more powerful. And the builder does not hesitate to place this heavier motor on his chassis. He knows that a few horsepower more will scarcely have any influence on the cost of building the machine, while their presence will permit him to inflate the market price without fear.

But so far as putting a four-speed gear set on the chassis that he builds, he consents to do it on the heavy, high-powered vehicles, because their selling prices are sufficiently remunerative to warrant it. But the small cars? They are the ones on which it is necessary to reduce the cost of manufacture to the minimum. They should have but three speeds. So much worse for the buyer. He cannot comprehend the necessity of being out of pocket several hundred francs for a fourth speed, since that fourth speed strikes him as useless.

But that fourth speed is not useless by any means, as can be proven. First, to begin by justifying the reasoning of the builder in showing what the addition of that supplementary speed leads to in the way of changes on the chassis. In Fig. 1 have been grouped three types of change speed gears. No. 1 represents a type providing three forward speeds and reverse, with the high speed on the direct drive. The sliding member is reduced to the two pinions *C* and *D*, with the jaw clutch *A* for the direct drive. Both the length and diameter of the shafts are moderate; the weight is not great, and the cost can be kept low.

Additional Speed Adds Fifty Per Cent. to Length.—The method of operation of the second arrangement, No. 2, still involves but a single sliding member, but it is almost *half as long again* as the preceding one. The addition of the fourth speed has been responsible for the increase. It must not be thought, however, that the relative distances between the pairs of gears are all the same, and that the fourth pair would accordingly not be responsible for increasing the length more than one-fourth of its previous size. This would be a fallacy.

Take, for example, the three pinions of the sliding member. The gear *B* is actually in mesh with the pinion *P*. That pinion must be a sufficient distance away from the driving gear *M*, so that these two shall not come in contact when the jaw clutch *A* is engaged. The gear *C* of the sliding member, on its part, must not contact with *P*. Between *B* and *C* there must be sufficient space for engagement, plus a length equal to the travel of the jaws of *A*, plus a few millimeters for play. The gear *C* must not contact with the pinion *Q*, when sliding to the right, after *B* and *P* have become entirely disengaged. The pinion *Q* is then distant from *P* a space greater than that from the left face of *B*, to the right face of *C*. Again, the gear *D* of the sliding member must never come in contact with the pinion *Q*, and, as on the direct drive, when *C* is close to *P*, *D* is also close to *Q*, the distance between *C* and *D* is equal to that between *P* and *Q*, and must be greater than that between *B* and *C*. From this it will be evident:

1. That the interval between *B* and *C* is equal to the width of a

gear face, plus the length of the direct drive jaws, plus the necessary play.

2. The interval between *C* and *D* is equal to the preceding space, plus the width of *two gear faces*, plus the necessary play, which is also greater.

3. The interval between *P* and *R* is equal to that between *C* and *D*, plus the width of *two more gear faces*, and the play required, this being greater than before.

Fourth Speed Increases Both Speed and Weight.—Consequently the addition of the fourth speed has increased the length of the gear-set by the width of *five gear faces*, and a

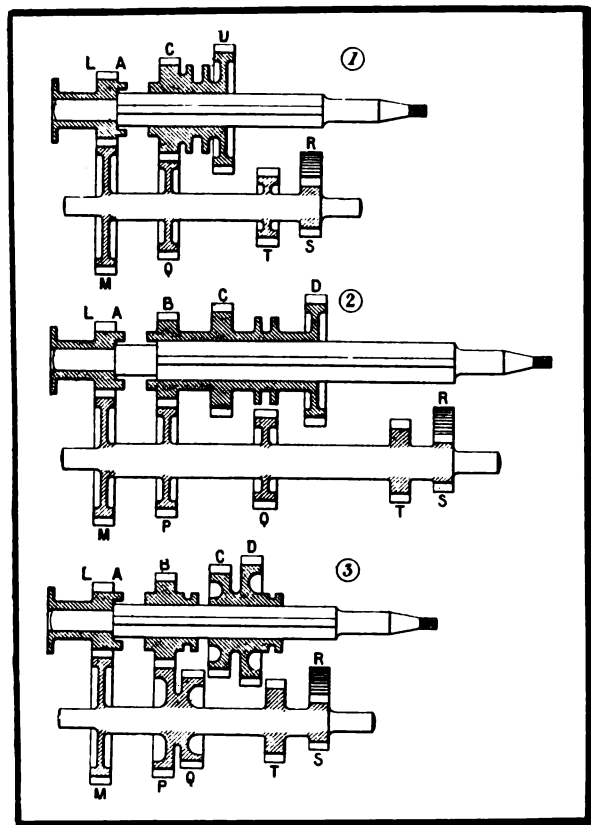

Fig. 1.—Types of change gears: No. 1, three speeds. N. 2, four speeds, one sliding member. No. 3, four speeds, two sliding members.

number of millimeters for the play required. These shafts, being so much longer, must be made that much stronger and heavier. The gear-set housing must likewise be made capable of carrying a greater weight, from which it will be seen that a four-speed gear-set calls for an entirely different class of work than a three-speed gear. Necessarily, the cost is much greater.

Thus far our attention has been confined to a type of gear-set having but a single sliding member. It is possible to make it with two sliding members, or even with three. The size of the gear box may then be reduced. See No. 3. But the interior complication and the more involved method of operating the sliding members, far from diminishing the cost, greatly enhance it. There is no difficulty, in view of this explanation, in understanding the hesitancy of the designer to thus increase initial cost.

Let us see what end this fourth speed serves. It is not with the manufacturer that the question will be discussed, but with the buyer. Take, for instance, two machines, identical in every respect, except the number of speeds with which they are pro-

*Translation from the French of "Omnia."

vided. Both are of the same weight, have motors of the same power, and both have the same type of gear-set, except that one has four and the other has but three speeds. Take the three-speed car first. The choice of these speeds is not a matter of indifference, as our analysis will show incidentally, though this is not the place to discuss that. Assume that the speeds chosen are the conventional ones of 16, 28 and 48 kilometers (10, 17½ and 30 miles) per hour. Assume the car to be on the road, with the second speed engaged. Will the motor then propel the car at exactly 28 kilometers (17½ miles) per hour? It will, if it happens to be on a 7½ per cent. grade, as under these conditions, the motor will develop its full power. But if the grade be less, the speed will no longer be 28, but 30, 33 or even 35 kilometers (18½ 20½ or 22 miles) per hour, at which the motor, being less heavily loaded, will drive the car. On a stiffer grade the speed will, on the contrary, diminish, and if we wish to climb a grade stiffer than 10 per cent. it will stall.

The curve *ABECND*, Fig. 2, represents the speeds which the car in question will make on the different grades with the second speed in engagement. During this period the motor will turn at a series of speeds corresponding to those of the vehicle. But at all these speeds, with the exception of the first, it will not furnish

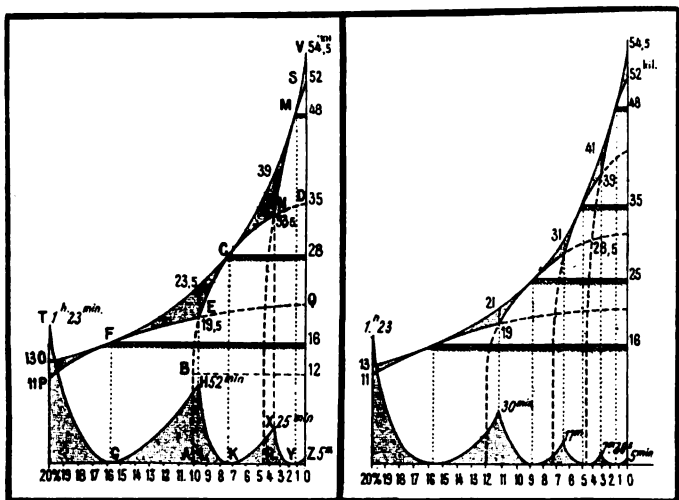

Fig. 2.—Showing time losses with three speeds.

Fig. 3.—Showing time losses with four speeds.

its maximum power. Its maximum output will correspond to the point *C* of the curve *ABECND*.

Shifting into first speed, we will then have a new curve *PFEQ*, with *F* as the point of maximum power. On the third speed we would have the curve *XNMS*, with the point *M* as the peak representing the maximum power delivered by the motor. If free to take any gear ratio, the points *C*, *F* or *M* of the curves corresponding to each one of these gear ratios would form a new continuous curve *UFCMV*. That curve would represent the speed at which the motor, turning at its best r.p.m. rate and developing its maximum power, would drive the car up the different grades.

It will also be evident that on a 9.6 per cent. grade the car would attain a speed of 23.5 kilometers (14.6 miles) per hour, while on the first speed, curve *PFEQ*. On the second speed, curve *ABECND*, it will only reach a speed of 19.5 kilometers (12 miles) per hour. Not having all speeds, 4 kilometers (2½ miles) an hour is consequently lost. If there was 100 kilometers (64 miles) to run on such a grade, it would mean the loss of almost an hour in making it—to be exact, 52 minutes, taking 5 hours and 8 minutes, instead of 4 hours and 16 minutes. So far as the owner's pocket is concerned, the result is the same as if the motor had been run under full load for 52 minutes, without propelling the car. If the motor were one of 12 horsepower, it would mean 5.2 liters (1.14 gal.) of gasoline wasted.

Loss Is Less on Lower Grades.—But grades of 9 per cent. are rare; take one of only 3.6 per cent. The loss in 100 kilo-

eters (64 miles) will be 25 minutes, or 2.5 liters (.55 gal.) of gasoline. The curve *TGHKXYZ* represents the loss of time in 100 kilometers, which the three-speed gear-set, chosen with the speeds in question, would cost. Why not then choose others? Everything depends upon the nature of the ground to be covered. If, as is usually the case, the rises are short, and the easy grades far more numerous than the bad ones, we could have favored them in our illustration, by making the second speed very much higher. In a rolling country it would be necessary to diminish the value of these speeds in such a manner as to reduce the loss of time on the heavy grades, and increase it on the others; *T* and *H* would then be lowered, and *X* and *Z* raised.

For lack of more definite data, let grades ranging up to 8 per cent. be assured. The average loss of time in 100 kilometers will then be 12 minutes, and the loss of fuel for the same distance will be slightly more than one liter—1.2 liters (.26 gal.), to give the exact figures.

It will be well now to consider the four-speed car, Fig. 3. Assuming the same basis of desiring to favor the light grades, choose speeds of 16, 25, 35 and 48 kilometers (10, 15½, 22 and 30 miles) an hour for the first to the fourth speeds, respectively. The maximum power curve remains the same, as well as the curves for the extreme speeds, 16 and 48 kilometers per hour. The two curves of 25 and 35 kilometers per hour have replaced the former single intermediate of 28.

Fourth Speed Saves Enough Fuel and Time to Pay Its Way.—These curves follow very closely the curve of maximum power, while the fuel and time losses per 100 kilometers are greatly reduced. It is found, as a maximum, 30 minutes on a grade of 11 per cent.; 17 minutes on a grade of 6.2 per cent.; 7½ minutes on a 3 per cent. grade, and 5 minutes on rises less than this. The mean average of these losses on grades up to 8 per cent. in 5 minutes, and half a liter (.11 gal.) of essence. By having four speeds, 7 minutes and .7 liter (.15 gal.) of fuel per 100 kilometers have been gained. Let it be supposed that only 20,000 kilometers (12,400 miles) in a year are covered. The gain is 1400 minutes, or almost 24 hours of driving, and 140 liters (31 gal.), or at least 52 francs in fuel (\$10.40) in actual running (outside of Paris), without considering the matter of lubrication and wear on the motor, during those 24 hours of useless running. due simply to that fourth speed.

On the other hand, let it be assumed that the mean possible speed, the power of the motor being given, is 40 kilometers (25 miles) per hour. If there are three speeds, that will be lowered to 37 (23). With four speeds, instead of 40, we will have 38.7 kilometers (24). The fourth speed will then be equivalent to the practical increase of 5 per cent. in the power of our motor. To the economy of time might be added that the saving of fuel is almost one liter (.22 gal.) per 100 kilometers, so that we must recognize that this extra speed is well worth the small amount of space it demands on the chassis, and that it has the right to pay for its presence there.

“Machine Drawing and Design for Beginners.”—In this work on a time-worn subject the publishers, Longmans, Green & Company, have succeeded in getting a new style of treatment which is unusual and effective. The author is Henry J. Spooner, C. E., a well-known English engineer and writer on engineering subjects. The text is divided into 26 chapters, each devoted to a different subject which is thoroughly handled and completed before taking up the next. The method of treatment is as follows: the subject is defined, then discussed, then the ordinary points are called to the student's attention and their treatment clarified. Next the more difficult questions are taken up in a similar manner and finally the subject is closed. Drawings illustrate every point made and no less than 14 useful tables are given. At the close of every chapter exercises are given of a numerical, drawing and sketching nature. These carefully follow the text, but at the back are given a miscellaneous lot of problems covering the whole work. It is an excellent book for the purpose, mechanical drawing self-taught, or equally good for class instruction.

FRENCH SPRING WHEEL APPEARS MERITORIOUS

FROM the very birth of the automobile there have been produced spring, elastic and other flexible wheels designed to eliminate the pneumatic tire and all attendant troubles. These have possessed merit sometimes, others were only ingenious and not practical. The latest to be produced among the French, always large producers in this particular line, is the Lipkowski.

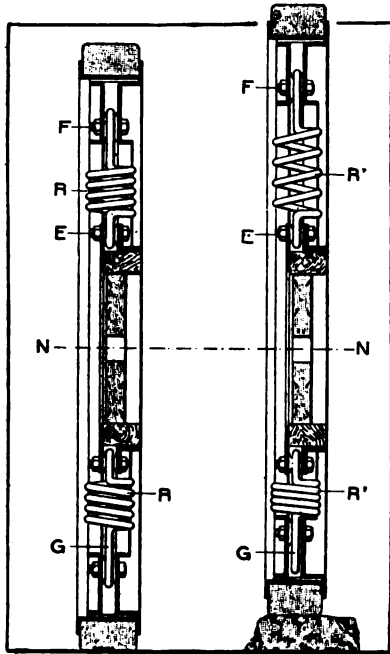

Section Illustrating the Action.

The rotative or sideways sliding motion is limited by a pair of abutments or projections, while the other motion is restricted by the springs. These will restrain the rotative motion, making it gradual and progressive. Shocks would destroy the projections which may not have a large cross-section.

The springs are coils of a small diameter and with the size of the wire proportioned to the load, small for light touring cars and runabouts, large for heavy enclosed cars or trucks. The two eyes for attachment are turned into a plane parallel to the flat side of the wheel and differ. The inner end is perfectly circular and just fits the bolt upon which it is mounted, so that there is no play at that end. The outer end is elongated and consequently has a little freedom.

This comes in when the wheel runs over an obstruction, as shown in the sectional drawing. The interior part with the axle does not rise but continues in the same horizontal plane. The felloe portion rises, thus drawing away from the inner part

at the top and approaching it at the bottom. The first action exerts tension on the upper spring, stretching it. The second part of the movement compresses the bottom spring, First, the elongated eye gives or slides the length of the elongation. A further movement results in pressing together the coils.

In this way the inner wheel is suspended within the outer, the outer taking all road shocks and altering its position relative to the inner without actually disturbing it or the axle which it carries. The outcome of this is the desired result, easy riding qualities with solid tires. A set of these wheels on a heavy limousine car of 40 horsepower was driven 10,000 kilometers (6,210 miles) among the Alps and through other mountainous parts of Switzerland and Italy. On this long tour the inventor had with him three or four friends, so that the car was well loaded at all times. The riding was said to be very comfortable at all times and the only outcome of the trip was the necessity for replacing two broken springs.

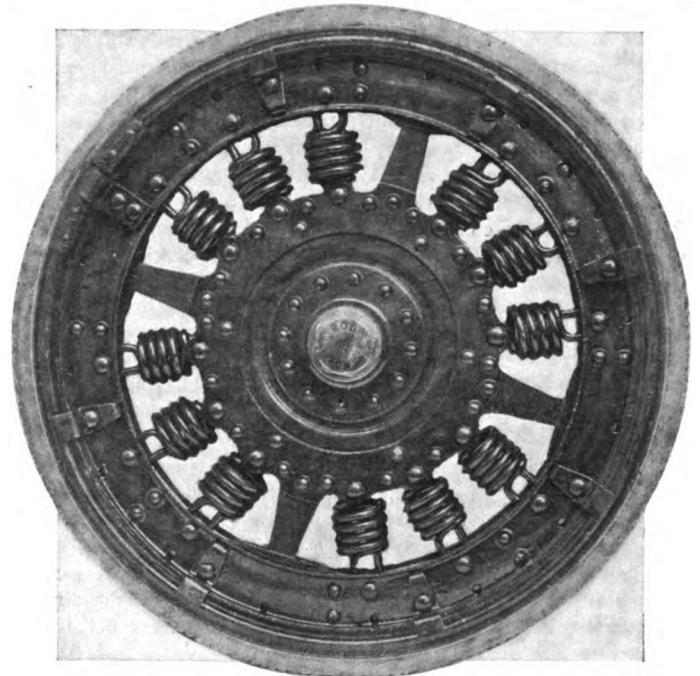

View of the Lipkowski Wheel, Showing the Springs.

These cost 18 francs (\$3.50) and their replacement occupied but 11 minutes. It is hard to imagine a similar trip on pneumatics with any less expense and an equally low amount of lost time, so the statement is fair that the merits of the wheel have been proven by actual, severe test.

SOME POINTERS REGARDING THE CARE OF TIRES

SIDE slipping and wear is due to spreading of the front wheels, generally caused by a bent distance rod or drag link connecting the steering arms or knuckles. If this condition is present, even in a comparative slight degree, the strain and wear brought upon the tire will quickly wear out the tread, inasmuch as the side slip continues with the rotation of the wheels. In case of excessive tread wear, examine the front wheels and find if they take proper position for straight ahead running.

Deterioration, due to chemical action, or rotting of the fabric lining, is usually caused by water or dampness, and is most likely to occur in tires which have been stored away for the

winter. Water will penetrate even a comparatively insignificant cut in the tread, and being absorbed by the fabric a gradual breaking down of the tire and disintegration will result. It is important for this reason to keep the tires in good repair.

Extra shoes and tubes should be protected by cases from the light and dust. Inner tubes in particular should be given proper care. When not in use they should be partly inflated and placed inside the spare shoes. Extra tubes should be spread upon a table with the valves spread half-way, and rolled up with the valves on top. Talcum or soapstone powder should then be freely sprinkled in the folds.



E-M-F Fire Fighter for Tampa's Fire Chief.

TAMPA'S FIREMEN GET THEIR NEW AUTO.

TAMPA, FLA., April 10.—Desiring to be thoroughly up-to-date in its equipment, the fire department of this city has received through the Tampa Harness & Wagon Company, the local agents, an E-M-F "30," a tourabout, equipped with four fire extinguishers, lanterns, axes and other fire-fighting paraphernalia for the use of the chief. The photograph shows Chief A. J. Harris seated beside the chauffeur, and directly behind him sits the assistant chief. Standing in the rear of the car is T. N. Henderson, manager of the Tampa Harness & Wagon Company. This car was the first E-M-F delivered to a Florida dealer, and is the first one in commission in that State, the wide tread that is required for Southern use on sandy roads making deliveries slower here than in the North.

CHINESE HAD A TAXICAB IN A. D. 265.

Professor Giles, of Cambridge University, has discovered in the dynastic histories of China a full specification of a taxicab dated A. D. 265. A model of the chassis has been made by Professor Hopkinson. The existence of such a vehicle has been hinted at several times in the past few years, and, in the research, Professor Giles came across the following reference to it in the history of the China dynasty (A. D. 265-419):

"The measure mile-drum-carriage is drawn by four horses. In the middle of it there is a wooden figure of a man holding a drumstick towards a drum. At the completion of every li the man strikes a blow on the drum."

Under the years A. D. 815, 830 and 987, they again heard of the taxicab, and the following further description was given:

"They are painted red, with pictures of flowers and birds on the four sides and in two stories, handsomely adorned with

carvings. At the completion of every li the wooden figure of a man in the lower story strikes a drum, and at the completion of every ten li a man in the upper story strikes a bell. There is a pole with a phoenix-like head and a team of four horses. Formerly the chariot held 18 soldiers, which number was increased in 987 by the Emperor T'ai Teung to 30."

The taxicab was again to the front in 1037, when an account of the mechanism was given, and even so late as the fourteenth century they read of a well-known poet who wrote a poem entitled "Ode to a Taxicab" in its praise.

ANOTHER COMMERCIAL FIELD FOR THE AUTO.

CLEVELAND, April 12.—The use to which the Auto Renovator Company of this city has just put their White steamer is decidedly novel, to say the least. A special body was built and placed on the rear end of the regular chassis. Within this is placed a dynamo and the necessary regulating devices. In use, the cleaning of houses by the vacuum system, the car is driven to the house where work is to be done, the dynamo belt is then put on, so that current is generated, this being connected to the other apparatus by means of wires. This is the up-to-date way of handling the cleaning problem, and is said to be far superior to the old and noisy vacuum apparatus.



Vacuum Cleaning Outfit on White Steamer Chassis.

To attract attention and thus business the car is equipped with a very large set of Gabriel horns. When going along the street to or from work the horns are played, the skilled operator being able to produce all of the popular airs and attract a proportionate amount of attention.

MAIL WAGON AND FIRE TRUCK FOR AKRON.

AKRON, O., April 12.—For a town of its size Akron can pride herself on being just as up to date as many a larger place. The recent events which have led up to the statement above are the call for bids on an automobile fire truck by the Board of Safety, the construction of an appropriate house for the same, and the very successful trial of a Brush mail wagon similar to those now in use in Washington.

This test lasted something over twelve hours, during which time the car covered 13 runs, totaling 35 miles, and made 322 stops. In this time the same work was done as ordinarily takes three men and three horses. The result was highly pleasing to Superintendent Schick, who personally accompanied the car. He was so much pleased that he will immediately place an order for a duplicate of the car used on the test.

The many large tire factories are so widely scattered that good service with horses is practically impossible and there have been many complaints. It was the result of these complaints that caused the present trial. The product of one of the tire companies helped to make the test a success, the Metz clincher tires going through without a particle of trouble.

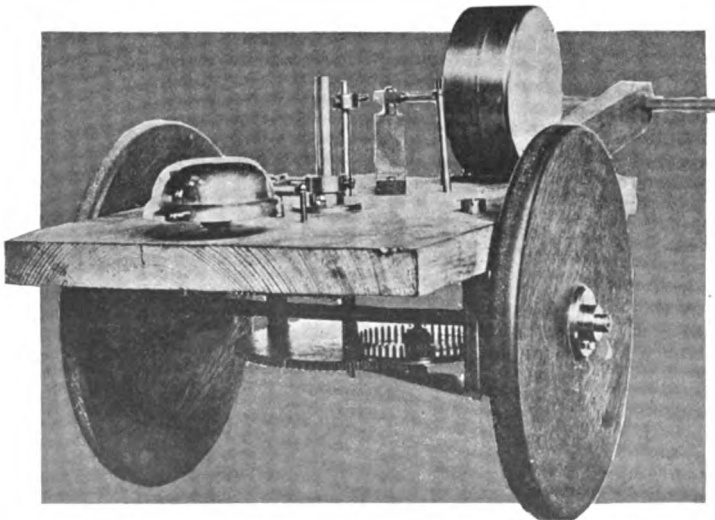

Chinese Taxicab of Third Century of the Christian Era.

Letters Interesting and Instructive

CARBURETER WATER JACKETS.

Editor THE AUTOMOBILE:

[1,830.]—Will you please explain the functions and necessity of water jackets for carbureters? Also the necessity for hot air supply to the carbureter, which is used on many cars.

Allegheny, Pa.
READER.

The chemical action of converting a fluid into a gas is accompanied by the absorption of heat. If no extra heat is furnished, the action of absorbing heat from the air will freeze the moisture in the air and this collects on the outside as a sort of snow or frost. That in turn retards the vaporization. So, heat is furnished from the handiest source. On some cars this is the hot jacket water and on others the heat of the exhaust pipe is used. It is very seldom that both are utilized on the same cars.

The purpose of making the carbureter with a jacket is to allow the use of the hot water if desired. All carbureters so made may also be had without the jacket. The majority of drivers prefer to do without this external heat supply in summer or in warmer climates.

COLOR TELLS THE STORY.

Editor THE AUTOMOBILE:

[1,831.]—Will you please tell me what the color of the exhaust indicates; that is, how can you tell from its color what is wrong?
Baltimore, Md.
STUDENT.

The exhaust from a perfect mixture is practically colorless. When the exhaust has the form of a dense smoke it may indicate one of two things. Either you are using too much lubricating oil, in which case the smoke will have a blue color, or else you are using too much gasoline, when the smoke will be more black and contain much soot. If the former is the trouble, you may not be able to remedy it at once. The whole system will be so full of oil that it will not burn out in a few minutes. The waste of fuel, on the other hand, can be remedied at once.

ONE PLUG WON'T SPARK.

Editor THE AUTOMOBILE:

[1,832.]—Will you please help me out of a little ignition trouble? My four-cylinder engine is ignited by means of a magneto, coil and regular spark plugs. Number one and three fire all right, but cylinders two and four will not fire as they should, although they sometimes spark. Can you tell me what is the most likely source of trouble, so that I can fix it?
Torrington, Conn.
R. E. PAIR.

There are a number of likely sources of trouble in your case. First, the insulation of the wires to the cylinders which are at fault may be defective. Defective insulation may be due to moisture, as water or oil, wire touching metal so as to ground the circuit, or the insulation in the two sections of the coil may be partly broken

down. Second, you may have loose connections in those two circuits, at the plugs or at the coil. Third, the spark plugs may be defective. A cracked porcelain will cause trouble like this. Or the insulation on the plug may be partially broken down so that the plug is fooling you by sparking all right in air but won't jump correctly in the higher pressure of the compressed mixture. In the latter case, the current will leak through the defective insulation of the plug rather than jump the air gap.

These are the principal sources of trouble in a case like yours and of them all you will find the defective insulation within the coil the most elusive and, at the same time, the most troublesome.

GASOLINE ATTACKS RUBBER.

Editor THE AUTOMOBILE:

[1,833.]—In the March 25 issue of "The Automobile" was printed a description of a tire inflater, which utilized the compression from one cylinder of an automobile engine. It being a well-known fact that gasoline, as well as oil, has an injurious effect upon rubber, it seems to me that the carbureter air which this device pumps into the tires, containing gasoline as it does, would have the same effect upon the inner tube.

If I am mistaken about this, I would be pleased to be corrected, as I have received several inquiries on the practicability of such a device.

Youngstown, O.

E. F. McNUTT.

Regardless of any merit or demerit of the particular device in question, the fact exists that gasoline always and under all conditions attacks rubber. So any mechanism which introduces gasoline or its vapor into a tire would have a more or less destructive effect. Experience will tell the exact result in this specific case.

WHAT IS A CYCLE?

Editor THE AUTOMOBILE:

[1,834.]—Will you please advise me through "Letters Interesting and Instructive" the meaning of the word cycle as used in connection with automobile engines?

INTERESTED READER.

Chihuahua, Mexico.

Webster defines a cycle as: An interval of time in which a certain succession of events or phenomena is complete, and then returns again and again, uniformly and continually in the same order. In the automobile engine, the phrase used at first was two-stroke cycle, four-stroke cycle, etc., but now the word stroke is usually omitted. These phrases were used to indicate the number of strokes in which the succession of events necessary to the operation of the engine, viz., suction, compression, expansion and exhaust, were completed. Until very recently there were but three of these phrases: two cycle, four cycle, six cycle. A French engine described on page 314 of THE AUTOMOBILE for Feb. 18, however, works three cycle.

RED-HOT EXHAUST PIPE.

Editor THE AUTOMOBILE:

[1,835.]—Will you please explain what is likely to cause the exhaust pipe on my car to become red hot as it does? I am a careful driver and do not like it to do this, although there is no real harm done.
Yonkers, N. Y.
J. T. D.

There are four possible causes for your trouble. First, the muffler may be clogged. Second, you may be driving too much on the low gear. Third, your exhaust may be throttled too much either in the pipes or in the engine. Fourth, it is possible that you drive too much with a retarded spark. The first can be remedied by taking the muffler off and cleaning it. The second and fourth you can change even easier than that. The third, on the other hand, will require some study and possibly some work. If the exhaust is throttled in the engine, other than changing the valve timing so as to hold the exhaust valve open longer, you can do very little. If it is in the pipes, you can change the bends and make the passage of the gas easier.

THE THREE-SPEED PLANETARY.

Editor THE AUTOMOBILE:

[1,836.]—Will you tell me if there are any three speed and reverse planetary transmission in actual use in this country, and if so, who uses them?
Belleville, Kan.
AUTOCAR.

To our knowledge there are no cars built in this country so equipped, but in England a car has been brought out recently with this form of transmission. That is, it is called a three-speed planetary but correctly speaking there is no epicyclic action except when the reverse is engaged. No internal gears are employed in the construction and although a series of planet wheels is used, in the generally accepted sense of the word, this is not a planetary.

The big trouble with the three-speed planetary is the complications attendant upon its construction and the great flywheel effect when the whole transmission is revolving as a unit. The weight is increased very materially by the transmission itself and by the additional control necessary. The latter is a complication over the two speed form. Summed up, the advantages are few and the disadvantages many.

COMPACT ARIES ENGINE.

Editor THE AUTOMOBILE:

[1,837.]—Will you please answer the following questions relative to the Aries engine described in the February 18 issue of "The Automobile": (1) What are the advantages of this motor over an ordinary four-cylinder motor? (2) What is the relative balance of a motor of this sort and what is the firing order? (3) What firm makes it and where are they located?
Wilkes-Barre, Pa.
R. S. O'HARA.

(1) The great advantage of this engine consists of the small space which it takes

up and the obtaining of two impulses per revolution. The length of the space occupied is nearly one-half of that taken up by an ordinary engine of the same power.

(2) The firing order is: Front right, rear right, front left, rear left. This brings the first two impulses 180 degrees apart, 165 to the next, then 180 again, 195 back to number one. The construction is such that it is similar to the two-cylinder, two-crank engine. The balancing is: Primary forces balanced, primary couple unbalanced, secondary forces unbalanced. Owing to the arrangement of the three-crank discs within the case, a heavy fly-wheel effect is obtained which makes the value of the balanced primary forces very great in comparison with the others.

(3) It is made by the Société Anonyme des Automobiles Aries, 39 Quai d'Argenteuil, Villeneuve-la-Garrone, France.

TWO-CYCLE MAGNETOS.

Editor THE AUTOMOBILE:

[1,838.]—I desire to build a three-cylinder two-cycle engine, and want to use a magneto for ignition. Will you please tell me whether to use a three- or a six-cylinder magneto, and how to connect it up to the engine? Will it be necessary to use two sets of spark plugs? How fast must the magneto run compared with the crankshaft? I have a six-cylinder magneto which I would like to use if it is possible, as that will save my buying another. A. D. SOFT.
New Rochelle, N. J.

To answer your question rationally it will be necessary to select a firing order for a six-cylinder four-cycle and a three-cylinder two-cycle. Suppose this be taken as 1, 5, 3, 6, 2, 4 for the six and 1, 3, 2 for the three. The whole number of cylinders is fired in two complete revolutions in the former case, while in the latter they are all fired in one complete revolution. Therefore to put them on a comparative basis it will be necessary to consider two complete revolutions in the latter case. This would make the firing order read 1, 3, 2, 1, 3, 2. Now, if you have a six-cylinder magneto it is geared to fire all six cylinders in one of its own revolutions or one-half of the crankshaft speed. In using this same magneto on a two-cycle three-cylinder engine, if geared the same as before, you would get six sparks per magneto revolution, which is per two crankshaft turns. As this is the required number to spark each of three cylinders twice, all that will be necessary is to provide two sets of spark plugs and connect them to the magneto so that they are used alternately.

Thus, the first turn of the crankshaft will produce a spark in each cylinder using the first set of plugs. Then the second set will come into use on the second turn of the shaft, and so forth.

If you did not have the six-cylinder magneto on hand, it would probably be preferable to purchase a special three-cylinder magneto and so gear it as to turn at crankshaft speed, which would give you the same results, viz., three explosions per revolution. In that case the extra set of plugs and the wiring would be eliminated, simplifying the whole ignition system, and

the wiring from the magneto would be so simple that it would be impossible to make a mistake. To return to the firing order in the case of the three, the magneto leads would have to run to cylinders 1, 3, 2 of the first set, then 1, 3, 2 of the second set.

Some magneto firms furnish magnetos in multiples of two only, varying the speed to care for cases like three cylinders or other odd numbers. These would not give you any trouble, however, as instructions are furnished with each instrument sold.

In the case that the magneto which you have is wound to turn at one and a half times the crankshaft speed for a four-cycle, it will only be necessary to run it at the same speed for a two-cycle of half the number of cylinders as brought out above.

HOW TO VAPORIZE KEROSENE.

Editor THE AUTOMOBILE:

[1,839.]—Will you please tell me the general principles of the vaporization of kerosene and why it is not more generally used for automobiles? A. B. DUGAN.
Jersey City, N. J.

The principal reason why kerosene is not more generally used is because of the lack of suitable vaporizers. To gasify any of the heavier hydrocarbons, a great deal of heat is necessary, much more than that furnished by air in the case of gasoline. In the usual kerosene carbureter, the fuel is heated previous to spraying it into the mixing chamber, by using the exhaust, circulated around the kerosene inlet. It is then atomized, in a chamber which is also furnished with a source of heat to assist that action. A second method is to compress the air only to a very high, an excessive pressure, within the cylinder and then spray the kerosene into that highly compressed and highly heated air. This heat ignites the entering stream of kerosene spray. The method employed in the Diesel motor is very similar to this.

The greatest disadvantage of the use of kerosene is starting. For this, the mixing device must be heated with a torch or else gasoline must be used to start on. A majority of automobilists finding it necessary to use gasoline for starting will use it for running sooner than bother with two fuels.

THE AREA OF MUFFLERS.

Editor THE AUTOMOBILE:

[1,840.]—I am having trouble with my muffler so will ask you to please answer a few questions relative to the same. Should the area of the muffler be less than the area of the exhaust pipe leading to it? In the case of mine, the cubical contents of the muffler are but one-half of the volume which is swept out by the piston. Should this be so? Moreover, the area of the small openings out of the muffler into the air is less than one-fourth of the area of the exhaust pipe. Is not this wrong in principle? Dayton, Ohio. JOHN O'BRIEN.

An increase in pressure is accompanied by a corresponding decrease in volume, and the reverse of this, a decrease in pressure, always shows an increase in volume. These are natural, unchangeable laws. In the case of a muffler, the gas entering it from the engine is at a high pressure, say, 35

pounds per square inch. The volume is accordingly low. The object of the muffler is to reduce this pressure to atmospheric or as close to it as practical. Let us say that the object is to get a terminal pressure of 16 pounds per square inch. The volume will be increased proportionately.

So instead of a decrease in the volume of the muffler pipes what is wanted is a large increase. It is hard to see how the area of the muffler can be less than that of the exhaust pipe, as per your first statement. In the matter of your second statement, the cubical contents ought properly to be about twice the pipe, rather than the one-half of your case, so you should enlarge yours four times. Relative to the area of the small final openings these should be the largest of all, if volume only be considered, as at that point the volume is at a maximum. But it is usual here to consider the speed, by increasing which the induction effect is increased. As the work of reducing the pressure has been completed at this point, the reduction necessary to effect a much higher speed of the gases does no great harm.

MORE TIRE INFLATION.

Editor THE AUTOMOBILE:

[1,841.]—Will you please give me further information about Mr. Maxim's tire inflater, described on page 516 of "The Automobile"? He takes gas from the inlet valve on the compression stroke and is therefore using explosive mixture to fill the tire. What effect will gas of this quality have on my tires? Does he not also get a little gas that has been exploded? He uses a check valve above the cylinder stop-cock undoubtedly. Grafton, Mass. SUBSCRIBER.

As far as the explosive character of the mixture is concerned, but does not make any difference. The illustration of the device shows the check valve above the ordinary cock. Your other questions were answered in the answer to E. F. McNutt.

TO ERADICATE AN EVIL.

[1,842.]—The chauffeur is at the present time getting his semi-annual raking over the coals regarding speeding. They are arresting them quite fast now, and at least they help to raise the debt the city is now in.

When we read in a newspaper how a chauffeur runs over and kills someone, we all line up to have his life for speeding; maybe he was going fast, and maybe not. At any rate, he can choose between being mobbed to death or to escape, and at a moment's thought he speeds away, naturally leaving no doubt that he was responsible for the accident.

Now, if all chauffeurs, when they have an accident, would only stop and ask for witnesses, and give local aid, this idea of lynching would soon leave the people and they would begin to think that maybe the chauffeur is not all at fault. And the judges would not doubt his word so much.

There is no doubt that a good many accidents now occurring could be easily avoided if the public at large would use their eyesight more when crossing an avenue or street, instead of plunging before an automobile or any other vehicle which is going even only eight miles an hour. And another thing: If the people walking could be made to cross the streets at corners I do not think there would be so many accidents as now occur; because drivers would be on the lookout for the people at these points. People will cross the street in the middle of the block, where drivers least expect them.

So, what is to be done? Not only is the chauffeur to be arrested for speeding and reckless driving, but the people ought also be made to cross the streets and avenues at the proper point, or do so at their own risk.

EDWARD VAN BAERLE.
New York City.

NEW YORK'S HIGHWAY COMMISSION IS INVESTIGATING

ALBANY, N. Y., April 9.—That the cost of maintaining and repairing good roads in this State during the next year will cost at least \$1,500,000, and that the Legislature will look to the owners of automobiles to meet their share of this expense, were among the points that were clearly set forth to-day when the Senate Committee on Internal Affairs gave a hearing on the Allds-Hamn bill, which among other things imposes a substantial registration fee.

Under the provisions of the bill all owners and operators must be registered with the Secretary of State. The registration tax is fixed at \$5 for cars weighing 1,500 pounds or less, \$10 if the weight be between 1,500 and 2,500 pounds, and an additional \$5 for each additional 500 pounds in weight. The bill exempts the automobile from all other taxation.

Charles T. Terry, representing the New York State Automobile Association, took the position that a tax of this character would be discriminatory and invalid. He maintained that the automobile had a right on the highway and that any tax to be equitable must be met by all users of the road.

Senator Allds asked Mr. Terry why the automobile associations had changed their attitude on the question of a tax since last year. Mr. Terry replied that he had no part in the matter.

"The reports of the Massachusetts Highway Commission," Senator Allds said, "show that the automobiles are responsible for 62 per cent. of the wear and tear of roads. Why should not automobiles meet their share of the expense of maintenance?" "The highways are used by every one, and why should not all users pay?" asked Mr. Terry in reply.

Senator Allds said that the method of road construction must be changed on account of the automobile. He said the roads were now going to pieces and that the State must look to the automobile for at least a part of the expense.

"The care of the highway is a governmental expense," said Mr. Terry. "I deny that the automobile wears the roads more than horse-drawn vehicles. The wear is in another way."

Alfred Ely, of the Automobile Club of America, complained of the excessive penalty for the first offense in cases of violation of the speed law. He favored the provision which requires the payment of all penalties and fines into the State treasury.

Speaking in behalf of the farmers, F. N. Godfrey, master of the State Grange, declared that owners of automobiles should pay a special tax, inasmuch as a special highway tax was assessed upon the owners of farm lands.

Giles H. Stilwell, of Syracuse; George C. Diehl, of Buffalo, and O. A. Quayle, of Albany, took the general ground upon which the argument of Mr. Terry was based.

It is estimated that the registration fee as proposed in the Allds-Hamn bill will yield a revenue of \$600,000 a year.

It was argued that the wear and tear on good roads by automobiles has been such that the State Highway Commission will not award any more contracts for good roads construction this year, but will devote its efforts to the 500 miles of additional goods roads work now under contract and to the repairing of the 1,800 miles of good roads now constructed.

The Highway Commission has asked the Legislature for an appropriation of \$1,500,000 to repair these 1,800 miles of good roads.

The commission is experimenting with an asphalt cement, which is to be utilized in covering all of the stone macadam roads so far constructed.

Meanwhile the State Highway Commission is investigating the question with a view of revolutionizing road construction in this State so as to produce a road which will successfully meet the wear of the automobile.

SITUATION IN NEW JERSEY IS NONE TOO REASSURING

TRENTON, N. J., April 12.—Of course half a loaf is better than no loaf at all, and for that reason one of the stipulations in the Bradley bill that has been most vigorously discussed in and out of the State may be accepted as the best possible result under the circumstances. It would appear that the new tourist's privilege clause, allowing non-residents to use the roads of New Jersey, is to cost \$1 and to be available for eight consecutive days, or four periods of two days each. It is explained that the fee of \$1 to accompany the application to be made to the department of motor vehicles is not to be considered a license fee, but simply a payment for the clerical trouble involved in the issuing of the temporary license tag.

To many this looks like an unnecessary imposition upon visitors, in view of the fact that none of the other States are likely to have anything similar when the State Legislatures adjourn, and there is a feeling that there will still be some resentment against visiting Jersey.

There are three other main changes included in the so-called Bradley bill. The most important of these is the reduced fee for justices of the peace and witnesses in automobile cases. The

second change raises the speed limit from 20 to 25 miles an hour in the open country where the houses are on an average of more than 100 feet apart. The third gives the commissioner of motor vehicles power to grant a temporary license for persons learning.

To clear up the confusion with regard to the Bradley bill, embodying changes in the main automobile law, a conference committee composed of three members of the Senate and three members of the Assembly has been appointed. The trouble with this measure has been caused principally through an amendment introduced by Assemblyman Young, permitting the use of chains on automobile tires while traveling on gravel roads. This amendment is not one that is wanted by the majority of motorists, and had not been asked for by the Associated Automobile Clubs of New Jersey.

In the matter of obtaining lights on all vehicles, that bill after having passed the Assembly now seems to be reposing in the Senate committee on agriculture, of which George W. Gaunt, master of the State Farmers' Grange, is chairman. Apparently there is going to be some difficulty in rescuing this measure from the committee and sending it to its final vote in the Senate.

SITUATION NOW COMPLICATED IN PENNSYLVANIA

PHILADELPHIA, April 12.—Between the "devil" of the Senate and the "deep sea" of the House of Representatives the legislation specially dear to the hearts of automobilists in this city and State will have a hard row to hoe if it is to emerge from the law mill in a shape satisfactory to anybody. The time to do anything worth while is limited, for the Legislature is due to adjourn Thursday.

In the matter of the automobile code the Senate prefers the Grim bill, while the House swears by the Townsend bill. Each branch passed its own bill and sent it to the other. The House amended the Grim bill till it resembled the Townsend measure, and the Senate reciprocated by torturing the latter into a verisimilitude of the Grim bill. The conference committees of the two houses will have to settle the dispute, but it is greatly to

be feared that both measures will fail from lack of time to finally pass either, or that if one is finally decided upon it will be in such shape that all hands will disown it.

The main point at variance is that the Grim measure would license operators, while the Townsend bill would register the cars, and as additional revenue appears to be one of the main objects, the Senators seem to have the Representatives on the hip, for there are approximately twice as many operators as cars in the State. In the matter of the disposition of the fines, there is also a difference of opinion between the two branches. While the House measure as passed finally divides the fines between the State and the townships, according to the class of offense for which they are inflicted, the Senate bill provides that all such money shall be turned into the State treasury.

The cross-State highway bill is also in danger from almost the same combination of circumstances, although in this case there are no twin measures to bother the conferees. The Governor's heart and soul is in the measure, as he desires it as a movement to his administration, and it is quite likely that in the event of its passage in an emasculated form or of the failure of the conferees to agree, some of the pet measures of those responsible therefor will meet with short shrift at his excellency's hands. This is one strong card the automobilists and others interested in the measure are banking on.

CONNECTICUT WILL WELCOME OUTSIDERS.

HARTFORD, CONN., April 12.—The proposed automobile bill drawn up by the committee on roads, rivers, and bridges of the Connecticut State legislature will be presented to the Senate to-morrow. The new bill contains many changes.

Provision is made for the establishment of the office of commissioner of motor vehicles, as already reported. The registration of all cars will expire December 31.

Non-residents, contrary to the prevailing opinion, will not be subjected to any harsh treatment and will be able to use the highways of the State as heretofore. This feature of the bill is commendable.

The cutting out of mufflers is prohibited.

No one less than 16 years of age can operate a motor car under any conditions. Licenses must bear the signature of the party to whom they are issued, and the fees have been increased.

In the matter of speed, various provisions have been looked to, and in city driving ten miles per hour will probably be the maximum. Another provision of the bill will make "joy riding" a hardship. An owner becomes liable for the driver's actions, whose license may be revoked on the second offense.

OHIO LAWMAKER SAYS "MORE MONEY."

COLUMBUS, O., April 12.—Representative Owen J. Evans, of Stark County, in an interview recently given to his home paper, said among other things: "I am in favor of increasing the license on automobiles in Ohio from \$5 to \$20 for six-cylinder machines. For two-cylinder machines the license should be \$10 a year. I expect to incorporate these figures into a bill which will be introduced at the next session of the General Assembly and which I will ask to be enacted into a law. I am also in favor of asking the General Assembly to appropriate \$20,000 for each county in Ohio for the improvement of the highways."

Automobile men are of the opinion that a law providing for a State license of \$20 and \$10 would be declared confiscatory by the Supreme Court and as a result unconstitutional.

NEW YORK STATE MAY LIMIT RECIPROCITY.

ALBANY, N. Y., April 13.—The Robinson bill which to-day passed the Assembly provides in the matter of registration reciprocity recognition only to those non-residents coming from States and territories which grant similar privileges to New York automobilists. Evidently this action is aimed at New Jersey, since Pennsylvania's new law will grant reciprocity.



Harry S. Houpt Company's New Store, New York City.

HOUP T OPENS NEW YORK SALESROOMS.

NEW YORK, April 12.—Herreshoff automobiles now have a home of their own in the metropolitan district, through the opening Saturday of the new showrooms of the Harry S. Houpt Company, Broadway and Sixty-eighth street. For some weeks the cars have been shown at the Hotel Marie Antoinette, during the completion of the new headquarters. Mr. Houpt has one of the most beautiful business places along automobile row, with the interior finished in silver and white, arranged to set off to advantage the latest candidate for light car honors. The Houpt cars will also be handled from this location, when they arrive on the market. Office space is on the second floor.

REMY PLANT IS GROWING RAPIDLY

ANDERSON, IND., April 12.—Three thousand magnetos a week will be the capacity of the Remy Electric Company, when the new brick building, 200 feet by 70 feet, is completed. The structure is to be ready for occupation within thirty days. The new building is but the first of several which are to be completed before the beginning of the 1910 season. Conservative figures, based on the present minimum specified deliveries, estimate the 1909 output of Remy magnetos at 60,000.

The new structure will be of brick, fireproof, with plenty of windows and thoroughly modern in every respect. One of the popular departments which will be enlarged by the factory addition will be the shop for making fittings for attaching Remy magnetos to old-model cars. The Remy plant is now claimed to be the largest in the world devoted exclusively to magnetos.

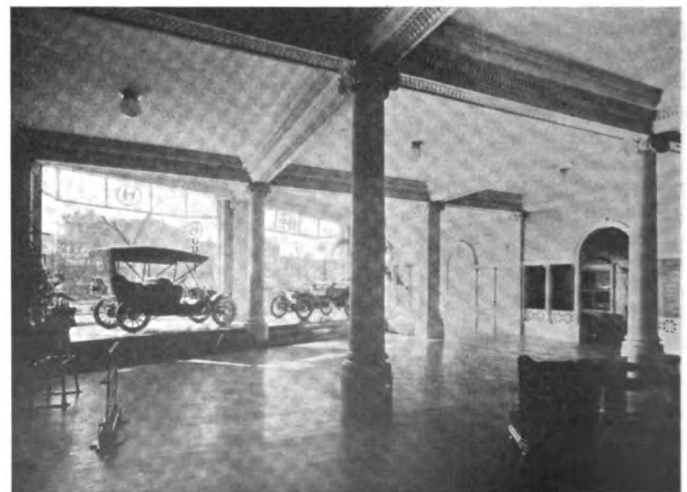

Interior of the Capacious Houpt Salesrooms.

DISTINGUISHING AN ENGINE BY ITS EXHAUST

PARIS, April 8.—Distinguishing the make of an invisible automobile merely by the sound of its open exhaust proved to be a more difficult task than the contestants had anticipated. There were twenty-two competitors united in a Parisian garage last Sunday morning, and twelve different cars, varying from a one-lunger Sizaire to a lordly 60-horsepower Mercedes, on which the twenty-two had to try their acoustic powers.

Each motor was started up in turn before the competitors and allowed to run for a few seconds with its exhaust pipes removed. The names of all the cars except one had been announced in advance in order to give the intending competitors an opportunity of training. The exception was Charles Y. Knight's sliding-valve engine, built by the Daimler Company, of England; when the time came for it to give the preliminary unmuffled bark the mechanic was still struggling with the exhaust pipe connections, and to save time the competitors were sent behind the heavy curtain without having heard the notes of the exhaust. The engine being quite new to France, it is doubtful if any of the mechanics present were acquainted with its sound.

The first car to be run alongside the heavy curtain behind which the competitors were massed was a four-cylinder Minerva, which proved one of the most difficult to recognize in the whole group. A 1909 four-cylinder Renault followed and for the space of sixty seconds abandoned its pretension to be the most silent car in the world. A Bayard-Clement quickly took its place and added further variety to the exhaust solos. The little Gregoire two-cylinder must have been an easy one for the men behind the curtain, for it was the only twin cylinder under test.

The Sizaire-Naudin one-lunger was equally easy, for there was an unmistakable harshness from its high-speed, high-compression engine. A large Panhard emitted its cheerful healthy hum, contrasting strongly with the harsher and sharper bark of the 1909 Mercedes which immediately followed. The little Lion-Peugeot one-lunger, too, made a strong contrast with the Sizaire-

Naudin, although the two were almost identical in power and bore of cylinder. The Delage diminutive four-cylinder had more of a hum than a roar, and should not have deceived any who had previously listened to its sound.

The Knight sliding-valve engine, that nobody had heard before, and that was looked upon as the stumbling block of the competition, proved to have such a soft muffled sound, even with the exhaust box removed, that nobody could be deceived. A four-cylinder Gregoire added its contribution to the solos, and the last note to be heard was the strident cry of a four-cylinder Mors.

The competition was rendered the more difficult from the fact that the exhaust piping was not entirely removed in all cases. This was left to the appreciation of the mechanics, and where it was more convenient to do so the piping was removed at the engine itself; in other cases disconnection was made where the tubing entered the exhaust box; in a few cases an exhaust cutout was brought into use. Obviously the sound was modified according to whether the exhaust passed directly into the air or first traveled along several feet of piping.

After examination of the papers it was found that the winner was Victor Gros, a nineteen-year-old mechanic, who had correctly named eight of the twelve machines. M. Leguen, a veteran mechanic, really paired with his young rival, giving eight out of twelve, but as he had not attempted to designate the remaining four, he was put into second position. Drouet and Poupelin, both young mechanics, each correctly named six cars out of a possible twelve, and M. Fontaine, a young soldier in an engineer regiment, shared fourth prize with M. Docrine, each having five correct answers out of twelve. Five others gave three correct answers, while the rest could do no better than two, one and nothing.

The winner failed on Minerva, Delage four-cylinder, Mors, and Gregoire four cylinder; the second man found his stumbling blocks in Minerva, Gregoire, Mors and Renault.

FRENCH SALON LOOKS IMPROBABLE NEXT WINTER

PARIS, April 8.—Of the four associations jointly responsible for the Paris Salon the two most important are so stoutly opposed to the event that its abolition for 1909 is practically certain. The executive committee, presided over by Gustave Rives, and responsible for the organization of the fashionable exhibition in the Grand Palais, is recruited from the Automobile Club of France, the Chambre Syndicale de l'Automobile, the Chambre Syndicale du Cycle et de l'Automobile, and the Syndicat des Fabricants de Cycles. Profits arising from the Salon are carried to a reserve fund in the name of the four interested parties.

The Automobile Club of France, only a certain proportion of whose members are actively engaged in the industry, believes that the show should be continued, and has voted accordingly. In this, of course, they are only looking to their own interests, the Salon always having been a source of profit. The comparatively unimportant Syndicat des Fabricants de Cycles, not having to bear much of the expense of costly exhibitions, has also voted in favor of the retention of the Paris Salon.

The Chambre Syndicale du Cycle et de l'Automobile, under the presidency of M. Darracq, has declared by a large majority against the holding of a show in 1909. The Chambre Syndicale de l'Automobile was capable of deciding either for or against the show, and particular importance therefore attached to the meeting of its committee this week when the Paris Salon came up for consideration. The Marquis de Dion, president of the Chambre Syndicale, fought stoutly for the retention of the annual show on the grounds that it was necessary for the complete develop-

ment of the industry. The members of his committee, however, were not all of the same opinion, and after a wordy battle lasting two hours, the vote was 11 for and 10 against, with 2 blank.

The anti-show vote has still to be ratified by the full assembly of the Chambre Syndicale, and if this is done it is difficult to understand how the Paris Salon can be held. The Marquis de Dion declares that if the full meeting of his association votes in favor of the abolition of the show he will resign his position of president and work with the Automobile Club of France for the holding of the show. A salon, however, in which none of the leading firms will take part is not worthy the name of national.

MICHELIN GIVES BRITISH AERO PRIZE.

LONDON, April 3.—The Michelin prize has done so much to help on the progress of aviation in France that great interest has been evinced at the news that the tire firm has offered a British Michelin prize to the Aero Club of the United Kingdom. The prize takes the form of a \$2,500 trophy, and a further sum of \$2,500 will be awarded to winners during the next five years.

The contest is limited to British aviators employing British-built machines, and, as with the French prize, the winner will be the one who flies the greatest distance over a certain specified course. The minimum distance for each year must be double that of the preceding year till the 250-mile mark has been reached. Should the prize not be gained during any one year, the money endowment would be added to that of the next year.

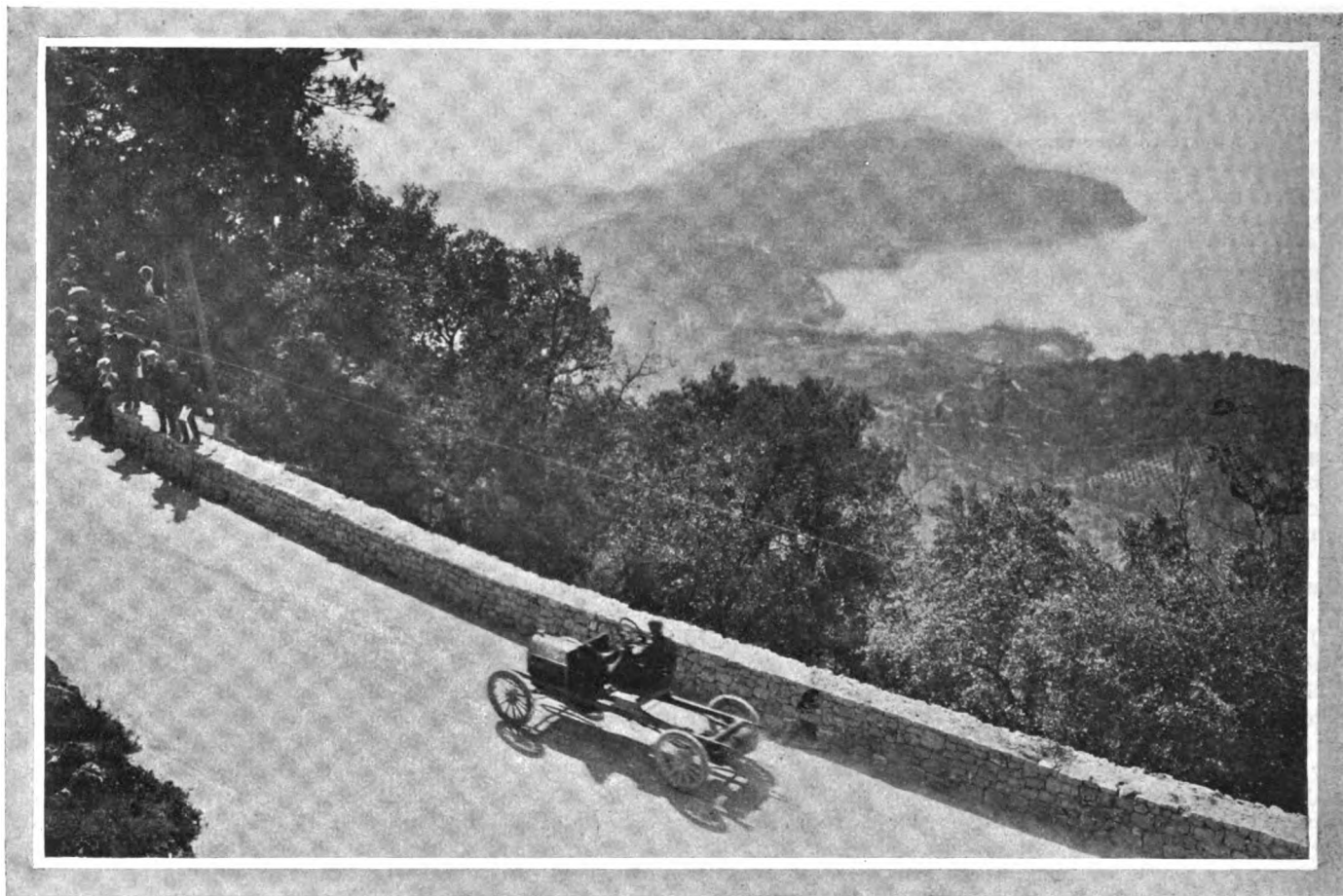

How La Turbie Is Conquered These Days

By W. F. Dradley



PARIS, April 5.—The past week saw the revival of the once famous hill-climbing contest of La Turbie, the hill near Nice in the south of France. The events of the meeting, which lasted a week from March 28, were aided by almost perfect weather and plenty of sunshine. The course selected was 6 kilos 400 meters long (3.974 miles), with a practically perfect surface, but a few bad turns. At these some of the less fortunate contestants turned turtle, but no one was hurt. This was indeed fortunate, considering the circumstances under which the races were formerly abandoned as well as for the drivers themselves, taking into account the speed at which they were traveling and the nature of the curves. Among the cars which overturned, but fortunately were not damaged, were a Mors, Berliet and Darracq, with such skillful drivers "up" as Hallut, Whitlock and Ragusa.

The two things that stand out most prominently in the result are the performances of Sizaire and Bayard-Clement. The latter won a double victory, taking first place in each of two in the total of nine classes, which brought corresponding honor because no other make scored in more than one contest. These classes were the two-cylinder, any bore or stroke, and the four-cylinder, limited to 75-85 mm. (2.95-3.35").

This was completely overshadowed by the victory of the cars bearing the name of Sizaire & Naudin. These little "one-lungers" not only won the monocylinder event, but took second, third, fourth and fifth in the same. Not content with this, Sizaire, who drove the winner, made the second fastest time of the week, being beaten only by the Opel, with a four-cylinder machine of 115 mm. (4.53") bore, the limit in its class. This means, also, that Sizaire not only hopelessly outclassed all other single-cylinder cars, but went over the severe course in less time than all of the two-cylinders, all fours except Opel, and all sixes. It was a sweeping victory for the car with a single lung.

Of equal importance with the two sterling performers just mentioned was the new Daimler car from the Unterturkheim works and fitted with the Knight engine which has caused such a furore in the past few months. This marked the first appearance of the Knight-Daimler engine in competition, and its performance was as a consequence watched very closely, more so than any other car present. This class was the fifth and for engines of any bore greater than 96 mm. and less than 105 mm. The limits just let in the model now rated at and sold as a 22-horsepower machine. The car and engine behaved very well and won second place in the division. The time made was 7 min. 29 3-5 sec., which brought it rather close to the winning La Buire.

The complete summary of the hill climbing results follows :

- Class 1—(Single cylinders)** George Sizaire (Sizaire & Naudin), time 6 mins., 12 2-5 secs.
- Class 2—(Two cylinders)** Albert Roux (Bayard-Clement), time 13 mins., 57 4-5 secs.
- Class 3—(Four cylinders of 75-85 mm. bore)** Louis Sharp (Bayard-Clement), time 8 mins., 7 2-5 secs.
- Class 4—(Four cylinders of 86-95 mm. bore)** Paul de Latzger (Laurin-Klement), time 6 mins., 42 1-5 secs.
- Class 5—(Fours of 96-105 mm. bore)** Paul Scoffier (La Buire), time 7 mins., 10 2-5 secs.
- Class 6—(Fours of 106-115 mm. bore)** Lindpaintner (Opel), time 6 mins., 0 1-5 secs.
- Class 7—(Fours of 116-130 mm. bore)** Juge (Pllain), time 7 mins., 38 4-5 secs.
- Class 8—(Six cylinders)** Schnelder (Rochet-Schnelder), time 7 mins., 21 secs.
- Class 9—(Voltorettes, Grand Prix type)** Chevillot (FEN), time 10 mins., 36 1-5 secs.

The former course differed from the one used mainly in length, the greater distance of nearly 16 kilos requiring the use of the present course and some distance on each end of it. The races have aroused all of the old enthusiasm which this week of contests always brought out and which continued up to the year of misfortune, when Zabriskie was killed and the meet abandoned.

Three days previous to the hill climbing the flying kilometer trials were held, with results very similar. The fastest time was made by an Opel, in class 7; the next by Lindpaintner, also driv-

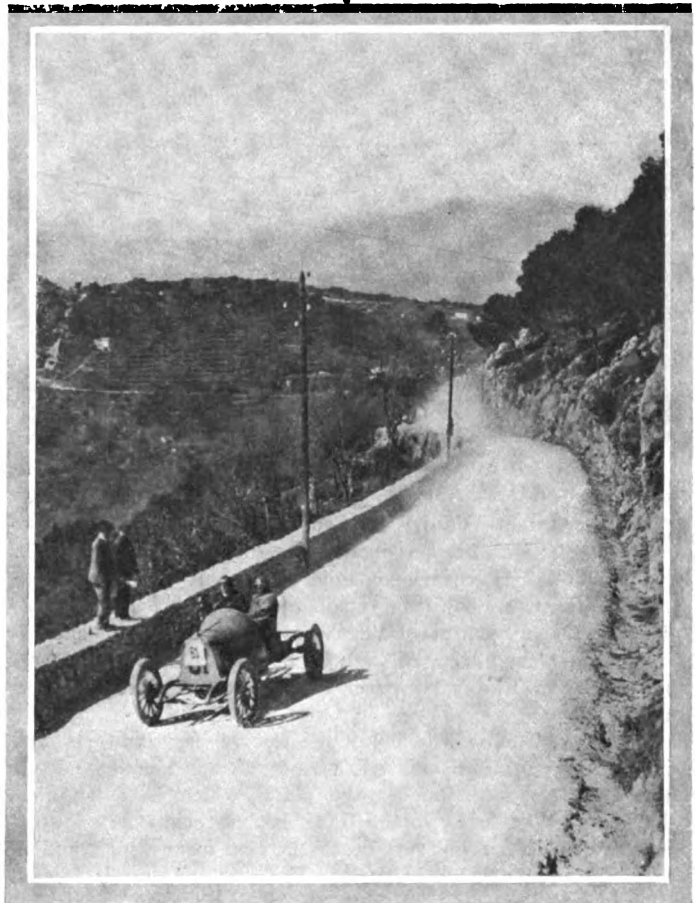

Lindpaintner and His Winning Opel on Course.



Winding Roadway Near Top of La Turbie.

ing an Opel, while George Sizaire was third. The times made were all poor, in comparison with existing records. Opel did the distance in 27 3-5 sec., which is at the rate of 89.10 m.p.h. Lindpaintner's time was much slower than this, 35 1-5 sec., equal to 63.51 m.p.h. In this competition, Sizaire with his little flyer did not press the big German cars as closely as in the hill-climbing contests, his best effort being 43 1-5 sec., equivalent to a speed of 51.75 m.p.h.

The program was so well carried out that it will doubtless be a fixture in the future and will occupy as prominent a place in the motoring calendar as it formerly did.

Problems of Aerial Flight Are Being Solved Rapidly



Santos-Dumont Getting Ready for His Monoplane Flights at St. Cyr, near Paris.

PARIS, April 9.—To-day M. Santos-Dumont made a successful flight with his new monoplane, the *Mademoiselle*, at St. Cyr, near this city, covering a mile and a half with great ease. Santos-Dumont has consistently adhered to the idea that a monoplane could be constructed that would prove practical, and his triumph over the forces of nature on this occasion gives great satisfaction to Europe's pioneer aeronautical engineer and his many friends.

His monoplane, which holds the record for lightness and diminutive size, weighs but 330 pounds, and is simplicity itself in its construction. The power plant, which is a Duthiel-Chalmers, two-cylinder opposed air-cooled engine, is located above the main bearing surface of the two main wings, and in the slight angle formed by them. The aviator's seat is located under the motor and the wings, and is a piece of canvas but five or six inches above the ground.

Farman Is Busy on Aeroplane of Special Design.

PARIS, April 7.—Dissatisfied with the little progress made during the past year with the flying machines furnished him by the builders, Henry Farman has broken away from the group and is now at the head of his own aeroplane building factory. The change affects not only the flying machine, but the engine also, Farman having decided that the eight-cylinder water-cooled engine is not good enough for his work and has ordered a seven-cylinder air-cooled rotary engine recently produced by the Gnome Company.



Duthiel-Chalmers Motor, Used by Santos-Dumont.

The engine has its seven cylinders radiating from a circular crankcase through which passes a stationary, hollow one-throw crankshaft. The cylinders are of nickel steel, and when first constructed had radiating flanges of equal depth descending down to near the end of the stroke. Shop tests showed, however, that 15 pounds of metal per engine could be saved by gradually lessening the depth of the fins as they neared the base of the cylinder. Method of attachment to the crankcase is by means of a locking ring fitting over the base

of the cylinder within the case. There is not a single projecting bolt on the face of the crankcase to receive the cylinders.

There is one main connecting rod with integral big end, and to this are attached the six other connecting rods in practically the same way as the upper end of the connecting rod is attached to its piston in standard automobile practice. The main connecting rod is fitted to the crankshaft with ball bearings. Exhaust valves are in the cylinder head, and are operated by balanced rocker arms. The inlets are in the piston head, and are consequently automatic. The firing charge arrives through an intake pipe passing through the hollow crankshaft, then passes behind the piston through the valve in its head, the carbureter, of an ordinary type, being stationary while the rest of the engine, including the magneto, is revolving.

On the Farman aeroplane the propeller, a wooden one, constructed by Chauviere, is mounted on the rear of the crankcase. The forward face of the crankcase, on which are mounted the timing gears, is covered by a torpedo-shaped aluminum casing to decrease the wind resistance. The engine develops 50 horsepower at 1,200 revolutions a minute, and they have been able to prove during the shop tests, will throttle down as low as 250 revolutions a minute without a misfire. The control is entirely on the throttle, the sparking point being fixed. The strong draught caused by the revolutions of the engine keeps the cylinders wonderfully cool. Even after two hours' steady running on the testing block the steel cylinders are hardly discolored and it is possible to touch them with the naked hand. Naturally the conditions in the open air will be still more advantageous.

Lubrication is taken care of by centrifugal force. An ordinary type of oiler is carried in some convenient position on the aeroplane, its supply of lubricant being delivered to the main bearings by a single pipe passing through the hollow crankshaft.

Henry Farman declares that in addition to the two machines that he is now building for his own use he has orders on hand for several aeroplanes of a similar type, and is prepared to turn out flying machines with a guaranteed ability to fly. It is with these machines that he intends to compete in the most important European this year.

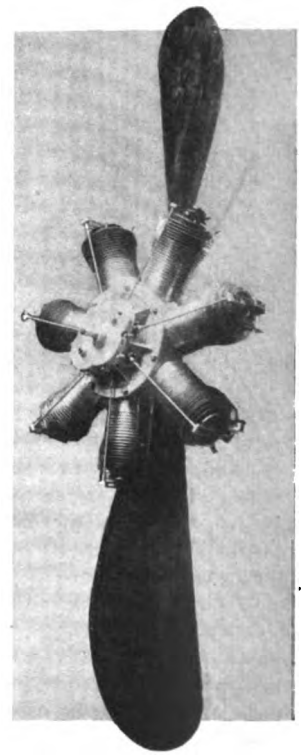

Gnome 7-Cylinder Motor, Used by Farman.

ENGINES AT BRITISH AERO SHOW.

LONDON, April 3.—At the Aeroplane Show, which has now closed its doors after a successful run, special interest was attached to the engine section, for here there was not that unfinished and doubtful air which seemed to be characteristic of the aeroplane exhibits themselves.

The British exhibits were not many in number, for several of the leading manufacturers who are known to be experimenting have, naturally enough, no desire to seek publicity for their efforts at present, but the engines that were on view showed a commendable originality of design and good workmanship.

Wolseley.—The Wolseley Motor Company exhibited two engines which were excellent representatives of their class. The first was built for aeroplane work and has eight V cylinders set at 90 degrees. The cylinders are 90 mm. bore by 125 mm. stroke, and 60 horsepower is developed at 1,350 revolutions per minute. The water jackets are of sheet aluminum and are attached to the cast steel cylinders by a row of screws. The induction and water pipes are also of aluminum. Forced lubrication to all bearings is effected by a gear pump. This engine, weighing five pounds per horsepower, has been constructed for a British monoplane, which is almost ready for its trials.

A second engine on this stand is designed for a dirigible balloon. The eight vertical cylinders of 165 mm. bore by 178

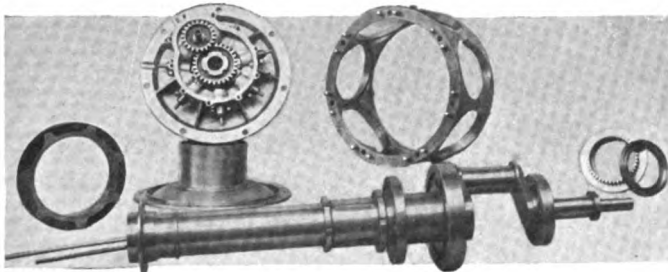

Crankshaft and Details of Gnome 7-Cylinder Motor.

mm. stroke develop 200 horsepower at 1,000 revolutions per minute. The jacket and pipes are of aluminum.

Aster.—Of the several other firms who showed engines with vertical cylinders, the Aster Company attracted special attention with the Green engine. These engines, which have four vertical cylinders for the lower powered models and eight V cylinders for the 80 horsepower type, work on the standard four-cycle principle, but the constructive details are quite original. The cylinders are separate steel castings machined all over, with cylindrical valve chambers projecting from the head. The water jackets are pressed in one piece from sheet copper and are open at the bottom end and closed at the top. When in place the bottom end slides over a rubber ring carried in a groove in the cylinder casting, thus making a water-tight joint and allowing for expansion. Above the cylinder head, the jacket presses on collars turned on the cylindrical valve seatings and are finally held in place by the aluminum domed valve covers.

A single overhead camshaft operates the valves through rock levers. These levers are all enclosed in an oil-tight aluminum casing and the whole arrangement can be hinged back out of the way when a valve is to be removed. The cylinder holding-down bolts also hold the five substantial crankshaft bearings.

New.—The New Engine Company is the first well-known British firm to adopt the two-cycle engine, and its production seems quite an advance on existing types. The 40 horsepower model has four steel cylinders, 4 1-2-inch bore by 4-inch stroke. The exhaust ports open when the piston has traveled half way down on its stroke, the burnt gases discharging direct into a silencer. A little further in the stroke the inlet ports are uncovered and a blast of air is blown in, driving out the remainder of the products of combustion. The air blast remains in operation till the end of the stroke and is then diverted by a rotary valve into an aluminum jacket surrounding the cylinders, replacing the usual water jacket. At the commencement of the

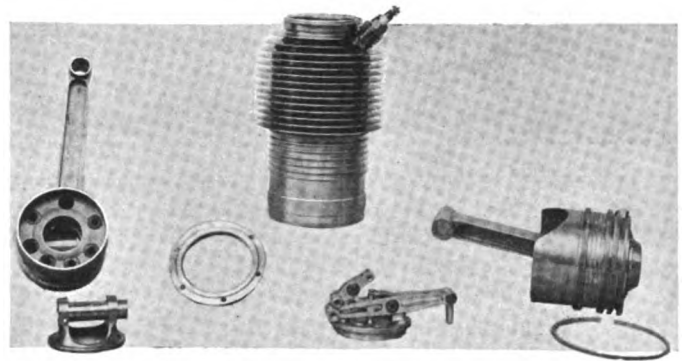

Cylinder and Piston of Gnome Motor, Disassembled.

upward stroke a charge of very rich mixture is admitted to the cylinder through the rotary valve and the resultant explosive mixture is compressed and fired in the usual way.

International.—The International rotary motor is another British production that works on novel lines. The two cylinders are opposed, and with each is cast half of the crankcase. The propeller shaft is attached to a ring bolted to the cylinder castings, while the crankshaft, with its two cranks at 180 degrees, remains stationary. The gas is drawn through a non-return valve into the crank chamber, and as the pistons come together the gas is forced into one cylinder or the other alternately through an external pipe. The inlet and exhaust valves are mechanically operated and no springs are used, the valves closing themselves quickly by centrifugal force. The ignition is by Bosch magneto and the current is conducted to the plugs through two spring plungers working on slip rings.

Continental Makes.—All the best known Continental engines that were to be seen at the Paris Show were staged at Olympia, and in many cases improvements have been effected during the interval. The R. E. P. engine is now made in a 10-cylinder type, rated at 40-50 horsepower, in addition to the five and seven-cylinder models previously supplied. In all these engines the cylinders are set fanwise in two rows, the rear cylinders covering the spaces between those in the front row. The 50-horsepower Gnome has seven radial air-cooled cylinders, and these revolve around the stationary crankshaft. Other engines are the Gobron-Brillié, which has four cylinders arranged like an X, and the eight-cylinder V models of Renault and E. N. V., the former air cooled and the latter water cooled.

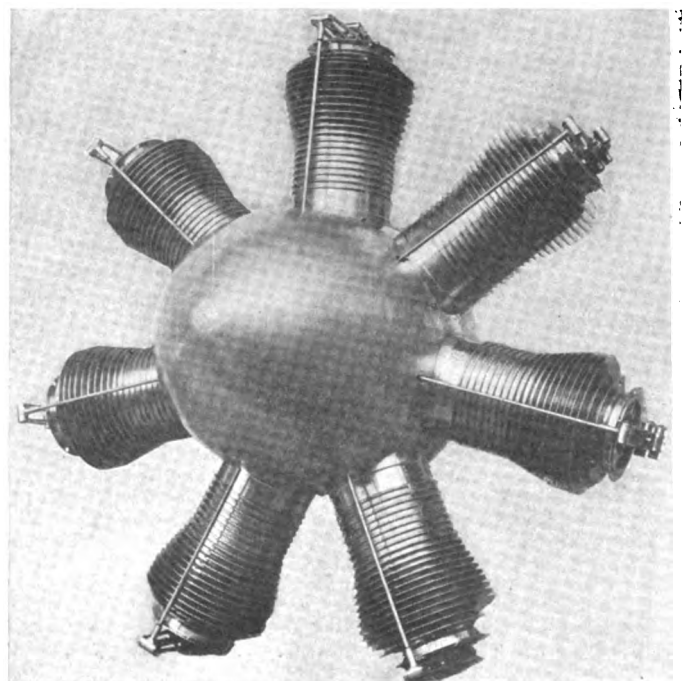

Gnome Motor, Showing Aluminum Covering Over Gears.



Vol. XX.

Thursday, April 15, 1909

No. 15

THE CLASS JOURNAL COMPANY

H. M. SWETLAND, President

231-241 West 39th Street, New York City

EDITORIAL DEPARTMENT

A. G. BATCHELDER, Managing Editor

R. F. KELSEY, Associate Editor

THOS. J. FAY

MORRIS A. HALL

W. McKEAN WHITE

W. F. BRADLEY, Foreign Representative

BUSINESS DEPARTMENT

A. B. SWETLAND, Business Manager

LOUIS R. SMITH

FRANK B. BARNETT

W. I. RALPH, 1035 Old South Building, Boston, Mass.

C. H. GURNETT, { 1200 Michigan Ave., Chicago, Ill.

F. W. VAN SICKLEN, {

H. H. GILL, Detroit, Mich.

T. B. VAN ALSTYNE, Philadelphia, Pa.

Cable Address - - - - - Autoland, New York
 Long Distance Telephone - - - - - 2046 Bryant, New York

SUBSCRIPTION RATES:

United States and Mexico - - - - - One Year, \$3.00
 Other Countries in Postal Union, including Canada - - - - - One Year, 5.00
 To Subscribers—Do not send money by ordinary mail. Remit by Draft,
 Post-Office or Express Money Order, or Register your letter.

FOREIGN SUBSCRIPTION AGENTS:

ENGLAND:—W. H. Smith & Sons, Ltd., 186 Strand, London, W. C., and all book-stalls and agencies in Great Britain; also in Paris at 248 Rue de Rivoli.
 FRANCE:—L. Baudry de Saunier, offices of "Omnia," 20 Rue Duret, Avenue de la Grande Armee, Paris.
 GERMANY:—A. Seydel, Mohrenstrasse 9, Berlin.

Entered at New York, N. Y., as second-class matter.

The Automobile is a consolidation of The Automobile (monthly) and the Motor Review (weekly), May, 1902, Dealer and Repairman (monthly), October, 1903, and the Automobile Magazine (monthly), July, 1907.

MAKING THE AUTO PAY FOR THE ROAD.

Desire is plainly evident in not a few State legislatures now in session to saddle upon the automobile owners a greater part of the cost of the upkeep of the highways. If the matter were left to a popular vote of all owners of motor-driven vehicles, it is not improbable that the decision would be favorable to a graduated annual tax, provided all other users of the highway were asked to pay their just proportion.

Once upon a time the New York *Times*, now progressive, suffered from an acute attack of automobile antagonism. But a change has come in its ideas—many other daily newspapers have had similar revisions of opinion—and we reprint concerning a proposed New York State law the following editorial which it printed it under the head of "A Motor Car Tax":

A graduated tax levied according to the weight of the machines is proposed in the Allds-Hamm bill, which prescribes rules to register, identify, and regulate motor vehicles and their operators on the public highways. The purpose of the tax is "to raise nearly enough money to repair the damage they do to the good roads." It will cost \$1,500,000 to repair the 1,800 miles of "good roads" already built in the new State system which have been raveled by autos.

For two reasons we think the proposed tax is unjust. If it is to be imposed, proportionate taxes should be applied to other vehicles using State roads. The Constitution requires this. Secondly, it is not the fault of the automobilists or of their machines that the roads are in their present plight, but the fault of the road builders. They have stupidly persisted in dressing their surfaces with a finely comminuted material which they well knew must be displaced and thrown to the rear by the so-called suction of rubber tires.

It is self-evident that the wearing surfaces of roads should be suited to the vehicles that traverse them. The newly created State Highway Commission has wisely decided not to award contracts for further construction of "trunk-line boulevards" until some one of the special surfacings of bitumen or oil with asphaltic bases shall have been adopted. Meanwhile, it would be manifestly unfair to tax motor cars or other vehicles for blunders of highway builders.

It is a fact daily becoming more apparent that the present highway is not suited to the increased demands made upon it, caused principally by the multiplied mileage of the motor-driven vehicle, and a remedy must and will be found by those entrusted with our roads building. It is far from probable that all macadam roads now being constructed are given the same careful building as was received by their predecessors. Only recently did some of the discerning politicians become aware of the fact that the people as a whole want good roads, and that in their building there might be opportunities of profit to those directing the expenditure of the public money. Roads have worn out much faster in some sections than in others, with indications that supervision might have been faulty and negligent.

But the roads question is one that is vital to a commonwealth as a whole, and, realizing such to be the case, it is predicted that the problem will be solved ultimately in a satisfactory manner.



CLASSIFICATION WILL CLEAR ATMOSPHERE.

With the definite and comprehensive classification of cars adopted by the rules committee of the Manufacturers' Contest Association, and by it recommended to the Contest Board of the A. A. A., it begins to be apparent to the lay mind that a much mixed situation is gradually being improved. Only time will prove the wisdom of the rules, but clarification on the subject of contests is an obvious necessity which has called for attention.

There have been contests and contests, each different from the previous one. Price, weight, piston displacement, various curious formulas, and all sorts of classes existed, and, upon application, were sanctioned. The result was that it was hard to decide whether a winning car really showed merit or not. The car that won in one unique class would be hopelessly left behind in the next contest with some other unusual arrangement.

To have a real comparison of the performance of two different cars, it is first necessary to have a uniform series of performances under standardized conditions. This heretofore has not been available because of haphazard classes, varying at every opportunity. Now that the manufacturers, who are the ones vitally interested in a real comparison, have stepped in, and, through the medium of their representatives, placed themselves on record as in favor of standardized tests, and deduced a set of acceptable standards, this matter has been reduced to its understandable terms.

In the future, acting under the new standards, the results obtained in the East will be comparable with those which take place in the West. The races everywhere being upon one basis, it will be possible at the end of the year to deduce the best American car in any desired class. Except that some one prominent maker absents his product, this yearly summary will be beyond question trustworthy. It begins to look as if the final result will have a very great value to all concerned.

N. A. A. M. EXECUTIVE COMMITTEE BELIEVES IN M. C. A.

PLAINLY expressed and subject to no misinterpretation was the pronounced manner in which the executive committee of the National Association of Automobile Manufacturers at the regular monthly meeting, held April 7, in New York City, placed itself upon record as approving the alliance between the Manufacturers' Contest Association and the American Automobile Association. The session was held as usual at the association's headquarters, No. 7 East Forty-second street, and the full text of the resolution is herewith given:

Whereas, The interests of automobile manufacturers in contests of all descriptions are well represented by the Manufacturers' Contest Association, to membership in which all manufacturers are eligible and to which a large number of manufacturers have already applied for membership; and

Whereas, A formal alliance has been entered into between the Manufacturers' Contest Association and the American Automobile Association, one of the conditions of which alliance provides for an advisory committee representing the manufacturers and appointed by the principal trade organizations, which committee takes an active part in the deliberations of the contest board of the American Automobile Association; and

Whereas, The interests of the trade demand not only the maintenance of such an association but active participation by it in matters relating to contests of all descriptions; be it

Resolved, That members of the National Association of Automobile Manufacturers, Inc., be and are hereby respectfully urged to apply for membership, to take an active interest in and to loyally support the Manufacturers' Contest Association and its rules; and be it further

Resolved, That the Manufacturers' Contest Association will act in accordance with the desires of this association by giving full publicity to its regulations and decisions, and by taking such definite action as will disbar from events sanctioned by the American Automobile Association all persons or organizations who or which take part in, or in any other way support any event not so sanctioned.

W. E. Metzger, the first vice-president, presided in the absence of President S. D. Waldon, who was unable to attend. These were the other members of the committee present: S. T. Davis,

Jr., Locomobile Company of America; Windsor T. White, the White Company; Thomas Henderson, Winton Motor Carriage Company; William R. Innis, Studebaker Automobile Company; C. C. Hildebrand, Stevens-Duryea Company; H. O. Smith, Premier Motor Manufacturing Company; Albert L. Pope, Pope Manufacturing Company; Benjamin Briscoe, Maxwell-Briscoe Motor Company; L. H. Kittredge, Peerless Motor Car Company; J. W. Gilson, Mitchell Motor Car Company, and C. G. Stoddard, Dayton Motor Car Company.

The Rapid Motor Vehicle Company, of Pontiac, Mich., was elected to association membership.

Atlanta Will Have a National Show.

Preceding the executive committee meeting there was a session in the morning of the show committee, during which there appeared a notable delegation from Atlanta to ask that that enterprising Southern city be placed in the very limited national show circuit, which now includes only New York and Chicago. It was the contention of the delegation from the "Gate City of the South" that a national show would be an excellent investment for the industry, and these were the men who urged Atlanta's claims: Clark Howell, managing editor of the *Atlanta Constitution*; John L. Cohen, S. C. Dobbs, of the Chamber of Commerce; Charles R. Ryan, J. T. Fitten, E. M. Hansom, and E. W. Gans.

The show committee was so favorably impressed with the arguments presented that it voted to recommend to the executive committee that Atlanta have a show conducted directly under N.A.A.M. auspices. At the executive committee's meeting the matter received thorough attention, with the result that S. A. Miles, the general manager, was empowered to conduct final negotiations with the proper parties in Atlanta, to which city Mr. Miles will subsequently pay a visit, perhaps accompanied by Alfred Reeves, of the American Motor Car Manufacturers' Association.

A. M. C. M. A. SELECTS SHOW AND OTHER COMMITTEES

R. E. OLDS will be the chairman of the new show committee of the A. M. C. A., the Committee of Management of which held its monthly meeting at 505 Fifth avenue, April 8. The other members of the committee will be S. H. Mora and Benjamin Briscoe, with Alfred Reeves as general manager. The association will conduct its tenth international automobile show at Grand Central Palace, New York, on dates yet to be named.

The formation of the Manufacturer's Contest Association, for the purpose of taking a concrete interest in racing and contest matters, was unanimously approved, and a resolution was adopted recommending that all members of the A. M. C. M. A. join and support the new organization, which has an agreement with the Automobile Association of America regarding contest matters. It was decided further that the members should be

Show Committee.—R. E. Olds, Reo Motor Car Co., chairman; S. H. Mora, Mora Motor Car Co.; Benjamin Briscoe, Maxwell-Briscoe Motor Co.

Tours and Races.—W. H. Van Der Voort, Moline Automobile Co., chairman; A. C. Newby, National Motor Vehicle Co.; V. A. Longaker, American Motor Car Co.; Walter C. Marmon, Nordyke & Marmon Co.

Good Roads.—Charles Lewis, Jackson Automobile Co., chairman; James Couzens, Ford Motor Co.; R. M. Owen, Reo Motor Car Co.; H. B. Krenning, Dorr's Motor Car Co.

Legislation.—C. G. Stoddard, Dayton Motor Car Co., chairman; A. C. Newby, National Motor Vehicle Co.; R. A. Palmer, Carter Car Co.; R. E. Graham, Acme Motor Car Co.; Walter E. Hildredth, Holsman Automobile Co.; Walter S. Austin, Austin Automobile Co.

Finance.—James Couzens, Ford Motor Co., chairman; W. G. Morse, Atlas Motor Car Co.; J. B. Bartholomew, The Bartholomew Co.

Membership.—S. H. Mora, Mora Motor Car Co., chairman; Morris Grabowsky, Rapid Motor Vehicle Co.; W. H. Van Der Voort, Moline Automobile Co.

asked to take the matter up with their dealers throughout the country that the actions of the M. C. A. may be fully supported.

A large amount of routine business was transacted, the meeting being in session until late in the day. In attendance at the meeting were: H. O. Smith (Premier Motor Manufacturing Company), chairman; C. G. Stoddard (Dayton Motor Car Company); S. H. Mora (Mora Motor Car Company); G. Vernon Rogers (Mitchell Motor Car Company); W. H. VanDerVoort (Moline Automobile Company); Benjamin Briscoe (Maxwell-Briscoe Motor Company); R. E. Olds (Reo Motor Car Company); Charles Lewis (Jackson Automobile Company); C. C. Hanch (Nordyke & Marmon Company); and Alfred Reeves, general manager. These committees for 1909 have been announced by Chairman Smith:

Advertising and Publicity.—J. N. Willys, Overland Auto Co., chairman; G. B. Louderback, Buckeye Mfg. Co.; Theo. P. Balley, St. Louis Car Co.; Leon M. Bradley, New York office; Charles E. Duryea, New York office.

Standardization and Technical.—Geo. A. Weldely, Premier Motor Mfg. Co., chairman; John D. Maxwell, Maxwell-Briscoe Motor Co.; Henry Ford, Ford Motor Co.; Max H. Grabowsky, Grabowsky Power Wagon Co.

Freight and Transportation.—G. V. Rogers, Mitchell Motor Car Co., chairman; Harry Knox, Atlas Motor Car Co.; H. W. Mack, Mack Bros. Motor Car Co.; R. Harry Croninger, Pennsylvania Auto-Motor Co.; J. N. Willys, Overland Automobile Co. (In conjunction with traffic department of N. A. A. M.)

Tires.—W. S. Marmon, Nordyke & Marmon Co., chairman; James Couzens, Ford Motor Co.; Frank Briscoe, Brush Runabout Co.; O. Stevenson, York Motor Co.; S. H. Mora, Mora Motor Car Co.

Agencies.—W. H. Van Der Voort, Moline Automobile Co., chairman; A. R. Welch, Welch Motor Car Co.; H. R. Mallow, De Luxe Motor Car Co.; Frank L. Pierce, Gaeth Automobile Co.; H. B. Larzelere, Chadwick Engineering Works.

M. C. A. PRESIDENT EXPLAINS ITS WHYFORE AND PLANS

By BENJAMIN BRISCOE, PRESIDENT MANUFACTURERS' CONTEST ASSOCIATION.

BELIEVING that automobile contests can be encouraged and improved by support of a concrete nature, such as an organized body of automobile manufacturers can supply, the motor car makers have organized what is known as the Manufacturers' Contest Association, the work of which will undoubtedly be of great importance to the pastime and industry, and the plans of which are naturally of considerable interest at this time.

It is agreed that the automobile makers who supply the sinews of war in speed and other contests should have some voice in the rule-making, but not in the enforcement of rules. There can be no argument as the maker's knowledge of what rules would be best to bring out the merits or demerits of cars for the final edification of the general public, but, on the other hand, there can be no argument but that the actual government of contests, and the enforcement of the rules generally, should be in the hands of men without trade affiliations of any sort. Undoubtedly in the suggestions which the makers may offer for rules there will be many that, for some reason or other, are not acceptable to the national governing body, and in many cases the final interpretation of rules as made by the governing body of racing may not meet with approval of all makers. It is the difference of opinion which makes contests interesting.

In accordance with the agreement which the American Automobile Association and the Automobile Club of America have, the Manufacturers' Contest Association recognizes the A. A. A. as the national governing body and the A. C. A. in all events of an international character. There is no desire on the part of the M. C. A. to act other than in an advisory capacity, which it will do, always having in mind the best interests of the industry.

There is no denying the fact that there was much to be criticized in the manner of conducting automobile racing in the past. It was said by some of those interested in the sport, however, that the support of all the manufacturers was needed to better conditions, and this is now made possible by the new organization, which enters the field without a thought of what has taken place in the past, but considering only the present and the future.

That the new association can bring about many desirable improvements admits of no argument. It will work for uniform rules, better classifications for racing cars, uniform fees and sanctions, and generally encourage automobile clubs and trade associations to promote contests. It will not hesitate to make recommendations whenever it deems that such recommendations are in order, and in every other way it will work to advance the best interests of motoring, from a competitive and from a business point of view.

At the same time it must always be remembered that the M. C. A. can encourage only those contests that are promoted with due respect for the State laws and the rights of others on the highways. To do otherwise would bring it into disrepute with the lawmakers of the various States and would eventually bring on the heads of motorists generally unfair laws that would make their pastime anything but pleasant. The manufacturers from time to time are represented and have to appear themselves before the various legislative bodies and to do other than consider carefully all phases of open competition on the road would weaken their position in legislative work, which it is agreed, is of more importance than any other department of motoring.

MOSLER'S PURCHASE OF SPARK PLUG PATENTS

MUCH interest has been aroused in the automobile world by the announcement of the sale of the basic spark plug patents by the Association Patents Company, the patent-holding end of the Association of Licensed Automobile Manufacturers, to A. R. Mosler & Company, of New York City. The two patents in question are known as the Canfield and Mueller, and are numbered 612,701 and 582,540, respectively, in the Patent Office. In notifying the trade and public of their purchase of these patents, A. R. Mosler & Company set forth their reasons for acquiring them as follows:

For several years these patents have been the cause of considerable anxiety on our part, because we believe that if any suit had been brought against us upon them and particularly the Canfield patents, we would have been unable to successfully defend such a suit.

The prior art bearing upon these patents was carefully investigated and considered by our counsel and we were advised by him that it was highly advisable for us to acquire these patents and particularly the Canfield patent, which, in the opinion of our counsel, is not anticipated by anything in the prior art and is undoubtedly valid and quite broad in scope.

All manufacturers of spark plugs in this country recognize the value and importance of manufacturing spark plugs each provided with a deep chamber or recess around the electrode for the purpose of preventing an injurious accumulation of soot or other foul matter on the insulation of the electrode. Indeed, all of the well-known spark plugs now upon the market in this country are each constructed with a deep chamber or recess around the electrode and consequently are within the claims of the Canfield patent. This Canfield patent contains two claims which are as follows:

- (1.) In a gas, oil or vapor engine igniter or spark or a recess or counterbore around the electrode or electrodes and above its or their sparking-points when said electrodes are used vertically, for the purpose of preventing an injurious accumulation of the products of combustion or other foul matter on the insulation of said electrodes, substantially as and for the purpose set forth.
- (2.) In a gas, oil or vapor engine igniter or spark or a recess or counterbore of such size and depth as to prevent the explosive mixture used in the cylinder from circulating into said counterbore or recess far enough to come in contact with its deepest part

around the electrode or electrodes at or near the point where said electrode or electrodes leave the insulator to enter the cylinder or firing-chamber, for the purpose of preventing an injurious accumulation of the products of combustion or other foul matter on the insulation of said electrodes, substantially as and for the purpose set forth.

The following mentioned members of Association of Licensed Automobile Manufacturers have been licensed under these patents: Apperson Bros. Automobile Company, Kokomo, Ind.; Autocar Company, Ardmore, Pa.; Chalmers-Detroit Motor Company, Detroit, Mich.; Cadillac Motor Car Company, Detroit, Mich.; Corbin Motor Vehicle Corporation, New Britain, Conn.; Everitt-Metzger-Flanders Company, Detroit, Mich.; Electric Vehicle Company, Hartford, Conn.; Elmore Manufacturing Company, Clyde, Ohio; H. H. Franklin Manufacturing Company, Syracuse, N. Y.; Hewitt Motor Company, New York City, N. Y.; Knox Automobile Company, Springfield, Mass.; Locomobile Company of America, Bridgeport, Conn.; Lozier Motor Company, New York City, N. Y.; Matheson Motor Car Company, Wilkes-Barre, Pa.; Packard Motor Car Company, Detroit, Mich.; Peerless Motor Car Company, Cleveland, Ohio; Pierce-Arrow Motor Car Company, Buffalo, N. Y.; Pope Manufacturing Company, Hartford, Conn.; Royal Tourist Car Company, Cleveland, Ohio; Alden Sampson 2d, Pittsfield, Mass.; Selden Motor Vehicle Company, Rochester, N. Y.; F. B. Stearns Company, Cleveland, Ohio; Stevens-Duryea Company, Chicopee Falls, Mass.; E. R. Thomas Motor Company, Buffalo, N. Y.; Toledo Motor Company, Toledo, Ohio; Winton Motor Carriage Company, Cleveland, Ohio.

"F. A. L." REPLACES "CAR WITHOUT A NAME."

CHICAGO, April 12.—Announced as "the car without a name," the four-cylinder touring car which has made its debut in this city during the past week will hereafter be called the "F. A. L." The initials are those of the three men who are most interested in its production and sale: T. S. Fauntleroy, president; H. R. Averill, general sales manager, and E. H. Lowe, general manager and secretary. Mr. Averill, who has resigned as sales manager of the York Motor Car Company, has stated that the new cars will be entered in all contests in its class, including the light car race near here, the Savannah light car race, the Quaker City Motor Club Founders' Week race, and all endurance contests. It will be seen in the Glidden tour, the Motor Club of Harrisburg run and other events of importance.

Carlton) the façade of the Travelers' is based upon the design of the Pandolfini Palace in Florence and that of the Carlton upon the Library at Venice. The Royal Automobile Club, which will adjoin the Carlton, follows the precedent, more or less adopted by the other clubs, and owes its inspiration to the former Hotel Crillon-Coislin—now the Automobile Club—in the Place de la Concorde, Paris. It would be difficult to find a more beautifully studied example of modern architecture than the fine fronts by Gabriel facing the Place de la Concorde—there are two buildings, exactly alike, the former Hotel Crillon-Coislin and the Minister de la Marine—second only to Perrault's Colonnade of the Louvre—if indeed to that—this is among the finest columnar façades in the world. It is extremely improbable that any classic design to equal this will be built in England during the lifetime of any one now living, so that any architect who would emulate Gabriel must needs do so in much the same spirit that he might attempt to emulate the Parthenon or the Sainte-Chapelle—to attain as near as the conditions permit the same character of refinement, simplicity and strength.

This character is expressed to an unusual degree in the design for the new Royal Automobile Club. It is large in scale, an essential to monumental effect; the proportions of the *travée* are nearly the same in elevation as those of the buildings by Gabriel, but the effect will be quite different in perspective, due to the column being engaged instead of part of a free screen. Again, in elevation, the central feature of the new building is similar to the end pavilions of the old, but the effect here will also be different—in the French example the corner columns under the pediments are engaged to the pylons and the two middle ones though free are only a half diameter from the pilaster behind. In the building to be erected in Pall Mall the corner columns will be a half diameter in front of a pilaster on the corner of the pylon against

which the portico returns, while the middle ones are in screen, due to the wall face being recessed below the pediment to form a loggia. This latter effect is usually a weak one, giving, as a rule, the impression of two buildings joined together, but the present treatment—the latest studies show the pylons at the ends and those at either side of the pediment brought to the same face—slightly in front of the bases of the columns—and the balcony over the entrance door only, thus doing away with the console below the corner columns and placing the balustrade at either side of the balcony between the pedestals to columns instead of in front of them—a distinct improvement upon the elevation sent herewith. The mass of masonry forming an attic behind the pediment now projects beyond the face of the pylons. This arrangement produces the effect, in the model, of a strong frame of masonry round the void in the center and appears to effectually unify the whole front. It will be interesting to see how this will work out in execution. Internally the building is treated in the "grand manner." There is an uninterrupted vista from the Pall Mall entrance through to Carlton House Terrace. The elliptical vestibule is 48 feet by 32 feet and runs through two stories and is 50 feet high to the ceiling over the central portion. The dining room at the east end and the club room at the west are each 93 feet by 35 feet, and the "Lounge," which on occasions may be used as a lecture room, 108 by 40 feet, including the platform, and 35 feet high. The basement contains a gymnasium and extensive baths, which are accommodated in rooms which are 28 feet high. Included in the baths is a swimming pool 30 by 75 feet.

The Royal Automobile Club will be the first important club building built in London for several years, as a monumental structure of the kind, the only one for many years more. As architecture it bids fair to rank high among the best work of this century in England.

THE new lighting law in France, like most new laws promulgated by a paternal government, in France and elsewhere, which are supposed to be justly applicable to the automobile, is full of anomalies. Of course, this is not to be wondered at. Solons and law-makers have not yet learned enough about the automobile—unless they be automobilists themselves—to be able to put the new locomotion in its proper place.

The new law refers simply to the number plaque on the rear of the automobile; that it must be permanently riveted to the chassis or it must be painted on a fixed portion of the body work, and must be so effectually lighted at night so as to be as visible as in the day time. This of itself is probably impossible, for no matter how brilliantly it may be lighted a moving surface will not be as readily read, as to the inscription it bears, at night as it will be with the light of day. This is undeniable, evident fact.

And the red light which was formerly demanded? Nothing is said about that in the new law, so presumably it is no longer obligatory, and, of course, the authorities will not be able to summon anyone for the omission of it in the future. Not that this matters much; far from it, for the old lamps, all had a red prism showing rearward. The new ones, those of Bleriot, Duceclier and others, who are reaping a harvest off the sale of this new automobile accessory in France, have no provision for this red light whatever, contenting themselves with giving as an effective illumination of the rear number plate as possible. Sometimes this is accomplished by reflection, and sometimes by a diffused light showing through ground glass, the latter a very neat method and legible enough when an automobile is standing still or moving slowly. At *vitesse*, even at the regulation six, eight or ten kilometers an hour, it will be another story.



The law says further that all automobiles on the road at night must carry this lighted rear plate; but another law still in force, and which has been in force for ten or a dozen years and has never been rescinded, distinctly states that at a less speed than 30 kilometers per hour—that is, an automobile not capable of making more

than 30 kilometers an hour—the number plate may be dispensed with altogether. Therefore, logically, one is not obliged to illuminate a number plate which does not exist. What will actually happen in practice will be seen later. French law deems a suspect guilty until he is proven innocent, and by the same line of reasoning the authorities may be expected to work one an injury—if they feel like it—and beg his pardon afterward, if they express any regret at all. But what about the *dommage interet*, a bogey that lives in France to-day like the faith that all men are equal in the modern republic?

And what does all this prove: simply that automobile laws are the most foolish laws ever enacted as they exist to-day. The red flag law in Britain, whereby every "road locomotive" was obliged to be preceded by a man on foot carrying a red flag, was no more ridiculous than a lighting law which provides for the lighting of a plaque which does not exist.

Passengers to the number of 26 were carried 150 miles by Count Zeppelin recently, in his great dirigible balloon, and served to show, perhaps, better than any feat yet accomplished, the practicability of such a machine. Ten aeronauts and fifteen soldiers were in the party, in addition to the inventor, and were in the air for about four hours, leaving the quarters at Lake Constance and flying for a greater distance than has ever before been covered with such a weight.

What the Clubs are Doing These Days

BOSTON MOTOR CLUB NOW OFFICERED.

BOSTON, April 12.—The Boston Motor Club has completed its organization by the election of the following officers: President, Horace G. Kemp; vice-president, E. A. Gilmore; secretary, Alonzo D. Peck; treasurer, W. K. Farrington; directors, A. P. Teele, J. B. Sullivan, Jr., Arthur E. Adams, H. H. Love, A. B. Henley and R. R. Ross; membership committee, John L. Snow, W. A. Shafer, George Priest, V. A. Charles and K. A. Skinner.

President Kemp is a well-known local amateur autoist who has long taken much interest in club affairs. Vice-president Gilmore is a member of the Whitten-Gilmore company, the Thomas and Chalmers agents, and Secretary Peck is the veteran Boston bicycle dealer and race official. Treasurer Farrington is an amateur autoist. Of the directors, Messrs. Teele and Sullivan are Boston attorneys, Arthur E. Adams is manager of the Algonquin Motor Car Company, agent for the Oldsmobile; H. H. Love is a member of a financial concern, A. B. Henley is manager of the Franklin branch, and R. R. Ross is connected with the Peerless branch. John L. Snow, of the membership committee, is manager of the Peerless branch, W. A. Shafer is the head of the Crown Motor Car Company, agent for the Pullman and Glide, V. A. Charles is the manager of the Inter-State agency, and Kenneth A. Skinner is a former president of the dealers' association.

CROSBY TO BE HEAD OF BIG JERSEY CLUB.

NEWARK, N. J., April 12.—This year a nomination is equivalent to an election in the official list of the New Jersey Automobile and Motor Club. This means that W. Clive Crosby, at present president of the Associated Automobile Clubs of New Jersey, will also become the head of its largest club, as he has been placed in nomination by that organization's trustees. The other nominations are: Vice-president, Clarence Bissell; treasurer, G. H. Simonds; secretary, A. B. LeMassena. The present incumbent of the presidency, Paul E. Heller, declined a re-election, and Dr. J. R. English likewise refused a continuation in the treasurership.

In the board of trustees Mr. Heller, J. L. Adams, Jr., and H. D. Bowman have been named to succeed Joseph H. Wood, W. F. Kimber and A. G. Scherer. The holdover trustees are H. A. Bonnell, Dr. Frank Meeker, F. A. Croselmire and W. C. Shanley.

BRIDGEPORT CLUB HOLDS ANNUAL ELECTION.

BRIDGEPORT, CONN., April 12.—At the annual meeting of the Automobile Club of Bridgeport, attended by nearly 250 resident and non-resident members, Frank T. Staples was unanimously re-elected president of the organization. The other officers chosen were: Ralph M. Sperry, vice-president; F. W. Bolande, secretary; L. B. Powe, treasurer; board of governors, H. H. DeLoss, M. V. Doud, Dr. H. S. Miles, E. W. Fairchild, A. H. Canfield and B. H. Edwards. The nominating committee was composed of H. E. French, Frank Miller and David F. Read.

MARYLAND COURTESY FOR HARRISBURG RUN.

BALTIMORE, MD., April 12.—The Automobile Club of Maryland, through Secretary Darling, has requested Secretary of State N. Winslow Williams to have the State waive its legal right to require Maryland licenses for those who will participate in the endurance run of the Automobile Club of Harrisburg. Mr. Williams has submitted the club's request to Governor Crothers.

SYRACUSE CLUB CAMPAIGNING FOR MEMBERS.

SYRACUSE, N. Y., April 12.—There are now 230 members in the Automobile Club of Syracuse, and there are 250 owners who are not members, and a vigorous campaign has been instituted to secure at least 150 additional members. If this can be done, the activity of the local organization will be greatly increased, a permanent secretary engaged, headquarters established and monthly bulletins issued.

The club is at the present time actively engaged in considering the bills now before the State Legislature.

Through the courtesy of Congressman M. E. Driscoll the Syracuse club has received the latest topographical maps of the State. These will be mounted, and hung in the secretary's office.

PHOTOS WERE OF NORRISTOWN PATHFINDERS.

NORRISTOWN, PA., April 12.—The photographs used in the April 8 issue of THE AUTOMOBILE, in connection with the endurance run of the Motor Club of Harrisburg, were taken by the pathfinders of the second annual endurance run of the Norristown Automobile Club. This contest will be held May 18 and 19, between this place and Hagerstown, Md. The pathfinding party consisted of five cars, sent over the route at considerable expense to the club, and the photographs show the splendid roads which will be covered. The cars making the preliminary trip were a six-cylinder Oldsmobile, driven by T. W. Berger; White steamer, Matheson, Crawford and American Traveler.

DROUGHT AS MILWAUKEE CLUB'S COUNSEL.

MILWAUKEE, WIS., April 12.—The Milwaukee Automobile Club has accepted the resignation of James T. Drought, secretary and treasurer since its organization in 1903, as Mr. Drought could not be induced to remain. Arthur C. Brenckle, one of the leading cigar manufacturers of Milwaukee, has been unanimously elected secretary, and a treasurer will be chosen at the next meeting, it having been decided to separate these offices. Mr. Drought has consented to act as legal counsel, in which capacity he has been valuable. Mr. Brenckle is a charter member of the club, and has taken a deep interest in all of its affairs.

PHILADELPHIA CLUB INCREASES MEMBERSHIP.

PHILADELPHIA, April 12.—At the April meeting of the recently elected board of governors of the Automobile Club of Philadelphia last week no less than 63 applications for membership were favorably acted upon. Chairman R. O. Griffith, of the maps, routes and signs committee, reported that as soon as the full text of the new automobile laws of Pennsylvania, New Jersey and Maryland could be secured and put in type the new road book will be printed and issued to the members. Powell Evans was re-elected president of the board; Stedman Bent as vice-president, and S. Boyer Davis as secretary and treasurer.

OHIO ASSOCIATION ELECTS OFFICERS.

CINCINNATI, April 12.—Harry L. Vail was elected president of the Ohio Automobile Association at its annual meeting. C. J. Forbes, Jr., was re-elected secretary. The directors are: From Cleveland, F. T. Sholes, Harry L. Vail, W. H. Wherry, F. J. Baer, Chas. Weaver, C. H. Hoskins, C. J. Forbes, Jr., J. B. Ayers, W. M. Hager, W. F. Bonnell, B. P. Foster; from Elyria, A. L. Garford; from Youngstown, C. H. Yahrling; from Kenton, James H. Allen; from Akron, Andrew Auble. Secretary Forbes' report showed an increase in membership from 1,180 to 1,604.



A Leading Garage in the Heart of Portland, Me.

The photograph shows the headquarters of the Harmon Automobile Company, 26-30 Forest Avenue, Portland, Maine, which is admirably located as a stopping place for tourists on the route to the Maine summer resorts.

Milwaukee.—Since the fire which destroyed the Sanger garage, the members of the Common Council are proposing all sorts of radical regulations. This subject and the ultimate outcome are of great interest, because the garage is a necessity here, particularly in the fashionable districts. That condition was brought about by the desire of owners to keep their cars in a public rather than a private garage. One result of this has been to produce a lot of very high-class garages, most of which are architectural models. The outcome of the discussion will be awaited with much anxiety by the owners of these expensive places.

San Francisco.—The latest step in the automobile invasion of Van Ness avenue is the announcement of the erection of the Stearns Building, on the corner of Fulton street. This will be a very large building and one that will add materially to the neighborhood. Construction has been started, and possession is expected within sixty days. The Reliance Automobile Company, the local Stearns agents, will move the salesrooms and offices, but the shops and garage will remain at the present location, this segregation being one of the features of the new building.

Chicago.—The new garage proposed by the Chicago Motor Cab Company, to be erected near Huron and St. Clair streets, has been strongly opposed by residents of the fashionable district. Protests have been filed by Joseph Leiter for the Potter Palmer estate, John L. Whitman, John T. Mountain, H. F. Talbot and R. F. Keith. Certain legal points are being considered by city counsel.

Joliet, Ill.—One of the best equipped garages in the State has been opened by George B. Peterson, on Clinton street. It includes a show room, office space, rest and smoking rooms, retiring rooms for ladies, and a machine shop fitted with electrical power and operated by skilled mechanics. The garage has large washstands and space for cleaning and storage.

Des Moines, Ia.—Contingent upon street improvements, the Bernhard-Turner Automobile Company, will erect a large building for garage purposes on Seventh street, just north of Grand avenue. It will be two stories in height, with a front of glass, and completely equipped in every way; garage, washstands, etc., and the property has been secured.

New York City.—John D. Rockefeller has had plans filed for making over the annex to the Metropolitan Riding Academy, at 125 West 55th street, into a garage. The wooden fittings will be torn out, and the building reconstructed in fireproof style, with steel ceilings, terra cotta walls and partitions and cement flooring. A turntable will be installed.

Garage Washstand on the Roof.—To utilize otherwise wasted space, a garage in Sydney, Australia, has arranged its building so that its cars are taken to the roof for washing and general cleaning, and then taken down into the building for storage. The roof is made of reinforced Malthoid and so can be used for this without any danger of leaks or of it wearing out.

Huntington, W. Va.—The Hanley & Kincaid Automobile Company will occupy the new Miller garage, on Court street, between Ninth and Tenth streets, which is one of the largest in West Virginia. The garage section of the building has been completed and the company will take possession at once.

Port Jefferson, N. Y.—The Fred Griswold Garage Motor Company has bought the lumber yard property of John T. Mather, and will erect a garage and dredge the mill creek so that motor boats can get to the shop. Benjamin West, of Bayport, is to be an active member of the company.

Pittsburg, Pa.—B. F. Benson is erecting a garage on North Craig street, near Luna Park, for Studebaker cars. The Hamilton Automobile Company, agent for the KisselKar and the Middleby, has broken ground for a new home at Hamilton and Dallas Avenues.

Louisville, Ky.—The Olds Motor Works has purchased, for \$25,000, property on Fourth avenue, near York street, on which to build the largest garage in the South. It will be of brick construction, and used both as a selling headquarters and garage.

Cumberland, Md.—The Queen City Garage Company, recently incorporated, will continue the garage and repair business which has been established for some time. J. H. Johnson, B. H. Biays and L. Reed are interested.

Charlotte, N. C.—Osmond L. Barringer has made plans for building a one-story garage, 50 by 180 feet, with a showroom and office in the front, and in the rear an electrically driven machine shop; cost, about \$10,000.

Indianapolis, Ind.—Work was started recently on the two-story building for the Gibson Automobile Company, at 235 N. Pennsylvania street. This building, 37 by 125 feet in size, will be used as a showroom.

Springfield, Mass.—Work has been commenced upon a new garage for the Hampden Automobile Company at 60 Taylor street. It is 50 feet wide and 115 long and will be completed in sixty days.

Atlanta, Ga.—Edwin P. Ansley, 71 N. Forsythe street, is having plans prepared for a ten-story reinforced concrete building for storing, repairing and displaying automobiles.

Toronto, Ont.—The Canadian Cycle and Motor Company intends erecting a three-story building for its Toronto headquarters at Richmond and Bay streets.

Hobart, Okla.—C. F. Newcomer, of the Hobart Motor Car Company, has completed arrangements to erect a new garage on Washington avenue.



Garage of the St. Paul (Minn.) Motor Vehicle Company.

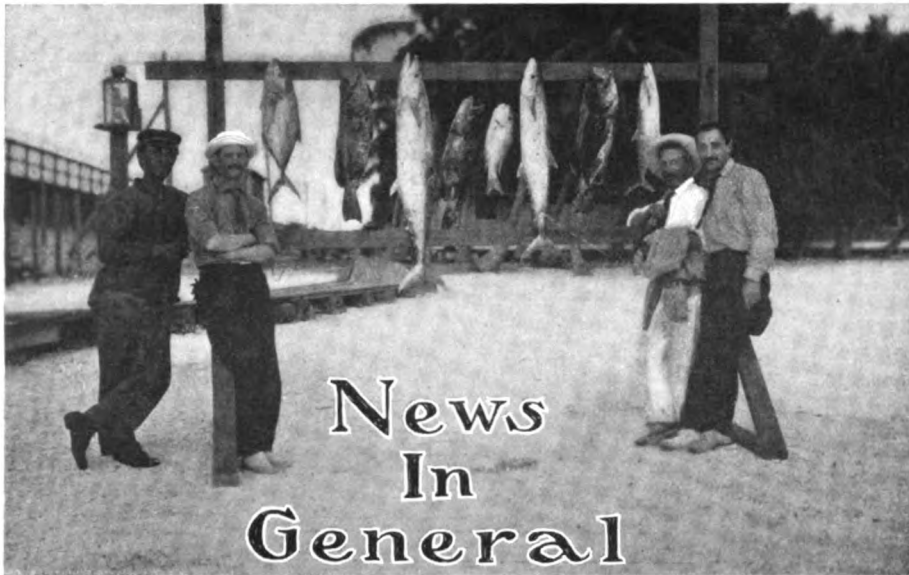

Three Famous Fishermen and One Able-Bodied Seaman.

Showing the result of a day's sport at Knight's Key, Florida, participated in by three prominent New Yorkers: General Manager Alfred Reeves, of the American Motor Car Manufacturers' Association; John C. Wetmore, of the "Evening Mail," and Nathan Lazarnick, the well-known photographer. The able seaman stands complacently at the extreme left, apparently well satisfied with a good day's work.

Lozier Company's Team for Races.—Harry Michener and Ralph Mulford, who have driven the Lozier cars in the principal events in which these have competed in the last three years, will continue to drive in the events in which the Lozier cars are featured during the coming season. Harry Cobe, who twice assisted in breaking the world's 24-hour record with a six-cylinder Lozier last year, will also be a member of the Lozier team. Michener is now on the Pacific coast, and will take part in some of the western events during the next six weeks; after which he will return east, either for the 24-hour race at Philadelphia or the Cobe stock car race at Chicago. Mulford will be seen in races for the last time this year, and will take no part in racing events after the Founders' Week race in Fairmont Park next October. Harry Cobe will probably take Milford's place as a regular driver on the Lozier cars after this season.

Many Visitors See Pierce Factory.—Approximately 1,500 people have been shown through the new factory of the Pierce-Arrow Motor Car Co., Buffalo, in the past twelve months, according to officials who have been able to judge the numbers fairly accurately, and hereafter an actual count will be made by those in charge of the reception room. The plant has become one of the show places of the city, and for that reason the visitors have not been confined wholly to the class that buys cars. Among the visitors have been between 60 and 75 men from other automobile factories, and several from large European concerns, all looking for ideas on how to better their own establishments. The Pierce is one of the largest and most modern in its construction among automobile factories, and a cordial welcome is always given to visitors, no matter what their purpose may be.

Tropical Trade in Waverley Electrics.—The island neighbors and dependencies of the United States are proving excellent customers for American-made automobiles. A short time ago a Waverley electric was sold to a sugar

planter of San Domingo. Last week an order was received from Honolulu for a model 67 Waverley victoria phaeton. This is an especially popular model for southern climates and the appearance of a new electric carriage of this type in tropical Hawaii can hardly fail to attract attention among other possible purchasers. A letter recently received by the Waverley Company from Manila, P. I., refers to the active competition in that faraway city between automobiles of French, Spanish and American manufacture, and expresses an urgent desire to see a greater number of American cars represented in that city.

Chicago Society Woman Drives Baker Electrics.—Mrs. Guy R. Pierce, a society woman of Chicago, is an enthusiast on electric automobiling, and recently said: "I do not see why ladies should doubt that an electric automobile can be operated easily. Any woman can drive an electric at her own pleasure, without danger of soiling gowns, gloves, or temper." Mrs. Pierce has purchased one of the new Baker electric coupes, and has been asked by many of her friends to show them how to run the car. She also owns one of the Baker electric runabouts, a car which has the general outlines of a gasoline car, but which is really an electric with a mileage radius of 100 miles at an approximately high speed.

A Million Dollar Challenge.—With evident courage of its convictions, the Diamond Rubber Company is taking the position that the automobile owner should have first-hand knowledge of tires. In a rather striking advertisement printed this week, a "Million Dollar Challenge" is issued to car owners to acquire such knowledge, and users of Diamond tires, as well, are urged to check up their respective experiences. The Diamond Company is very much in earnest, and the advertisement referred to is well calculated to attract a great deal more than passing notice.

Winton Output of Large Cars Sold.—Notice has been issued by sales manager Churchill that the entire output of 60-

horsepower Winton sixes has been sold. Mr. Churchill says, "We do not count a car sold until we have the money for it. If we were to follow the general practice of regarding agents' blanket orders as sales, our entire output of both 48 and 60-horsepower cars would have been gone long ago. Sales have been particularly active all winter, and at the present rate we shall have no more 48-horsepower cars to sell within three weeks."

Bosch Offers Prizes to Racers.—The Bosch Magneto Company has announced that it will give cash prizes to the drivers of the first three cars in the Coupe des Voiturettes, the light car race, in France this year. The driver of the first car will get \$600, that of the second \$200, and the third \$100. The only condition is that each car shall be equipped with the Bosch magneto. As to other prize awards on occasions of this season's events of major importance, announcement will be made later.

Record Sale of Glide Cars in Peoria.—The old adage that "a prophet is not honored in his own country" has not held in the county of Peoria, Ill., according to G. G. Luthy, secretary of the Bartholomew Company, manufacturer of the Glide automobiles. This concern has sold 18 of its 1909 cars to buyers in the city of Peoria, in which the factory is located, and six to those in the same county, outside of the city, making 24 sales in Peoria county.

Rapid in New Factory.—The Rapid Motor Vehicle Company, of Pontiac, Mich., has moved into its new factory, which now gives it four acres of floor space. H. G. Hamilton, the general manager, reports that 80 per cent. more business is on the books of the concern than in the busiest season of last year.

Baltimore to San Francisco Tour.—Harry C. Weiller and family, of Baltimore, Md., are arranging to make a trip across the continent to San Francisco, in their 50-horsepower Welch car. Many side trips will be taken, and it is expected that about 10,000 miles will be covered.

IN AND ABOUT THE AGENCIES.

Remy, Detroit.—The Remy Electric Company, of Anderson, Ind., manufacturer of high tension magnetos for automobile, marine and stationary gasoline engines, has opened a branch selling office at 471 Woodward avenue, Detroit, Mich. The new distributing center will be under the management of C. E. Brelsford, formerly manager of the Detroit branch of the Witherbee Igniter Company and the Stewart & Clark Mfg. Company. Mr. Brelsford will be assisted by A. J. Roth and Dell Stines, both of whom are experts on automobiles and accessories.

Stearns, Philadelphia.—G. Hilton Gantert, formerly of The Motor Shop, has been awarded the Philadelphia agency for the Stearns car, and has opened up handsomely appointed salesrooms at 510-512 North Broad street. As the Motor Shop handled the Stearns in the Quaker City up to within a few months ago, Mr. Gantert is peculiarly well qualified to advance the interests of that car in Philadelphia.

Kissel Motor Car Company of New York.—In changing its location, the name of the metropolitan distributor of the KisselKar also was changed from the Apthorp Motor Car Company to Kissel Motor Car Company of New

York. Its new headquarters are at 1875-77 Broadway, and Fred S. Dickinson, the manager, has made arrangements for additional lines of cars from the Wisconsin factory.

E-M-F, Tampa, Fla.—The Tampa Harness & Wagon Company are the agents for the E-M-F in this city. The company's territory embraces several counties in southern Florida.

PERSONAL TRADE MENTION.

H. S. Firestone, president of the Firestone Tire & Rubber Company, has returned to his home in Akron, O., delighted with Cuba as a perfect spot for automobile touring. He says that the roads are being continually improved by the government with coral stone, which is proving to be the finest material imaginable. It works down into an asphalt-like surface that requires little repair and remains perfectly smooth. Mr. and Mrs. Firestone toured in company with James Couzens, of the Ford Motor Company.

Frank B. Hower, chairman of the A. A. Contest Board, in a friendly chat recently, said: "I think I will not care to run another Glidden tour after this year. I am glad to have this one to manage, in order to apply the experience I gained in the last two contests. The manufacturers this year will get the best run for their money they ever have had. I am making certain of this, but in another year I hope there will be some one else to bear the burden of the work and worry."

F. C. Gilbert has resigned as general sales manager of the Toledo Motor Company, the successors to the Pope Motor Car Company, of Toledo. Mr. Gilbert has been with this company, and its predecessors for fourteen years, and during the period of the receivership marketed for the receivers over a million dollars' worth of goods, holding the sales record for the allied companies. He expects to take a short vacation and will then take up active work again.

J. L. Davidson, superintendent of the former Rainier automobile factory at Saginaw, Mich., has severed his connections with that plant, now the Marquette, and taken a position as superintendent of the American Motor Company of Indianapolis. The seven foremen who were under him in official capacity, as an expression of their goodwill, presented him with a valuable ring. Mr. Davidson is succeeded by W. R. Willett, at the Marquette works.

Milton Lusk, who has entertained so many automobilists on Glidden tours and at shows by his music on Gabriel horns, will shortly join the sales forces of the Pittsburg branch of the Olds Motor Works. With C. H. Foster, of the Gabriel Horn Company, it is probable that Mr. Lusk will be at the keys of a horn in the A. A. tour this summer.

E. Percy Noel, advertising the Moon Motor Car Company, is the author of the words of a new popular song, "Tell Me Your Love in Wireless," brought out by the Noebur Publishing Company, St. Louis. W. P. Burnet, a well-known composer, wrote the music.

Russell Dale formerly sales manager of the Celfor Tool Company, has been appointed the Chicago representative of the Carpenter Steel Company, of Reading, Pa. Mr. Dale will have his headquarters in the Commercial National Bank building.

T. P. Myers, sales manager for the Rapid Motor Vehicle Company, Pontiac, Mich., has just returned from a month's trip through the Western States, where he recently appointed several new agents for his company.

L. H. Kittredge, president of the Peerless Motor Car Company, has been made a member of the executive committee of the Cleveland Industrial Exposition, which will be held in Cleveland from June 7 to 19.

J. J. Evans, who marketed the first American Mercedes automobile, has taken charge of the output of Frontenac cars, made by the Abendroth & Root Company, Newburgh, N. Y.

F. A. Stock, for some time associated with the Franklin line in Cleveland, has been appointed manager of the Jewell Motor Car Company, of that city.

Thomas Henderson, vice-president of the Winton Company, leaves Cleveland this week for a Pacific coast tour.

TAXICABS AND TRANSIT.

Greenfield, Mass.—A company has been organized in Greenfield to operate a line of automobiles to Turners Falls and Northfield. One car to seat twelve has been purchased and will be run to the former place on an hourly schedule, each trip consuming about 15 minutes, commencing May 1. The car for the Northfield line will seat 16 to 20, and will make three round trips daily, one in the morning and two in the afternoon, beginning with the summer season.

Marquette, Mich.—The Marquette County Traction Company has been organized to run an automobile service between Marquette, Ishpeming, and Negaunee. Four large passenger cars are to be put into the service, and will make regular trips between the three cities every day.

Philadelphia.—The Whitmarsh Valley Country Club has purchased a 40-horsepower White steamer opera bus, which it will use in running between the clubhouse and railroad and trolley stations at Chestnut Hill.

RECENT BUSINESS CHANGES.

Gilbert Manufacturing Company Separates Lines.—The Gilbert Manufacturing Company, New Haven, Conn., makers of the Gilbert tire cases and other automobile accessories, has separated its business in this trade from that of making corsets. In doing this a new concern has been incorporated under the old name, and the Gilbert Corset Company was formed to carry on the original line. F. E. Bowers has bought a controlling interest in the new firm and will continue in the active management as in the past.

C. S. Houghton, Baltimore.—New salesrooms and a repair shop have been opened by C. S. Houghton, the local agent for the Overland cars, at 6 East Read street. Mr. Houghton formerly had his headquarters in the Calvert building.

TO DOUBLE CHALMERS PLANT.

Detroit, Mich., April 12.—It was announced to-day that the Chalmers-Detroit Motor Company has decided to double the capacity of its plant. A new building, an exact duplicate of the present main building, will be erected in

time for occupancy September 1. This will be 60 feet wide, 400 feet long, and three stories high. The new building, like the present main building, will be of concrete construction throughout.

WOODWORTHS AT NIAGARA.

Niagara Falls, N. Y., April 12.—The Leather Tire Goods Company, Newton Upper Falls, Mass., has just completed a new two-story factory at Niagara Falls, which it will occupy after May 1. The entire manufacturing plant and office will be moved to Niagara Falls the latter part of April, and all correspondence should be addressed here after May 1.

The new factory is located on Whirlpool avenue, near the Whirlpool Rapids. It has over 10,000 feet of floor space, and with the improved machinery which is being installed, will have a capacity of over 300 treads per day. This new location will make it more convenient than heretofore to obtain Woodworth treads, for Niagara Falls is one of the best shipping points in the country.

NEW AGENCIES ESTABLISHED.

Brush, Dutch Neck, N. J.—Hiram Cook & Sons. For the eastern half of Mercer County, including Princeton, Lawrenceville, Hightstown and Pennington.

White Steamer and Jackson, Tampa, Fla.—Florida Gas Engine and Supply Company.

White, Pittsfield, Mass.—Tracy & Robison, 184 North street. For the Berkshires.

Rapid, Pittsburg, Pa.—Keystone Automobile Company.

Chase, Boston.—N. S. H. Sanders.

RECENT INCORPORATIONS.

Duluth Motor Vehicle Company, Duluth, Minn.—Capital, \$50,000. To manufacture, buy, sell, import and export automobiles, motors, engines, machines, etc.; sell gasoline. Do a general garage business, etc. Incorporators: A. G. Fitzgerald, Evelyn S. Fitzgerald, C. W. Fitzgerald.

Crowley Iron and Machinery Company, Ltd., New Orleans.—Capital, \$15,000. To install an automobile garage and do a general repair and machine shop business. President, S. D. Wilder; vice-president, J. P. Burgin; secretary-treasurer, C. E. Warren.

The Anderson Motor Car Company, Anderson, Ind.—Capital, \$10,000. To manufacture motor vehicles. Incorporators: T. Chandler Welbes, Spencer M. Hickman, Edwin G. Worden, U. Grant Hodson, E. Fred Dice.

Nadall-Van Sicken Manufacturing Company, Chicago.—Capital, \$50,000. To manufacture automobile accessories. Incorporators: G. L. Wilkinson, W. A. Scott, C. A. Richmond.

Berger Taxicab Company, Brooklyn.—Capital, \$25,000. To manufacture and rent automobiles, wagon trucks, carriages, etc. Incorporators: H. A. Berger, W. Wing, P. Wilds.

Green Taxicab Company, Brooklyn.—Capital, \$25,000. To purchase, deal in and rent automobiles and motor vehicles. Incorporators: D. T. O'Brien, F. G. Strobel, H. Jacobs.

L. W. Holt Company, Buffalo.—Capital, \$10,000. To sell automobiles, power boats and engines. Incorporators: R. A. Kellogg, Elizabeth A. Nauth, Frances A. Moses.

American Body Company, Buffalo.—Capital, \$10,000. To manufacture automobiles and other vehicles. Incorporators: E. A. Selkirk, E. J. Freitas, J. W. Kelly.

Motor Company of Dover, Del.—Capital, \$100,000. To manufacture automobile and other motors. Incorporators: J. H. Hughes, J. L. Wolcott, Franklin Temple.

Sloane Motor Company, Chicago.—Capital, \$35,000. To do a general manufacturing business. Incorporators: A. W. Baer, William M. Sloane, D. M. Carter.

Beacon Motor Car Company, Boston.—Capital, \$10,000. To do a general automobile business. Incorporators: F. H. Young, L. B. Pinkney.

Oklahoma Taxicab Company, Oklahoma City, Okla.—Capital, \$10,000. Incorporators: Joseph Huckins, Jr., C. R. Riggs, H. R. Connor.

SOME RECENT TRADE PUBLICATIONS

The Rambler Magazine: Thomas B. Jeffery & Co.—This magazine, which does not accept a single line of advertising material, and is mailed free to a multitude of people each month, is the unique publication known as the "Rambler Magazine," published by Thomas B. Jeffery & Company, Kenosha, Wis., makers of the Rambler car, in the interest of 14,000 Rambler owners. The latest issue, now being mailed, is practically of standard magazine size, and in it appears articles descriptive of touring, with pictures especially posed by some of the best photographic artists in the country. The Rambler people offer big prizes to amateur photographers for specimens of their work, and these are reproduced in the issues. This publication was started several years ago for circulation among Rambler car owners. Then owners asked to have it sent to their friends, and these have increased to such an extent that the free circulation has now soared to high figures. Mr. Jeffery, maker of the Rambler, believes that the furnishing of specific information to owners and prospective buyers is of great benefit to the industry in general. Free copies of the latest issue will be sent to any one making the request to the publishers.

The White Company, Cleveland.—The White Company, in its latest publication, the catalogue of the 1909 product, has followed much the same successful lines as heretofore, with perhaps an improvement, for its new book is a pleasure to read, and highly instructive as well. Not only are the various models described, but the parts of the White construction are thoroughly analyzed, and to those users of gasoline cars who do not understand the operation of the successful steamers, this catalogue would be especially valuable. The book is a handsome one, from cover to cover; well bound, well printed, and with cuts which could not be improved. Phases of White desirability are discussed, the newly adopted Joy valve action explained, as well as that of the steam generator system, which is so often misunderstood or misquoted. Excellent photos of the complete cars, chassis, and parts, are given to illustrate the reading matter. Two chassis sizes are built by the White Company this season, one of 20, and the other of 40 horsepower, and the specifications are given in full.

Banker Wind Shield Company, Pittsburg, Pa.—Two types of wind shields are being made by the Banker Wind Shield Company, as shown by the firm's recent catalogue, one a single folding, and the other a double folding type. In both, heavy plate glass is used, and they both have features that make them desirable, such as rubber buffers in the ball and socket joints, and full length hinges, to prevent rattling. The double folding shield is, of course, the one featured, for it can be so folded over the hood of an automobile as to be out of the way, even when the hood is opened. There is no metal strip across the center of the glass to obscure vision, and shelves of metal are used to support the glass. The frame is made of one piece solid stock, set in channelled rubber, and the clamps, telescoping tubes, etc., are made of highly polished brass. The wood is of walnut and mahogany, with piano finish. Accurate measurements for all makes of cars are kept so that mail orders can easily be attended to.

Buckeye Manufacturing Company, Anderson, Ind.—The new catalogue of the Buckeye friction drive cars deals mainly with the friction feature and the engine used. The former embraces two elements, a friction disc and the driving wheel, mounted upon an extension of the crankshaft. The disc is mounted, slidably, upon a jack shaft from which the drive is by enclosed silent chain to the rear axle. Actual service has proved all of the Lambert claims, not only on touring cars of little weight, but upon the heaviest of commercial trucks. Four models are listed, varying in price, carrying capacity, size and type of motor. The extremes are Model A-1, which will carry 2-3 passengers, lists at \$800, and has a 20-horsepower, two-cylinder opposed engine; and Model B-2, with roomy seven-passenger body, four-cylinder vertical motor of 40 horsepower, and priced at \$2,000. Between the two are a number of others all medium priced, but varied in capacity and equipment to suit the various needs.

Northwestern Storage Battery Company, Milwaukee, Wis.—Storage ignition and lighting batteries, electric cabin and enclosed car lights, electric side and rear lights for automobiles and motor boats, battery charging outfits, etc., manufactured by the Northwestern Storage Battery Company, are ably described and illustrated in a catalogue recently published by this concern. Several sizes of ignition batteries are made: 6-volt,

60-ampere; 4-volt, 60-ampere, and 6-volt, 40-ampere. Then there is a motor boat battery of 6 volts, 120 amperes, and a lighting battery which can be made in various sizes, for house, farm or boat lighting, to be used in connection or without, a gasoline engine and dynamo charging outfit. A great variety of lamps is offered, the searchlights being furnished with tungsten globes, and the side and dome lights with the regular carbon lights. Special lights for speedometers, etc., are also made, and all types shown and explained in detail in the catalogue.

Breeze Motor Buggies, Carthage, O.—The Jewell Carriage Company has issued its catalogue describing the several styles of motor buggies built by it, sold under the trade name of Breeze. There are two chassis sizes illustrated, one of 13-14 horsepower, and the other of 17-18; both with double opposed off-set air-cooled engines, single chain drive to a counter-shaft, and double side chain drive to the rear wheels. A two forward speed planetary transmission is used. There are three general styles of bodies mentioned, one with a single seat for two passengers; one a surrey with a capacity of four or five; and a model with a seat for two in front and with a light spring wagon body so that merchandise can be carried at the rear. The wheels are 37 inches in diameter, and fitted with solid rubber tires. The steering is by wheel, and the engine control levers are on the steering post, underneath the wheel.

Kearns Motor Buggy Company, Beavertown, Pa.—Gearless, clutchless, valveless, are the words used to describe the Kearns, which is a new motor buggy or high-wheeler with a two-cylinder, two-cycle, air-cooled motor and a friction transmission. While these words at first sight seem extravagant, upon closer acquaintance the car is seen to bear out the claims. The two-cycle motor used is the Speedwell, which is well known, and of course has no valves. With a friction transmission no clutch is used, this being one of the advantages of this form of power conveyance. With this form, also, gears are eliminated. As the catalogue aptly puts it, "the Kearns cars are noted for the mechanical features they lack; they have no speed change gearing, no differential, radiator, water tank, pump or water jackets, no clutch, valves, gears, cams or springs, and no punctures."

The K-W Ignition Company, Cleveland.—In a little booklet which combines the features of a catalogue and an instruction book, the K-W Ignition Company, of Cleveland, is setting forth the particulars of its 1909 products of magnetos, coils and spark plugs. Five different styles of magnetos are made; one for belt spark only with a friction drive; one for belt drive, especially for machines like the Ford runabouts; one for motor boats, and two which can be used with gears, belts or sprocket and chain drives and either for jump spark or make and break, the same model being used with slightly different arrangement for the different types of ignition. These magnetos can be used for electric lights at the same time that they furnish the ignition current. K-W spark plugs and coils are described in detail, giving the advantages and construction, with advice for the care of them.

Alden Sampson Mfg. Co., Pittsfield, Mass., is distributing Catalogue C, a book descriptive of commercial motor vehicles built by this concern. These include the twenty-ton road train and principally the new four-ton truck chassis. The latter has been so constructed as to be equally suitable for use as an omnibus. The good features noticed on casually glancing through the book are the spring-suspended engine, three-point suspension for the transmission, automatic spark advance, the driver manipulating the throttle only, and the enclosed chain. The chain case is dust-proof and oil tight, being made of sheet metal, is liberally provided with inspection and adjustment covers, while at the same time acting as a radius rod. This will undoubtedly be a large factor in the life and efficiency of the chains, the most important element in the driving mechanism.

The Royal Tourlet Car Company, Cleveland.—The announcement of the Royal Tourist for the 1909 season was looked forward to with a great deal of expectancy before the shows, and the catalogue, which appeared simultaneously with the touring cars, is in keeping with them. Bound in light blue with an attractive cover drawing, and having in its center two of the prettiest photos of cars yet seen in the season's booklets, both being views of the new touring cars, make it especially attractive. A front view is also shown, as well as those of the engine, transmission, and other parts. The construction of the car is explained in de-

tail, and the general matter in the catalogue conveys a splendid impression of the newest product of the Royal Company.

American Napier Company, Jamaica Plain, Mass.—The American Napier Company, in its catalogue of the 1909 product, announces that three types will be manufactured: The 60-horsepower, six-cylinder car; the 40-horsepower, four-cylinder car, and the 20-horsepower, four-cylinder "Nike" type runabout. The full description of these models is given in the new publication, calling attention to the construction of the frame, brakes, steering joints, clutch, engine, gears, and other points worthy of note. Ease of control and ignition is emphasized, as well as the lubrication features. In tabulated form, the specifications are so given as to allow of an easy comparison between the various models, or for reference.

Buggycar Company, Cincinnati.—In presenting the 1909 catalogue of "Buggycars," this company reveals an unusual machine. This is a high-wheeler with a horizontal opposed, air-cooled motor of 12-horsepower located in the center of the car. From the flywheel, the drive is by friction to a side shaft, the latter driving the rear axle through bevel gears. Side leaf springs are used, the frame is of angle iron, 1-1/8 tires, are solid, and the same on both, 42-inch front and 44-inch rear wheels. Tiller steer is employed and a wide range of buggy bodies may be had. As an option, cable drive may be had, if desired, in place of the friction shaft drive.

Motor Car Equipment Company, New York City.—Everything for the autoist but the auto, might well be the title of this 1909 catalogue. The firm is accessory dealers, and the catalogue is a description in detail of the accessories handled, all of which are of a very high grade and well known to the trade. Contrary to the usual catalogue of supply houses this one is printed on very excellent paper and the cover is of an attractive design. This has a border made up of scenes from the Vanderbilt and other races, within which is another border. Inside of this in turn is grouped a lot of accessories, about every imaginable thing in this line being included.

Trojan Motor Company, Louisville, Ky.—This concern is issuing a binder with inserted leaves to the number of 7, 8 by 10 in size, descriptive of the Trojan automobile motors. These are of the air-cooled two-cycle two-port type, and range from one to four cylinders. The same size cylinders are used on each, and are 4 1/2 inches in diameter, 8, 16, 24, 32 for the respective one, two three and four-cylinders, in which it agrees exactly with the A. L. A. M. rating, although the latter is intended for four-cycle motors. Two views of the single-cylinder are shown.

Dow Tire Company, New York City.—This is a booklet, 5 by 9 in size, descriptive of the Dow non-deflation inner tubes. These are of great service in the elimination of punctures and the annoyances attendant upon cuts or punctures. Coupled with this, the fact that these tubes do not lose anything in resiliency easily accounts for the present popularity of this accessory. The booklet describes their manufacture, includes many letters of recommendation, and finally a list of prices and sizes in both inches and millimeters.

Ohio Seamless Tube Company, Shelby, O.—This is a history of the growth of the seamless steel tube industry in this country, dating from 1890. The development of the buildings, which is the mark of the progress of the company, is pictured in a series of photos. These show in a graphical way the story which the text tells. The 4 by 8 booklet closes with a description of the process of making steel tubing.

Cortland Forging Company, Cortland, N. Y.—Catalogue D is a real book, 6x9 in size, bound in cloth and illustrates the product of this company, which includes bow sockets, arm rails, top and body irons, as well as shifting rails and top parts or components of carriage or automobile tops. A very complete index is a pleasing departure from the usual run of catalogues.

Hornecker Motor Mfg. Co., Geneseo, Ill.—No. 5 catalogue of the Torpedo Motorcycles, showing the various one and two-cylinder models made by this firm. A considerable portion of the book of 40 pages is devoted to testimonial letters from Torpedo owners all over the country, particularly California, where many hill climbs and races have been won on this make.

Garvin Machine Company, New York City.—Edition D of the illustrated catalogue of machine tools is a standard sized, 6 by 9, well printed book of 96 pages. The text, descriptive of the Garvin one, two and three-spindle profilers, vertical spindle millers, duplex millers, and other tools, is printed in three languages. These are English, French and German.

INFORMATION FOR AUTO USERS

A Compact Pressure Register.—A clever device which is destined to add to the peace of mind of the automobilist is the new Pressuretell valve, shown in the illustration, which not only retains the air pressure within the tire, but at the same time will indicate at a glance the pressure existing. The recent agitation for higher air pressure has developed this article as a pressure indicating medium, and as it was a self-evident necessity, the natural question was—why not incorporate it as a part of the valve itself?

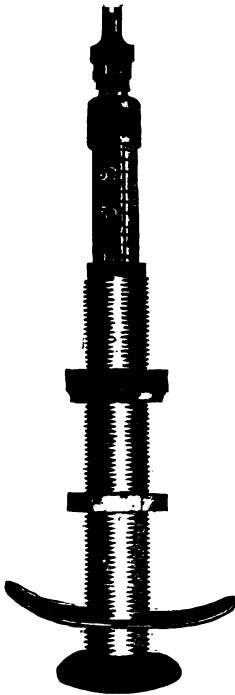

PRESSURETELL VALVE.

The device is arranged inside of the regular and well-known Schrader valve, all of the parts being standard, so that it is interchangeable with any valve now in use. On screwing off the protecting cap, the interior portion of the valve rises, displaying a graduated stem which, read at the top line of the stationary part, gives the pressure. The graduations read from 40 pounds at the top down to 120 pounds, at 5-pound intervals, as the pressure within being greater, the graduated stem will be pushed out farther, so the graduations must read in reverse order. The pumping of the tires or deflation of the same is in no way interfered with. The Pressuretell valve is marketed by Indicator Sales Company, 1773 Broadway, New York City.

Don't Risk Losing Your Auto by Fire.—It is often said that an ounce of prevention is worth a pound of cure. This must be true of fires if of anything,

so any means for preventing or extinguishing automobile fires is worthy of attention. Among the successful fire extinguishers is the Goodson, which has the additional good features of being small, compact, efficient, and above all, reasonable in price. This is put up by the makers, Goodson Electric & Mfg. Co., Providence, R. I., in long tubes of small diameter, which will go into any tool box. The composition of the contents is such that it cannot explode, cannot get out of order, will not freeze, requires no attention, and is so simple that any child can operate it. With all these good features, the retailers should sell them faster than the makers can turn them out. If they cannot, it is a sure sign that the people do not know a good thing when they see it. The quality of taking little room should alone be enough to recommend it. But added to that, non-freezing, non-explosive nature and lack of care speak volumes for it.



GOODSON FIRE TUBE.

Wridgway Automatic Headlight Shade.—A crying necessity, due to the glare of the average headlight, which blinds approaching drivers and renders roadwork a hazard. The "Wridgway" is made by the Wridgway No Glare Shade Company, 1999 Broadway, New York City. This shade is said to do nothing to kill the glare of the lamp, and in no way is the efficiency of the same reduced. The rays of the light are not scattered, and the projected beam of a headlight is just as effective, but its penchant of damage is aborted.

W-D Spring Cushion Tire.—This tire is designed to eliminate possibility of punctures and blowouts and insure safety at all times. The basis of the puncture and accident proof claim is the laminated Swedish steel springs which form the interior of the construction. These have the form of a modified letter B laid on the flat side, thus bringing the recess uppermost. Into this a heavy beading on the interior of the rubber shoe or casing, fits loosely, the arrangement of



CROSS SECTION W-D TIRE.

the curves being such that it is impossible for the steel springs to cut into the rubber. The use of springs does away with air and the necessity for providing it in the first place and maintaining it thereafter. This means throwing away the pump and with it all tire worry. The springs are very resilient under load, in fact, a depression of three-quarters of an inch is claimed, which is actually more than the ordinary hard-pumped pneumatic. This should make for easy riding qualities, which have been prominent by their absence in other tires with steel as the base. This tire is said to be no longer an experiment, having been tried on rough and smooth roads for between 7,000 and 8,000 miles, and is pronounced by tire and automobile experts to be the acme of perfection in tire manufacture. It is sold under an absolute guarantee, making it the most economical and absolutely safe tire on the market. The W-D Spring Cushion Tire Company is located at 107 West Twenty-seventh street, New York City.

The Ball Does the Work.—In the Shain Ball Spray Carbureter, as the name indicates, there is no spray nozzle, this work being done by a ball. It floats on the entering stream of gasoline and by its weight regulates the flow thereof. This arrangement makes for simplicity in operation, and by eliminating many

small, delicate parts also reduces the opportunities for derangement. In the sectional view, the gasoline enters at the pipe on the left, passes through the screen, which is removable, up under the ball, and thence enters according to the suction of the engine. This suction not only raises the ball but also sets it to whirling. The result is to break the stream of entering gas into a thin film, which is thrown against the walls, where the air readily picks it up. From this

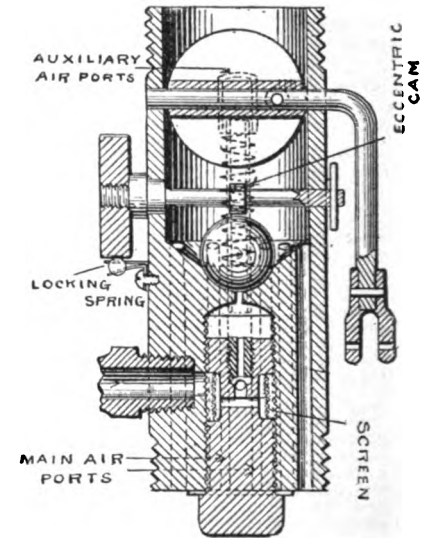

SHAIN BALL SPRAY CARBURETER.

mixing chamber, the mixture passes up into the throttle chamber, where at very high speeds additional air is admitted. This is allowed to enter by the movement of the throttle, which at or near the extremity of its traverse, uncovers the auxiliary air ports. The weight and size of the ball is predetermined by the manufacturers, and is unchangeable. Its lift, however, is regulable by means of an eccentric cam. The size of all of the air ports, both main and auxiliary, is also unchangeable, as is the point at which the latter comes into action. So, this device possesses many attractions for the new driver, and the old hand, who desires simplicity. It is made and marketed by Charles D. Shain, Murray street, New York City.

Greater Convenience in Horn Operation.—A new contrivance of great simplicity and very convenient for use when driving, particularly in crowded city streets, is a horn which may be operated without removing the hands from the steering wheel. In driving along crowded thoroughfares, a person's hands are

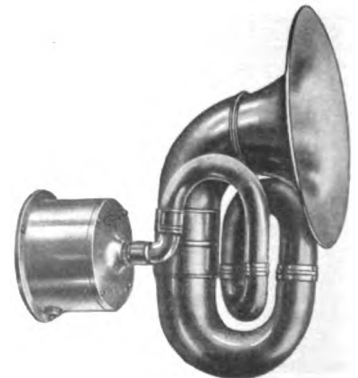

HOLTZER-CABOT ELECTRIC HORN.

rather well occupied by the needs of gear shifting and steering, without anything additional such as a signaling device. A late improvement in this direction is the use of electrically operated horns, which may be operated from any place desired by simply locating the operating button at that point.

A prominent company manufacturing a line of electric horns, the Holtzer-Cabot Company, of Brookline, Mass., has brought out an improved horn which has many new and valuable features which will commend its use. This horn may be operated by either a 6-volt storage battery or by dry cells if preferred. It is so made that the adjustment will not be affected by the jar of the machine running over the road. Moreover, it is also dust and moisture proof. As ordinarily attached to an automobile, the operating push button is placed upon the steering wheel, usually on one of the spokes. It may, in this position, be operated without moving the hands.

New Ajax Non-Skid Tire.—In bringing out its new non-skid tire, the Ajax-Grieb Rubber Company has adopted a distinctive method of construction. Instead of having a moulded tread, the Ajax tread is wrapped on the shoe by the same process by which the ordinary smooth Ajax tire is made. When worn

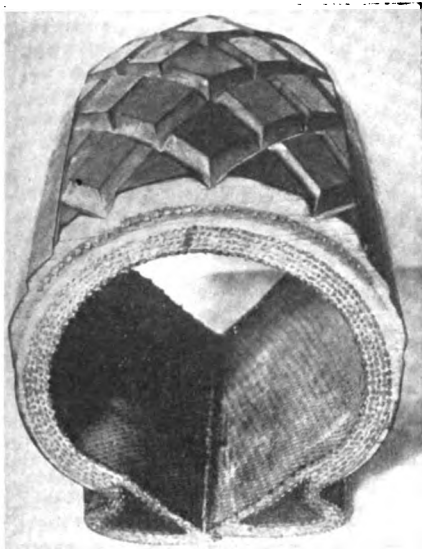

SECTION AJAX NON-SKID TIRE.

after going at least the 5,000 miles for which they are guaranteed, these non-skid tires can be retreaded without injury to the inner fabric so that they can be run two or three thousand miles more. The new Ajax also has a character of its own in its appearance, its raised parts being quadrilaterals, 3-16 of an inch in depth, arranged diagonally across tread. These are designed to be far enough apart to prevent squeezing and flattening into a smooth surface when under weight, and in contact with the road surface. As the quadrilaterals on the Ajax tread point in the direction in which they run, it is claimed they offer a minimum of resistance and wear. The tire itself is heavier than the smooth model, the 3 1-2-inch size having five plies of fabric. The breaker strip—the strip of fabric between the inner pliable rubber cushion and the tough outside layer—is made heavy, and the same is true of the entire tread layer.

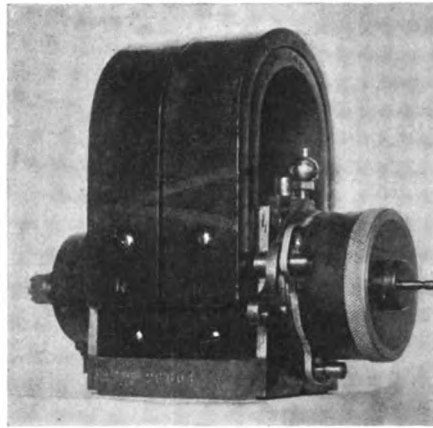

EISEMANN SINGLE-CYLINDER MAGNETO.

Eisemann High Tension Magnetos.—For the coming season the house of Eisemann will produce two types of high tension magnetos intended for the two radically different classes of work, but with similar electrical connections to previous models. The two types will be for use with a separate coil and without a coil, in which case the magneto is a complete ignition system in itself.

In the first style, the make-and-break mechanism is fitted so that it can be detached quickly. This is accomplished by fitting it on a round plate which is readily removable. The contacts are fiber on steel, the cam being steel and the lever carrying the platinum point being fitted with a piece of fiber. The high tension distributor has an automatic cover and arm. The brushes are of steel, used to give the best contact with the least rubbing on the copper. The armature is on ball bearings on the cam side and plain bearings on the driving end. The armature is of the same type as before, the low tension type.

The self-contained type is a departure for this firm, being produced for the first time. The low tension current produced by the primary windings is periodically interrupted by a revolving break, each break producing a high tension current of very high voltage in the secondary winding. This current is collected by means of a slip ring at the driving end and carried to the distributing plate by an insulated lead and carbon brush to the inside of the distributing arm on the distributing plate. This arm is fitted with a long rubber sleeve to secure perfect insulation. For advance, the point of breaking may be displaced by simply

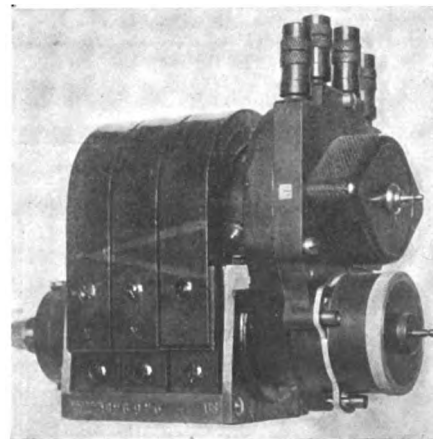

EISEMANN FOUR-CYLINDER TYPE.

shifting the steel shoes on which the fiber block of the breaker lever is kicking. This range of advance is obtained without decreasing the intensity of the spark. The armature is mounted the same as in the first case, ball bearings on the cam side and plain on the gear end. One new feature is the special disposition of the pole pieces, which are cut helicoidal shape. This gives greater smoothness and a larger advance.

The materials used are nearly all of them specially made for this purpose, a number of them being made to order in Germany. They are thoroughly tested out at the French factory. The American sales of all Eisemann products are handled by Lavalette & Co., 112 West Forty-second street, New York City.

To Reduce Internal Tire Friction.—

One of the reasons why tires heat up as they do is because of the very high internal friction, between the tube and the shoe. This may be prevented by the use of some anti-friction powder or liquid, but of such a nature as will not attack the rubber. Many wise autoists use talcum powder; others rub the surfaces with soapstone; but what is claimed to be the best is a preparation just brought out for the purpose, which is neither talc nor soapstone. It is known as Rex powder and is put up in



HOW REX POWDER IS APPLIED.

one-pound cans with combination sifting top, by the Rex Manufacturing Company, Hartford, Conn. The method of use recommended by the makers is to sift a little into the outer shoe just before applying it to the wheel. By putting the powder into the shoe it comes between the shoe and tube where the friction is greatest.

Can't Steal This Clock.—Any automobile owner who has ever been subjected to the petty annoyance of having his clock stolen will appreciate a new clock so constructed as to be thief proof. In the Safety auto clocks, this feature is made prominent. The form is such that a key is necessary to separate the clock from its holding case. The latter is fastened to the dash by means of interior screws, so that with the movement in place these are concealed and consequently inaccessible. A new feature which has just been added to the safety line is the shield. This protects winders from the various objectionable influences such as moisture and will be supplied on all clocks when so desired at a slight additional cost. The clocks are made by Manasseh Levy & Company, 182-184 Broadway, New York City.

**INDEX
TO ADVERTISERS**

Acetylene Gas Illuminating Co. 52	Duff Mfg. Co. 54	M. & E. Mfg. Co. 78	Shaler Co., C. A. 86
Acme Motor Car Co. 57	Duplex Co. 56	Maple City Mfg. Co. 58	Sireno Co. 52
Adams Co. 57	Duplex Coil Co. 84	Masury & Son, John W. 83	Siro Carbureter Mfg. Co. 54
Alr Tight Steel Tank Co. 81	Echo Horn Co. 68	Matheson Automobile Co. 88	Skinner & Skinner 83
Ajax-Grieb Rubber Co. 91	Edmund & Jones Mfg. Co. 55	McCue Co. 57	Spacke Machine Co., F. W. 83
Aluminum Foundry Co. 53	Eldredge Electric Mfg. Co. 52	Metz, Chas. H. 72	Spare Motor Wheel of Amer. 70
American Electric Fuse Co. 82	Empire Automobile Tire Co. 73	Mezger, C. A. 89	Speed Changing Pulley Co. 66
American Motor Car Co. 71	Everett-Metzger-Flanders Co. 73	Michelin Tire Co. 56	Speedwell Motor Car Co. 92
American School of Correspondence 55	Excelsior Supply Co. 61	Midland Motor Car Co. 73	Spicer Universal Joint Mfg. Co. 53
Anderson Forge & Machine Co. 53	Excelsior Tire Co. 55	Miller, Chas. E. 92	Splitdorf, C. F. 58
Asphalt Ready Roofing Co. 70	Ferro Machine & Foundry Co. 99	Mitchell Motor Car Co. 71	Sprague Umbrella Co. 70
Atwater-Kent Mfg. Works. 51	Firestone Tire & Rubber Co. 75	Model Automobile Co. 72	Springfield Metal Body Co. Cover
Austin Automobile Co. 107	Fisk Rubber Co. 95	Moline Automobile Co. 68	St. Louis Supplementary Spiral
Autocar Co. 76	Fientje, Ernst. 68	Moon Motor Car Co. 57	Spring Co. 84
Auto Car Mfg. Co. 87	Fort Pitt Motor Car Co. 57	Morgan & Wright. 94	Standard Co. 63
Auto Tire Security Co. 89	Franklin Mfg. Co., H. H. 103	Morrison-Riker Mfg. Co. 96	Standard Roller Bearing Co. 71
Auto & Supply Mfg. Co. 52	Fried-Ostermann Co. 106	Mosler & Co., A. R. 61	Standard Sales Co. 52
Baker Mfg. Co. 74	G & J Tire Co. 81	Moss Photo Engraving Co. 82	Standard Welding Co. 75
Baldwin Chain & Mfg. Co. 53	Gabriel Horn Mfg. Co. 88	Motor Car Equipment Co. 86	Stanley & Patterson. 77
Biddle & Smart Co. Cover	Gaeth Automobile Co. 72	Motor & Mfg. Works Co. 98	Star Speedometer Co. 105
Billings & Spencer Co. 51	Gearless Motor Car Co. 57	Mutz Clincher Tire & Rub. Co. 56	Stearns Co., F. B. 87
Bl-Motor Equipment Co. 51	Goodrich Co., B. F. 54	N. Y. Sporting Goods Co. 55	Stewart & Clark Mfg. Co. 67
Black Mfg. Co. 54	Goodyear Tire & Rubber Co. 66	N. Y. & N. J. Lubricant Co. 82	Stitch-in-Time Vulcanizer Co. 60
Bliss-Chester Co. 62	Gramm-Logan Motor Car Co. 57	National Tube Co. 65	Stromberg Motor Device Co. Cover
Blue Book. 62	Grossman Co., Emil. 80	National Brake & Clutch Co. 53	Studebaker Automobile Co. 73
Bongartz Co. 65	Grout Automobile Co. 79	National Motor Vehicle Co. 87	Swinehart Clincher Tire Co. 69
Borne Scrymger Co. 56	Ham Mfg. Co., C. T. 54	New Departure Mfg. Co. 97	Syracuse Alum. & Bronze Co. 53
Bosch Magneto Co. 86	Hardy Co., R. E. 52	New Process Rawhide Co. 66	Syracuse Chemical Fire Ex-
Boston Auto Gage Co. 52	Harris Oil Co. 85	Nightingale Whistle Mfg. Co. 88	tinguisher Co. 76
Bowser & Co., S. F. 81	Hart-Kraft Motor Co. 71	Nonkoroda Co. 58	Thomas Motor Co., E. R. 73
Boyle & Co., John. 66	Hartford Suspension Co. 68	Nordyke & Marmon Co. 94	Timken Roller Bearing Axle
Bretz Co., J. S. 64	Havoline Oil Co. Cover	Nuttall Co., R. D. 53	Co. 78
Brown Co. 65	Haws, Geo. A. 54	Oakes & Dow Co. 60	Tiresele Mfg. Co. 75
Brown & Co., S. N. 56	Haynes Automobile Co. 104	Oakland Motor Car Co. 71	Tray Plate Battery Co. 65
Brownell Motor Co., F. A. 53	Helnze Electric Co. 58	Olds Motor Works. 57	Triple Action Spring Co. 66
Brush Runabout Co. 90	Hemmeter Spark Plug Co. 70	Orange Machine & Mfg. Co. 76	Tremont Rubber Mfg. Co. 54
Buckeye Jack Mfg. Co. 54	Henricks Novelty Co. 84	Overland Automobile Co. 98	Trifont Mfg. Co. 52
Buckeye Mfg. Co. 72	Herschell-Spillman Co. 53	Owen & Co., R. M. 56	Tucker, C. F. 75
Buffalo Specialty Co. 82	Herz & Co. 57	Packard Electric Co. 70	Tudor Mfg. Co. 69
Buob & Scheu. 56	Hess-Bright Co. 53	Packard Motor Car Co. 111	Uncas Specialty Co. 61
Burnett-Compound-Spring Co. 69	Hill Dryer Co. 58	Palmer & Singer Mfg. Co. 57	Underwood Typewriter Co. 85
Byrne-Kingston Co. 93	Hoffecker Co. 70	Pantasote Co. 58	Universal Tire Protector Co. 66
Cadillac Motor Car Co. 57	Hoffman, Geo. W. 52	Parish & Bingham. 53	Utility Co. 53
Cameron Motor Co. 74	Holtzer-Cabot Electric Co. 68	Parker, Stearns & Co. 56	
Canton Drop Forging Co. 53	Hotel Woodstock. 58	Pennsylvania Auto Motor Co. 92	
Carter Car Co. 71	Howard Motor Works. 57	Petrel Motor Car Co. 76	
Chadwick Engineering Works. 74	Hoyt Electrical Ins. Works. 79	Peugeot Freres. 53	
Cleanola Co. 74	Hydraulic Pressed Steel Co. 59	Pierce Co., Geo. N. Cover	
Cleveland Puncture Proof Tire Co. 65	Indestructible Steel Wheel Co. 53	Portland Garage. 55	
Coes Wrench Co. 46	Interstate Automobile Co. 72	Premier Motor Mfg. Co. 112	
Conn. Tel. & Elec. Co. 90	Jackson Automobile Co. 57	Prest-O-Lite Co. 85	
Continental Caoutchouc Co. 56	Jeffery & Co., Thos. B. 109	Presser & Sons, Thos. 75	
Continental Motor Mfg. Co. 61	Jewell Motor Car Co. 77	Puritan Gas Tank Co. 75	
Cook's Sons, Adam. 65	K-W. Ignition Co. 78	Quincy-Manchester-Sargent Co. 53	
Corbin Motor Vehicle Corp. 73	Karl Co., Adolph. 52	Quride Hide Co. 53	
Corcoran Lamp Co. 55	Keystone Lubricating Co. 97	Raimles & Co. 52	
Cornish Friedberg Motor Co. 57	Kimball Tire Case Co. 64	Randall-Faichney Co. 64	
Correspondence School Motor Car Practice 78	King Top Mfg. Co. 56	Rapid Motor Vehicle Co. 108	
Covert Motor Vehicle Co. 57	Kissell Motor Car Co. 71	Rauch & Lang Carriage Co. 87	
Crane Puller. 52	Knox Auto Co. 93	Remy Electric Co. 52	
Cullman Wheel Co. 53	Konigslow, Otto. 53	Republic Rubber Co. 56	
Dayton Motor Car Co. 72	Lansing Wheelbarrow Co. 69	Reynolds, Harry H. 54	
Dayton Rubber Mfg. Co. 56	Larchmont Mfg. Co. 52	Robert Instrument Co. 52	
De Luxe Motor Car Co. 57	Lenthier Tire Goods Co. 52	Robinson & Sons Co., Wm. C. 52	
Diamond Chain & Mfg. Co. 100	Lehman Mfg. Co., J. H. 52	Rock Island Battery Co. 85	
Diamond Rubber Co. 101	Leland Co., W. H. 66	Rockwood Mfg. Co. 60	
Dietz Co., R. E. 95	Lexington Motor Car Co. 73	Rome-Turney Radiator Co. 70	
Dixon Crucible Co., Joseph. 64	Life Publishing Co. 52	Royal Equipment Co. 52-68	
Dow Tire Co. 76	Lipman Mfg. Co. 54	Rushmore Dynamo Works. 59	
Driggs-Seabury Ordnance Corp. 81	Lobee Pump & Machinery Co. 54	S. M. Supply Co. 78	
	Locomobile Co. of America. 57	Sallsbury Wheel & Mfg. Co. 52	
	Long Arm System Co. 69	Schenectady Spark Plug Co. 74	
	Long Mfg. Co. 71	Schrader's Sons, A. 84	
	Loring Appliance Co. 52	Schubert Bros. Gear Co. 56	
	Lucas & Co., John. 56	Selden Motor Vehicle Co. 72	

FOR
UNMATCHABLE
QUALITY
BUY

COES

STEEL HANDLE MODEL
WRENCH

Coès New Auto Wrench

Sizes:
6-in. and 12-in.

Special Features:

Narrow Jaws Especially Made for Automobile Work, Without Sacrificing Strength.

COES WRENCH COMPANY, Worcester, Mass.

6"-size jaw opens 1 1/8".
Takes any spark plug.
12" jaw opens 2 5/8".

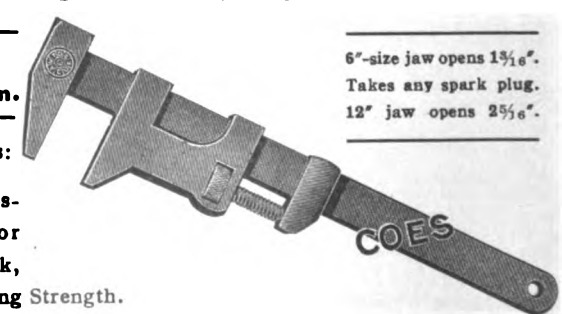

THE AUTOMOBILE

"On to Richmond!"—Nowadays



By Pathfinder

S UDDENLY realizing that an Easter vacation was to be had for the taking, the thought came to mind that Spring would be awakening down Virginia way. Hence the old cry of "On to Richmond!" found lodgment in my brain, and late the same day—which was Good Friday—I was leaving the metropolitan maelstrom in company with friends who accepted promptly the invitation to go along in my White steamer.

We drove to New Brunswick and there spent the night. The next morning we hustled over the road to Trenton, and here, crossing the river, drove into Phila-

delphia by way of Bustleton. This route proved to be much more interesting than the usual route via Bordentown and Burlington, and, besides, we avoided the ferry at Camden and the narrow east-and-west streets of Philadelphia, with blocks of two-story houses.

Coming into the city by way of the Old York Road and North Broad street, we stopped only long enough to have luncheon and then continued straight out South Broad street. Chester was the next town on our route, and we found the roads south of that place quite as neglected as they were two years ago when we passed

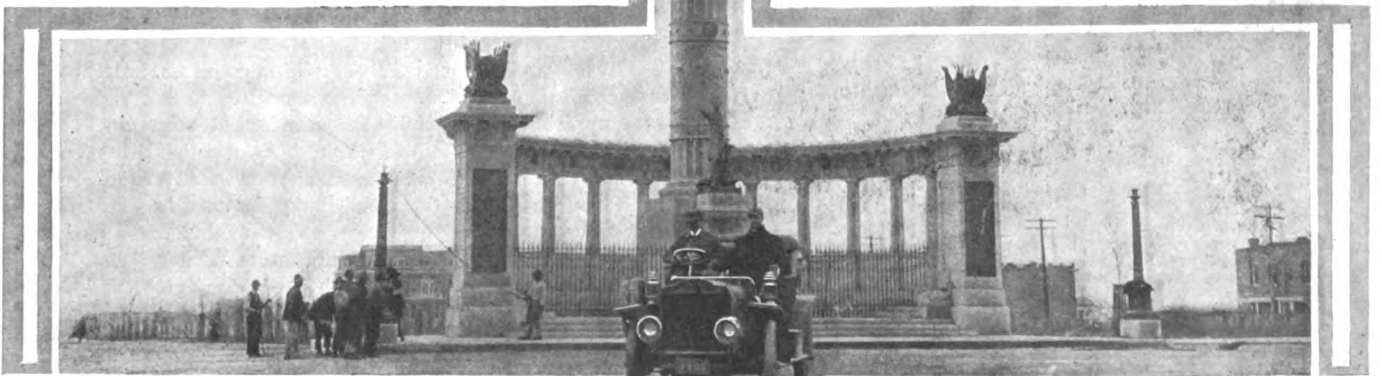

The Jefferson Davis Monument and Peristyle at Richmond, Virginia.

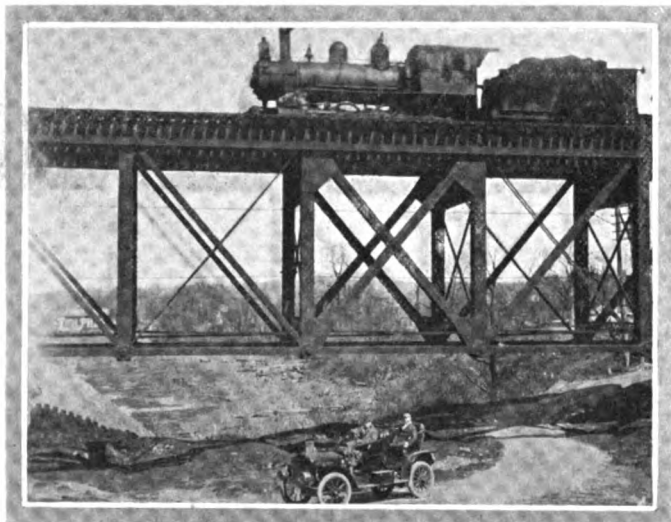

The Rail Bound Steamer and the Trackless Steamer.

through that town on our way to Cape Charles and Norfolk. I make special note of this fact because almost invariably, when covering a route for the second time, I find the roads in better condition than before, thanks largely to the vigorous good roads campaign which the users of automobiles are conducting in all parts of the country.

Soon we were on the fine toll-road leading into Wilmington, and, on reaching that city, we turned off to the southwest and headed for Newark, Del. After leaving Wilmington we were in a section that none of us had before traveled in a car and, consequently, we had to find our way by asking questions at each fork and crossroad. We found the road unexpectedly good, and it did not take us long to reach Newark, and from there to travel to Elkton. Near the latter town the good roads stopped and the road became rather rough, with occasional stretches of sand. Continuing through Northeast and Principio, we reached the Susquehanna River at Perryville just at dusk. The ferryboat happened to be on that side of the river and we were soon across at Havre de Grace.



Chesapeake Bay, South of Havre de Grace.

The fare charged for carrying an automobile on this ferry is \$2, which seemed to us rather out of proportion to the distance traveled. However, as there is a decent pier and approach to the ferry at either side of the river, we did not complain.

It will not be long before the ferry at Havre de Grace becomes a thing of the past. The Pennsylvania railroad has recently built a new bridge at this point and has ceded its old bridge to the State (in return for the repeal of certain onerous restrictions in the company's franchise). As soon as a new center pier is built, which is predicted for November 1, there will be a fine highway for the use of vehicles. At the present writing the first highway bridge over the Susquehanna is at Columbia, and the majority of tourists traveling between Philadelphia and Baltimore go that way—probably because of the senseless tradition that there are some great difficulties in traveling by the direct route via Havre de Grace.

We spent the night very comfortably in Havre de Grace at the Hartford Hotel, taking our dinner at Herr Konigsberg's restaurant, where we were served with terrapin soup, oysters right out of the bay, chicken, and a few similar delicacies at the surprising price of fifty cents per head.

Before starting out in the morning we were joined by our old friend, L. W. Tremblay, of the Automobile Club of Maryland, who acted as our guide for the rest of the day's trip. We had not traveled far from Havre de Grace when the good roads reappeared, and we made quick time through Belair and

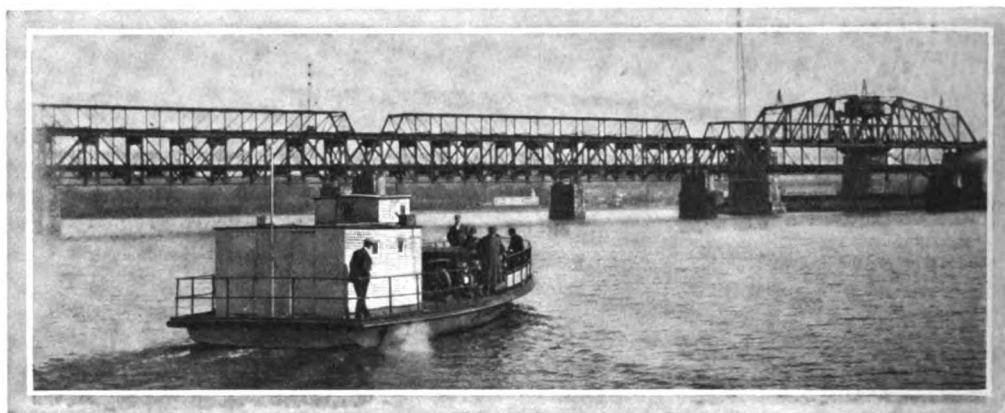

Ferry Across the Susquehanna River, from Perryville to Havre de Grace.

then to the beautiful Long Green valley, famous as the rendezvous of several hunting clubs. Even faster than the nimble fox runs before the pursuing hounds, we hastened through the valley to its terminus at Towson, and from there it was but a short drive into Baltimore (111 miles from Philadelphia).

Up to a year or two ago tourists usually made the trip from Baltimore to Washington by a roundabout way, via Ellicott City. Now a fine boulevard is under construction directly connecting the two cities. More than two-thirds of the road has been finished, and the tourist covers the intervening stretches of bad road with good grace, as he knows that, before another year has passed, the work of building the macadam boulevard between the two cities will be completed.

Only one incident marked our trip into the Capital City. Just as the tip of the Washington Monument came into sight we saw an automobile approaching us at a speed very much greater than that stipulated in the statute. As it flew past us we saw that it was a big White Steamer, in which sat its smiling owner, President Taft, with the members of his family. He acknowledged our salutes by tipping his cap with that display of camaraderie which is usual when White meets White.

We decided to spend the night at Washington, and devoted much of the evening to considering our further plans of "On to Richmond"—the cry which once thrilled so many hearts. We pored over the maps and discussed the pros and cons of the several possible routes to that city, just as must have been done in the dark days of 1861-1865 by those who had in their

keeping the destiny of the nation. But while it took the Union army four years to go from Washington to Richmond, we were determined that we would do it in one day. And we did so, although there is no record of the trip ever having been made before in a day by an automobile. No data has ever been published regarding the route which we covered, and, for that reason, the accompanying map will prove of special interest to those tourists who are not deterred by bad roads, particularly if the bad roads lead through an interesting section of the country.

Leaving Washington on Monday morning (the day after Easter) we crossed the long bridge over the Potomac River and continued parallel with the railroad into Alexandria. On the outskirts of this town we turned due south into the old "Telegraph road," so called because it is along this road that the telegraph wires run to Richmond. Although we made frequent turns during the day, we followed the Telegraph road practically all the way to Richmond, making a few detours here and there at places where we were advised that we could find better roads.

Nothing would be gained by considering the Telegraph road section by section. Almost all of it is bad and much of it is worse. However, I believe that it is only a matter of a few years when this road will be macadamized all the way from Washington to Richmond. But it is the touring conditions now existing of which we speak. There is very little level country in eastern Virginia, and the road goes up and down, up and down. The best roads which we found were of sand, on which,

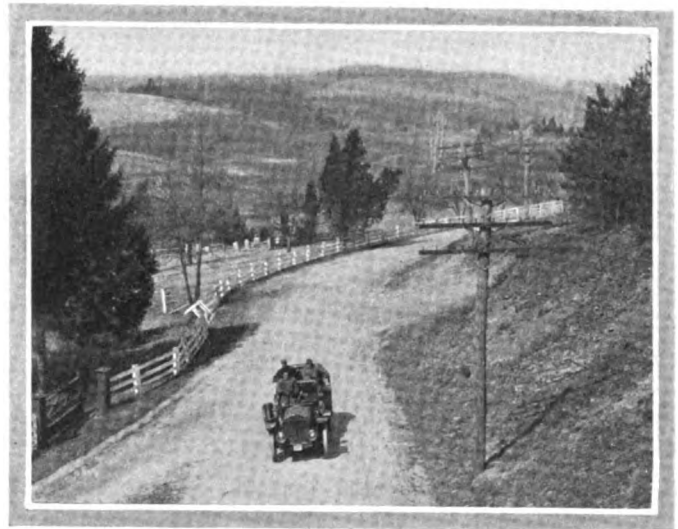

View of Long Green Valley, Near Baltimore.

Soon after leaving Stafford Court House the road improved a little, and we "crossed the Rappahannock" into Fredericksburg. On the summit of the hill just beyond this town we saw by the roadside a little monument, hardly two feet high, bearing the inscription, "Lee's Hill, Battle of Fredericksburg." How modest a memorial this is, we thought, to the valor of the Confederate troops who, on this ridge, in the closing days of 1862, defeated the Union troops who were advancing on Richmond and drove them back across the Rappahannock with terrible slaughter. Surely, if every little Northern town can boast an elaborate Soldiers' Monument, Fredericksburg should have some more imposing memorial of the victory achieved there by the "Boys in Gray."

After we left Fredericksburg behind us the road seemed even

rougher than before. There were more creeks to be forded, but none of them was either very wide or very deep. In fact, considering how sparsely the country is settled, we were a little surprised to find substantial iron bridges over all the more im-



Typical Road Almost Anywhere Between Washington and Richmond.

by "straddling" the ruts and by opening the throttle a little wider than usual, we made almost as good progress as we had on the previous day. Even the worst roads made no difference to us except that we did not cover very much more than ten miles an hour. The roads were rough and washed out, and often each of the four wheels would be on a different level. We found many miles of corduroy road, in which the "corduroy" was missing every few yards. After dropping gently from the "corduroy" we would bring our car almost to a stop at the point where the "corduroy" began again. Then, opening the throttle wide, our car would climb to the new level—almost a foot above the old—without even jarring the passengers. But, of course, this kind of driving takes time, and instead of making Fredericksburg, the halfway point, for luncheon, as we had planned, we had traveled by 1 o'clock only as far as Stafford Court House (52 miles from Washington).

This community consists of a court house, two general stores, a jail, and a fine old-fashioned farmhouse, owned by the clerk of the court, Mr. Bryan. Mr. Bryan's claim to local fame is that he is a cousin of "William J.," the Presidential Marathon runner. However, we shall remember the Bryans of Stafford Court House as the providers of as fine a luncheon as was ever set before a party of three hungry tourists; price (for the three), "A dollar—if that is not too much." I think, too, that they will remember us as having given them their first automobile ride (twelve in the car).



Along the Banks of the Occoquan River.



After Lunch with W. J. Bryan's Cousins, Stafford C. H.

portant streams. After our travels in Georgia, a year ago, we were prepared for anything in the fording line and were, if anything, a little disappointed that we did not find any deeper water on our route.

There is an end to all things—even to a Virginia bad road, and about the time our speedometer registered 95 miles from Washington we were on a road which would have passed inspection



Old House Near Fredericksburg, Riddled with Bullets.

in central New York by the standards prevailing four or five years ago. Just as daylight was fading we reached the little town of Ashland, and here we stopped to light our lamps. We could not get our acetylene lamps working, and, therefore, drove into Richmond by the light of our oil lamps, which, of course, would have been inadvisable had the roads not been in very fair

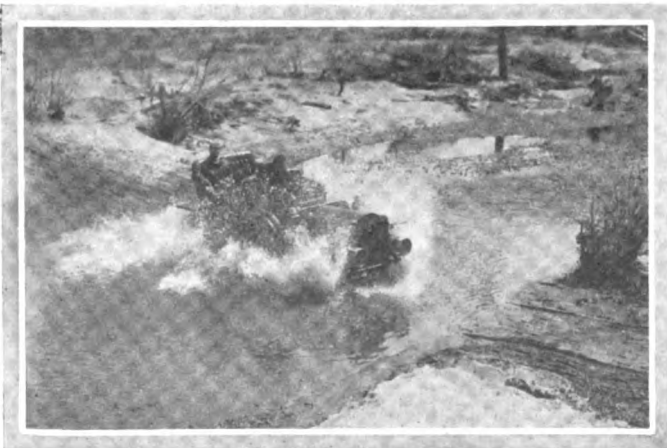

White Steamer Fording a Stream Near Ashland, Va.

condition. We reached Richmond in time for a late supper at the luxurious Hotel Jefferson, 125 miles from Washington and 375 miles from New York. Thus, without a single involuntary stop, even for tires, we had traveled from the metropolis to the old capital of the Confederacy in practically three days and had passed through five States—New Jersey, Pennsylvania, Delaware, Maryland and Virginia. A journey of this character emphasizes the utility of the auto as an up-to-date form of travel.

When Richmond Was Reached We Took Our Ease.

At Richmond I found myself once more in a country which I had previously covered (reaching there via the Shenandoah Valley), and, therefore, decided to terminate the trip, as we were once more beginning to think about telephone calls, unanswered letters, and those other things which, in this imperfect world of ours, intrude upon the mind and time of the tourist. We spent much of the following day in driving around Richmond and its suburbs, and late in the afternoon turned the car over to the Old Dominion Line for shipment back to New York and returned by train, each of us wearing a coat of tan that would do credit to a Glidden tourist the third day out from Kalamazoo.

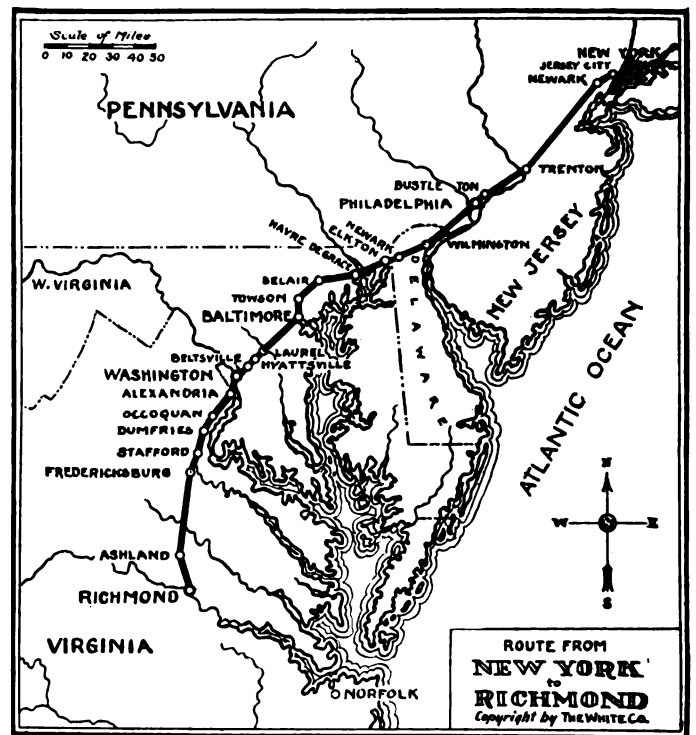

MOTOR PARKWAY RE-OPENED TO TOURISTS.

NEW YORK, April 19.—After being closed to automobilists during the last two months, the Long Island Motor Parkway was opened on last Saturday. At present the Meadow Brook lodge, situated near Garden City and the Meadow Brook Hunt Club, at Westbury, is the only entrance and exit, and cars may pass through it between the hours of 8 a. m. and 7 p. m. on Saturdays and Sundays. Active construction on the course has progressed during the Winter, the right of way having been cleared of trees, and the grading, bridging, fencing and roadmaking east from Bethpage to Lake Ronkonkoma and west from the Meadow Brook lodge to the Queens-Nassau line are receiving attention now. Within a short time extra gangs of laborers, concrete mixers and steel workers will be employed.

WOMEN TO RACE IN FAIRMOUNT PARK.

PHILADELPHIA, April 19.—Permission has been granted by the Fairmount Park Commissioners for an automobile obstacle race to be held by the members of the Movoganto Klaubo, a body of enthusiastic women automobilists. No date has as yet been set.

What the Glidden Pathfinder is Finding

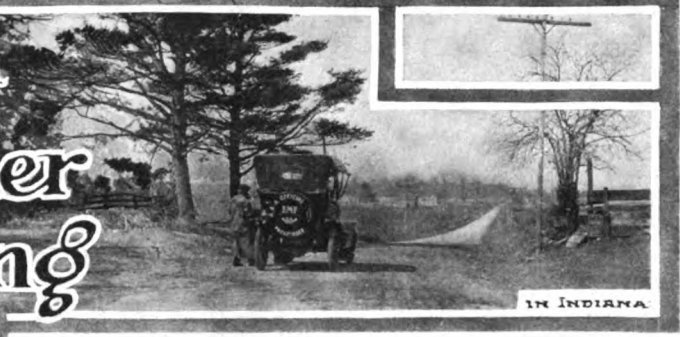

CHICAGO, April 17.—Guard well your thermos bottles, ye Gliddenites given to acquiring a thirst which the town pump will not quench. Note carefully that these receptacles for goat's milk, bubble water, and other elixirs of life blow cold when you leave Detroit on the morning of July

12 next, for they must needs serve as oases in many an arid waste.

It isn't that Michigan will be lacking in vernal beauty. Nature has dealt kindly with the Wolverine State across which Glidden tourists will wend their way in Midsummer. For much of the way the route selected by Pathfinder Dai H. Lewis leads the tourist across rippling brooks and past sylvan dells where lakes of crystal clearness nestle, delighting the eye, but—

It was a raw April morning, with one of those winds that chills to the marrow blowing a gale, when the E.-M.-F. "30" bearing Pathfinder Lewis, E. LeRoy Pelletier, of the E.-M.-F. Company, Official Photographer Krohn, the driver, and the "Innocent Bysitter," trundled into Paw Paw, a thriving village of 1,600, after plowing a course for some hours through a sea of mud caused by a combination of rain and snow.

"At last," murmured Pelletier, who after the exposure to which he had been subjected resembled an animated iceberg more than anything else.

With a deliberation that was exasperating under the circumstances, Lewis clambered down from his seat beside the driver, ambled across the road, and dragging a ruralite to one side talked earnestly with him for a moment. Then he returned to the car.

"He says he doesn't know, but we might try the hotel," said Lewis, as the car sped forward.

Two blocks further and a halt was made at the village inn, where the landlord, sans coat and vest, was standing on the walk superintending the unloading of a sample trunk. Laboriously a quintet of chilled travelers made their way over to the local boniface, and Pelletier, acting as spokesman, propounded the fateful question.

"Gosh all hemlocks, no," ejaculated the astonished landlord, in tones that were plainly audible across the street. "You can't get a drop of whiskey in this town for love or money. This is a dry county, you know."

Sadly five pairs of eyes were turned in the direction of the car, where reposed two empty thermos bottles, the filling of which at Kalamazoo, the last life-saving station passed, had been overlooked.

Then the watchful Pelletier was seized with an inspiration.

"Come on, fellows, we'll get something," said he, leading the procession to a shop a few doors distant, where a sign announced ice cream soda and soft drinks.

"Land sakes, no, we won't have no ice cream soda for two months yet," was the comforting information handed out by the proprietress of the shop, who had emerged from a rear room wiping her steaming hands on a kitchen apron. "We ain't got

no soft drinks, neither." This proved to be a true statement of fact, and for once the redoubtable Pelletier was nonplussed. Ten minutes later when we left the shop, after investing in a number of souvenir post cards, he was standing on the sidewalk in front of the village grocery eagerly devouring a quart of half ripe strawberries in a vain endeavor to assuage the thirst that had been growing with startling rapidity ever since it was discovered that Paw Paw was not an oasis.

There were other points along the line where similar attempts would have been equally fruitless, but no further effort was made. By July these dry spots will be still more numerous, at least two large counties through which the Glidden tour will pass having gone strongly for local option at the recent election, with the result that even blind pigs and speakeasies will be hard to locate after May 1.

Whether premeditated or purely accidental, it happens that the first night's control at Kalamazoo is located in the wet belt, although Battle Creek, only a few miles away, will be dry. Not that this will matter to the Gliddenites, for they are proverbially abstemious; but there seems to be a deal of satisfaction in being in touch with a base of supplies at all times, and the presence of even a well-stocked thermos bottle has been known to ward off thirst just as surely as inability to secure wet goods creates a desire, all of which goes to prove the axiom that a bottle of prevention is more efficacious than a barrel of cure.

Sometime, somewhere, I had read or heard that pathfinding was great sport. Fortunately for the author of that statement, I am unable at this time to recall either his name or address. I



An Illustration Which Tells Its Own Story.

know better. There may be latitudes in which at this season of the year you can drive across country day after day without suffering inconvenience. There is at least one where you can not, as I learned to my entire satisfaction.

When you face biting winds hour after hour as the car speeds along, encounter clouds of sand that at times hide the road from view, splash through mudholes hub deep, and battle with a driving snow that makes progress next to



under water." After due deliberation, we decided not to go through the swamp road, and fifteen minutes later learned that had we followed the instructions given we would have been far off the course. But the natives are a sociable lot, and you are given a hospitable reception wherever you stop.

If asking questions was all there was to it, pathfinding would not be such an irksome task. That is only an incident of the journey. With pencil and pad in hand, Lew-



impossible, all within a few hours, you begin to realize that pathfinding is no sinecure, and your envy of the men entrusted with the task shrinks appreciably. Add to this the joy of piling out of the car in mud ankle deep, picking your way over to a farm house where you are greeted effusively by an underfed dog who loses no time in indicating a desire to feast off your calves while you endeavor to pacify him, knocking at the door, awaiting the arrival of the entire household, and then, after you have shivered and shook for a little matter of five minutes or so, discovering they are unable to enlighten you on the point in which you are in doubt, and you appreciate as never before what such a trip as this means.

"Some folks says it's three an' a half miles, some says it's four, some says it's four 'n a half, an' there's others says it's five. I dunno how far it is," was the interesting information vouchsafed by one woman in answer to an inquiry from Lewis.

"Which road is the best?" inquired Lewis, urbanely.

"The swamp road that runs down past here, leastwise most folks says so, but I don't know," came the non-committal reply.

Back in the machine again, Lewis gave the word to proceed, when in shrill feminine tones there came the cheering announcement:

"You can't go through the swamp road, though. The bridge is busted down, and the road's all

TYPICAL MICHIGAN SCENE



NEAR BATTLE CREEK

is sits beside the driver for hour after hour, taking down the mileage and distinguishing points as the car spins along, and at night transcribes his notes for use in the official guide book that next Summer will describe the course so clearly that the veriest amateur could not go wrong. There are photographs, hundreds of them, taken by the way, and these will show every turn to be made.

Next July, when the Glidden tourists leave Detroit on their way to Denver, conditions will be ideal, and there will be no suggestion of hardship. Neatly printed guide books will tell them where to go and what to do. They may marvel at the completeness of the book, but they will have no conception of what its compilation meant, of the long, cold rides, the endless detail, the vast amount of labor involved.

If they knew what I know about pathfinding—but they will not, so what is the use of dwelling longer on that point? And it is because of what I know regarding pathfinding that I am not envious of Lewis and associates on their trip to Denver. LEN G. SHAW.

DELAWARE RUN.

WILMINGTON, DEL., April 19.—The Delaware Automobile Association has decided to hold an endurance run during the latter part of May. The route will probably be to McCall's Ferry, Pa., along the Susquehanna River.



GETTING DIRECTIONS

PATHFINDER IS PLOUGHING THROUGH THE WISCONSIN MUD.

BUFFALO, N. Y., April 20.—The Glidden pathfinding expedition is by this time well on its way to Minneapolis, on the latter part of the first leg of the tour, and about a quarter of the total distance has been mapped out in shape to go in the official guide book. Starting from Detroit on April 12, the party stopped the first night in Jackson and the second in Kalamazoo, which is to be the first night stop of the contestants. On the third day the route-layers made South Bend, Ind., and on Thursday reached Chicago, the second night stop of the real tour. From the Windy City the path-finding car proceeded to Madison, Wis., which is to be the third overnight stop.

The pioneers are making a more careful survey than ever this year, owing to the unfamiliarity of the country which is to be traversed. The route will be entirely new to the Glidden tourists of former years, with the sole exception of the stretch between South Bend, Ind., and Chicago, which was covered in 1907. Frequent stops are made to take pictures, as all the important turns and forks are to be illustrated in the guide book. The roads have been found very muddy, but their character promises better conditions in July.

The present plans for the tour call for a period of about eighteen days and a distance of about 2,000 miles. There will be two intermissions of two days each, however, one at Denver and the other probably at Minneapolis. Denver automobilists are reported to be raising a fund of \$10,000 for the entertainment of the tourists, so the weary wanderers may look forward to a good time on the Saturday and Sunday to be spent in that city.

It will be noted that both the time and the distance are a little longer than for any former tour, and this is expected to afford a more strenuous test of the cars. However, the plans are as yet tentative and subject to change, as it may be discovered that some of the trips are impracticable. No official announcement will be made until Mr. Lewis has completed his survey.

Arrangements for the night accommodation of the tourists are already being perfected, especially for the ten days in which they will be housed and fed in Pullman cars. This is expected to be a welcome novelty, as the accommodations will all be equally good and the price will be determined and paid in advance, and the "knockers" will have no chance to complain of uncertainty and overcharging. There will be many of the features of camping out, without the disadvantages, for often the Pullmans will be found on sidings out in the prairies, where the coyotes will sing their lullabies.

Although a few still favor rules that permit a number of cars to be tied at the finish with perfect scores, there are more manufacturers who welcome the conditions of a true contest, in which it is certain that a definitive winner will be evolved. In fact, many would favor rules so strict as to leave no perfect scores at all, the car with the least penalization to be the winner. No one expects a car to cover 2,000 miles, over all kinds of roads, without the least stop or adjustment, and the granting of a dozen or more so-called "perfect scores" under such conditions is only a source of criticism.

The greatest value of a cross-country tour is to show the public how the cars stand up under the most strenuous usage, and an unrestricted race in which a car may be secretly rebuilt several times over is of no advantage to anyone. It is of the utmost importance that the cars travel on a rigid schedule and that a close account of all repairs be kept. Moreover, the closer the contest the more interesting it will be, and the more valuable will be the publicity obtained. Charles J. Glidden, the donor of the trophy, will accompany the tourists this year, as usual, riding in the Premier pacemaking car with Chairman F. B. Hower.

Entries at the regular fee will close May 15, the earliness of the date being due to the many arrangements to be made for the accommodation of the party. Entries made up to June 15 will cost \$100 extra, but positively no post entries will be received.

NEW PHASE IN THE NEW YORK TO SEATTLE CONTEST.

IT is barely possible that changed rules and manufacturers' approval in the endurance contest from New York to Seattle may result shortly, if rumors emanating from responsible sources materialize. Great opposition has been found by Mills & Moore, the Eastern managers, to certain provisions in the rules announced, and the lack of regulations of speed and interchangeability of parts, so these may be altered to suit the manufacturers who voted against the event. If this is done it is probable that the members of the Manufacturers' Contest Association may raise the ban placed upon it, although not necessarily entering. Following a visit of John Kane Mills to Detroit, Tuesday, came the report that the manufacturers have been asked by letter from the chairman of the rules committee, H. E. Coffin, whether the matter of the trans-continental contest shall be reopened. A daily schedule of 200 miles as far as Denver, and then go-as-you-please, are the changes suggested.

In the meantime the Thomas pathfinder is battling with snow,

deep mud, broken bridges and no roads at all, in Wyoming. It left Denver on Wednesday of last week, reached Cheyenne that evening over good prairie roads; pushed through 40 miles of snow to Laramie on Thursday; 91 miles to Hanna on Friday, the first 71 of which, to Medicine Bow, was good, and the remainder nearly impassable; 20 miles to Rawlins was sufficient work for one day on Saturday; Sunday was spent in Rawlins while a gang of laborers by the order of the road commissioner tried to make some of the roads west passable; and, Monday, Green River was reached. The road conditions have been such as to almost prevent movement, but it is expected that they will be better in Idaho and Washington, where State appropriations of \$50,000 and \$125,000, respectively, have been made to improve the roads for the contest.

Enthusiastic receptions have been accorded the crew by automobilists and authorities, and they have been accompanied by pilot cars since leaving Denver.

DEATH OF GEORGE P. DICKEN.

PARIS, April 17.—George P. Dicken, well known to many American automobile visitors to Europe as the automobile and aeronautic reporter of the Paris edition of the *New York Herald*, suddenly died recently at Monte Carlo, where he was reporting the motor boat races. Mr. Dicken was the first to obtain and tell of the European success of Wilbur Wright, and consequently secured a notable beat for the *Herald*.

GEORGE B. SELDEN IS MARRIED.

ROCHESTER, N. Y., April 19.—George B. Selden, president of the Selden Motor Car Company, and licensee of the Selden patent on automobiles, was married to Miss Jean Shipley on last Wednesday morning. The ceremony took place at the home of the bride in this city, and immediately thereafter Mr. and Mrs. Selden left for an extended tour. As a wedding present the bride received from her husband a 1909 Selden touring car.

GIANT'S DESPAIR ENTRY BLANKS ISSUED.

WILKES-BARRE, PA., April 19.—An even dozen events will constitute the fourth annual hill climb of the Wilkes-Barre Automobile Club, as shown by the entry blanks which have just been issued. Under the sanction of the A. A. A. and with the understanding that the contest on Giant's Despair, the Wilkes-Barre Mountain, will be the national event of its kind, this will be held on Monday, May 31. The classification has been made according to price and piston displacement, as laid down in the rules of the national organization, and the contestants will be divided into seven sections, according to price; two by piston displacement; one free-for-all, and two special classes, one for members of the local club and one for Quaker City Motor Club visitors.

The regulations under which the affair has been held in the past successfully will be in force this year. The course, which is 6,000 feet in length, with a rise of 700 feet, giving a grade varying from 11 to 22 per cent, will be guarded by efficient police, probably the famous State Constabulary. The contestants will all be given a flying start and none will be allowed to descend until each event is over. An electric timing system will be installed and guaranteed to operate. The Hollenback trophy, offered to cars whose piston displacement is between 301 and 450 cubic inches, will be one of the principal prizes and it must be won three times to secure it for permanent possession.

The entries will close on May 26, with George F. Lee, chairman of the contest committee. The fee for each event has been set at \$15. The list of events follows:

- Event 1—Gasoline stock cars, selling for \$850 or less.
- Event 2—Gasoline stock cars, selling from \$851 to and including \$1,250.
- Event 3—Gasoline stock cars, selling from \$1,251 to and including \$2,000.
- Event 4—Gasoline stock cars, selling from \$2,001 to and including \$3,000.
- Event 5—Gasoline stock cars, selling from \$3,001 to and including \$4,000.
- Event 6—Gasoline four-cylinder stock cars, selling for \$4,000 or over.
- Event 7—Gasoline six-cylinder stock cars, selling for \$3,000 or over.
- Event 8—Free for all. Cars of all types and motive power.
- Event 9—Gasoline stock chassis with piston displacement of 451 cubic inches, not to exceed 600. Minimum weight, 2,400 pounds.
- Event 10—Gasoline stock chassis with piston displacement of 301 cubic inches, not to exceed 450. Minimum weight, 2,100 pounds.
- Event 11—Cars owned by members of the Quaker City Motor Club only.
- Event 12—Cars owned by members of the Wilkes-Barre Automobile Club only.

ALL DIXIE NOW WANTS AUTO RACES.

ATLANTA, GA., April 19.—Successes at Savannah, Daytona, Atlanta, New Orleans and other cities, have stirred the whole South into a racing craze. The complaint long ago infected the large cities and now the small towns have been reached. The latest candidate is Fitzgerald, Ga., a town founded not many years ago by G. A. R. veterans and their families and now numbering perhaps 3,000 citizens. A three-days' meet has been scheduled for June 8, 9, 10, and according to report "500 cars are expected to take part."

SAVANNAH HOPES FOR GRAND PRIZE.

SAVANNAH, GA., April 20.—At a meeting of the executive committee of the Savannah Automobile Club action was taken, giving authority to the chairman to request the Automobile Club of America for early advice as to whether another Grand Prize race is to be held, and if Savannah will be the scene of the event. Not until the A. C. A. is heard from will the Savannah club take any further steps toward the race.

BRITISH DOUBT OF FLORIDA RECORD MAKING.

One of the leading English publications, *Motor*, prints a picture of George Robertson, the well-known driver, and, while calling attention to his Florida time trials at the wheel of the Benz car, cannot resist the temptation to insert in parenthesis that "it is alleged" the figures were made. The particular reference is to the five miles which the Benz covered in 2:45 1-5.

RULES FOR NEW JERSEY RUN ANNOUNCED.

NEWARK, N. J., April 19.—Rules requiring above all things a strict observance of the automobile laws of the State have been announced by the race committee of the New Jersey Automobile and Motor Club, to govern its endurance contest, May 22. Open only to amateurs, the regulations are of a nature new to this part of the country, although conforming to those of the American Automobile Association. Penalties for arriving at the two controls ahead of time, for work done on the motor, and for stops en route, with observers on each car, are provided for.

The event may be entered only by owners of automobiles who are club members in no way connected with the trade, and the cars must be driven either by the entrant or one of the immediate family, no chauffeurs or mechanics being allowed at the wheels. There will be three classes: A, for cars to and including 20 horsepower; B, for those from 21 to and including 30; and C, for those of 31 and over. In addition to the driver and observer, who will occupy the front seats, the full complement of passengers must be carried, and in the case of touring cars, there must be one person for each 18 inches of the width of the rear seat. The driver will be the only one allowed to make adjustments, except to tires, unless permission is secured from the observer, and then the time of the other persons will be charged against the car at double rate of, and in addition to, that of driver.

The route as suggested has been adopted, going to Hackettstown via Chatham, Madison, Morristown, and Schooley's mountain, and returning via Stanhope, Dover, Montclair and East Orange. This circuit is 95 miles in length, and must be covered twice, checking at Newark and Hackettstown each time.

The substance of the penalty list as announced is as follows: To arrive at Newark more than three minutes ahead or behind time on either circuit, 2 points; to stop the motor without making repairs or adjustments, 3 points; to stop the motor to make repairs, adjustments or replacements, 2 points; to stop the car on either circuit after leaving Dover, unless in case of tire trouble, exceptions made when held up at railroad crossings, or for other reasons beyond the control of the driver, 3 points; to repair or make replacements or adjustments, with motor running, 1 point; to replenish with oil or gasoline at any other place than the clubhouse in Newark or the American House in Hackettstown, 1 point. Driving the car in circles in order to delay the arrival at the Newark control will be penalized 2 points. Entry blanks may be secured from the club secretary, A. B. Le Masena, 64 Park place, Newark.

BUSES BARRED FROM RIVERSIDE DRIVE.

The recent action of the Board of Park Commissioners, of New York City, in debarring the Fifth avenue motor buses from using Riverside Drive, has aroused much indignation. The company started the service in response to the popular demand, but has been obliged to suspend it temporarily.

One of the leading landscape architects expressed himself as in favor of the service, saying that the trees should be trimmed to a height of eighteen feet from the road surface as in Paris and other European cities. Harold A. Caparn, treasurer of the American Society of Landscape Architects, is also favorable to the trimming process, and placed himself on record as follows: "The fact is that Riverside Drive is a public parkway, and should therefore be made available to the public as fully and freely as possible, consistent with the proper preservation of its beauties which constitute the greater part of its usefulness. I sympathize with the Park Commissioner, and commend him for his zeal, but his enthusiasm conflicts with public interest."

In the interim, the people in the neighborhood, who encouraged the installation of the service, are anxiously awaiting the outcome. It is urged in favor of the motor bus service that the increasing demand for transportation facilities in that part of the city may result in the establishment of a street car line on the drive, which would destroy its value as a beauty spot.

What to Do When the Carbureter Won't Work

By Morris A. Hall

A CARBURETER is a device for vaporizing liquid fuel. The fuel ordinarily used in the automobile engine is gasoline, and the majority of carbureters are arranged to convert this into a gas. This is done by mixing air with it. Air is used because the fuel itself lacks sufficient oxygen for complete combustion, and air is the cheapest oxygen carrier at hand. If gasoline were self-sufficient, neither air nor other oxygen carriers would be necessary. In that case, the fuel could be vaporized in a closed vessel by simple agitation, such as paddles would afford.

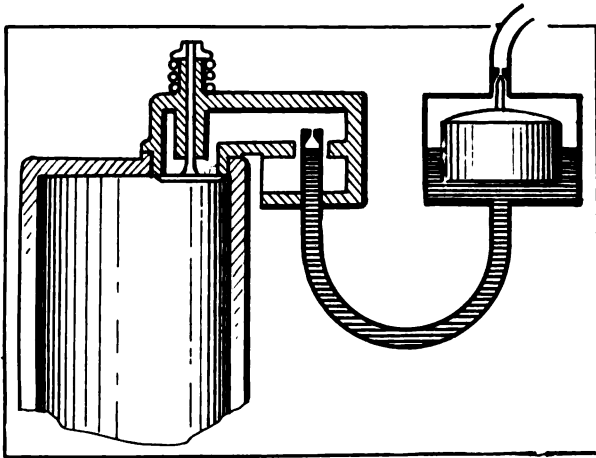

Scheme of Operation of the Original Maybach Carbureter.

The carbureters now in use attain this result in a variety of ways. The early devices were mainly of the surface type, in which the air passes over the surface of a body of the fuel, picking up some of it. Another early form circulated the air around gauze, wicking, or other surface saturated with fuel. Both of these methods are in use to-day, but in combination, and not as the sole source of gas. Thus, Benz used a vaporizing device of this sort on his earlier machines.

Another very old method is called the ebullition or filtering carbureter. In this air is forced through a body of liquid, entering at the bottom and in its passage to the top absorbing small particles of the fuel. Daimler began with this style, but later abandoned it in favor of the Maybach float feed spraying arrangement, which was the prototype of the form now in prevailing use. The filtering scheme is, however, still used.

A fourth basis of operation is the spraying or atomizing of the liquid through a very fine nozzle, being picked up in this form by the intruding air. The common variety is of this kind. The first of this type, the Maybach, as shown in the figure, was remarkable, in comparison with its modern successor, principally for its simplicity. There was a float, controlled by the amount of liquid, and a nozzle. The air entered around the nozzle and mixing with the fine spray of fuel in a chamber directly above the cylinder, was drawn from there into the combustion chamber. Although simple, it was also crude and the heat from the cylinder doubtless had much to do with its success. The nozzle was large, as such sizes go to-day, but in spite of all these defects it worked, and worked better than anything that preceded it.

Defects in the Original Are Not Found in Modern Types.—The original had no adjustment, the opening in the casting measured the amount of air, the size of the nozzle measured the amount of the fuel and the fineness of the spray; there was no means of regrinding the float valve, and thus no way of assuring an even and continuous flow of fuel. The modern adjuncts

of the original Maybach device consist of remedies for these defects, and, in addition, a proper means of balancing the float.

To pick out a modern carbureter at random, take the one shown. Like its ancestor, this has a gasoline chamber into which the fuel is admitted by the action of a float, first passing through a strainer. From the float chamber the liquid passes up to and through the spraying nozzle. The weight of the float is so calculated that the level in the final nozzle is just 1 millimeter (0.04 inch) below the top. This insures that there will always be fuel there for the air suction to draw off. As the chemical action of changing a substance from a liquid to a gas is usually accompanied by the absorption of heat it is advisable to supply a reasonable proportion of this and in that way assist the change of form. In the older Maybach, this was inadvertently done by placing the whole apparatus in close contact with the hot cylinder. In the modern carbureter, placed some distance from the heated portions of the engine, this additional heat is supplied by the jacket water. An alternate scheme is to preheat the air supply by a special pipe from the exhaust manifold.

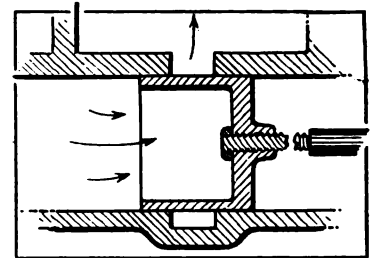

Throttle Stems Sometimes Part.

From this mixing chamber the mixture of air and gasoline vapor passes upward into a secondary mixing chamber. This communicates with the inlet pipe through the medium of the throttle valve. Into the latter chamber, the auxiliary air supply (when used) has access, through the auxiliary air valve. This comes into action on very high speeds when the engine is pulling very strongly, for which the proportion of gasoline to air is liable to be too large, so the auxiliary opens, admits more air and thus dilutes the mixture.

Whatever the character of the resultant mixture, it is admitted to the cylinder by the throttle valve, which takes the form known as the butterfly. This is but a flat piece of sheet metal, preferably brass, attached to a suitable shaft with an operating lever on the external end.

And Then the Trouble Begins.—Fuel and carbureter troubles begin with the first turn of the starting crank. The cylinder is cold, so no heat is available to assist in vaporizing. It is impossible to turn the motor over very fast by hand, so that there is very little suction, tending to draw the mixture into the carbureter. This trouble leads to what is known as priming. It is the act of introducing by hand, or independently of the

carbureter, gasoline in a form that is readily vaporized. It may be squirted into the cylinder head, directly, through the suction inlet valve (if one is used), through the pet cocks on top of the cylinder, or otherwise. To do this, an oil can may be kept on hand, full of gasoline, and reserved for this purpose. Or a rag or piece of waste may be saturated with the liquid, held over the desired opening

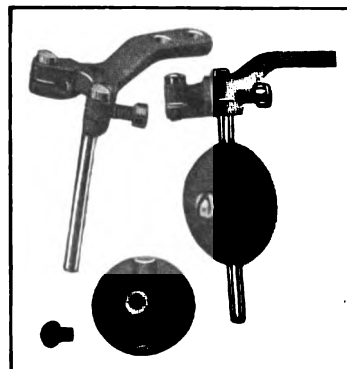

Typical Butterfly Throttle Parts.

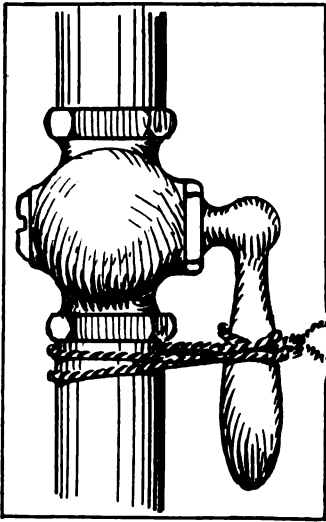

A Little String Saves Trouble.

and the fuel squeezed out. These remarks apply mostly to old-fashioned motors, but can be used in the case of a very stubborn customer of more recent date.

The modern engine starts so readily, however, that such precautions are not necessary. All carbureters are fitted with a device called a priming lever for this particular purpose. The action is to raise the float off of its seat, allow more gasoline to flow into the float chamber, thus raising the head effective for causing a flow at the nozzle, and, from this, the desired result that the gas flows more readily and the motor starts easier. If the prime does not work, prime by hand.

Engine Should Start on the First Turn.—So if all conditions are right, the carbureter is primed and the engine will start on the first turn of the crank. If it does not do so there is a source of trouble which must be remedied first and it is useless to continue cranking. This may lie in the fuel system itself, but exterior to the vaporizer, or it may be in the ignition apparatus. It is well in a case of this sort to start with the gasoline tank and follow the fuel through each step until it apparently reaches the combustion chamber in the form of a properly proportioned mixture of gasoline and air.

To start with the tank, is there enough fuel in it not only for starting purposes, but enough to allow of making the proposed trip? This is readily ascertained by unscrewing the filler cap and inserting a measuring stick. For the purpose a graduated rule is good, but not necessary; any stick or small branch of a tree will answer, or, lacking all these, a piece of wire can be used. A string tied to a very small weight would also do.

Having verified the presence of fuel, the next question to ask yourself is: does it reach the vaporizer as it should? Nearly all carbureters have a drain cock at the lowest point. Open this and if fuel flows out in a steady stream you can be sure that the pipe from the tank up to this point is not clogged. In case the carbureter does not have a drain cock, the same result can be effected by holding the primer for a long time when the gasoline will overflow through the air inlet.

In either case, if there is no sign of gasoline when the tank contains plenty, it is apparent that the feed pipe is clogged and the method of procedure is as follows: Shut off the cock below the tank so that none of the precious liquid can escape, then drain off the carbureter and pipe into a handy pail. Next open the union below the cock in the feed line and the one at the other end of the same pipe. At both places look for obstructions.

Then clean the pipe out thoroughly, using flowing water, a piece of wire or other means which are available at the time.

Gasoline Strainer Is Often a Source of Trouble.—Finding nothing here, it will be necessary to continue the search. Look in the strainer of the carbureter to make sure that the flow is not stopped there by the accumulation of dirt and grit, filtered out of the fuel. This should be

cleaned often, but like many other dirty jobs is "postponed" from time to time.

Should this source of trouble prove "not guilty," the carbureter itself becomes an object of suspicion. Is the float jammed down upon its seat or are there obstructions there which prevent the flow of fluid? Is the float punctured, or has one of the soldered joints, if a metal one, opened, or is it fuel-soaked, if cork?

A Bent Needle Valve Stem Raises Hob.—To attend to this sort of trouble disconnect the priming arrangement, take the cover off of the float chamber (it usually is screwed on with a right-hand thread), and take the float out. An examination of the float will disclose if it is at fault in any of the above-mentioned ways, all of which are comparatively easy to fix. If the float was jammed down, perhaps by priming, the act of taking it out will cure that, provided that the stem of the float is not bent and the needle valve or its seat not injured. If the seat is scored it should be ground in just like any other valve using oil and fine emery. A fuel-soaked cork should be thrown away if another is at hand to replace it, but if not, the cork float should be moved in its position on the stem so that it sets higher in the liquid. In other words, move the cork a sufficient amount to compensate for its loss of buoyancy.

In the case of a punctured float of metal or loose solder, the only real remedy is to resolder in either case. It usually happens that a soldering outfit is not available out on the road and some form of makeshift will be necessary to allow of reaching

a place where a soldering iron may be had. If the puncture is on the bottom, it is sometimes possible to accomplish this by inverting the float so that the hole comes at the top. Here the gasoline seldom reaches and if the flow be reduced to make sure of this, it is possible to get to a soldering iron.

A remedy which might be tried in an extreme case of this sort is to fill the float to make it heavy, so that it will have a tendency to sink. Then take a small diameter spring, cut off a short piece of it and place it in the float chamber so that it opposes the sinking action of the now-heavy float. By carefully determining the length, and thus the strength, of this spring, the same action is obtained as would be had if the float were working all right. Of course, if the entrance of the liquid

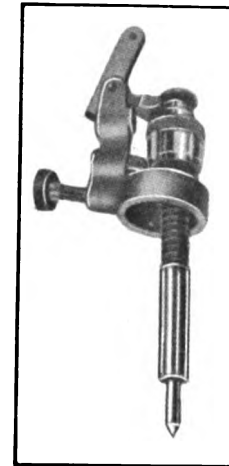

Showing the Delicate Needle Point.

fuel is such that the sinking of the heavy float tends to close rather than open the gasoline inlet, the spring would have to be on the bottom and fairly strong so as to oppose the action of gravity. But if the float works downward to open the gasoline passage the spring will be at the bottom and very weak, simply being there to prevent an excessive flow.

Look Out for a Throttle Loose on Its Shaft.—Now the carbureter trouble has been reduced to a minimum. The remaining troubles might be centered in a clogged spraying nozzle. But this nozzle is readily removed, and with it the trouble, if that be the offending member. If the spray is proven O. K., the throttle is ready for attention. If of the butterfly type it may have become loose on its shaft, or what is the same thing, the operating lever may be loose. In either case the shape and weight are such that it would swing into such a position as would cut off the entrance of gas to the inlet pipe and thus to the cylinder. If the throttle is of the circular sliding or piston form it may not be connected to the throttle rod, but stuck in such a position as to prevent the passage of gas. This sometimes happens when running, and then, apparently, closing the throttle does not stop the engine. The writer had this happen to him once at a time when it was absolutely necessary to stop. The only way that trouble was averted was by the instantaneous closing off of the switch and the application of the brakes.

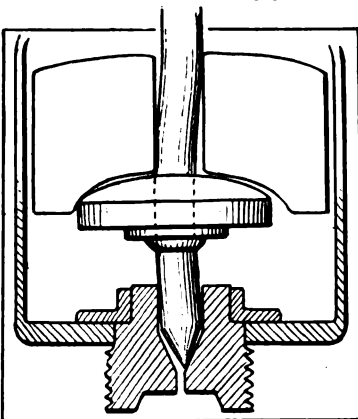

Look for a Bent Needle Valve.

The last hope of finding trouble in the carbureter system rests with the inlet pipe. If no other trouble is found, take this off in search of misplaced waste or similar substances. The size of the pipe is such that anything in it large enough to cause trouble can be seen instantly and removed easily.

The valve or cock controlling the flow of liquid from the tank should be examined frequently and care taken to keep it in good shape. It must act hard and must be tight, so that no gasoline flows when it is supposed to be shut off. The reason for having it act hard is to prevent it jiggling shut after a long run. This is a real source of trouble, as the engine will gradually slow down and stop without any apparent source of trouble until the tank is looked at when the supply is found to be shut off. A method of fixing it, which is not to be recommended, however, is to open the cock and then hammer the handle so as to jam it tight against the seat, but in the open position.

This makeshift will answer until a place is reached where the taper seat can be reground or tightened in place, if that is what it needs. In case the driver did not wish to do this, and the cock was of the two-way type, open when the handle is parallel to the axis of the pipe, it could be tied in the open position by passing a cord around the cock and pipe both.

Water in the Gasoline Causes Cuss Words.—In all phases of gasoline systems trouble there is the possibility of water in the fuel. This may be proven by drawing off a little of the liquid into the palm of the hand and spreading it out into a thin even layer. If gasoline, it will vaporize in a few seconds, say, ten, according to the thinness of the layer and the quality of

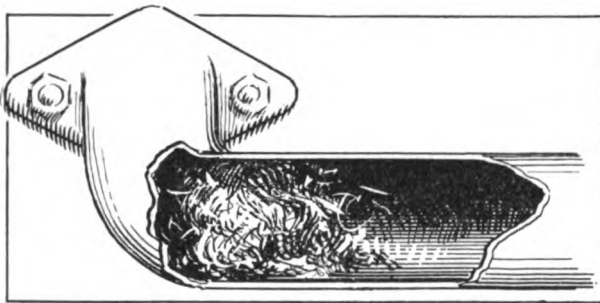

Waste in the Inlet Pipe Upsets All Calculations.

the "stuff." If it does not pass away as a vapor, leaving the hand very cold, within a minute, one is safe in saying that water is present. Another good way to detect the presence of water in the gasoline is to spread some of the suspected mixture over a flat, clean plate, preferably of sheet metal. The gasoline will spread out in a very thin, even sheet, but the water will not. Globules of water will stand up above the thin level of gasoline and thus betray the presence of the objectionable liquid. If this test is worked out carefully and tried several times, particularly in conjunction with the first named test, it is possible to find the impurity every time. A little practice will give the new operator skill in this direction which will come in handy, in time of trouble on the road, when obliged to buy inferior fuel. A very fine screen of brass will intercept some, but chamois will take out all of the water. In a bad case of this sort the quickest way to remedy it is to draw off all the fuel into a pail, and then, in putting it back into the tank, pass it through a piece of chamois. In a mild case it will sometimes suffice to drain the carbureter only.

This feature is of more importance than is ordinarily thought, as a single instance will suffice to show. A car with a pressure tank at the rear of the chassis had the pressure valve fail to work, with the result that the bottom of the tank blew out at an isolated place far from repair and supply stations. With it went the gasoline, of course. An examination of the remains of the tank revealed the fact that the water in the fuel, being heavier, had gone to the bottom, and, lying there in quantity, had rusted through the iron tank, making it so weak that it readily yielded to a little excess of pressure.

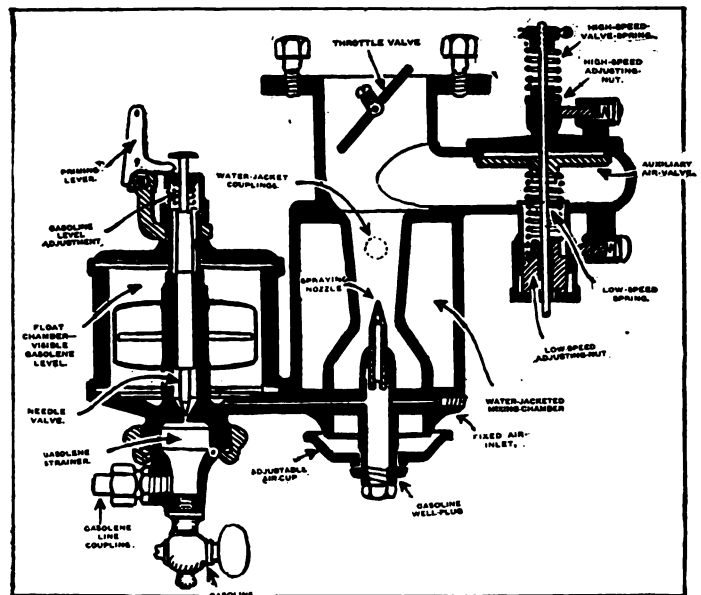

A Typical Modern Carbureter Shown in Section.

It might be thought that the driver, without gasoline or a tank to put it in, was stalled, but such was not the case. A walk of a mile brought him to a trolley line. A nine-mile ride on this reached a place where gasoline was to be had. Returning with a five-gallon can of fuel, the small outlet at the top was connected by means of rubber hose to the end of the fuel-supply pipe. After inverting and punching a hole in the bottom with a nail, for an air vent, the driver reached home by holding the inverted can in his lap or on the seat beside him, the gasoline flowing to the carbureter by gravity. This is an extreme case, but shows what can be done by determination and head-work.

The two cuts, one above and the other below, show a typical modern carbureter, picked out at random, to illustrate to the novice the various parts. The upper view shows a cross-section and the lower an external view. The various parts are all marked with their proper names, the same parts being named in both views. It will be noticed that the mixing chamber is water jacketed; this is not applied to all carbureters; in fact, this particular make may be had without it if the driver so desires it. The parts previously referred to will all be found in these cuts and properly marked with the name by which they have been called.

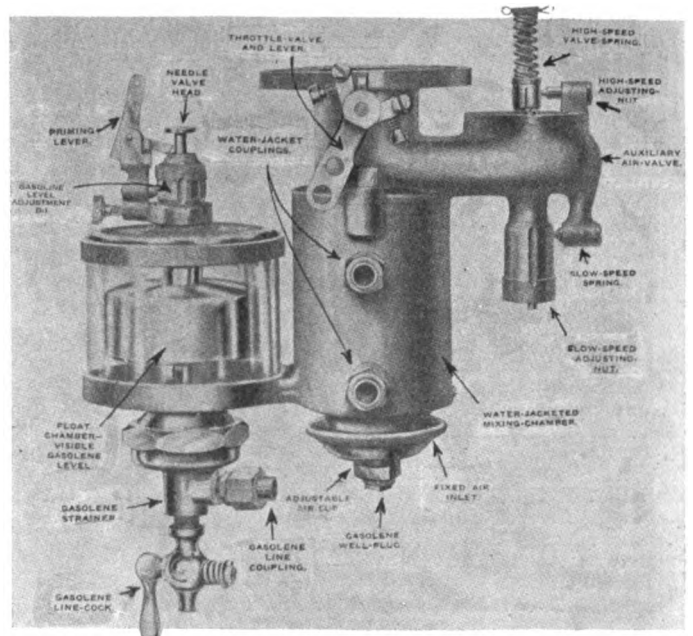

View of the Same with Parts Properly Marked.

Automobile Gasoline and Other Available Fuel

By Thos. J. Fay

Part II

TRUE, when the motor was running slow it was doing no work, and loss was 100 per cent. On the other hand, it is necessary to run the motor when the car is not running, and to whatever extent this necessity is indulged in it has a value in comparison with some other motor that refuses to run under the same conditions, on the same fuel economy; in some cases, then, the loss is more. The next best fuel economy was when the motor was running on full load, and as the nitrogen content shows the amount of air used was slightly more than when the motor was running slow. It is very likely that, under full load, a little more air was what was wanted, and the oxygen present, which was but 0.23, rather goes to show that the air was not up to the requirement.

Partly loaded, the losses were quite in excess of what should obtain, due to the lack of air, as shown by lack of oxygen excess, on the one hand, and to the low nitrogen content, on the other. In this case the oxygen excess was 0.3 and the nitrogen was down to 79.6, both of which showings go to indicate that the mixture was too rich. That this is a very important matter is plain to be seen, especially if account be taken of the hydrogen content, which was 2.4, when the motor was partly loaded, which hydrogen is worth about four times as much as carbon, as a fuel.

To some extent this question is complicated by the composition of automobile gasoline in that if the fuel does not burn, in the time allowed, because it is not volatile, sufficiently for the purpose, it is not a carbureter question unless it is found that, despite the inferior grade of the fuel, it will vaporize by preheating in the manner as shown in Fig. 2.

The Principle of Testing Gasoline.—While it is true that gasoline, in which several fractions of the hydrocarbon distillates can be tested by subjecting the same to a distilling process, and when the several fractions are separated, determine the value of them respectively, this process is a long one, and it cannot be conducted excepting with suitable equipment and by men of some skill. If the object is merely to determine if the sample, in any given case, is as good as it ought to be, considering some standard in hand, the best way to get at the facts will be to note the relative volatility of the standard and the sample to be tested. Fig. 4 will serve to convey the idea, in which it is shown that C_6H_{14} (gasoline) is placed on one pan of a suitable set of balances and some of the sample to be tested is placed on the other pan of the balance. If the gasoline evaporates the fastest, the beam will tilt in the downward direction on the side holding the sample to be tested. By plotting a curve to fixed intervals of time it would be possible to approximate the contents of the sample, as it relates to standards of known performance. In a suitably devised weighing machine the several fractions of gasoline will evaporate off in the order as follows:

PROPERTIES OF AUTOMOBILE GASOLINE.

Name.	Formula.	Density.	Volatility.	Calorific.
Butane	C_4H_{10}	0.600	1	
Pentane, iso.	C_5H_{12}	0.628	31	
Pentane, normal ..	C_5H_{12}	0.626	36	
Hexane	C_6H_{14}	0.674	68.5	7,155
Hexahydrobenzine ..	C_6H_{12}	0.760	69	
Hexahydro-toulene ..	C_7H_{12}	0.772	97	
Heptane	C_7H_{16}	0.688	98	7,380
Octane	C_8H_{18}	0.719	120	7,560
Octane, normal	C_8H_{18}	0.707	125	
Nonane, a	C_9H_{20}	0.740	136	7,900
Nonane, normal	C_9H_{20}	0.722	150	
Decane	$C_{10}H_{22}$	0.738	160	8,060
Benzine	C_6H_6	0.884	80.4	9,690
Toulene	C_7H_8	0.871	111	

If the evaporation is noted and the difference in weight is observed at fixed intervals of time, the curve will show the several rates of evaporation and it will be possible to approximate the percentages of the more volatile fractions in comparisons with the heavier contents. Butane, for illustration, would disappear so rapidly as to make its measurement difficult. This fraction boils off violently at the normal temperature of the surrounding, and pentane boils "on a cake of ice." Hexane, on the other hand, boils at what may be regarded as the temperature of the surrounding, and it is therefore the natural fuel for use in automobile motors, particularly since the calorific value of this fraction is but slightly below that of the heavier fractions. The illustration, Fig. 4, is offered merely as a suggestion, with the idea of elucidating the principle, taking into account relative evaporation under normal conditions. The question of the "heat exchange" will be taken up also, especially since this is a phase of the situation that bears heavily upon the subject.

Considering fuel of this sort, in carbureters, in the conventional way, it is true that water-jacketing will go a long way toward vaporizing the gasoline, and even preheating the air en route to the carbureter will avail much. On the other hand, if the fuel is of the most non-volatile sort, as it may be, it is then that the gasoline will enter the cylinders in globule form, to some extent, at any rate, as depicted in Fig. 5, in which the globules are shown enlarged as they emerge from the carbureter, and since evaporation goes on all the time, and at a rapid rate, if the heat is there to excite the same, the globules will diminish in size as they traverse the manifold, so that the more heat there is available and the longer the manifold the greater is the chance of realizing the much-desired vaporized condition of the fuel by the time it enters the cylinders.

On the other hand, the amount of heat utilized for the purpose should be minimized, on the ground that the weight of fuel in acceptable form will be decreased if the heat is in excess of the exact requirement. That the power realized from a motor will be a maximum if the gasoline is in the most acceptable form is too plain to require further discussion, but there are other phases of the subject that can well monopolize space.

Influence of Fuel on Cranking the Motor.—In kerosene and alcohol motors the question of starting is probably the most important detail, and the greatest bar to the use of both of these classes of fuel. In automobile motors, considering "automobile gasoline," which is not nearly so volatile as real gasoline, this same question comes up, and it is becoming more important as the grade of gasoline is decreasing, from the point of view of volatility. With perfected motors, as they are now to be had, cranking would be with almost no trouble at all were gasoline

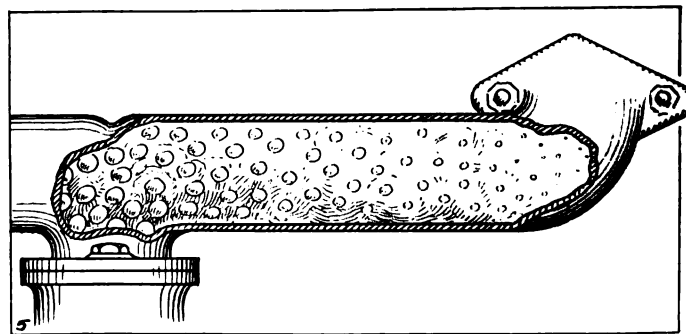

Fig. 5—Depleting the reducing sizes of globules for increasing length of the manifold.

of some grade as "hexane." Even as it is, if a large percentage of the gasoline is of the more volatile fractions, the cranking question is devoid of much difficulty, provided a means is at hand for flooding the carbureter, in order to assure that enough of the more volatile fuel will spill out on the "pan" to satisfy the conditions. Fig. 6 is offered with a view to showing the manner in which "priming" affords relief from the ills of fuel; a large part of which is so non-volatile that it will not vaporize until it contacts with the heated cylinder walls.

The object in priming is to spill out so much fuel that enough of the more volatile fraction will be available to enable the motor to be started. Once the motor starts and the cylinder walls are heated, the less volatile fuel will burn in any case when it enters the cylinders, unless it is that a portion of the fuel breaks down and forms coke. Between the most volatile portions of the fuel (which are the superior fractions to use in cranking) and the heavy fractions there is, of course, a range of fuel that will vaporize in the intake before it enters the cylinder, once the motor is warmed up and the heat is communicated to the surrounding parts. The construction, Fig. 6, is intended to show the manner in which the gasoline raises in the depression chamber "pan" as the result of priming, although it will be understood that there are many ways of constructing carbureters to attain the desired results. In this case the gasoline raises in the depression chamber of the carbureter, and the more volatile portion is picked up by the cold air as it enters the air passage when the motor is being cranked, due to the displacement of the pistons in the motor cylinders and the resultant inrush of air in the intake of the carbureter.

When the motor starts, the float or equivalent device takes charge, and in a few minutes the level of the gasoline falls away to the normal, due to the controlling action of the float. If the gasoline is of a good quality there is danger of flooding, so called, due to the volatility of all the excess gasoline in the pan, and since there is vastly more than is required for the normal operation of the motor, if it is volatile the mixture will be enriched in excess of the requirement. This trouble is disappearing, due to the lack of volatility of automobile gasoline as compared with gasoline proper, and in modern carbureters it is the practice to adequately provide for starting: (a) by so designing the depression chamber that the partial vacuum formed will be a maximum, and (b) so contriving that the flooding process will be effective. As soon as the motor starts, the auxiliary air passage is adjusted to afford an adequate volume of air, in order that the mixture will be the most efficient for the purpose, and, as before stated, when the amount of gasoline is about 1.9 per cent. vapor to air, the best results will be realized. It is not difficult to attain the best result for the reason that the auxiliary air valve will afford a wide range of adjustments, and the motorist soon attains a degree of skill which enables him to judge of the requirements.

Effect of Evaporation on Temperature.—When gasoline evaporates the temperature of the liquid is lowered, and the amount of the change depends upon the proportion of the fractions in the fuel, due to the differences in this respect between them. The drop in temperature for the respective fractions will be as follows:

EFFECT OF EVAPORATION ON TEMPERATURE OF REMAINING LIQUID.

Hexane.	Heptane.	Octane.	Decane.
19	17.9	17.2	14.8

The drop in temperature as above given is in degrees centigrade, assuming that the exact right amount of air is intimately mixed with the fuel in the process of evaporation, and on the further assumption that the fuel is not allowed to change in temperature at the expense of some outside source of heat. On the other hand, to assure this performance it is necessary to consider that the air has to be at a certain temperature at the time of contact with the gasoline. The minimum temperature will be:

MINIMUM TEMPERATURE OF THE AIR FOR A GIVEN TEMPERATURE CHANGE.

Hexane.	Heptane.	Octane.	Decane.
1.3	21.5	36.2	56.8

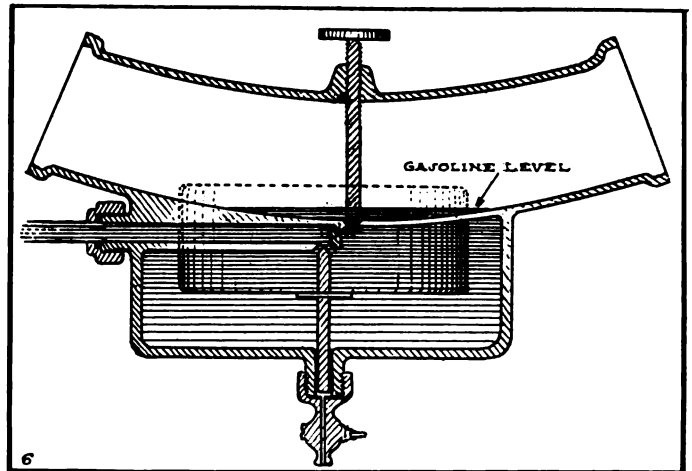

Fig. 6—Showing the accumulation of gasoline in the pan of the depression chamber, as the result of priming.

These values will depend upon the conditions as above set down, and in this case the temperature is in degrees centigrade also. There is one other point to be taken into account, i. e.: There is a minimum temperature at which a vapor can be supported, and this temperature will be different for each fraction, measured at the atmospheric pressure. This minimum temperature is given as follows:

MINIMUM TEMPERATURE AT WHICH FUEL WILL VAPORIZE.

Hexane.	Heptane.	Octane.	Decane.
-17.7	3.6	19.0	42.0

in which the temperature is in degrees centigrade. This tabulation is of the greatest importance, in that it indicates indirectly, to be sure, the relative vapor tensions of the several fractions of the hydrocarbons in common use in automobile gasoline. What will be the resultant of combinations of these fractions in practice is, of course, a speculation, and, too, account must be taken of the better performance of automobile gasoline when the air is in excess, rather than in the theoretical right amount.

In practice it is the custom to adjust the auxiliary air valve of the carbureter until the best result is realized, and it is common custom to consider that the air is in excess about 30 per cent. when the fuel is doing the best work. As to whether or not 30 per cent. is a good estimate must depend largely upon the motor in any given case, for, as has been demonstrated on many occasions, a carbureter that seems to do good work on one motor fails to work in a manner to be commended in another case, considering two motors of the same size. It does not follow that one of the motors will deliver more power than the other, although it might be possible, and it would be the height of good practice to look for more power from the motor using the least fuel under these conditions. It is certain that the thermal efficiency would be the highest for the motor that would work on a given (minimum fuel) carbureter adjustment, and in all probability the difference is to be found in the degrees of scavenging of the respective motors to a vast extent, at any rate.

Irrespective of the relative performance of motors it is necessary to supply an excess of air to all, the exact excess depending upon the quality of the motor in each case, and while the subject is up it is to say quality resides in a motor that uses fuel efficiently, and it is also true, very likely, that the motor requiring the least excess of air for a given fuel consumption is the superior motor to use. In the various types of motors available this excess air requirement is all the way from 20 to 60 per cent., with a few examples perhaps in which the excess air is below the low figure mentioned.

In view of the nitrogen content in mixtures, there is no actual need of any further dilution with a view to rendering the mixture slow burning. It will be understood that nitrogen serves a useful purpose, in that it renders the mixture sufficiently slow burning so that it can be used. Were the fuel free from nitrogen

and sufficiently supplied with oxygen in the right (excess) ratio, under the conditions of compression as they now obtain in motor cylinders, it is not believed that cast iron would hold together long enough to complete one revolution of the crankshaft after the event. The event would be what is commonly termed a disruptive explosion, and the force of the blow would do much damage.

With the minimum sufficient amount of air, considering a pound of gasoline, the products of combustion would be as follows:

PRODUCTS OF GASOLINE COMBUSTION PER POUND OF GASOLINE.

Carbon Dioxide.	Water Vapor.	Nitrogen.
2 pounds.	1.5 pounds.	11.8 pounds.

In this is evidence of the presence of 15.3 pounds of air per pound of gasoline, and, while the ratio will change under different conditions of fuel, the nitrogen content is the major portion. That this large volume or weight of nitrogen is necessary may be more or less true, but it is not necessary to include a considerable percentage of spent product of combustion in the bargain, hence the desire for the most perfect possible conditions of scavenging, or further additions of air in the absence of perfect scavenging. With imperfect scavenging more air is needed, for the reason that all the oxygen enmeshed in spent products of combustion is lost for the real purpose, and to whatever extent this process is represented additional air must be supplied.

Excess air in the mixture will upset the conditions involved in the temperatures, both of evaporation and of the air before evaporation. Increasing the air excess has the effect of decreasing the temperature drop, as would be natural, since the specific heat of the air is substantially constant, and the heat

HOW TWO-CYCLE EFFICIENCY IS INCREASED.

A new feature for application to two-cycle engines has been made the basis of letters patent by its inventor, Manuel S. Carmona, of Mexico City. One drawback of the two-cycle motor has been the poor efficiency of the exhaust stroke, this working out in two ways, one the exhaust gases left in the cylinder vitiate

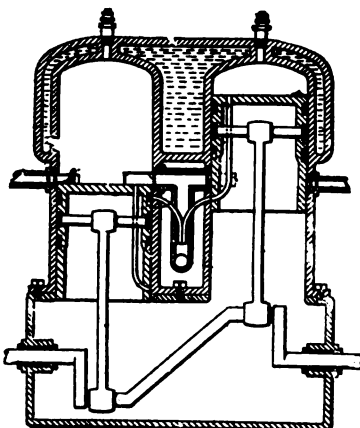

Cross Section Carmona Motor.

part of the mixture, and the other, the incoming fuel is used to blow the exhaust out, some of it following, thus reducing the fuel economy. This new idea is applicable to any two-cylinder motor with cranks at 180 degrees or any four cylinder with adjacent cranks at 180 degrees. It consists primarily (as shown in the cut), of an extremely small diameter tube set into the piston in such a manner that at the point of maximum compression in that cylinder, its lower end will register with a similar sized

part of the mixture, and the other, the incoming fuel is used to blow the exhaust out, some of it following, thus reducing the fuel economy. This new idea is applicable to any two-cylinder motor with cranks at 180 degrees or any four cylinder with adjacent cranks at 180 degrees. It consists primarily (as shown in the cut), of an extremely small diameter tube set into the piston in such a manner that at the point of maximum compression in that cylinder, its lower end will register with a similar sized

tube set into the cylinder wall and communicating with the pipe into which the adjacent cylinder is exhausting.

The idea of this is that a very small portion of the gases at compression pressure escaping into the exhaust pipe will create an injector effect or vacuum which will clear the cylinder of spent gases more quickly than otherwise.

GEORGIA CITIES USING TAXICABS.

SAVANNAH, GA., April 19.—The hackmen in the State of Georgia are becoming alarmed these days because most every city has, or is going to use, taxicabs in a very short time. The latest to fall in line is Macon.

units involved will be proportional to the weight of air taken, which, in this case, for 30 per cent. more air than the net requirement, will be as follows:

EFFECT OF EVAPORATION ON TEMPERATURE OF REMAINING LIQUID.

Hexane.	Heptane.	Octane.	Decane.
15.2	12.9	13.3	11.5

In this, as in the preceding case, it is assumed that the liquid is not affected by heat additions from any outside source, and the temperature in degrees centigrade is that due to the heat exchange, pure and simple. In this, as in the preceding case, it is also necessary to take into account the minimum temperature at which the air will have to exist, in view of the results given for the fall of temperature in the liquid on a basis of 30 per cent. excess air, which air temperature will be as follows:

MINIMUM TEMPERATURE OF THE AIR FOR A GIVEN TEMPERATURE CHANGE.

Hexane.	Pentane.	Octane.	Decane.
-7.1	13.2	27.8	49.2

Likewise, increasing the amount of air to excess over and above the net requirements for theoretical complete combustion influences the temperature at which the fuel can support vapor as follows:

MINIMUM TEMPERATURE AT WHICH FUEL WILL VAPORIZE.

Hexane.	Pentane.	Octane.	Decane.
-22.4	.5	14.5	37.7

Increasing the air content has the effect of lowering the temperature at which the gasoline will vaporize, and, as will readily be understood, this is one of the reasons why excess of air is by way of decreased trouble in practical operation.

(To be continued.)

TAXICABS IN PLENTY FOR THE HOOSIERS.

INDIANAPOLIS, IND., April 12.—Although there are no cabs now operating in the city, within sixty days there will be three separate lines working, with some twenty or thirty cabs on the job.

John E. Morand, interested in the Frank Bird Transfer Company and the Indianapolis Transfer Company, has placed an order with the Coppock company for ten vehicles, which will be placed at the Union Station and in front of the principal hotels.

The first company to get into action will be Charles W. Sheetes & Son, for whom the Lambert company has practically completed four taxicabs. These will be delivered and in use by the first of May.

The Overland company is now manufacturing taxicabs, of which some ten of the first lot have been ordered and are eagerly awaited by a local company.

From all appearances, it will not be long before many of these cabs will be in service, and from the interest that is being displayed in them it seems as if Indianapolis will be a red hot taxicab town.

MOTOR TRUCKS NOW BARRED FROM DOCKS.

NEW YORK CITY, April 19.—The work of years in gradually winning the various steamship lines over to a sane view of motor trucks has been upset in a minute by the action of the New York Fire Insurance Exchange, which recently notified the owners of all docks that if gasoline or steam trucks were allowed on the piers they would increase the insurance rates 50 cents per \$100. As this is a 50 per cent. increase, the dock owners at once prohibited all vehicles using gasoline, kerosene, benzine or naphtha from going on the piers. Following this drastic action the New York Automobile Trade Association, the Association of Licensed Automobile Manufacturers and the American Motor Car Manufacturers' Association announced their intention of fighting for a more liberal attitude, which will place the self-propelled vehicle on a par with horse-drawn trucks. Having worked for years to obtain this privilege, they do not propose to lose it without a struggle.

Repair of Aluminum Castings by Oxy-Acetylene

By Henry Cave

PROBABLY the most radical development produced by the advent of the oxy-acetylene flame is the welding of aluminum. As most people are probably aware, all other metals are amenable to some form of brazing or soldering process. Cast iron could have been considered in the same class as aluminum until a few years ago, when discoveries were made resulting in it being possible to braze it more or less satisfactorily. Aluminum, however, defied all attempts to unite it in a manner which would in any way approximate the strength of the metal. Though

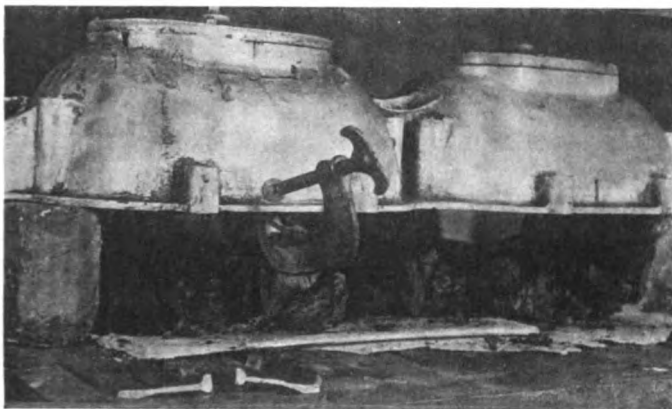

Badly Broken Case Prepared for the Welding.

it has for several years been possible to solder it, the results are not satisfactory where anything more than the stopping of a leak or other requirements as would not subject the joint to strain. Even for this purpose it requires considerable experience to get satisfactory results, and the permanency is always doubtful, owing to the possibility of electrolytic action. The reason of this difficulty is that metallic aluminum always contains a small amount of oxide, and therefore it is extremely difficult to coat the surface without having an intervening layer.

Even though a neutral flame (or the flame can even be adjusted to contain a surplus of carbon) is obtained with the oxy-acetylene torch, the molten surface of the aluminum being fused by this means has a coating of oxide which has to be broken up by puddling with a steel rod, allowing the metal to run together, thus producing a weld that is practically local recasting. It has often been attempted to remove the oxide chemically by means of a flux, but so far this has not been accomplished, though certain chemicals have been found that help considerably and add to the strength and smoothness of the weld.

It is interesting to note that, though the oxy-acetylene welding process originated in France, and is much more extensively used there than in this country, we are considerably ahead of them in the art of welding aluminum.

Though aluminum fuses at a comparatively low temperature (1,200° Fahr.), its high conductivity for heat, which has a ratio of 31.3 as compared with 11.9 for iron, makes it necessary to use more heat in welding than is required by metals having a much higher melting point. The heat being conducted away from the weld into the surrounding metal to such an extent that when the surface to be welded becomes molten the metal for a considerable distance around is close to the point of fusion and liable to collapse if great care is not exercised. This is often guarded against by placing what is practically a complete mold under the part to be welded. The first illustration above shows this in practice, the clamp being used to hold the mold.

It can be readily seen that one of the principal features of carrying out this work is the time taken, as the longer the flame takes to fuse the metal, the greater the amount of heat that is conducted into the surrounding parts; therefore, the hotter the flame, the less the time and the conduction of heat. This is the reason why it is necessary to use a flame of such a high temperature (6,300° Fahr.) as that produced by burning acetylene with oxygen to obtain satisfactory results on a metal of such a low point of fusion, as aluminum.

Another feature is helped by confining the heat to as small a space as possible by reducing the time for conduction, as this also reduces the expansion. The chance of the part cracking, due to the shrinkage of the metal in cooling is considerably reduced. The chance of cracking can be realized when it is known that the shrinkage of aluminum in cooling, from the point of fusion to atmospheric temperature, is three-sixteenths of an inch per foot. The modulus of elasticity of aluminum as given in text-books is 11,500,000 lbs. per square inch. This is a theoretical figure that represents the weight per square inch that would be required to stretch a piece of the material to double its length, if the elasticity remained the same as it is up to the point where it actually ceases and commences to tear the metal apart.

Tensile tests of aluminum alloy, as used for automobile parts, generally show that the elastic limit and maximum strength practically coincide, the material not having any appreciable elongation, and this elongation is reduced to a vanishing point when the metal is heated to a few hundred degrees.

Taking an example of shrinkage in two inches, which is no uncommon length to have molten at one time, using the above

$$\text{figures, then the stress produced would be } \frac{11,500,000}{1/32 \times 2}, \text{ or } 718,800$$

lbs. per square inch, which is far more than any metal could withstand, and if it is not ductile enough to stretch, it would certainly pull part. This trouble is, however, eliminated in most cases by preheating the part to be welded, uniformly all over, and in this way reducing the extreme difference in temperature, and therefore the contraction between the metal at the weld and

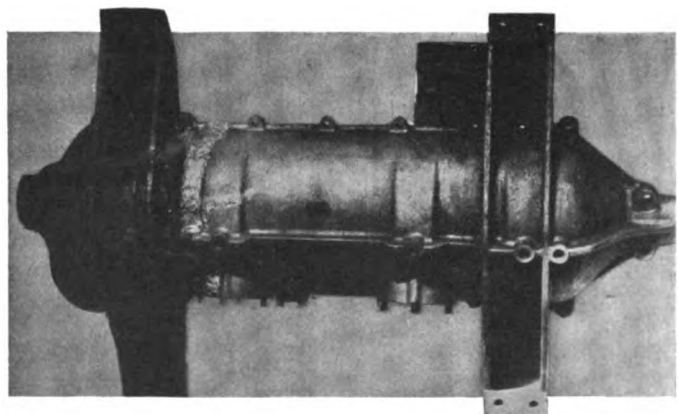

This Case Was Nearly Severed, But Welding Saved It.

the rest of the casting. That is, the parts that otherwise would tend to hold the weld from contracting in cooling will themselves have to contract at the same time as the weld, thus practically eliminating the strain. It can readily be seen that it is not necessary to preheat the part when a foot or lug is broken off entirely, as there is nothing to restrict the contraction.

Castings having a thin part connected across parallel to a

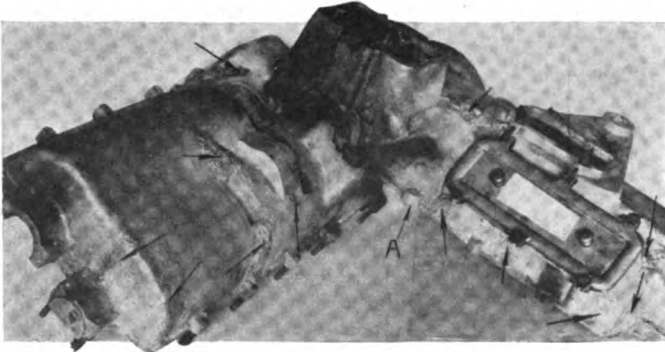

Both Halves of Case on Which Fourteen Welds Were Made.

heavy section are practically impossible to weld with the present development of the process, though it is quite possible that means of doing this may be discovered any time. There is, of course, some difference in the action of the different alloys now being used, and what might prove a failure in one case might be a success with other material.

Up to the present time the new aluminum alloy, "Magnalium," which is coming into use, cannot be satisfactorily welded, due to a very heavy oxide forming on the surface, but a flux may sooner or later be discovered to eliminate this.

A few pictures showing work of this class are given on this page. They represent cases of entirely broken parts, those only cracked and instances where it was necessary to build up additional metal. Fig. 1 is a badly broken case prepared for welding with the mold and charcoal in place. Fig. 2 shows a lower half of a crankcase, which was nearly severed at one point. The third figure is a transmission case which necessitated welding in no less than fourteen places, as indicated by the small arrows. In the center of the figure, *A* shows where the metal was built up to form a new lug in place of one broken off and lost.

AMONG THE NEW AUTOMOBILE BOOKS.

The Gas Engine.—This 447-page work is an attempt to cover the whole of the field. The author, Forrest R. Jones, formerly an instructor at Cornell, and more recently at the head of the New York School of Automobile Engineers, has treated the subject in a manner that renders it more of a text-book than a reference work. The general order of the subject matter is as follows: Descriptive, operative, testing for faults, theoretical, results of tests. The very important subject of ignition is well covered, no less than 52 pages being devoted to it. The chapters on cooling, lubrication and exhausting are very brief, almost too much so. A short but very practical treatise on valve timing is followed by a number of pages on troubles and tests. A brief portion at the end of the book is given up to the pure theory of the heat cycles, which are well, if briefly, covered. The whole book is written in exceedingly plain language, the extremely technical being purposely avoided. This is a feature that will gain it many friends among the non-technical readers. The book is published by John Wiley & Sons, of New York City, and the retail price is \$4.

"Automobiles."—This is the text-book of the American School of Correspondence, located in Chicago, and consequently its 186 pages are rather elemental. The author, Hugo Deimer, M. E., is professor of mechanical engineering at Pennsylvania State College. The book is called a practical treatise on the construction, operation and care of gasoline, steam and electric motor cars, including mechanical details of running gear, power plant, body and accessories, instruction in driving, etc. The subject matter is divided into five chapters and copiously illustrated with cuts of American cars and parts of cars, very few line drawings being used. Considering its audience, the book has been carefully freed from any and all traces of theoretical or technical matter; in fact, it is of an intensely practical nature.

THE AUTOMOBILE CALENDAR.

AMERICAN.

Races, Hill Climbs, Etc.

- April 22-24.....Chattanooga, Tenn., Hill Climb on Lookout Mountain, Lookout Mountain Automobile Club.
 April 23-25.....Denver, Col., Dealers' Demonstrating Tour, to Pueblo and return.
 April 24.....Philadelphia, Roadability Run to Atlantic City, Quaker City Motor Club.
 April 26-May 1...New York City, Second Annual Automobile Carnival, New York Automobile Trade Association.
 April 26.....New York City, Second Annual Hill Climb, Fort George-New York Automobile Trade Association.
 April 26-28.....Lawrence, Kan., Three-Day Endurance Run, Lawrence Automobile Club, Beatrice, Lincoln, Fairbury, Lawrence.
 April 28-30.....Pittsburg, Pa., Gazette Times-Chronicle Telegraph Three-Day Endurance Run. Indorsed by Automobile Dealers' Association.
 April 30.....New York City, Endurance Run, New York Automobile Trade Association.
 May 3-6.....Harrisburg, Pa., Third Annual Endurance Run, 700 miles, Washington, Baltimore, Scranton, Motor Club of Harrisburg.
 May 10-13.....Detroit, Mich., Four-Day Endurance Run, Detroit Automobile Dealers' Association.
 May 18-19.....Norristown, Pa., Second Annual Endurance Run, Norristown Automobile Club, to Hagerstown, Md.
 May 22.....Hartford, Conn., 200-Mile Endurance Run, Hartford Automobile Club.
 May 22.....Newark, N. J., Third Annual Endurance Contest, New Jersey Automobile and Motor Club, 190 Miles.
 May 31.....Wilkes-Barre, Pa., Annual Hill Climb, Giants' Despair Mountain, Wilkes-Barre Automobile Club.
 May 31.....Bridgeport, Conn., Annual Hill Climb, Sport Hill, Automobile Club of Bridgeport.
 June 1.....New York City, Start of Transcontinental Contest to Seattle, for Alaska-Yukon-Pacific Exposition, M. Robt. Guggenheim Trophy.
 June 12-14.....New York City, Catskill-Berkshire Endurance Contest, New York Automobile Trade Association.
 June 14-18.....Philadelphia Reliability Run to Pittsburg and Return, Quaker City Motor Club.
 June 17.....Readville, Mass., Track Race Meet, Bay State Automobile Association.
 June 18-19.....Chicago, Stock Chassis Race for Cobe Trophy and Light Car Race.
 June 21-26.....Binghamton, N. Y., Fourth Annual Endurance Run, Albany, Boston, Hartford, Newburgh, Binghamton Automobile Club.
 June 22-28.....Albany, N. Y., Fifth Annual Tour, Bretton Woods, Portsmouth, Boston, Albany Automobile Club.
 June 24-26.....Montreal, Blue Bonnets Track, Race Meet. R. M. Jaffray, Manager.
 June 25-26.....Philadelphia, 24-Hour Track Race, Quaker City Motor Club.
 July 3 and 5.....Wildwood, N. J., Straightaway Races, Motor Club of Wildwood.
 July 4.....Los Angeles, Cal., Southern California Automobile Dealers' Association. Road Races, 250 Miles for Large Cars; 150 Miles for Light Cars.
 July 12.....Detroit, Start of Sixth Annual A. A. A. Tour for Glidden Trophy.
 Sept. 6-11.....Lowell, Mass., Automobile Carnival, Lowell Automobile Club.
 Sept. 15.....Denver, Col., Start of Flag to Flag Endurance Run to Mexico City.
 Oct. 7.....Philadelphia, Second Annual Stock Chassis, 200-Mile Race, Fairmount Park, Quaker City M. C.
 Dec. 29-30.....Philadelphia, Fourth Annual Mid-Winter Endurance Contest, Quaker City Motor Club.

FOREIGN.

Races, Hill Climbs, Etc.

- April 22-30.....France, Paris, Small Commercial Vehicle Competition.
 April 26-May 13..Germany, Commercial Vehicle Competition, Kaiserlicher Automobile Club.
 April 29.....Sicily, Voiturette Races.
 May 2.....Sicily, Targa Florio, Automobile Club of Italy.
 May 6-9.....Austria, Small Vehicle Competition, Automobile Club of Austria.
 May 8-23.....Belgium, Antwerp, Sixth International Automobile, Cycle, Martime and Fluvialite Exposition.
 May 10-15.....Sweden, Industrial Vehicle Competition, Automobile Club of Sweden.

Letters Interesting and Instructive

NAPHTHALENE INTERESTING.

Editor THE AUTOMOBILE:

[1,843.]—Will you please inform me where naphthalene can be procured and at what price? How is it used as a car fuel and can it be used in common runabouts?

A SUBSCRIBER.

Griffin Corners, Delaware County, N. Y.

Naphthalene is put on the market in three forms: flake, balls and crystals. These may be obtained from any wholesale druggist. The retail price cannot be given, but it will not be far from 3 cents per pound, as the wholesale price is 2½ cents. This is for all grades, but the first and last would be the most pure and, therefore, by far the most desirable.

To use it as a car fuel will require special apparatus: first, to melt it; second, to heat and vaporize the resultant liquid, and third, means for feeding the vapor to the engine as required. Aside from melting it, the process of using it will be exactly similar to the use of alcohol as an automobile fuel. Gasoline weighs a little over 6 pounds per gallon, so that at 18 cents per gallon the price per pound is about 3 cents. This gives a basis of comparison, but not very favorable to naphthalene. In France it costs 12½ cents per pound, while gasoline is 65 cents per gallon. This makes the latter cost about 10½ cents. Even at these apparently unfavorable prices, it appears that the motor uses less of the naphthalene fuel than of the gasoline. On the Paris-Versailles test, spoken of in the March 25 issue of THE AUTOMOBILE, the cost of fuel using gasoline only was \$2.75, while the other cost but \$0.82, with \$0.22 added for gasoline used in starting. Apparently more tests are desirable.

AUTO RAILWAY CAR.

Editor THE AUTOMOBILE:

[1,844.]—I understand that there are some attachments made for use in running an automobile on railroad tracks. Will you kindly give me addresses of all the different makers of these attachments?

H. E. H.
Princeton, W. Va.

About the only attachments necessary for cars of standard gauge are a means of locking the steering gear and railway wheels with the proper flanges. If the car is not of standard gauge, some sort of shims or washers will be needed to bring the gauge (tread of the automobile) up to or down to standard railway gauge. As to flanged wheels, you being a railway man, should know of more manufacturers than we do. Simply order them with plain hubs and bore the hubs out to suit your axles. We have never heard of a manufacturer of a steering gear lock for this purpose, but you can render the gear ineffective by taking off the cross connection back of the axle and the steering rod from the right knuckle to the moving arm of the gear.

It is not advisable to use an automobile in this manner, as it throws upon the springs and other running gear parts undue strains which they were never designed nor intended for. Ball bearings in the wheels, for instance, would not stand up very long under the pounding of uneven rail ends, nor would any hardened bearings.

INCREASING THE COMPRESSION.

Editor THE AUTOMOBILE:

[1,845.]—In case it is desirable to increase the compression in a cylinder, is it practicable to do so without recasting the whole cylinder? I refer to two cycle engines where it would be impossible to use plates on top of the piston. If you will give me the details of the best method to accomplish this result, I would appreciate it.

New York City.

INCREASE.

There are four ways in which the compression of a two-cycle engine can be changed, and there seems to be some drawback to the use of nearly all of them. In case your engine has a separate cylinder head, held on by bolts, the upper part of the combustion chamber of this can be "fattened up" with some form of plate or any other means which will decrease the size of the chamber. In case your cylinders are not so made, this process will not be an easy one.

Then the second method could be tried. In case the cylinder casting is bolted to the crankcase, take the cylinder to a machine shop and have an ⅛ inch or the desired amount turned off of the lower face.

In place of this you can get a new connecting rod with the hole for the piston pin raised above the height of the present one by the desired ⅛ inch, that is, get a rod ⅛ inch longer.

The last resort will be a new piston with the hole for the piston pin bored lower than standard by the amount desired.

The only drawback to the first method is the work connected with it, particularly to do a nice job. In the case of the last three, however, the changes all alter the action of the piston in uncovering the ports in the cylinder walls, and with it the action of the cycle. That is, the piston would not uncover the inlet and exhaust ports at the same time in the stroke as at present, and possibly might not uncover them at all. This alteration of the cycle would probably eliminate some, if not all, of the power of the engine, and in any case would alter it greatly.

Summing up the advantages and disadvantages, unless your engine is so constructed as to allow of readily decreasing the combustion chamber volume as per the first method, it would not be advisable to try to change it. In any case, confer with the manufacturer before going ahead.

PROPER VALVE TIMING.

Editor THE AUTOMOBILE:

[1,846.]—Will you please give me some idea of the proper valve timing? My engine does not run very well and I am thinking of changing the valve setting.

R. B. JOY.

Buffalo, N. Y.

In an article in THE AUTOMOBILE, October 29, 1908, the subject of valve timing was exhaustively treated. In that article figures were given for a number of prominent French engines. The average valve timing for the 31 engines was as follows: Inlet opens 8° 6' past the upper center, inlet closes 26° 15' past the lower center, exhaust opens 46° 20' before the lower dead center and closes 5° 40' beyond the upper center.

You do not mention what your trouble is or we might be able to offer some advice. In any case it is not advisable to tinker with as important a matter as this without first consulting the manufacturer. It is barely possible that your camshaft has been put in place one tooth out of the correct position. This would effect the whole cycle very materially, so it would be advisable to look at the gears and see if they are not marked at the point of correct meshing.

FLAT VALVES AND SPEED.

Editor THE AUTOMOBILE:

[1,847.]—Will you please answer the following questions in your "Letters" columns:

(1) When and by whom were the following originated: transmission on the rear axle, underslung frame, valves in the head.

(2) What American cars use flat seated valves.

(3) Did an eight-cylinder motor cycle ever do 120 miles per hour as has been claimed?

St. Paul, Minn.

L. G.

It would be a hard matter to give an exact answer to all of your questions, thus it is impossible to say who was the originator of all automobile parts. De Dion was one of the very early users of transmission placed on the rear axle, this being in 1899. Valves in the head were first used by Diesel. We do not know who first used the underslung frame.

(2) Locomobile uses flat-seated valves for the inlet on the 40-horsepower car. Hewitt also uses them on his trucks. The manufacturers of the Jencick motors, employed mostly in motor boats, use flat seats. These are about all of the American cars using them. This type is more favored on the other side, as in England, James & Browne, Humber, Brush, Wilson-Pilcher, and some of the Napier output are so equipped. Fiat is a prominent advocate of this construction.

(3) We have never heard of this claim nor of any speed trials or races which would substantiate it. In "The Automobile" for February 25, 1909, you will find the following, relative to motor cycle time: "The fastest time recorded as having been

made on a motor cycle is that of a mile in 44 $\frac{2}{5}$ seconds, a speed of 81.08 miles per hour, by William Wray on an imported Peugeot machine. This is not recognized by the F. A. M. as a record, because the engine was rated at 14 horsepower. The record for a straightaway is 46 $\frac{2}{5}$ seconds, a speed of 77.58 miles per hour, made by G. H. Curtiss, on a Curtiss. The circular track record is 54 seconds, a speed of 66.66 miles per hour, held by Fred Huyck, riding an Indian." As a speed of 120 miles per hour would mean a single mile in 30 seconds, you can see thus far it has not even been closely approached.

WANTS TO DYE.

Editor THE AUTOMOBILE:

[1,848.]—Will you please tell me what to use to color a canvas top black, something that will not fade and will stand weather conditions. S. L. D.

High Point, N. C.

The best substance to use is boiled oil, which you can obtain anywhere. This is applied with a brush or in any handy manner. To color this, add the color pigment until the desired shade is obtained, stirring the mixture very thoroughly. Apply this to the top in a series of coats, the first of pure oil only, the others of pure oil or the colored mixture, as desired. These should bear some relation to the number of coats which you wish to put on. Any number may be used, but beyond four the total coating becomes rather thick and therefore more liable to crack. Up to four, however, you are safe, and this number will shed water perfectly. With four coats, only the last needs to be colored, that is three coats of oil and a final coat of colored oil. If you have no fear of cracking, you can use as many coats as you desire to, the waterproofing effect increasing with the increase in the number of coats.

PECULIAR MISFIRING.

Editor THE AUTOMOBILE:

[1,849.]—Will you please explain to me the cause of my engine missing? It is a four-cylinder machine of a popular make and not over two years old. The valves have all been ground in very recently and the seats are O. K., the plugs have been carefully examined and are also all right, the cylinders all fire and apparently fire in proper order and at the proper time. Yet in spite of all this the engine misses, particularly at high speeds. On low speeds and at starting it runs fine as well as anyone should ask, but as soon as I speed up it begins to miss. Rochester, N. Y. X. Y. Z.

Your trouble is apparently in a sticking valve stem or stems. Take out the valves one at a time, and see if the stems have become gummed with oil. In fact, if this is the only trouble, it will not be necessary to take them out, but just squirt kerosene on the stems. In case it is not a matter of gumming, you will have to ascertain if the stems are straight. You can do this by rolling the stem portion on a surface plate, when any deviation from a straight and true shape will show itself. The valve stem may be out of round, which the rolling process will also disclose. Having correct-

ed these sources of trouble, if the engine does not run as it should, look to the valve guides in the cylinder. They must not only be clean, straight and round, but at right angles to the plane of the seat.

The trouble of missing with correct ignition and tight valves is made apparent in the missing at high speeds. If the valve sticks, a sufficient charge will be drawn in, but the valve will not close, due to some of the causes we have mentioned, and the compression stroke will blow the charge out again. At slow speeds, the valve spring has a measurable time in which to act, so the effect is less, but as the motor speeds up this time becomes less and less, so the final result is that the whole charge is blown out or such a large proportion of it that there is not enough left to ignite. As a result, the engine misses, and will continue to miss until the valve stems have been properly attended to.

WANTS TO MAKE GASOLINE.

Editor THE AUTOMOBILE:

[1,850.]—Will you please tell me what apparatus is necessary and what will be the process for making gasoline from natural gas? Would such a process be liable to be commercially successful? H. McGREGOR. Harper's Ferry, W. Va.

Going into the chemistry of the matter, we find that natural gas, like many of our other fuels, is a compound, the principal constituents being hydrocarbons. These are themselves compounds, and are grouped broadly into two classes, the paraffins and the olefines. If a heavy hydrocarbon of the paraffin series be exposed to heat while under pressure it will be decomposed into a lower hydrocarbon and an olefine.

For instance $C_{12}H_{26}$ is decomposed into hexane C_6H_{14} and the olefine, hexylene, C_6H_{12} . In a similar manner, the reaction may be continued until the highest member of the series and the most desirable from a fuel standpoint, methane, CH_4 , is obtained. The normal composition of natural gas is such that 93 per cent. of it is hydrocarbon. Gasoline being a hydrocarbon it

is possible by means of heat and pressure suitably applied to produce it as the ultimate result. It is possible, but not very probable, and the whole matter should be looked upon rather in the light of a laboratory "stunt" than of any practical value.

The same line of reasoning has been applied to the production of alcohol from natural gas, this being given the preference over gasoline, for the reason that the present market price of alcohol is about twice that of gasoline, and thus there is a chance of the process being commercially successful.

MORE ABOUT TOWING CONTESTS.

Editor THE AUTOMOBILE:

[1,851.]—In the April 1 issue of "The Automobile," in Letters Interesting and Instructive, H. M. Conroy asks: "Wherein would the motor be tested, in a coasting contest with the clutch disengaged." It would not, and that is one of the things to be desired. Many a good motor is badly abused by having to propel a lot of junk. Most every rig has one or more places where power is being wasted, and the motor gets the blame. A dragging brake band causes overheating. Does the user fix the band? No! He gets a larger pump or gears the fan faster or puts on more radiator. He does not know any better. The coasting or towing contest would tell him better. It is true that there are tricks to all contests and that a contest proves little or nothing. But there is just as much trickery about a contest up hill as there can be about one down hill. If the honor of the contestants cannot be trusted (I believe it usually can be) then appoint investigating committees who will see that the rigs are in operative condition. Or put the winning rigs through a road test immediately after winning.

I have for years believed that every owner should know about how much it takes to move his rig on the garage floor. Either he should have a spring balance handy and tow it or he should push it often enough to know when it is pushing freely, and when there is something wrong that needs looking into.

I send photo showing a Buggyaut being towed. I have rigged on this a large scale so that the actual pull can be easily photographed. A cycle air tube forms the spring. A standard spring scale is also used to be certain the results are correct. Such a large scale could be easily used in a towing contest, and the public could see the actual pull for themselves. An asphalt street, and no wind, is all that is needed. These tests ought to be very common. They would add a lot to the improvement of the auto.

Mr. C.'s suggestion that a flexible motor is much to be desired is certainly correct. This can be gotten at by taking the slowest high speed on a hill and the fastest high speed time of the same rig.

CHARLES E. DURYEA.

Reading, Pa.

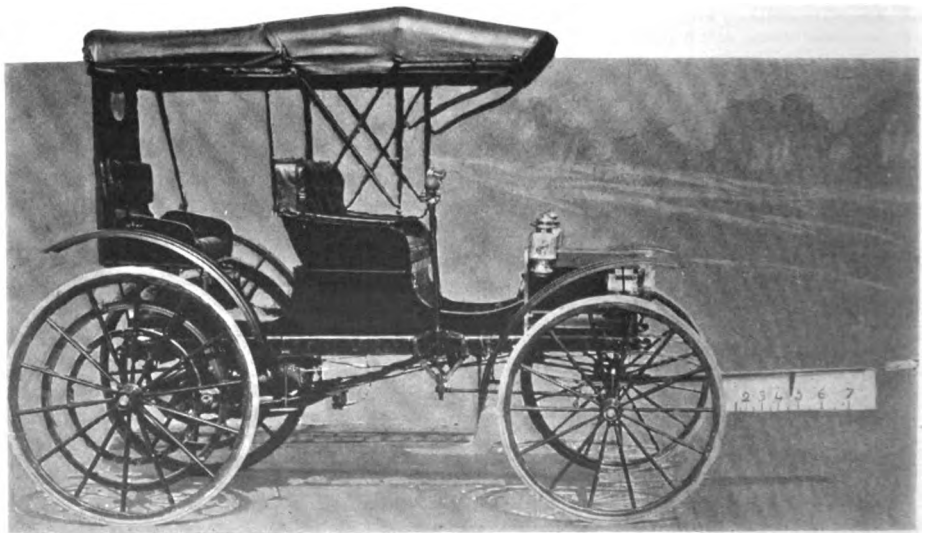

Duryea Car Rigged with a Spring Balance to Measure the Pull Required to Move It.

CONCERNING AIR-COOLING AS OPPOSED TO WATER-COOLING

BY ARTHUR HOLMES, FIRST ASSISTANT ENGINEER H. H. FRANKLIN MFG. CO.

IN THE AUTOMOBILE, March 18, appeared "Automobile Cooling Systems Analyzed," by Morris A. Hall, relative to the comparative efficiencies of air-cooled and water-cooled automobile motors. In this occurred several statements, evidently made without sufficient reflection.

After giving the reasons for cooling the cylinder walls of an internal-combustion motor—which, by the way, are undoubtedly correct—he quotes from the Franklin catalog relative to the cylinder wall temperature at which a gasoline motor does its best work. He then goes on to say that this temperature is entirely too high because, although he admits the thermal efficiency at such a temperature is indeed very high, the mechanical efficiency would be lowered correspondingly so that the net result or B.H.P. would remain the same.

Mr. Hall right here lays himself open to very serious criticism, for he forgets that it is the practically universal custom to compare the performances of gasoline engines by B.H.P. This, of course, takes into account the mechanical efficiency. For instance, suppose we had two engines of identically the same bore and stroke, the general design of bearings, etc., the same, one of these engines, however, being water-cooled and the other air-cooled. Suppose, then, these two engines were put on the block and tests for economy were run off. Inasmuch as it is impossible at the present date to accurately indicate the horsepower of a high-speed gas engine, it would be necessary to base these economy tests on the B.H.P. delivered by each motor.

Mr. Hall in his article makes use of a heat balance taken from a well-known authority (we think we have seen it in Dugald Clerk's book, "The Gas and Oil Engine"), in which the I.H.P. is given as 17 per cent. of the total heat units contained in the fuel. This is undoubtedly a very good example of what a water-cooled motor should do, and from the present writer's experience the B.H.P. seldom attains this figure.

We are safe, then, in assuming that the water-cooled motor which we are testing would do no better. On the other hand, however, the air-cooled motor would develop its power with an efficiency, calculated in the same way, of 19½ per cent. This can be verified by the authorities at Sibley College, Cornell University, under whose direction many such tests have been run off on a Franklin motor in the laboratory of that institution. This would mean that if these motors of the same horsepower were put into two identical cars and run over identically the same roads in the same way, the water-cooled car would use 14.1 per cent. more gasoline than the air-cooled car. Of course, it would be impossible to put these two engines in exactly the same cars, for Mr. Hall says "the more bulky, assuredly heavier, and admittedly more complicated fluid systems with positive circulation."

We have proved to ourselves and others, by such tests, that air-cooling does raise the heat efficiency based on the B.H.P., regardless of whether this rise is due to a great rise in thermal efficiency proper, accompanied by a smaller loss in mechanical efficiency, or by not quite so great a rise in thermal efficiency and no change in mechanical efficiency.

The mechanical efficiency is, of course, the ratio of the power delivered by and outside of the engine to the power developed inside the cylinders. This term is made necessary because of the fact that some of the power developed inside the cylinder is lost as far as useful work is concerned, in friction, due to the pistons working in the cylinders, the connecting rod and crankshaft bearings, the camshaft gearing, etc. In fact, wherever any mechanical motion occurs power is lost, due to friction. It is with this loss in friction in the engine parts which we have now to do. As Mr. Hall says, one of the chief reasons for cooling cylinder walls is to insure proper lubrication; he might very well have said, then, as far as lubrication is concerned it is unnecessary to cool the cylinders as long as they are perfectly lubricated. In other words, cooling, from a lubrication point of

view, is merely a relative term depending entirely upon the nature of the lubricant.

We have no tests at hand showing the friction losses in motors running perfectly cool and others running at the temperatures attained by air-cooled motors, nor do we know any; but we do know that in general the friction generated between two surfaces is dependent upon their lubrication, and not upon temperature.

Quoting from Unwin, an efficient lubricant should possess the following qualities:

- (a) It should wet the rubbing surfaces.
- (b) It must not evaporate or decompose while in use.
- (c) At the temperature at which it is employed it should have enough, and only enough, viscosity to remain between the surfaces.
- (d) It must contain no acids or other constituents capable of acting on the rubbing surfaces.
- (e) It must be free from grit or other foreign matter.

From the above it can readily be seen that the only qualification having any bearing on the case in question is that the lubricant should be correct for the temperature at which it is used. Now there are many lubricants which can stand a temperature of 350°, so the lubrication question is very easily solved. In fact, it is far easier than in many cases in so-called ordinary steam engineering which may have escaped Mr. Hall's attention. We refer now to engines using superheated steam or even high-pressure steam, in which case the cylinders are often jacketed by steam at a pressure of 200 pounds or so. In this latter case this means a temperature of approximately 375°.

Quoting Unwin, again: "With ordinary superheated steam, superheated about 100° or 150° F., the only care necessary is to use an oil which stands a high temperature, and various universal oils, some of them distilled or charcoal filtered, are available. The flash points of such oils are from 500° to 700° F." It would seem from this that long years ago the question of high temperatures in cylinder walls had received a great deal of attention, and that it had not scared engineers to any great extent. At any rate, we still hear of superheat and high-pressure steam and we also hear very little or nothing about loss of mechanical efficiency due to using high-pressure or superheated steam.

In his article Mr. Hall makes the statement that a tight, or even close-fitting, piston cannot be used in an air-cooled engine. If he means by this that when the cylinder and piston are cold the piston diameter is less than the bore of the cylinder by several thousandths more than would be the case with a water-cooled engine, he is probably correct. Mr. Hall goes on to say that "from this it is at once apparent that the mechanical efficiency is very low indeed." This is the first time we have ever seen a tight piston advocated over a loose one for the purpose of increasing mechanical efficiency. But he should remember, of course, that nobody knows exactly what clearance there is between piston and cylinder when the motor is warmed up to its working point. He should remember also that this clearance is the important one. Now what indicates that the lower limit of clearance has been reached is that the piston will seize or stick to the cylinder walls when the motor reaches its working temperature, even when the motor is flooded with oil. On the other hand, generally speaking, the fact that the upper limit has been reached will manifest itself in a slap or knock. It will be admitted by most engineers that the proper clearance is the least which will allow the piston to work freely in the cylinder under the hottest working condition. The reason for keeping this clearance as small as possible is to prevent, for some time at least, the ill effects due to the inevitable wear which will eventually occur.

Now, then, what is the obvious and scientific way of solving this problem? We solved it by taking a standard motor and equipping it first with a set of pistons which we felt sure, because of their great clearance, would slap. A hard road test showed that they did. These pistons were then removed and

larger ones by a couple of thousandths substituted and the same routine gone through. This process was continued until the slap disappeared. We then had found our upper limit of clearance. From here the process was continued, until finally the clearance became so small that there was a perceptible drag in the motor

and then seizure occurred. We had thus found the lower limit of clearance. Observations taken all during these tests gave indisputable evidence as to what was the best clearance to use, or, to be more exact, what was the proper size piston for that size cylinder. Could anything be simpler or more accurate?

A. L. A. M. STANDARDIZATION ACCOMPLISHMENTS

FROM COKER F. CLARKSON ON THE SUBJECT.

Editor THE AUTOMOBILE:

It is hard to account for the reply given to H. A. Morris, on page 583 of the April 8 issue, in answer to the inquiry as to what the Association of Licensed Automobile Manufacturers has done in the way of standardization of parts.

It is well known that during recent years the A. L. A. M. has annually compiled for its members new specifications for the various materials used in automobile parts, resulting in the use by its members of stronger and more elastic metals. The result of this is seen in what the association cars have done in ordinary touring service and in contests.

The engineers and master mechanics of the association members have been quick to draw their accurate and logical conclusion from the data on various engineering subjects, jointly and severally submitted and discussed at their periodical meetings during recent years. These men are as able and progressive as any body of men in the world, and any statement tending to belittle their work can only reflect on the man who makes it. The generously given and effective co-operative work of these men has probably never been surpassed. At any rate, it has been characterized by many well qualified to judge as unique and without parallel.

As to standardization, it must be remembered that, fundamentally, standards are not spontaneous products, but what is indicated as best in long practice, and it is reasonable to assume can be used by the average manufacturer, both in the line of suitability primarily and as related to best practice. The adoption and promulgation three years ago of the A. L. A. M. screw standard was an event which indicates as well as anything else the competency of the association engineers to take the responsibility of passing alone and unaided upon a broad engineering subject. There has been a demand for at least forty years for a fine pitch screw standard. The matter not only lay dormant but was becoming more complicated every day because various kinds of machinery subject in use to great vibration demanded a thread of relatively fine pitch compared to that laid down in the old United States standard, and various more or less used fine pitch screw threads sprang up. There was also a long-continued unsatisfied demand for a properly designed castle nut. Incidentally the progress of automobile construction required stronger and tougher material, allowing less weight and neater appearance of screw for a given piece of work.

The A. L. A. M. has been absolutely the protagonist of this standard. It issues the only official edition of it and has carried on the mass of consequent communications with people in various lines of business throughout the world as to the details of it—such as matters of master gages, source of supply of both raw and finished material, taps and dies, and the best practice in drill sizes, etc. This screw standard met a crying want and has been an unqualified success. The propriety of its increasingly occupying its field must be more and more recognized.

The statement that the A. L. A. M. standard spark plug shell is different from all previous sizes is absolutely wrong. The A. L. A. M. standard spark plug has been as successful as the screw standard. Primarily it is what has been for some years known in the trade—since the start of the industry practically—as the Autocar plug.

Standardization is a word which carries a note of joy to the heart of every mechanic and every engineer; has been a long-cherished dream of the motoring fraternity; expounded as a doctrine; taught as a theory; discussed as a possibility, and advertised as an accomplishment ever since the automobile industry began to take shape as such. It is obvious that in this sense standardization may be a hobby. It is equally obvious that the A. L. A. M. engineers deserve credit for what they have had the sense not to standardize, as well as for the positive creative standards brought about.

It is easy to say, and it has been said for years, that control should be standardized, but it is not easy and it has not yet been considered feasible to do so, owing to the viewpoint of the different manufacturers as each in his light sees the demands of the public. To-day some people believe that for the high gear the change speed lever should be in one position; others are confident that it should be in another. Such features of construction as spark and throttle levers, axles and wheels, must of necessity be bolted down by time to the best practice. They are purely matters of design and preference, and distinct from the subject matter of a standard dealing

with ratios or measurements after one design or form of a part has been practically universally accepted.

The function of standardization is in reducing the cost of and facilitating production, which is made possible by the fact that standardized parts, or tools with which they are made, are kept in stock at low prices relatively; and in the less cost and time involved in the replacement of parts by repairmen and users.

ASS'N OF LICENSED AUTOMOBILE MFRS.,
New York City. COKER F. CLARKSON.

E. T. BIRDSALL ON STANDARDIZING.

Editor THE AUTOMOBILE:

I desire to take issue with you on the answer to letter No. 1,820, April 8. In that answer it is stated that the mechanical branch of the A. L. A. M. has only made a small start towards standardization of automobile parts. If all the screws, bolts, nuts, yoke and rod ends, levers, spark plugs, and Q. D. rims on a car constitute a small part, then my idea of proportion and that of your writer's are far apart.

The yoke and rod ends were not standardized for the purpose of getting lower prices on forgings, but to get parts that were correctly designed for their work, and of such sizes as were needed in automobile construction. If I remember rightly, the price of these improved forgings is slightly higher than the old ones. They are designed with correct proportions as to bearing surfaces, wearing surfaces and range of adjustment, and are the result of months of work on the part of most of the best designers in the country, as well as parts manufacturers. The new standard screw threads which your writer passes over so airily were necessary, as there was no standard that was consistent or suited to the requirements. The new standard is the result of many conferences between the automobile engineers and such firms as Brown & Sharpe, Pratt & Whitney and several large screw and tap and die-making firms. That the standard is good, is right, and is used by many of the best car-building concerns would seem to refute the printed statement that "this is really a complication."

The standard spark plug did not create any trouble that the writer is aware of, as he has had no difficulty in getting them from any maker of plugs. It did not differ from all others, as the Autocar Company has been using this size of plug and pitch of thread for the entire term of its existence. If it is not good, what other size is better? What other size is standard? Who else has done anything to establish a standard? The other association and the S. A. E. have not been heard from.

After over two years' work in reconciling the various trade interests involved and many costly experiments, a standard Q. D. rim was adopted which will be much in evidence in 1910, as the rolls and other tools could not be made ready for the 1909 cars. A very complete set of levers has been designed by the engineers of the mechanical branch with the help and advice of the principal makers of drop forgings. These will also be out in 1910.

If you think it is an easy matter to standardize wheels and axles, just write to all the makers and see what they think of it. One hundred answers will produce one hundred designs that one hundred designers know to be the only design fit to be used under a car. The same applies to frames, springs, control parts, size of seats, etc., ad infinitum. Where is the standard carbureter? It will arrive on the same train as the standard axles and wheels, et al.

When all men look alike and act alike, then all cars will have the same method of control and not before. The mechanical branch attempted to standardize some other parts, but the difficulties to be surmounted and the conflicting opinions of what was right or wrong were so diverse that the task was abandoned as hopeless, at least for the present. The engine rating formula which you approve the branch considers as its poorest work, as it is admittedly an arbitrary makeshift.

At the time, the standardization of the bolts and nuts seemed like a "real big problem," but I see now that we are making a mountain out of a mole hill and should have started on something "real big" like the body or the engine. I am no longer connected in any way with the A. L. A. M., but like to see credit given for useful and conscientious work.

E. T. BIRDSALL, M.E.
New York City.

Auto-Making Within a Hundred Miles of Philadelphia

W. McKean White

PHILADELPHIA, April 19.—Southeastern Pennsylvania, famous as the location of many great industries, is now one of the busiest automobile manufacturing sections of the country. Within a radius of 100 miles of Philadelphia there are seven concerns of note working up to capacity to produce cars to supply orders received from all over the country. The estimated aggregate output of these concerns will be between 3,500 and 4,000 automobiles, and the hum of the machine shops and the erecting departments is indicative of the prosperous conditions generally throughout the automobile making and selling world.

Night and day work has been found necessary in some instances to keep the output approximately at the point of the demand. All types of cars are being constructed, from two to six cylinders, both for pleasure and for business purposes, and in addition to those companies confining their attention to the building of automobiles, there are numerous factories with products allied to those of the automobile, which have shared generously in the general improvement of business.

The York Motor Car Company and the Hart-Kraft Motor Company, at York; the Autocar Company, at Ardmore; the Chadwick Engineering Works, at Pottstown; the Acme Motor Car Company and the Middleby Auto Company, at Reading; and the Pennsylvania Auto Motor Works, at Bryn Mawr, are the ones which contribute to the welfare of the industry at large from the southeastern part of the Keystone State.

An important situation in Pennsylvania in connection with the building of cars which has given the manufacturers much satisfaction is the urgent demand for automobiles among farmers of that wealthy agricultural section of the State. It is no longer a strange sight to see a family of quaint-clad Mennonites, Dunkards or Ammish going to church or to town in a high-priced touring car.

With the 1909 output generally allotted, and under way through the factories, several of the Pennsylvania firms are actively laying plans for the 1910 season. One firm hopes to have its entire 1909 product completed by the middle of July, another by the middle of August, still another will have two new models for sale within the present month, while a fourth is making no plans for changing its present style and will continue to build the same cars throughout fall and winter.

THE PULLMANS PRODUCED IN YORK.

YORK, PA., April 19.—Working 22 1-2 hours of the 24, the York Motor Car Company, under the immediate direction of James A. Kline, general manager, is intent on the production of between 550 and 600 automobiles for the 1909 season. With nearly five hundred employees, an enlarged factory, new machine tools and

everything favorable to securing maximum productive conditions, the firm is still behind its orders, and is at present endeavoring to overhaul the demand with an immediate supply. There are four sizes of Pullman chassis built, and these are equipped with seven types of open bodies. Only one model now can be delivered as soon as ordered, and that is the smallest one, a car of 20-horsepower. Mr. Kline, in going through the big plant, speaking of the circumstances which have required the use of the factory by night as well as day, said:

"We have greatly enlarged the plant through the addition of new buildings and the renovation of ones which were formerly occupied by the carriage works, so that we now have over 90,000 square feet of floor space. Our machine shops have been given increased facilities through the purchasing of new tools and we absolutely manufacture every part of the Pullman car, buying only the engines, aluminum and other castings and forgings, and the frames. Bodies, wheels, gears, nuts, bolts, shafts and the thousand parts that are necessary to make up a high-grade car are machined right in our own shops and nothing is bought assembled. At present we are shipping from 16 to 18 cars each week, from 45 to 50 a month being the average, so that with those already sent away, our production will total 550 or 600.

"We hope to be through with the 1909 material by the middle of July, and perhaps a little earlier, so that we can start in on cars for the following year. In fact, we expect to start on 1910 work within two weeks, and will begin to take orders for September delivery. I can assure you that there will be very little change, but there will be some few details which will be altered.

"As to contests, it is pretty hard to say just what we will do for we have been too busy to consider the matter very thoroughly. We will enter two cars in the annual endurance run of the Motor Club of Harrisburg, and I presume that we will have Pullmans in more or less track racing."

Of the four models, the medium-priced touring car with the 30-horsepower engine has proven the most popular of the line, and already 202 of the 300 to be built have been shipped. Of the 150 small cars of 20 horsepower, 70 have been sent away and on this model alone can immediate deliveries be made. About 50 four-cylinder cars of 40 horsepower will constitute the output of that size, and 36 of them are in use, while there are still 44 of the 50 six-cylinder cars to be built. Thus of the entire 550 planned in 1908, 314 have been sent away to the 37 agents.

Hart-Kraft Building Commercial Vehicles.

Under the supervision of Granville Hartman, the Hart-Kraft Motor Company is aiding in the solution of the commercial vehicle business by the production of six commercial automobiles a week, and with a standard car, a unit power plant, and

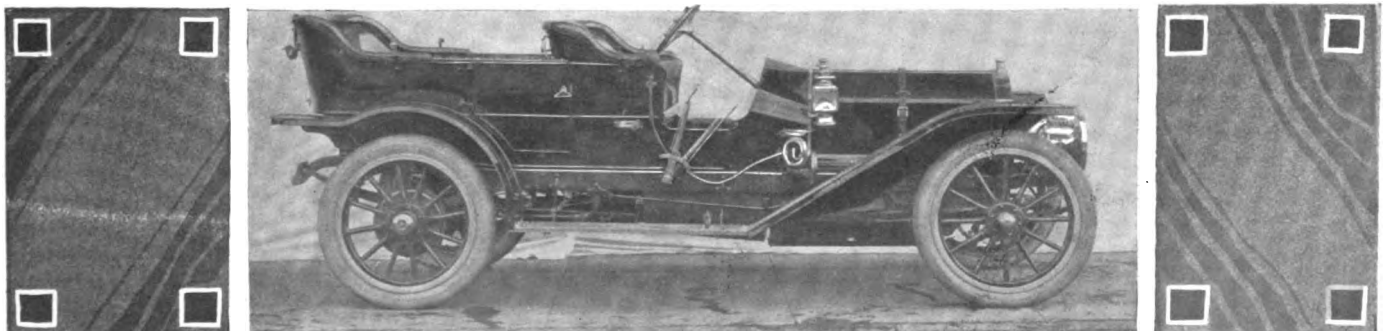

York Motor Car Company Introduces a Toy Tonneau Body for Its Four-Cylinder 40-Horsepower Chassis.

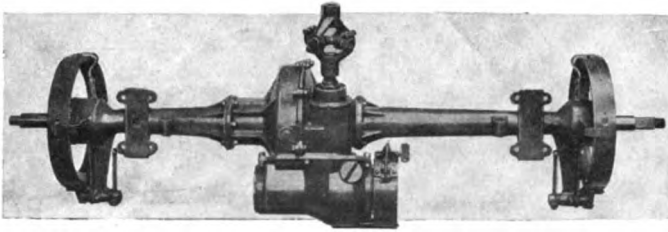

Individuality In Autocar Rear Construction.

simplified control, has found a ready market. The great difficulty of educating users of heavy horse-drawn trucks and delivery wagons has thus been obviated. A large factory has been built by the concern, and with increased facilities the rate of construction will soon be that of from 500 to 700 cars a year.

The Hart-Kraft car is equipped with a two-cylinder, double-opposed engine, developing about 12 horsepower, with a planetary transmission, giving two forward speeds and one reverse, and a double side-chain drive. The engine, transmission, differential casing and countershaft are all in a single unit, and one complete set can be substituted for another in 25 minutes. This is an important detail in commercial work where a delivery service may be handicapped if a car has to stop for a period. The testing of Hart-Kraft cars embodies some interesting features. The power unit, after being machined and assembled in the factory, is put upon a testing stand where it is first "run in" for a day with one sprocket secured so that the differential will be operated. Then it is run under its own power for a day, with its own carbureter, magneto and coil, and connected by its double side chains to a dynamo, where its power and fuel consumption is measured.

From the testing-room the power plant is moved into its chassis and the latter loaded with 600 pounds of sand. As soon as the car is taken out on the country roads it is first limbered up and then is made to climb backward up a steep hill, three-quarters of a mile long. Inasmuch as a commercial vehicle must do a great deal of reverse work in service, this test is altogether practical.

COMMERCIAL AND PLEASURE AUTOCARS.

ARDMORE, PA., April 20.—By combining the features of a commercial vehicle so that with the simple exchange of bodies it can be used as a pleasure car, the Autocar Company this year has had more business than it could accomplish with only day work in its large plant. In addition to this type of utility car, the company now has a line of four-cylinder, medium-priced touring cars which has proven equally popular. According to the president, David S. Ludlam, the outlook for the Autocar Company is one of the brightest in the life of the 12-year-old concern.

The plans for this year had called for the manufacture of 175 utility car chassis, which can be used for commercial work entirely, as delivery vehicles, taxicabs, town cars, or cabs, or with special bodies for any use, with two-cylinder engines of standard Autocar design. The reception accorded used up the first shop

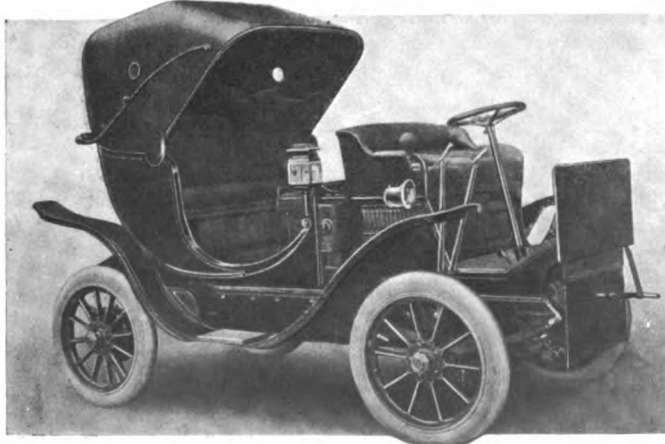

Two-Cylinder Autocar with Victoria Body.

order, and 400 more of these machines will be started in July. This will carry the factory to the first of next year. In the meantime the entire force is concentrating its attention on the building of the four-cylinder car which made its debut at the Garden show. Eighteen are constructed every week, and the entire number will be 400. It is expected that by working day and night the 475 men employed will finish these touring cars by the time the raw material for the second shop order is ready.

The factory of the Autocar Company has always been one of the largest in the country, but it is taxed to its utmost now. Its

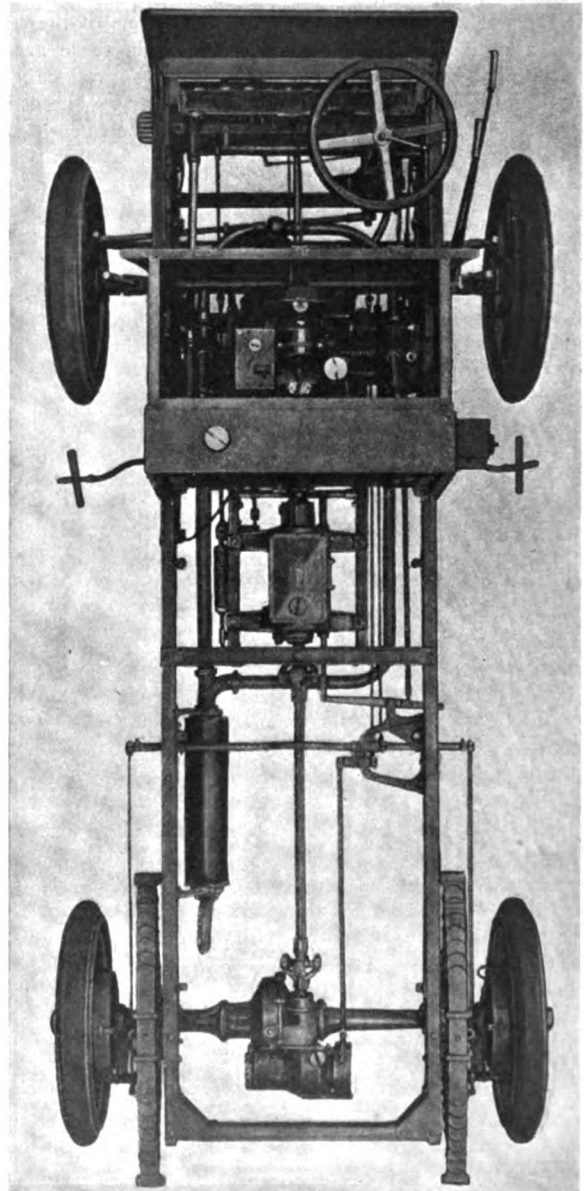

Autocar Company Features a Utility Chassis.

570 machine tools are all in use, and every part of the cars is manufactured in the plant, only castings and forgings being purchased. A great deal of material for the four-cylinder cars is at present being machined, an indication of the number of cars which are constantly being sent away. The two-cylinder chassis is built in two wheelbase sizes, 85 and 97 inches, both with a carrying capacity of 2,000 pounds. The motor is more powerful than that used in the little runabouts which made the Autocar famous, 18 horsepower being developed from the 4-3-4 by 4-1-2 cylinders. Five cars with these motors were built, using surrey bodies, for experimental purposes and may at some time be added to the general line. At present only the officials of the company have them. The touring car has a motor which is rated by the A. L. A. M. at 25.6 horsepower, a three-speed transmis-

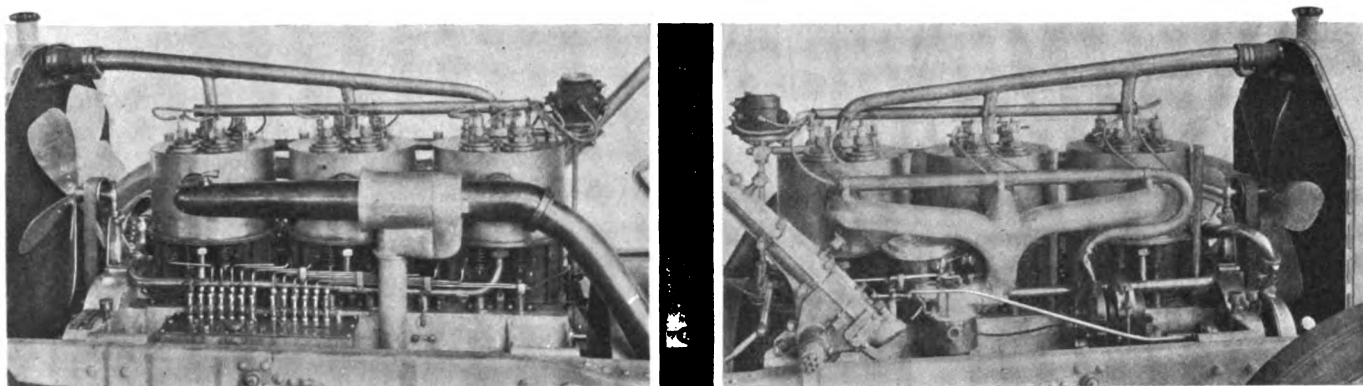

Symmetrical Exhaust and Straightaway Intake Manifolds of the Great Chadwick Six Motor.

sion, a wheelbase of 102 inches and a five-passenger body.

That the Autocar will be well represented in racing and contests this season was shown by the statements of H. M. Coale, the sales manager, who said: "We are going into all contests in our class this summer, and perhaps in some we will compete with larger and more powerful cars. It is our expectation to put a four-cylinder touring car in the endurance run of the Motor Club of Harrisburg, one in the roadability run of the Quaker City Motor Club to Atlantic City, and perhaps we will be able to take part in the run of the latter club to Pittsburg and return. We will have two of the four-cylinder cars in the 24-hour race at Point Breeze or wherever the Quaker City Club decides to hold that event, and will try to repeat our success of last year when the Autocar won."

GREAT CHADWICK SIX BUILT AT POTTSTOWN.

POTTSTOWN, PA., April 20.—In its new, well-lighted and airy factory building the Chadwick Engineering Works is now finishing its first lot of 50 Great Chadwick Six touring cars and roadsters. With a small output of high-priced cars it can afford to send them through at a slower rate than can the makers of the lower-priced product, so that the energy of the entire force will be employed in making and erecting 115 automobiles, 90 of which will be touring cars. The remaining 25 will be roadsters of the type which attracted a great deal of attention at the shows last winter, with the gasoline tank at the rear and exhaust ports at the side, protruding through the hood.

The factory building is just about a year old, and is such as to bring maximum results from the men and machines. The machine shops have already started upon the second order of another 50 cars, as the first order is finished and the last ones will have their bodies placed upon the chassis within two or three weeks. As an evidence of the number of cars which will be manufactured during the spring, L. S. Chadwick, vice-president, general manager and superintendent, points out the amount of raw material being machined or waiting to go through the fin-

ishing processes. Cylinders, crankcases, transmissions, chain cases and smaller parts are taken in the unfinished state.

Four cars a week are being finished, using both a day and night shift of employees, and this rate can be increased when necessary. At present the concern can promise deliveries in three weeks at Pottstown, and has found the spring season opening up with a bound. Within a couple of weeks the output will be pushed up to one a day, six a week, so that the output can be completed by the first of August. There has been little change contemplated for a 1910 product, inasmuch as those which have been embodied in the present car give it about 35 per cent. more power than formerly, a higher-speed motor, valves held open longer and lifted higher, and a new carbureter contributing toward this. Both Mr. Chadwick and H. B. Larzalere, the sales manager, impress upon those who talk of the Chadwick that the present stock car is a duplicate of the car which won hill-climbs so generally and made fame for itself in the Vanderbilt race last year.

Mr. Larzalere summed up the plans for the selling season and the contesting by saying: "Our agencies have been keeping us busy in trying to give them cars for early delivery, and we fully expect that the orders now in hand for spring delivery and those which will continue to come will make us work as hard as possible. We have 20 cars now waiting for their bodies, and these will all be shipped within a few days.

"Len Zengle, who has been with the Pennsylvania Auto Motor Works, will join our forces on Monday and will probably handle our cars in hill-climbs and speed contests. Just what we will enter, however, has not been decided, for we have been waiting for the various rules to be thoroughly discussed and decided upon. We would like to enter the Cobe stock-car race if the conditions are favorable, and this is true also of the Fairmount Park, the 24-hour races in New York, for we believe in racing. We will, of course, defend our record on Giant's Despair, at Wilkes-Barre, and if Chattanooga were not so far away it is probable that we would take a trial on Lookout Mountain.

"The progress in the factory has been especially pleasing to us, for we have been rushed and still able to turn out cars under

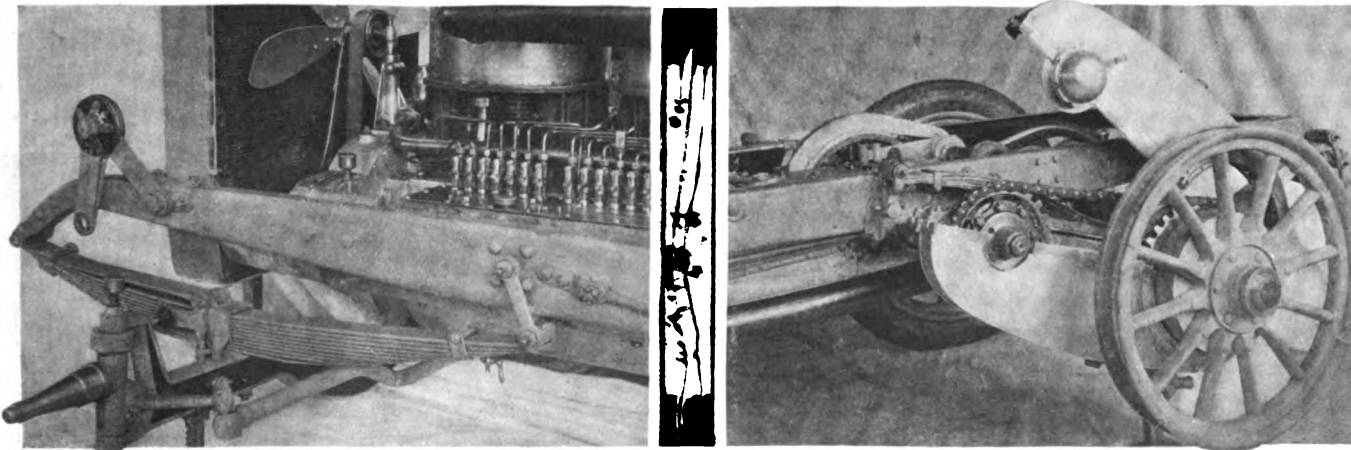

Chadwick Constructive Details Seen in Front Spring and Axle, and Chain Case Assembly.

high pressure. We are using the whole factory building: the first floor for offices and assembling, the upper ones for machining, and motor and transmission assembling, and chassis erecting, and in the basement we have our stockroom and inspectors. Every part that goes into the car is inspected by three different men before it is allowed to pass, and very often Mr. Chadwick himself takes part in this on the most essential parts."

ACME AND MIDDLEBY REPRESENT READING.

READING, PA., April 21.—This city is represented in automobile manufacturing circles by two concerns, the Acme Motor Car Company and the Middleby Auto Company, building two entirely different types of cars, the former water- and the latter air-cooled. The Acme company is engaged in turning out from two to three cars a week, its estimated product for the year, according to President H. M. Sternberg, being 125 cars. These will be divided among four chassis types, the best known of which is the six-cylinder car and a four-cylinder one of 40 horsepower. The two other models are a four-cylinder touring car or roadster of 32 horsepower and a larger "Sextuplet" of 60 horsepower.

The Acme factory, which is a large one, four stories in height, is utilized in making the cars completely under one roof, nearly the whole operation, from receiving the rough castings and other materials, to the shipping of the handsome automobiles being done by the Acme mechanics. Machine work, assembling, erecting, upholstering, radiator making, and many other details of construction being attended to by the factory itself. It is but another instance of complete manufacture and the trend away from the former practice of buying parts from various concerns and then putting them together.

As to racing, a subject in which all of the manufacturers are more than ordinarily interested, Mr. Sternberg said: "We now have 120 men working in our factory, with a shift on in the evenings, and if we keep as busy throughout the spring we will have little or no time to think about racing. We have had our racing car, the one used in the Vanderbilt and Grand Prize races, overhauled and will assemble it in about 10 days. We would like to take part in some of the events on the Indianapolis speedway and perhaps at Philadelphia, in the Fairmount Park race, for we won second place in that last year. If the conditions are such that we can enter at Chicago for the Cobe race, it is possible that our sextuplet may be purchased by a Chicago autoist and entered by him. We do not expect to take any part in endurance contests, but we may be in the 24-hour races in New York."

The Middleby company, presided over by J. Middleby, Jr., has taken hold of the old Duryea plant, and with new machine tools and certain improvements has established one of the busiest small automobile factories in the country. The history of it is interesting, as showing the public demand for a car of the type which it is producing, at the rate of six or seven a week. Mr. Middleby took hold of the buildings, equipped them with the latest machinery, turret lathes, shapers, grinders, drill presses, etc., and put the first car, a four-cylinder, air-cooled one of 25 horsepower, on the roads on August 2, 1908. No agencies were established until November, and chassis No. 213 was put upon its erecting frame to-day, with the cars turned out in numerical order. A seasonal output of about 400 automobiles has been predicted.

PENNSYLVANIA ACTIVE AT BRYN MAWR.

BRYN MAWR, PA., April 21.—Concrete construction in automobile factories, tending to lessen vibration and noise, is exemplified by that of the Pennsylvania Auto Motor Works, which builds the Pennsylvania cars. The quietness of the factory, while the regular work progresses, is a feature that instantly attracts attention, for as the machine tools do their work and the assembling and finishing of cars go on, there is not the great amount of deafening noise common in other plants. The Pennsylvania company has but recently completed its new factory, and it now has about 85,000 square feet of floor space. A production of from 750 to 800 cars is planned as the total for the present season, although it is distinctly understood, by those connected with the firm, that the seasons and years are not recognized in the working of the factory. New models may be introduced at any time.

Three models are at present being constructed: a six-cylinder car of 75 horsepower; a four-cylinder car of 50 horsepower, and a four-cylinder car of 25 horsepower. The first and third are new models, while the second is the type which has been made for two years. Two new models will be turned out in about three weeks or a month, and these five constitute the complete line for the present. The new cars will be known as Models B and D6. The former will be a seven-passenger touring car with a four-cylinder engine, 4 7-8 by 5 1-4-inch cylinders, and a wheelbase of 122 inches, to sell for \$3,200; while the six-cylinder car will have cylinders 4 1-4 by 4 1-4 inches in size and a wheelbase of 131 inches, to sell for \$3,500.

R. Harry Croninger, the general manager, speaking of the general conditions at the plant, stated: "It is probable that by June 1 we shall have built 200 of the smallest cars, those selling for \$2,100, with baby-tonneau bodies; 150 of the 50-horsepower cars, which sell for \$3,000, and about 50 of the six-cylinder machines. We build our cars only to order, but the orders have recently been arriving faster than we can ship, and so at present we are 15 cars behind on our six-cylinder type and 30 on the small cars, while on the '50' we are holding our own. We have no piecemeal work, every one of our 250 employees being on salary.

"We intend to go into all of the contests in our class, with three cars: a six and both sizes of fours. It is not planned to use either of the new models for we shall be busy constructing them to order. Gabriel, who is the foreman of the Quinby factory, and who has taken part in a number of European races, will probably handle the 75-horsepower car, but we have not decided who will drive the other two. We will not compete on circular tracks nor enter endurance runs under the present rules, but we will go into speed trials and hill-climbs. What I would like to see is a type of contest which would prove dependability, power and speed and put an end to 'axle fakirs.' I would suggest that there should be an endurance run to Wilkes-Barre, via Reading, with time schedules, intermediate controls, but not a technical examination which would penalize for little things that might happen in touring. At Wilkes-Barre I would have the cars locked up and then on the following day enter the machines in the hill-climb on Giants' Despair according to their various classes and make them climb with the same load carried on the run from Philadelphia. On the third day, the machines would be run to Canandensis, in the Pocono Mountains, where there would be a speed trial, again entering the cars in their classes.

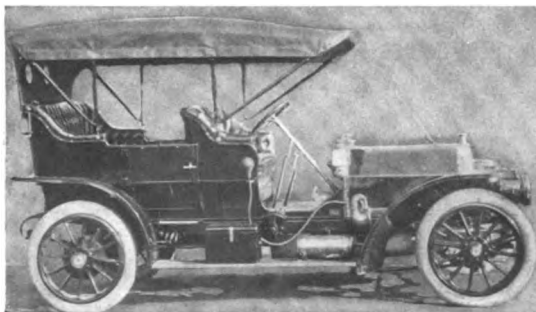

The Smallest Pennsylvania, 25-Horsepower.

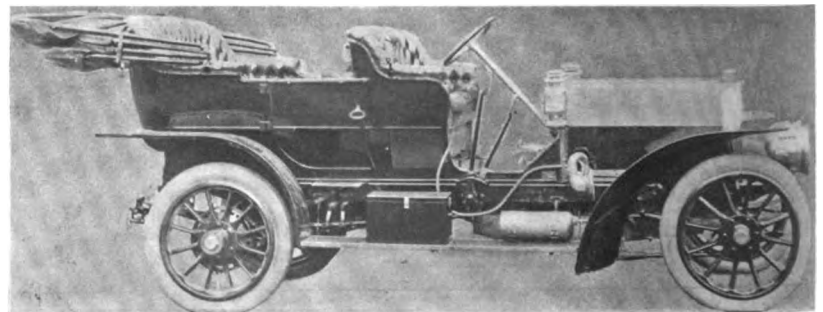

Another of the Pennsylvania Family—50-Horsepower.

About the Matheson Six-Cylinder

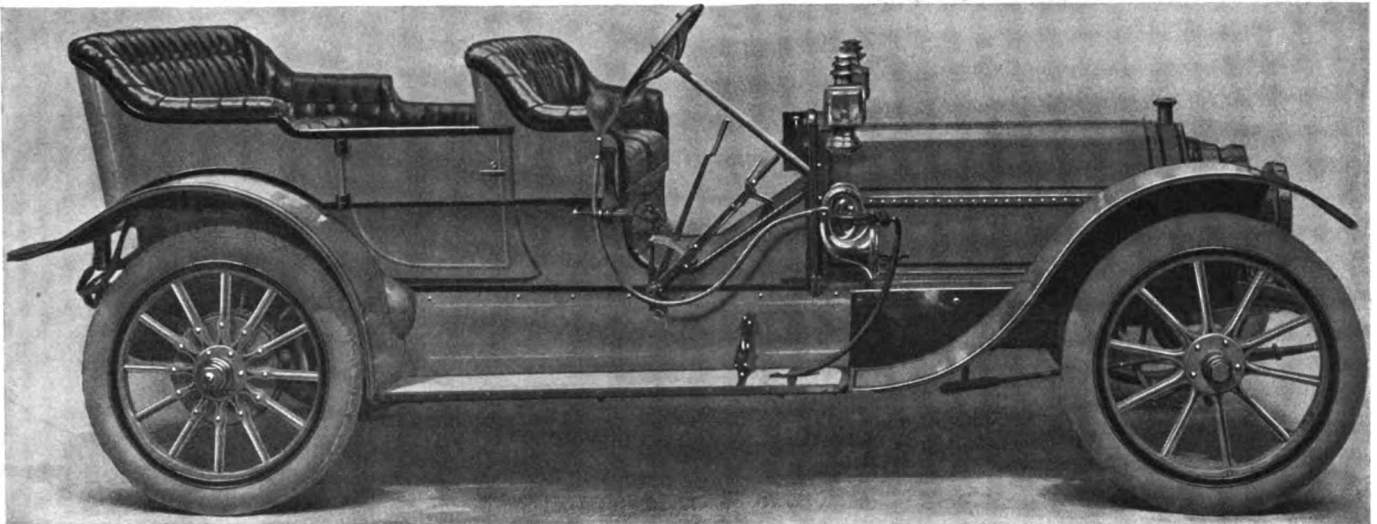

Latest Creation of the Matheson Automobile Company—A Light Six-Cylinder Touring Car of 50-Horsepower.

NEW YORK, April 19.—Matheson "Light Six" is here, with the consequent result that the selling headquarters of the Matheson Automobile Company, 1886-1888 Broadway, has been one of the busiest places in the automobile district during the past few days. The car which has arrived is the first to be delivered since the type made its debut at the shows. Two models were then announced to come from the Wilkes-Barre factory for the 1909 season. The "fours" were then deliverable, and now the "sixes" are being made and shipped in considerable numbers.

A feature construction has been assiduously avoided in the design of the six, although it differs materially from the type of the present four, or of the six-cylinder car which was made two years ago. The changes have been made chiefly in motor- and transmission-gear construction, with their various appliances, but the workmanship is of the same standard and the experimental cars so thoroughly tried on the northeastern Pennsylvania mountains that the deep confidence of the Matheson company is reposed in the latest production of their factory.

Description of the Engine.—The notable feature of the six-cylinder engine is in its valve action, which has been materially changed from previous practice, although in nowise detracting from the latter. The valves, all in the head and at the right side, are operated through depression from overhead beams,

which, in turn, are raised by lifters from a single camshaft in the crankcase on the left side. The valves, 2 3/8 inches in diameter, are all interchangeable, electrically welded to their stems, and have flat faces. The lifter rods have screw adjustments.

The six cylinders are cast in sets, three dual units to each engine, with a bore of 4 1/2 inches and a stroke of 5, rated by the Matheson company at 50 horsepower. They are enameled to give the same clean appearance, as are all cylinders of this make, with the intake manifold on the right side and exhaust on the left. The carbureter is of special design, of the multiple-jet type, which has proven successful on previous models, with a control both from the top of the steering column and from a foot throttle. The crankshaft is offset 3/4 of an inch, running on four bearings, the front one being an annular Hess-Bright ball bearing and the others of plain phosphor bronze.

Lubrication System.—Special attention has been given to the lubrication system for the motor, the rear construction, of course, taking care of itself. Splash in the crankcase is supplemented by a three-lead Lavigne mechanical oiler, situated on the left side, just behind the first crankcase arm, and driven from enclosed gears. The oiler, water pump and magneto are placed in the order named on the left side, and a single shaft with intermediate couplings drives them 1 1/2 times the motor speed. Each

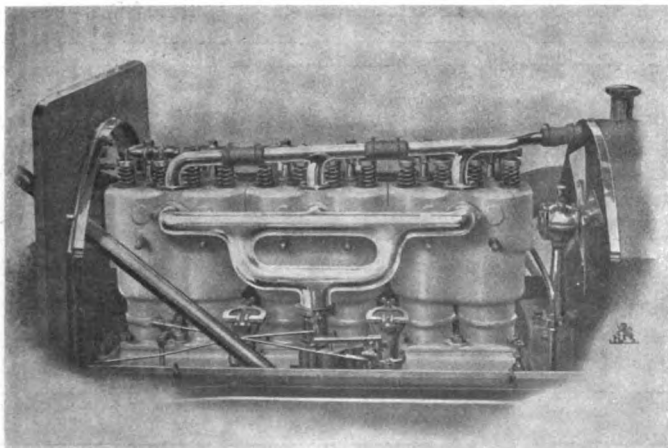

Intake Side of New Motor Showing Carbureter.

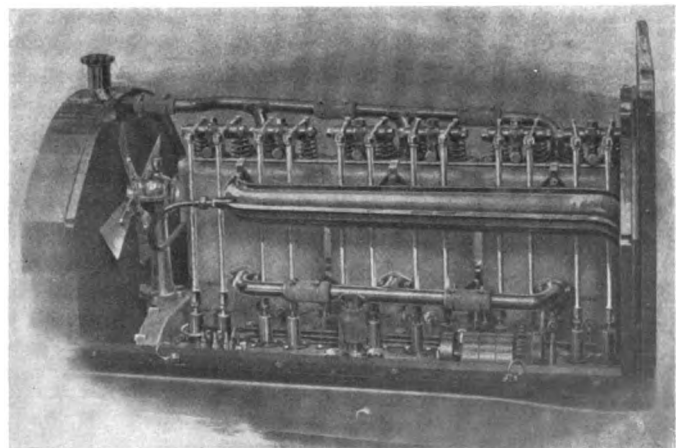

Exhaust Side Showing Oiler-Pump-Magneto Arrangement.

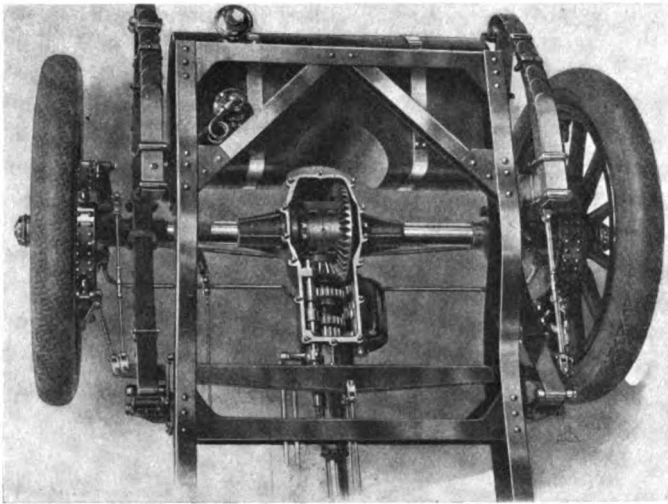

Rear Construction with Transmission Uncovered.

of the oiler-leads branch into pipes to the various cylinders or bearings; one lead forcing lubricant to the three plain crankshaft bearings; one branching into six, to supply oil to grooves in each of the cylinders, and the third has six oil pipes arranged to drip upon the lower ends of the connecting rods as they move.

High-Tension Ignition Used.—An innovation for Matheson cars is the use of high-tension, jump-spark ignition, with plugs placed in the right side of the cylinder castings and obtaining current from a Bosch magneto.

A standard water-cooling system is embodied, with a centrifugal pump, cellular radiator and gear-driven aluminum fan. The radiator is the same shape as that characteristic of the Matheson, of ample size, with large piping to the tops of the cylinders and to the pump. The latter has an aluminum casing, bronze impeller and steel shaft, driven, as stated above, from the oiler-pump-magneto shaft, and forcing its water into the jackets on the left side at the bottom. The fan, which consists of six aluminum arms riveted to the hub casting, is 16 inches in diameter, and is driven through bevel gears from the crankshaft with a 2 to 1 reduction. To take up any sudden motion on the part of the engine a spiral-jaw clutch is interposed.

An 18-inch flywheel, mounted on the rear of the crankshaft, contains the multiple-disk clutch in an oil-tight casing. There are 51 flat steel disks in the assembly, the rings have alternately eight notches and eight lugs, forced together by a spring which gives a load of 140 pounds. A tubular rocker sleeve is used to connect with the clutch-foot-pedal, and the arms are long enough to give an easy and delicate action. The entire front of the chassis, from the radiator to the flywheel, is protected from road dirt by the extension of the motor base to the side of the frame.

Transmission Integral with Rear Construction.—Shaft drive, with a three-forward and one reverse speed, selective sliding-gear transmission, located in a crucible-steel casting together with the bevel driving gear and the differential, and a full floating rear axle constitute the transmission construction. Thus there is nothing between the clutch and the rear axle, except the propeller shaft, which is of solid steel, 1 5/8 inches in diameter, squared at both ends. This shaft runs in a casting, which is at once the strut and the torsion tube, performing the functions of the latter through a globe-end fastened to frame cross-girt. Deflections are compensated for by a suitable device. The transmission shafts run on sets of ball bearings, with thrust bearings located advantageously. The two sliding gears are made of chrome nickel steel and all other gears are of nickel steel, oil tempered, with 7/8 of an inch face. On high speed the drive is direct to the bevel pinion and gear, the whole construction of which can be readily reached for inspection by removing the cover. The differential is of the bevel-gear type. The drive from the bevel-gear housing to the wheels is through floating live axles, made of nickel steel, of 1 1/4 inch diameter, with

squared ends, and oil tempered. Six-tooth nickel-steel clutches form the connection between the shafts and the wheel hubs. The whole rear construction of the new cars is of special Matheson make—no means was spared to test it in preliminary work and it showed its worth and was adopted.

The front axle is by Timken, I-section, a single drop-forging without welds, with adjustable roller bearings. Half-elliptic springs are employed in front and three-quarter-elliptic in the rear, the former being 34 inches long, with seven leaves, joined to the sideframe eyes in front and linked at the rear; the latter springs are extra long and strong, to insure ease in riding, the lower member having eight leaves and is 40 inches long, linked to the chassis frame, and the upper member also has eight leaves, 21 1/2 inches long, from the scroll-spring eye at the rear to a chassis bracket in front. Oil holes and oil screws are provided.

Minute Attention to Important Details.—Brakes, control mechanism, steering and the other parts of automobiles which must be given the most accurate consideration in designing and building have been thoroughly attended to in the Matheson cars in general and in this model in particular. There are two sets of brakes, both operating on the rear wheels, one set being expanding and the other contracting. The drum is 2 inches wide and 14 inches in outside diameter. The internal set is applied by the right foot-pedal and the other by a side lever, but between these and the brakes themselves are interposed brake-eveners. Within the drums are located the hold-back pawl and ratchet controlled by a foot-pedal on the toe-board.

An irreversible steering action, through a hardened worm and sector, is obtained and the steering cross-rod placed behind the front axle. The knuckles are all drop forgings, fitted with grease and oil cups. The spark and throttle levers are situated upon the top of the steering post and are stationary.

The new "six" is fitted with a five-passenger body which much resembles the toy tonneau type, because of its low, rakish appearance, and in color and general lines follows standard Matheson practice. The upholstery is of high-grade leather, with tufted seats and backs; the fenders and running board are enclosed; the gasoline tank is fastened to the pressed-steel frame at the rear, and the wheels are 36 inches in diameter, using 4-inch tires.

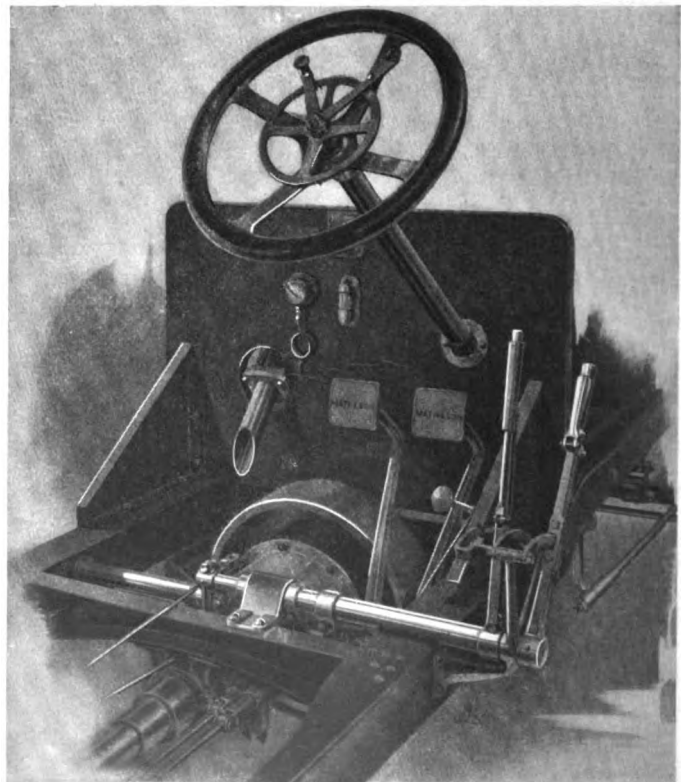

Control Mechanism and Unobstructed Dash.

A Franco-British Newcomer

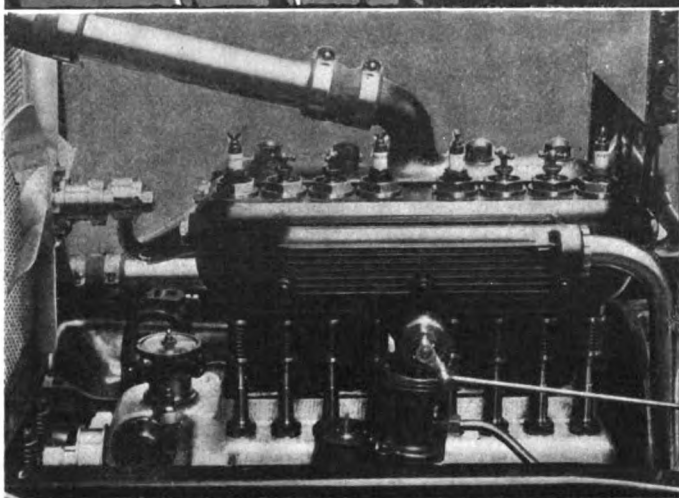

The Motor Shows Clean and Natty Proportions.

LONDON, April 10.—At the Manchester show a number of cars were shown for the first time, and none attracted more attention than the F. L., which, although the product of a famous French house and built complete in the shops across the Channel, R. M. Wright & Co. have taken the exclusive rights to it, and they propose to sell only in England. This makes the car practically a British product.

Placed alongside of other cars, the feature which is most apparent is the neat yet extremely simple lines of the whole chassis. Beginning with the motor and carrying right through to the back axle and rear construction, every piece shows this tendency toward simplification. Moreover, ease of adjustment and facility of dismantling have been most carefully kept in view, so that for such service as taxicabs, the whole construction is ideal, as the removal of any part is a matter of minutes.

Engine Has a Straightforward Appearance.—As the view of the left or valve side of the motor shows, the cylinders are cast *en bloc*. The exhaust is not cast integral, but is a simple ribbed casting attached by three bolts to the machined face of the cylinder. The valves are grouped on the one side, with the carburetor placed low down on that side. The inlet pipe is integral with the exhaust, and so carefully worked out that at first glance, there does not appear to be any inlet. The carburetor is attached to this in such a manner that it can be removed in a minute or can be rotated out of the way without disconnecting it. Double ignition is fitted with the timer located at the left, forward, and driven from the camshaft. The high-tension magneto is placed on the other side, at right angles to the motor, and is driven from the crankshaft. It is very accessible, and may be removed in less than a minute without disturbing anything.

The engine is of the four-cylinder type, with 80 mm. (3.15") bore and 100 mm. (3.94") stroke. The rating is 12-16, the latter being the R. A. C. rating for this bore. The under portion of the crank chamber, flywheel pit and lower half of the gearbox is in one aluminum casting, which forms its own underpan, and is carried directly on the main frame side members. Cooling is by thermosiphon, the outlet from engine to the top of the radiator being a single straight pipe of large diameter. The return is lower down on the other side, and is also of large diameter and free from bends, only one being necessary. The cooling is assisted by a large sized fan, belt driven from the crankshaft, and hung from the cylinder block on an I-section bracket.

Lubrication Well Cared For.—The engine is lubricated by the pressure system, the oil being forced by a gear-driven pump

through the drilled shaft and to the reservoir on the dash, from whence it flows by gravity to all other places. This reservoir is placed on the engine side of the dash, so as to conform to the modern desire for a clean dash on the driver's side. A dial indicator shows the amount of lubricant on hand.

The transmission gives three speeds and reverse, with the usual direct drive on the high. From this the drive is by means of a cardan shaft enclosed in a very large tube and turning on ball bearings. The rear wheels carry a pair of brakes, enclosed and of the internal expanding type. These and the footbrake on the mainshaft are operated by adjustable means, all of the pedals being quickly changed, while the hand levers can also be changed to suit the operator's physique.

One-Lever Control Is Featured.—The steering-post control of the engine follows the practice inaugurated by Renault in the use of one lever. The spark advance is fixed and the single lever provided works the throttle. The steering wheel is of the four-segment design, with an original method of assembling.

The frame is of pressed steel, and has a liberal section. There are two bends, one at the dash to allow of a large steering lock and to dispense with a sub-frame. The other is just forward of the rear axle, and is designed to lower the center of gravity. The springs follow usual practice, with three-quarter elliptics in the rear. The wheels are large and fitted with good-sized tires.

The chassis form, the F. L. sells at £285 (\$1,400), and with the body fitted the price is £350 (\$1,700), so that it comes in the so-called popular class of four-cylinder cars.

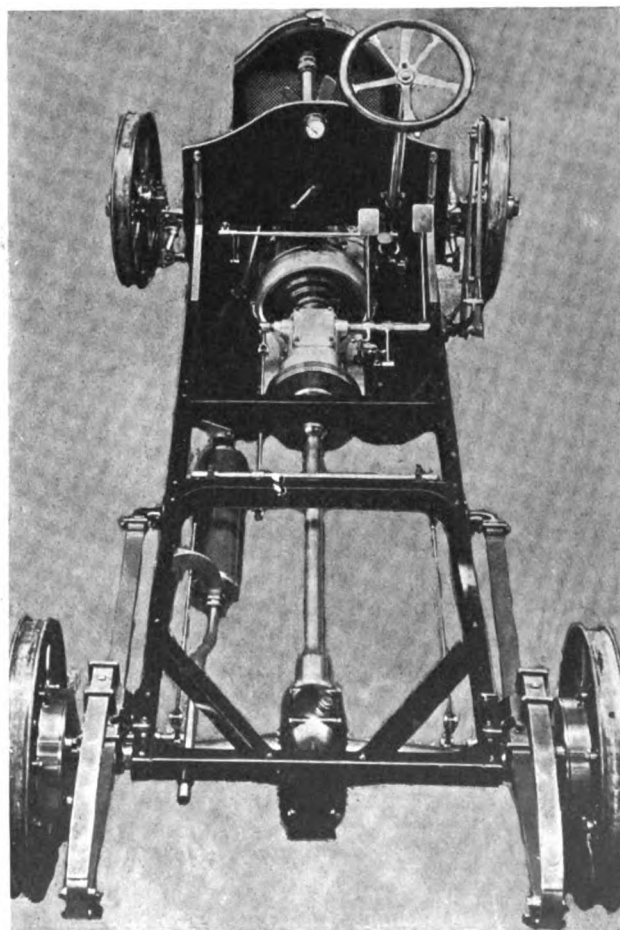

View of the Chassis and Rear Construction.

HOW STEVENS-DURYEA USES TEST-BLOCK ENGINES

By JOHN W. FEW, Jr.

CHICOPEE FALLS, MASS., April 19.—Most interesting is the practical and economical use of the engines placed on the testing block at the Stevens-Duryea plant, and it also illustrates how the cost of a car can be reduced through improved equipment and factory organization. The well-equipped factory to-day cannot only do better work than formerly, but it can do the same work at much less cost.

Two years ago the writer was much interested in seeing the engines on the testing block churn up great quantities of water in a huge tank to show "what they could do." The power was there; but it was all wasted. The water was simply being used as a resistance. Now all is changed. There is the same roar of turning machinery as the fifteen or more engines strain at their blocks, but the energy, instead of being dissipated uselessly in water, is conserved by dynamos and used to drive the machinery in the building. Each engine is placed on a separate frame and attached to a Westinghouse direct-current motor of 17 kilowatts capacity, but capable of a considerable overload. When the engine is first put on the stand it is run in by the motor. After a complete limbering up the engine under test is required to drive the motor for a number of hours, developing about 38 horsepower. The engine is then taken down; that is, the main bearings are all taken apart and examined to see if any wear has developed, and every moving part is minutely examined before reassembling. After this the engine must make a continuous run of 10 hours, driving the motor and must produce 38 horsepower or over all the time. Located above the testing frames is a large switchboard, the gauges of which are numbered to correspond to the numbers on each frame. At a glance the output of each machine can be seen.

Great care has been exercised that in the operation of the engines conditions shall approximate those obtained in actual usage. Gasoline, which is stored in a 400-gallon tank, is delivered to the engine with the same flow and pressure that exists in the complete machine. This is secured by the use of an auxiliary tank containing two gallons. By the use of a ball valve the flow is

regulated and the carbureter works under the same condition as in actual service. The cooling system has been worked out with the same care. While the radiator is missing, a large tank is connected up to the engine and insures a sufficient cooling medium. An auxiliary pump is interposed in the system to insure that the head of water and pressure is the same as when the motor is on the road. The current generated by the engine is used in the factory and the output of the fifteen or more engines, each producing 38 horsepower, is no small item of economy. A 75-horsepower generator, with suitable governor, is also connected up in series, so that when a number of engines are being changed at the same time and the output consequently diminished it can take up the load and the work goes merrily on. The efficiency of the system in furnishing power was put to a test not long ago. The large generator broke down and for several days was out of commission. By extra efforts on the part of the testing force to keep the 18 stands full, the machines under test furnished sufficient power to run the plant without one instant of stoppage or the secession of one machine unnecessarily. Thus, the utility of this apparently useless work was proved to the satisfaction of every one concerned.

Although the engines get such a careful test on the blocks they are further tested on the road. After being fitted to a chassis they are driven for three or four hours, then taken apart and once more examined for wear, valves again ground and then once more are taken on the road and tuned up by the tester. If the engine performs to his satisfaction he turns it over to the head tester, who once again takes the car on the road and makes it do "stunts." It must throttle down to a snail's pace on the high, pick up on the spark, and take certain hills on direct drive. Out of respect to the law in Massachusetts, nothing will be said as to the speed required. After this the car receives the regular body and equipment and is again taken on the road for a short run. This is to determine that everything is right. While some of these tests appear to be useless, it is only an indication of the painstaking care practised at the factory to insure a perfect car.

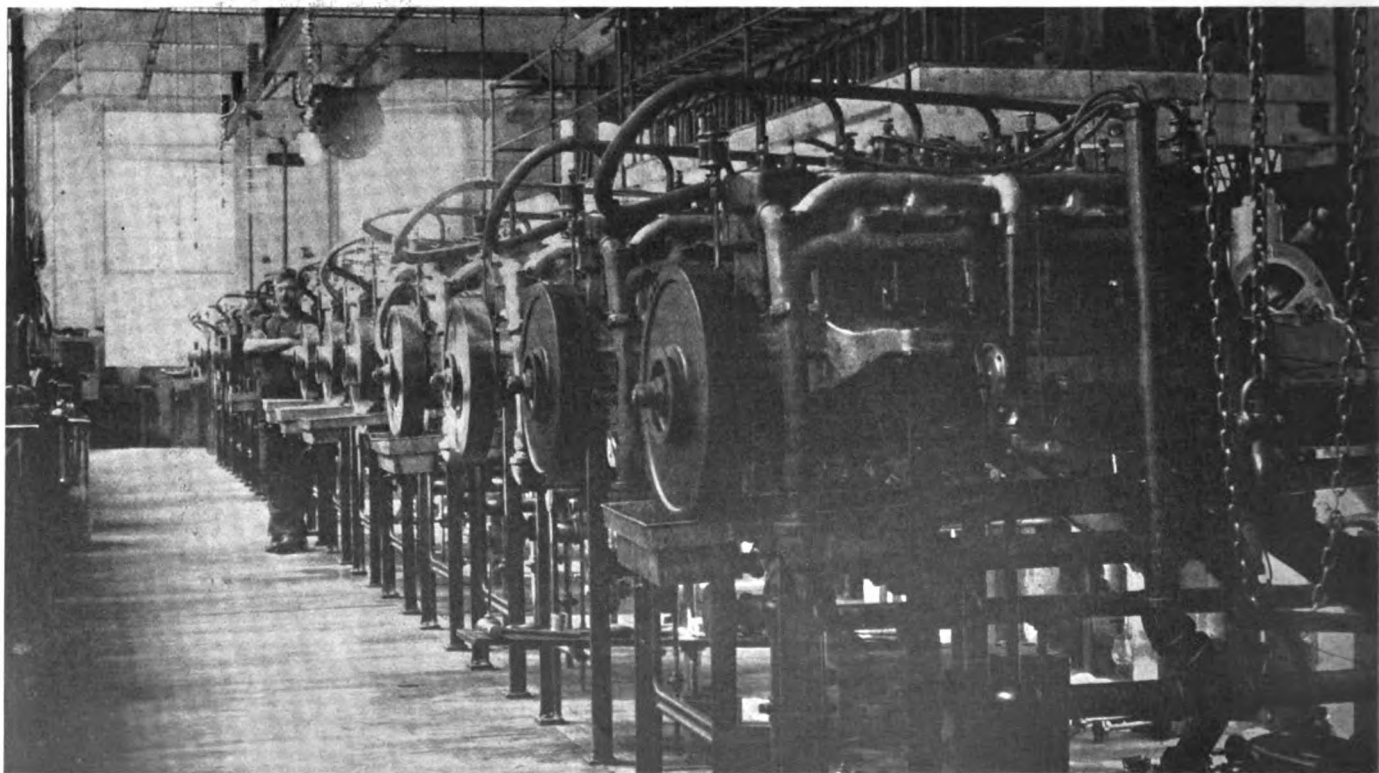

Stevens-Duryea Testing Room—Six-Cylinder Engines in Foreground, Fours in Rear—Electrical Gauges and Testing Apparatus Overhead.

What One Pennsylvania Club is Doing for Roads



LANCASTER, PA., April 19.—Depending upon the newspapers of the county and the spirited enthusiasm of its members, the Lancaster Automobile Club has inaugurated a system of good roads improvement that bids fair to eclipse the efforts of any other automobile club up to date. The most striking thing about the whole movement is that it is so practical and is meeting with the hearty cooperation of the farmer element. Lancaster county has over 1,000 miles of public highway and is divided into 40 townships and nearly that many cities and boroughs. Each of these localities is presided over by its road officials. Scattered throughout the county are 30 newspapers and the club's plan is carried out as follows:

The consent of each of the road officials is gained to permit a one-mile stretch of dirt roadway to be dragged by a King Split-Log road drag for a period of 20 hours of labor all told, the dragging being done after each rain by farmers who live at convenient localities. The club supplies the drag, pays the farmer who drags the road and agrees to make good by a \$500

bond if necessary that no damage will be done to the roadway. At each section of the county a newspaper is given the credit of conducting the experiment and the news columns of the nearest paper are kept alive with frequent reports regarding the condition of the road from time to time, demonstrations held upon it, officials present, comparisons with stretches of road not dragged, etc.

Newspaper correspondence is solicited from the farmers living in the neighborhood of the demonstration and they are afforded every opportunity to drive over the newly dragged road and examine its condition.

One board of supervisors from the township of East Lampeter were so set against this method of road improvement at first that they put the matter into the hands of their lawyers, who notified the club that if any such means of working their township roadways was adopted they would prosecute those who might do the work. By dint of tact and perseverance on the part of the good-roads committee and the club's solicitor, this board of objecting supervisors finally permitted the club to carry on its work. Over 2,000 four-page pamphlets describing in detail the method of constructing a road drag have been distributed to the farmers. The county of Lancaster is becoming a beehive of good-roads industry, and the progressive plan of the automobile club gives every evidence of being the right remedy for "Good Roads Now," which is the campaign slogan of the autoists.

GOOD ROADS TALK FREQUENT NOWADAYS IN CONGRESS

WASHINGTON, D. C., April 19.—The good roads movement has no greater advocate in Congress than Representative William Sulzer, of New York. During the past week he delivered a strong speech on the subject, stating among other things that national aid for good roads is demanded by the people, and the question will grow more and more important as the seasons come and go until the demands of the people are granted by the national government. The following excerpts from Mr. Sulzer's able address are of pertinent interest:

"Good roads mean progress and prosperity, a benefit to the people who live in the cities, an advantage to the people who live in the country, and it will help every section of our vast domain. Good roads, like good streets, make habitation among them most desirable; they enhance the value of farm lands, facilitate transportation, and add untold wealth to the country. Good roads have a money value far beyond our ordinary conception. Bad roads constitute our greatest drawback to internal development.

"The direct connection between good roads and the value of farm lands is shown in a striking manner by the United States Department of Agriculture. The returns received by the department from various States show that in nearly every case the States having the highest percentage of improved roads have the largest population per mile of road, thus showing that better roads are a powerful factor in encouraging the settlement of unused lands, especially in sparsely populated sections of the country. A comparison of the percentage of the improved roads

of the various States shows that the average percentage of the improved roads in all States where farm land is worth less than \$20 an acre is only 1.8 per cent.; whereas in the States where the acreage value is more than \$20, improved roads constitute an average of 9 per cent. of the total mileage.

"The farsighted wisdom of Julius Cæsar built from the Imperial exchequer the magnificent roads that led in all directions to eternal Rome. The great Napoleon—Cæsar like—built the roads of France that center in Paris from the general funds of the government; and these French roads have done more than any other single agency to encourage the thrift and increase the industry of the people of France. Cæsar and Napoleon were the great road builders of ancient and modern times, and their foresight and their judgment and their work demonstrated the beneficial results that follow like the night the day the building of great governmental highways."

TOLL ROAD'S CONDITION PROTESTED.

WILMINGTON, DEL., April 19.—Alleging that the Philadelphia and Wilmington turnpike is in bad condition, some of the users of the road have taken steps to try to have it improved or the taking of toll thereon stopped. A petition has been drawn up by Robert L. Baldwin, who uses the road, and it has been signed by a number of others. An inquiry will follow, and that will determine the petitioners' rights.

What the Clubs are Doing These Days

MARYLAND WILL WELCOME PENNSYLVANIANS.

BALTIMORE, April 19.—These are busy days for the members of the Automobile Club of Maryland. Their request to Secretary of State Winslow Williams that the members of the Harrisburg Automobile Club who are to participate in the endurance run from Harrisburg to Scranton, through sections of Maryland, be permitted to operate their machines in this State without having to procure a Maryland license, has been granted. The certificate of concession issued by the Secretary of State stipulates, however, that the visiting autoists will be subjected to all other State laws and regulations.

Members of the local club are planning to entertain the visitors during their stay in Baltimore. A delegation will meet the Harrisburg motorists at Relay, on their way from Washington to Baltimore, and escort both the pilot and chairman cars to this city. The checking station will be at the Automobile Club of Maryland quarters.

Two more councils of the State Association of Motorists, the organization which intends to look after proper and just legislation for Maryland owners, were organized during the week. These were the Salisbury and Elkton councils, the latter being in the home city of Governor Crothers, who favors the Swann Bill, which caused such a stir among owners until some of its original provisions were modified.

A. C. OF HARTFORD ELECTS NEW OFFICERS.

HARTFORD, CONN., April 19.—At the annual meeting of the Automobile Club of Hartford, held last Wednesday evening at the headquarters in the Allyn House, General Wallace T. Fenn was elected president; Thomas W. Russell, vice-president; C. D. Alton, Jr., was re-elected treasurer, and Arthur G. Hinckley was elected secretary. The election of the new officers puts into effect the recommendation of the committee on the expansion of the club at the meeting on March 26, that the officers be automobile owners, and not allied with the trade or industry in any professional capacity.

The committee on new quarters recommended a location on the ground floor of the Allyn House, to take the place of the present quarters on the second floor. The membership report showed a present membership of 318, one member having been dismissed for violation of the automobile law. The annual dues for old members have been increased from \$5 to \$10, and for new members to \$15. Following the close of the regular order of business, former President J. Howard Morse, who has just returned from a two years' stay abroad, gave an interesting talk on his automobiling experiences in Africa.

WORCESTER'S DEAD HORSE CLIMB JUNE 17.

WORCESTER, MASS., April 17.—The board of governors of the Worcester Automobile Club has decided to hold the annual hill climb on Dead Horse Hill, Saturday, June 17. This comes on a date when there is no other event of similar character scheduled in New England, and it is expected that the entries will be exceptionally large, as last year's event was an unqualified success. The committee consists of President John P. Coghlin, Daniel F. Gay and Albert H. Inman.

For several weeks the club has been considering an independent hill for the climb. It is realized that with the high-power cars this year Dead Horse is not as stiff a proposition as is desired, and it was thought that if a private hill could be secured it could be used as a recognized hill on which to hold tests, there being no place in New England where a car can be tested without violation of the speed laws. To build a hill a mile in length would cost about

\$15,000, and the club could not get such a proposition under way in time for a climb this year. It was finally decided to utilize Dead Horse Hill for this year's contest.

MINNEAPOLIS CLUB HAS 804 MEMBERS.

MINNEAPOLIS, MINN., April 19.—Horace Lowry was unanimously re-elected president of the Minneapolis Automobile Club at the annual meeting. The other officers named were: First vice-president, C. F. Haglin; second vice-president, S. M. Colburn; secretary (re-elected), G. H. Seeley; treasurer (re-elected), J. H. Riheldaffer. Of 14 candidates for the board of directors, Dr. C. E. Dutton, G. H. Seeley, H. E. Pence and Frank Cook were elected. President Lowry announced the appointment of the chairmen of committees as: House, H. E. Pence; good roads, G. A. Will; sign posting, Harold Vorce; legislation, Dr. C. H. Kohler; membership, E. L. Brown; tours and contests, Dr. C. E. Dutton.

During the past year 326 new members have been received into the organization, bringing the total to 804; and in other lines the club has been similarly successful.

LOUISVILLE CLUB HAS DOUBLED MEMBERSHIP.

LOUISVILLE, KY., April 19.—Improvement in country roads and the generous erection of signposts in Jefferson county were advocated at the annual banquet and meeting of the Louisville Automobile Club. The new officers are: President, J. T. Ross; first vice-president, H. E. Tuley; second vice-president, R. E. Morris; secretary, E. J. Straus; treasurer, W. I. Kohn; directors to the State association, G. S. Barnett, Prince Wells, Lee Miles, Dr. R. L. Ireland, J. M. Chatterson.

The willingness of the municipal park board to an increase of the speed limit from 12 to 15 miles an hour was signified, and also its intention to construct stone bridges in Cherokee Park. Committees were appointed by the newly elected president to take up the matter of road improvement and signposting. The club now has a total membership of 205, double the number on the lists a year ago.

GENEVA (N. Y.) CLUB WILL HAVE SUMMER RUN.

GENEVA, N. Y., April 19.—At a meeting of the Geneva Automobile Club, held recently, the resignation of President Herendeen, who is going to Europe, was accepted, and the following members elected to office for the ensuing year: President, W. L. Fay; vice-president, E. S. Sigler; secretary and treasurer, C. W. Fairfax; executive committee, G. M. B. Hawley, Dr. W. H. Jordan, H. L. Rose. Good roads and the regulations of speed were subjects which were discussed and plans for the summer run were also taken under consideration.

SPRING ACTIVITY OF CANADIAN AUTOISTS.

MONTREAL, CAN., April 19.—With the opening of the spring touring season, the Automobile Club of Canada has outlined a number of lines of activity. One of these deals with the dust nuisance, and together with the municipalities between this city and St. Anne's on the lake shore, it has arranged to oil roads most used by autoists. In connection with road work, it has

been planned to post signs between Montreal and Rouse's Point, thus forming marked touring routes with those coming from the United States. Arrangements have not been fully completed for the three days' race meet to be held on the Blue Bonnets track. It is expected, however, that this will be made a very important event and will be entered by a number of prominent drivers.

JAMESTOWN (N. Y.) CLUB PLANS MANY EVENTS.

JAMESTOWN, N. Y., April 19.—These officers for the coming year were chosen by the Jamestown Automobile Club at its annual meeting: President, W. J. Maddox; vice-president, Fletcher Goodwill; secretary, Louis C. Breed; treasurer, B. D. Phillips; trustees, Peter H. Hoyt, S. B. Broadhead, Oscar Stranburg, Dr. W. E. Goucher, H. W. Fenton, W. A. Marson, J. H. Wright, F. O. Anderson, C. O. Pickard, D. H. Grandin, F. P. Hall, W. W. Hunt.

An effort is being made to increase the membership, and plans have been made for a series of events for the summer, including a parade at an early date, races in July, club runs to places of interest and improvements in the neighboring roads.

FIRST ANNUAL MEETING OF NEW HAVEN CLUB.

NEW HAVEN, CONN., April 19.—The New Haven Automobile Club celebrated its first annual meeting and birthday at Savin Rock, last Wednesday evening, combining the election of officers with a smoker and Dutch supper. Nearly all of the 200 members attended. The officers chosen are: President, Thomas G. Bennett, re-elected; vice-president, J. P. Goodhart; secretary, W. T. Dill; treasurer, C. E. Thompson; board of governors: T. G. Bennett, J. P. Goodhart, W. T. Dill, F. G. P. Barnes, C. M. Robinson, P. S. Thompson, A. L. Chamberlain. Chairman of committees: Legal, C. M. Robinson; membership, P. S. Thompson; contest, W. A. Maynard; good roads, F. G. P. Barnes; sign posts, A. L. Chamberlain.

A PICTURESQUE PENNSYLVANIA ROUTE.

NORRISTOWN, PA., April 19.—Passing through the most prosperous, as well as the most historic, part of the State of Pennsylvania, the route chosen for the second annual endurance run of the Norristown Automobile Club has elicited a widespread interest. Members of the local organization and automobilists from many parts of the surrounding country have decided to join with the contest simply because of the pictorial nature of the country to be covered, as aside from the contesting spirit. Four hundred miles of highway will be traveled in the run of two days' duration to Hagerstown, Md., and return, on May 18 and 19.

Starting from this city, the tourists will cross the Schuylkill River, to the Lancaster pike, and turn westward toward Downingtown, a portion of the Chester valley which is bordered on the south by the Hundred-Mile Woods, and on the north by the Valley Forge hills. The famous old road is followed through Coatesville, skirting the Welsh mountains, in which some beautiful views of the prosperous Lancaster county will be gained. The general direction of the proposed State highway from Philadelphia to Pittsburg is taken, and most of the distance is over some of the roads which are included in

the plans. At Lancaster the contestants will continue due west to Columbia, where they will cross the mile-and-a-quarter-long bridge over the Susquehanna River. A rich farming country is traversed to and beyond York, and the Blue Ridge mountains will be seen in the distance. The first reminders of the historical ground will be seen at Hanover, in the center of which place is a large monument to the soldiers who fell at Gettysburg, and shortly after passing through Littlestown the Mason and Dixon line is crossed, into Frederick county, Maryland.

In Frederick, the site of Barbara Frietchie's house will be passed, and the route takes a slight northerly turn, crossing the Catcoctin mountains at Braddock Heights. The views will be well worth the trip, for a descent is made, into the fertile Middletown valley, over a natural switchback road, with the Blue mountains but a few miles away. A climb of three and a half miles to the top of Bolivar mountain, close to the battlefield of South Mountain, will furnish a real test for the automobiles. Historic spots are everywhere made known by the Government signs, Harper's Ferry to the south, and Antietam to the west. Hagerstown, the night stop, has ample facilities.

The homeward-bound trip is commenced in a northeastern direction, soon the Mason and Dixon line is re-crossed, and Waynesboro is the first place of size entered. Another climb of three and a half miles to the summit of the Blue Ridge, through Penn Mawr, by the Blue Ridge Mountain House and Chariman, will reveal to those who have never taken the trip some of the most splendid views in the East, the valleys on both sides being easily seen just at the summit. The descent will be made through Monterey Gap, over the road which General Lee used in retreating after the battle of Gettysburg. Still proceeding in an easterly direction, Jack's mountain, a spur of the general system, is crossed, and Gettysburg reached. This will, of course, be exceedingly interesting, and perhaps more so when it is considered that the road taken toward Chambersburg, crossing the mountains north of Cashtown, is the same one which General Lee took in approaching the crucial encounter with Meade. As a contrast to mountain climbing, the run up the Cumberland valley will be a particularly pleasing one, as it always is to autoists who have just come across the Alleghanias.

At Harrisburg the turn to the East is made, via Reading, over Mount Neversink, and through Birdsboro and Pottstown, to the finish at Norristown. The distance on the first day is 190 miles, and on the second 210, so that even though going through a picturesque and interesting country, the event is not without its qualifications as a competition and an endurance tournament. Already a large number of entries have been assured of the Philadelphia automobile trade. The Oldsmobile "six" with its 42-inch wheels, and the American Traveller with 40-inch wheels will be among the contestants.

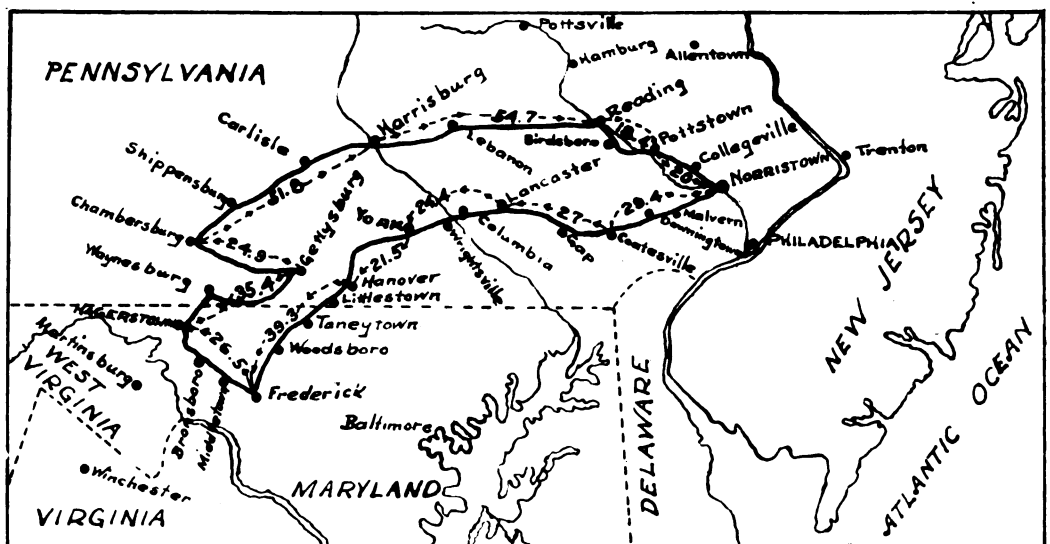

Route of Second Annual Endurance Run of Norristown (Pa.) Automobile Club.

NEW YORK PREPARES FOR WEEK OF FESTIVITIES

ENTHUSIASM for the second annual carnival of the New York Automobile Trade Association has been bubbling forth from the concerns in the automobile business of the metropolis during the present week, in preparation for the festivities of the next. Banners, bunting, and other decorative ornaments have begun to appear on the buildings along and just off of Broadway, while the interiors have been appropriately arranged for the celebration of the opening of the spring touring and selling season. A hill climb, a series of speed trials, an efficiency contest, a demonstration of the feasibility of automobiles in conveying troops, and a mammoth parade are the features in which the automobiles will be the centers of interest. A dinner dance and a smoker will furnish evening social entertainment and a souvenir day will supply some surprise in novelties which will be given to customers and friends of the dealers. So successful was the carnival last year that this one has been anticipated and some elaborate preliminary work done for it.

Opening on next Monday, there will be a hill climb on the Fort George hill which, in point of entries assured, will surpass any yet held. Price classification by the A. A. A. standard has been adopted, and there will be eleven events, seven for gasoline cars only, one for steam and one for electric cars only, and free-for-alls. Entry blanks for these have been issued.

Tuesday straightaway speed trials on Hillside avenue, Jamaica, L. I., will be run, over the same course used in races last Spring.

Souvenir day will hold the attention on Wednesday, with a dinner dance in the evening at the Hotel Marseille.

Inability to get a track in good condition has prevented the original plan of a track race and games for Thursday, and instead it has been decided to call this "Military" day. The remarkable demonstration held recently in England of the manner in which soldiers can be quickly mobilized and transported some distance will be duplicated here, four or five hundred members of the ninth regiment of the militia, fully equipped for service, being the soldiers in the case. They will be picked up at their armory and carried to some suburban place for luncheon, and brought back late in the afternoon.

One of the most interesting events announced will be the feature of Friday, that of a one gallon efficiency contest, planned on much the same lines as the one held several years ago. The contestants will not know the route to be taken until just before the start; they will be given a single gallon of gasoline, and will run as far as possible, using special tanks if desired, in order to get every drop of gasoline before stopping. To put all upon an equal basis regarding size and power, it has been decided that the score of the cars shall be obtained by multiplying the distance traveled by the weight of the car and its occupants. The price classification will also be in effect and there will be an observer on each car. Distance will be measured by odometers, unless a specially measured suburban course can be obtained.

Decorative effects may be given full reign in the carnival parade, an event in which hundreds of automobiles are expected to take part, held this year in the afternoon instead of the evening. There will be sections for beautifully bedecked cars, for grotesquely finished ones, for commercial cars, floats, and for regularly equipped cars, so that all kinds, types, and sizes may take part. Generous prizes, both cash and plate, have been announced for all the competitive events of the week. Manufacturers, dealers and branch managers have entered heartily into the spirit of the affair, and the size of the parade may be surmised from the fact that the Maxwell Company alone has made arrangements for 150 cars; another concern that had previously entered 30 raised this to 50, and others are expecting to do likewise. Added to the trade division will be the great number of private owners who have made extensive preparations.

The following is the list of events scheduled:

Monday, April 26.—Fort George hill climb. Eleven events.

Tuesday, April 27.—Straightaway speed trials, Hillside avenue, Jamaica, L. I.

Wednesday, April 28.—Souvenir day on Automobile Row. Dinner dance at Hotel Marseille, Broadway and One Hundred and Third street.

Thursday, April 29.—Military day.

Friday, April 30.—One gallon efficiency contest.

Saturday, May 1.—Carnival parade. Smoker, and award of prizes at Automobile Club of America.

INTERESTING STATISTICS OF THE MAXWELL NON-STOP RUN

BOSTON, April 19.—Complete data, showing the effect of the 10,000-mile non-stop motor run, have not yet been compiled by the technical committee, in whose charge the Maxwell car was placed at the finish of the test last Monday afternoon. The car is now in the laboratory of Professor Charles F. Park, of the Institute of Technology, and his examination is so minute that he has not yet completed it. When the report of Professor Park is drafted, it is expected that figures will be given showing just what was the result on every part of the mechanism of more than twenty-five days' continuous running of the motor, and the journey of 10,074 miles, which is what the register showed when the car was finally stopped by President Speare, of the A. A. A.

From the log-book carried on the car during the test, however, some interesting facts have been compiled. In this book was entered a complete account of the car's performance, the mileage per day and per trip, the amount of supplies taken on, and the repairs that were necessary. The motor was run exactly 606 hours and 21 minutes, never stopping from the time it was cranked at 10 o'clock on the morning of March 18, until it stopped in Copley Square at 4:21 o'clock April 12. During that period there were used, according to the log-book figures, 758 gallons of gasoline, making the average mileage per gallon about 13.3. This, however, included time when the car was standing still, but the motor was eating up fuel. There were used 119

gallons of oil and 17 pounds of grease for lubricating purposes. The consumption of oil was much greater than on an ordinary touring car, because a very light oil was used in large quantities.

In the total duration of the test, 606 hours and 21 minutes, the car itself was standing still with the motor running 39 hours and 40 minutes. In that time the car would have covered, had it been in motion, approximately 600 miles. The time during which the car stood still was consumed in taking on gasoline and oil, changing drivers and observers, changing tires and making repairs. There were eight tire punctures, the rear axle was changed, a spark plug and a push rod replaced. Several spring leaves had to be replaced. In all the car made 156 round trips from Boston to Worcester, Providence, Newburyport, Nashua, Marlboro and Framingham, making an average of 65 miles per trip.

Members of the technical committee, who are the only persons that have ridden in the car since the end of the test, were surprised at the smooth manner in which the motor was running.

Splitdorf Gives Dinner to Maxwell Drivers.—In recognition of the good work of the drivers who handled the Maxwell car in its 10,000-mile test, Charles F. Splitdorf, maker of the Splitdorf magneto and coil, with which the Maxwell was equipped, on Tuesday evening gave a dinner to the drivers and the members of the Maxwell Company at the Hotel Thorndike. Through the run the Splitdorf magneto gave the best of service.

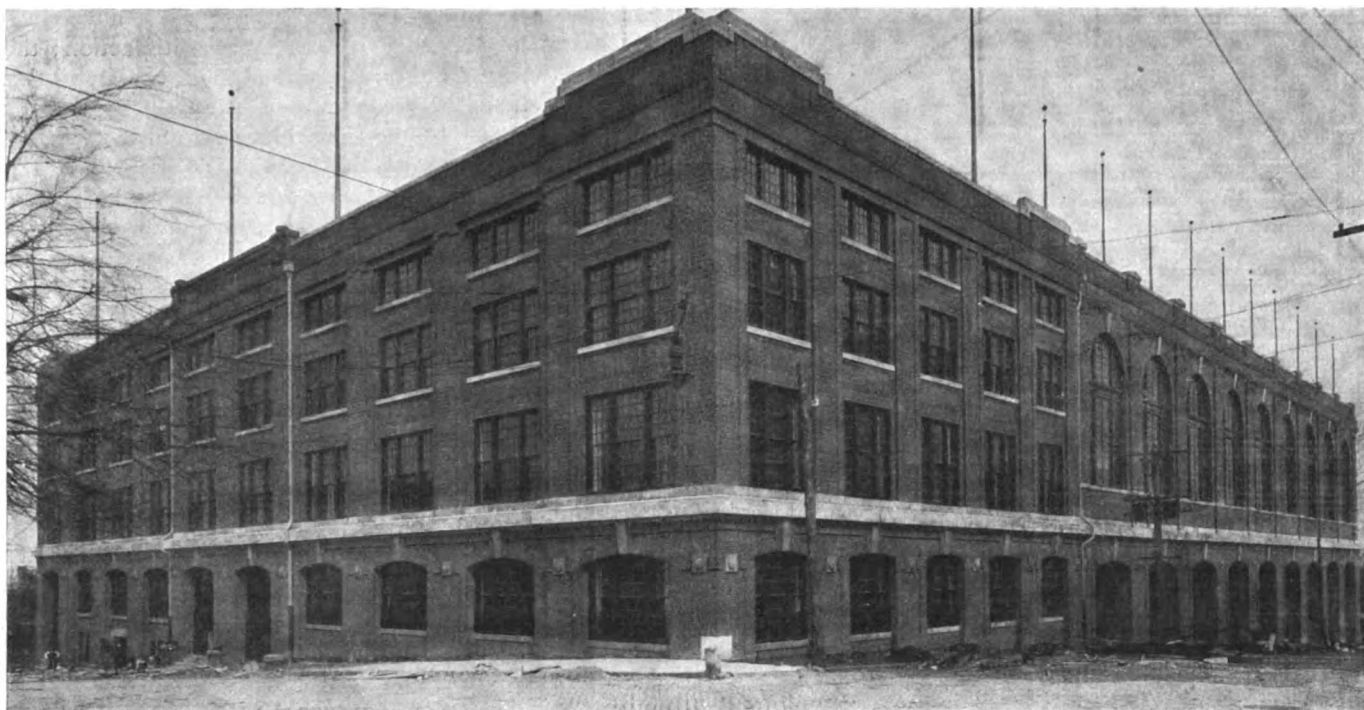

Atlanta's Big Auditorium, Nearing Completion, Where "National Automobile Show of the South" Will Be Held in November Next.

CANDIDATES FOR WESTERN CUP RACES.

CHICAGO, April 20.—Frank H. Trego, general executive in charge of the two races of the Chicago Automobile Club—light car event, June 18, and Cobe cup, June 19—started out Monday night on a canvassing trip to Western factories for the purpose of getting a correct line on the probable entries for the two big Western road races. He has mapped out a circuit, taking in Flint, Pontiac, Jackson, Detroit, Indianapolis, and Cleveland.

The first stop at Pontiac resulted in the positive assurance that the Buick will have three cars in both events, with Strang, Burman, and Chevrolet as drivers. A visit to the Oakland factory at Pontiac unearthed a possible candidate which hitherto had not been figured upon for the Cobe cup.

While Trego has been away home folks have been busy, and yesterday it was announced as almost certain that a Renault will compete in the light car event, with the driver probably George Schoeneck. Another candidate for the light car race which had been overlooked by the census takers is the Corbin, and the Bird-Sykes Company has opened negotiations with the factory with a view to making an entry. Louis Geyler, Stevens-Duryea agent, also announced yesterday that his company is likely to nominate one of the four-cylinder models.

ANOTHER TAXICAB COMPANY LAUNCHED.

New York wisely has the taxicab habit beyond all hope of recovery. The latest applicant for a share of the public favor is the W. C. P. Taxicab Company, which has been organized by C. F. Wyckoff and E. S. Partridge, of Church, Wyckoff & Partridge; and A. R. Rockwell, F. E. Moscovics and De Witt Page, of the Bristol Engineering Company, Bristol, Conn. The vehicles of the new company will be popularly known as the "yellow taxi," from their coloring; the chassis and lower portion of the body is painted orange yellow, striped with black, and the hood and upper part of the body black.

The cabs, which are to be built by the Bristol Engineering Company, will embody several new features. The driver will sit on the left-hand side, with the levers in the middle. The taximeters will be driven from the front wheels, so that their measurements may be as accurate as possible, especially in slippery weather. The first "yellow taxis" are already on the streets. They will be operated from the garage of Wyckoff, Church & Partridge, at 232 West Fifty-sixth street.

ACCESSORY CONCERNS FORM COMBINE.

Announcement was made Tuesday of a selling plan involving five of the best known concerns in the trade, to be backed and managed by men who have been eminently successful in the marketing of accessories during the past few years.

The new corporation, with a capital of \$100,000, will be known as the United Manufacturers. It will act as a co-operative selling and distributing organization, handling the business of the Jones Speedometer, Inc., Weed Chain Tire Grip Co., C. A. Mezger, Inc., Connecticut Telephone & Electric Co., and N. Y. & N. J. Lubricant Co.

Jones speedometers, Weed chains, Soot-Proof spark plugs, Automatic windshields, Connecticut coils, and Non-fluid oils are the products that will be handled.

The organization will be owned and personally managed by the individual manufacturers who compose it. Plans at present include New York headquarters at Broadway and Seventy-sixth street, and branches in Detroit, Boston, Chicago, and Cleveland, with other branches to be opened later.

The president of the new organization will be W. B. Lasher, of the Weed Chain Tire Grip Co., while the other officers are R. M. Owen of C. A. Mezger, Inc., vice-president; Robert H. Montgomery, New York, secretary; George L. Holmes, of Jones Speedometer, Inc., treasurer.

As might be expected, the objects of the new organization are to concentrate the selling efforts of the interested companies and to reduce the expense of selling and distributing. On account of the branch house system, it will bring the selling company in closer touch with its customers. The new corporation will do no retail business, concerning itself solely with the jobber and dealer.

AUTOISTS USE THE WIRELESS "C. Q. D."

Two Newark, N. J., automobilists, Will H. Linkroum and A. Frederick Collins, have perfected a wireless telephone which can be carried in a suit case. One day last week they took the apparatus with them in Linkroum's Lozier car, and Collins, the inventor, held wireless conversations with the Newark office, one being from the Morristown Pike road, twenty miles away. Mr. Linkroum believes that the wireless 'phone will be of great assistance to automobilists in obtaining help in case of accident. The only difficulty is the necessity of having the garages previously equipped with similar instruments.



Vol. XX.

Thursday, April 22, 1909

No. 16

THE CLASS JOURNAL COMPANY

H. M. SWETLAND, President

231-241 West 39th Street, New York City

EDITORIAL DEPARTMENT

A. G. BATCHELDER, Managing Editor

R. F. KELSEY, Associate Editor

THOS. J. FAY

MORRIS A. HALL

W. McKEAN WHITE

W. F. BRADLEY, Foreign Representative

BUSINESS DEPARTMENT

A. B. SWETLAND, Business Manager

LOUIS R. SMITH

FRANK B. BARNETT

W. I. RALPH, 1035 Old South Building, Boston, Mass.

C. H. GURNETT,

F. W. VAN SICKLEN, } 1200 Michigan Ave., Chicago, Ill.

H. H. GILL, Detroit, Mich.

T. B. VAN ALSTYNE, Philadelphia, Pa.

Cable Address - - - - - Autoland, New York
 Long Distance Telephone - - - - - 2046 Bryant, New York

SUBSCRIPTION RATES:

United States and Mexico - - - - - One Year, \$3.00
 Other Countries in Postal Union, including Canada - - - - - One Year, 5.00
 To Subscribers—Do not send money by ordinary mail. Remit by Draft,
 Post-Office or Express Money Order, or Register your letter.

FOREIGN SUBSCRIPTION AGENTS:

ENGLAND:—W. H. Smith & Sons, Ltd., 186 Strand, London, W. C., and all book-
 stalls and agencies in Great Britain; also in Paris at 248 Rue de Rivoli.
 FRANCE:—L. Baudry de Saunier, offices of "Omnia," 20 Rue Duret, Avenue
 de la Grande Armée, Paris.
 GERMANY:—A. Seydel, Mohrenstrasse 9, Berlin.

Entered at New York, N. Y., as second-class matter.
 The Automobile is a consolidation of The Automobile (monthly) and the Motor
 Review (weekly), May, 1902, Dealer and Repairman (monthly), October, 1903,
 and the Automobile Magazine (monthly), July, 1907.

FOR THE MAN BUYING HIS FIRST CAR.

As the first days of warm weather appear and the roads begin to dry into passable condition, it is customary to give forth a word of advice and exhortation to those about to make their first plunge into automobiling. Never before have the cars been so good or so cheap; never before have there been so many profits and pleasures to be realized from their use—does this sound familiar? Yet, even at the risk of bromidism, we must repeat it. Perhaps some new reasons can be brought out to show that this, above all others, is the year; so that the stragglers, as of old, will fall into line and dim longings will be aroused in minds heretofore unmoved by the demonstrator and his seductive efforts.

Those to whom this preachment is especially addressed we may divide into two classes: the doubtful, who are not persuaded of the advantages of being an automobilist, and the timid, who, although persuaded, must count the cost. The former we can only advise to secure as many rides, runs, and demonstrations as possible; for their hesitation can only come through lack of experience. So let them pester the expectant agent and the complaisant friend; may these long-suffering teachers be rewarded hereafter, if not on this mundane sphere.

To the timid, fortunately, we can give facts and figures. This year for the first time the possibilities of the light, low-priced car are beginning to be realized. At \$1,500

and less there are a dozen different makes, any one of which can be depended upon to give satisfaction; they will run twenty miles on the gallon of gasoline, and their tires will stand the wear of five thousand miles. The useful life of one of these machines can only be guessed at. There are cars of the vintages of 1904 and 1905 which will be in active service again this Summer, albeit a trifle antiquated in appearance; and allowing for the improvements in construction since those days, these new cars should last nearer ten than five years. As for the chauffeur, the light car knows him not; the owner drives, and doubles his enjoyment thereby.

So snap the whip once more, and round the stragglers into line; delivery dates are going fast, and now is the time to buy!

* * *

LAW MAKING IS IMPROVING.

Common sense treatment of the automobile is evident as one State legislature after another concludes its annual session. Pennsylvania has improved its law in many ways, and it will now welcome the automobilists of other States, providing the other States similarly welcome the autoists from the Keystone commonwealth. New Jersey has also become quite liberal, though its reluctant politicians would insist upon a measly dollar fee for visitors. New York now has in mind the abolishing of all automobile speed limits and the making of drivers responsible under the same law which covers other users of the road. The fee is to be an annual one, as in many other States, but the abolishment of the miles-per-hour iniquity and consequent "trapping" will be considered by most automobilists as a good trade under the circumstances. Other legislatures are still busy, but the grist that has already come from the law-making mill is indicative of the changed attitude of public and politicians generally. Connecticut still bears the palm for the most liberal and sensible treatment of motor-driven vehicles, and this despite the fact that its legislature is composed in great part of farmers and men from small towns. And the "Nutmeg State" has roads worthy of the name.

* * *

"WE SHOULD WAIT AND WATCH."

Here is some editorial comment from the *New York Times* which supplies material worthy of fair-minded consideration by the man who has yet to become an automobilist in one form or another:

Automobile accidents are undoubtedly numerous, and too numerous, but it is doubtful if their number increases in anything like the same proportion as does the number of automobiles, and it would be only fair, in making up the account, to cross off a good many of them as only taking the place of accidents which, if it were not for the new vehicles, would be happening to users of the vehicles they replace.

Another thing to remember is that for innumerable centuries humanity has been learning how to keep out of the way of horses and the carriages they draw, while its experience with automobiles began less than twenty years ago, and evasion of them has not yet become instinctive and automatic. All of us can remember when "the murderous trolley car" claimed its daily victims, and motor-men were the constant objects of just such denunciation as the chauffeurs are now receiving. The cars are run to-day much as they always were—only faster—but, considering their enormous number, they do little harm.

Of course, there is in all this no excuse for the doings of reckless, drunken, or incompetent chauffeurs, and the problem of their proper control or abolition must be studied till a solution of it is reached, but there is some reason for viewing the situation as it is. We may be happy yet, even with the automobiles steadily increasing in numbers daily.

NEW YORK TO PAY ANNUALLY AND ABOLISH SPEED LIMITS

ALBANY, N. Y., April 19.—As the result of the conference held between legislators and representatives of the automobilists, an agreement last week was reached on the provision of a new motor vehicle law, which was quickly introduced in the form of an amendment to the State highway law. The measure is now in the hands of the Finance Committee of the Senate.

The agreement included the taking of the Allds-Hamn bill of last year; which was reintroduced early this session, and the making over of it where it did not coincide with the plan and scope of the conference.

Horsepower to Be the Basis.—By the proposed new law horsepower is to be the basis of the registration fee whereby automobile owners are to pay their share toward the repair and maintenance of the highways of the State.

The provision settled upon was that of the uniform laws commission of last Summer, with a slight increase over its rates. It is provided in the new bill that each owner shall pay an annual fee to the Secretary of State of \$4 for each car he owns of 20-horsepower or less; \$6 for each car of between 20 and 30-horsepower, and \$10 for all machines of over 30-horsepower. This is expected to raise an annual revenue of over half a million, which shall be turned over to the State treasury to be used for the repair and maintenance of highways.

All Speed Limit Laws Are to Be Repealed.—There will be no speed prescribed as lawful, and therefore there will be no auto-traps and no graft for the country or other justices. The motor vehicle driver will be placed on the same equality with the driver of a horse-drawn vehicle in that neither may drive recklessly so as to endanger life and property at any rate of speed. This will make it possible to **arrest a reckless driver on a congested street** who may be driving at a speed of not more than five miles an hour and yet may be endangering the lives of pedestrians. The same vehicle may be driven 20 miles an hour early in the morning without endangering anyone.

The penalties prescribed are a fine of \$50 for the first offense; a fine of \$50 or thirty days' imprisonment for the **second offense**; and a fine of \$50 and thirty days or possibly six months' imprisonment for the third offense, and a clause for the suspension of the driver who thrice offends may be put in.

These penalty clauses may be worked out somewhat differently before the bill is passed.

Professional chauffeurs are to pay \$10 for their first license and \$5 a year for its renewal; the Secretary of State shall furnish an official badge, the design and color of which he shall determine, and the color shall change each year.

The common rules of the road, which seem to have been left out of the highway law, will be reinserted to **cover all vehicles** using the highways, and fixing by statute that vehicles meeting shall turn to the right and shall pass to the left, etc.

Among those present at the conference were: Senators Allds and Heacock and Assemblyman Hamn; H. A. Meldrum, president of the New York State Automobile Association, and Oliver A. Quayle, chairman of its legislative committee; Superintendent of Insurance William H. Hotchkiss, ex-president of the A. A. A.; F. H. Elliott, secretary of the A. A. A.; Charles T. Terry, representing the National Association of Automobile Manufacturers; Alfred Ely, representing the Automobile Club of America; Giles Stillwell, of Syracuse, and several others.

The wording of the new law, which is to obviate the present speed limit provision is this:

Every person operating a motor vehicle on the public highways of this State shall drive the same in a careful manner and at a rate of speed so as not to endanger the life or limb or property of any person.

The anti-joy ride and anti-tampering provision is as follows:

Any person using or operating, driving, injuring, or tampering with a motor vehicle without the permission of the owner is punishable by a fine of not exceeding \$100, or imprisonment of not more than six months, or the suspension of the right to operate a motor vehicle as a registered chauffeur for not more than six months, or all of such penalties.

Automobiles used solely for commercial purposes, or which are propelled by electric battery power, or are used or to be used solely within the confines of a city, are to pay only a nominal license fee of \$2, without regard to their horsepower, as they would not use the good roads.

The registration fees imposed shall be in lieu of all of the taxes, general or local, to which motor vehicles might be sub-subject as personal property.

PENNSYLVANIA, LAW IMPROVED, GRANTS RECIPROCITY

HARRISBURG, PA., April 19.—Reciprocity for automobilists from other States; an increased speed limit; uniform speed and license regulations; a new rate of fees; and the provision that all fines shall be reported to the State Treasurer, are the subjects which have been accorded special treatment in the Keystone State's new automobile law. These features are embodied in the Townsend Senate bill, which after an intermingling with the Grim House bill, has finally passed the Legislature and but awaits the signature of the State's autoing executive, Governor Stuart, to make it a law in immediate effect. The Pennsylvania Motor Federation figured much in the passage of the measure.

Broad-minded in its provisions, and superseding other statutes with which general fault has been found, the enactment is a pleasing one to automobilists, representing the result of a great deal of hard labor against a few legislators who would have had narrow policies enforced. Of premier importance is the clause which allows tourists from other commonwealths to enter the borders of this one without having to make extensive arrangements for being licensed beforehand. A limit of ten days is set, however, during which the license tags of **States which similarly recognize** those of Pennsylvania, will permit the use of the roads. There is no statement in the law preventing a visitor from be-

ing within the State for more than one period during a year.

The licensing of resident cars and owners will hereafter be carried out along different lines from those now in effect. A fee of \$5 is required for cars of less than 20-horsepower; \$10 for those of more than 20 and less than 50; and \$15 for those of 50-horsepower or more. Motorcyclists are required to pay \$2, but do not have to carry tags.

Dealers and manufacturers will be allowed to have five sets of licenses and tags, and each set will be sold for \$5. In addition, the operators of these company cars must be licensed, at \$2 each, and must wear badges.

Uniformity was a prime requisite asked by automobilists, and their desires have been heeded, in at least two particulars: that the State law should be the only one, that municipalities should not be allowed to issue city licenses, and that all such regulations in effect now shall be declared void. This was mainly a hit at the Quaker City, which has required operators to take out local licenses. The other consideration is that of speed, for by the new law 24 miles per hour is set as the maximum legal limit, with 15 as that required in built-up sections of towns and cities. The only qualifications placed upon this are those of recklessness, and that when approaching a street car which has stopped to dis-

charge passengers, the automobilists **must stop or not endeavor to pass on the side from which persons are alighting.** The speed law cannot be altered by localities, except in the case of public parks, which may restrict the speed, but not to a lower degree than that of other vehicles.

In the matter of fines there was a determined effort on the part of automobile owners, through the clubs, to have some regulations which would stop the petty graft known to have been carried on by a number of township officials, justices and constables. Opinions were divided as to whether the fines should be turned into the State treasury, to be used in road construction, along with the license fees, or whether they should be allowed to remain in the townships, but with requirements as to reports which would prevent misappropriation. It was finally decided that the fines for speeding shall be used by the townships authorities, but the collectors who receive these fees are now required to give a sworn detailed statement quarterly. All penalties imposed for other acts than fast traveling must be sent at once to the general State fund.

Prevalence of joy-riding and flagrant use of cars influenced

those who framed the act to aim directly at the atrocious custom, especially in the matter of fines, and they are now exceptionally heavy: \$100 to \$300 for the operation of a car by an intoxicated person, with the probability of a year in jail, or both, and a suspension of the license. A sum of \$100 is the cost of using a car without the knowledge of its owner, and perhaps a year.

For speeding, however, the penalties are not so large, ranging from \$10 to \$25 for a first offense; a second offense within a year may cost between \$25 and \$50, or 20 days in the county prison; and a third dereliction is rated at from \$50 to \$200, or 30 days. Jury trials may be obtained, if desired.

Constables and officers may arrest upon sight without a warrant, but must file with a magistrate an affidavit setting forth the reasons, and furnish the autoist with a copy. If a car is seen violating the provisions of the law, the license is taken as prima facie evidence that the owner is in it, and he will be held responsible unless he can show who was really the operator.

The Townsend bill will go into effect as soon as signed, except as relating to the licensing of Pennsylvania residents, who shall be governed by the present statute until December 31, 1909.

NEW JERSEY LAW BROUGHT FAIRLY UP-TO-DATE

TRENTON, N. J., April 19.—Governor Fort today signed three of the six automobile bills passed by the legislature, and announced that he will sign the remaining three on Wednesday. Automobilists all over the State are elated at their success in obtaining the passage of these measures, which at least eliminate all the medieval features of the former statutes and in some respects are an advance upon those of some other States. Complete reciprocity in the licensing of non-residents has not yet been granted, but they are permitted to remain in the State for eight consecutive days, or for four periods of two days each, on the payment of a fee of one dollar. Offsetting this is the provision that all vehicles must carry a light at night—a feature which automobilists have always advocated.

The three bills which are now law provide as follows: First, that it be a misdemeanor to drive an automobile without the consent of the owner, or while in an intoxicated condition, or for a bet or wager, or to break a record, or after license has been revoked, or to fail to display a registration number or to display a false registration number; second, that the funds already collected from licenses, registration fees, and fines, amounting to about \$300,000, be released for immediate use in road repairing; third, that the Commissioner of Roads be given two competent engineers as assistants.

Of the measures which will be signed Wednesday, the first is that providing for the lighting of all vehicles at night, on penalty of a fine of one dollar for each offense. Non-residents are permitted to use their machines in the State for a limited time,

as explained above; the licenses may be obtained on written application, inclosing the fee of one dollar, and in case the applicant is properly registered in his home state, he need not take out a driver's license in New Jersey. The last and, at least to the native automobilists, the most important bill does away with the absurd requirement of numbers on the front lamps, fixes **twenty-five miles an hour** as the maximum speed limit in open country where the houses are more than 100 feet apart, and reduces the fees allowed justices of the peace, constables, and witnesses to such a low figure that there will no longer be any incentive to make wholesale arrests.

The passage of these bills is an example of the power which can be wielded by a firm organization of clubs. The automobilists carried on their campaign in a businesslike way, obtaining the aid of boards of trade and other influential associations all over the State. Much credit is due Joseph H. Wood, chairman of the legislative committee of the Associated Automobile Clubs of New Jersey, for his constant and fruitful activity. As a result of their efforts the automobilists have obtained a reasonable and consistent law, which grants freedom from petty annoyances in the guise of "Jersey justice," and which will no longer drive away their visitors.

In the past New Jersey's reputation has kept away thousands of tourists who otherwise would have spent weeks at the beaches and summer hotels. The greater prosperity of these resorts should serve as an example to other States of the advantages of an equitable automobile law.

CONNECTICUT TO HAVE COMMISSIONER OF MOTOR VEHICLES

HARTFORD, Conn., April 19.—The automobile bill drawn up by the committee on roads, rivers and bridges, as well as the bill providing for the establishment of the office of commissioner of motor vehicles, was reported to the Senate and is due to be taken from the table this week. The commissioner of motor vehicles measure is not regarded with any great enthusiasm by the automobilists of the State, but they believe that if it is rejected they may expect the enactment of a law giving justices' courts the power of revocation of licenses. That, of course, would mean chaos, and the former bill seems the lesser of the two evils. It is possible to secure a fair-minded commissioner who will be reasonable in the execution of the automobile laws, whereas if the rural courts should have the power to keep

an owner from using the roads, because of the revocation of the license, this State will not be the most pleasant one for automobilists. The hotel men have joined the auto people in the demand for proper consideration of tourists.

The chief objection to the bill drawn up by the committee on roads, rivers, and bridges is the provision calling for a speed of ten miles per hour at intersecting streets. It is pointed out that this would give the country constables a fine opportunity to re-establish their speed traps, which have been decidedly in the background under the present law. Considerable opposition in both houses is expected from the representatives of the rural districts, as there is still much feeling against out-of-State automobilists who habitually drive at express-train speed.

PITTSBURGH GAINS SOME NEW FACTORIES.

PITTSBURGH, April 20.—Greater Pittsburgh is soon to get three automobile manufacturing plants, if present prospects count for anything. This city has turned out to be one of the best automobile buying centers in the country, and this has encouraged manufacturers to seek locations near Pittsburgh for their new plants. The new plants which will be located in this district are those of the Belden Motor Car Company, the Perfection Magneto & Commonsense Auto Company, and a new concern headed by C. P. Munch, general manager of the Buffalo & Susquehanna Coal Company, of DuBois.

The Belden Company has been located in this city for several years, with offices in the Bessemer building. Its new car, the invention of Edward H. Belden, elicited much comment at the recent local show. The company has practically decided to locate the plant at Ambridge, the new industrial town, 30 miles down the Ohio river, where the great plants of the American Bridge Company were located five years ago. The plant for which plans are now being prepared will employ at least 2,000 hands, and definite announcements regarding it will be made within the next 60 days.

The Perfection Magneto and Commonsense Automobile Company last week bought the property of the Ambridge Lumber Company, also at Ambridge, and will move its factory there from Anderson, Ind. Just as soon as improvements are made to the plant the company will start work with 50 men to manufacture specially designed automobiles and magnetos. The company later expects to employ 150 men. F. C. Borden, president of the company, has been in the Pittsburgh district for several weeks negotiating for a site. He is also secretary of the Sanitary Manufacturing Company, of Salem, Ohio, and the Pittsburgh manager of the Russell Engine Company, which has a capital of \$1,500,000. T. K. Bevington will be general manager of the Commonsense Company.

C. P. Munch is promoting the third concern which proposes to manufacture automobiles in this district, and it will complete its organization probably this week. The company will have ample capital. The car which it will manufacture will be known as the "Pennsylvania No. Six." It has been manufactured hitherto at Massillon, O., by the W. S. Reed Co., and was there known as the "Massillon Six." Orders for 30 cars have been placed with the Howard Motor Company, of Yonkers, which will manufacture the new machine until a plant can be erected. W. S. Howard is identified with the new company. The "Pennsylvania No. Six" will sell for \$2,250, and the plant proposed will employ at least 500 men.

"Pittsburg Six."—For more than a year another car has been manufactured very successfully at New Kensington, Pa., twenty miles up the Allegheny river. This has been known as the "Pittsburgh Six," and is a good seller in this district. Commercial vehicles have also been manufactured in Pittsburgh on a small scale, and it is possible that a plant may be built soon.

A. C. A. HAS TALK ON TIRES.

NEW YORK, April 20.—Demountable rims and other improvements in tire construction and application were thoroughly discussed this evening before members of the Automobile Club of America. Representatives of several large manufacturers explained the merits of their particular goods, with opportunities given for the deflation of their arguments. The new demountable rims were given the most time, for there were several shown and demonstrated which have but recently been exploited. Those who spoke were: P. W. Litchfield, superintendent of the Good-year Tire & Rubber Company; Alexander Dow, Dow rims; F. G. Hill, Republic; J. B. Cothran, Continental; Orrel A. Parker, Newmastic; C. B. Whittelsey, Hartford Rubber Works factory; Marcus Allen, Empire; Dr. Doolittle, Doolittle rims; and A. Harris, Kempshall. Previous to the tire talk the Snell method of storing and supplying gasoline to garages was explained, illustrated with a working model. About 200 club members and friends attended.

TOLEDO SALE AND POPE COMPANY PLANS.

HARTFORD, CONN., April 19.—In the event of the sale of the Toledo plant of the Pope Manufacturing Company, it is the intention to retire the issue of \$266,000 of the six per cent. notes due August 1, 1910, and by appropriation of about \$50,000 from the current earnings the company will be able to take up the issue of \$267,000 which matures August 1, 1909. Such action would leave earnings of about \$350,000 applicable to the two classes of stock in the event of the consummation of the sale of the Toledo plant to the Overland company, which is now regarded in this section as a foregone conclusion. It is assumed that through the reorganization of the Pope Company, the operation of the two plants at Hartford and Westfield would net an annual income of about \$400,000. With these earnings the company could pay 6 per cent. on the \$2,500,000 of preferred stock, and then have a remainder of \$250,000 for the \$4,000,000 of common stock. Whether these sums will be distributed will depend on the financial situation and the policy adopted by the board regarding the accumulation of a surplus and a working capital. It is expected here that the sale to the Overland interests will net the Pope Company about \$500,000.

TRANS-PENNSYLVANIA ROAD ASSURED.

HARRISBURG, PA., April 19.—Pennsylvania will have a trans-State highway, from Philadelphia to the Ohio State line, including Harrisburg en route. Such has been provided for in the highway bill which was passed last week just as the Legislature was about to adjourn, and which had a stormy voyage between the two houses before it was adopted. The movement was started toward finality by Governor Stuart, who has fostered the matter since it was first suggested, even to touring over proposed routes, and the dream of a fine road across the commonwealth will probably be realized before long.

Within six weeks, funds aggregating \$3,000,000 will be available for the commencement of the undertaking, to be spread over two years from May 31, with an additional million in each of the two following years, the entire sum set aside being \$5,000,000.

SELDEN FACTORY NOT DAMAGED BY FIRE.

ROCHESTER, N. Y., April 19.—Since the recent disastrous fire in this city the Selden Motor Vehicle Company has been busily engaged denying reports that its factory was destroyed. The factory which was burned was one built by Judge H. R. Selden, the father of George B. Selden, president of the present company, and was sold to the Palmer Company. The conflagration did not injure the plant of the Selden Company, and the Selden cars are being produced as regularly as before.

NORTH JERSEY AUTOISTS HAVE ELECTION.

PATERSON, N. J., April 19.—The annual meeting of the North Jersey Automobile Club resulted as follows: President, W. G. Norwood; vice-president, J. N. Faulkner, M.D.; second vice-president, B. Eastwood; secretary and treasurer, James Madden; captain, Harry McGinley; first lieutenant, Charles Frost; second lieutenant, W. M. Jacobus; counsel, Jacob Vanderclack. George A. Post, who has been a most conscientious president for several years, declined a continuance in office.

PETREL WILL MOVE TO MILWAUKEE.

KENOSHA, WIS., April 19.—The Petrel Motor Car Company, of this city, has secured a new factory at 470-480 Virginia street, Milwaukee, where it will be enabled to multiply its present output four or five times. The removal will take place May 1.

GILLETTE TO REPRESENT CONTEST BOARD.

HARTFORD, CONN., April 19.—C. H. Gillette has been appointed official representative of the contest board of the A. A. A. and will have entire control of all automobile contests in this locality.



New Headquarters of Herz & Company, New York City.

THE AMERICAN HOUSE OF HERZ.

Coincident with the enormous increase in the business of automobile manufacturers there has been a parallel one for the makers of automobile parts and supplies, necessitating enlarged facilities for production, a maximum output of high-grade goods and often a change of headquarters. This has been the recent experience of Herz & Company, of New York, Vienna and Stuttgart, which has moved northward along Lafayette street, in New York, to the corner of Houston, where it has found factory space for the extension of its trade. Under the direction of G. L. Herz, who spends half of each year in this country and half in Europe, the new plant is now working day and night to fill its orders for ignition and other specialties, all but a small part of which are used by automobile factories.

The New York factory is used in making timers, distributors, air pumps, spark plugs and shock-absorbers. The Herz magnetos are all made in Germany and imported complete for American use. Wire cables and copper gaskets are also products of the Herz European plants, the reason for this, according to Mr. Herz, being that the more skilful workmen do not leave their home towns and cannot be induced to go away to other countries. Much of the manufacture of these devices requires handwork. At the same time much of the material, such as compressed fiber and rubber, can be secured of higher quality abroad.

By its change in location the metropolitan house is now fully equipped to manufacture the parts which the firm markets; 30 machine tools, many of them special in design and construction to meet the needs, operated by experienced workmen, are in con-

stant use. Castings for the pumps are machined; platinum alloy electrodes for spark plugs are stamped from ribbons of the expensive material; timer cams, ball races and contacts are hardened, and many of the lines are assembled under the direction of the head of the firm. One of the feature machines of the shop is that which grinds the interior of the roller-contact timers.

Six different styles of magnetos are now built by the Herz company and imported into this country. One which is receiving the attention of the makers at present is a light one for aerial ignition, where high-speed work is necessary and high efficiency required. This is one of the lightest devices of its kind ever made, and it gives a very hot spark at low speeds, such as when the armature is revolved by the fingers, being then of such intensity as to jump an eighth-of-an-inch gap. The growth of the motorcycle business in America can be appreciated from the fact that over 4,500 Herz magnetos for this type of machine have been received during the past fiscal year. Of the 12 types of timers made, two have just been put upon the market, of special design and embodying improved features, such as tool-steel contacts, ball bearings, fiber insulation and absolute rigidity. These devices are made in the New York factory, as are also the air pumps, which are used for pumping tires, blowing whistles on motor boats, or for securing air pressure for other uses. A feature of the Herz pumps is that there is no leather about them, the gray iron pistons having two rings of the same material. They are friction driven.

Bougie Mercedes plugs, with double stone insulation, are claimed to be self-cleaning and not open to short-circuiting or fouling. The electrode has six points, instead of one, set eccentrically so that the spark-gaps vary from 1-4 to 1-2 of a millimeter, the idea being to take advantage of the varying intensity of the magneto spark as the speed of the engine changes. These changes are accommodated in the plug. The cleaning property is secured by the construction, which allows the gas compressed in the plug chamber to blow out around the electrode, blowing any oil or carbon deposits away from the electrode.

The business of the accessory manufacturers is a good barometer of conditions of the general automobile business, and of this Mr. Herz says: "The factory business must be enormous, as indicated by the pressure brought to bear upon us for faster delivery of our products. Our orders on file would require us to double our capacity, and we have had to take on night work. The trade this year is utterly beyond comparison with that of a year ago. Then it was not good. I will go to Germany very shortly to hurry affairs there and try to get more material."

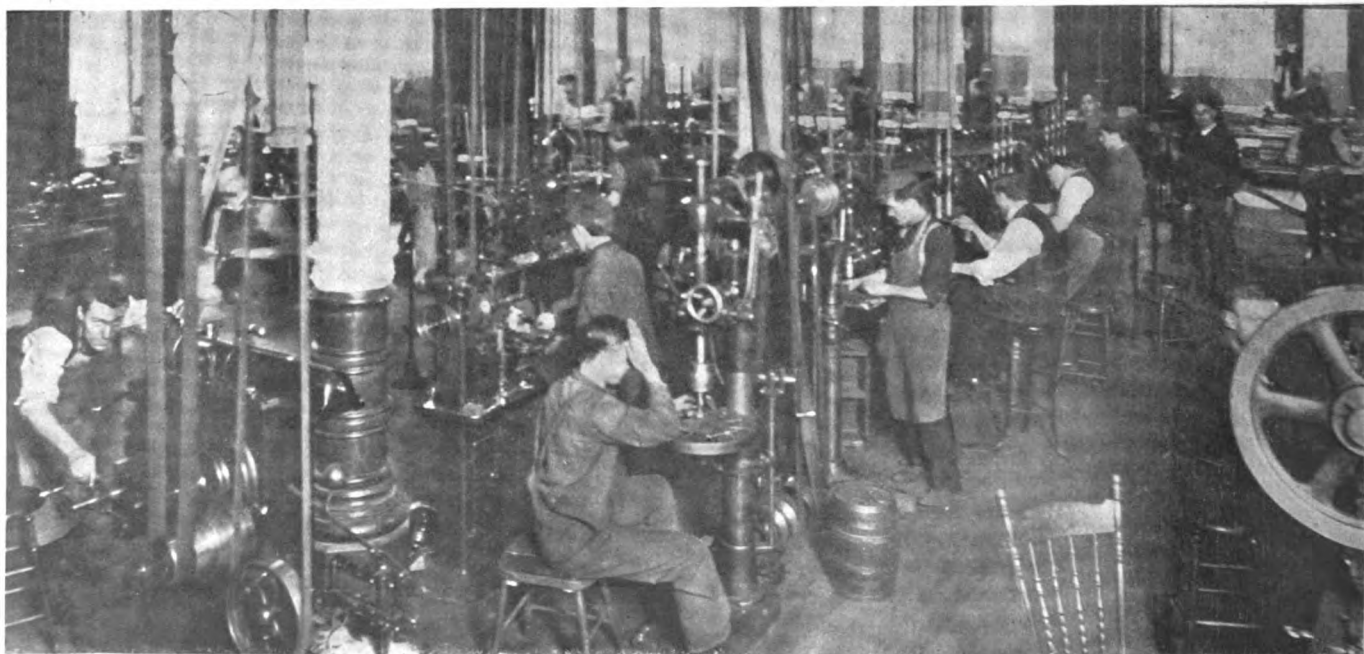

One of the Work Rooms in the New York Plant Where the Herz Specialties are Made.

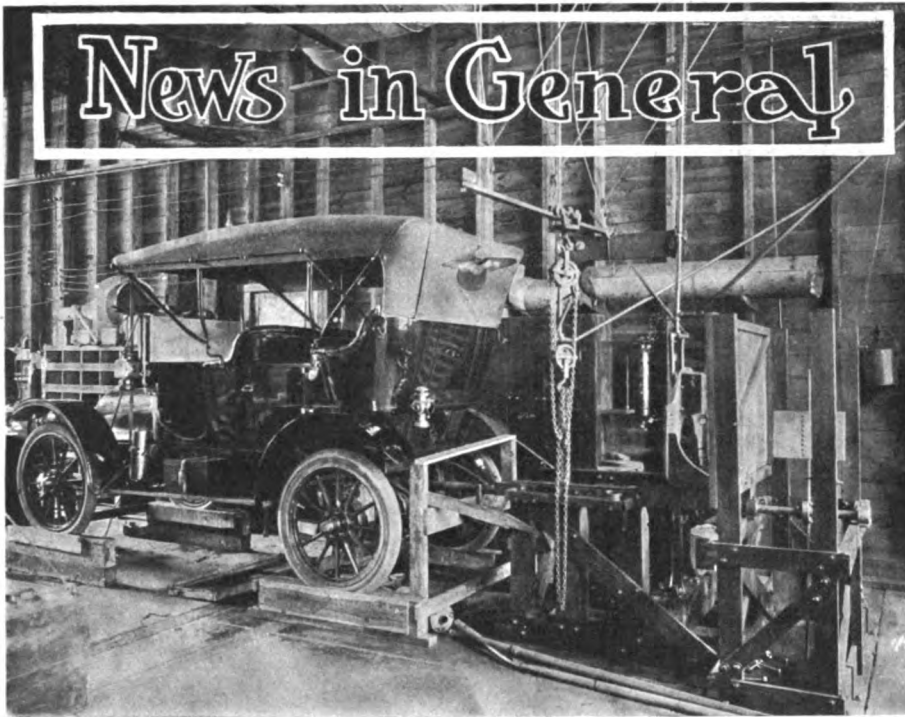

Testing Horsepower of Franklin Engine in Completed Car.

In testing the horsepower of engines at the Franklin factory, Syracuse, N. Y., the engine shaft of the car is connected with a fan dynamometer, by which any desired load can be put on. The revolutions per minute, gasoline and oil consumption, and the horsepower are noted. Ordinarily only the engine is tested, but the testing room is so arranged that a completed car can be admitted, the engine shaft extended out through the rear of the running gear, and complete readings made with the dynamometer.

Rambler Fined for Beating Interurban Car.—An unusual result came of a fast brush between a Rambler touring car and a limited express interurban car on the Louisville and Eastern Railroad, according to Prince Wells, the Louisville, Ky., representative of the Rambler cars. It seems that W. W. Litter of that city, was driving his model 45 Rambler touring car on the Shelbyville pike, which is parallel with the electric railroad, and in a four or five mile race with the fast trolley car, beat it to a crossing on the main pike, the speedometer showing 60 miles an hour. The vanquished motorman and conductor deliberately went into court, and testified against the automobilist, causing him to be fined for fast driving. The judge fined Mr. Litter 1 cent and costs.

Another Pierce for the White House.—A second Pierce-Arrow car for the use of President Taft and his family has been shipped by the Pierce-Arrow Motor Company, of Buffalo, to Washington. The new car is a six-cylinder, 36-horsepower landaulet, and is upholstered in gray whipcord, with the national coat of arms emblazoned upon the door panels. The first Pierce purchased was ordered last February, and is a six-cylinder suburban of 48-horsepower. An extra touring body for this car has been ordered, so that the new landaulet will be used in inclement weather in the summer and fall. All of the bodies are painted a dark blue, with a russet stripe following the lines of the moulding.

The "Diamond" Girl.—The latest and by far the prettiest girl to make her appearance is the "Diamond" girl. This is a large poster sent out by the Diamond Rubber Company and shows a young lady in clown's attire apparently having a fine time at a masked ball. It seems to be unmasking time, for she holds her mask in her hand. The costume of white, with longitudinal blue stripes,

contrasts well with the red background, and the effectiveness of the whole is increased by the absence of advertising matter. The only reference to the publishers is the two words, "Diamond Tires," on the buttons of the costume.

Renault Wins New Zealand Trials.—Paul Lacroix, manager of the Renault Freres selling branch, New York City, has received word that a 14-20-horsepower Renault car was the successful contender in the New Zealand Automobile Club's reliability trials which extended over four days. The prize was the Star trophy. There were five competitors, and the Renault and a Star of 12-horsepower furnished most of the interest. Both made perfect non-stop scores on the first three days and on the fourth the Renault lost one point and the Star five, with the result that the Renault won.

Large Increase in Sale of Bakers.—"1909 is unquestionably an electric year," according to F. R. White, general manager of the Baker Motor Vehicle Company, who tells of the remarkable increase in the demand for electric automobiles. Of the business in Baker cars, he says: "Our sales for the month of March showed an increase of 300 per cent, over the best month in the history of our company, and even though we have largely increased our factory force we are running day and night endeavoring to turn out cars fast enough to supply the demand for Baker Electrics."

KisselKar Climbs Steep Texas Bluff.—An incline of 43 per cent., the steepest bluff in the State of Texas, has been successfully negotiated by a 30-horsepower KisselKar, according to advices from Dallas. Carrying four passengers, the car twice made the climb, over a dry bed of a stream filled with crumpled lime stone, shale and ridges. After making the first climb, and reporting it, the feat was challenged, so to prove the veracity

of those interested the test was accomplished a second time. It is said that nine other cars tried the hill, but the Kissel-Kar was the first to reach the summit.

Spring Meeting of Mechanical Engineers.—The American Society of Mechanical Engineers will hold its Spring meeting in Washington, D. C., May 4 to 7. Professional sessions will be held at which papers on the conveying of materials, gas power engineering, steam turbines, the specific volume of saturated steam, oil well pumping and other subjects will be considered. The members will be received by President Taft and will be given a special exhibition drill of troops by the War Department.

College Men Plan 3,200 Mile Tour.—Boston has been made the starting point of a 3,200-mile automobile tour through Europe, from Glasgow to Naples, by the Motor Touring Club of Syracuse University. The college men will sail on June 25, with their cars, and expect to be home by September 12, making a tour of 81 days. They calculate their expenses at about \$650 per man.

Sells Motor Boats to Autoists.—Among the recent arrivals in New York's automobile row is the Atlantic Company, of Amesbury, Mass., manufacturers of motor boats and engines. Under the management of R. C. R. Binder, a branch has been opened at 1619 Broadway. A temporary branch was opened last Spring and a number of boats sold to men prominent in the automobile trade.

HAPPENINGS AT THE FACTORIES.

Mitchell, Racine, Wis.—Work on the new buildings for the Mitchell Motor Car Company, is rapidly progressing. The new \$80,000 office building is well under way, and the masons in charge of laying the foundations for the concrete factory additions have commenced operations. The company is contemplating the building of a circular race course on a tract recently purchased south of the city. This will give a testing ground aside from the public streets and country roads.

Stoddard-Dayton, Dayton, O.—Permits for the erection of a six-story concrete building have been issued to the Dayton Motor Car Company, the manufacturer of Stoddard-Dayton cars. It will be located at the corner of McDonough and Bacon streets, on the site of the present power plant. The latter will be razed, and in the meantime power will be supplied from outside sources.

Peerless, Cleveland.—The Peerless Motor Car Company has increased its capitalization from \$600,000 to \$3,000,000, under the laws of Ohio. It was formerly a West Virginia corporation. The incorporators were: G. B. Siddall, L. H. Kittridge, F. I. Harding, E. H. Parkhurst, John F. Demsey.

Speedwell, Dayton, O.—The erection of several new buildings is now being planned by the Speedwell Motor Car Company of Dayton, O. An increase of business has required enlarged manufacturing facilities.

Union, Albany, Ind.—The Union Auto Car Company of Albany, Ind., will shortly move to Seymour, Ind., where a new building will be used in the manufacture of touring cars and runabouts. New capital has been invested in the concern.

Lyman, Buffalo.—The Lyman Manufacturing Company of Buffalo, has purchased a brick factory, 46 by 150 feet

in size, which will be equipped for the manufacture of Austin-Lyman automobiles, and for general machine work.

Frisbie, Middletown, Conn.—The Frisbie Motor Company has filed with the Secretary of State a certificate of its action in changing its name to the Frisbie-Heft Motor Company.

Babcock, Buffalo.—The Babcock Electric Carriage Company has arranged for the building of an addition 40 by 100 for constructing electric automobiles.

IN AND ABOUT THE AGENCIES.

Neustadt & De Prez Form Company.—A new selling company for the Pacific Coast has been organized by J. H. Neustadt and Eugene De Prez under the name of the Pacific Sales Corporation, with main offices at 50-56 Van Ness avenue, San Francisco, Cal., which will act as factory sales agent, covering the territory from Los Angeles, Cal., to Vancouver, B. C., west of the Rockies, and doing exclusively a wholesale business—selling manufacturers and jobbers only. Mr. Neustadt and Mr. De Prez are well known to the trade, having formerly conducted an exceedingly successful business in St. Louis, Mo.—that of the Neustadt Auto & Supply Company, and which they sold some six months ago.

Splitdorf Opens European Agencies.—The success of the Splitdorf ignition apparatus at the Paris show, and demands for these goods by European manufacturers, has led to the establishment of Splitdorf agencies in the principal cities. They are: Paris, 88 Avenue des Ternes; London, 139 Long Acre; Turin, Italy, 64 Via Santa Chiara; Brussels, Belgium, 33 Square Guttenberg; and Barcelona, Spain, 433 Consejo de Ciente.

Royal Tourist Branches.—The Royal Tourist Car Company has opened branches in New York and Chicago, the former at the corner of Broadway and 62d street, and the latter at 1253 Michigan avenue. Both of these have excellent locations, and equipped with factory facilities. These houses, as well as the agencies in other large cities, Boston, Philadelphia, Baltimore and elsewhere, have been meeting with great success in selling the new Royal Tourist cars.

RECENT BUSINESS CHANGES.

National Sales Corporation Will Move.—An entire building at 232 West Fifty-eighth street, New York City, has been taken jointly by the National Sales Corporation and the Emil Grossman Company, and will be occupied on May 1. There are three floors, 20 by 100 feet in size, in the structure and, being right in the heart of the automobile district, will give the concerns an additional advantage in the trade. A complete stock of hydraulic and spring-action wind shields, Red Head spark plugs, Peugeot chains and rims and Pirelli tires will be carried.

Henry W. Price Company Changes Name.—The firm name of the Henry W. Price Company, of Rockford, Ill., makers of the "Price" line of gloves, has been changed to the Fried-Ostermann Company, and a radical change made in the policies. E. C. Ostermann states that, "The watchwords of this concern will in the future be 'quality, progression, and aggression.' Both Mr. Fried and myself have been connected with the Price concern for years, and have long contemplated this change."

Loring Auto Appliance Company Moves.—Having outgrown both its present offices and factory at 1777 Broadway, New York City, the Loring Auto Appliance Company, Inc., has leased the entire building at 42 West 43d street, and will take possession on May 1. A number of new accessories have been taken on, and the concern will be prepared to branch out in these.

PERSONAL TRADE MENTION.

Arthur N. Jarvis, one of the pioneer writers on automobile subjects, has been engaged by the Contest Board of the American Automobile Association to send out the official news and other information concerning the "Sixth Annual Reliability Touring Contest" of the A. A. A. This means that the work will be exceptionally well done, and the material which reaches editorial desks will be practically ready for the printer.

Charles C. Craig has been appointed manager of the Chicago branch of the Haynes Automobile Company, to take effect at once, succeeding J. B. Seibler. Mr. Craig is well known in the trade, having been identified with the industry for some years, principally in the capacity of traveling salesman for the Haynes and other companies.

Montague Roberts, the racing driver, has been appointed to the engineering boards of the Herreshoff Motor Company, of Detroit, and the Bristol Engineering Corporation, of Bristol, Conn. Since December he has been testing out the Herreshoff cars at Detroit, and he will do the same work with the new Houpt cars at Bristol.

Otis R. Cook has joined the forces of the Federal Rubber Company of Cudahy, near Milwaukee, Wis., as manager of the tire departments. James W. Devine accompanies Mr. Cook as his assistant. The company has established general offices in Milwaukee, with a branch at Milwaukee and Oneida streets.

Joseph B. Deibler has resigned as manager of the Chicago branch of the Haynes Automobile Company, which he has held for six years. He has not announced his intentions for the present, but in May will take a tour in a Haynes to a Dakota ranch for a vacation.

James Joyce, manager of the automobile department of the American Locomotive Company; C. B. Denney, treasurer of the company, and Leigh Best, vice-president of the company, are rusticating at Farmington, Conn., making their headquarters at the Country Club.

Gilbert U. Burdette, who has been in charge of Packard interests in Newark, N. J., has retired from the Packard agency, and joined the forces of the Atlantic Motor Car Company, in the management with C. J. McShane.

E. W. McGookin, sales manager of the Stewart & Clark Manufacturing Company of Chicago, has assumed the management of the Detroit branch, at 697 Woodward avenue.

David Landau, of the Palmer & Singer Manufacturing Company, has been appointed chief engineer, in the place of Oscar Stegeman who recently resigned.

Geo. H. Brown, secretary and treasurer of the Winton Company, and Mrs. Brown have returned to Cleveland from a visit to Atlantic coast points.

Charles A. Singer, Jr., has been appointed general sales manager of the Palmer & Singer Mfg. Co.

RECENT INCORPORATIONS.

Gilbert Manufacturing Company, New Haven, Conn.—Capital \$12,000. To manufacture motorcycles and motorcycle parts. Incorporators: F. E. Bowers, E. B. Spalding, Louis F. Meyer.

Sterling Gas Machine and Manufacturing Company, Camden, N. J.—Capital \$25,000. To manufacture carburetors and gas machines. Incorporators: L. C. Simpson, J. W. Mills, G. A. Darlington.

Barrell Pneumatic Tire Protector Company, Boston.—Capital \$50,000. To manufacture and sell auto tires. President, H. A. Crossman; treasurer, R. H. Kammeler; clerk, A. E. Carson.

Commercial Motor Car and Engine Company, Chicago.—Capital \$20,000. General mercantile and manufacturing business. Incorporators: W. S. Mills, F. M. Olson, P. W. Kerr.

W. & R. Motor Truck Company, Taunton, Mass.—Capital \$50,000. General express business. President, F. S. Hall; treasurer and clerk, F. E. Wellman; attorney, Louis Swig.

Victor Tire Traction Company, Boston.—Capital \$50,000. To manufacture and sell tires. President, H. A. Crossman; treasurer, R. H. Kammeler; clerk, A. E. Carson.

Auto Lock Company, Chicago.—Capital \$50,000. To manufacture and deal in automobiles and accessories. Incorporators: R. W. Dunn, C. J. Monohan, L. A. Wisner.

American Body Company, Buffalo, N. Y.—Capital \$10,000. To manufacture motor and other vehicles. Incorporators: Edward W. Selkirk, E. J. Freitas, J. W. Kelly.

C. N. Cady Company, Canastota, N. Y.—Capital \$60,000. To manufacture motors, engines, machines, etc. Incorporators: C. N. Cady, G. B. Cady Jr., Minnie A. Cady.

Omnium Tire Import Company, New York.—Capital \$10,000. To deal in automobile tires, sundries and supplies. Incorporators: Simon and Bourchard Haas, Edgar Block.

North Jersey Garage, Morristown, N. J.—Capital \$25,000. To manufacture automobiles. Incorporators: R. H. Nevins, R. S. Foster, Joseph Van Dyke, Harvey Archer.

Hilton Manufacturing Company, Boston.—Capital \$100,000. To manufacture and sell automobile supplies. President, R. W. Sawyer, Jr.; treasurer, J. S. Stone.

Fulton Livery Company, Fulton, N. Y.—Capital \$20,000. To run an auto livery and rent cars. Incorporators: M. A. Thomson, C. A. Reynolds, G. S. Piper.

Sloane Motor Company, Chicago.—Capital \$35,000. To manufacture motors and accessories. Incorporators: A. W. Baer, W. W. Sloane, D. M. Carter.

Virginia Garage Corporation, Roanoke, Va.—Capital from \$1,000 to \$25,000. To do a garage business.

Cotta Transmission Company, Rockford, Ill.—Capital \$40,000. To manufacture automobiles and accessories.

NEW AGENCIES ESTABLISHED.

Middleby: New York City.—Audobon Garage & Machine Works, 415 West 150th street, for New York City, except Brooklyn. D. L. Ormsby, proprietor.

Selden, Atlanta, Ga.—Selden Car Company, Columbia Garage, Edgewood avenue and Ivy street, G. G. Reid, sales manager.

Rambler: Lawrence, N. J.—Frank W. Thatcher.

Maxwell, Elmira, N. Y.—Jennison & Shea.



End of a Joy Ride.

A borrowed touring car dashed down Michigan avenue, Chicago, and into the window of the Firestone Rubber Co.'s branch as if in search of the non-skids which it lacked.

SOME SELECTED AUTOMOBILE PATENTS

Issue of April 6, 1909.

916,972. Explosive Engine.—Linton T. Bassett, Salem, Mass. Filed Jan. 3, 1908. The Bassett motor has an air cylinder concentrically placed around the lower extension of the cylinder walls. Within this is an auxiliary piston driven off of the crankshaft, which automatically uncovers an air port at the bottom of its stroke. The air entering there passes through the auxiliary piston and on the up stroke is compressed and forced into the cylinder proper.

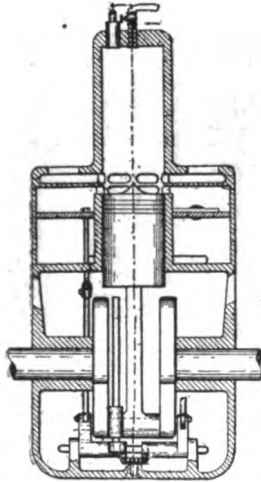

Bassett Two-Cycle Motor.

It is free to do this, as the main piston, at the bottom of its stroke, uncovers ports communicating with the concentric air chamber. Immediately above these, but separated from them and open to the atmosphere, are a series of exhaust ports. The engine is evidently intended to be run two-cycle with fuel injected at the proper point in the compression stroke so that the heat of compression will ignite the charge, as in the Diesel engine.

916,999. Air-Heater for Gasoline Engines.—Charles B. Chambers, Milo, Mo. Filed Jan. 25, 1908.

917,001. Wheel.—Carlton B. Chase, Worcester, N. Y. Filed March 19, 1908.

917,126. Carbureter.—Burt N. Pierce, Indianapolis, Ind. Filed Jan. 24, 1907.

This is an ingenious attempt to have the suction of the engine, which operates the air valve, control through this medium the inflow of gasoline as well. The end of the

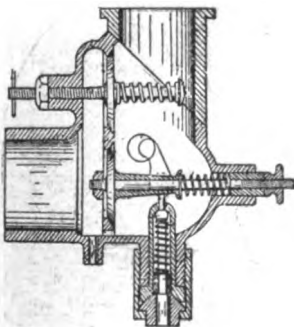

Pierce Floatless Carbureter.

air valve stem is made tapering and the increase in this taper operates to increase or decrease the flow past the needle valve. A plunger is spring held against this stem and its lower end is formed to a point and acts as the needle valve.

917,165. Rotary Explosive Engine.—Carlo Sella, Biella, Italy. Filed Oct. 12, 1906.

917,205. Power Transmission Device.—Edward P. Warner, Chicago, assignor to Warner Clutch Company, Chicago. Filed March 30, 1908.

917,220. Friction Device.—Lawrence Whitcomb, Brookline, Mass., assignor to National Brake & Clutch Company, Boston. Filed July 10, 1907.

917,232. Cooling System for Internal Combustion Engines.—C. C. Worthington, Dunnfield, N. J. Filed Sept. 10, 1904.

917,264. Carbureter.—F. W. De Tray, Aurora, Ill. Filed Dec. 30, 1907.

917,283. Internal Combustion Engine.—Warren H. Frost, Los Angeles, Cal. Filed July 22, 1907.

917,353. Automobile Support.—Alfred J. Parker, Newark, N. J. Filed Aug. 3, 1908.

917,415. Automobile Alarm.—Edwin Copleston, Brooklyn, N. Y. Filed March 28, 1908.

917,422. Motor Vehicle.—Carson Durkee, Vicksburg, Mich. Filed Jan. 9, 1907.

917,463. Transmission Gearing.—E. E. Larson, Thompson, Ia. Filed June 26, 1908.

917,465. Motor Vehicle.—John N. Leach, Melrose, Mass. Filed Nov. 25, 1907.

917,493. Tire.—H. E. Schindler, Sisseton, S. D. Filed July 6, 1907.

917,560. Dry Battery Cell.—Walter S. Doe, Jersey City, N. J. Filed May 11, 1908.

917,572. Starting Apparatus for Automobiles and the Like.—Samuel J. Evans, Roanoke, Va. Filed Aug. 8, 1907.

917,598. Emergency Brake.—Jacob Hauser, Scottsdale, Pa. Filed Oct. 10, 1908.

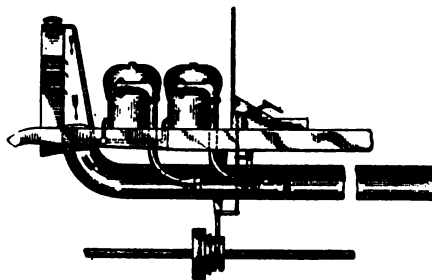

Worthington Cooling System.

917,612. Antiskidding Tire.—Eleazer Kempshall, London, Eng. Filed Apr. 20, 1908.

917,613. Non-skidding Tire.—Eleazer Kempshall, London, Eng. Filed April 20, 1908.

These are two American patents taken out by the English inventor whose product is already well known. The Kempshall tire as sold in this country is made with a series of deep depressions in the tread, these being circular with a slightly raised center. The tread portion of the tire is made extra heavy to allow of these depressions having quite a depth. The annular wall around the circular depressions forms a continuous surface at the edges of the tread portion. The circular holes constitute the non- or anti-skid part, the idea being that as the holes are pressed to the ground by the weight and speed of the car, the air is gradually squeezed out, forming a series of small vacuums. These do the work of resisting sideways motion.

917,722. Internal Combustion Engine.—James F. Duryea and William Remington, Springfield, Mass., assignors to Stevens-Duryea Company, Chicopee Falls, Mass. Filed Feb. 12, 1908.

This is apparently the first step toward a starting device, consisting as it does of a pressure reservoir connected to the cylinders so that they may be connected.

917,723. Tire for Vehicle Wheels.—Eleazer Kempshall, London, Eng., assignor to Kempshall Tire Company of Europe, Filed July 8, 1907.

917,734. Tire.—Eleazer Kempshall, London, Eng., assignor to Kempshall Tire Company of Europe. Filed July 25, 1907.

Issue of April 13, 1909.

917,764. Friction Clutch.—Harold Horsfall, Pittsburg, Pa. Filed June 5, 1908.

917,845. Spring Wheel.—J. J. Collins, Clemo, Pa. Filed Nov. 1, 1906.

917,883. Vehicle Wheel.—George W. Morris, Racine, Wis. Filed June 17, 1907.

917,926. Dust Pan or Shield for Automobiles.—Howard E. Coffin, Detroit, Mich. Filed July 18, 1907.

This is the underpan used on the Chalmers-Detroit cars and as the cut shows, is formed in a semi-circular shape with a lip at the top which hooks over the lower flange of the

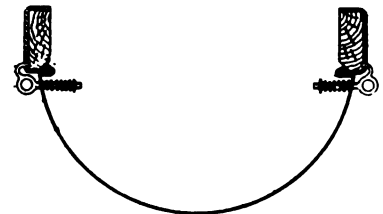

Coffin Form of Dust Pan.

main frame. It is held there by means of a clip which is fastened to the outside of the frame section. A spring on the inside of this holds the pan tightly against the frame, which spring may be compressed by the fingers and the pan freed for removal.

917,941. Valve Gear and Governing Mechanism for Explosion Engines.—Norman T. Harrington, Lansing, Mich. Filed Jan. 20, 1908.

918,122. Steering Device.—Charles E. Brooks, St. Louis, assignor to Roth Tool Company, St. Louis. Filed Oct. 5, 1908.

918,140. Gasoline Fire Engine.—William F. Gibbs, Philadelphia. Filed Feb. 5, 1908.

918,211. Internal Combustion Engine.—Charles W. Snyder, Hudson, N. Y. Filed April 20, 1907.

This is a two-cycle motor with crankcase compression, but the gas is led from there to the cylinder by means of a bypass in which is working a rotary valve. The latter is so

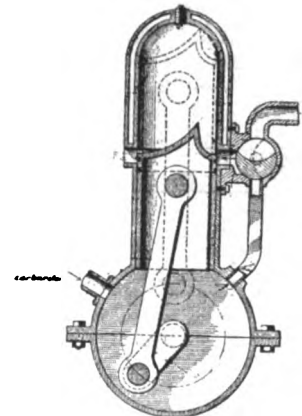

Snyder Rotary Valve Engine.

proportioned and driven from the crankshaft as to allow fresh air to be drawn into the cylinder on the end of the exhaust stroke and just before the inlet opens. This air helps to clean the exhaust gases out of the cylinder, insuring a full charge of pure gas.

918,429. Shock Absorbing Device.—Claude H. Foster, Cleveland, O. Filed Dec. 4, 1908.

Information for Auto Users

Herz Improved Timers.—Two new types of timers have been produced recently by Herz & Company, of New York, one being a wipe contact and the other having a roller-bearing contact. The feature of the former is in the contact itself, which has been radically changed so as to do away absolutely with any wear. The highest grade of Styrian tool steel, hardened sufficiently

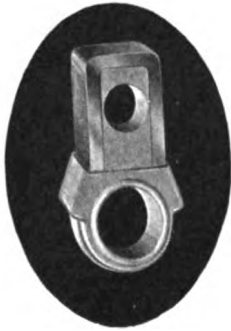

NEW HERZ CONTACT.

to cut glass, is used in the contacts in the rim, the surface of which is subject to wear. The tool steel rim is embedded with an alloy metal which is part of the terminal, and is absolutely rigid. This particular contact has been tested thoroughly, and for six weeks it was run day and night, without showing any perceptible wear. The body of the timer is of rubber, and the revolving center, with

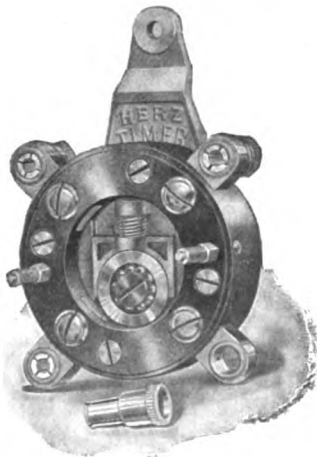

IMPROVED HERZ ROLLER TIMER.

its tool-steel plunger, runs on two sets of ball bearings.

In the roller-bearing timer, the roller is mounted in a square frame, a spring pushed parallelogram, and one of its several features is its compactness. The revolving section is supplied with two roller bearings, and indeed, the roller itself is an annular bearing which is held in a slide, set off the center. This slide is pressed forward by a spring, and though held rigid, will permit of ready self-adjustment. The contacts are made of hardened tool steel, set in vulcan fibre, and ground to caliber on a special

machine. The contacts are of the snap type. The workmanship on these specialties is of the same high grade as characterizes other Herz products.

A Novelty in Radial Bearings.—While ball bearings as a rule do not give as much trouble as many other parts of a car, when they do wear and get out of true they are a source of great trouble. It is asserted by many authorities that the fault of most bearings lies in the design and construction of the device used to separate the balls, and breakage or distortion of this part invariably puts the entire bearing out of commission. With a view of overcoming this sort of thing, the makers of the R. I. V. bearing, whose works are at Villar-Perosa, Italy, hit upon an invention of an anti-friction ring of babbitt metal, cast around the balls after they had been placed in proper position in the bearing. The properties of this metal as a "self-lubri-

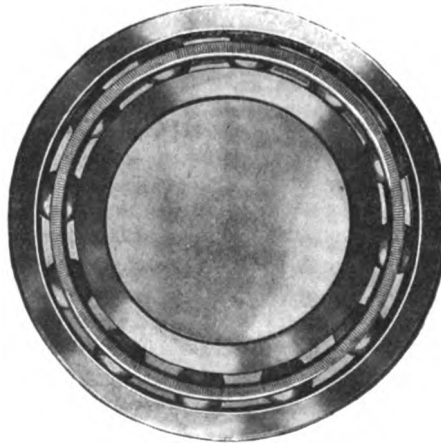

R. I. V. BALL BEARING.

cating" substance are well known, and by a special process the balls are loosened in this soft metal floating ring to such an extent that they revolve with perfect freedom, yet without the least noticeable play. It is through the fact that this ring is a floating arrangement, and is absolutely free from strain in any direction, and by its very nature frictionless, that it is claimed to be an indestructible device that never gets out of true, at least, up to 30,000 miles.

The balls are made of highest grade carbon crucible steel, perfectly hardened and finished with great accuracy, and the rings into which the balls fit are of the same quality of steel and accurately ground. Among the American manufacturers who have given the R. I. V. bearing an exhaustive tryout, and then placed an order for more, is the Packard Motor Car Company, of Detroit, Mich.

Stewart Multipolar Speedometer, Model 14.—This speedometer makes a special bid for public favor because of its extreme simplicity and costly construction. The mechanism, as shown by the illus-

tration, consists of but two moving parts, the rotor D and the disc H. The rotor, the actuating element, consists of a ring of non-ferrous material in which four permanent magnets are embedded. These magnets are accurately machined from imported Tungsten steel, made to special analysis—the costliest material obtainable for the purpose. The disc, the indicating means, is formed of an alloy

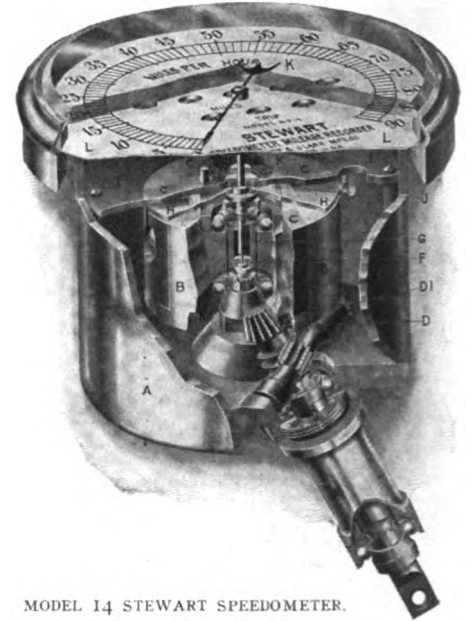

MODEL 14 STEWART SPEEDOMETER.

metal which is exceedingly light and has a low resistance. The rotor rides on hardened ball bearings, the disc on a diamond bearing. To the disc is attached a pointer which moves over an evenly graduated scale, very large in area. The standard or arm upon which Multipolar Model 14 is mounted with a clock is a distinct speedometer innovation, lifting the speedometer and clock away from the dash and making them both easily seen and read. The whole outfit is handsomely finished in brass and possesses unusual style and tone.

Walker's Tire Bands for Preventing Blow-outs.—A convenient form in which to have tire protectors is that of short individual covering strips that are independent of one another. This is the form in which the puncture and blow-out pre-



WALKER BLOW-OUT BAND.

venters made by the Walker Auto Tire Band Company, Indianapolis, come to the autoist. They may be had with or without metal tread mountings, the latter being mounted with 1-8 inch rivets swedged in tapering holes.

Vanguard Spark Plug.—What is claimed to be a spark plug that cannot be fouled or short-circuited by water, oil or carbon, has been patented by the Vanguard Manufacturing Company, of Joliet, Ill. It is shown in the accompanying illustration, and its makers call it "the plug of uninterrupted service." An extended demonstration of the plug to prove that it possessed the qualities claimed for it was made before crowds



VANGUARD SPARK PLUG.

of visiting dealers at the Chicago automobile show last January, and the good record which it made at that time is now having its effect in the large blocks of orders which are keeping its manufacturers busy. The Vanguard Company guarantees the plug not to quit sparking on account of any kind of fouling matter, and it is sold to dealers and individuals under this guarantee. It has terminal caps of a new and special design, adaptable for any old style or quick detachable terminals.

A Simple Shock Absorber.—One of the simplest devices of its character on the market at the present day is the Thomas shock absorber, manufactured by the Buffalo Specialty Company, Buffalo, N. Y. It consists of a combination of a double coiled spring and lever of peculiar construction, built of one piece of special steel and possessing great resiliency. The Thomas has no working

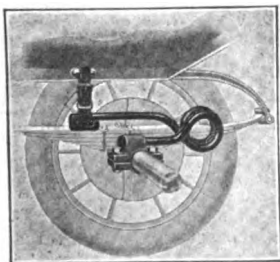

THOMAS SHOCK ABSORBER.

joints, frictions, pistons or plungers, and it is the claim of the makers that they eliminate the jolting and racking upthrow with absolute surety, and prevent the breakage of springs. The manufac-

turers are now making a special introductory offer embodying a free thirty-day trial, with return privileges if the user is not satisfied with the results.

Latest Thing in Tire Sleeves.—As a first aid to the injured tire the Wiles tire sleeve, a good illustration of which is shown herewith, appears to meet all requirements, for a quick and lasting repair. Although it is of comparatively recent invention, the manufacturers, the Diamond Rubber Company, of Akron, O., is pushed to the limit to satisfy the demands made upon this department of its business. It is claimed for the Wiles tire sleeve that it meets every requirement and has points of superiority in that it is quickly and easily applied, covers every portion of the tire exposed



WILES SLEEVE IN PLACE.

(fitting closely to the rim) and is equally as good for rim cut or blow-out as for tread puncture. It requires no lacing, cannot creep after it is applied, and the quality of rubber and sea island fabric used in its construction gives it the highest degree of wear resistance. A fabric blow-out patch is furnished with each sleeve, so that the same may be applied should the injury to the tire require it. E. H. Harris, of the Diamond Rubber Company, in speaking of the Wiles tire sleeve, says: "Every one who has seen or used it is astonished at its effectiveness and simplicity. More than one auto enthusiast has said to me: 'Why didn't I think of that myself?'"

B. & S. Steering Connections.—The Billings & Spencer improved steering connections consist of five pieces, separate views of each being shown in the illustration which accompanies. The parts consist of a ball-arm, attached to the steering post; two socket connections, with safety lugs for securely binding the adjusting plugs, and right- and left-hand steering arm connections. The two last-named pieces are of new design and are so made as to facilitate adjustment to various sizes of steering arms. Special oil cups are also added. Each connection is a drop forging, made with the customary care for which this house is noted, from the best steel obtainable for the purpose, properly machined and carefully assembled. They are marketed by the manufacturers, the Billings & Spencer Company, Hartford, Conn.

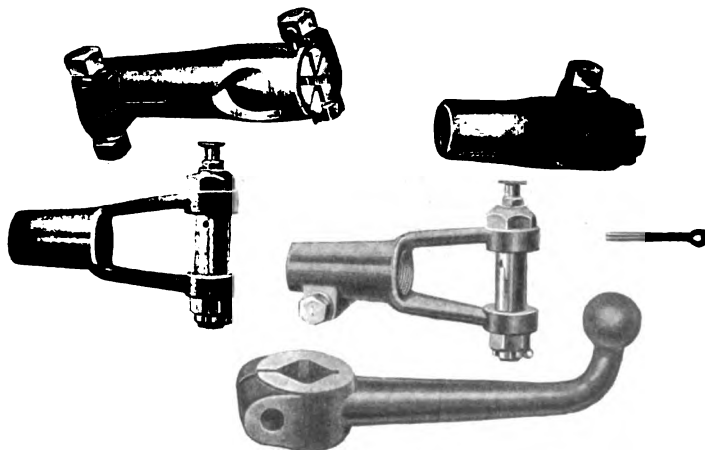

THE BILLINGS & SPENCER COMPANY'S IMPROVED STEERING CONNECTIONS.

Gobbo, God of Good Fortune.—A new idea in mascots, made in bronze and threaded at the bottom so as to fasten



GOBBO, MASCOT.

readily to radiator filling cap. Gobbo's rule of life is "Be cheerful and you will be rich in everything." These mascots are made by the S. M. Supplies Company, Boston.

How Flake Graphite Will Prevent Squeak in Springs.—To prevent springs from squeaking, flake graphite gives instant relief. The springs may be taken off or the leaves separated by jacking the body up so as to take the weight off the springs, then some graphite may be floated between the leaves with kerosene or oil. This will give lasting lubrication and at the same time will not catch dirt or dust as plain oil or grease will. In this connection if Dixon's Motor Graphite, manufactured by the Joseph Dixon Crucible Company, Jersey City, N. J., is used on the inside of tire shoes it will prevent the shoes from sticking and is better than talc or chalk. Rims may be also advantageously treated with flake graphite as a preservative of rust. The application of a thin coating of quick drying shellac varnish, to which some flake graphite has been added has been found to give good results, also if all threaded connections are made with graphite and oil, or, better yet, a specially prepared graphite joint compound, the joints may be taken apart at any time without trouble.

Save Your Radiator.—If you wish to preserve the water jackets of your engine or prolong the life of the radiator, an excellent preservative is that known as Nonkoroda. This is a compound which removes and prevents the formation of rust or scale, thus eliminating expensive repairs caused by leaky radiators. It is made by the Nonkoroda Company, New York City.

INDEX TO ADVERTISERS

Abendroth & Root Mfg. Co.	54	Dayton Rubber Mfg. Co.	52	Kokomo Electric Co.	102	Royal Equipment Co.	51-67
Acetylene Gas Illuminating Co.	51	De Luxe Motor Car Co.	52	Konigslow, Otto	53	Rushmore Dynamo Works.	74-75
Acme Motor Car Co.	52	Diamond Chain & Mfg. Co.	53	Lansing Wheelbarrow Co.	72	S. M. Supply Co.	66
Adams Co.	52	Diamond Rubber Co.	56	Larchmont Mfg. Co.	72	Salisbury Wheel & Mfg. Co.	51
AJax-Grieb Rubber Co.	108	Dietz Co., R. E.	112	Lavalette & Co.	91	Schrader's Sons, A.	51
American Ball Bearing Co.	83	Dixon Crucible Co., Joseph	58	Leather Tire Goods Co.	99	Schubert Bros. Gear Co.	65
American Carburetor & Imp. Co.	85	Dow Tire Co.	66	Lehman Mfg. Co., J. H.	51	Selden Motor Vehicle Co.	87
American Electric Fuse Co.	90	Driggs-Seabury Ordnance Corp.	53	Leland Co., W. H.	53	Shaler Co., C. A.	90
American Motor Car Co.	94	Duplex Co.	53	Levy Co., Manasseh	64	Sireno Co.	51
American Motor Car Sales Co.	97	Duplex Coll Co.	91	Lexington Motor Car Co.	85	Skinner & Skinner	88
American Motor Truck Co.	83	Echo Horn Co.	78	Life Publishing Co.	51	Smith Co., A. O.	88
Anderson Forge & Machine Co.	53	Eclipse Machine Co.	56	Lipman Mfg. Co.	54	Smith Mfg. Co., I. J.	83
Excelsior Supply Co.	58	Edmund & Jones Mfg. Co.	60	Lobe Pump & Machinery Co.	54	Spacke Machine Co., F. W.	53
Apple Electric Co.	56	Eldredge Electric Mfg. Co.	51	Locomobile Co. of America.	52	Spare Motor Wheel of America.	70
Ashton Valve Co.	51	Empire Automobile Tire Co.	80	Long Arm System Co.	72	Speare's Sons Co., Alden.	60
Asphalt Ready Roofing Co.	71	Enamelac Varnish Co.	48	Long Mfg. Co.	66	Speed Changing Pulley Co.	78
Atlas Motor Car Co.	cover	Everett-Metzger-Flanders Co.	85	Loring Appliance Co.	51	Speedwell Motor Car Co.	58
Atwater-Kent Mfg. Works.	105	Excelsior Supply Co.	58	Lucas & Co., John.	63	Spicer Universal Joint Mfg. Co.	53
Austin Automobile Co.	86	Excelsior Tire Co.	93	M. & E. Mfg. Co.	69	Spittdorf, C. F.	103
Autocar Co.	82	Firestone Tire & Rubber Co. cover		Masury & Son, John W.	86	Sprague Umbrella Co.	70
Autobug Co.	84	Flisk Rubber Co.	88	Matheson Automobile Co.	98	St. Louis Supplementary Spiral Spring Co.	84
Auto Car Mfg. Co.	95	Flentje, Ernst	67	Maxwell-Briscoe Motor Co.	76-77	Standard Co.	79
Auto Tire Security Co.	65	Fort Pitt Motor Car Co.	52	McCue Co.	52	Standard Connecting Rod Co.	56
Auto & Supply Mfg. Co.	51	Franklin Mfg. Co., H. H.	86	Metz, Chas. H.	87	Standard Roller Bearing Co.	66
Automobile Trade Directory.	49	Fried-Ostermann Co.	70	Meyers Auto Top Co.	55	Standard Sales Co.	51
Bailey & Co., C. J.	44	G. L. Economizer Co.	60	Michelin Tire Co.	52	Standard Welding Co.	81
Baldwin Chain & Mfg. Co.	58	Gaeth Automobile Co.	87	Miller, Chas. E.	89	Stanley & Patterson.	82
Barnrd-Johnson Auto Supply Co.	55	Gearless Motor Car Co.	52	Mitchell Motor Car Co.	86	Star Speedometer Co.	100
Bartholomew Co.	97	General Accumulator & Battery Co.	92	Model Automobile Co.	87	Stearns Co., F. B.	91
Beaver Mfg. Co.	67	Gilbert Mfg. Co.	62	Moline Automobile Co.	73	Stein Double Cushion Tire Co.	56
Bellfuss Motor Co.	85	Goodrich Co., B. F.	54	Moon Motor Car Co.	52	Stevens-Duryea Co.	96
Billings & Spencer Co.	48	Goodson Electric & Mfg. Co.	80	Mora Motor Car Co.	cover	Stewart & Clark Mfg. Co.	61
Bi-Cal-Kay Aux. Spring Co.	51	Goodyear Tire & Rubber Co.	85	Morgan & Wright.	84-102	Stromberg Motor Device Co. cover	
Bi-Motor Equipment Co.	48	Gramm-Logan Motor Car Co.	52	Morrison-Riker Mfg. Co.	70	Studebaker Automobile Co.	85
Black Mfg. Co.	92	Grand Rapids Spring Co.	54	Mosler & Co., A. R.	63	Swinhart Clincher Tire Co.	73
Blue Book	68-69	Gray & Davis.	cover	Moss Photo Engraving Co.	79	Syracuse Alum. & Bronze Co.	53
Bongartz Co.	55	Grossman Co., Emil.	72	Motor Car Equip. Co.	48-64	Syracuse Chemical Fire Extinguisher Co.	67
Borbein Auto Co.	54	Grout Automobile Co.	52	Mutz Clincher Tire & Rub. Co.	52	Thomas Motor Co., E. R.	85
Borne Scrymser Co.	98	Ham Mfg. Co., C. T.	55	Mutt Co., L. J.	55	Timken Roller Bearing Axle Co.	78
Bosch Magneto Co.	70	Hardy Co., R. E.	51	N. Y. Sporting Goods Co.	48	Tiresels Mfg. Co.	81
Boston Auto Gage Co.	51	Harris Oil Co.	89	National Brake & Clutch Co.	53	Tray Plate Battery Co.	78
Bowser & Co., S. F.	56	Hart-Kraft Motor Co.	57	National Motor Vehicle Co.	94	Trenton Rubber Mfg. Co.	54
Boyle & Co., John.	83	Hartford Suspension Co.	78	National Welding & Mfg. Co.	84	Trimont Mfg. Co.	81
Brennan Motor Co.	67	Havoline Oil Co.	106	New Departure Mfg. Co.	100	Troy Carriage Sunshade Co.	58
Bretz Co., J. S.	58	Haynes Automobile Co.	86	New York Gear Works.	55	Tucker, C. F.	51
Brown & Co., S. N.	55	Heinze Electric Co.	57	Nightingale Whistle Mfg. Co.	90	Tudor Mfg. Co.	71
Brownell Motor Co., F. A.	53	Hemmeter Spark Plug Co.	71	Norokoda Co.	60	U. S. Fastener Co.	81
Brush Runabout Co.	86	Hercules Electric Co.	80	Nordyke & Marmon Co.	52	Uncas Specialty Co.	62
Buckeye Jack Mfg. Co.	59	Herschell-Spillman Co.	53	Nuttall Co., R. D.	58	Underwood Typewriter Co.	79
Buckeye Mfg. Co.	87	Herz & Co.	48	Olds Motor Works.	52	Universal Tire Protector Co.	67
Buffalo Specialty Co.	56	Hess-Bright Co.	53	Omar Motor Co.	101	Vacuum Oil Co.	91
Buob & Scheu.	55	Hill Dryer Co.	53	Orange Machine & Mfg. Co.	66	Veeder Mfg. Co.	92
Burnett-Compound-Spring Co.	71	Hoffecker Co.	71	Owen & Co., R. M.	52	Vehicle Specialty Corporation.	57
Cadillac Motor Car Co.	52	Hoffman, Geo. W.	51	Packard Electric Co.	71	Velle Motor Vehicle Co.	95
Cameron Motor Co.	80	Holtzer-Cabot Electric Co.	73	Packard Motor Car Co.	111	Victor Clutch Compound Co.	53
Canton Drop Forging Co.	53	Hotel Gibson House.	84	Palmer & Singer Mfg. Co.	52	Victor Tire Traction Co.	72
Chadwick Engineering Works.	81	Hotel Lafayette.	91	Pantastote Co.	96	W. D. Spring Cushion Tire Co.	67
Chandlee & Chandlee.	57	Hotel Woodstock.	55	Parish & Bingham.	53	Walker Auto Tire Band Co.	70
Chicago Auto Top Co.	30	Howard Motor Works.	52	Parker, Stearns & Co.	54	Warner Instrument Co.	98
Cleanola Co.	57	Hoyt Electrical Ins. Works.	54	Peerless Specialty Co.	89	Watt-Detroit Carburetor Co.	71
Cleveland-Canton Spring Co.	53	Hydraulic Pressed Steel Co.	53	Perfection Spring Co.	54	Weed Chain Tire Grip.	72
Collins & Sons, G. A.	84	Indestructible Steel Wheel Co.	53	Petrel Motor Car Co.	83	Weston Elec. Instrument Co.	62
Columbia Lubricants Co.	54	Interstate Automobile Co.	87	Peugeot Freres.	53	Wheeler & Schebler.	104
Conn. Tel. & Elec. Co.	95	Jackson Automobile Co.	52	Pittsfield Spark Coll Co.	59	White Co.	cover
Conover, E. K.	87	Jacobson Machine Mfg. Co.	84	Prest-O-Lite Co.	107	Whitlock Coll Pipe Co.	81
Continental Caoutchouc Co.	52	Jeffery & Co., Thomas B.	109	Prosser & Sons, Thos.	81	Whitney Mfg. Co.	81
Continental Motor Mfg. Co.	62	Jewell Motor Car Co.	82	Puritan Gas Tank Co.	54	Widmer Machine Works, C. A.	70
Corbin Motor Vehicle Corp.	85	K. W. Ignition Co.	110	Quincy-Manchester-Sargent Co.	54	Willard Storage Battery Co.	78
Cornish Friedberg Motor Co.	52	K. & W. Mfg. Co.	70	Quride Co.	58	Willitt Engine & Carburetor Co.	90
Couch & Seeley Co.	67	Karl Co., Adolph.	51	Raimes & Co.	51	Winship, W. W.	80
Covert Motor Vehicle Co.	52	Kellom Co., Chas. F.	57	Rajah Auto Supply Co.	54	Winton Motor Carriage Co.	86
Cullman Wheel Co.	53	Keystone Lubricating Co.	69	Remy Electric Co.	51	Witherbee Igniter Co.	51
Cunningham, Sons & Co., Jas.	98	Kimball Tire Case Co.	99	Republic Rubber Co.	52	Wyman & Gordon Co.	48
Dayton Motor Car Co.	86	Kinsey Mfg. Co.	55	Reynolds, Harry H.	54	York Motor Car Co.	59
		Kissell Motor Car Co.	87	Robert Instrument Co.	51		
		Knox Auto Co.	101	Rome-Turney Radiator Co.	71		

BAILEY'S WON'T-SLIP TREAD TIRES

NON-SKID

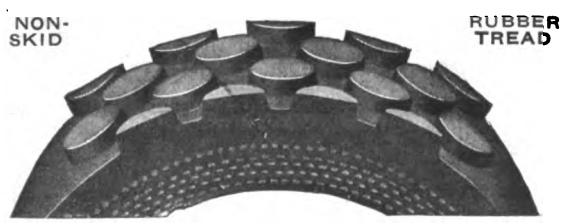

RUBBER TREAD

The rubber studs forming the BAILEY "WON'T-SLIP" TREAD TIRES to prevent skidding and give perfect traction were the correct principle to start with.

After being in general use for over eight years on Automobiles, Motor Cycles and Bicycles in the United States and Europe, the principle of the BAILEY TREAD has proved to be absolutely correct.

Twelve of the largest tire manufacturers in the world (nine in the United States and three in Europe) endorse this as licensees under the patents to make and sell the BAILEY TREAD.

The principle is so perfect that it is impossible to produce a substitute.

For sale by all dealers everywhere. Write us for Booklet.

C. J. BAILEY & CO., Patentees, 22 Boylston Street, BOSTON, MASS.

Licensed Manufacturers in the United States—The B. F. Goodrich Co., Akron, Ohio; The Diamond Rubber Co., Akron, Ohio; The Fisk Rubber Co., Chicago Falls, Mass.; Hartford Rubber Works Co., Hartford, Conn.; G. & J. Tire Co., Indianapolis, Ind.; Goodyear Tire & Rubber Co., Akron, Ohio; Morgan & Wright, Detroit, Mich.; Empire Automobile Tire Co., Trenton, N. J.; Consolidated Rubber Tire Co., New York City; The B. F. Goodrich Co.
Licensed Manufacturers in Europe—7 Snow Hill, London, E. C., Eng.; The North British Rubber Co., Edinburgh, Scotland; Hanover Rubber Co., Hanover, Germany

THE AUTOMOBILE

BIG TOWN
IS HAVING ITS
BIG CARNIVAL



*BENZ
Free-for-all-winner.*

“TO commemorate the eleventh anniversary of practical automobile construction in this country,” is the reason given by the New York Automobile Trade Association for its second carnival week in the “Big Town” of the country. The affair has assumed stupendous proportions, and unquestionably the attention of the general metropolitan public has been focused on the motor-driven vehicle and its present foundation of permanent stability. With a hill climb Monday wherein the cars easily surmounted the steep grade, record-breaking straightaway performances in Queensboro on Tuesday, and Wednesday devoted to visiting the bunting and flag-decorated stores of “Automobile Row,” the carnival is now in successful swing, with more spectacular events to come. To-day will include the transport of the military and a grand opera performance at the Majestic theatre, Friday will be punctuated with a one-gallon efficiency test, and Saturday is to have a big afternoon parade and a concluding

evening of jollification in the form of a smoker at the A. C. A.

There has been work in plenty in the preparation and conduct of the carnival, the executive and finance committee of which consists of these leading workers: Gen. John T. Cutting, chairman; Percy Owen, president New York Automobile Trade Association; Frank Eveland, C. R. Teaboldt, Col. K. C. Pardee, C. W. Wurster, C. P. Skinner, Alexander Howell, R. G. Howell, A. J. Inderrieden, and Walter R. Lee, secretary.

When one brings to mind the now historic “run,” promoted on Decoration Day, 1896, by John Brisbane Walker, in which two Duryea cars out of six contenders survived the trying journey of 26 miles from the City Hall to Irvington-on-the-Hudson and return, and compares it with the events of this week, he then comprehends the enormous strides accomplished in the making of the greatest industry of modern times. Then the automobile was more or less a subject of jest; now it is a pleasurable necessity.





At the Top of Fort George Hill the Scene Resembled an Outdoor Automobile Show.



National, Altken Driving, Fastest of the Six-Cylinders.

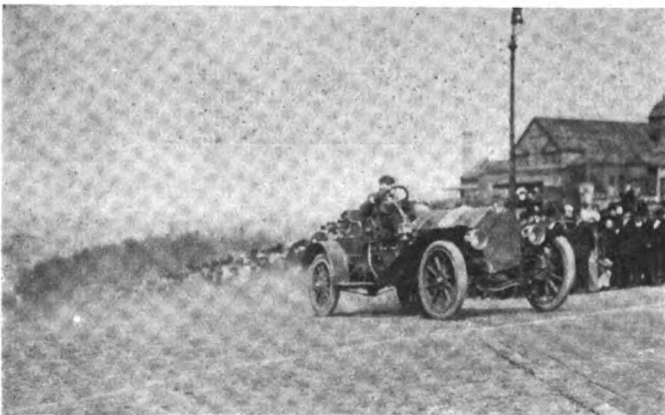

P. & S. Winner, with Lescaut at the Wheel.

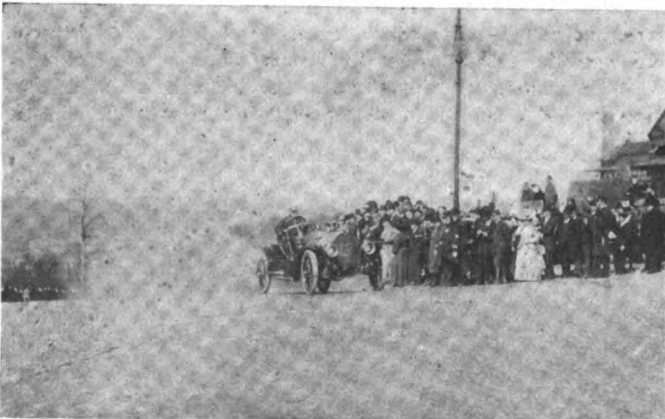

Chalmers-Detroit, Star Performer, Knipper Driving.

STOCK CARS REAL FEATURE OF CLIMB.

Though the unthinking public was naturally attracted and enthused by the record-breaking Benz in the contests up Fort George Hill, those given to deduction in affairs of this kind saw more practical performances in the regular stock car events. Out of the field of 41 there were less than a handful of special built racers, and the times made by the stock models were very fast indeed. The 120-horsepower Benz and David Bruce Brown, the combination so successful in Florida recently, flashed up the 11 per cent. grade in 28 4-5 seconds, 3 2-5 seconds better than the best in the 1908 climb and 1-5 better than the record of 1907.

As in previous Fort George climbs the 1,900-foot Belgian-blocked hill, start was standing, with a short dash across the street, through a narrow passage-way, not more than eight feet wide, and then the contestants would be on the hill proper, with a steady rise to the top. Thousands scattered along the walks or the steeper higher ground, some even being in the trees, while at the summit there was a large representation in cars. Perfect weather, a clear course with ample police protection, and good management combined to begin the first actual celebration of the week in ship-shape order. Starter Wagner sent the 41 contestants off in exactly an hour. All sizes of autos were on the list, from the little Maxwell Juniors of 10 horsepower to the big "sixes" of 90 and the bigger fours of 120.

Price classification was used in dividing the stock cars, the free-for-all, of course, being open to all sizes and styles of motive power. Gasoline had full sway towards making records, for this was the only type of car entered, with the exception of the two electrics. The interest for many of the spectators centered in the big fellows entered in the free-for-all and the larger class events, for it was in these that the fastest ascents were made.

The speed averaged from 30 to 45 miles per hour, from the less than half a minute time of the Benz, whose speed was exactly 45 miles per hour average and greater than that on the hill proper. to the six scores of over a minute. Brown in the German racer was followed in :31 1-5 by Webb in a Panhard of 120 horsepower which took part in the 1908 Grand Prix. These two big ones were of special character, and the figures of the stock National "Six," 33 3-5, only 2 seconds less than the Panhard, was a tribute to stock construction, inasmuch as it was the fastest time of the day made by a regular model.

The medium-priced cars of present popularity showed up in fine style, in numbers and in time, there being eight starters in the class between \$2,001 and \$3,000. A Chalmers-Detroit "Forty" led in :40 4-5, with Bourque in the Knox 2-5 of a second away, and the frequently-competing National third. Buick and Oakland divided the class between the \$1,301 and \$2,000 marks, Burman winning in :40 2-5. The two Oakland cars with their off-set crankshafts both made the entire run, after the start, upon high speed, Bauer and Dennison taking the climb excellently.

Mrs. Joan Newton Cuneo desired to try the hill in the Knox, but the officials declined to allow her, inasmuch as the event was held under an A. A. A. sanction, and the national body has de-

cided that only male drivers shall compete. Owing to the fact that Mrs. Cuneo's name was on the program for a special exhibition event many people expected to see her.

The officials of the day were as follows: Chairman, Col. K. C. Pardee; referee, Robert Lee Morrell; starter, Fred J. Wagner; judges, Alfred Reeves, S. A. Miles; technical committee, A. L. McMurtry, H. H. Law, A. H. Whiting; clerk of course, Alexander Howell; steward, J. E. Goewey; announcer, C. T. Earl. The summary follows:

GASOLINE CARS SELLING FOR \$850 OR LESS.

Car.	H.P.	Cyl.	Bore	Stroke	Gear	Driver.	Time.
Maxwell	10	2	4 in.	4 in.	4	Mannebach	:2:28
Maxwell	10	2	4	4	4	Ross	:2:32

GASOLINE CARS SELLING FOR \$851 TO AND INCLUDING \$1,300.

E-M-F	30	4	4	4	4 1-2	3	Taylor	:53 2-5
Bulck	18	4	3 3-4	3 3-4	4 1-2	3	Finch	:56 1-5
Bulck	18	4	3 3-4	3 3-4	3 1-2	3	Jones	:1:00 1-5
Mitchell	24	4	4	4	3 3-8	3	Delamater	:1:02 4-5
Overland	30	4	4	4	4 1-2	4	Baumhofer	:1:03 4-5
Maxwell	18	4	3 3-4	4	3 1-2	2	Dahl	:1:07 2-5

GASOLINE CARS FROM \$1,301 TO AND INCLUDING \$2,000.

Bulck	30	4	4 1-2	5	3 1-2	3	Burman	:40 2-5
Oakland	40	4	4 1-2	5	3 1-2	2	Bauer	:46 1-5
Oakland	40	4	4 1-2	5	4	1	Dennison	:46 3-5
Bulck	30	4	4 1-2	5	3 1-2	2	Warren	:52 1-5

GASOLINE CARS FROM \$2,001 TO AND INCLUDING \$3,000.

Chalmers-Detroit	40	4	5	4 3-4	3	3	Knipper	:40 4-5
Knox	38	4	4 7-8	4 3-4	3 1-2	2	Bourque	:41 1-5
National	35	4	4 3-4	4 3-4	2 7	2 7	Aitken	:42 3-5
Palmer & Singer	60	6	4 3-4	5 1-2	3	3	Palmer	:43
Moon	30	4	4 1-2	4 1-2	3	3	Davis	:45 4-5
Columbia	29	4	4 1-4	4 1-2	3 1-2	3	Coffey	:46 3-5
Palmer & Singer	60	6	4 3-4	5 1-2	3	3	Howard	:49 3-5
Pope-Hartford	30	4	4 7-8	5 1-4	3 1-2	2	Chandler	:56

GASOLINE CARS FROM \$3,001 TO AND INCLUDING \$4,000.

Palmer & Singer	60	6	4 7-8	5 1-2	3	3	Lescault	:41 2-5
National	35	4	4 3-4	4 3-4	2 7	2 7	Aitken	:42 1-5

FOUR-CYLINDER GASOLINE CARS SELLING FOR \$4,001 OR OVER.

Simplex	90	4	6 1	5 3-4	2	2	Robertson	:34 4-5
Stearns	30-60	4	5 3-8	5 7-8	4	4	Dolg	:37 4-5
Simplex	60	4	5 3-4	5 3-4	2	2	Broesel	:38 2-5
Stearns	30-60	4	5 3-8	5 7-8	3	3	Rutherford	:45 1-5
Stearns	30-60	4	5 3-8	5 7-8	3	3	Swan	:46 4-5

SIX-CYLINDER GASOLINE CARS FOR \$4,000 OR OVER.

National	60	6	5	5	1 37	1 37	Aitken	:34 2-5
Stearns	45-90	6	5 3-8	5 7-8	2 1-2	2 1-2	Burke	:40 1-5
Acme	50	6	5	5	2 1-2	2 1-2	Patschke	:42 2-5

FREE FOR ALL.

Benz	120	4	6 1	8	1 3	1 3	Brown	:28 4-5
Panhard	120	4	6 1	7 1-2	2	2	Webb	:31 3-5
National	60	6	5	5	1 37	1 37	Aitken	:33 3-5
Knox	48	4	5 1-2	5 1-2	3	3	Dennison	:33 4-5
Stearns	45-90	6	5 3-8	5 7-8	2 1-2	2 1-2	Burke	:36 3-5
Columbia	29	4	4 1-4	4 1-2	3	3	Coffey	:37
Royal Tourist	48	4	5 1-2	6	3	3	Jardine	:42 1-5
Stearns	30-60	4	5 3-8	5 7-8	4	4	Fickling	:44 3-5
Renault	60	4	6	6	2	2	Basle	:45 1-5
Babcock	3				9 3-4	9 3-4	Peck	:54 4-5

ELECTRIC CARS.

Babcock	3				9 3-4	9 3-4	Wagner	:1:24 4-5
---------	---	--	--	--	-------	-------	--------	-----------

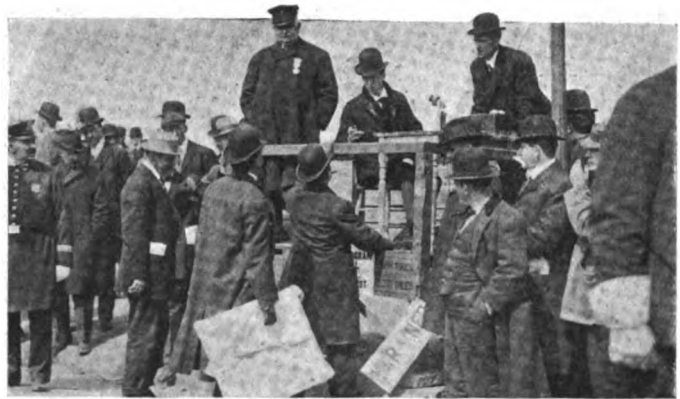

Colonel K. C. Pardee, the Hill Climb Chairman.



Maxwell, Which Took the Pony Honors.

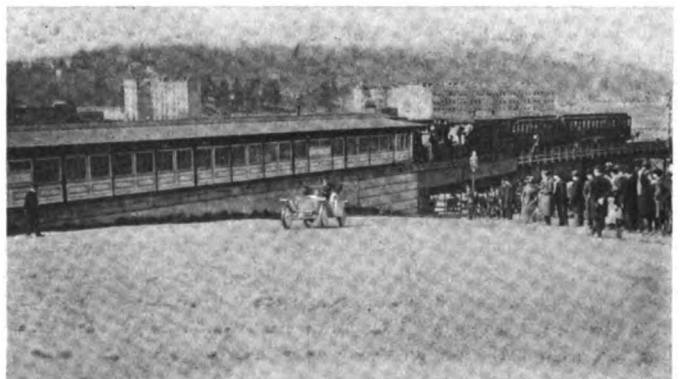

Babcock Electric, Which Traveled Under the Minute.



George Robertson, Vanderbilt Cup Winner, Winner of the Four-Cylinder Over \$4,000 Class, with 90-Horsepower Simplex.

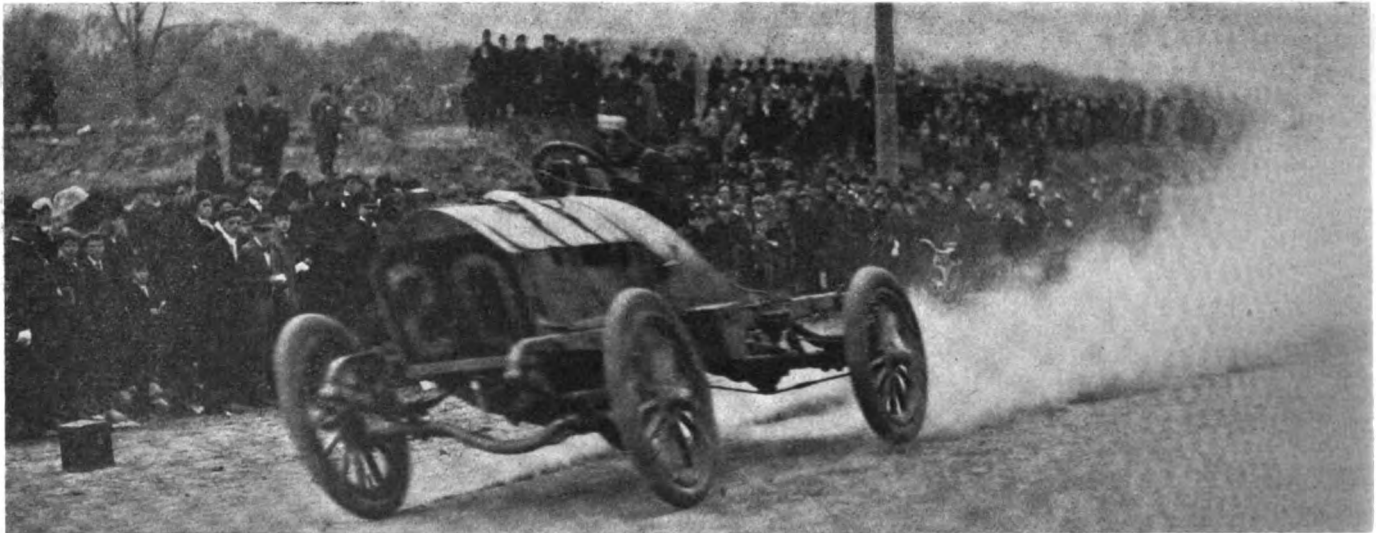

Knox, Driven by Bourque, Which Captured One Event and Tied First Place in Another.

GREAT SPEED IN JAMAICA STRAIGHTAWAYS.

Rough and dusty was the course on Hillside avenue, Jamaica, Long Island, Tuesday, when the entire attention of the "Big Town's" automobilists was moved across the East river and into Queens borough. One and two mile distances had been laid out, electric timing arrangements made, and some 10,000 people gathered along the route to see an afternoon of real sport. Again David Bruce Brown made the feature runs of the day, with the big Benz, its time of 35 3-5 seconds, a rate of 101.69 miles per hour, lowered the world's record for the distance over a road. It was apparent to the spectators that the speed of the great machine was enormous, as it came down the stretch with a thick cloud of dust rolling back from it. The crowd was not highly disappointed when on its first trip on the longer course the timers were not as quick as the car, and no time was caught, necessitating another run. The second trial was probably equally as fast as the first, the time being 1:16 2-5, a rate of 94.24 miles per hour, for the two miles, 2 4-5 seconds better than the score of the Hotchkiss last year. Likewise, Brown's record of 35 2-5 broke that of last season for the mile by 3 1-5 seconds.

But fast as was the German, there were other cars blowing chips from the block of "Old Father Time" during the day, and some of them were real stock cars, with full equipment and only in a few cases stripped. The Knox team made a splendid showing, Dennison in the 48-horsepower car covering the mile in

:41 3-5 in the last event of the day, run as dusk started in, at a rate of 86.53 miles per hour; and in the one-mile free-for-all his time was nearly as good, :42 2-5, a rate of 84.9 m.p.h.

The National "Six" took next honors among the stock cars, Merz taking it over the short distance in 44 seconds, an 81.8 miles an hour rate. George Robertson was at the wheel of the big Panhard, inasmuch as his Simplex had been ruled out as not being a stock car, and with the big French car he took second place in both free-for-alls.

It was a peculiar incident, and one which shows the evenness with which the modern stock car develops its power, that the classes were all won by the same cars in the two sets of events.

There were no untoward incidents or approaches to accidents, except in the one mile free-for-all, when Coffey, driving the light Columbia, swung too sharply in rounding the slight curve into the homestretch and appeared to run off the road into the grass. He straightened out, however, and his time was not materially affected, being 54 4-5 seconds. The roughness of the course caused a great deal of bouncing and the few larger holes sent the cars up into the air somewhat. The only event scheduled which was not run was that of running as slow as possible on high speed. It was decided that this would take too long, inasmuch as the Oakland, driven by Dennison, had averaged two miles an hour for the distance in the morning, taking about 30 minutes to go one mile. There were only two entries.

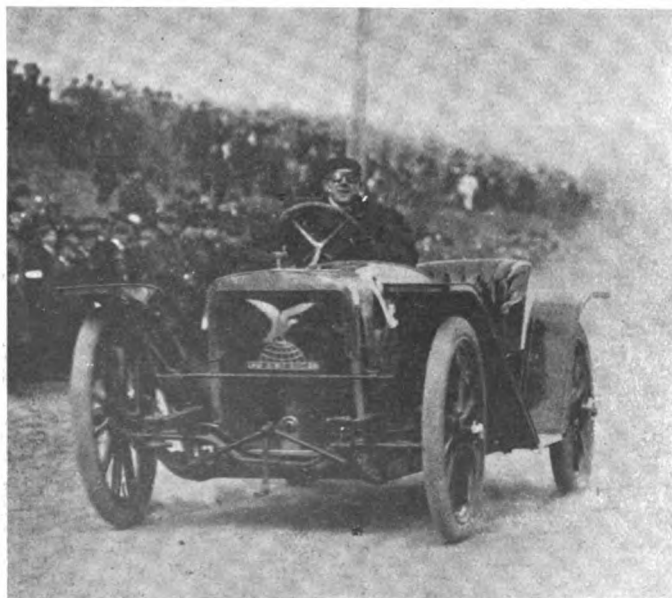

American, Driven by Redatar, Was a Fast Performer.

ONE MILE FREE-FOR-ALL.

Pos.	Car.	H.P.	Cyl.	Bore.	Stroke.	Driver.	Time.
1.	Benz	120	4	6.1	8	Brown	:35 2-5
2.	Panhard	120	4	6.1	7 1-2	Robertson	:39
3.	Knox	48	4	5 1-2	5 1-2	Dennison	:42 2-5
4.	National	60	6	5	5	Merz	:44
5.	Renault	60	4	6	6	Basle	:47 1-5
6.	S. P. O.	18	4	3.34	4.33	Adams	:49 4-5
7.	Columbia	29	4	4	4 1-4	Coffey	:54 4-5
8.	Lozier	50	4	5 1-2	5 1-2	Cobe	:55 1-5
9.	Knox	38	4	4	4 7-8	Bourque	:56
10.	Babcock	3				Peck	No time

TWO MILES FREE-FOR-ALL.

1.	Benz	120	4	6.1	8	Brown	1:16 2-5
2.	Panhard	120	4	6.1	7 1-2	Robertson	1:24 4-5
3.	Knox	48	4	5 1-2	5 1-2	Dennison	1:32
4.	Knox	38	4	4 7-8	4 3-4	Bourque	1:35 1-5
5.	National	60	6	5	5	Merz	1:35 2-5
6.	Renault	60	4	6	6	Basle	1:40
7.	Columbia	29	4	4	4 1-4	Coffey	1:45 4-5
8.	Babcock	3				Peck	2:47

ONE MILE—SIX-CYLINDER GASOLINE CARS, OVER \$4,000.

1.	National	60	6	5	5	Merz	:48 3-5
2.	Stearns	45-90	6	5 3-8	5 7-8	Burke	:58 1-5

TWO MILES—SIX-CYLINDER GASOLINE CARS, OVER \$4,000.

1.	National	60	6	5	5	Merz	1:42
2.	Stearns	45-90	6	5 3-8	5 7-8	Burke	1:57 1-5

ONE MILE—FOUR-CYLINDER GASOLINE CARS, OVER \$4,000.

1.	Stearns	30-60	4	5 3-8	5 7-8	Rutherford	:53 1-5
2.	Stearns	30-60	4	5 3-8	5 7-8	Allen	:55 4-5

TWO MILES—FOUR-CYLINDER GASOLINE CARS, OVER \$4,000.

1.	Stearns	30-60	4	5 3-8	5 7-8	Rutherford	1:51 3-5
2.	Stearns	30-60	4	5 3-8	5 7-8	Allen	1:56 1-5
3.	Stearns	30-60	4	5 3-8	5 7-8	Swan	1:58 2-5

ONE MILE—GASOLINE CARS, FROM \$3,001 TO AND INCLUDING \$4,000.

Pos.	Car.	H.P.	Cyl.	Bore.	Stroke.	Driver.	Time.
1.	American	50-60	4	5 3-8	5 1-2	Redstar	1:00
2.	Haynes	50	4	4 1-4	5	Shuttleworth	1:03 1-5

TWO MILES—GASOLINE CARS, FROM \$3,001 TO AND INCLUDING \$4,000.

1.	American	50-60	4	5 3-8	5 1-2	Redstar	2:00 1-5
2.	Haynes	50	4	4 1-4	5	Shuttleworth	2:13 2-5

ONE MILE—STOCK CHASSIS, CARS OVER \$3,000.

1.	Knox	48	4	5 1-2	5 1-2	Dennison	:41 3-5
2.	Blanchi	70	4	5.9	6.68	Hutt	:49 4-6

TWO MILES—STOCK CHASSIS, CARS OVER \$3,000.

1.	Knox	48	4	5 1-2	5 1-2	Dennison	1:34 2-5
2.	Lozier	50	4			Cobe	1:49 4-5
3.	Blanchi	70	4	5.9	6.68	Hutt	1:50

ONE MILE—GASOLINE CARS, FROM \$2,001 TO AND INCLUDING \$3,000.

1.	Knox	38	4	4	4 7-8	Bourque	:56 2-5
2.	Chalmers-Det.	40	4	4	5	Knipper	:56 2-5
3.	P. & S.	60	6	4 3-4	5 1-2	Palmer	:56 4-5
4.	P. & S.	60	6	4 3-4	5 1-2	Wallace	:57 4-5
5.	P. & S.	60	6	4 3-4	5 1-2	Howard	1:01 4-5
6.	Columbia	29	4	4	4 1-4	Coffey	1:03 3-5
7.	National	35	4	4 3-4	4 3-4	Altken	1:06 4-5
8.	Pope-Hartford	40	4	4 7-8	5 1-4	Hines	1:18 1-5

TWO MILES—GASOLINE CARS, FROM \$2,001 TO AND INCLUDING \$3,000.

1.	Knox	38	4	4 7-8	4 3-4	Bourque	1:56
2.	P. & S.	60	6	4 3-4	5 1-2	Palmer	1:56 4-5
2.	Chalmers-Det.	40	4	5	4 3-4	Knipper	1:58 1-5
4.	P. & S.	60	6	4 3-4	5 1-2	Wallace	2:00
5.	National	35	4	4 3-4	4 3-4	Altken	2:02 4-5
6.	Columbia	29	4	4 1-4	4 1-2	Coffey	2:02
7.	Pope-Hartford	40	4	4 7-8	5 1-4	Hines	2:16 1-5
8.	P. & S.	60	6	4 3-4	5 1-2	Howard	2:20 4-5
9.	Pope-Hartford	40	4	4 7-8	5 1-4	Chandler	2:25 1-5

ONE MILE—GASOLINE CARS, FROM \$1,251 TO AND INCLUDING \$2,000.

1.	Buick	30	4	4	4 1-2	Burman	:55
2.	Buick	30	4	4	4 1-2	Warren	1:03 2-5
3.	Cadillac	30	4	4	4 1-2	Le Duc	1:09 4-5

TWO MILES—GASOLINE CARS, FROM \$1,251 TO AND INCLUDING \$2,000.

1.	Buick	30	4	4 1-2	5	Burman	1:52
2.	Buick	30	4	4 1-2	5	Warren	2:13 2-5
3.	Cadillac	30	4	4	4 1-2	Le Duc	2:28

ONE MILE—GASOLINE CARS SELLING UNDER \$1,250.

1.	E-M-F	30	4	4	4	Stark	1:09 4-5
2.	Buick	18	4	3 3-4	3 3-4	Jones	1:10 2-5

TWO MILES—GASOLINE CARS SELLING UNDER \$1,250.

1.	E-M-F	30	4	4	4 1-2	Stark	2:22 2-5
2.	Buick	18	4	3 3-4	3 3-4	Jones	2:26 1-5
3.	Buick	18	4	3 3-4	3 3-4	Finch	2:28 4-5
4.	Maxwell	18	4	3 3-4	4	Sickinger	2:51 1-5

WEDNESDAY SOUVENIR DAY—A DINNER-DANCE.

Wednesday's part in the festivities was that of "Souvenir Day," when the dealers in the local trade were given a particular chance to be hosts. "Automobile Row" fairly hummed, and some very pretty and valuable souvenirs were given to recognized customers and friends. A dinner-dance was held in the evening at the Hotel Marseille, 103d street and Broadway, dinner starting at 8:30 with the dance beginning at 11 o'clock.

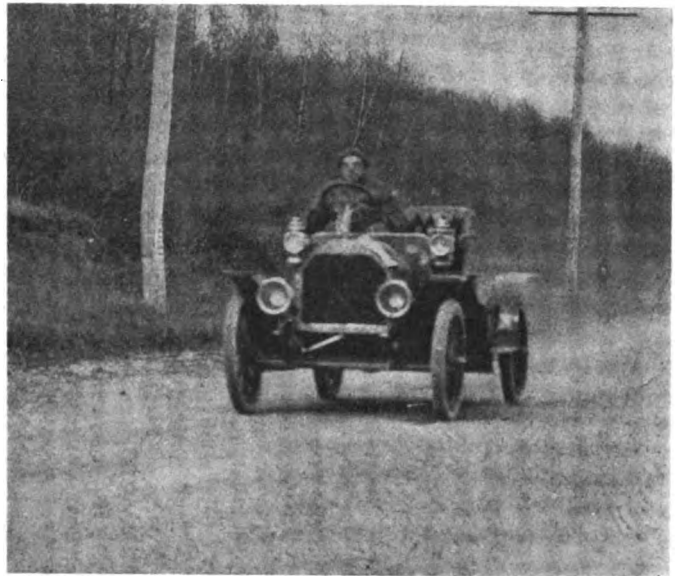

Stark in E-M-F, Winner of Two Small Car Classes.

THURSDAY, FRIDAY AND SATURDAY.

A military demonstration, including transporting of the Ninth Regiment to Larchmont and a sham battle, is going on this afternoon. About 150 cars were marshaled this morning and taken to the Armory, where the troops were in readiness with full equipment. They were taken to the Heathcote Arms, on the Boston Post road for the active work on that part.

The Imperial Grand Opera Company this evening at the Majestic Theater will have a special performance as a part of the celebration, with "King Guy" and "Queen Annette" attending.

The one-gallon efficiency contest will be held to-morrow (Friday) and should be most interesting. Each car will be given a single gallon of gasoline and sent away on a route not to be announced until the start. The cars will be classed according to price and a basis for accurate comparison will be secured in multiplying the weight (including the passengers) by the distance covered. There will be an observer on each contesting car, and in his charge will be a two-gallon can of gasoline with which to make the return trip. Thos. J. Fay, ex-president of the Society of Automobile Engineers, will act in the capacity of chief inspector of the cars. A. C. Bergman, a member of the society, will assist Mr. Fay.

From the spirited voting for the king and queen of the carnival, interest has been aroused in the pageant which will pass through the upper part of the city on Saturday, starting from Broadway and Eighty-fourth street. Saturday evening the A. C. A. will give a smoker to the Trade Association.

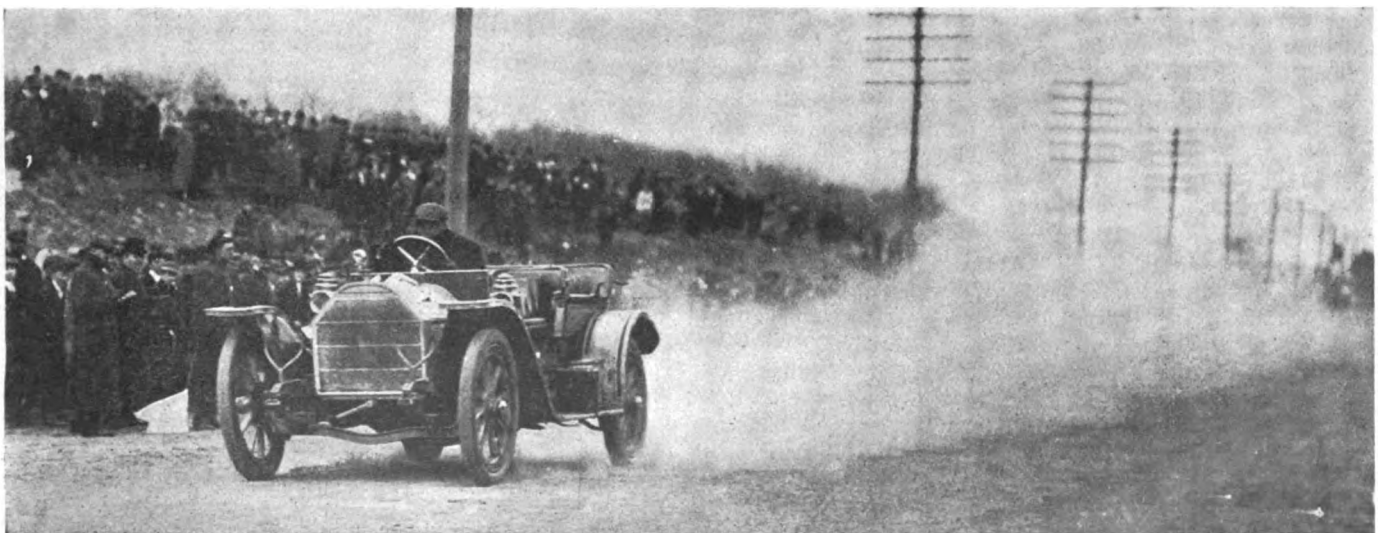

Stearns "White Lines," Driven by Private Owners, Were Out in Force in Their Classes.



PHILADELPHIA, April 26.—The second annual roadability run of the Quaker City Motor Club last Saturday afternoon, to Atlantic City, demonstrated that it is quite possible to pull off a real automobile contest without the aid of the professional element and at the same time inject sufficient of the spirit of rivalry to keep the competitors on the *qui vive*—and incidentally refrain from fracturing the speed laws. Sixty-nine cars started from the Hotel Walton, J. C. Bartlett's Woods electric coupé taking the word at 1 o'clock sharp, the others following at one minute intervals. The route, via Egg Harbor and May's Landing, was 68.2 miles long, and the official secret time, set by Mayor Reyburn, of this city, was 3 hours 46 minutes 30 seconds.

George Proud's Rambler, driven by Ira Brown, was declared the winner of the "grand" prize, coming under the wire just 22 seconds before the official limit expired. The "place" prize went to "Dick" Sellers, who drove his Pennsylvania over the course within 1 minute 43 seconds of the mark set by the Mayor. E. C. Benson captured the "show" trophy with his Apperson, handing in his card but 2 minutes 17 seconds shy of the mark.

A unique feature of the contest was that every contestant participated in the winnings, even the last to finish coming in for something. Secretary Harbach evolved the scheme, and it worked out beautifully. Those cars which finished fourth to thirteenth, inclusive, captured series A prizes; from fourteenth to twenty-fifth, series B trophies; from twenty-sixth to fortieth, series C emblems; from forty-first to sixtieth, series D prizes, and from sixty-first on, series E awards. The farther away the car finished from the official figures the smaller the value of the prize. It was a decidedly novel scheme and made a marked hit.

The Mayor distributed the prizes on Saturday evening on Young's New Million-Dollar Pier, whither the cars were taken after the run and put on exhibition. The impromptu automobile show attracted thousands of the elect who flock to the City-by-the-Sea at this season of the year.

The performance of the day par excellence was that of the brace of Woods electric coupés, driven respectively by J. C. Bartlett and George Daley. Despite a 35-minute holdup at Hammonton to enter security for having scared a horse into smashing its rig, the former brought his car to the finish in 4:35:40 on one charge of "juice"—and with about 15 miles left in his batteries. Daley did the same trick in 5 hours 12 minutes. This double performance of the Woodses is said to be the first on record in a regularly sanctioned contest in which cars of all powers had entered. Mrs. Leslie Carter, the well known actress, had her yellow Thomas Flyer in the run, and the rig, with

its uniformed crew and two pretty theatrical-looking ladies in the tonneau, made a hit. Countess Von Holstein's Oldsmobile was also a contestant. The following summary shows the order of finish, drivers and the time variation from the official figures:

Place.	Car.	Driver.	Penalties. h. m. s.
1	Rambler	Ira Brown	0:00:22
2	Pennsylvania	Richard Sellers	0:01:43
3	Apperson	E. C. Benson	0:02:17
4	Elmore	F. Hardart, Jr.	0:02:30
5	Elmore	R. E. Ross	0:02:35
6	Stoddard-Dayton	H. L. Walker	0:02:35
7	Maxwell	W. C. Longstreth	0:02:40
8	Oldsmobile	E. K. Schultz	0:03:00
9	Stoddard-Dayton	Caryl Roberts	0:03:43
10	Cadillac	F. L. Paxton	0:04:06
11	Mitchell	Jno. F. Dilworth	0:04:17
12	Apperson Jack Rabbit	Charles J. Swain	0:04:30
13	Oldsmobile	C. Edgar Shreve	0:05:23
14	Peerless	P. B. Huyette	0:05:30
15	Packard	H. M. Lyman	0:05:40
16	Oldsmobile	Wm. T. Taylor	0:05:45
17	Autocar Wagon	J. Bryan	0:05:55
18	Apperson	Dr. J. F. Sinclair	0:06:15
19	De Dettlich	F. K. Stehle	0:07:35
20	Packard	H. Van Fossen	0:08:13
21	Studebaker	Frank Yerber	0:08:45
22	Apperson	A. M. Benson	0:08:55
23	Elmore "44"	George R. Harvey	0:09:07
24	Franklin	J. Chubbuck	0:09:45
25	American	W. Blind	0:09:49
26	Apperson	Mr. Foss	0:10:07
27	Rochet-Schneider	Mr. Isenberg	0:12:25
28	Midland	George F. Parker	0:13:25
29	Dragon	H. D. Jacobs	0:14:15
30	Winton Six	J. L. Brock	0:15:19
31	Stearns	G. Hilton Gantert	0:15:27
32	Stearns	F. C. Dunlap	0:15:35
33	White Steamer	Evans Church	0:17:10
34	Pope-Hartford	J. R. Maynes	0:17:44
35	Packard	A. A. Kent	0:17:45
36	Oldsmobile	L. D. Berger	0:18:12
37	Locomobile	R. S. McCracken	0:18:22
38	White Steamer	Stuart Leister	0:19:23
39	Autocar Taxicab	J. Morris	0:20:10
40	Winton Six	A. E. Maltby	0:20:15
41	Chalmers-Detroit	H. O. Brown	0:21:00
42	Franklin	W. B. Danehower	0:21:20
43	Packard	Thomas Wilkinson	0:21:30
44	Locomobile	F. L. Shields	0:23:25
45	White Steamer	A. T. James	0:23:25
46	Packard	Joe Vernier	0:24:20
47	French Berlet	W. T. Richardson, Jr.	0:24:30
48	Pope-Hartford	F. B. Shepard	0:24:45
49	American Traveler	Mr. Vogel	0:24:53
50	Peerless	J. Louchheim	0:25:45
51	Oldsmobile	J. Doe	0:26:50
52	Mitchell	F. J. Sweet	0:27:45
53	Thomas Flyer	D. A. O'Hara	0:28:55
54	Peerless	Dr. I. M. Koch	0:30:30
55	Oldsmobile	A. F. Rusk	0:32:19
56	Oldsmobile	E. Westcott	0:46:35
57	Stoddard-Dayton	W. W. Randall	0:47:44
58	Peerless	L. S. Amonson	0:48:00
59	Bulck	F. K. Worley	0:48:45
60	Woods Electric	J. C. Bartlett	0:49:10
61	Thomas Flyer	J. H. Lallou	0:51:15
62	Bulck	Mr. Tygert	0:56:12
63	Stearns	H. A. McNichol	1:18:05
64	Woods Electric	G. W. Daley	1:26:30

How Old Lookout Was Climbed

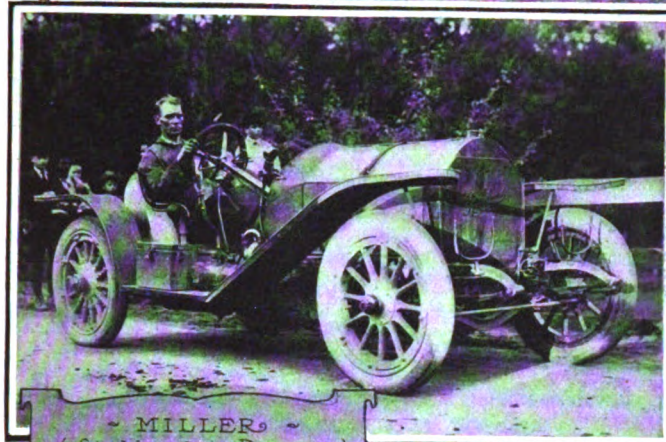

~ MILLER ~
(Stoddard - Dayton)
Winner Stock Free-for-All



STRANG and CHEVROLET
(Buick)
Fastest Performers.

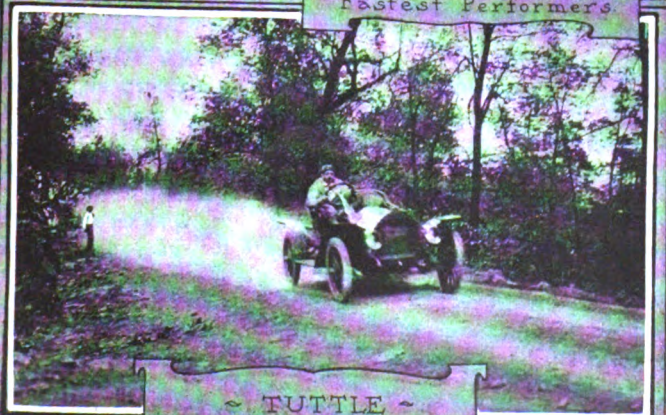

~ TUTTLE ~
(Stoddard - Dayton)

CHATTANOOGA, TENN., April 22.—Old Lookout Mountain, famous from Civil War days and known to the entire world, was conquered to-day by the men who drive automobiles and motorcycles. Yes, and more than conquered, for the cars ascended to the top of the mountain at a speed of from fifty to sixty miles per hour, rounding sixty-five turns throughout, and with grades that at times ran 30 per cent.

Fifty thousand people watched the climbing, watched for death round the "Flatiron," at the "Letter S," the "Double Letter S," the "W" turn, the "Serpentine" and the "Bridge of Fear." Some one made the trip earlier and named the points, and some one did the work well, for the names hardly convey the full meaning. The course is tortuous, the course is hard, the grades are steep, the road is none too wide at present, and none too safe.

Lookout came as a surprise to a lot of people who wanted to enter. Many came first, tried the course and backed out. Others came, saw and conquered in the end. Croakers said that deaths would result from the ordeal, but none occurred, and, therefore, the shouting of those who had the nerve to tackle the event and who won out.

To climb Lookout the start is made on the level at a point where the Southern Railroad is just constructing a road to go right through the mountain itself. The proposed bridge provides abutments that are excellent for sight-seeing. The road starts right up and goes past some splendid residences that are located at the foot. The grade is exacting and takes the wind from a few cars. Then come a lot of turns, serpentine in their way, and, suddenly, after passing along a bluff with Chattanooga in the distance, the car is driven to about as pretty a letter "S" as may be found. Many of the bluffs have been cut away to widen the road. One turn succeeds another, and each has new fears. No stretch is long and every turn has its problems. Suddenly the finish comes, also on a turn, and then the driver gives thanks that he has reached his destination; while the passenger: well, he just gets right down on his knees and talks of fate.

It all looked dangerous and had every one of the fifty thousand spectators who traveled up the hill to watch the cars go up taken a similar course of instruction, as did the writer as a passenger with Strang, the real drive would have aroused their interest to a greater extent. As it was these thousands picnicked along the course and waited patiently for each competitor to go by. The results had to be learned from the daily papers of the following morning. None on the hill learned the real time and each driver was cheered in turn, including the motorcycle men, who did the jumping-jack act as they drove their machines up the grades and over the rough going at from forty to fifty miles per hour, and at times faster.

Bert Miller and Harry Tuttle, with Stoddard-Dayton cars, were active competitors of the Buick, Locomobile and other entrants throughout the contest. Miller won out in the free-for-all stock car contest, and lost another event in all probability

for the reason that the timing tape was struck so hard when he made a flying start that it failed to record. This timing arrangement was a novelty. A white tape was stretched across the road about three feet from the ground. The cars struck the tape and released a gong which rang and was heard through the telephone at the top of the hill.

When Miller made his start in the seventh event he simply flew, and it was claimed made faster time to the bridge, about three miles up, than did any one else. From the start this bridge could be seen, and watching for the cars at this and other points as they could be seen in their ascent caused added interest at the start. Miller, after having started, could not be stopped, and so completed his daredevil effort without being timed. He demanded another trial and it was not given. His time for the eighth event, the stock car free-for-all, was doubled; in other words, being allowed for the seventh event. It brought him victory for that event, but in the free-for-all Strang and the Buick won out in 6:39 4-5.

Chevrolet negotiated the hill in 6:30 2-5 for the 4.9 miles, and this time was made at dusk. The honors for the fastest speed went to the daring French-American driver, whose daring was never to be questioned as he hurled himself at the turns, one after the other, in the fast gathering dusk, fairly pushing the returning populace off the course. The drive of the Frenchman was noteworthy, and drew admiration on all sides, especially as he had been up against the hardest sort of luck. Twice he had accidents, once a broken wheel, and another time a blowout.

The accident to Louis Doerhoeffer in his Locomobile proved a wonderful escape, as he shot into the ditch in making the "Hair-pin" and he and his mechanic were thrown out in front of the large crowd. The car was uninjured.

Strang won three of the events. Daring always, he came to look at Lookout Mountain, and after several trips said that he would make the journey so often that every step would be familiar. He did so, and his nerve was good, although to the stranger "within the ranks" his daring seemed insane. No hard luck attended him throughout the races, although he gave "fate" every opportunity.

It is now the intention of the Lookout Mountain Automobile Club to apply for a national sanction and put on a great contest

for next October, when the road will have been greatly widened, the rough spots taken out and danger spots protected. To every intent and purpose Chattanooga will aim to put forth the best hill climbing proposition in the country. Nor is it the intention of Chattanooga to do things half way. This was indicated at this meet, when the State soldiery was secured to guard the course. The soldiers used red flags for danger and white flags to announce the coming of the cars.

In Chattanooga the banks and business houses closed and it was made a local holiday. One of the local residents said that not one in four people kept away from the hill, and this is seemingly a fair statement. Nor did the people tire of the long waits for the cars, these waits being unavoidable owing to the inadequate timing arrangements.

The rain which came Thursday night, and proved a deluge, prevented any thought of the two days of track contests, and these were postponed until next week. It is improbable that many of the drivers will return, as the teams are scheduled elsewhere. The summary of the climb is herewith given:

FREE FOR ALL STOCK CARS.

1. Stoddard-Dayton	Miller	6:58	3-5
2. Buick	Strang	7:15	3-5
3. Thomas	Duffy	7:20	1-5
4. Locomobile	Doerhoeffer	Failed to finish.	

STOCK CARS LISTING AT \$3,000 AND UNDER.

1. Buick	Strang	6:39	4-5
----------	--------	------	-----

STOCK CARS LISTING AT \$2,000 AND UNDER.

1. Buick	Strang	6:48	
2. Stoddard-Dayton	Tuttle	7:49	4-5
3. Chalmers-Detroit	James	10:42	2-5

STOCK CARS LISTING AT \$1,000 AND UNDER.

1. Buick	Dewitt	6:57	3-5
2. Buick	Kenyon	11:04	4-5

FREE FOR ALL CARS.

1. Buick	Strang	6:39	4-5
2. Stoddard-Dayton	Miller	6:58	3-5

SPECIAL TRIAL AGAINST BEST TIME.

1. Buick	Chevrolet	6:30	2-5
----------	-----------	------	-----

MOTORCYCLES, 30 1-2 INCHES AND UNDER.

1. Indian	Stubbs	6:54	1-5
2. R. S.	Moss	9:10	

MOTORCYCLES, 61 CUBIC INCHES AND UNDER.

1. Indian	Stubbs	6:50	2-5
2. Curtiss	Green	7:25	

700-MILE RUN OF HARRISBURG CLUB COMES NEXT

HARRISBURG, PA., April 26.—With arrangements en route completed, and the last detail attended to here, the final week before the start of the 700-mile run of the Motor Club of Harrisburg finds the club members and the officials in readiness for one of the most important events to be held in the East this year. Next Monday morning the contestants will leave the capital of the Keystone State for the national capital, crossing spurs of the mountains, through historic country, and over various conditions of Pennsylvania and Maryland roads. For four days next week they will be moving over the country under strict rules, and with experienced management, so that a remarkable endurance run is confidently expected.

Authorities all along the route have become interested in the affair, starting right here with the donation of the principal trophy by Governor Stuart, and by his starting the first car on its journey. The town and city authorities and automobile clubs along the way have been planning an enthusiastic reception, some of the places having dispensed with speed laws for the day, in case the tourists wish to show them how fast they can travel, and constables and police have been instructed to keep the streets clear. Maryland has even waived the privilege of license fees, and a government official will check the cars as they arrive in Washington. The second day the cars will return to this city via Baltimore; the third they will go up-State to Wilkes-Barre, via Sunbury and Williamsport; and the fourth they will return

via Stroudsburg, Delaware Water Gap, Easton and Reading. In addition to the Governor's trophy, there are two others of value in the respective classes, one given by the Board of Trade, and the other by the *Patriot*.

The entries have been arriving in good numbers, and it is probable that there will be 25 or 30 starters, among whom are a number who have taken part in important national events. Walter C. White will make his first appearance in competition since his accident at Cincinnati; Tom W. Berger will have a six-cylinder Oldsmobile with 42-inch wheels; C. S. Carris will be at the wheel of a Franklin; Robert Morton with a Pullman delegation; and a number of private owners are also taking part. The complete entry list has not as yet been announced. The rules provide intermediate checking stations, with a definite time schedule, observers to be carried on all cars, and penalties for adjustments, repairs and replacements. All working parts, such as bonnets, battery boxes, coils, etc., will be sealed, and technically examined at the conclusion of the run.

The officials include such experienced men as R. H. Johnston, of New York, who is the referee; J. C. Kerrison, of Boston, as starter; David Beecroft, of Chicago, as chairman of the technical committee, and J. Clyde Myton, of Harrisburg. The immediate arrangements have been in charge of W. R. Douglass, the club secretary. Dr. J. R. Overpeck is the official pilot, and he will see that the confetti is scattered each day.

Automobile Gasoline and Other Available Fuel

By Thos. J. Fay

art III

BESIDES the volatility of automobile gasoline the viscosity, and some of the other properties of the fuel will be worthy of discussion. Considering that the relation of air to gasoline in the mixture should be held at a constant ratio, if the best mixture is to be realized, it follows that the viscosity of the fuel should be a constant if the orifice through which the gasoline flows is some one fixed size, which viscosity can only be so if the temperature is held at a constant level, and if the fuel is fixed, as to its composition and in gas form.

The viscosity of gasoline increases as the specific gravity advances, so that trouble of this nature will augment as the fuel becomes inferior in character, assuming that poor fuel is represented by the heavy fractions of the distilling process. Taking "octane" as a standard to go by for the time being, the density of which is 0.707 specific gravity and the effect of viscosity will be about as follows:

TEMPERATURE IN DEGREES CENTIGRADE.					
10	15	20	25	30	35
Relative Viscosity Considering Temperature Only.					
Unity	1.073	1.145	1.212	1.270	1.225

An inspection of the above relations will at once disclose the reason why gasoline will be deficient in a carburetor of the nozzle type, when the temperature is low, if the adjustment is made for the right fuel relation when the temperature is high. For anything like good results, it is necessary to adjust the nozzle at a fixed (middle of the range) temperature, and the same should be a good average of the prevailing range of temperatures. In the Winter time, when the temperature is low, the nozzle should be with a larger hole (orifice) than will be required in the Summer time when the prevailing temperature is higher. At all events there is no one size nozzle that can be regarded as right for all degrees of temperature, and this is one of the every day troubles that autoists have to cope with, many of whom do not well understand why their motor will run to their entire satisfaction a part of the day, and not run well some other part of the same day.

In the carburetors using a needle-valve in the nozzle, an attempt is made to get away from this very trouble, but it rarely happens that the needle-valve as usually made is so designed that it will allow of the fine adjustment which is an absolute necessity, assuming that the remedy lies in a means for altering the flow of gasoline, from time to time, as the state of the weather would

seem to require. It is even a question, that has never been adequately discussed, as to whether the needle-valve in the nozzle is really of any practical value. If it (as a device) is likely to add more trouble than it will cure, it is not a good contrivance to use. In some cases the needle-valve gives a great amount of trouble, and while it is possibly true that the difficulty might be done away with, the fact remains that it is not, and in practice, to deal with the existing conditions is a necessity.

Preheating Is One Way Out of the Trouble.—Heating the air as it leads to the carburetor is of advantage in certain ways, since it enables the gasoline, in globule form, to reduce to vapor, in the manifold to some extent, at any rate, rather than to have the globules enter the cylinders, there to form coke, and to be vaporized under conditions that can not be regarded as the most efficient. This heated air, however, will not compensate for changes in viscosity of the liquid, as it is sucked through the nozzle. The only way that the ills of viscosity can be eliminated is to heat the liquid gasoline, in the bowl of the carburetor to some fixed temperature, as is done in some cases, by water-jacketing the carburetor and allowing hot water, from the water jacket of the motor cylinders, to circulate through the same, which water should be at a constant temperature.

There is one trouble about this, but it is the lesser of the evils, since, while the water will be a little hotter than is necessary for the purpose, even so, it is possible to so contrive that the surface available will be within striking

distance of the requirements. It is not desired that the gasoline shall be heated in excess of certain needs; indeed, it is something of a disadvantage to utilize more heat than the actual demand. On the other hand, it takes quite a little heat to boil gasoline, and the right place to apply the heat is to the liquid, rather than to the mixture, after it leaves the bowl of the carburetor. True, in the case involving the use of the gas tank, in which the gasoline is reduced to vapor before it is allowed to enter the manifold at all, these vaporizing troubles are handled in the right way, in that the heat (taken from the exhaust products of combustion) is applied to the liquid gasoline in a manner sufficiently direct to serve the purpose. In this case the air drawn in is heated by contact with the surfaces of the heater, and the rich mixture should be quite free from liquid fuel. In actual practice this method shows enough economy to indicate that the reasoning is good, and that heat should be applied to the liquid; moreover, the idea is in accord with the dictates of logic.

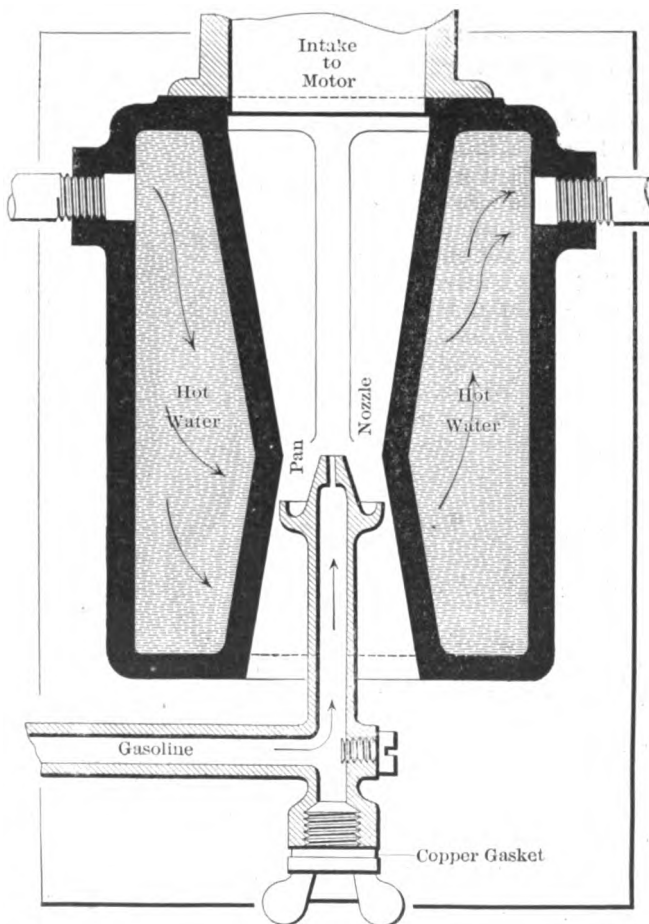

Fig. 8.—Water-jacketing the depression chamber heats the mixture instead of the liquid gasoline.

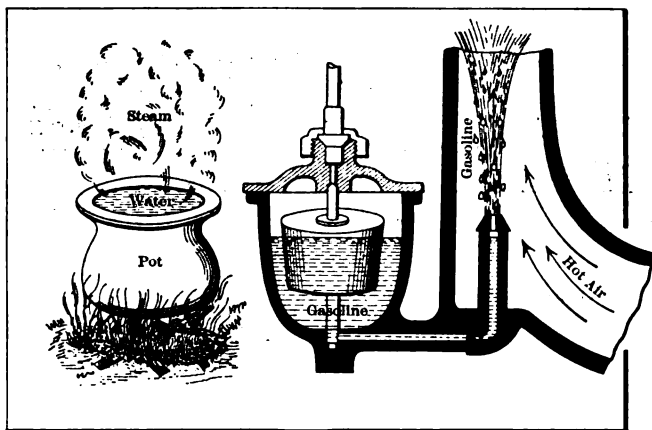

Fig. 7.—When water is boiled, a fire is built under the pot; this is the right way to boil gasoline.

The specific heat of air is taken at the low value, for the purpose of putting the error on the safe side, if one there happens to be. There is some question as to the air being at a constant volume in this service.

SPECIFIC HEAT OF GASES AND VAPORS AT A CONSTANT PRESSURE.

Substances.	Specific Heat for Equal Volumes.	Equal Weights.
Steam	0.2989	0.4805
Oxygen	0.2405	0.2171
Nitrogen	0.2368	0.2438
Hydrogen	0.2359	3.4080
Carbon dioxide.....	0.2935	0.1952
Carbon monoxide.....	0.2870	0.2450
Air	0.1689	0.2375

SPECIFIC HEAT OF LIQUIDS AT TEMPERATURE OF MAXIMUM DENSITY.

Substances.	Specific Heat.
Water	1.00
Gasoline	0.50

NOTE.—The specific heat of gasoline depends upon its composition, specific weight, etc. The figure given is an approximation.

If the latent heat of evaporation of gasoline is taken to be 210.1 B.T.U., which figure will change, as the density of the fuel changes, it will be rendered apparent that a vast amount of vapor will have to be handled, per heat unit absorbed. If a gallon of gasoline weighs say, 5.9 pounds, and if it is assumed that a car will travel 11.8 miles per gallon, at a mile per minute, the gasoline consumption will be one-half pound per minute. This is rather a high rate of consumption of fuel, but there are cars that even exceed this, so that it is not a stretch of the imagination to use it as an illustration. On this basis, 105 B. T. U. of heat will have to be transferred to the liquid gasoline in order to evaporate it, during each minute of time. If water is used, and if the heat transfer absorbs from the water the requisite number of heat units, with a drop in temperature of the water of 20 degrees Fahrenheit, the amount of water required for the purpose will be:

$$w = \frac{105}{20} = 5.25 \text{ pounds (approximately) per minute.}$$

The reverse of this lies in the following:

$$\text{B.T.U.} = w \times t = 5.25 \times 20 = 105$$

when,

w = quantity of water in pounds,

t = change in temperature of the water in degrees Fahrenheit,

B.T.U. = thermal value in British thermal units.

If the specific heat of air is taken to be 0.1689, which is the right value for a constant volume (at a constant pressure the specific heat of air is 0.2375) the weight of air required to do the work that can be done by 5.25 pounds of water, will be:

$$a = \frac{5.25}{0.1689} = 31 \text{ pounds of air per minute.}$$

This is on a basis of 20 degrees Fahrenheit change in temperature, as was considered in the case involving water. The weight of a cubic foot of dry air at 72 degrees Fahrenheit is 0.0747 pounds, and if this weight is taken for a basis, the following will hold:

$$c = \frac{31}{0.0747} = 415 \text{ cubic feet of air per minute.}$$

If a motor with six cylinders is considered, and if the bore and stroke are taken at 4½ inches, respectively, the cubical displacement will be 248 cubic feet per minute per 1,000 suction strokes, so that there is not enough air for the purpose, considering all the air that can be used in the cylinder in view of displacement, and, unfortunately, all the air will not brush against the walls. Indeed, but a small part of it will be available to absorb heat from the walls, particularly in view of the presence of an auxiliary air valve, which allows the major portion of the air to by-pass the depression chamber in the average carbureter. In any case, the air is not enabled to heat the gasoline excepting as it leaves the nozzle, and the time allowed is far too short to assure results.

As for the cars in which no means are provided for heating the gasoline, it is highly improbable that very much of the same is vaporized before it enters the cylinders. They properly represent the school of design, in which it is claimed that it is a matter of no moment as to how the gasoline is vaporized, and that the results are good enough when the fuel is vaporized in the cylinders instead of outside.

For the cars using hot air it will be proper to remember that, the increase in temperature assumed, i.e., 20 degrees Fahrenheit, is a fairly low value, and some of the trouble would be eliminated were the air to heat up more. On the other hand, there is small chance of all the air reaching a higher temperature, in actual practice, with the heating equipment used, and the glaring

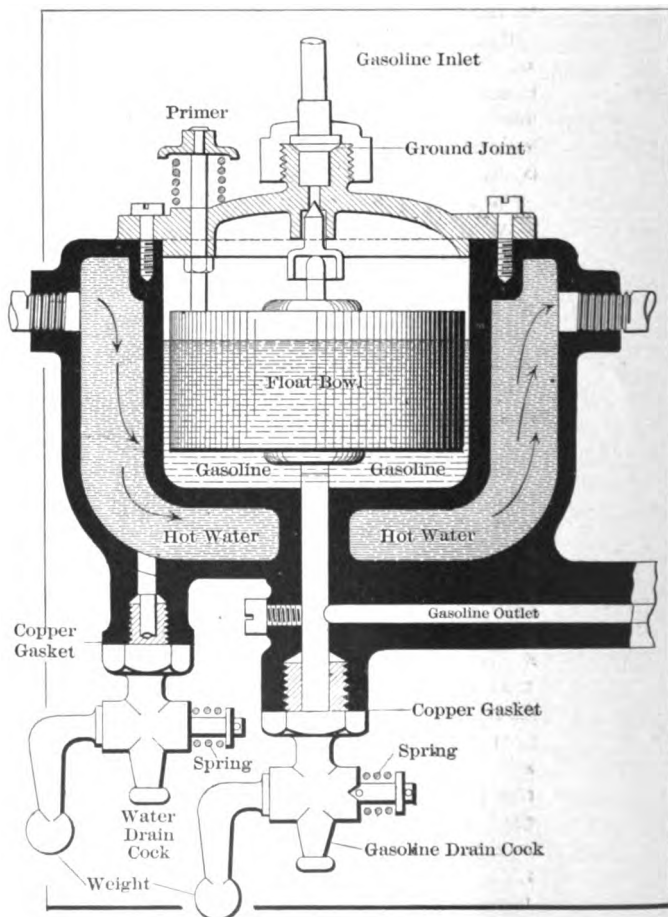

Fig. 9.—To heat the liquid, a water-jacket is placed around the float-bowl, in the manner as shown.

fact is rendered apparent, viz., the liquid gasoline is not reduced to vapor, excepting for a part, by the heated air, as it passes through the depression chamber, by the nozzle, en route to the cylinders.

The illustration is not sufficiently refined to take into account some variables as (a) the effect of diminishing the pressure, below the atmospheric, in order to induce the air into the cylinders, and to suck the gasoline out of the nozzle of the carbureter, (b) the presence of gasoline in the mixture, which must displace air. But these are all matters of small moment since they merely augment the trouble by a small percentage in that the amount of air will be less than the piston displacement represents.

The real story lies in the inability of the air to furnish an adequate amount of heat to completely vaporize the gasoline, and as a result, the gasoline must enter the cylinders, in liquid form, before it is vaporized, and since the cylinder temperature is at the "coking" point, some of the gasoline must form coke, which is a great disadvantage in practical work.

The real source of trouble then, is not the cylinder lubricating oil, but in gasoline instead, due to the very fact that the means of "boiling" the gasoline, to make vapor, does not afford enough heat to do the work outside of the cylinders, and as the temperature inside the cylinders is that which will deposit carbon out of the liquid gasoline, theory and practice are in full accord, excepting that the practical result is not wanted.

In Boiling Water Put the Fire Under the Pot.—To make steam it is necessary to boil water, and it would be regarded as a strange performance were anyone to apply the heat to the steam instead of to the water. Vapor of gasoline is no more nor less than the product of boiling gasoline, and the best way to produce the vapor is to boil the liquid, just as is done with water. Fig. 7 shows the way in which steam is made, in which a fire is built under the pot. The rest of the process is too well understood to require further discussion. A second figure in the same illustration also shows how gasoline is handled in automobiles, and it looks a little strange to apply the heat to the "spray" as it spouts out of the nozzle, in contrast with the pot of water along side of it, unless it is conceded that the old-fashioned way of boiling liquids is wrong.

Practical Devices Used in Heating Fuel.—If heat is applied to the mixture only, rather than to the liquid, Fig. 8 shows the manner in which the water jacket is contrived, in which the water is entered at one (convenient) point on the diameter, near the top of the casting, and in view of ribs that are made to serve as baffle plates, in the manner as shown by dotted lines, the water is forced down, and around, to the water outlet on the diametrically opposite side of the casting. The amount of heat that will be taken up by the gas will be limited, for the reasons as given, amongst which, as stated, the specific heat of the gas is a rather low value, and too, the surface available is restricted. True, the low specific heat of the gas is assurance that it will heat up readily, without absorbing much heat from the water in the jacket. On the other hand, the heat requirement is a definite quantity, and unless this full amount is taken up by the gas, the same will be with entrained liquid, which is not wanted, especially as carbon is likely to form in the cylinders if the liquid is not completely vaporized before it enters the combustion chamber of the cylinders, in the motor.

Water-Jacket Should Be Around the Float Bowl.—In case it is desired to take advantage of the benefits to be derived from heating the liquid gasoline, rather than the gas mixture, it is then that the plan as depicted in Fig. 9 will be the preferable one, and as shown, the water jacket is around the float-bowl, into which the gasoline enters on its way from the fuel tank to the motor. As will be observed, the water enters at the top, and if a system of baffle plates are provided, as they should be, the water will flow down, thence up, and out on the opposite side of the bowl. In view of the increased ability of the liquid gasoline to absorb heat, and in further view of the slow rate at which the gasoline flows out of the bowl, which is a condition that does not exist in the case of the vapor, the requisite amount of heat is assured,

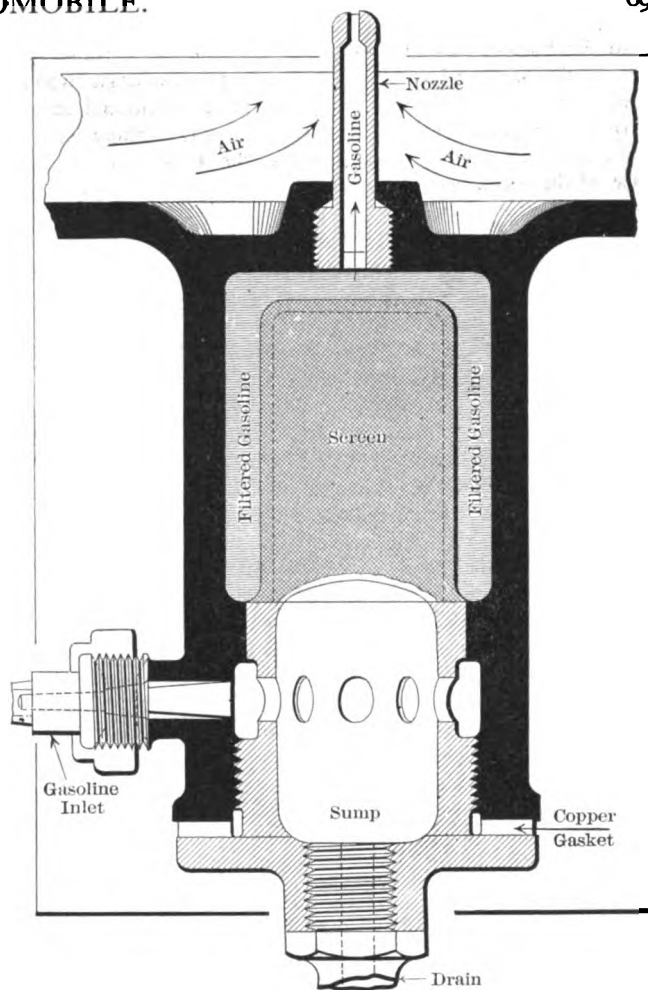

Fig. 10.—Illustrating a strainer to be placed between the float-bowl and the gasoline nozzle, in the depression chamber.

even if the difference in temperature between the water and the gasoline is not so very great. In general, the difference in temperature should be about 150 degrees Fahrenheit, and this is quite enough for the purpose, with, perhaps, a good margin.

The construction shown is more by way of a diagram, in so far as the bowl is concerned, and the float is of the direct acting genera, which is not the only kind used in practice. As will be observed, however, the needle is separate, and it is therefore self adjusting, so that if the float gets out of alignment, it will not of necessity cause the needle-valve to leak. Leaky valves cause much trouble in practice, due to the use of inferior material in some cases, and to the form of construction, in which the system gets out of alignment, or sticks. For the needle, it is believed that German silver is the best, although it is difficult to procure, which is the main reason why soft brass rod-stock is more often than not used for the purpose.

The float should be of "spun" copper, rather than of cork, and if cork is used it is a moral certainty that it will lose its buoyancy before very long, in actual service. If the float is of copper, it can be adjusted to the conditions, without resorting to the use of means for changing the adjustment at will, and in this practice there is nothing to shift, so that, once the adjustment is right, it will stay so. It is not uncommon, in connection with carburetors, to observe that the cocks are of the sort usually found on gas fixtures and on other work in which the ills of vibrations are not figured upon. For carburetors it is scarcely to be expected that the ordinary form of cock will do the work without giving a certain amount of trouble, and the form of cocks shown are certainly better, in that they are provided with a spring-locking device, so contrived that the cock can not jar loose. The lock consists of a pin in the stem of the valve which engages a nick in the housing. When the valve is turned the spring compresses enough to allow the pin to slide out of the

notch in the housing without any trouble at all. The crank on the stem is also weighted, and the weight hangs downwards when the cock is in the closed position. This is an additional safeguard that is of good value, and the cost is really nothing extra. If all cocks are so devised, it is then that the autoist can see, at a glance, if the cocks are opened or closed, and in the dark, it is only necessary to feel the position of the crank on the cock, to be able to tell if it is opened or closed.

In the future, it is a moral certainty that the fuel question will become sufficiently acute to require that every known means will be provided, in order that the gasoline may be quite completely vaporized, and with this contingency in mind, it may be that the question of the water-jacket is one to be discussed on a basis of jacketing not only the float-bowl, but the depression-chamber as well. There can be no possible objection to the extension of the jacket to include the depression-chamber, especially if, in the course of events, fuel becomes less volatile than it is at the present time, although it is a sad condition to contemplate. Should it be desirable to jacket around the mixture, as well as around the gasoline in liquid form, it will be the right plan to take advantage of the methods shown in both Figs. 8 and 9, combining them for the purpose.

A Strainer Should Be in the Gasoline System.—Considering the diameter of the nozzle orifice, even in the cases involving the use of very large motors, it is easy to understand how a little slime, or hard paraffine, will serve as the nucleus for further accumulations of such matter as will be found in gasoline, and Fig. 10 shows a strainer such as should find lodgment in the system, between the float-bowl and the nozzle. As will be observed, this device, as shown, requires the liquid to enter to the

inside of the strainer, the object being to assure that the accumulations will be withdrawn, with the strainer, when the same is removed for the purpose of cleaning. It will also be observed that there is plenty of room in the well for the strainer, and a good space is allowed between it and the walls of the housing. In some of the earlier types, it was the custom to afford but little room between the walls and the surface of the strainer, with the result that jelly formed readily, and when the strainer was removed for the purpose of cleaning the jelly failed to come out, but after being loosened up it would float up to the nozzle and cause stoppage of the fuel at frequent intervals until it became an argument in favor of a design such as would not allow the jelly to collect on the inner wall of the well.

Why Hot Air Will Not Best Serve the Ends.—It is really necessary to heat the liquid gasoline, just as it is proper to heat water to cause it to boil. It would seem to be just as good practice to try to heat steam to make the water from which it is made, boil, as it is to heat mixture in the intake of the motor, in order to cause the liquid gasoline to boil off as it oozes out of the nozzle. Hot air, drawn in through the primary air-take, while it does afford a measure of benefit, is representative of a most indirect way of doing that which can be done directly. True, there are ingenious devices in vogue, by means of which the heat is applied with good effect, particularly when the gasoline is of a desirable quality. The time is fast approaching, however, when even a fine display of ingenuity will fail, in a measure, at any rate, to deliver enough heat to the fuel, by any indirect process, and it is believed that the water-jacket method will find many converts.

(To be continued.)

NOVEL AND PRACTICAL SYSTEM OF CAR RENTING

THE majority of garages rent an automobile by the day rate or hour rate alone, the usual charges for the day being from \$25 to \$35 for a five to seven-passenger car, whether the customer uses the car a full day or not. The length of the day varies also, some garages reckoning eight hours to the day, while others reckon twelve hours. No record of mileage is kept, and should the car need repairing on the road no deductions are made from the charge. Hour rates vary from \$3 to \$5, and at hour rates the customer is also deprived of the use of the car when repairs are being made. It is customary to either collect the charges in advance or have the customer pay the driver on giving up the car. Under these circumstances charging by the day or hour is unfair to both the customer and the garage, in charging the former for service he does not get, and in putting the latter at the mercy of an unscrupulous driver, who can pocket a proportion of the hire by claiming that part of the time was employed in repairs, or that the customer discharged the car sooner than he expected. Again, if no mileage record is kept, the profit or loss on each car rented is difficult to determine.

To give fair treatment to the customer and at the same time to protect the garage, the Central Auto Station Company, Pittsfield, Mass., rent their cars out on a mileage or hourly basis, the maximum total prevailing. The cars are fitted with clock, and season and trip odometers, and before leaving the garage the time and mileage odometer readings are entered on a rental slip, along with the name of the car and the driver's and customer's names. If the car is run steadily, the mileage rate as indicated by the odometer of 25 cents a mile is charged, but if the car is kept waiting, the hour rate of \$3.50 prevails. Should repairs be necessary on the road, the elapsed time is deducted from the hour rate. When the trip is finished the odometer and clock readings are again taken at the garage and entered on the rental slip, a specimen slip being shown in the accompanying illustration. The bill is then made out from this slip and delivered to the customer. It will be seen that the route is also marked on the slip, and that the slip acts as a check on the driver and customer,

and is conclusive proof in case of a dispute. The system is working with great success, and is well worth universal adoption by concerns desiring to embody the latest methods.

CENTRAL AUTO STATION CO.	
PITTSFIELD, MASS.	
RENTAL SLIP No. 17	
Date <i>April 20 '09</i>	
Car	<i>Stroms</i>
Odometer Out	<i>1061-5</i> In <i>114106</i>
Trip Odometer Out	<i>0</i> In <i>80.1</i>
Clock Out	<i>1:00 Pm.</i> In <i>5 Pm.</i>
Total Mileage	<i>80.1</i> @ <i>.25</i> <i>20⁰⁰</i>
" Hours	<i>4</i> @ <i>3.50</i> <i>14⁰⁰</i>
Driver	<i>Smith</i>
Route	<i>No. Adams, W. U. Auston</i>
Customer	<i>McBrown</i>
	<i>Bill #11672</i> <i>20⁰⁰</i>

Rental Slip That Admits of No Argument.

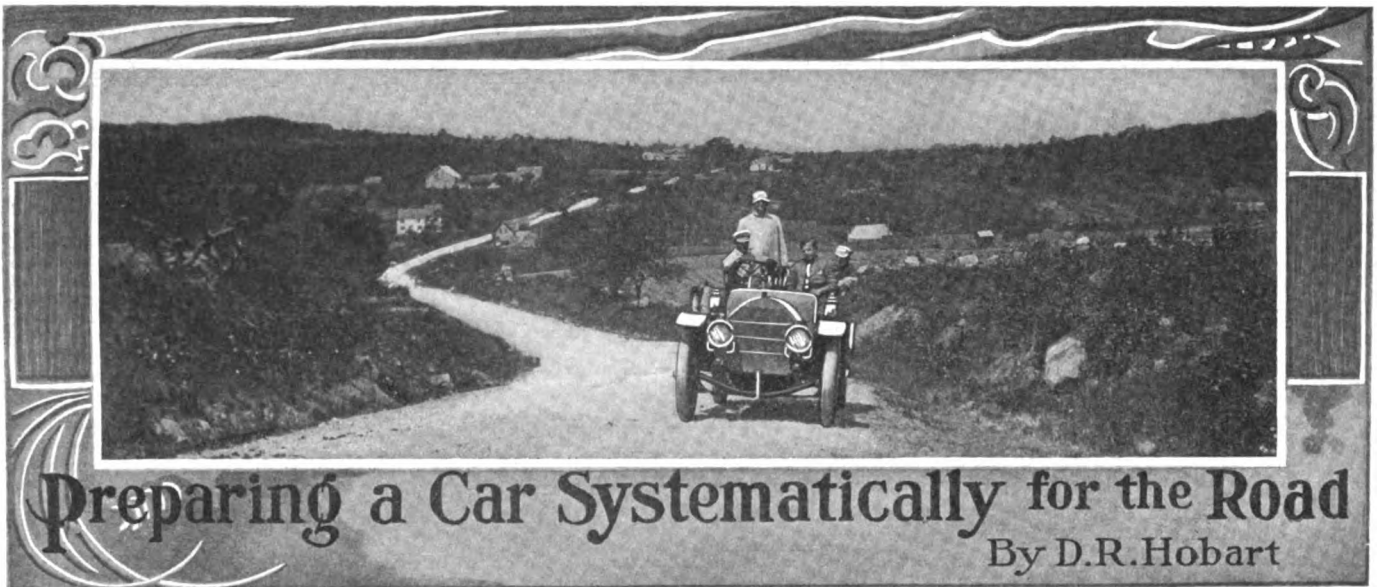

SYSTEMATIC procedure in preparing a car for the road and in attending to its wants during the trip will result in the necessary attentions soon becoming second nature to the operator, with the result of keeping the car in good condition. It is a well-known fact that most of the trouble occurring to automobiles come from negligence, outside of careless driving. Given a careful driver and proper attention, there is no reason why the life of a motor-driven vehicle should not be measured in years instead of months, as is too often the case.

Commencing Operations, Filling and Oiling.—The autoist, when commencing his preparations of the car for the road, should start by filling the water tank, which in most cars is combined with the radiator, with absolutely clean water.

After doing this, the pipes carrying the water to and from the radiator should be examined for leaks and the grease-cup on the pump screwed down one turn. The fan-belt should then be tested for tightness and the fanshaft oiled.

Then, beginning with the starting crankshaft and the front springs, and moving toward the rear of the car, every oil cup and hole should be liberally fed with oil and every grease cup screwed down one turn, not forgetting the gear shifter shafts and the brake shaft. As the oiling progresses, every moving part of the mechanism should be inspected, the steering linkage being tested for looseness, the clutch operated to "work in" the lubricant, and the spark and throttle levers and the pedals worked to and fro to loosen them up and distribute the oil. It would be well for the autoist to have a plan-view of the car with all oil cups and grease cups marked so as to facilitate the oiling operation.

Lubricating Oil Is Infinitely Cheaper than Worn and Broken Machinery.—Should a nut or bolt be found loose during the oiling, it should be tightened at once and not left until later on, as it may be forgotten, with disastrous results. To most people the number of places to be oiled seems too great, but as a matter of fact the complete oiling of a car takes but a few minutes and more than repays for the time spent in the longer useful life of the car.

Examining Tires and Springs, and Cranking.—The tires should be examined for cuts and weak spots, and if likely to cause trouble on the road should be changed. A glance at the springs will show if any leaves are loose or broken, and the nuts holding the spring clips should be tried with the fingers for slackness.

The gasoline tank can now be filled, the spark retarded and throttle partially opened, and the gear-shifter lever placed in the neutral position. The hand brake should be put on and the motor turned over by the starting crank.

In cranking a motor the autoist should grasp the crank handle with the left hand and hold on to the right dumb-iron with the

right. He is thus enabled to exert more power on the handle, and in case of a back-fire will not be injured, the fingers being merely thrown open as the handle moves downward. When a back-fire occurs when cranking with the right hand, the autoist is lucky to escape with a wrenched arm or a cut or bruises, as the position is awkward and the body is out of balance.

With battery ignition the spark should always be retarded on starting the motor, but with magneto ignition, which is in use on a large majority of cars to-day, the spark is fixed, or, if not, should be somewhat advanced.

Note Action of Motor and Lubricator.—Having started the motor, the autoist should listen for any unusual sounds while it is running and also closely watch the sight-feeds on the lubricator, adjusting them if necessary.

If the car is likely to be out after dark, the acetylene generator should be provided with carbide and the lamps filled.

If a gas tank is used instead of a generator, the autoist should see if the pressure gauge indicates that there is sufficient gas in the tank for the trip, and, if not, the tank should be replaced by a charged one.

In connection with filling the lamps it would be well to form the habit of wiping the tail-lamp glasses and the license-plate with a cloth, as these are usually neglected and become obscured by dirt, and may subject the autoist to arrest for not having a rear light or an illegible license-plate.

Trying Out the Car.—The autoist should now take his seat, and, withdrawing the clutch, place the shifter lever in the position for first speed, release the brakes, and start the car by engaging the clutch gradually.

While the car is moving the brakes should be operated, first the hand brake and then the foot brake, and if any adjustments are needed they should be made at once. A trial of the brakes with the car running is more valuable than a number of trials with the car at rest.

If the gear shifter lever does not work properly or the clutch slips, the fact will be indicated and adjustments made on the spot, saving the autoist trouble and humiliation on the road.

Easy Means of Remembering Procedure.—If the above method of procedure is followed, it will be surprising what a short space of time will be consumed in preparing the car. As an aid to memory, the words WONT GAT can be used, the initial letters of words describing the various operations being employed, thus:

Water.
Oiling.
Nuts and bolts.
Tires.
Gasoline.
Acetylene.
Trying-out.

ITALIAN INSTRUMENT FOR MEASURING CYLINDER BORES.

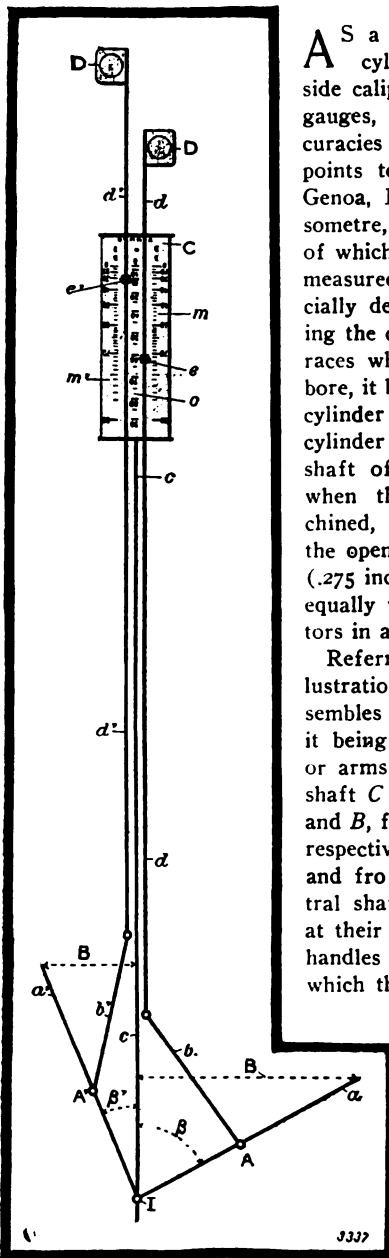

Diagram of Alesometre, Showing Operating Scheme.

Diagram and also the angles β' and β which the "ribs" or arms A and A' make with the central shaft. The graduations are placed upside down so that the operator can read them by slightly

As a rule the bore of a motor cylinder is measured with inside calipers, or in some cases star gauges, and to prevent the inaccuracies due to applying the caliper points to a scale, M. Paradis, of Genoa, Italy, has invented the alesometre, an instrument by means of which the bore can be accurately measured. The instrument is specially designed for use in measuring the cylinders of motors used in races where the classification is by bore, it being readily inserted in the cylinder through the opening in the cylinder head through which the shaft of the boring tool projects when the cylinder is being machined, provided the diameter of the opening is not less than 7 mm. (.275 inch). It is obvious that it is equally valuable for use by inspectors in automobile factories.

Referring to the accompanying illustrations, the instrument resembles the frame of an umbrella, it being provided with two "ribs" or arms $A' A$ pivoted to a central shaft C and controlled by links B' and B , fastened to sliders D' and D respectively. The sliders work to and fro in grooves cut in the central shaft and are reduced in size at their upper ends and fitted with handles D' and D , by means of which they are moved by the operator. A cylindrical casing C is fastened to the shaft and is slotted to allow pointers E' and E to move with their respective sliders when the handles are operated. The cylinder is graduated on its front face, the positions of the pointers indicating the distances $B-B$ in the dia-

inclining his head, and not disturbing the adjustment of the instrument. Two spirit levels E and F are fitted to the cylinder, one for vertical and the other for horizontal use. The central scale, between the two slots, is graduated in degrees, while the outer scales M' and M are graduated in millimeters.

To use the alesometre, the handles are pulled upward as far as they will go, folding the arms A' and A against the central shaft. The lower end of the instrument is inserted into the cylinder and the handles pushed down until the ends of the arms touch the walls of the cylinder. The pointers indicate the distances $B B$, and also the angles β' and β directly on the scales, and by referring to a table accompanying the instrument the diameter of the bore may be read off to six decimal places.

If the table accompanying the alesometre should be mislaid, the bore of the cylinder can be determined by simple trigonometry as the angles β' and β and the distances B' and B are known. The bore would then equal the sum of the products of each distance multiplied by the sine of the angle to which it corresponds.

It is doubtful whether such an instrument will long retain its accuracy under the rather severe usage usually given to measuring instruments both in the factory and at the track. It will be noticed that there are five joints in the instrument, and no provision for the inevitable slackness is made, so that measurements will sooner or later become unreliable. As the graduations are only in millimeters, it will be impossible to make as accurate measurements as with micrometer calipers, and cylinder diameters slightly over or under the even millimeter cannot be detected with accuracy.

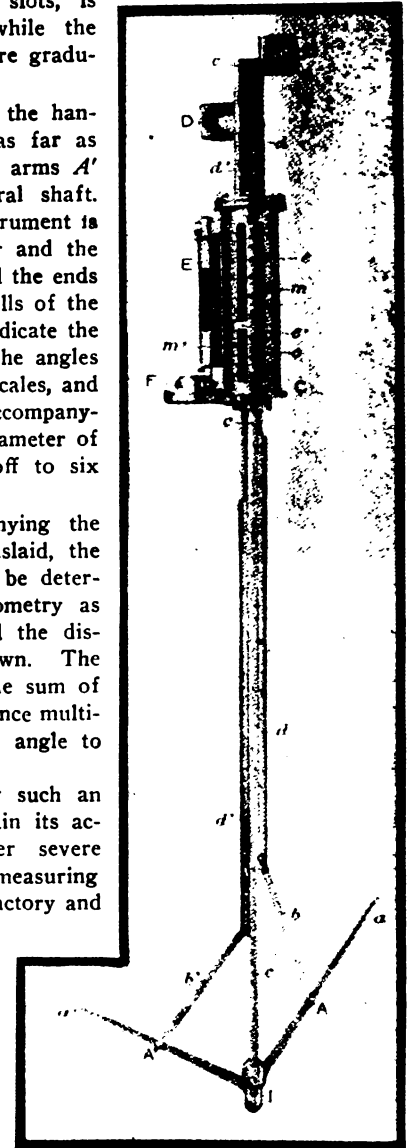

The Paradis Alesometre In Operating Position.

IRREVERSIBLE STEERING EXPLAINED.

The question is often asked, what is irreversible steering? This cannot be explained in a word. The first form of steering arrangement consisted of a series of arms and linkages. In extreme cases it was possible to so place the steering lever that road obstructions would turn the wheels out of their position, even against the driver's exerted strength.

The modern form of steering gear is such that this is impossible. The mechanism used differs from the old form. Moreover, it is self locking. The usual form of this is the worm, which, of itself, may not be forcibly reversed from the road end of the steering arrangement.

WHEN A LAMP GLASS BREAKS.

When the tail-lamp glass breaks, red tissue paper bought from a stationery or toy store can be substituted, the paper being either tied round the lamp with string or fitted into the frame which held the glass. As there is no head draught on the lamp, this "wrinkle" is perfectly feasible. If a sheet of paper such as is wrapped around butter can be obtained, it can be fastened on with wire after doubling it and greasing it, coloring with red ink or dye. This can be used for head and dash lamps also without coloring the paper, of course. A handkerchief can also be used, and if none are lost the glass can sometimes be held together by adhesive plaster.

Information for the Man Who Drives

Caring for Acetylene Lamp System.—As there is little night running during the winter months, the acetylene lighting system is more or less neglected, the generator being left with stale or partially used carbide in the chamber, and the residue being allowed to clog up the water port and the waste ports. The rubber lamp connections and gas-bag suffer also by deterioration as well as the burners and gas valves. For the proper maintenance of the system, strict cleanliness should be maintained at all times and the various parts should be examined and replaced from time to time as necessary. The results of neglect are seen every spring in lime deposits which have to be removed by means of a cold chisel, in porous connections and in clogged burners which resist the cleaning wire and necessitate the scraping of the burners. By following the accompanying directions, the automobilist can depend on having his lighting system in good shape whenever he desires to use it.

Care of the Generator.—The interior of the carbide chamber or basket is more or less in contact with the water distribution apparatus and the parts of both apparatus are liable to clogging by the formation of lime residue in the generation of gas. If this residue is allowed to collect, it will have to be removed with a chisel, which is a ticklish operation in a light construction like that of a generator, especially around the water valve or its outlet. Acids are sometimes used to remove the deposit, but as they eat the metal, their use should be prohibited. The basket and pot should be thoroughly washed out after each run with water, the water outlets being cleaned with special brushes, when these are obtainable, or by wires, removing all traces of lime. The water valve should be scraped and tested to see whether it seats properly, care being taken not to damage the valve or its seat in so doing. While the valve is dismantled for cleaning it would be well to see that its stem is straight and that it works with some ease in the threaded portion attached to the water chamber. The gas valves should be cleaned and should seat snugly, so that there will be no leakage past them. This applies also to the gas valves on the lamps.

The best position for the generator is on the runningboard just back of the change-gear quadrant, and sufficiently far out from the frame to allow a free circulation of air all around it. The generator will keep cool in this position and will perform its work to the best advantage when properly cooled.

The Much-Neglected Condenser.—When used at all, the condenser or its substitute is put off in some position where it becomes caked with mud and is almost forgotten until it is full and the lamps begin to flicker. Then the mud is cleaned from it and it is drained out. It should be placed so that it is close to the lamps, where it will catch all of the condensation from the gas going to the burners, and in addition any water that may enter the burners due to washing of the car. It should be emptied from time to time, say once or even twice a month, when the lamps are in regular use. The majority of troubles with acetylene lamps are due to lack of a condenser and to the use of too small metal tubing.

Regarding Tubing and Gas Bags.—Copper tubing is considerably used for piping the gas to the burners, but it is liable to erosion by the gas, and standard 1-8-inch gas pipe is better and lasts longer. The gas bag and rubber lamp connections should be kept clean and not painted, as is often done to correspond with the car, as paint rots the rubber, with the result that it is soon unserviceable and must be replaced. When the rubber is to be washed, only water should be used and the goods should be carefully dried before putting them in service again.

Care of the Lamp.—It goes without saying that the burners should be kept clear, wires being passed through the gas apertures and the air apertures at intervals. The burners should be unscrewed occasionally and blown through, and the interior of the burner body scraped clean of deposit. Outside of keeping the lenses and glasses bright and polishing the exterior of the lamp, there need be no other attention paid except to keep all joints and the bracket screws or nuts tight.

To Avoid Clutch Trouble.—One of the greatest sources of trouble for the novice lies in the clutch. This may be just right, it may be slipping or it may be what is called fierce. The second manifests itself in such pleasant situations as climbing a hill when, with the engine running at its highest speed and the proper gear engaged, the car starts to run backward instead of forward. Or on the level, with the engine racing and the high gear in, no speed results.

The last condition shows itself in the sudden jumping forward of the car when the clutch has been let in, or it may even be so severe as to shear off the bevel driving gear when used with studded non-skid tires or any form that will not slip easily.

To repair the first, look at the leather, if this is all in good shape with an apparently good surface, but has lubricating oil on it, wash the surface well with gasoline. It is not a bad idea to roughen the surface of the leather a little with a coarse file.

The harsh or fierce clutch is remedied by the application of a proper oil for this purpose. Castor oil is universally used and a good way is to soak the complete clutch in it over night. This will cure a case of harsh leather, but it may be that the trouble is only a lack of adjustment of spring tension. Usually there is an adjusting nut and a locking nut. Back off the latter and make an adjustment. Then tighten the lock nut to retain it. For the beginner, it is better to adjust a little at a time and make several successive jobs of it than to try to do it all at once. But always adjust it as soon as possible.

The Proper Care of Chains.—The owner or driver of a chain-driven car should learn very early in his driving career to care for the driving chains in a proper manner. While chains have been known to run an entire season without any care or additional lubrication, this practice is deprecated. To care for a chain properly, one should get into the habit of lubricating every so often and so time these intervals that they occur before the chain is in need of the oil. In addition to this regular lubrication, there should be some set time at the end of which the automobilist takes the chain off, cleans it thoroughly, and inspects it to detect faults.

A month is a good length of time for this, and an excellent way to proceed is to take the chain off and throw it into a pan of kerosene. In the morning, all of the dirt will have passed from the chain to the liquid and can be found in the bottom of the pan. Take the chain out and throw the liquid and dirt away. Then clean the pan and in it wash off all traces of the kerosene with gasoline. Having done this, hang the chain up to let the gasoline evaporate.

The chain then will be both clean and dry. Now inspect all rollers, links, rivets and bushings, taking note of any unusual wear as indicating by looseness or play. If defects are found, they should be remedied. Then, having the chain clean, dry, inspected and passed upon as O K, an excellent method is to soak it, or, better, boil it in a heavy melted lubricant. The best quality of beef tallow mixed with a little graphite is good. Many do not like the latter, in which case a high-grade oil may be substituted for the purpose.

COMPOSITION OF COMMERCIAL PETROLS.

By BERTRAM BLOUNT, F. I. C.

Since the modern automobile came into use the nature of the fuel has been a question of much interest, leading to many tests. Originally the specific gravity was measured with a hydrometer, but this was soon abandoned as valueless. Many drivers have a lurking doubt about the quality of their fuel and as soon as trouble crops out blame the petrol. In an endeavor to prove or disprove this, the writer purchased in London a number of samples of seven different brands, all in sealed cans. Thus it may be taken that it was such as the producers habitually make.

The samples were examined by the usual fractional distillation, and their specific gravities and those of their fractions were determined. In addition, a certain number were analyzed for sulphur, and one or more examples of each brand were burnt in a calorimeter. The results are shown in the table.

It is often supposed that the calorific value varies with different origin or quality, but in fact the variations are small. This refers to a given weight of the fuel; by volume there is a considerable difference owing to the different specific gravities of petrols. The calorific value stated in calories per liter and in B.T.U. per one-tenth of a gallon indicate this, and show that as long as petrol is sold by measure instead of weight an appreciable advantage is secured by buying the heavier grades, provided they can be burnt efficiently.

The determination of the calorific value was a matter of difficulty. A bomb calorimeter was used which, though easy to manipulate when solid fuels are burnt, needs special handling with a volatile liquid like petrol. In spite of the fact that there is an excess of oxygen at a pressure of 25 atmospheres, complete combustion was difficult to secure. Moreover, the explosion was so violent as to shatter the platinum cup in which the petrol was contained. After many trials the petrol was enclosed in a relatively deep cup provided with a celluloid envelope rising above the edge and contracted at the top so as to form a sack with a relatively narrow mouth. By this means the vapor was confined sufficiently to cause it to burn at a moderate rate and imperfect combustion and violent explosions were avoided. The percentage of sulphur in all cases is so small as to be without practical significance. The petrol engine is free from this drawback which occurs with coal.

The remaining figures are worthy of study. It may be noticed that the specific gravity of any given brand varies within comparatively narrow limits save in cases where there are two grades. The percentages distilling within limits are less regular, but the variations are moderate, and not greater than might be expected with a commodity which is of a very complex mixture.

Three of the brands present so general a similarity that they may be grouped and their average composition compared.

	Pratt.	Shell.	Carburine.
Below 100° C.....	65.0	66.6	66.5
100 to 120° C.....	24.8	23.9	23.7
120 to 133° C.....	6.0	5.0	5.8
Above 133° C.....	3.0	3.1	2.8
Loss.....	1.2	1.4	1.2
	100.0	100.0	100.0

The resemblance is sufficiently close to make possible a specification for petrol filled by all three brands, thus freeing the consumer from the obligation to buy any particular one and allowing that each may be employed as convenience may dictate.

The other brands differ too widely to admit of grouping, but comments may be permitted. Anglo "760," which has a specific gravity of 735-740, is in a class by itself. It differs from the foregoing in the small fraction distilling below 100 deg. Cent., and the middle fraction coming over at 100-120. The succeeding fraction from 120-133 is large, but the tailings (distillate above 133) are as small as those brands discussed.

Carless's "standard" is the lightest of those examined, 86.5 per cent. distilling below 100 and 98 per cent. below 120. Like Anglo, it stands in a class by itself, and is similar to the petrol of the days when .68 was desired and .70 was an upper limit. If fuel like this is desired a different specification is necessary.

TABLE SHOWING THE RESULTS OF AN EXAMINATION OF SAMPLES OF SEVEN DIFFERENT BRANDS OF PETROL.*

SERIAL NUMBER	TRADE NAME	Specific gravity.	65° C.	60° C.	63° C.	58° C.	56° C.	63° C.	65° C.	63° C.	58° C.	55° C.	60° C.	60° C.
1	Anglo "760"	0.739	70° C.	0.719	0.717	0.711	0.710	0.712	0.710	0.700	0.718	0.715	0.705	0.705
2	Shell	0.717	65° C.	0.708	0.707	0.706	0.706	0.706	0.706	0.706	0.706	0.706	0.706	0.706
3	Pratt's Motor Spirit	0.711	60° C.	0.710	0.710	0.710	0.710	0.710	0.710	0.710	0.710	0.710	0.710	0.710
4	Carless Capel "Standard" "Mevril"	0.700	56° C.	0.699	0.699	0.699	0.699	0.699	0.699	0.699	0.699	0.699	0.699	0.699
5	Shell	0.716	63° C.	0.707	0.707	0.707	0.707	0.707	0.707	0.707	0.707	0.707	0.707	0.707
6	Pratt's Motor Spirit	0.711	60° C.	0.710	0.710	0.710	0.710	0.710	0.710	0.710	0.710	0.710	0.710	0.710
7	Carless Capel "Mevril"	0.718	63° C.	0.704	0.704	0.704	0.704	0.704	0.704	0.704	0.704	0.704	0.704	0.704
8	Shell	0.716	63° C.	0.707	0.707	0.707	0.707	0.707	0.707	0.707	0.707	0.707	0.707	0.707
9	Carburine	0.717	65° C.	0.705	0.705	0.705	0.705	0.705	0.705	0.705	0.705	0.705	0.705	0.705
10	Carburine	0.717	63° C.	0.705	0.705	0.705	0.705	0.705	0.705	0.705	0.705	0.705	0.705	0.705
11	Pratt's "Perfection"	0.710	58° C.	0.698	0.698	0.698	0.698	0.698	0.698	0.698	0.698	0.698	0.698	0.698
12	P. G. R.	0.715	58° C.	0.706	0.706	0.706	0.706	0.706	0.706	0.706	0.706	0.706	0.706	0.706
13	P. G. R.	0.705	55° C.	0.700	0.700	0.700	0.700	0.700	0.700	0.700	0.700	0.700	0.700	0.700
14	Anglo "760"	0.736	70° C.	0.719	0.717	0.711	0.710	0.712	0.710	0.700	0.718	0.715	0.705	0.705
15	Pratt's Motor Spirit	0.715	63° C.	0.701	0.701	0.701	0.701	0.701	0.701	0.701	0.701	0.701	0.701	0.701
16	Pratt's Motor Spirit	0.712	63° C.	0.702	0.702	0.702	0.702	0.702	0.702	0.702	0.702	0.702	0.702	0.702
17	Shell	0.719	60° C.	0.706	0.706	0.706	0.706	0.706	0.706	0.706	0.706	0.706	0.706	0.706
18	Carburine	0.717	63° C.	0.705	0.705	0.705	0.705	0.705	0.705	0.705	0.705	0.705	0.705	0.705
19	Russian Petrol	0.705	60° C.	0.700	0.700	0.700	0.700	0.700	0.700	0.700	0.700	0.700	0.700	0.700
20	Russian Petrol	0.705	60° C.	0.700	0.700	0.700	0.700	0.700	0.700	0.700	0.700	0.700	0.700	0.700

*Petrol is the English term for all petroleum products, suitable for use in internal combustion engines and is comparable with the word gasoline, extensively used in the United States, or the word essence, which the French apply to the engine fuel. The word petrol is a very logical one, being derived from the word petroleum, from which the fuel is obtained by distillation.

Letters Interesting and Instructive

CAR HARD TO START.

Editor THE AUTOMOBILE:

[1,852.]—I have a two-cylinder 1907 model which, after giving much good service, has begun to get freakish. It runs well at times, but overheats so badly that it is necessary to fill it with water every twenty miles. Also the engine is very hard to start. Can you suggest anything which will overcome this?
G. H. G.

New York City.

Your machine is probably in need of a general cleaning and overhauling; carbon deposits in the cylinders, scale and mud in the cooling system will doubtless be found responsible for both the failings you mention. As in this car, the entire power plant is hung on the frame by bolts in the ends of the cylinders, it will be a somewhat lengthy process to take these off for cleaning, and a better scheme will be to use one of the decarbonizing fluids on the market. Fill the cylinders with this through the spark-plug hole, making sure that the compression cocks are closed, and let it stand over night. In the morning the greater part of the fluid will be found in the crankcase, whence it may be drained off, as well as through the compression cocks. Put plenty of oil in the crankcase before starting again.

The cooling system can be effectively cleaned with kerosene, which will loosen up the scale. The hose connections had better be removed, to be replaced with new ones, and the openings stopped with corks before pouring in the kerosene. This, too, should be allowed to stand over night. After the engine has been cleaned out in this way a new adjustment of the carbureter, effected by the air lever under the steering wheel, will probably be found advantageous.

WHY PNEUMATIC TIRES?

Editor THE AUTOMOBILE:

[1,853.]—Will you please inform me through the columns of "The Automobile" why the pneumatic tire is used on automobiles in preference to solid rubber?

A. B. LANGWORTHY.

Soldiers Home, Cal.

The pneumatic tire is used to secure a desirable spring effect, and to reduce the vibrations. The former is in addition to the usual body springs, which as yet are not perfect. The springs also absorb some, but not all, of the vibrations set up by the rapid passage of the car over road surfaces which are far from even. The pneumatic tire, properly filled with air, possesses the much-desired quality known as resiliency. The air-filled tire has the two additional qualities: first, yielding to or swallowing up small obstacles, and, second, obtaining a better grip on the road. The former is very desirable because it does away with much of the lifting up of the wheel in passing over obstacles. It there-

fore makes the car, so equipped, ride easier. The ability to take a better grip upon the road allows, in addition, greater speed than could be obtained with the heavier and less resilient solid tires. As to the weight, inflated pneumatics would weigh about one-third of the solids, so when reducing the weight as low as possible, why add this weight unless there are some advantages to counterbalance it?

On the other hand, the solid tire has a number of undeniable advantages, such as the freedom from punctures, and the attendant saving in worry. This is, however, being minimized by the use of demountable rims and tires.

AUTOMOBILE SCHOOLS.

Editor THE AUTOMOBILE:

[1,854.]—What good schools are there for learning the mechanism of the different makes of automobiles and the ways of operating and repairing them? How long are the courses and what is the cost?
Albion, N. Y. DAN BULLARD.

Aside from the correspondence schools, of which there are a number, you would probably get more from a school in which the practical workings were emphasized. If you are in a position to come to New York City, there are several excellent automobile schools here, one of which would doubtless suit you. The Y. M. C. A. maintains such a school at its Fifty-seventh street branch. The cost of the course at this school is about \$50. It may be completed in either four or eight weeks. In the former case, there will be four shop periods of three hours each and two road lessons of one hour each, per week. In the longer course these are just halved, that is, two shop and one road lesson per week.

TO CORRECT A MISS.

Editor THE AUTOMOBILE:

[1,855.]—My car, a four-cylinder model, misses persistently in one cylinder, especially at low speeds. I have changed spark plugs, inspected the high-tension wire and adjusted the vibrator, but without results. The car has been in use for little over a year and is otherwise in good condition.
Brockton, Mass. PUZZLED.

Such a miss as you describe is as likely to come from an air leak into the inlet as from the ignition, and since you have gone over the latter so thoroughly it will be well to try the former. In case the cylinders are separate, or if there is a separate branch of the inlet pipe for each cylinder, the leak will probably be found where the pipe bolts on to the cylinders. A new gasket is the remedy. It is also possible that the leak may be around the valve stem. In this event a new valve stem guide should be provided. Or, if the valve guide is integral with the cylinder casting, it may be bushed.

TRANSMISSION TYPES AGAIN.

Editor THE AUTOMOBILE:

[1,856.]—Will you please inform me through the medium of "Letters Interesting and Instructive" what is the difference between the selective and progressive types of transmission?
A READER.

Longmont, Colo.

The difference between the selective and progressive transmission is mainly a difference in the method of operating the speed changes. In the former the operator may select the speed desired and change to it at once without passing through any other speed. With the progressive type the continuous or progressive movement of the gear-shifting lever gives in succession the speeds from the lowest to the highest. In this form, if the low speed is engaged, and the high is desired, it is necessary to pass from low to second and then to high. If there are four speeds, from low to second, second to third, and third to high.

CYLINDER OIL TESTS.

Editor THE AUTOMOBILE:

[1,857.]—Would you kindly answer through "Letters Interesting and Instructive" what is one of the best ways to subject cylinder oil for an automobile to a fire test, and what is the requisite test for a good oil?
Independence, Kan. L. V. STANFORD.

There are really two parts to the fire test, as it is called. One is the test for flash point. This may be determined as follows: Take two pieces of glass of the same size and large enough to cover a small glass beaker. In one of them cut a couple of notches. These are for two purposes. One is for the thermometer and the other for the flash point determination. Insert a thermometer in the beaker, filled with the oil under test. Place the notched glass over this and the other piece of glass over that, taking care to cover the notch not in use. Now uncover this notch, note the temperature, and apply a lighted match to the opening. If nothing results, warm the oil slowly over a flame to a higher temperature and take another trial and reading. Continue the test until upon the application of the lighted match the oil vapor over the oil flashes. The thermometer reading at that point gives the flash point. The glass plates may now be removed and heating continued. The match is applied at similar intervals, until finally the oil burns, which will usually occur at about 50 degrees above the flash point.

An additional test is for precipitation at a known temperature. This is also made in a beaker. Two ounces is the usual amount. It is heated to the desired temperature, at which the oil may change color, but must not show a precipitation. Still another good oil test is the evaporation test. This is the result of slow heating, and the usual speci-

fication is that the oil shall not lose over 5 per cent. of its volume when heated to 150 degrees Fahr. for 12 hours.

Flash point, burning point and precipitation vary with the service for which the oil is intended, thus air-cooled motors always require a much higher oil test than those for water-cooled machines. As this is some indication of the quality, it is higher priced and harder to obtain, both in purity and evenness, and as a matter of convenience. Three hundred degrees is about the lowest flash point that should be accepted. With this would go 350 to 400 burning point and about 500 precipitation lower limit. In fact, oils may be had for any desired flash point and burning point up to 450. Beyond that they are hard to obtain. It is frequently claimed that this, that or the other oil will test 800 degrees, meaning the burning point. In the face of this statement, a simple home test as outlined above will prove whether or not you are getting what you are paying out your money for.

TIRE INFLATION EXPLAINED.

Editor THE AUTOMOBILE:

[1,858.]—There have appeared in your paper several letters asking about the effect of the Maxim tire inflater on the rubber of tires. In your answer to these letters you have allowed it to be inferred that explosive mixture or gasoline vapor is taken from the engine cylinders. As manufacturers of the Maxim inflater, we would like to have this wrong idea corrected. In the Maxim inflater nothing but exploded gas can get into a tire. If a moment's thought is given the question, this will be clear to anyone.

The tire must be inflated when the car is standing still. The engine, therefore, must be running idle. Now, an idle engine cannot be given its full throttle opening or it will race. If the throttle is not opened full, the compression cannot be normal. It must be very much below normal. This being the case, it cannot get out, as it cannot lift the inflater check valve. Hence, unexploded charge containing gasoline vapor cannot possibly get into the tire.

As only high pressure gas can lift the check valve, it becomes necessary to ignite the charge in the cylinder to get this pressure. But even the ignited charge of an idle engine is not high enough to get into a tire against the resistance of the tire valve and the pressure in a tire. It is, therefore, necessary to get at least some load on the engine. This is easily done by cutting out the ignition on three cylinders, leaving only the one fitted with the inflater to ignite. This gives good explosions in this cylinder, and a high enough pressure to inflate a tire. There can be no gasoline vapor in this gas. The only deleterious matter which can possibly get into the tire is oil, which may be carried over from an engine having excess cylinder lubrication. This is trapped, however, along with the moisture which is one of the products of combustion.

In inner tubes which have been inflated for over a year by this inflater, never having had anything else used on them, the rubber is distinctly better than is usually the case. All this has been proven by the Hartford Rubber Works Company, makers of Hartford tires, and many users of the inflater, after months of service.

F. A. LAW MACHINE COMPANY.
Hartford, Conn.

The point which the manufacturers have endeavored to bring out is that unless the mixture is correctly proportioned, that is, exactly right, the explosion pressure will not be the maximum and therefore will not be able to lift the check valve. In case the mixture is just right, it will be completely burned and thence no gasoline, vapor or otherwise, will enter the tire.

The effect of excess oxygen, hydrocarbons and oil will still be present.

AN AMERICAN SPRING WHEEL.

Editor THE AUTOMOBILE:

[1,859.]—Being ourselves engaged in the manufacture of a spring wheel, we were very much interested in the article entitled "French Spring Wheel Appears Meritorious," in "The Automobile" of April 15.

Your account shows very clearly the manner in which this wheel works, but there are to our mind two disadvantages to this or any spring wheel dependent for its riding qualities on radial springs. The first and most important is that in a radial spring wheel, even where the springs are put in without tension, by far the greater share of the load falls on the springs immediately above and below the hub. The springs on the sides are almost useless, and unless they are fastened by a perfect ball and socket joint, so that the springs pull straight and do not bend, what little load they carry is carried at a tremendous disadvantage.

We notice in the article that two of the springs were broken. Wherever a spring is pulling out of line with its axis the likelihood of fracture is much increased. Moreover, as each spring in the radial spring wheel must in turn carry more than its share of the load, it must be made too heavy to give the proper riding qualities. In a wheel with the springs parallel with the hub, where each at all times bears only its proportional share of the load, the springs can be made light enough to give the desired riding qualities.

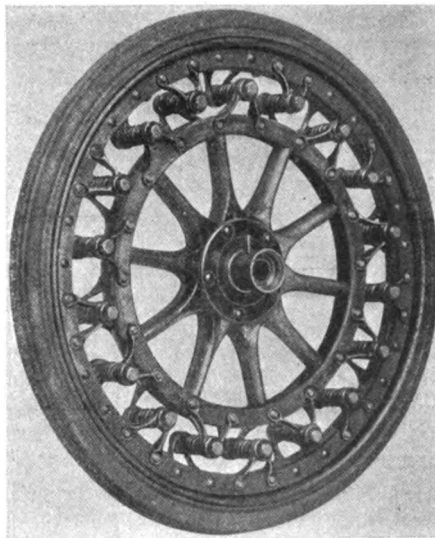

The Seaton Spring Wheel.

The second objection, we observe, has been recognized by the inventor, namely, the tendency to wobble or dish. He has incorporated a set of four solid braces. This, however, seems to us but a make-shift, as it is practically the same thing as depending for radial strength on four spokes in the solid wheel. With this construction, running up on curbs at an angle or turning out of car tracks would be very likely to prove disastrous.

THE AMERICAN SPRING WHEEL CO.
Cleveland.

The Seaton spring wheel is herewith shown. As the illustration reveals, the springs are coil springs, but are so used as never to be subjected to alternate tension and compression in a radial direction, as is the case with the French wheel previously mentioned.

DEFENDS WATER COOLING.

Editor THE AUTOMOBILE:

[1,860.]—In the issue of April 22, of "The Automobile," appeared a letter from the Franklin Company relative to air versus water cooling, in which some statements were made to which I wish to take exception. I have, personally, made a number of gasoline engine tests. In the most thorough and satisfactory of these, the results were such as to give a heat balance in which the percentage of heat converted into work was 20.76 per cent. for partial load, and 22.77 per cent. for full load. These results are not exceptional, as may be shown by the

following similar figures taken from a well-known authority on gas engines:

Per Cent.	Test by	Place.
20.6	Unwin	London
20.6	Fernald	New York City
20.7	Robertson	Lafayette
21.0	Robinson	England
22.8	Kennedy-Tower	London
27.7	Spangler	Philadelphia
30.0	Seraing, Belgium

The average of these with my own full load result amounts to 23.27. As resulting from no less than eight widely different, wholly independent, and careful investigators, this may fairly be taken as representing a more accurate figure than the 10-year-old one taken from Clerk.

Taking this as correct, then, the whole force of Mr. Holmes' statement, "We are safe in assuming that the water-cooled motor which we are testing would do no better," and the subsequent conclusion as to air superiority, vanishes into thin air. In fact, the whole letter, being based upon this, loses its force.

Instead of a gain in fuel economy as therein pointed out, the tables are turned and there is a fuel loss. It is hard to discover how the gasoline consumption was figured, but on the same basis the apparent gain of 14.1 per cent. drops to a loss of 21.3 per cent.

Strictly aside from the other points, which I do not wish to speak of as being likely to provoke a prolonged discussion, the above, based upon careful and reliable experiments, should be given equal weight with the previously published statements.

CHARLES A. FULLER.
Brooklyn, N. Y.

The above letter is published complete as sent in, and as the points brought out therein are self-evident, no comment will be made.

NOT MODEL T FORD.

Editor THE AUTOMOBILE:

[1,861.]—In my letter (1688) in which I asked you in regard to getting new piston rings for my model F Ford two-cylinder car, my letter was made to read model T, which is the new model and a four-cylinder car. Mine is, I think, the 1905 type; however, I have had it fixed up and it is running nicely. As it misrepresented the Ford car and was an injustice to the makers, I think it right that I should ask you to please make the correction. This should have been done before now, but I was away from town at the time and for some time after.

Pecos, Texas. J. B. NEILL.

We have printed the letter in full above, but fail to see where there was any reflection upon the makers. Piston rings wear out on four-cylinders as well as upon twos, and when so worn require replacement, regardless of make or type.

PUMP LUBRICATION.

Editor THE AUTOMOBILE:

[1,862.]—Will you please advise me what sort of lubricant to use on the water pump. Mine is of the centrifugal type.

Hoboken, N. J. A. K. LEE.

Grease is the proper lubrication for a pump, and it should be stiff enough so that the water will not wash it away. Be careful not to use too much, as highly heated water tends to carry it into the radiator and deposit it there, where it is liable to clog the circulation, or at least, reduce the efficiency of the radiator. See the article on "Automobile Cooling Systems Analyzed," March 25 issue of THE AUTOMOBILE, page 503, relative to the lubrication of pumps. It is there pointed out how a person may change the shape of the gears in a gear pump as to make it self contained as to lubrication. A somewhat similar method of procedure might be worked out for other types of pumps.

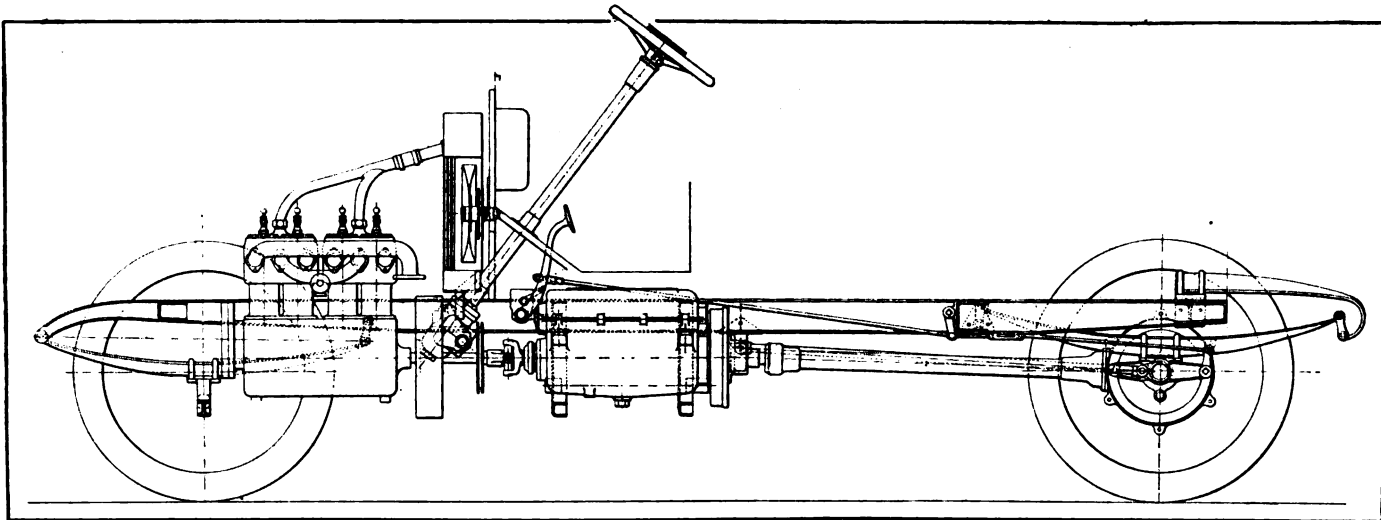

Ampere Looks Like Any Other French Car in General Appearance, Except for the Hand Levers.

ELECTRO-MAGNETS REPLACE MASTER CLUTCH ON FRENCH CAR

PARIS, April 20.—In the interests of simplicity, there have been many devices brought out, some of which did not survive the test of time and popular service. A newcomer here bears all the earmarks of being very much simplified, and, in addition, has been subjected to over two years of severe tests. Having survived this unscathed, it seems safe to any that the many unusual features incorporated in the Ampere Light Car are commendable.

The elimination of the clutch has long been a dream of automobile inventors. So, too, with the differential there have been attempts without number to simplify or dispense with that source of trouble and expense. Speed changing, the bugbear of the novice, is a continuous and never failing source of discussion. Then, when the new car is said to have no clutch, no differential, no speed change lever, and yet works satisfactorily, it is seen that the announcement is epochal, and the details of absorbing interest.

The fundamental principles of all of the sources of simple operation may be applied to any make of car, but the house of Ampere has, thus far, contented itself with a single light-weight model of 10-16 horsepower.

Engine Not Radically Different.—The construction of the motor is not unusual. The cylinders are cast in pairs, with ample water jackets, extending rather low down on the piston stroke. The latter is long, being 100 mm. (3.94 inch) for a bore of 80 mm. (3.15 inch). The valves are located on the left side of the motor and are interchangeable. The exhaust pipe is carried across the cylinders and down at the rear.

A very simple inlet pipe is, likewise, very short and leads to the carbureter, which is of special construction. The ordinary vaporizer is of the constant level type, with a float which maintains the fuel at a level, 1 mm. below the top of the spraying nozzle, this height having been proved right in practice. In the carbureter used on the Ampere, the level which gives the best results is 10 mm. below the nozzle tip. The lower level calls for a much stronger suction, and this is obtained by forcing the incoming air through the air passage at a correspondingly high pressure. At the same time

this passage is so shaped that the air current is given a rapidly whirling motion. The latter, being a necessity in this device, is further augmented by the use, at the air entrance, of a series of fan-shaped blades which deflect it. In this manner a sort of whirlpool of air is formed, causing a central depression around the spray nozzle and is strong enough to suck the gasoline up for more than the 10 mm. necessary. The air pressure being varied according to the speed of the engine, the amount of gasoline drawn into the carbureter, which is entirely dependent upon this pressure, is exactly proportioned to the speed. Therefore, no fuel is wasted and condensation is prevented. Additional air enters the mixing chamber by an opening directly opposite to the first and so located that the two air columns meet one another.

To return to the engine details, the crank case, of aluminum, is hung directly upon the main frame, which narrows at the dashboard for this purpose. The cylinders are cooled with water, circulated by a gear-driven centrifugal pump. The radiator, following the practice of Renault and C. G. V., is placed at the rear of the engine, on the front of the dash. It is of the vertical tube type, with a fan inside of it, driven by means of a belt from a pulley on the crankshaft extension.

No Sign of a Master Clutch.—The first sign of the difference between this car and any other lies in the flywheel and the gearbox directly back of it. The flywheel is for balancing purposes only, and as a result is of exceedingly plain appearance. Between this and the transmission is placed a single universal joint to care for the possible difference in level of the engine and transmission, the former being on the main frame, and the latter on a dropped subframe of channel section.

The transmission is of the individual clutch type, the clutches consisting of electro-magnets. As the small cut, displaying the parts, shows, the jackshaft is above the mainshaft. Upon the latter the gears are placed, which are clutched up to the shaft to obtain the different speeds. These are three in number, with direct drive on the high. To engage any gear a current is impressed on the windings of the magnet, which is keyed to the shaft. This attracts the plate carrying the gear, and, intimate relations having been established be-

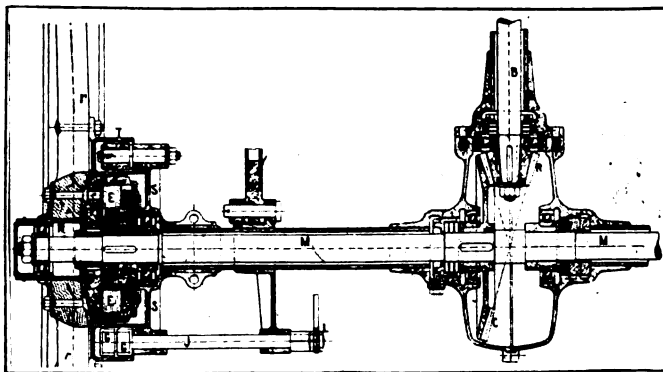

The One-Piece Rear Axle Looms Up Large.

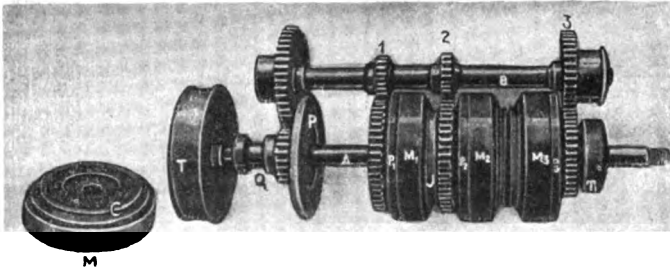

Transmission Parts, Showing Clutches in Place.

tween the two, just as would be the case with jaw or other clutches, the desired speed is obtained. There are four of these electro-magnets and four of the plates, that for the high speed being made integral with the gear itself.

Magnetic Clutch Parts Look Very Elemental.—The other small cut shows the plates and other parts, comprising the whole of two clutches. One of these is separated and the other assembled. In the one which is taken apart, *P* is the plate, carrying the gear *E*. *M*₁ is a full view of the magnetic plate and shows the keyways, used in fastening it to the shaft. At *B* is the magnet complete, with a wire leading to the rings. On the right is the magnet set into place in *M*₁. These represent at the same time the gears themselves and their method of operation, and, with the case and bearings, complete the transmission.

Directly back of the gearbox is a brake drum and internal expanding brake. Operating here, ahead of the bevel gear reduction, the advantage in braking is increased in that ratio.

Cardan Shaft Drive Is Regular.—Seekers after variety will find none in the shaft drive, which is a good example of designing along standard lines. The driving shaft is enclosed in a stout tube and carries a universal joint at the front end only. The tube is free at the transmission end. The torsion rod is pivoted on the center line of the joint, so that its action is correct.

An inspection of the line drawing of the rear axle construction displays another excellent piece of designing. The differential will at once be missed and the resulting simplification noticed. The rear construction then simmers down to the gears themselves, their shafts and the requisite thrust and radial bearings. All of these are of the ball type, and provision is made to take thrust in both directions, an unusual feature.

One-Piece Rear Axle of Great Strength.—One outcome of the elimination of the balance gear is that it allows of the rear axle being made in a single piece, so proportioned as to have the greatest section at the point of maximum bending moment, the center. This gives great strength to the whole rear construction. On the outer ends of the rear axle are keyed a pair of magnetic clutches, one at each end. Except for the diameter, which is slightly greater, these are the same as the clutches used to operate the transmission gears. The mode of operation is the same, also. When current is turned into the magnet *E*, contained within a recess in plate *D*, the corresponding plate *P*, incorporated in the rear wheel, is attracted, and as long as the current passes and energizes the magnet, is driven by the rotating axle. As soon as the current is cut off the wheel is freed, due to road resistance and is no longer driven from the motor.

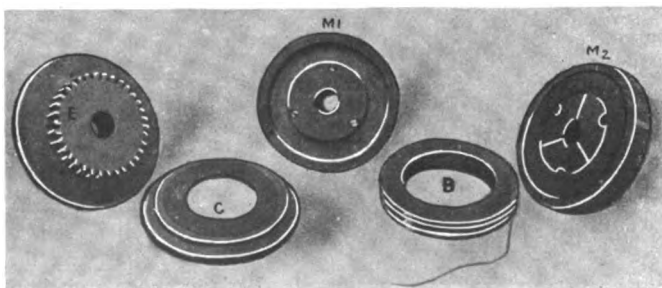

How the Magnetic Clutches Look When Disassembled.

Source of Differential Action.—This is the action which displaces the differential. The steering gear turns free up to a certain angle, at which it automatically cuts off the current to the inner wheel. The inner wheel, thus being disengaged and running free, while the outer wheel continues to drive the car, a perfect differential action is obtained. This is all done automatically by the movement of the steering wheel, and no manual work on the part of the driver is necessary.

The brake drums, wheels and other parts are standard, as is seen in the photograph, in which *M* is the magnetic clutch and *F*; *F*₂ the two halves of the hub brakes.

The control really displays all of the simplifications, at which the innovations are aimed. All told, it includes the steering post, on which are, besides the wheel itself, the spark and throttle levers, above both and in the most convenient place, a finger lever, which operates all speeds by a limited movement of perhaps 3-8 inch per speed. There are no hand levers and but two foot pedals. The right of these operates the brakes in the rear hubs. The other, answering to the ordinary clutch pedal, upon a slight forward movement, cuts off the current to all clutches, in which it follows the action of any other clutch. A further movement results in the application of the shaft brake. A toe pedal may be used for acceleration and is placed at the right.

Source of Electric Current Is Interesting.—The two sources of current, on the other hand, are of live interest, as on an

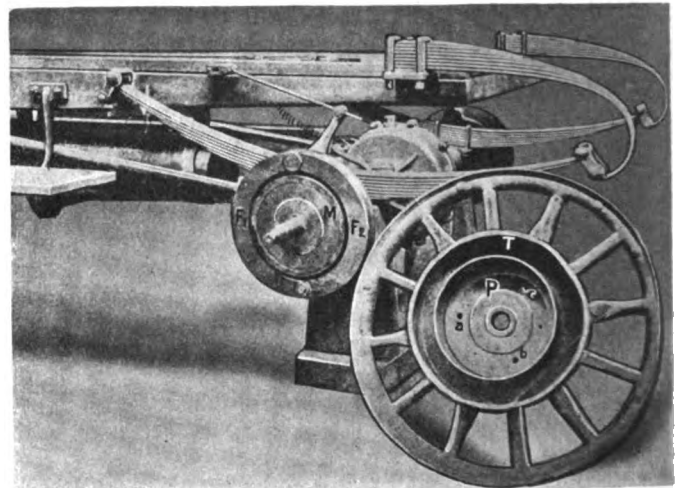

View of Rear Construction, with Wheel Removed.

electrically controlled car, like this one, the current furnished is the "whole thing." There are two magnetos, the ordinary one for ignition; the Nilmelior, driven from the crankshaft and located alongside the engine, opposite to the valves. For furnishing current to the magnets, another magneto is furnished. This is located upon an extension of the lower half of the gearbox, which extends from the side of the box to the main frame on the right side, forming a wide shelf.

This magneto is enclosed in a water-tight case and is belt-driven from the cardan shaft. It has been specially constructed, with special windings, to produce a current of perfect constancy, but limited amperage. At very high speeds the voltage increases slightly. This specially wound machine, it is claimed, has the advantage over accumulators for this particular work, of less weight, smaller loss of voltage, decreased danger of short circuits, and increased reliability. If desired, the cars may be had with accumulators, however.

The use of electro-magnets for speed changing is not new, having been tried by Panhard in 1898. This effort failed for the lack of a suitable source of current, but the present device, the result of much scientific research and exhaustive practical experiments, is believed to have overcome all former defects.

The disadvantages, which only years of use can bring out fully, are electrical complications, and the introduction of the magnetic clutch, not generally considered reliable.

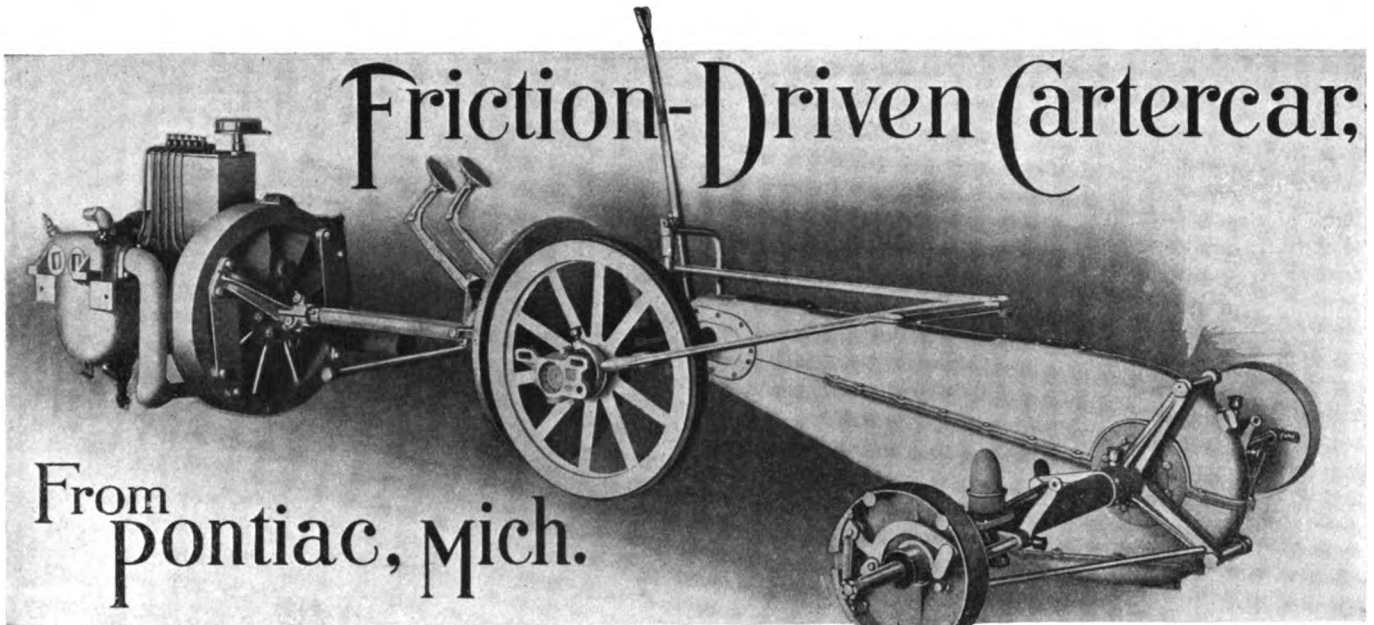

The Friction Drive and Enclosed Chain Make a Very Simple-Looking Outfit.

PONTIAC, MICH., April 26.—Which is preferable, three or four speeds? This question is one that is agitating numbers of manufacturers and users. It does not concern the makers of the friction-driven Cartercar, the Cartercar Company, of this city, for the user of this car may have either one or a combination of both, if desired. That is, the transmission to which this company has pinned its faith has an unlimited number of speed changes, one for every occasion. At the beginning, six years ago, the concern started with the idea of a friction drive. That it has been successful is borne out by the necessity for increased factory space. The present plant at Pontiac occupies five acres of floor space, totaling 218,000 square feet.

The production will be limited to two models, both embodying all of the newer improvements and all of the distinctive Cartercar features. These will be known as Models K and H. The former is continued from last season, while the latter is an addition to the line. Model K is equipped with a five-passenger touring body, and the motive power is the same two-cylinder opposed engine as has been used. It has a 5 1-2-inch bore and a shorter stroke of 4 1-8 inch. At a normal speed of 1,000 revolutions, the power developed is in excess of 22 horsepower.

Thermo-Siphon Cooling Featured.—The natural system of water circulation is used, without a pump or fan. With this system the water circulates more rapidly as it becomes hotter, and in the case of hill climbing or otherwise when the motor is working hard and running slow, more water is moved around.

The friction transmission is of very simple construction, with very few parts. It is, therefore, easy to care for and not expensive to maintain. Upon the prolongation of the crankshaft is mounted the aluminum disc, while against this a movable friction wheel with fiber facing presses. The latter is mounted upon a jackshaft and by sliding it along the various speeds are obtained. From this shaft, the final drive is by sprocket and chain to the rear axle. The chain is enclosed in a case of aluminum, which is said to be dust and oil-tight. Within this the chain runs in a bath of oil, which lubricates it thoroughly.

A series of experiments conducted by them with two cars running under parallel conditions for a distance of 6,000 miles resulted in a stretch of but 1-16 inch for the enclosed chain and in the shorter distance of 3,000 miles of 2 1-4 inch for the other chain, which was open and exposed.

One Speed Lever to Operate.—All of the speed changes are made by means of a single lever, located at the right of the operator in the usual position. This not only suffices for the forward speeds, but the reverse as well. In conjunction with this, the left-foot pedal moves the friction wheel into and out of engagement, like the clutch on an ordinary car.

One advantage which the makers of the car claim is that the transmission is practically fool-proof. In that it will stand endless abuse and hard driven with a minimum of repair expense, this is nearly true. The only part to wear is the fiber rim on the sliding wheel. This, it has been found, is good for 4,000 miles before replacement, which distance can be increased by careful driving. Replacement means little more than time necessary to do the work, as the fiber facing costs very little.

The wheelbase of Model K is 103 inches. The frame, which has a rise just above the rear axle for clearance, is of channel-section pressed steel, the dimensions being liberal. A dropped cross-member in front stiffens the construction there and acts as a cradle for the radiator. The other two cross stiffeners are located at the extreme rear and in the center, the latter carrying the transmission. The springs are of the now-generally accepted flat type. Both front and rears are semi-elliptic, and shackled at the rear end. The front axle is of the tubular form with large yokes and extra large steering knuckles. The cross connection is placed at the front of the axle.

Popular-Priced Model, Too.—In addition to the larger car just described, another of the roadster class will be brought out. This is Model H and will have a four-cylinder vertical motor of 4-inch bore and equal stroke. This motor is also rated at 22 horsepower. The cylinders are cast in pairs with the valves on one side. The car has a 100-inch wheelbase, 32 by 3-inch tires and a three-passenger runabout body. This may, however, be changed from a single rumble to a double rear seat or a baby tonneau, as desired.

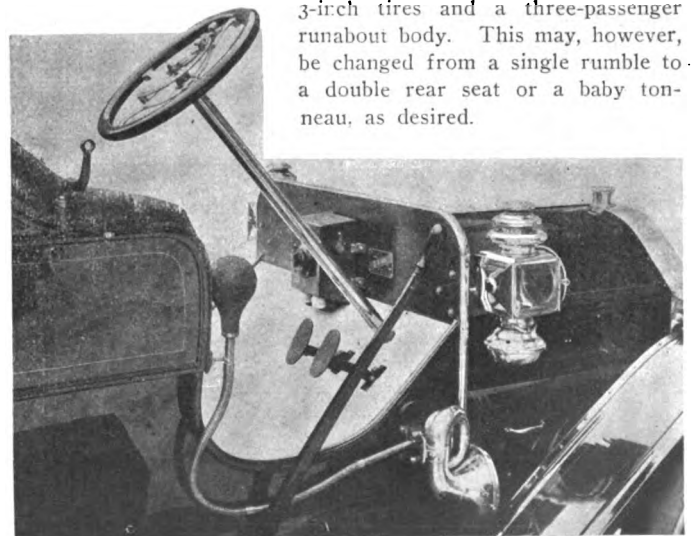

The Control Is Reduced to Foot Pedals and a Single Lever.

GASOLINE ENGINE CASTINGS A PROBLEM

VERY few of the owners or operators of automobiles, wrapped up as they are in their own operating troubles, stop to think of the troubles which the manufacturer has had previous to the final product. Chief among these sources of worry and friction is the matter of suitable castings, one particular branch,

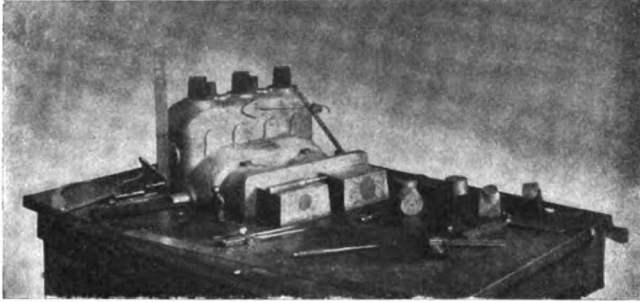

Aluminum Cylinder Pattern and Tools Used In Making.

cylinders, causing as much trouble as all of the others put together, if not more.

Granting the necessity for suitable castings, it becomes necessary to produce them, and all large users are alive to the difficulties incident thereto. For instance, there is the matter of the material, usually gray cast iron; then the process has much to do with the finished product and its composition. In processes, there are two in general use: first, the ordinary cupola method, and, second, the air furnace. The former is an approximate way, as the exact composition cannot be assured, nor can the physical properties be controlled within the close range necessary for regular and even work.

In the air furnace, on the other hand, the metal does not come in contact with the fuel nor with the air, as there is no forced draft. As both of these items must exert an influence on the product, it follows that their absence makes for a superior iron.

Another item which looms up large on the trouble horizon is the matter of proper patterns and coreboxes. The first, it might be explained, makes the depression in the sand corresponding to the exterior of the desired casting. The molten iron when poured in would fill this up solid if it were not for the pieces placed therein, and these are known as cores.

In the making of both patterns and core boxes, the greatest care must be exercised to have them fit together accurately, yet so as to go together and part with ease. This makes it easy for the moulder to handle them and results in better castings. Ordinarily patterns are made of wood, but in automobile work they are so expensive and used so much that it pays better to make them of metal. The metal employed varies just as the work to be done does. Thus, the cylinder pattern, which the moulder handles a great deal, lifting it from place to place, is made of

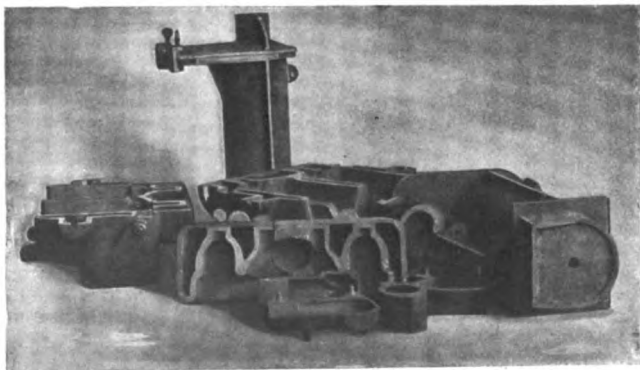

Core Boxes Are Made of Cast Iron—A Typical Set.

aluminum to make it light. The core boxes, on the other hand, generally go to the core room and remain there. They are not handled or moved around much, so are made of a cheaper but heavier metal, cast iron.

Aside from the proper tools to work with, as exemplified by patterns and core boxes, the greatest care must be exercised in the work, and only careful workmen should be employed. The mold should be clean cut, dry, and evenly rammed. The sand should be well tempered, there should be plenty of vent area, and a lot of good judgment should be used in gating the finished mold. The cope and drag, the two parts of the molding flask, should match accurately, with cores set and vented with care. Much depends upon these conditions in securing an accurate, solid, and uniform casting. The matters of the tempering of the sand, venting, placing of the cores, gates and accurate matching of the flask parts are "up to" the molder. If cheap help is employed, and these important parts of the work slighted, the results will be such as to show the cause plainly. Tempering the sand, which means no more than mixing the proper quantity of old and new, and keeping the whole properly wetted, is directly "up to" him, and if lazy or underpaid, he will shirk it. If this is slighted the castings will show it.

The form and material of the flask also enter. Old wooden flasks cannot hold their shape and, consequently, the sand, as well as a more rigid flask, say, of iron. In the course of time

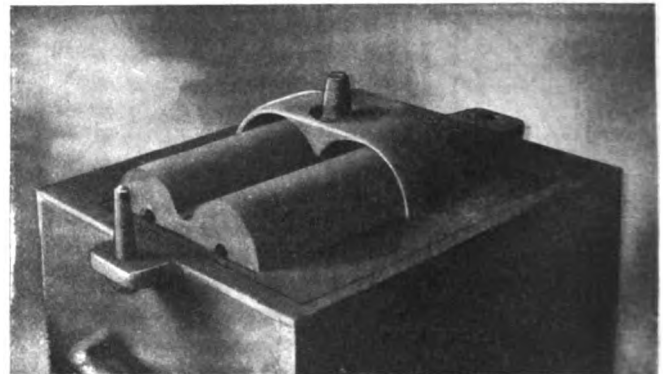

Half of Cylinder Mold, Showing Cores In Place.

nails and screws, set into the wooden sides, loosen up and allow lots of play or wobble. In matching up the cope and the drag, which must be as near exact as the foundryman ever works, this factor enters, as with the wooden form, the male and female points do not meet exactly on account of the wobble.

With iron, on the other hand, these cannot loosen, and the fit, if there is any, is exact. This sounds like a simple argument, but anyone who has ever seen the castings resulting from the former case will at once see the force of it. Half of the casting is in one plane and the other half is in another, due to the twisting which the loose pins allowed.

The matter of large prints for the main cores is one that is worthy of mention. With a small core print the long core of large diameter is able to be moved by the inflowing metal. If the mold is so gated that the iron flows to the two main cores of a casting with cylinders in pairs, from opposite directions, this will result in making the axes of the core spaces approach one another at the top. Then in machining the casting, the roughing cut will run out near the top of both cylinders, and after much work has been expended upon it the discovery is made that the casting is useless or a "waster."

The illustrations on this page which bring out clearly the points mentioned, were supplied by the Ferro Machine & Foundry Company, Cleveland.



Alone with Nature in the Northern Island.

EVEN in far-off New Zealand, a country whose interior is little known, and is as primeval as any part of the world in these days of exploration, where roads are such in name rather than in fact, leading between towns with unpronounceable names and whose inhabitants use a language equally beyond the understanding of most white travelers, automobiling is possible, but fraught with difficulties.

Having heard a great deal about the beauty of the wildness of the northern island, the engineering feats in railroad construction visible from the so-called roads, and of the general interest in the country through which the automobilist must pass, we decided to risk a trip from Wellington to Auckland, a distance of about 500 miles, paralleling the railroad on what is known as the Main Trunk route. The country scenery became fascinating as soon as it was entered and to Marton, 100 miles, we ran through old and well-settled country over fairly good roads. At Marton we entered the first stretch of our long run of 300 miles to the North through the practically unknown King Country. The conditions of the rough and bumpy roads, the logs and stumps all around and other unmistakable signs made it evident that we were entering country that only a few years ago was virgin bush.

Above Hunterville, we got the first glimpse of the Makohine Viaduct, and soon the huge structure burst into view. It is a grand sight. We descended into the Gorge and looked up at its great height—a Leviathan built to carry trains across the great rent in the earth, dive into the tunnel and disappear out of sight. While standing there we heard the shriek of an engine, a train rushed out of one solid wall of rock, with a roar crossed the slender structure and entered another one. We climbed out of the gorge and continued through Ohingaiti and Mangaweka, mushroom townships that sprang up in a night, the even purr of the engine spelling sweet music to our ears, till presently the road became rapidly worse. We passed through Utiku, where the sounds of many sawmills—New Zealand at work—greeted us. Each of these had contributed, with heavily loaded wagons, to

The writer of this story has spent practically all his life in New Zealand, knows the country blindfold, and will be pleased to supply any of our readers contemplating a trip through that country with any information or assistance in his power. Letters should be addressed to "Antipodes," care Editor this paper.

cutting up the roads until it was nothing but a series of bumps. For a little while we were stopped by a team of working bullocks, whose ponderous movements reminded us of the middle ages. Holes, bumps and new stone for the next six miles, in to Taihape township, made the roads so bad that we took to the footpath, risking a summons rather than taking back to the road, even in the town.

Taihape seems a prosperous, business-like little town; whether it will continue so when the line is completed, with so much broken country around it, is another tale. There are several good hotels, nice-looking shops with plate-glass windows, and we had a fine lunch at the "Gretna." Here, also, we took on two cases of gasoline to see us through to the Auckland section and started off about two o'clock. The road wound round mostly a steady up-grade, with a creek or gully on one side and banks on the other, and our tires

had to grind through loose rocks. We inspected them twice, but the good old Palmers on the back wheels were standing up to the ordeal like Britons. This stretch lasted for about 11 miles, and then the road lay through open, rolling country, where we made better going, though we could tell by the heavy pull of the engine that we were steadily rising as we neared Mt. Ruapehu. When we reached Taurangarere, we joined the railroad again, and at the highest point on the line (over 2,000 feet), ran through a dusty pumice soil onto the plains and along the right of the railway line, till we struck the Waiouru Accommodation House.

After the varied and broken scenery of Mangaweka and Taihape, with the Papa cliffs of the Rangitikei River rising sheer six or seven hundred feet from the river bed, with pretty bits of bush here and there, the tussock and pumice plains we had entered were deadly monotonous, so we decided to push straight on, and, after an easy run of about eight miles all down hill, reached the Wangaehu River at a fairly wide ford. I came back on to the low speed and sent her at it. It proved to be fairly deep water, surging well over the platform and round the bonnet and the current was pretty strong, but she took it like a duck. We were soon at Kerioi, and by our gas lamps the accommodation house was soon detected. We inquired the way and found that there were two creeks unbridged still to cross between us and Ohakune, and as one was two feet deep and the other not far off that depth, we decided to stop for the night.

In the morning we had reeled off a couple of miles when we came to the first creek. The ford was narrow and deep, with a treacherous looking soft shingle bank in the shallowest part, so we took the deeper. I did not disconnect the exhaust pipe at the engine, and when in the center the exhaust pipe got below the water and the engine was smothered. It was a case then of winding her out by hand. The second creek caused us no trouble for we found but 18 inches of water. From Ohakune we made a deviation to Raetihi, where we had lunch. From Raetihi to Pipiriki, 17 miles, the going was deadly rough and we had to proceed at a crawl. The road descends about 600 feet to the latter place, on the Wanganui River, and when about six miles

away the road became better. En route we passed along the famous "dress-circle," where the road winds around the Papa cliff in a semicircle. We were the first autoists ever in Pipiriki, and the Maori people were greatly interested in the car, surrounding it and looking under it to see the "horse." We returned to Raetihi that evening with our gas lights doing good work.

On the following morning we filled up and got under way for the main trunk line again, striking it seven miles above the point we had left two days previous. A couple of miles further brought us to another great engineering feat, the Makotote Viaduct, which was just as impressive in appearance as the other high bridge, and leaving it we again entered the bush country, soon finding ourselves at the top of the spiral where the railroad runs five miles to gain one in actual progress. We stopped long enough to take a beautiful panorama of the impressive scene, with the sinking sun dyeing the hills a deep red. The

descent to Raurimu was easy, and about 15 miles further on we struck the head waters of the Wanganui River, running along it to Taumaranui, the terminus of the world's scenic route, "Wanganui to Auckland

via Wanganui River, the Rhine of New Zealand." It is, in fact, all that is claimed for it.

Here we learned that we could go 14 miles past Taumaranui to a section of three miles over the Poro-a-tareo tunnel, where there was only a horse track. So the car had to be hauled from Taumaranui to Te Kuiti. We spent Sunday morning overhauling the car and in the afternoon went out on the Wanganui River in a Maori canoe and enjoyed a swim. We reached Te Kuiti at 10:30 Monday morning, and in ten minutes we had shoved up a couple of planks and driven off the truck, cheered by the Maoris, who watched the unloading of the first automobile from the South. After inquiring the way, we started off to visit the Waitom caves, arriving there for lunch. In the New Raukuri cave, a huge cavern, we were led from gallery to gallery, examining the stalactites and stalagmites, taken through low-vaulted tunnels where the sound of rushing water became louder and louder until when the sound was well-nigh deafening, we realized that we were standing upon the brink of a precipice where the tunnel ended abruptly, and somewhere below us a torrent was dashing along in inky darkness. The thought of the danger and the wonder of it made us glad to turn around.

After a tramp back a mile and a half, armed with a lantern, we visited the Waitom caves, which proved a veritable fairyland, culminating in a wonderful grotto, with a pool of still but fresh water, and on looking up, we thought we had been transported into the heavens dotted with myriads of stars. Closer inspection revealed the presence of hundreds of glow worms upon the ceiling, giving forth in the darkness a beautiful, weird, soft and spectral light.

The next morning we got away for Hamilton, and after a run of about 60 miles, arrived there for lunch, finding preparations being made for a visit from the Premier, Sir Joseph

Ward, and we were able to have an interview with him in the interests of automobilists, for he is one himself, in reference to the completion of a road over the Poro-a-tareo tunnel. When this bit of road is completed, or even as it is, I can recommend the Main Trunk route from Wellington to Auckland and vice versa as being one of the finest drives in the Dominion.

The ideal round trip leaving from Auckland would be to take the car on the boat to Coromandel, then via Thames, Paeroa, Waihi, Tauranga, Rotorua, Taupo, Napier and Wairarapa over the Rimutakas to Wellington, returning via Paikakariki, Palmerston, North Marton, Hunterville, Taihape and the Main Trunk to Hamilton, and on through Ngaruawhia to Auckland and vice versa for Wellington. By this route not a single inch of the ground would be duplicated, and some of the finest scenery in the colony would be traversed, including that little known but magnificent drive of 40 miles round the seacoast from Coromandel to the Thames, on the downward trip, and on the return, the lovely trip through the Main Trunk.

In looking back over the trip, it certainly can be recommended as one of the scenic ones of the world, especially interesting to those who have never visited New Zealand, or who have visited only the coast and do not realize that the beauties of the interior are without parallel. One feature of the trip that was a surprise to me was the number of tourists met en route, all traveling in coaches, boats or railroad trains, however, for we were the first to appear in an automobile. Our independence of time

tables and of the dust and soot of the railroads, of the hot sun and dust of the coaches and the slow movement of the boats made us envied by the other less fortunate fellow-voyagers.

While wait-

ing for tea at Waiouru, the coaches from Pipiriki and Tokaanu arrived, one from the Wanganui river, 45 miles, and one from Lake Taupo. The passengers looked as if they had passed through a dust storm, and watched us start away in the cool of the evening for Ohakune. Another time we met a party, when quick action was necessary to prevent an accident. We had been running along at a good clip, when, on rounding a curve, we commenced the descent into the Sulphur Stream Gorge and came upon four coaches carrying His Majesty's mails, and all loaded with passengers doing the overland trip from Auckland to Wellington, via the Main Trunk. Down went our brakes, in went the reverse, and before the leaders had time to well realize what had startled them we had backed around the corner out of sight.

Mountains, volcanos, plains, plateaus, gorges, and, in fact, almost every kind of topography is seen in this trip. One of the most startling evidences of this was seen after leaving the Makotote Viaduct, and striking into the Waimarino plains, the road quickly changed from a good hard blue-stone to a sort of pumice twelve inches deep in dust. For ten miles, until we reached Raurimu, we re-entered the bush, the going was anything but pleasant. On the Maimarino plateau we caught a fine view of Ruapehu, Tongoriro and the active volcano, Ngarahoe.



Giving the Motor a Drink.



Maori Natives Manifested Great Interest in the Car.

LOWELL SECURES THE NATIONAL STOCK CAR ROAD RACES

LOWELL, MASS., will have the national stock car races, over the Merrimac Valley course, September 6 and 7, thus completing with the Wilkes-Barre hill climb and the Glidden tour the trio of national A. A. A. contests. With the light car event as the opener these speed tests will be the features of a week of automobile festivities planned by the Lowell Automobile Club and the people of that city. Both road races will be run under the classifications of the Manufacturers' Contest Association, and, of course, the sanction of the A. A. A., the latter organization having given the necessary permission to schedule the contests as of national interest and consequence.

At present the course over which the successful stock car competition was held last year is 10.6 miles long, but if sufficient entries are received for the coming one this can be increased to 15 miles. The plans for holding national races have all been made, and were well formulated before the A. A. A. was asked to make the meet of national importance. The entire system of roads to be utilized is such that it is in a natural amphitheater, with only two crossroads, both of which will be bridged. It is not more than half a mile from the main stretch of the route to the backstretch, and, although presenting difficulties for the drivers, it is not considered a dangerous course as circuitous courses go, and should prove very fast.

A \$5,000 trophy has been guaranteed for the stock chassis race, and it will be for annual competition as the A. A. A. stock chassis trophy. A proportionately suitable prize will be given to the winner of the light car contest. The official permission to hold the meet was given by the executive committee of the A. A. A., subject to a satisfactory arrangement being made between the Lowell club and the Contest Board. The request of the Massachusetts body was presented by its president, J. O.

Heinze, through the advisory committee of the M. C. A., and it is expected that the final agreements will be completed in a few days and official approval become a matter of fact.

Lowell's Mayor Calls Upon Citizens.

LOWELL, April 26.—The city officials and merchants of Lowell are becoming enthusiastic over automobile week in the Fall, and there is an assured prospect that sufficient money will be subscribed so that the series of automobile races and motor boat events can be carried out as proposed. Mayor George H. Brown is much interested in the plan for an automobile carnival and has issued an open letter to the citizens, asking their co-operation with the automobile club and the merchants in making the automobile week a success. His letter in part is as follows:

"The Lowell Automobile Club is planning to give this city the largest automobile carnival in the history of the country, and it is the duty of every citizen of every walk of life to realize the importance of this event, and to co-operate with the public-spirited men who are working to make it a complete success.

"While no official step has been taken on the part of the city to forward the arrangements of the carnival, I believe that the proposed week of events will be of two-fold importance to us, the advertisement which the city will receive throughout the country, and the financial benefits which will come to our business men and tradespeople; therefore I take this opportunity of calling upon the people of our city to give their moral and financial support to this project. Manufacturers are planning to have big exhibits here, and if this locality appeals to them it may be expected that they will ultimately open branch houses in Lowell.

"Of the sum of \$10,000 which must be raised by the Lowell Automobile Club to insure the carnival of its financial success at the start, approximately \$8,000 has been promised. I ask all our citizens who are interested to help swell the fund by their contributions. I trust that in every possible way our business men will co-operate with the club in this project."

INDIANAPOLIS SPEEDWAY RAPIDLY ASSUMING FORM

INDIANAPOLIS, April 26.—Progress in the construction work on the Indianapolis Motor Speedway, embodying several new features, is the subject of most general interest at present. The great race course is rapidly assuming its permanent shape, and much of the work on it has been completed.

It has been decided that asphaltum oil will be used in surfacing the track, to eliminate dust, and the five miles will necessitate the spreading of 235,000 gallons. The whole will be thoroughly worked in, rolled, levelled, and packed so that the gravel will not tear up. This is especially the case on the curves, which are 60 feet wide, and will be banked to a degree of 20 per cent. Unlimited speed may be attained upon the straightaways, and 112 miles an hour on the turns.

Should any car leave the course on a curve it will not turn turtle on the outside, dropping down to the level of the straightaway, for there will be a levelled and inclined space between the top of the curve and the boundary line for spectators, so that the driver will be able to straighten up before an accident occurs.

The immensity of the undertaking can be realized from the fact that there are five steam tractors, 300 mules, 150 scrapers, and four six-ton and three ten-ton rollers, now in use. It will require a carload of white paint to cover the four miles of outside and two and a quarter miles of inside fence. Through these there will be six entrances to the grounds, so arranged that any part of the course and the several stands for spectators may be easily reached.

There will be separate garages for each of the racing cars, and an 80-foot flag pole, the idea being that as long as a car is in a race its flag will remain hoisted, but if it drops out, the flag will be lowered. Different colors will be used. In addition

to the main grand-stand there will be 20 individual stands to hold 40 persons each. A double-decked press stand has been built, and arrangements are being made for constructing a dark room for photographers. There will be eight special fouling and judging stands, so that the contestants will be under constant surveillance. Gasoline and oil houses, and water tanks, are being built.

Interest in the national championship balloon race of the Aero Club of America, which will start from the speedway grounds, June 5, has grown as the result of the efforts of the Aero Club of Indiana. Within two weeks amateur balloonists from three cities will arrive to complete the number of ascensions necessary to become registered pilots. Nine entries have been received, representing clubs of St. Louis, Chicago, Indianapolis, Buffalo, Boston, and New York. The gas mains from the city to the grounds, a distance of four miles, have been laid, and everything is in readiness for trial trips.

"BLUE BOOK" PATHFINDER AGAIN BUSY.

The "Official Automobile Blue Book" pathfinding car, which last year covered over 30,000 miles, started last Tuesday from New York for Ohio and Indiana to complete the work for Section 4 of the "Blue Book," which the publishers intend to be a complete guide to the Middle West States. The car will later on be joined by Robert Bruce, editor of the "Blue Book," who has been in Chicago for some time laying out routes.

The first German school of aviation has been formed under the auspices of the Bavarian Automobile Club.

BROOKLANDS HAS NOTABLE REOPENING

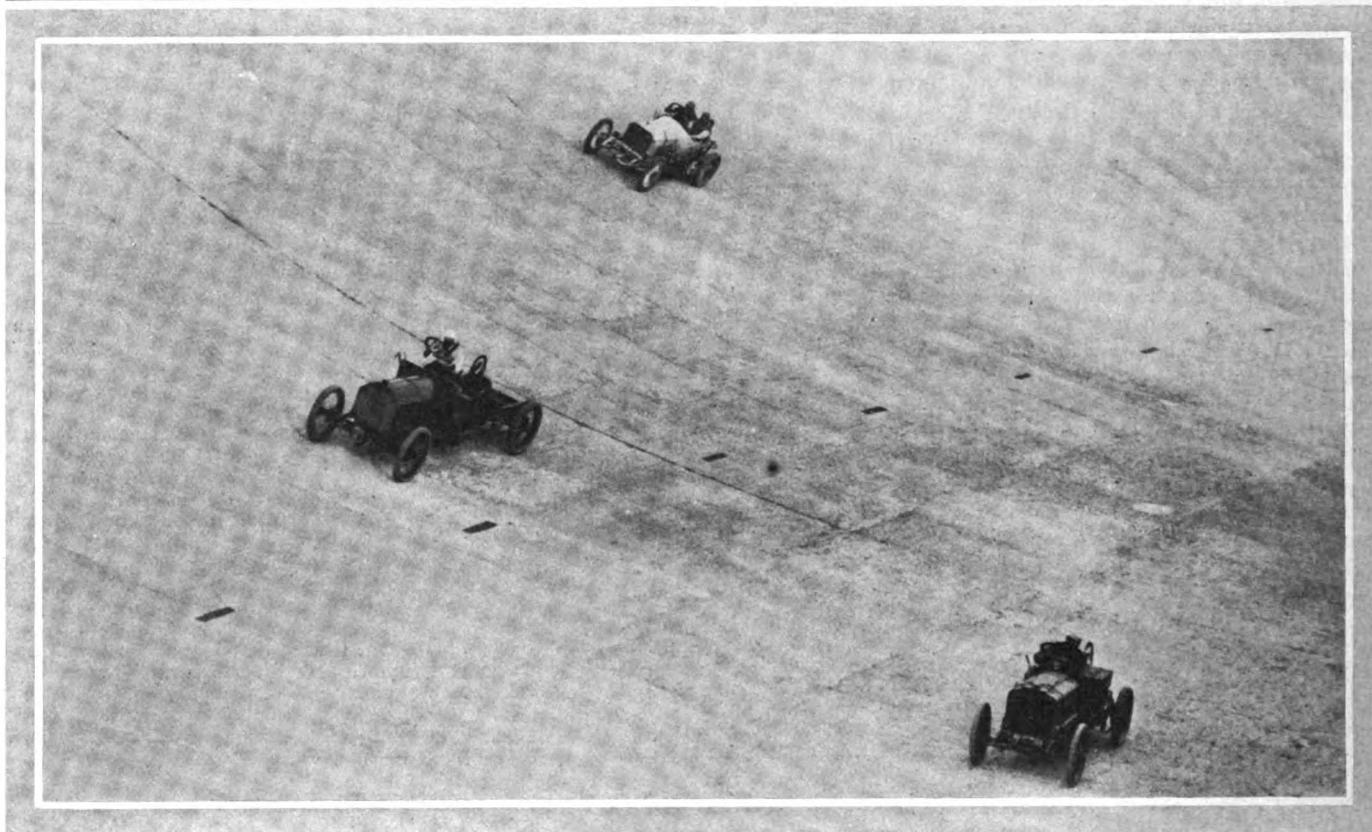

Winning Mercedes Passing the Fiat and Brasier Cars at the Rate of 100 Miles Per Hour.

LONDON, April 22.—Accompanied by magnificent weather and with a large and enthusiastic audience in attendance, the Spring opening at Brooklands was held on Easter Saturday and Monday, the program being pronounced one of the most successful ever held since the track was inaugurated. The entries were good and the programs run off without hitch on both days.

Saturday had five events and an "extra," the latter being a time trial on the recently constructed test hill by an 18-horsepower Straker-Squire, the best time averaging 18 1-4 miles an hour from a standing start.

The first event, the Easter Junior handicap, for cars up to 25 horsepower, was won by an 18-horsepower Straker-Squire driven by L. R. Squire, who took the lead at the start and held it throughout the three miles of the race, his average being 59 3-4 miles an hour.

The Weybridge cup for cars of 37 horsepower or under for the same distance was won by H. G. Nalder in a 35.7-horsepower Berliet, at an average speed of 62 miles an hour.

The chief event of the day was the Senior handicap for cars of 25 horsepower and over, the distance being 5 3-4 miles. The winner was A. W. Tate, on a 59.6-horsepower Mercedes, who started from scratch and gradually overhauled the field, winning by a small margin. The average speed was 87 miles an hour. This was the only event for private competitors during the day. In addition, there were two motorcycle events at five miles, the winners being H. H. Bowen and W. H. Bashall, both riding 3 1-2-horsepower Triumph machines.

Easter Monday's program was more attractive than that of Saturday. The attendance was somewhat larger by reason of the holiday, and in spite of a strong cold wind which arose.

Showers in the morning had wet the track, and there were some exciting skids as a result, especially at the turns. Fortunately no one was injured, although a motorcyclist was thrown as a result of a seized motor.

The first event was for the Sizaire et Naudin Cup for cars of that make having a single cylinder motor of 120 mm. bore and 130 mm. stroke, the course being down the finishing straight, a distance of about a half mile. The result was a tie between W. H. Milburn and R. H. Hart, the former appearing to slow down so as to make a dead heat of the race. Later on the tie was run off and Hart won, Milburn being left at the starting line. The winner's speed was 36 1-2 miles an hour.

The Easter Senior handicap was the next event, it being for cars of 25 horsepower and over, the distance 5 3-4 miles. A. W. Tate, on a 59.6-horsepower Mercedes was the winner, although Baker White on a 60-horsepower Napier held the lead for over 5 miles, but was finally passed by both Tate, and J. W. Stocks on a 25.6-horsepower de Dion. Tate's time averaged 88 miles an hour. It was during this event that considerable skidding took place and several collisions were narrowly averted.

The Open Four-Inch race for 5 3-4 miles and for cars under the "Four-Inch" classification, was won by a de Dion, driven by W. V. Jolley, at an average speed of 68 1-2 miles an hour, the winner having about 50 yards to spare.

The final event was an obstacle race, in which the contestants had to keep within parallel lines about 25 yards apart and dodge a series of dummies, which were worked across the course, without leaving the lines. B. S. Millard on a 8.9-horsepower Sizaire won without touching a figure, his time being 34 seconds for the 100 yards of the course. The next competitor, A. R. V. Garnett on an 18.7-horsepower Straker-Squire took 32 2-5 sec.

STURMEY ON THE KNIGHT ENGINE TEST.

Henry Sturmeý, one of the well-known British automobile authorities, in his comment printed in *Motor* gives expression to this opinion concerning the Knight engine:

I confess to a considerable feeling of satisfaction that the Daimler Company have at last carried out so searching an official test of the new Knight engine and with signal success, because I believe, while I was the first in this country to turn the Knight engine down by mental reckoning—which I did three years ago on seeing the drawings in an American paper—I was the first over here, I think, to accept it as a practical design (after seeing and trying it and hearing Mr. Knight's explanation on points I raised). I am saying nothing in this paragraph as to whether it is better, or more

efficient, or more silent than the usual type of engine, but what I am saying is that the test has shown that those who have refused to accept the unofficial evidence presented to them and who stated, with more or less vehemence, that the sleeves could not be lubricated; that there would be excessive wear, and that, for practical commercial purposes, it "could not work," have been shown to be wrong.

Mr. Sturmeý's opinion is that of a majority of British automobile authorities who were also skeptical concerning the Knight engine, and held similar views regarding the wear and lubrication. The results of the bench and 2,000 miles test at Brooklands have demonstrated to all that the engine is a commercial success and not an experiment.

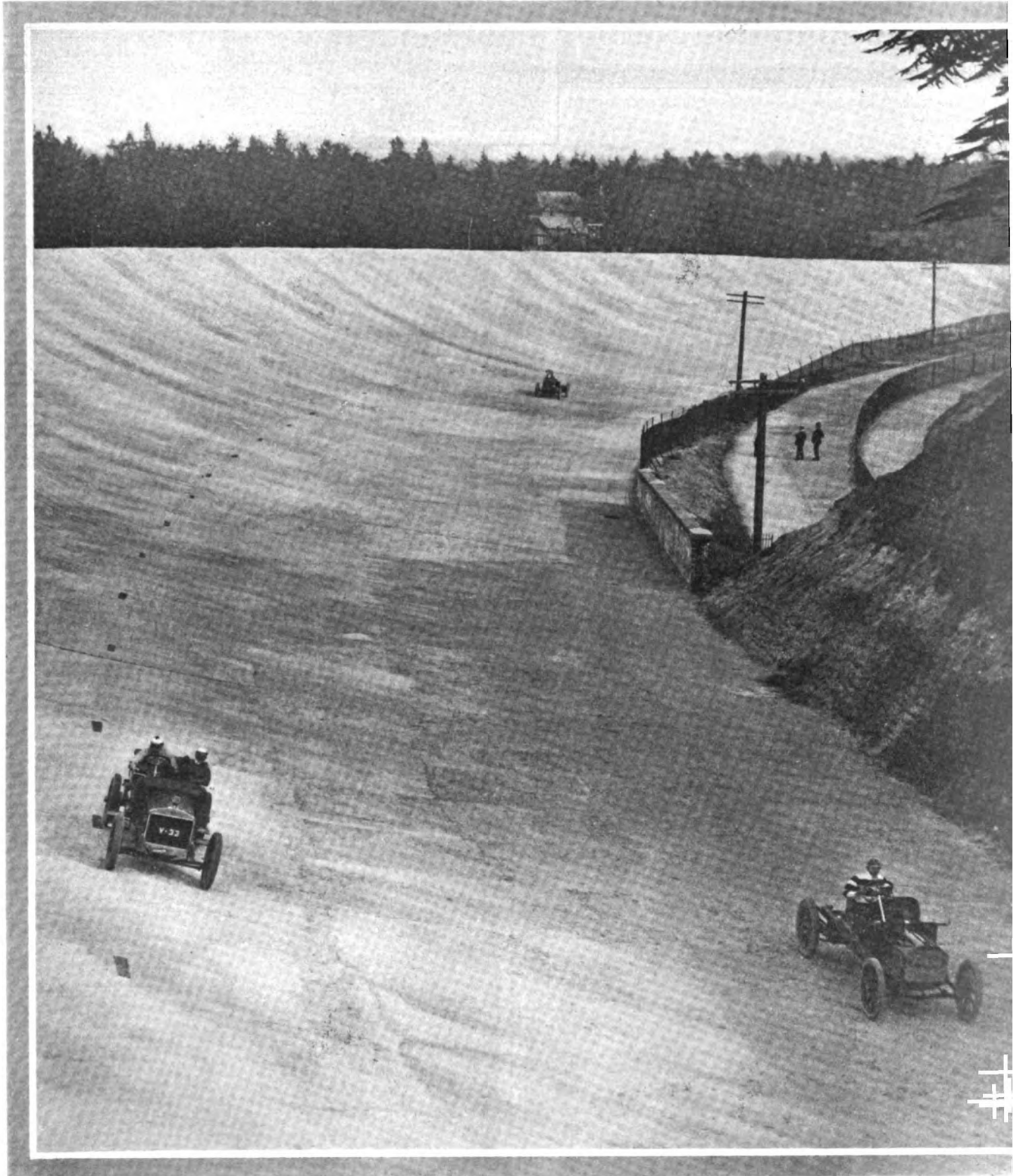

Three Cars Taking the Explosive Bend in the Easter Handicap at Brooklands Track.

West will supply
 AAA Tour
 with
 Varied Roads



1 — Spring Roads in the West.
 2 — Leaving Watertown, Wis.
 3 — A Stop at Fort Sheridan.
 4 — Just plowing through mud.
 5 — Lewis really enjoys pathfinding.
 6 — Near Paraboo, Wis.
 7 — Horses not yet well acquainted.
 8 — What Lewis read at Zion City.



ROADS WILL BE BETTER FOR A. A. A. TOUR.

While the first three days of the A. A. A. tour, from Detroit to Madison, Wis., the travel through an unpicturesque country, the scenery becomes fine after leaving Madison. In some respects, according in "Pathfinder" Lewis, it surpasses the scenery enjoyed on the Eastern tour. The pathfinding trip this year was begun two weeks earlier than usual, and the dirt roads that will be excellent in Summer are now long stretches of mire. Lewis says he has had more severe experiences than ever before, but that the route he is laying out will afford a more enjoyable contest and a better one in a sporting sense than in previous years. At times the roads have seemed impracticable, but he is sticking to it, and having a light car with 30 horsepower (an E-M-F.), he has not been stalled, but has progressed steadily, though slowly.

It has been the object of the A. A. A. Contest Board to make the tour this year of greater interest to the automobile users in general by making it of more value as an object lesson. This is to be done, not by making the contest more difficult, but by having the rules more exacting. The performances of the cars will be set forth with fuller detail, because of the improved rules, and motorists everywhere will get a better line on the possibilities of touring on schedule. There will be fractional points of penalization incurred for things not before penalized, and while the contest is certain to be close, it is expected in this way to evolve an individual winner for each trophy, without any car being discredited because of minor adjustments that are ordinarily experienced by everyone.

The interest being manifested by manufacturers indicates that the entries this year will outnumber those of last year. Already a number of paid up entries are in hand, something which never before has been the case so far in advance of the tour. The entries this year close June 15, with \$100 deducted from the fee of those who enter before May 15.

INDIANA REPRESENTATIVES IN A. A. A. TOUR.

INDIANAPOLIS, IND., April 5.—This State will have its usual quota in the annual tour for the Glidden Trophy during the coming summer, with perhaps additions to the number which have competed in the past. Webb Jay has announced his intention of driving a Premier, the first time that he has ever been at the wheel of a gasoline car in a big contest, and the first time he has been on the tour since 1906. George A. Weidely will be at the wheel of another Premier, and probably Ray MacNamara will handle the third.

It is understood that the Haynes will have its two representatives, with Frank Nutt in charge of one and Loring Wagoner, the other. At least one Marmon will be on hand under the guidance of Frank E. Wing, of Boston, who made perfect scores in both the 1906 and 1908 tours. Just what the Overland and National factories will do is not known, but it is thought that they will have cars in the run; the National may have a full team and the Overland both touring cars and runabouts. The Apperson has not been seen in tours for two years, but as it has been in numerous contests lately, especially hill climbs, there is a rumor that it will also be in the annual trek.

MARYLAND CLUB TO HAVE SEALED BONNET.

BALTIMORE, April 27.—A sealed bonnet endurance contest will be held May 15, under the auspices of the Automobile Club of Maryland, the route selected being from Baltimore to Frederick, then to Gettysburg, and back to this city. The cars will be placed in a garage upon return to Baltimore, and a committee of experts will make an examination. The slightest defect will entail a penalty. The cars will be divided into four classes: Touring cars up to 30-horsepower; touring cars above 30-horsepower; roadsters, and tourabouts under 30-horsepower, and roadsters and tourabouts above 30-horsepower. The running schedule calls for a finish within seven or eight hours.

REEVES VISITS INDIANAPOLIS SPEEDWAY.

That the completing of the new two-and-one-half-mile automobile track at Indianapolis marks an epoch in motoring, is the statement made by Alfred Reeves, general manager of the American Motor Car Manufacturers' Association, who recently visited the new speedway. The visit was made at the invitation of the officers of the new Motor Speedway, which includes Carl G. Fisher, A. C. Newby, F. H. Wheeler, and J. A. Allison. In the party were H. O. Smith (Premier Motor Mfg. Company), Benjamin Briscoe (Maxwell-Briscoe Motor Company), S. H. Mora (Mora Motor Car Company), R. E. Olds (Reo Motor Car Company) and W. H. Van der Voort (Moline Automobile Company), all members of the American Motor Car Manufacturers' Association. The visitors are enthusiastic supporters of the new plan which, they state, will result in the Middle West having the fastest course in the world, for the new track will permit of a speed of 100 miles an hour just as long as a car can stand it.

"One cannot appreciate the importance of the undertaking unless they have paid a visit to the new oval," said Mr. Reeves, Monday. "An army of more than 400 men living in camps on the grounds are literally 'making the dirt fly.' The contractors must finish their work by June 25, and the first race will be held July 15. The new course is beautifully laid out and will supply an ideal enclosure for aeronautical and motor sports. The piece of ground is more than one mile long and little over one-half mile wide, the entire undertaking involving an expense of a little more than \$300,000."

THOMAS PATHFINDER REACHES IDAHO.

Automobiling touring in the Spring in Wyoming is particularly strenuous work, according to the reports sent East by the party which is mapping out the route for the New York to Seattle endurance contest. For sixteen days the Thomas car has been battling with snow, mud, and water in crossing the State of Wyoming, with short runs, at the start in Colorado, and now in Idaho where the roads are slightly better. On Wednesday of last week the car was dug out from a mudhole near Bitter Creek by a railroad section gang of fifteen men and then placed on a corduroy road specially built for it. Thursday was spent in making a snail-like progress, and Green River was reached Friday afternoon, after having spent five days in the 130 miles separating it from Rawlins.

Better progress was made Saturday, 88 miles being covered to Kemmerer, although a number of washouts had to be filled, and the crew felt that perhaps there was really hope of their reaching Seattle. Sunday evening no report was received of the whereabouts of the big car, but Monday evening it pulled into Montpelier, Idaho. Sunday night was spent with a camp of shepherders out on the plains, with the temperature at zero. Pocatello was reached Tuesday. The roads did not improve as much as the crew had expected, on account of more snow, but with pilots, the party is getting slowly along.

The Manufacturers' Contest Association, by a mail vote, decided not to reopen the matter of the contest.

DETROIT GAINS MORE PLANTS.

DETROIT, April 26.—Another is to be added to the long string of automobile plants located here. A company is being organized to enter the light car, low priced field, and it is expected that the new model, which for the present will be an assembled car, will be placed on the market by June 15.

Recognizing the advantageous position Detroit occupies for makers of parts, the Buffalo Carbureter Company will locate in Detroit, the plant at Buffalo being dismantled and the machinery shipped here as rapidly as possible. A temporary location has been secured, pending the erection of a plant, and operations will be commenced with about one hundred hands. William F. White, president, and Robert A. Huessler, treasurer, will also make Detroit their home.



Vol. XX. Thursday, April 29, 1909 No. 17

THE CLASS JOURNAL COMPANY

H. M. SWETLAND, President
231-241 West 39th Street, New York City

EDITORIAL DEPARTMENT

A. G. BATCHELDER, Managing Editor
R. F. KELSEY, Associate Editor
THOS. J. FAY MORRIS A. HALL W. McKEAN WHITE
W. F. BRADLEY, Foreign Representative

BUSINESS DEPARTMENT

A. B. SWETLAND, Business Manager
LOUIS R. SMITH FRANK B. BARNETT
W. I. RALPH, 1035 Old South Building, Boston, Mass.
C. H. GURNETT,
F. W. VAN SICKLEN, 1200 Michigan Ave., Chicago, Ill.
H. H. GILL, Detroit, Mich.
T. B. VAN ALSTYNE, Philadelphia, Pa.

Cable Address - Autoland, New York
Long Distance Telephone - 2046 Bryant, New York

SUBSCRIPTION RATES:

United States and Mexico - One Year, \$3.00
Other Countries in Postal Union, including Canada - One Year, 5.00
To Subscribers—Do not send money by ordinary mail. Remit by Draft,
Post-Office or Express Money Order, or Register your letter.

FOREIGN SUBSCRIPTION AGENTS:

ENGLAND:—W. H. Smith & Sons, Ltd., 186 Strand, London, W. C., and all book-
stalls and agencies in Great Britain; also in Paris at 248 Rue de Rivoli.
FRANCE:—L. Baudry de Saunier, offices of "Omnia," 20 Rue Duret, Avenue
de la Grande Armee, Paris.
GERMANY:—A. Seydel, Mohrenstrasse 9, Berlin.

Entered at New York, N. Y., as second-class matter.
The Automobile is a consolidation of The Automobile (monthly) and the Motor
Review (weekly), May, 1902, Dealer and Repairman (monthly), October, 1903,
and the Automobile Magazine (monthly), July, 1907.

THE TRAIL OF THE ROAD-HOG.

Connecticut has one of the best systems of public roads
in this country. Connecticut was the first State to abol-
ish the arbitrary speed limit and adopt an automobile
law based on equity and common sense. And although a
very large part of the automobile travel on Connecticut's
roads is by non-residents, these are nevertheless granted
complete reciprocity. In every way Connecticut has en-
deavored to treat automobilists fairly, even liberally.
What has been her reward may be best understood from
the circular letter herewith, signed by the selectmen of
the town of Berlin, which sees many passing autoists.

The selectmen of Berlin seem to be of a reasonable
and peace-loving mind; there is no bombast, no hys-
terics, no suggestion of shot-guns or dynamite. Their
letter is an appeal for justice, and it should be granted.

Unfortunately the comparatively few automobilists
who are the cause of this complaint are not likely to be
moved by any such consideration. It is Connecticut's
misfortune, like New Jersey, to lie on the main route
between two great cities. Much of the automobile
travel on her roads is by through-trippers, whose only
concern is to lose as little time as possible on the way.
This class is the most dangerous, as it is largely made up
of more or less reckless chauffeurs driving high-powered
cars; and it is also the least amenable to reason. The
local automobilist, who is acquainted with his neighbors

for many miles around, must behave circumspectly in
order to retain their friendship. The leisurely tourist—
may his numbers increase!—wishes to see the country
and make the most of a health-giving pastime. It is for
the most part "through-trippers" and "record fiends"
that make up the tribe of the "road-hog."

These considerations may soothe our self-respect, but
they do not help Connecticut. The law-abiding class of
automobilists must take this matter into their own hands;
it may soon be a case of self-preservation. There is too
much fellow feeling among automobilists; most of them
seem to have the schoolboy spirit of protecting a com-
rade who has broken a rule. Every right-minded and con-
scientious driver should make it a point to report "road-
hogs," and to see that his club takes vigorous action.

W. H. Gibney, Chairman, Meetings
N. W. Baldwin, 1st Day of Each Month.
E. W. Dyer.
Selectmen's Office
Town of Berlin
Berlin, Conn., April 12, 1909.
Dear Sir:—
The taxpayers of the Town of Berlin in the last
few years have expended large amounts of money
to improve our highways. We desire that the en-
tire public shall have the benefit of these im-
proved highways. Some automobilists, however,
are using these highways at a speed which trans-
gresses the law and jeopardizes the life and prop-
erty of our citizens. We believe the majority of
automobilists appreciate good roads and are de-
sirous of observing the law relating to speed. We
do not wish to take active measures against auto-
mobilists, but unless they use more discretion and
cease to travel at the high rate of speed on the
roads of the Town of Berlin we shall enforce the
State law and do it rigidly.
We have no desire to antagonize automobilists,
but rather desire to work with them, but unless
they show a disposition to co-operate and cease to
abuse their privileges, we shall rigidly enforce the
law.
Yours very truly,
(Signed) W. H. GIBNEY, N. W. BALDWIN, E. G. ROCHE, Selectmen,
Town of Berlin, Conn.

The man who ordinarily will not show consideration
for others becomes even worse when placed at the wheel
of a high-powered automobile. Secure himself, from
harm, he cares little for those who may cross his path,
and at times his conduct is such as to cause one to doubt
if he is not bereft of his senses. Read on another page
of the attitude of one across-the-State traveler who was
remonstrated with by an observing and conscientious
member of the Hartford club. Through the State, this
trampler upon the rights of others was going, and little
he cared for the law or those who were trying to pre-
serve it. Small wonder is it that the citizens of Berlin
and other Connecticut towns feel compelled to express
themselves in terms that are unmistakable and justified.
The law-abiding autoists must purge their own ranks.

Those who will not see simply because they won't,
must be made to see. This reckoning has been delayed
beyond the limits of the patience of the general public,
which has yet to become thoroughly accustomed to the
presence of the motor-driven vehicle.

HOW CONNECTICUT'S LAW IS ABUSED.

HARTFORD, CONN., April 26.—Many complaints have been made of late that out-of-State autoists touring through Connecticut have no regard for the law. A case in point is that of the reckless operation of a car bearing the New York State license number 60,967. An officer of the Automobile Club of Hartford, which organization is doing its utmost to preserve the present liberal law or bring about the enactment of a similar measure at least as good, noted the number of the car, which speeded down one of the main thoroughfares of the town and later encountered the driver at a local garage. He remonstrated with the driver, who laughed at him and stated that as he would soon be out of the State, the Connecticut law had no terrors for him. It is just such indiscreet action as this that is bound to put a crimp in the Connecticut law. It is needless to say that a close watch has been kept in general since the Legislature convened.

WISCONSIN MAY ELIMINATE SPEED LIMITS.

MILWAUKEE, WIS., April 26.—Officials of the Milwaukee Automobile Club and Wisconsin State A. A. are confident that the bill now before the Legislature, practically eliminating the speed limits for cars and making recklessness cause for arrest at any time and place, will be passed. The committee considering the measure has decided to report it favorably, after James T. Drought, counsel for the Milwaukee Automobile Club, made a vigorous argument in its favor and explained it clearly. The law makes the speed limit 25 miles an hour, but is so framed that a driver would be liable to arrest for violation if he ran recklessly in any part of the State. If a driver ran even as low as five miles an hour on a crowded street and that speed was dangerous, the driver would be liable to arrest. The bill enhances the police powers of the State while removing many harsh restrictions from owners of cars. It is an entirely new measure.

MOTOR FEDERATION NOW HAS 25 CLUBS.

WILKES-BARRE, PA., April 26.—The fourth annual meeting of the Pennsylvania Motor Federation was held at Wilkes-Barre, April 23, where the directors were the guests of the local club. Reports of the officers and chairmen of the legislative and good roads committee were decidedly encouraging, and general satisfaction was expressed over the passage through the Legislature of the Townsend motor vehicle law, which was the bill prepared by the Federation.

The board passed a strong resolution recommending that its clubs co-operate with the local authorities to secure a strict observance of the terms of the new law, and recommended that habitually reckless drivers who cannot be controlled be not only publicly expelled, should they be members of automobile clubs, but that the club officials aid in securing convictions which would entail a jail sentence or the revocation of license or registration.

The secretary's report showed an enrollment of 25 clubs, with a total membership of 2,600, an increase of 10 clubs and 800 members within the year.

The Cumberland Valley Automobile Club, the Beaver Valley Motor Club, the Juniata Valley Motor Club, the Chambersburg Motor Club, and the DuBois Automobile Club were elected to membership.

The good roads committee have plenty of work cut out for them in the preparation of a system of main State highways and the codification of the road and bridge laws of the State, to be used in the preparation of legislation to be presented in 1911.

Robert P. Hooper, of Philadelphia, was re-elected president; Peter A. Meixell, of Wilkes-Barre, and John A. Wilson, of Franklin, vice-presidents, and Paul C. Wolff, of Pittsburg, was again asked to serve as secretary and treasurer.

Joseph H. Weeks was reappointed chairman of the good roads committee, S. Boyer Davis of the legislative committee, and L. P. Baekky of the publicity committee. The appointment of a chairman of the touring committee was withheld for the present.

A. A. A. HAS TWENTY-NINE STATE BODIES.

NEW YORK, April 26.—There are now twenty-nine affiliated State organizations in the American Automobile Association, through the election of Utah and Iowa bodies at the meeting of the executive committee, held at national headquarters, April 21. Besides the Utah Automobile Club and the Iowa State Automobile Association, the Adams County Motor Club, of Natchez, Miss., and the Montgomery Automobile Association, of Montgomery, Ala., were elected as unfederated clubs. In Mississippi and Alabama, plans have been started for State bodies.

The place and the date of the second annual good roads and legislative convention will be announced shortly, according to Chairman George C. Diehl, who has this matter in charge.

Those who attended the meeting of the executive committee were: President Lewis R. Speare, Boston, who presided; W. C. Crosby, president, and H. A. Bonnell, secretary, Associated Automobile Clubs of New Jersey; Robert P. Hooper, president, and Paul C. Wolff, secretary, Pennsylvania Motor Federation; J. P. Coghlin, president, Worcester Automobile Club; G. H. Gillette, secretary, Connecticut State Automobile Association; L. J. Powers, Jr., Springfield Automobile Club; Alfred Reeves, general manager, A. M. C. M. A.; E. P. Chalfant, general manager, A. L. A. M.; Charles Thaddeus Terry, New York; F. H. Elliott, secretary, A. A. A.

CLEVELAND AFTER A. A. A. CONVENTION.

CLEVELAND, April 28.—The Cleveland Automobile Club, supported by the Cleveland Chamber of Commerce, is going after the next annual convention of the American Automobile Association, according to an announcement made by Secretary C. J. Forbes, Jr., of the local Automobile Club.

President W. F. Bonnel, of the Cleveland Automobile Club, and Harry L. Vail, president of the Ohio State Automobile Association, expect to leave for New York City this week, in an effort to bring the matter to head. They will urge the desirability of Cleveland as a meeting place for the A. A. A. The local club has the enthusiastic support of the Cleveland Chamber of Commerce, the leading organization of this city.

CUT-OUT NOT A SIGNAL DEVICE.

MILWAUKEE, April 26.—The municipal court at Racine, Wis., has decided that the "cut-out" is not a signal device in the meaning of the law, and Roy Easson, a tester for the Mitchell Motor Car Company, of Racine, was fined \$10 and costs. An appeal has been made to the Supreme Court. George Peterson, chairman of the town of Mt. Pleasant, swore out warrants for the arrest of Easson and two others of the nine Mitchell testers, claiming that as they had no bell or horn they were guilty of violating the law requiring signal devices. Each machine, however, was supplied with a pedal cut-out, which constituted the defense.

In Milwaukee there are hundreds of machines whose only signal device is the cut-out, and the only threatened prosecution in this connection has been by a nervous man who thought the cut-out made unnecessarily loud noises. Many Ramblers are supplied with nothing in the way of signal devices except the pedal cut-out, and the testers of the Kenosha product have experienced no trouble.

NEW YORK'S PROPOSED LAW PROBABLY DEAD.

ALBANY, N. Y., April 28.—The Allds bill, to provide a motor vehicle law without a speed limit, to-day was amended in the Assembly so as to put in a speed limit and permit local regulations, in addition to a clause to shut out automobilists from States where New Yorkers are not allowed reciprocal courtesies. There was a rising vote of 71 to 48, and New York City members joined those from rural counties in voting for the amendments which kill the bill unless the Governor sends in an urgency message for passage as amended during the next two days.

SUGGESTED RULES TO GOVERN OBSERVERS IN CONTESTS

FEW of the endurance contests scheduled for the coming season are run without the use of the observer system, whereby each entrant nominates some one to ride on a competitor's car. Frequently it has been found in the past that the observers did not understand the conditions, and inasmuch as their principals were only indirectly affected by laxity, did not do the full duty expected of them. To overcome this, E. C. Johnson, of the Keystone Motor Car Company, of Philadelphia, formerly a chairman of the contest committee of the Quaker City Motor Club, and an official in many races and road contests, has compiled a set of rules in which special attention is paid to the observer question. The regulations were planned to be used in connection with endurance runs of the Q. C. M. C., and provide for the whole affair, only that section applying to the entrants' representatives on other cars being considered here.

In regard to observers, the rules say: "The committee will hold each entrant responsible for the action of the observer named by him"; and in the list of penalties, under the section on observers, the following are the regulations:

Each contestant shall nominate a responsible man to act as an observer. This man will be placed in one of the contesting cars, and it shall be his duty to keep accurate record of all replacements, adjustments, motor stops, etc., on a card furnished each

day, this card to be turned over to the chairman of the contest committee at the termination of each day's run. Contestant nominating such observers will be held responsible for the proper performance of his duty, and will be penalized as follows, should he fall in said performance:

- (a) 10 points for failure to record the actual time of passing each checking station, and at the night control.
- (b) 10 points for failure to record all adjustments.
- (c) 5 points for failure to record all replenishments.
- (d) 20 points for failure to record all motor stops.
- (e) 50 points for failure to deliver observer's card to a member of the contest committee within thirty minutes after checking in at the night control, or at the termination of the run.
- (f) 100 points for failure to record any assistance received during the progress of the run.
- (g) 1000 points for deserting the car before the completion of the run.
- (h) The refusal of an observer to make an affidavit as to the correctness of his report, should such be desired by the contest committee, will be sufficient grounds for disqualifying the entrant nominating such observer.

Some of these penalties are very severe, but it must be remembered that if the observer fails in any of these particulars the car in which he rides may be heavily penalized by something over which its crew has no control, and that it is just to inflict the penalty upon the nominee of such an individual.

FIRST ENTRY FOR GERMANY'S BIG TOUR IS DISAPPOINTING

BERLIN, April 22.—First entries for the Prince Henry tour have closed, with the somewhat disappointing result of 111, against 145 of last year's first entry. It was believed that Austro-Hungary's active participation would have brought a great number of competitors together; at present, however, only eight have entered. The three credit points for the less experienced drivers have not kept any of Germany's big guns away, and Poege, Erle, Held, Opel, Lindpaintner, Stoess, Benz, Mathis and Bugath will all come up to the mark.

Germany is naturally very much to the front with 80 entries, 16 of which are Opels, while Mercedes and Benz are down with nine cars each, and the other firms in equal proportions.

Belgium and Italy have entered nine cars, Austria eight and

France five, while England, Holland, Switzerland and the United States are completely lacking.

It is also unlikely that the severe regulations to keep freaks and specials out of the event will be of much avail, as some of the stroke measurements afford very remarkable reading. Horch has built an engine with a stroke of 170 millimeters to a bore of 85 mm. The Gaggenau cars are described as having a bore of 100 and stroke of 200 mm. One of the smallest Opel cars has a bore of 70 and a 125 mm. stroke. Poege's Mercedes is fitted with a 90 by 140 mm. motor. It will be interesting to see what the regulation touring cars will be able to do against these special designs. Among all the first 111 contestants there are only two six-cylinders, these being the Protos cars.

ACCESSORY ASSOCIATION NOW HAS NEW YORK QUARTERS

NEW YORK, April 26.—Representing 180 manufacturers of automobile parts and supplies, the Motor and Accessory Manufacturers now have headquarters in New York City, accessible to members who come to the metropolis, and comfortably located at 17 West Forty-second street. This organization is composed of makers who furnish automobile factories, dealers and garages with nearly all of their supplies, and is chiefly occupied in acting as a clearing house for information, introducing new concerns, and in deciding policies of national importance.

The manner of participating in the annual shows, and of not going into the local ones on account of the great number and consequent expense, is a matter considered by the accessory manufacturers through the association. Membership gives numerous advantages: prestige of being associated with prominent firms and men in the industry; protection against a wave of price cutting, although it does not attempt to control or even to fix prices, as this would be in defiance of the interstate commerce laws; and the advantages of a clearing house of experienced tradesmen. This last is an important feature of the work of the central office, for on its lists are the names of over 3,000 purchasers of automobile supplies, and all are garages, dealers

or factories, none being individual buyers. The members of the association give information regarding their customers, but the name of the member filling out the blanks is not noted. Other members may at any time write to the office in this city asking for the credit of rating of prospective purchasers, and thereby know just how to treat matters of credit.

The organization is growing rapidly, an average of five new firms being elected at each quarterly meeting. The officers are:

President, H. E. Raymond, B. F. Goodrich Company; first vice-president, H. T. Dunn, Fisk Rubber Company; second vice-president, F. E. Castle, Atwood-Castle Company; third vice-president, C. E. Whitney, Whitney Manufacturing Company; treasurer, W. S. Gorton, Standard Welding Company; secretary, P. S. Steenstrup, Hyatt Roller Bearing Company. The directors are: H. S. White, National Tube Company; D. J. Post, Veeder Manufacturing Company; C. T. Byrne, Byrne, Kingston & Company; H. W. Chapin, Brown-Lipe Gear Company; E. S. Fretz, Light Manufacturing & Foundry Company; L. M. Wainwright, Diamond Chain & Manufacturing Company.

The New York office is in charge of H. M. Street, from whom information regarding membership can be obtained.

What the Clubs are Doing These Days

HARVARD TROPHY AT BAY STATE MEET.

BOSTON, April 26.—The complete list of events for the June 17 race meeting of the Bay State Automobile Association at Readville track has been announced by the contest committee, of which Chester I. Campbell is chairman. There will be eight events, the most important of which is that for the Harvard trophy, offered by students of Harvard College for a 25-mile event open to all cars. In addition to the trophy the winner will receive \$500 in cash, while cash prizes of \$200 and \$100 are offered for second and third. It is expected that a number of fast cars owned by students will compete in this event. Another trophy race is that for the Automobile Trade trophy. This is to be at 10 miles for cars over 36 horsepower, close coupled and baby tonneau bodies being excluded. The third trophy event is that for the Bailey trophy at five miles for stock cars to be driven by owners. The complete list of events is as follows:

- 1—Five miles, for Bailey trophy, open to stock cars to be driven by owners or their representatives not having any connection directly or indirectly with the automobile trade, no chauffeur or professional driver.
- 2—Twenty-five miles, for Harvard trophy, open to all cars. First prize, the trophy and \$500 additional; second prize, \$200; third, \$100.
- 3—Five miles, open to touring cars up to and including 24 horsepower, close coupled and baby tonneau cars excluded. First prize, cup; second, gold Bay State Association medal; third, gold Bay State Association medal.
- 4—Five miles, open to touring cars up to and including 36 horsepower, close coupled and baby tonneau cars excluded. First prize, cup; second, silver plate; third, bronze plaque.
- 5—Ten miles, for Automobile Trade trophy, open to cars over 36 horsepower, close coupled and baby tonneau cars excluded. First prize, trophy; second, silver plate; third, bronze clock.
- 6—Three miles, open to stock car, roadsters or runabouts up to 30 horsepower. First prize, cup; second, silver plate; third, Bay State Association medal.
- 7—Five miles, open to stock cars, roadsters or runabouts, 31 horsepower and over. First prize, cup; second, gold Bay State Association medal; third, gold Bay State Association medal.
- 8—Special match race, to be announced later.

The contest committee is composed of Chester I. Campbell, secretary of the Dealers' Association, chairman; F. E. Wing, the Marmon agent; C. J. Bailey, the Bailey tire tread manufacturer; Walter G. Schmunk, of the White company, and James Fortescue, secretary of the Bay State Association. The track has been secured and will be put in first-class condition.

In addition to the races the association is planning several other events, including a club run to Providence on Memorial Day, a hill climbing contest on the Fourth of July, and an endurance run to be held later in the season.

COLUMBUS AFTER A GREATER MEMBERSHIP.

COLUMBUS, O., April 26.—The Columbus Automobile Association will start an active campaign for membership May 1, which is the beginning of the fiscal year.

The Supreme Court of Ohio has granted leave to T. M. Drolesworth, of Summit county, to file a test suit against the State automobile law. The complainant was fined for violating the law. He contends that the law is unconstitutional because it prescribes unequal fees and gives the State a monopoly of the business of furnishing tags. Automobile owners do not believe that the suit will succeed in overthrowing the law.

LARGE ADDITION TO LONG ISLAND CLUB.

BROOKLYN, N. Y., April 28.—In the new house of the Long Island Automobile Club the regular monthly meeting this evening resulted in the election of one of the largest membership lists ever proposed in the history of the organization. Fifty-four additions were made, 49 of these being to resident membership, while the remaining five were non-residents. The opening of the club garage, with its accompanying club-room facilities, has been a great success.

MORE CLUBS FOR A. C. C. OF NEW JERSEY.

NEWARK, N. J., April 26.—Organization of more county clubs and the strengthening of those already formed is taking much of the time of the officials of the Associated Automobile Clubs of New Jersey. Last week Frederick H. Elliott, secretary of the American Automobile Association, and Horace A. Bonnell, secretary of the New Jersey Federation, went to Plainfield to reorganize the club established there and place it on a firmer footing. There are a large number of automobile owners in the vicinity of Plainfield, and the local club promises to form the nucleus of one of the strongest bodies in the State.

The Warren County Automobile Club, with eighty members, has applied to Secretary Bonnell for the conditions of membership in the Associated Clubs, and will probably join the State organization within a month. This will strengthen the State body, as there has been no representation in that part of New Jersey covered by the Warren County Club.

SYRACUSE CLUB WILL POST SIGNS.

SYRACUSE, N. Y., April 26.—Secretary Forman Wilkinson states that the Syracuse Automobile Club will carry on a vigorous sign placing crusade this Summer, a stock of 100 signs having been ordered, in co-operation with town boards or village officials throughout this section of the country. The signs will be at the call of the townships, and the club will welcome the assistance of autoists in ascertaining needed location for these direction guides. The agitation against joy riding is supported locally, for there has been some prevalent, and the club has resolved to use its influence to have this practice stopped and a stricter adherence to the speed laws observed.

Permanent club offices will be opened on May 1 in room 606, S. & A. K. building, where accurate information regarding routes will be kept for the use of tourists.

CENTURY AUTOMOBILE CLUB TO BE LIVE WIRE.

PHILADELPHIA, April 26.—The Century Automobile Club, the successor of the Century Wheelmen, is preparing to enter actively into the competitive game. As a first step toward this end a live committee on contests, tours and entertainments has been appointed, which will open the season with a smoker in the club's handsomely appointed theater on Saturday evening, May 8. On Sunday, May 16, two score cars will participate in the initial club run, destination to be announced later. Later in the season a one-day open endurance run to one of the North Jersey coast resorts will be put on, and a winter reliability contest is also talked of. It is the intention to have these events for amateurs primarily, for there are more private owners taking advantage of the new club, than of the trade. Improved rules have been outlined, embodying some new features.

ANNUAL ELECTIONS ARE NUMEROUS.

Schenectady, N. Y., April 26.—The following board of governors has been elected by the Schenectady Automobile Club, and they will act as chairmen of the following committees: Membership, George Close; laws and ordinances, W. D. Loucks; exhibits, tours and contests, W. J. Close; good roads, E. F. Peck; grievance, Walter Green; publicity, F. R. Champion; extension, T. H. Soren; signs, E. J. Vrooman.

Middleboro, Mass., April 26.—At the annual meeting of the Middleboro Automobile Club the following officers were elected: President, Levi O. Atwood; secretary-treasurer, Chester E. Weston; directors, L. O. Atwood, C. N. Atwood, C. W. Maxim and A. A. Thomas.

ENLARGED OUTLET FOR FRONTENAC CARS.

NEWBURGH, N. Y., April 26.—Activity is the keynote of the work now being carried on by the automobile department of the Abendroth & Root Manufacturing Company, of this city, the manufacturers of Frontenac touring cars and roadsters. The supposed lateness of the building and selling season has had no appreciable effect here, and it seems that there must be a shortage of high grade cars of from 40 to 45 horsepower which has resulted in a large outlet for the Frontenac. This automobile has an engine of 40-45 horsepower and in all particulars is of standard design and construction. The manufacturers have an established reputation of 40 years' standing as makers of machinery, and have allied this to the production of autos.

J. J. Evans, who was formerly connected with the marketing of the American Mercedes, has just taken charge of the output of the local plant. Agency propositions are at present being considered, and early deliveries assured. In addition to the cars for pleasure purposes, there is also a Frontenac truck which has proven successful, and this will also be made in quantities.

AN ESPECIALLY CONVENIENT AMBULANCE.

INDIANAPOLIS, April 26.—The new ambulance for the Board of Health will be unusually convenient, several points of up-to-date construction having been utilized which have never been found in



Electric Ambulance Just Completed by Waverly Company.

an ambulance before. Chief among these are the electric heater, the convenient arrangement of the electric buttons, special drawers for surgical instruments and the appliances for the control of folding seats and stretchers. Worthy of mention also is the door arrangement. This differs from the ordinary in that two large side doors are used, these being 23 inches wide and opening into an interior open space of 18 inches by 3 feet 10 inches. The open space is located in front of the stretchers, convenient for the surgeon and attendants, while close at hand are the other conveniences.

The dimensions of the body are: Length inside, 8 feet 5 inches; width, 5 feet 10 inches; height, 5 feet 4 inches. The sill is 32 3/4 inches from the ground, and the step is 19 inches up. The wheelbase is 97 1/2 inches, and the tread standard. The chassis is of armored wood, with motor and battery attached to it and thus independent of the body. The motor is large and of exceptional overload capacity. It is operated from a 42-cell, 13-plate battery, constructed for speeds from three to fifteen miles, and an emergency speed of 20 miles per hour. Control is through a four-speed controller.

The interior is handsomely finished in polished hardwoods, with musset leather curtains and upholstery. In this vehicle the builders, the Waverly Company, of Indianapolis, have carefully studied the comfort of the patient as well as the serviceability of the car as a whole. The white color of the exterior gives it a typical ambulance appearance.

LATEST NEWS FROM TIRETOWN.

AKRON, O., April 26.—A combination of interests representing the leading companies in the United States manufacturing tire rims is to be effected in this city shortly, an important step having been taken April 23, when the United Rim Company was incorporated at Columbus with \$10,000 capital stock. The object of the company is not to manufacture rims, but to take further steps toward their standardization.

The incorporators of the company are Edwin C. Shaw, general manager of the B. F. Goodrich Company; P. W. Litchfield, superintendent of the Goodyear Tire & Rubber Company; Arthur H. Marks, vice-president and general manager of the Diamond Rubber Company; H. E. Raymond, sales manager of the Goodrich Company, and Ernest Hopkins, representing the United States Rubber Company, of New York. This company will probably succeed what was formerly known as the "Rim Association," and through the new arrangement one rim will now hold a tire of any size. Companies making rims in the United States are the Diamond Rubber Company (Marsh rims), the Goodrich, Goodyear, the Midgeley Manufacturing Company and the Standard Welding Company, of Cleveland.

The Diamond Rubber Company is following extensive additions to its plant made last year by two large ones planned for this year. The company has begun on a new laboratory that will be 148 feet long by 50 feet wide and three stories high. It is said that it will be the best equipped India rubber laboratory in the United States. Another immense addition will be started soon for factory purposes. It will be 200 feet long, 100 feet wide, and five stories high.

The cross-country auto transit business is becoming a very active industry in this part of the State. This week the Akron Motor Transit Company was incorporated by Akron men with \$10,000 capital stock for the purpose of operating auto cars between this city and the Summit lakes, south of Akron, three to five miles. The service will begin Memorial Day with a specially built 30-passenger, 60-horsepower autobus. The company is to take the place of an interurban car line that was incorporated, but which did not secure sufficient capital to be put in operation. Another auto bus line just starting is operating between two towns west of Akron, and will form the connecting link between two important systems of electric lines, both of which connect with Cleveland and eastern and western points. Still another auto line is to connect a number of county seats adjoining counties where electric lines were first proposed.

SPEEDWELL WILL TRIPLE SIZE OF FACTORY.

DAYTON, O., April 26.—Having increased its capital from \$50,000 to \$250,000, the Speedwell Motor Car Company has announced that it will triple the size of its present factory. Three acres of ground in Edgemont, adjacent to the plant, have been purchased, and on this will be erected a big modern concrete building of up-to-date construction.

Other improvements will follow, and the officials of the company announce that within a year more than 1,200 workmen will be employed. This increase is the result of the growing business in Speedwell automobiles, and additional factory accommodations became necessary. The officers of the Speedwell Company are: President, Pierce D. Schenck; vice-president, M. L. Sternberger; secretary and treasurer, R. A. Herbruck; general manager, J. G. Loomis.

ANOTHER MOTOR BUGGY FROM ILLINOIS.

ROCK ISLAND, ILL., April 26.—Automobiles of the buggy type in four different styles will be built in this city by the Geo. White Buggy Company, and will be marketed under the name of White. The motor will be a two-cylinder air-cooled one, geared with a ratio of 10 to 1, giving a maximum speed of 24 miles per hour. The wheels will be of medium size with large solid rubber tires. No foot pedals will be used in the control.



The Systematic Arrangement of the Pierce-Arrow Factory's Stock Room is a Delight to the Visitor's Eye.

HOW SYSTEM RULES IN ONE FACTORY.

BUFFALO, April 26.—Among the first things considered by the factory manager when a new plant is being constructed is the amount of space to be given to rough and finished stock, and the location of the rooms. Poor stock room facilities and a lack of system in an automobile factory will nullify all plans for economy in plant operation and certainty of output. In the early days of the industry new concerns occupied factory buildings that had been constructed for the manufacture of something entirely different. Makeshifts were necessary in the arrangement of stock rooms, machinery departments, and assembling floor, and parts, in taking their course through the factory, often crossed their own paths as many as a dozen times. Loss of time, the taking up of floor space, loss of parts, and confusion were among the necessary disadvantages of this system.

With the growth of the industry came a new order. When building new factories solely for the manufacture of automobiles, economy in operation was given serious consideration. Manufacturers of not only automobiles, but other articles as well, have no hesitancy in expressing great admiration for the arrangements of floor space, and of manufacturing systems employed at the new plant of the Pierce-Arrow Motor Car Company. The only way in which a part crosses its own path between the time it enters this factory and is placed in position in the cars, is when more than one machine operation is necessary to finish it from the rough stock stage. In this case it is taken to the inspection department after each operation, and when it

has been passed upon there is returned to machinery hall. In their sequence to the assembling floor from the railroad siding where the rough stock is unloaded, the departments are: Receiving room, rough stock department, machinery hall, inspection department, finished stock room, assembly floor. A straight line is scarcely deviated from, from the railroad siding to the assembly floor, the only changes from the direct route being the jogs necessary in going to various machines on the way to the inspectors. The machine shops and inspection rooms are so located that the direction is always a short, straight one, and when necessary to go to upper floors, the parts operated upon in one department pass right along to an elevator. The time saved is extremely valuable, and a large amount of money is thereby saved in production.

The heart of the person who originally planned the phrase, "A place for everything and everything in its place," would rejoice could he make a tour through the rough and finished stock rooms at the Pierce-Arrow plant. There is always a complete list of the stock in hand, and a plan of where every part may be found. In the rough stock department the larger castings, such as flywheels and cylinders, engine bases, and gearcases have their own floor spaces, as do the forgings. Smaller forgings and castings are kept in bins, while the smallest parts are stored in shut steel boxes on shelves. Bars and rods of steel and brass have their own racks, each one labeled, and sheet metal is stacked on the top of the racks. In the finished stock room almost all the parts are kept in steel drawers.



In the Inspection Room Each Workman Has a Desk and Is Seated at the Careful Work of Checking Up Parts Dimensions.

MORE TAXICABS AND STILL MORE.

SPRINGFIELD, MASS., April 26.—A shipment of fourteen taxicabs to the Phillips Automobile Company, of St. Louis, has just been made by the Atlas Motor Car Company, of this city. These newcomers, with the cabs now owned by this company, will make a total of more than twenty Atlas cabs by one company, with more to follow. The two-cycle engine with which they are equipped had much to do with the adoption of this make, as the simplicity, ease of starting and practical indestructibility appeal to the man who pays the bill.

The 1909 cab equipment has the two-cylinder, two-cycle, 20-horsepower engine, equipped with Atwater-Kent ignition system, sight-feed Hancock oiler, gear-driven instead of belt-driven; improved carbureter, with gasoline adjustment on dash; pump circulation, which eliminates all possibility of overheating the engine under the most severe conditions; gear-driven fan, which makes it possible to run engine at highest speed when the car is standing still, without any steaming of the water. A high-grade steel frame is used, the width of which in front is narrowed up three inches to allow maximum cramp of the front wheels and which adds greatly to the appearance. A very superior sliding gear transmission has been developed, which combines all of the good qualities of both the sliding gear and planetary type of transmission.

MAXWELL ENGINE FOR MOTOR BOAT.

The defeat of the *Dixie II* at the Monaco race meet has stirred up the American motor boat builders, and one of the immediate results is the announcement of a number of new boats. One of the first is to be the *Maxwell-Driscoll*, so named after the engine and the owner. The latter, R. J. Driscoll, of the Tarrytown Yacht Club, is having a boat of the same size as the *Dixie II*, 12 meters, built at the plant of the Hudson River Motor & Boat Works, of Tarrytown.

This will be equipped with a special motor from the works of the Maxwell-Briscoe Company. The number of cylinders to be used is 12, and the power rating is given out as 200. Bore and stroke have not been publicly announced, but the whole construction will be special, to match the especially light hull.

The new boat will be entered in all of the speed boat contests for which it is eligible, including the Fulton celebration and international races.

PALMER-SINGER MODEL FOR SUMMER USE.

The Palmer-Singer victoria is one of the most attractive summer models yet seen in New York. The body follows the conventional lines of horse-drawn carriages, adapted, of course, to its different mounting. It will recommend itself very strongly to people who are just giving up horses for city use. The chassis is of 30 horsepower, insuring considerable touring ability; the double-drop frame allows the body to be hung very low and lends itself to the graceful curves of the design. An extra body of the enclosed type, for winter use, can also be furnished.

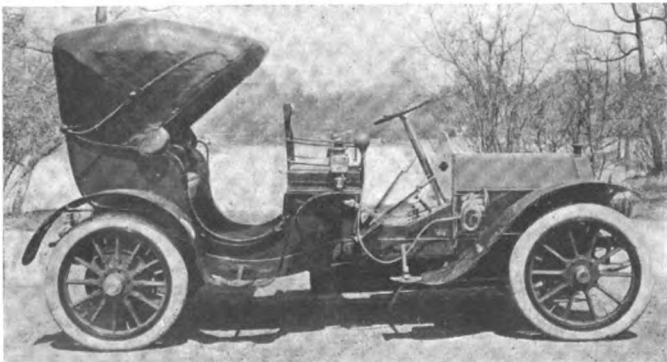

Thirty-Horsepower Palmer & Singer Victoria.

WILKINSON ADVOCATES SPHERICAL HEADS.

In a recent discussion of the cooling effect of having the interior of the cylinders of an automobile engine approach as nearly as possible the spherical form, thus exposing a minimum of surface to combustion, John Wilkinson, chief engineer of the H. H. Franklin Mfg. Co., said:

In order to keep the temperature of the cylinder walls of a gasoline automobile engine within working limits the design must be such as to lessen the heat allowed to enter the walls or increase that carried off, or both of these results must be accomplished. Getting less heat into the walls involves one of the fundamental principles of the economy of the gas engine and is best accomplished by reducing the internal surface exposed to combustion to a minimum, which means principally designing the combustion chamber so it will be as nearly spherical as possible.

If the internal surface is less, the less the incoming charge is heated and the less heat is lost to the cylinder walls; therefore the greater the power and efficiency the less heat it is necessary to carry off from the walls to keep them at a working temperature.

This fact does not seem to be well recognized, as we still see engines built with the valve pocket on each side of the cylinder. The internal surface exposed to heat at the time of explosion in a four-inch by four-inch motor, with a semi-spherical cylinder head, is about 38 square inches; in the same motor with a valve pocket on either side of the cylinder it is about 74 square inches, and a good part of this surface has to be left rough. It is evident that the jacket loss must be much greater in the last instance.

Engines with a hemispherical head show a gain of 25 per cent. in power and efficiency over the type with a valve pocket on each side. This type of cylinder head may also be machined smooth on the inside to reduce its absorbent effect to a minimum.

The concentric valve on the Franklin motor cars was designed to fit in exactly with air-cooling, dome-head, large-intake-valve construction, which would give increased power, increased efficiency and increased cooling ability. This construction also means a shape of cylinder and valves in which expansion from heat is equalized in every direction, preventing heat warping of parts.

FAL-CARS APPEAR ON CHICAGO STREETS.

CHICAGO, April 26.—The newest of Chicago-made automobiles, the FAL-Car, successor to the Reliable Dayton, is now active in the automobile affairs of the city. Demonstrations are being made, and H. R. Averill, the sales manager, reports that 20 cars will be ready for shipment by May 10. They are built in three styles, touring car, toy tonneau, and roadster, all on one type of chassis, with a four-cylinder, 30-horsepower motor, and selling for \$1,650. The firm intends to move from its present quarters at 15 North May street, to a larger plant on the south side of the city, so that the production for this year of 100 cars will be increased to 700 for the 1910 season. The important races and contests will be entered by the FAL-Car, in its classes.

ONE COMMERCIAL VEHICLE DEMONSTRATION.

HARTFORD, CONN., April 26.—An excellent demonstration of commercial car efficiency was afforded by S. A. Miner, who has been utilizing second-hand cars in delivery wagon service. The demonstration was made for the benefit of a large local grocery house. The commercial vehicle was loaded at the same time as were the horse vehicles. Thirty-six boxes of groceries of varying weights were loaded on the Knox car, and, according to the driver of one of the horse teams, it would require 3 to 3½ hours to deliver. The Knox did the trick in 1 hour 5 minutes.

KEYSTONE SIX IS NAME OF NEWCOMER.

NEW CASTLE, PA., April 26.—In the next fortnight the Keystone Six, of 60-horsepower, will be presented by the Munch-Allen Motor Car Company. This newcomer will have a double ignition system, including Bosch magneto, disc clutch, selective transmission, 121-inch wheel base and use 36 by 4-inch tires. The car will sell at \$2,250, completely equipped, and its makers will give a guarantee for one year. The company intends to put out about 250 cars of the 1910 model. It was erroneously printed that the car would be known as the Pennsylvania No. 6.

Told in the Progress of the Industry

Rapid Expansion of Oklahoma Motor Car Company.—An example of the growth of the great Southwest is that of the Oklahoma Motor Car Company, of Oklahoma City. This concern, dealing in automobile supplies for the past two years in Oklahoma, has outgrown its facilities, and has opened a branch, larger than the home office, in Dallas, Tex., from which the Lone Star State will be supplied with accessories. This will be conducted under the name of the Southwestern Automobile Supply Company, at 349-351 Commerce street. A third establishment under the title of the Overland Automobile Sales Company has been opened in Dallas, and it will have the agency for the Overland and KisselKar in Texas and New Mexico. The three concerns are identical in ownership, and President Will T. Brown and General Manager T. B. Funk will have managers in each place.

Waverly Electric in Rural Mail Service.—The use of electric automobiles in city mail delivery service is not uncommon, New York having added three to its equipment recently, but in rural work this type of propulsion has been less frequently used. On route 2, out of Manchester, N. H., Mark T. Hoffman uses a Waverly road wagon of 1905 design. He writes to the Waverly Company: "I am about to put my Waverly electric in commission. This is the fifth summer of five months' use each; but is second season of a new Exide battery which was charged 100 times for the 24-mile trip. The battery did wonderful work, making the trip of 24 miles with hills of 1,000 feet in all, on two volts, or 64 at start and 62 at finish, even on rainy days. This was over the rural U. S. mail route with 50 stops."

Business Men Recognizing the Motor Truck.—The filing of an order for a 5-ton American motor truck by the American Motor Truck Co., of Lockport, N. Y., for the Robert MacKinnon Co., Little Falls, N. Y., one of the largest knitting concerns in that State, tends to show that business men are beginning to understand the difference between the requirements for a commercial car and a pleasure car. This car will replace three heavy trucking teams and wagons, and is built for service alone. It has a four-cylinder 60-horsepower motor, with extra large and long bearings. Its piston area is greater than that of a similar powered pleasure car motor and the revolutions are slower.

New Chicago Home for Premier.—Webb Jay, Chicago agent for the Premier Motor Car Company, has let contracts for the construction of a reinforced concrete building at 2329 Michigan avenue. This will be rushed to completion so that it may be occupied by mid-summer, and will be the western distributing headquarters for the Premier. The first floor will be arranged for the offices, the salesrooms, and garage; the second for making tops; and the third for a stock room and repair shop. A 20-year lease was taken and the structure will be a model of its kind.

Ferry Route Across the Sound.—A short cut for automobilists from points in Westchester County, New York, and in lower Connecticut, to Long Island has been proposed by the Oakland Steamboat Company, Inc. It is planned to run boats at frequent intervals between Rye and Seacliff, and between Stamford and Cold Spring Harbor. Its regular service is between New Rochelle, Rye, Oakland Beach, and Stamford. The ferries across the sound would cut off a great distance now traveled through New York City.

Baker School of Instruction.—The Baker Motor Vehicle Company recently held a school of instruction at its factory in Cleveland, under the direction of its chief electrical engineer, Emil Gruenfeldt, at which representatives of nearly all the Baker agencies throughout the United States were present. Mr. Gruenfeldt gave a series of talks regarding the mechanical construction, equipment, maintenance, care of batteries, etc., and thoroughly demonstrated the new Baker electric models.

M. & W. Tires on Pathfinder.—Tire equipment will play an important part in the Glidden tour this summer, and the Morgan & Wright Company, of Detroit, is pleased by the fact that the E-M-F car which is making the pathfinding trip is equipped with M. & W. tires. These have been standard equipment on E-M-F, and the automobile builders made no change for the hard run on the almost impassable spring roads.

Reo Increases Capital.—The capital stock of the Reo Motor Car Company, at Lansing, Mich., has been increased from \$1,000,000 to \$2,000,000. About \$250,000 will be spent at once in enlarging the capacity of the factory, so that 10,000 machines a year may be built instead of the 7,000 as at present. The plant is now shipping 50 automobiles a day to all parts of the country.



Electric Sightseeing Chairs.

The two-passenger motor-propelled chair, which will be used about Belle Isle, Detroit's chief park attraction, the coming summer. These cars are capable of a speed of eight miles per hour.

Fal Motor Company Plans Southern Assembling Branch.—To insure more rapid delivery of cars in the South, the Fal Motor Company, the recent successor of the Reliable Dayton Motor Company, is planning to have a branch in Memphis, where some of its cars will be assembled. The parts will be shipped from the machine shops in Chicago.

Winton Six Popularity Felt at Factory.—The popularity of Winton Sixes has necessitated a 12-hour day in the machine department and an extension of the assembling department, whereby floor space of about 50 per cent. will be added. Work is going forward and the addition will be ready for use within two weeks.

Vanderbilt Buys Motor Plow.—George W. Vanderbilt is equipping his estate at Biltmore, near Ashville, N. C., with a number of automobiles and other motor-driven vehicles for farm use. He has already installed a motor plow, and a provision wagon.

Weston-Mott Company Enlarges Factory.—The Weston-Mott Company of Flint, Mich., has announced that it will shortly begin the erection of a new factory. The contract has been awarded to the Vinton Construction Co., Detroit.

Dallas, Tex., Dealers Organize.—The Dallas Automobile Dealers' Association has been organized with the following officers: President, M. A. Sacksteder; vice-president, M. B. Burwell; secretary-treasurer, J. B. McGraw.

Covert Motor Car Company in Detroit Field.—The Covert Motor Car Company has begun the manufacture of a medium-priced touring car with a four-cylinder, two-cycle engine.

D.H.K. Company Formed in Detroit.—A new company has been formed called the D.H.K. Motor Car Company, to build light runabouts to sell under \$500.

IN AND ABOUT THE AGENCIES.

Rainier Opens Philadelphia Branch.—The Rainier Motor Company has opened a branch in the Quaker City under the management of J. Knight Neffel. A location at Chestnut and Eighteenth streets, well away from the automobile row, has been secured. Mr. Neffel was formerly sales manager of Smith & Mabley, of New York, and later Paris representative of the same concern.

Firestone, St. Louis.—The two branches of the Firestone Tire & Rubber Company have been consolidated into an enlarged store at 2230 Olive street. The stock of pneumatic tires formerly carried at 3910 Olive street has been moved to the new headquarters, which, until this time, has handled solid tires only. O. O. Petty is the manager of the consolidated branch.

Penn Auto Supply Co., Atlantic City.—The Penn Auto Supply Co., of Philadelphia, as a convenience to its many patrons, has opened an Atlantic City branch at 2006 Pacific avenue, that city. W. C. Price, formerly connected with the Hartford Rubber Co., will manage.

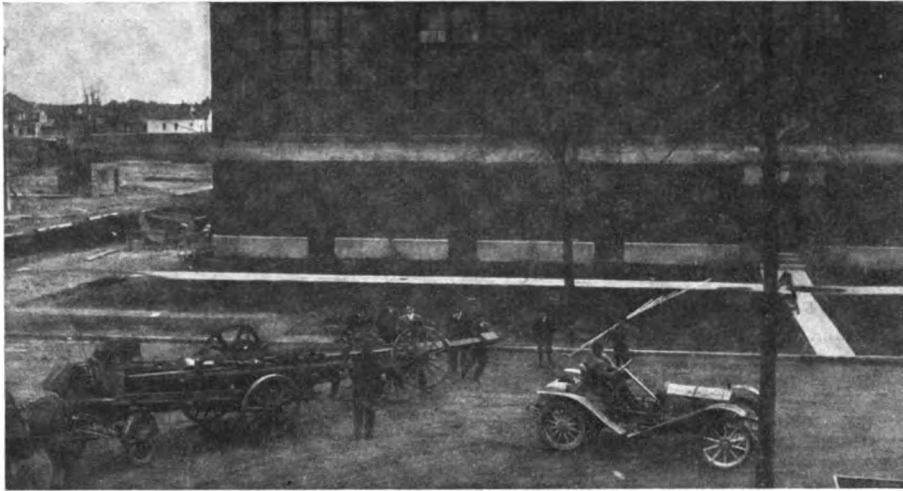

Packard Testers in Role of Good Samaritans.

Detroit is well acquainted with the Packard testing corps under Will Birmingham. It is seldom that one of them is very far away in case of trouble. The other day a horse-drawn wagon, delivering some heavy bars of steel, tipped over turning into the factory yard. Just then Birmingham happened along, and it was the work of but a few minutes to hitch onto the back end of the load and jerk it into place.

Hupmobile, Philadelphia.—To complete its line, now consisting of the National and Rambler cars, Manager Geo. G. Brownlee, of the Tioga Automobile Co., of Philadelphia, has closed a deal for the local agency of the Hupmobile, a Detroit product listed at \$750.

Rapid, Detroit.—The Rapid Motor Car Company, of Pontiac, has opened a garage and salesroom at 467-469 Woodward avenue, under the management of C. S. Bugbee.

TAXICABS AND TRANSIT.

Seattle, Washington.—The Seattle Taxicab Company, which has been operating cars in this city since March 1, now has 10 gasoline machines on the streets, and will continue to increase its service by six cars each week until enough are on hand to supply the demand. The service has proved very popular.

New York City.—A syndicate has made application to the public service commission and the board of estimate for a franchise to establish a bus service on the new Queensboro bridge, pending the installation of trolley service. The bridge is a mile and a quarter long.

PERSONAL TRADE MENTION.

N. H. Van Sicklen, Sr., the founder and former proprietor of *Motor Age*, well and favorably known throughout the Middle West, has announced his newest venture. This is in connection with the Nadall-Van Sicklen Manufacturing Company, of Chicago, of which he is secretary-treasurer. The business has increased to such an extent that new and larger quarters were a necessity. These were secured at 1233 Michigan avenue, where Nadall demountable rims will be handled.

Frank J. Campbell, whose Personal Advertising Service in Detroit was conducted at 242 Griswold street, has moved to more commodious quarters in the Trussed Concrete Building, and has changed the name of his organization to the Campbell Advertising Service. His move has placed him on "advertising square," so-called by the outside fraternity in referring to the neighborhood of the Federal Building.

Horace B. Hills, Jr., has assumed the management of the New York branch of the Royal Tourist Car Company, in its new location on Broadway at Sixty-second street. He will continue his business as agent for the Royal Tourist in Philadelphia. Max Greene, formerly associated with the White, and Chalmers-Detroit cars, will be associated with Mr. Hills in New York.

Fred J. Titus, former well-known champion bicyclist, who has been for the past five years one of the head salesmen for the Harry S. Houtt Co., of New York City, has completed arrangements to establish an agency for the Herreshoff and Houtt cars in New Jersey, at 213 Clinton avenue, Newark.

William E. Botto has accepted the position of general manager of the automobile and garage business conducted by George C. John of New York, in American Mors, Inter-State, and Marmon cars. Mr. Botto recently resigned from his position as sales manager of the Palmer & Singer Mfg. Co.

William W. Pickling, who has been prominently identified with New York second-hand automobile houses, has been engaged to manage the second-hand business of the Automobile Sales Corporation, of Philadelphia.

Robert H. Turner, formerly on the advertising staff of the Philadelphia *Evening Telegraph*, has joined the sales forces of the branch of the Firestone Tire & Rubber Company there.

C. Louis Fitzgerald has been appointed manager of the Newark, N. J., agency for the Packard. Mr. Fitzgerald has been connected with the New York Packard branch.

OBITUARY NOTICES.

Baron Edouard de Turckheim, the head of the de Dietrich firm, with works in Niederbronn, Germany, and Luneville, France, died at the Chateau de Dachstein, Alsacia, recently, aged eighty-one. Two surviving sons, Baron Adrien and Baron Eugene, are at the head of the main works at Luneville.

H. Spencer Lucas, a trustee of the firm of John Lucas & Co., the Philadelphia oil and soap makers, died at his home city on April 16.

PROVIDING, NOT PREVENTING.

In the advertisement of the General Accumulator & Battery Company, Milwaukee, Wis., appearing in the April 22 issue of *THE AUTOMOBILE*, the inadvertent use of the word "preventing" so distorted the meaning that the reading was just the opposite of what was intended. The substitution of "providing" makes it read as it should, viz.: "Current discharged through transformer, making high tension, at the same time providing dual system," etc.

REGARDING ENGINEER LANDAU.

The following communication received from Asher Golden, of Landau & Golden, New York City, is self-explanatory: "We wish to correct a notice in your last issue to the effect that David Landau has been appointed chief engineer of the Palmer & Singer Mfg. Co. We were retained about a year ago by the Palmer & Singer Mfg. Co., as consulting engineers, and have done considerable work for them in this direction. Owing to the recent resignation of Oscar Stegman, the Palmer & Singer Mfg. Co. simply called in Mr. Landau to take complete charge of their engineering department. Mr. Landau is not on the Palmer & Singer pay-roll."

LONG SERVICE OF FACTORY MEN.

Length of service of the men in a big factory plays an important part in the success achieved in raising production to a high standard, and recently an official of the Pierce-Arrow Motor Car Company requested a list of the factory heads and foremen, with the number of years' service of each. In all, the lists made up show that there are 46 men who have charge of the work of production, the highest in rank being the vice-president, whose duties includes the factory management, and from him running down the line to the foremen. The total term of years these men have been with either the Pierce-Arrow Motor Car Company or its predecessors foots up to 442, making the average connection with the company 9.61 years. The man who holds the record for long service is Henry May, vice-president and general manager, who went with the firm in 1873 and has remained with it ever since, a period of 36 years. One foreman has been with the company 28 years and two others for 21 years, while a number have worked continuously for 10 to 17 years.

RECENT INCORPORATIONS.

Mackenzie-Walton Company, Providence, R. I.—To manufacture seamless wire tubing for automobiles and other mechanical purposes. Will erect brick factory at Pawtucket avenue and Geneva street. A. J. Thorley, J. M. Mackenzie and Joseph Walton are members of the firm.

National Lamp and Brass Manufacturing Company, Chicago.—Capital, \$3,500. To manufacture auto lamps and brass goods of all kinds. Incorporators: G. W. Killeen, R. H. Wilson and H. Horner.

John J. Gibson Company, Buffalo.—Capital, \$20,000. To manufacture motors, engines, machines, cars, automobiles and wagons. Incorporators: J. N. Gregory, E. G. Thompson, George Routhead, Jr.

Automobile Owners' Protective Association, Camden, N. J.—Capital, \$100,000. To manufacture automobiles and protect owners. Incorporators: F. J. Curran, J. U. Clarke and T. F. Curley.

Jewel Electric Company, Chicago.—Capital, \$15,000. To manufacture and deal in automobiles, electrical supplies, etc. Incorporators: R. I. Phillips, M. C. St. John and M. C. Diller.

Morgan Avenue Garage, Brooklyn, N. Y.—Capital, \$7,000. To deal in automobiles, operate a garage, etc. Incorporators: J. A. Blanchfield, W. J. Blanchfield, Samuel Newman.

Taxi Motor Cab Company of Boston.—Capital \$375,000. To do a general automobile business. Incorporators: President, E. M. Davenport; treasurer, A. W. Pope.

East Side Auto Company, Attleboro, Mass.—Capital \$20,000. General automobile business. President, C. J. Adams; treasurer, A. N. Cooper; clerk, G. L. Adams.

Knickerbocker Automobile Company, Wilmington, Del.—Capital \$100,000. Incorporators: E. L. Squire, G. W. Dorsey, Jr., Albert Bird.

Miller Brothers, Amesbury, Mass.—Capital \$50,000. To do a general automobile business. President, T. C. Miller; treasurer, S. Anderson.

Brush-Chicago Motor Company, Detroit, Mich.—Capital \$11,000. Incorporators: Frank Briscoe, E. D. Moessner, Paul R. McKenney.

Deluxe Motor Car Company, Detroit, Mich.—Capital \$150,000. Incorporators: M. M. Kaufman, S. R. Kaufman, D. E. Kaufman.

Beljord Garage, New York.—Capital \$18,000. Garage business. Incorporators: D. S. Loeb, Seymour Schampain, A. H. Vitale.

Durham Automobile Company, Durham, N. C.—Capital \$50,000. To manufacture automobiles. Secretary, T. H. Lindsey.

Industrial Automobile Company, Elkhart, Ind.—Capital \$75,000. Incorporators: T. J. Shanahan, W. S. Long, L. D. Hall.

Albert Sterne Motor Company, St. Louis.—Capital, \$15,000. Incorporators: Albert Sterne, Max L. Weiss, Leonard Fassett.

American Reversible Motor Company, Boston.—Capital, \$50,000. President, A. C. Day; treasurer, G. M. Power.

Wakefield Auto Company, Albany, N. Y.—Capital \$5,000. To operate taxicabs and rent autos.

Kalamazoo Carbureter Company, Kalamazoo, Mich.—Capital increased from \$7,500 to \$25,000.

L. B. Repair Company, New York.—Capital, \$10,000. To deal in and repair automobiles.

The Perth Amboy Garage Company, Perth Amboy, N. J.—Capital \$50,000.

NEW AGENCIES ESTABLISHED.

Peerless, Stoddard-Dayton, Birmingham, Ala.—Drennen & Company, Avenue C and Twentieth street. Manager of automobile department, George B. Kelly; manager of mechanical department, A. D. Wood.

Detroit Electric, Boston.—Messrs. Rommelfanger and Binney, 323 Columbus avenue, trading as the Boston Electric Garage.

American Simplex, New York City.—Grant-Isbell Auto Company, 1666 Broadway; Ben W. Rickert, sales manager.

Hupmobile, Baltimore, Md.—Joseph Weisenfeld, in addition to the Oakland.

Lozler, Syracuse, N. Y.—The Amos-Pierce Auto Company, 215 James street.

Haynes, Rockford, Ill.—H. R. Hill, for Winnebago county.

E. M. F., Morristown, N. J.—W. B. Smith

SELECTED AUTO PATENTS.

Issue of April 20, 1909.

918,550. Rubber Vehicle Tire.—Chester O. Henderson, Dayton, O. Filed Sept. 21, 1908.

918,607. Carbureter.—Clarence B. Sturges, Scranton, Pa. Filed April 22, 1907.

918,621. Change Speed and Reversing Gear.—Luis Wirtz, Bilston, Eng. Filed July 6, 1907.

918,644. Vehicle Wheel.—Lloyd W. Barnhart, Van Wert, O. Filed April 11, 1908.

918,657. Three-Speed Transmission Gearing.—Robert W. Coffee, Richmond, Va., assignor to Lewis M. Kelzer, Baltimore, Md. Filed May 16, 1906.

918,658. Power Transmission Gearing.—Robert W. Coffee, Richmond, Va., assignor to Lewis M. Kelzer, Baltimore, Md. Filed June 25, 1906.

918,679. Internal-Combustion Turbine.—Paul Krause, Babylon, N. Y. Filed Oct. 10, 1907.

918,846. Tire.—F. J. Gostlin and L. Mueller, Jr., Akron, O. Filed Feb. 5, 1907.

918,936. Transmission Gearing.—Dixon E. Washington, Chicago. Filed March 26, 1908.

918,945. Wooden Rim Wheel.—Herman F. Ball, New York City, assignor to American Locomotive Company. Filed Aug. 27, 1908.

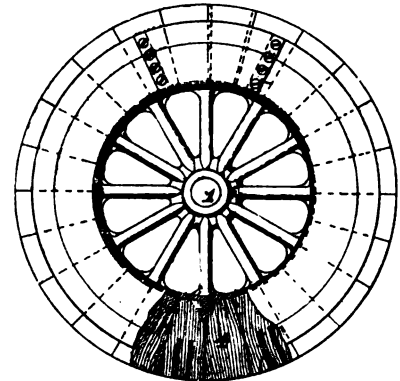

Ball's New Truck Wheel.

This wheel is more suitable for truck use than pleasure cars, and is doubtless intended to be tried upon the trucks now being brought out by this company. This is a subject that has been tackled before and without success, so it is to be hoped that the present trial will not meet with the same fate as its predecessors. For heavy truck tires, the solid rubber tire represents too high a depreciation figure, hence the various attempts to replace it with something less expensive, of which this is one.

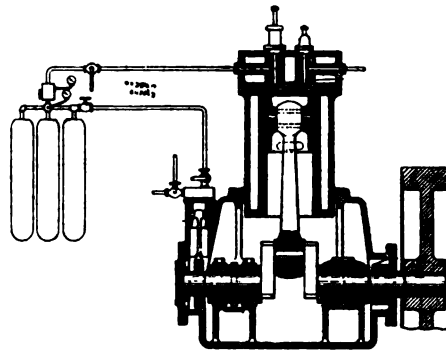

Sabathe Improved Cycle Scheme.

918,680. Emergency Stop for Motor Vehicles.—Paul Krause, Babylon, N. Y. Filed Nov. 12, 1907.

918,704. Internal Combustion Engine.—Louis G. Sabathe, Paris. Filed Aug. 30, 1906.

As the cut shows, this inventor is endeavoring to improve upon the process followed out in the ordinary engine. He does this by introducing into the cycle a portion of the compressed burned products, simultaneous with the injection of fuel, and followed by the introduction of a gas capable of supporting combustion. The arrangement is certainly a complicated one.

918,726. Spark Plug.—Franz Barthl, Far Rockaway, N. Y. Filed Aug. 12, 1907.

918,820. Tire for Vehicles.—David P. Boyd, Toledo, O. Filed Nov. 23, 1907.

918,987. Shock-Absorbing Device for Vehicles.—Claud H. Foster, Cleveland, O. Filed Jan. 21, 1907.

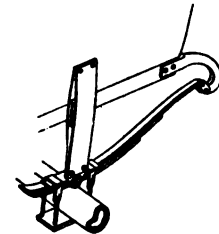

Foster Shock Absorber.

Foster's various inventions are all good, and the appearance of the latest seems to imply that it is good, too. It has been on the market for some time, so will not be described in detail. A pair of tapering side plates carry between them a sliding member which is attached to the car. The rise and fall of the sliders is resisted by the taper sides of the fixed member.

918,996. Cage for Ball Bearings.—Ernest Geshke, Charlottenburg, Berlin, Germany. Filed Nov. 20, 1907.

919,101. Clutch Mechanism.—C. L. Whaley, Augusta, Ga. Filed Dec. 14, 1907.

919,104. Valve Actuating Mechanism for Explosive Engines.—Alex. Winton and Harold B. Anderson, Cleveland, assignors to Winton Motor Carriage Company, Cleveland. Filed Sept. 8, 1908.

919,123. Spark Plug.—J. W. Brown, Jr., Camden, Ark. Filed Sept. 23, 1908.

919,174. Combined Turbine and Internal Combustion Engine.—John Hutchins, Moorfields, London, Eng. Filed Jan. 22, 1907.

919,276. Spark Plug.—Theodor Winestock, Stuttgart, Germany, assignor to Otto Charles Winestock, Perkinsville, Vt. Filed April 30, 1908.

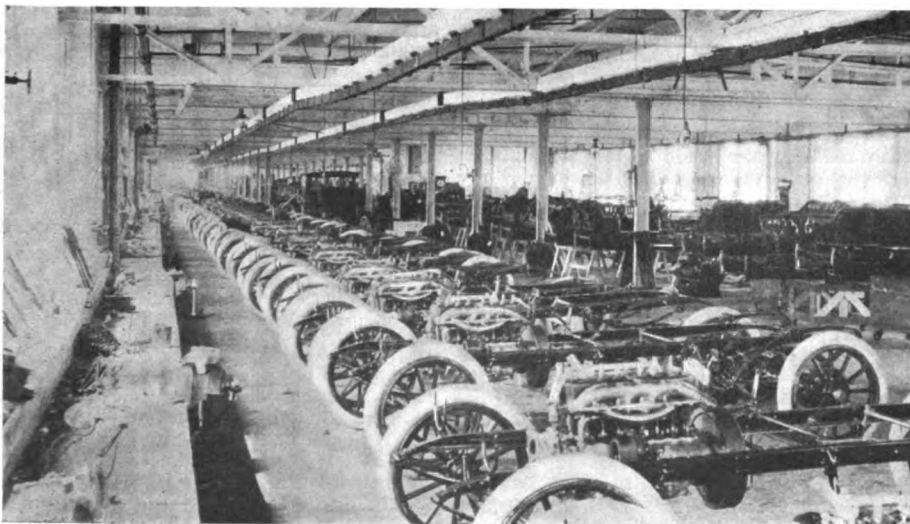

Assembling Department of the E-M-F Factory Showing Completed Cars.

Information for Auto Users

An Indestructible Wrench.—The increased demand for socket wrenches has brought out a number of high-grade devices of merit. Chief among these is the product of the Rex Wrench Company, of Boston. This is a drop-forged article of such workmanship and material that the makers warrant every part of it against ordinary breakage and actually replace parts which break. The work-

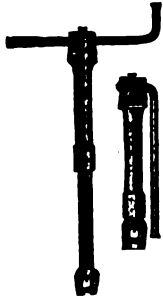

REX WRENCH HANDLE.

ing parts of the handle and the fork heads are drop-forged from a high carbon steel, and are case hardened. The sockets are steel castings by a new process that renders them very tough, so much so as to be unbreakable. In addition, a patented, telescopic, reversible handle may be had if desired.

As put on the market, the wrenches are in sets, varying from eight socket heads upward as high as one wishes to



A SET OF REX WRENCHES.

go. For instance, a set for all purposes, and especially adapted for motor boats, motors, and complicated machinery, is put out in a handsome oak box, at \$12. This set consists of the patent handle, screw driver, eleven fork heads, and eight hex socket heads. This will take all nuts, bolts, and cap screws, whether square or hexagon, from $\frac{1}{4}$ inch up to $\frac{3}{8}$ inch. These are furnished with a blue mottle finish, but if nickel is desired, it may be had at a slight additional cost. The handle is worthy of special mention, being complete in itself, extended or closed by the pressure of the hand. The sockets may be adjusted to any position instantly, and may be taken apart with ease and speed. When so taken down, the length is reduced from 14 to 8 inches.

Stein Automobile Tires.—Several features are embodied in the clincher tires made by the Stein Double Cushion Tire Company, of Akron, Ohio. Among these are the absence of lugs, the quality of not creeping, and the formation of the clinch. The beads, instead of ending, as is general practice, with a space between them on the interior when in place upon a rim, in the Stein tire overlap, thus forming a double cushion for the tube, preventing the entrance of any water or dirt, and keeping the entire volume of the inner tube above the rim. The design is patented. The shoes have been thoroughly tested during three years of road work, and with their wrapped-tread construction have shown that the quality is of a high standard, nothing but the



STEIN DOUBLE CUSHION TIRE.

best of materials—old, fine, Para rubber and Sea Island cotton—being used. With the bead or clincher overlapping, the tube does not come into contact with the rim and, it is claimed, will not pinch or chafe, remaining naturally round. The strain is equally divided upon the walls. The valve stem holds the entire shoe in place, there being no lugs, but the system prevents the tire from creeping. Stein tires are made in all popular sizes, and will fit any clincher, detachable or universal rim.

Banker Wind Shield.—Spring, the windy season, is the time for wind shields, and motorists, now getting out their cars, will do well to consider this needful accessory. The Banker Wind Shield Co., Pittsburg, Pa., are out with an extra fine product in this line, consisting of the No. 1 shield, which is not divided, and No. 2, which is double folding. The latter is parted in the center, below the line of vision. There are no strips of metal across the center of the

shield. In their place the plate-glass is supported on shelves extending from the frame. The upper glass folds on strong, extra heavy, piano-type hinge, and is held in place by a special clamp, which, with the rubber buffers, prevents rattling. The glass is 1-4 inch thick and of French plate. The frame is made of a single piece of 7-8-inch stock, with a 3-8-inch groove. The glass sets in this on a channel-shaped rubber, without bolts or screws to fasten it. The rubber



BANKER NO. 2 WIND SHIELD.

and the absence of metal fastenings insures the total elimination of noise, heretofore a big objection in wind shields. All clamps, bolts, hinges and other metal parts are of brass, highly polished, in this way securing the distinctive appearance which discerning motorists seek after so eagerly. The telescoping tubes are of 3-4 and 5-8 inch tubing, which insures lightness and rigidity. They are fastened securely to the shield by a special clamp, so as to be held in a vertical or horizontal position as desired. Each end of the tubes is provided with a ball and socket joints with more rubber buffers to prevent rattling. All wood used in the construction is of selected stock, either of mahogany or walnut, as desired. This is given an extra fine piano finish. It can be fitted to any car. Being very simple, this is the work of but a minute.

Yemco Quick-Adjustable Wrench.—Wrenches that can be operated by automobilists when in inaccessible places about a car are exceedingly handy. The York Electric & Machine Company, of York, Pa., has been marketing successfully in recent years the Yemco wrench, which can be used with one hand simply

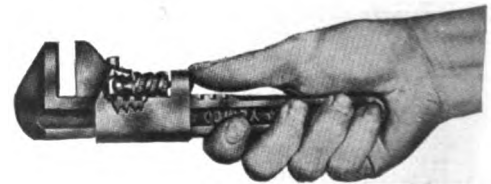

YEMCO WRENCH LOOKS LIKE ANY OTHER.

by pushing a little pin in the sliding jaw. Its appearance is similar to that of any other wrench, 8 inches long, made of dropped-forged, case-hardened steel, and it can be moved to any hundredth of an inch and will hold at that point without further manipulation. In using it, the jaw is pushed up with the thumb, first slipping the jaws open, hooking one over the nut, push up the other one and releasing the pin.

Marble System of Vulcanizers.—A method of repairing automobile and other pneumatic tires that is entirely different from any other now in vogue is that of the Marble system, manufactured by the M. E. Haywood Manufacturing

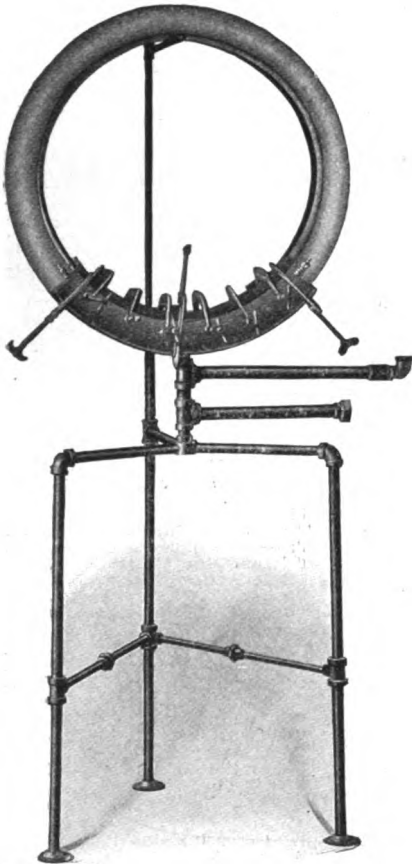

MARBLE VULCANIZER READY FOR USE.

Company, of Indianapolis. The principle is that of local application, heating only the part of the tire that needs curing, so that the remainder is not liable to deteriorate. If a tread is to be put on, only the raw material going into it is heated, and the bead and side walls are scarcely warmed. The plant is composed of the following parts: three inside patch vulcanizers, by which a broken shoe is repaired from the inner side and becomes stronger; three retreading vulcanizers, suited for tires ranging in size from 28 by 2½ inches to 36 by 5, taking up one-third of the circumference of the tread; one side wall and rim cut vulcanizer, which applies the heat and pressure directly to the parts to be cured, such as torn beads and sides; one tube arm, which will accommodate at least twelve tubes at once, clamped under pressure; one motorcycle vulcanizer for motorcycle tires; two patching vulcanizers for all size tires and taking up to 20 inches in length; one tread roller, to roll stock under greater pressure than by hand; complete frame of piping with globe valves and steam gauge, serving also as a steam line; and pads, clamps and complete sets of tools. This outfit enables a small dealer to have a complete tire repairing plant in a unit.

Permanit for Healing Punctures.—A preparation which may be placed in tires to heal punctures and prevent porosity is being imported by the Adolf Karl

Company, Inc., of Newark, N. J., and is sold under the name of Permanit. According to the officials of the firm, this material is a powder, there being no liquid form to fill the valve, and when a nail or something else sharp forces through the casing and tube, the powder acts to fill the space and prevent deflation. It can be used in any size tire, from that of a bicycle to the largest ones for automobiles, and numerous letters of commendation of it are received.

Universal Auto-Tire Remover.—This is more of a time saver than anything else. It does away with the use of a hammer in removing tires, thereby protecting and keeping in good condition rims, tubes, casings, fingers, and tempers. Being very simple, any one may use it. The natural strength of the tool makes it impossible to break it. Being easily adjusted, it can be made to fit any size tire or rim. The principle upon which it works is that of the compound lever. It is made in San Francisco.

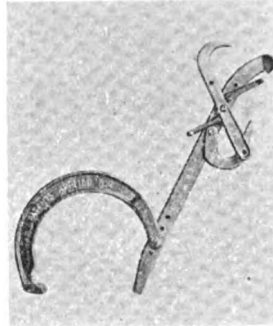

AUTO-TIRE REMOVER.

Borbein's New Roadsters.—A new model of roadsters, ready for the power plant, is being built by the Borbein Auto Company, of St. Louis. The running gear and body are sold complete, the purchasers having only to install the motor and transmission and supply tires. The latest type is made with seats for four, all set low to increase ease of riding, with high cushions and upholstered with dark-green leather. The front seat is divided and has a metal shield from the rear of the dash to the front of the rear seat. The rear seat, wide enough for two passengers, is not divided, making the complete body a surrey in style.

The front axle is of the I-beam type, 2¾ inches high, with annular ball-bearing spindles; the rear axle is of the floating type for shaft drive, with its gears in the ratio of 2½ to 1. Both internal and external brakes are furnished; the wheel base is 120 inches, and the tread standard 56. The artillery wheels are fitted with quick detachable rims for 34 by 4-inch tires. Reinforced metal fenders and running board are all fastened in place. The car is designed to take a

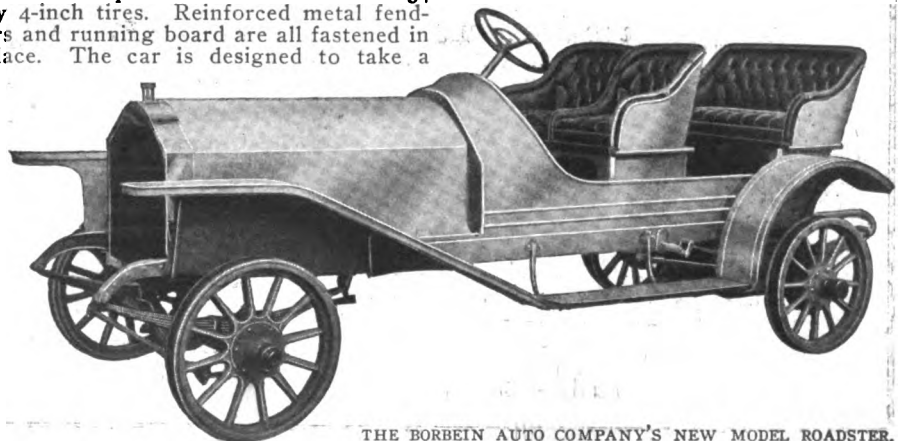

THE BORBEIN AUTO COMPANY'S NEW MODEL ROADSTER.

four-cylinder engine of medium size and any type of transmission; sold with one coat of lead paint, and including radiator, hood and steering gear. The Borbein Company builds all styles of running gears, bodies, axles and wheels.

Steering-Wheel Switch.—The awkward reaching for the switch on the dash or under the seat will soon be a thing of the past, if autoists appreciate the device just brought out to dispense with that. It is no more nor less than a properly designed switch, intended to go on the steering wheel and be operated in that position by the driver, without other movement than that of the fingers. It is intended to go on the right hand, underside of the wheel.

Four positions are provided as follows: Off, battery, magneto, magneto and battery together. The latter allows

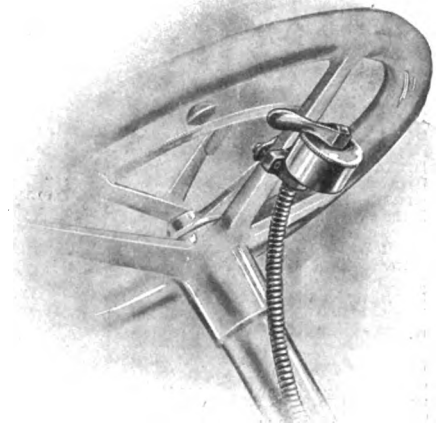

CONNECTICUT STEERING WHEEL SWITCH.

of its use on cars with two separate ignition systems, and is no hindrance on cars with a single system. The size is small, being but one and a half inches in diameter. It is entirely waterproof, and dustproof as well. The construction is of a high class, being entirely of brass. The method of fastening is by means of a bracket under one of the arms. The controlling lever may be removed at will, making the car safe from interference during the driver's absence. There are but two wires used and these are encased in a flexible brass tubing, through which they pass to the magneto and battery.

It is manufactured by the Conn. Telephone & Electric Co., Meriden, Conn.

INDEX TO ADVERTISERS

Abendroth & Root Mfg. Co. 58
Acetylene Gas Illuminating Co. 57
Acme Motor Car Co. 58
Adams Co. 58
Air Tight Steel Tank Co. 68
Ajax-Grieb Rubber Co. 78
Aluminum Foundry Co. 60
American Motor Car Co. 32
American Motor Car Sales Co. 96
Anderson Carriage Co. 71
Anderson Forge & Machine Co. 60
Atwater-Kent Mfg. Works. 58
Atwood-Castle Mfg. Co. Cover
Austin Automobile Co. 103
Autocar Co. 106
Auto Car Mfg. Co. 92
Auto & Supply Mfg. Co. 57
Babcock Electric Carriage Co. 85
Badger Brass Mfg. Co. 64
Baker Mfg. Co. 66
Baldwin Chain & Mfg. Co. 60
Billings & Spencer Co. 56
BI-Motor Equipment Co. 58
Black Mfg. Co. 76
Bliss-Chester Co. 57
Bongartz Co. 84
Born Scrymser Co. 65
Bosch Magneto Co. Cover
Boston Auto Gage Co. 57
Bowser & Co., S. F. 68
Boyle & Co., John. 74
Bretz, J. S. 104
Brown Co. 73
Brown & Co., S. N. 59
Brunnell Motor Co., F. A. 60
Brush Runabout Co. 98
Buckeye Jack Mfg. Co. 62
Buckeye Mfg. Co. 92
Buffalo Specialty Co. 85
Buffalo Electric Vulcanizer Co. 56
Buob & Scheu. 59
Burnett-Compound-Spring Co. 77
Burr Mfg. Co. 89
Byrne-Kingston Co. 95
Cadillac Motor Car Co. 58
Cameron Motor Co. 67
Canton Drop Forging Co. 60
Carter Car Co. 82
Chadwick Engineering Works. 65
Chelsea Clock Co. Cover
Cleanola Co. 65
Cleveland Puncture Proof Tire Co. 75
Conn. Tel. & Elec. Co. 91
Coes Wrench Co. 49
Continental Caoutchouc Co. 59
Continental Motor Mfg. Co. 62
Cook's Sons, Adam. 74
Corbin Motor Vehicle Corp. 81
Corcoran Lamp Co. 70
Cornish Friedberg Motor Co. 58
Correspondence School of Motor Car Practice 56
Covert Motor Vehicle Co. 58
Crane Puller 57
Cullman Wheel Co. 60
Dow Tire Co. 73
Driggs-Seabury Ordnance Corp. 67
Duplex Co. 60
Duplex Coil Co. 62
Echo Horn Co. 75
Edmund & Jones Mfg. Co. 62
Eldredge Electric Mfg. Co. 57
Empire Automobile Tire Co. 69
Enamelac Varnish Co. 62
Everett-Metzger-Flanders Co. 81
Excelsior Supply Co. 63
Excelsior Tire Co. 56
Ferro Mach. & Foundry Co. 108
Firestone Tire & Rubber Co. 66
Fish, Geo. L. 89
Flisk Rubber Co. 88
Flentje, Ernst 80
Fort Pitt Motor Car Co. 58
Franklin Mfg. Co., H. H. 83
Fried-Ostermann Co. 76
G. & J. Tire Co. 67
Gabriel Horn Mfg. Co. 85
Gaeth Automobile Co. 82
Gearless Motor Car Co. 58
Goodrich Co., B. F. 70
Goodyear Tire & Rubber Co. 75
Gramm-Logan Motor Car Co. 58
Grossman Co., Emil. 88
Grout Automobile Co. 97
Hall Lamp Co. 79
Ham Mfg. Co., C. T. 57
Hardy Co., R. E. 70
Harris Oil Co. 88
Hart-Kraft Motor Co. 102
Hartford Suspension Co. 75
Haws, Geo. A. 81
Haynes Automobile Co. 63
Helnze Electric Co. 76
Hemmeter Spark Plug Co. 66
Henricks Novelty Co. 60
Herschell-Spillman Co. 60
Herz & Co. 59
Hess-Bright Co. 60
Hill Dryer Co. 62
Hoffecker Co. 77
Hoffman, Geo. W. 57
Holtzer-Cabot Electric Co. 81
Hotel Woodstock 70
Howard Motor Works. 58
Hoyt Electrical Ins. Works. 59
Indestructible Steel Wheel Co. 60
Interstate Automobile Co. 82
Jackson Automobile Co. 58
Jeffery & Co., Thomas B. 109
Jewell Motor Car Co. 69
K.-W. Ignition Co. 74
Karl Co., Adolph. 57
Kemzite 99
Keystone Lubricating Co. Cover
Kimball Tire Case Co. 63
King Top Mfg. Co. 59
Kissell Motor Car Co. 33
Knox Auto Co. 79
Konigsloew, Otto 60
Lansing Wheelbarrow Co. 76
Larchmont Mfg. Co. 57
Leather Tire Goods Co. 59
Lehman Mfg. Co., J. H. 57
Leland Co., W. H. 75
Lexington Motor Car Co. 98
Life Publishing Co. 57
Lipman Mfg. Co. 65
Lobe Pump & Machinery Co. 65
Locomotive Co. of America. 58
Long Arm System Co. 11
Long Mfg. Co. 80
Loring Appliance Co. 57
Lucas & Co., John. 58
M. & E. Mfg. Co. 80
Maple City Mfg. Co. 62
Masury & Son, John W. 35
Matheson Automobile Co. 90
McCue Co. 101
Merrill Mfg. Co. 74
Metz, Chas. H. 82
Michelin Tire Co. 59
Midland Motor Car Co. 83
Miller, Chas. E. 90
Mitchell Motor Car Co. 82
Model Automobile Co. 82
Moline Automobile Co. 81
Moon Motor Car Co. 58
Moore, V. M. 67
Morgan & Wright. 94
Morrison-Riker Mfg. Co. 102
Mosler & Co., A. R. 87
Moss Photo Engraving Co. 86
Motor Car Equip. Co. 84-82
Motz Clincher Tire & Rub. Co. 59
Muttly Co., L. J. 59
N. Y. Sporting Goods Co. 62
N. Y. & N. J. Lubricant Co. 85
National Brake & Clutch Co. 60
National Motor Vehicle Co. 86
National Tube Co. 74
New Departure Mfg. Co. 100
New Process Rawhide Co. 74
Nightingale Whistle Mfg. Co. 89
Nonkoroda Co. 56
Nordyke & Marmon Co. 94
Nuttall Co., R. D. 60
Oakland Motor Car Co. 83
Olds Motor Works. 58
Orange Machine & Mfg. Co. 76
Outlook 52-53
Owen & Co., R. M. 59
Packard Electric Co. 77
Packard Motor Car Co. 111
Palmer & Singer Mfg. Co. 59
Pantasote Co. 59
Parish & Bingham. 60
Parker, Stearns & Co. 59
Peerless Specialty Co. 84
Pennsylvania Auto Motor Co. 83
Petrel Motor Car Co. 68
Peugeot Freres 60
Portland Garage Co. 62
Post & Lester Co. 76
Prest-O-Lite Co. 87
Prosser & Sons, Thos. 65
Puritan Gas Tank Co. 66
Quincy-Manchester-Sargent Co. 63
Quride Co. 60
Raimes & Co. 57
Remy Electric Co. 57
Randall-Falchney Co. 95
Republic Rubber Co. 59
Reynolds, Harry H. 71
Robert Instrument Co. 57
Robinsons & Sons Co. 63
Rockwood Mfg. Co. 70
Rome-Turney Radiator Co. 77
Royal Equipment Co. 81-57
Rushmore Dynamo Works. 96-97
S. M. Supply Co. 80
Salsbury Wheel & Mfg. Co. 57
Schenectady Spark Plug Co. 65
Schrader's Sons, A. 57
Schubert Bros. Gear Co. 59
Selden Motor Vehicle Co. 82
Shaler Co., C. A. 100
Sireno Co. 57
Skinner & Skinner. 63
Smith Mfg. Co., I. J. 68
Spacke Machine Co., F. W. 86
Spare Motor Wheel of America. 80
Speed Changing Pulley Co. 75
Speedwell Motor Car Co. 80
Spicer Universal Joint Mfg. Co. 62
Spittdorf, C. F. 76
Sprague Umbrella Co. 83
St. Louis Supplementary Spiral Spring Co. 92
Standard Co. 62
Standard Roller Bearing Co. 80
Standard Sales Co. 57
Standard Sheet Metal Co. 73
Standard Welding Co. 66
Stanley & Patterson. 69
Star Speedometer Co. 105
Stearns Co., F. B. 83
Stein Double Cushion Tire Co. 70
Stevens-Duryea Co. 98
Stewart & Clark Mfg. Co. 61
Stitch-In-Time Vulcanizer Co. 71
Stromberg Motor Device Co. Cover
Studebaker Automobile Co. 81
Swinehart Clincher Tire Co. 76
Syracuse Alum. & Bronze Co. 60
Syracuse Chemical Fire Extinguisher Co. 66-73
Thomas Motor Co., E. R. 81
Timken Roller Bearing Axle Co. 92
Tiresele Mfg. Co. 66
Tray Plate Battery Co. 75
Trenton Rubber Mfg. Co. 62
Trimont Mfg. Co. 65
Triple Action Spring Co. 74
Tucker, C. F. 57
Tudor Mfg. Co. 77
Uncas Specialty Co. 62
Underwood Typewriter Co. 73
Universal Tire Protector Co. 74
Van Wagner Mfg. Co., E. B. 60
Veeder Mfg. Co. 90
Velle Motor Vehicle Co. 92
Victor Clutch Compound Co. 60
Victor Tire Traction Co. 77
Volcano Spark Plug Co. 73
W. D. Spring Cushion Tire Co. 80
Waban Webbing Co. 63
Warner Instrument Co. 92
Western Motor Co. 73
Weed Chain Tire Grip. 77
Weston Elec. Instrument Co. 69
Wheeler & Schebler 107
White Co. 110
Whitlock Coll Pipe Co. 65
Whitney Mfg. Co. 66
Widmer Machine Works, C. A. 75
Willard Storage Battery Co. 84
Willett Engine & Carbureter Co. 87
Winton Motor Carriage Co. 98
Witherbee Igniter Co. 57
Wyman & Gordon Co. 56
Xargil Mfg. Co. 75
York Motor Car Co. 71
Zimmerman Mfg. Co. 87

FOR UNMATCHABLE QUALITY BUY GOES STEEL HANDLE MODEL WRENCH
Coes New Auto Wrench
Sizes: 6-in. and 1 2-in
Special Features: Narrow Jaws Especially Made for Automobile Work Without Sacrificing Strength.
GOES WRENCH COMPANY, Worcester, Mass.

THE AUTOMOBILE



Told Thousands Auto's Universality

Upper Fifth Avenue

King Guy and Queen Annette

Upper Broadway

TELLING to thousands in a comprehensive and practical manner the varied uses to which the motor-driven vehicle is now put, the automobile parade in New York City, Monday afternoon, served as a public demonstration of value and attracted widespread interest. Postponed from the preceding Saturday, because of the inclement weather, the event was favored with an ideal Spring day. Though the number of cars in line—310—proved disappointing, the procession adequately illustrated how the automobile now figures in the transportation of all kinds of merchandise, as well as for the carriage of passengers, individually and collectively.

Beginning with the light delivery wagon, carrying a load of a thousand pounds, and ending with the heavy five-ton truck dragging a loaded trailer with two additional tons, the commercial section showed cars suitable for any service that the demands of business might require. The public service vehicle

had a good representation in taxicabs and twelve-passenger omnibuses, there being thirty of such vehicles in line.

Crowds Await the Parade Eagerly.—As early as 2 o'clock the sidewalks on both sides of Broadway were occupied by a thin line of spectators, and the numbers increased until there was hardly space for passage except by way of the street. Fifth avenue had its lines of spectators in considerable numbers, and it was estimated roughly that nearly 200,000 saw the parade

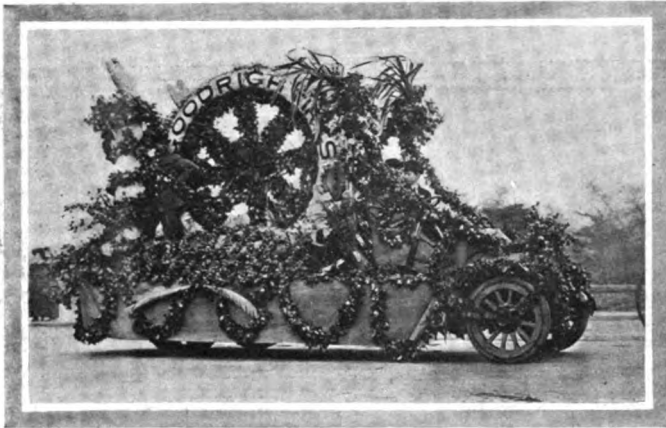

Goodrich Tires Were In Evidence In the Procession.



The Diamond Tire Float Was Well Designed and Chic.



Warner Auto-Meters Were Well Advertised as Usual.



Studebaker Closed Body Delivery Wagon In Parade.

from beginning to end. The crowds were thickest at Bretton Hall, on Broadway, where the coronation of King Guy and Queen Annette took place, and along Automobile Row, where noise-producing devices of all kinds served to pass away the time until the cars hove in sight.

Parade Delayed at the Start.—The coronation ceremony was delayed for a short time owing to the inability of King Guy to reach Bretton Hall on time because of difficulty experienced with the royal robes. Queen Annette was ready for the curtain bell. The coronation finally took place at 3 o'clock, General John T. Cutting performing the ceremony. There was little speech-making save a congratulatory address to the royal party on their popularity with the automobile public. The King and Queen then mounted their respective cars, and headed by a band of music started. Queen Annette, in a gown of shimmering green silk, rode in a Buick car, and had a throne in the shape of a seashell. The King's throne was mounted on a Stearns chassis and was bounteously decorated in red and gold. As the two floats passed up Broadway, the other cars swung into line from the side streets.

Historical and Racing Cars Form First Division.—The first division of the parade followed the royal cars and consisted of old models of well-known cars, and racing cars of the present day. Among the "old timers" was the 1893 model of the Haynes, running under its own power, and an ancient Columbia which was towed by an up-to-date car of the same make. The Grand Prix Benz racer and the Fiat Cyclone were also in line, the former being towed by reason of its inability to run as slow as the general pace required. A 1900 model Panhard, the Renault racer, and the hillclimb and straightaway winners were also in this division.

Many Makes of Cars Represented.—Following the historical and racing cars came the touring cars of present day models. There were attempts at decoration in the shape of American flags and bunting, and some of the cars were festooned with colored streamers and bombarded with confetti as they passed along Broadway. Taxicabs carrying crippled children from various institutions were included in this division, which numbered 230 cars. A number of foreign cars as well as the majority of American makes were represented, two of the former, the Nagant of Belgian manufacture and the Silent Knight Daimler being unfamiliar to the majority of spectators. The driver of the latter car was appropriately costumed in a suit of armor.

Decorated Cars the Feature of the Parade.—The decorated division was the third and the subject of much comment on all sides. Three cash prizes were offered in this division and twenty cars competed, all showing taste and ingenuity in their design. The Lozier car, with its body in the form of a horn of plenty and decorated with American Beauty roses and occupied by four beautiful women attired as Colonial Dames, was considered the most attractive and received the first prize of \$500. A representation of Cleopatra's barge, decorated with white flowers and mounted on an Oldsmobile, received the second prize. The third prize was awarded to a Matheson float decorated with red roses and occupied by girls in Pierette costume.

The grotesque cars created considerable amusement, especially the Desberon float representing Roosevelt on the prow of an airship with revolving propellor and surrounded by three men made up as African savages in the jungle. This float was awarded the first prize in the class. A Reo float, in the shape of a man-of-war and with a crew of negro sailors, took second prize in this division.

Michelin Float Makes Hit in the Commercial Division.—The commercial division brought out twenty cars of which three were awarded prizes. The float of the Michelin Tire Company made a decided hit and was accorded first prize, the Bibendum Twins on the elevated seat causing much laughter by their seemingly hilarious state. These figures represent the trademark of the Michelin Company. The Thermos float, built in the form of a bottle and apparently drawn by doves and driven by a young woman seated on the neck, mounted on an English Napier chassis, received second prize. The third prize in this division

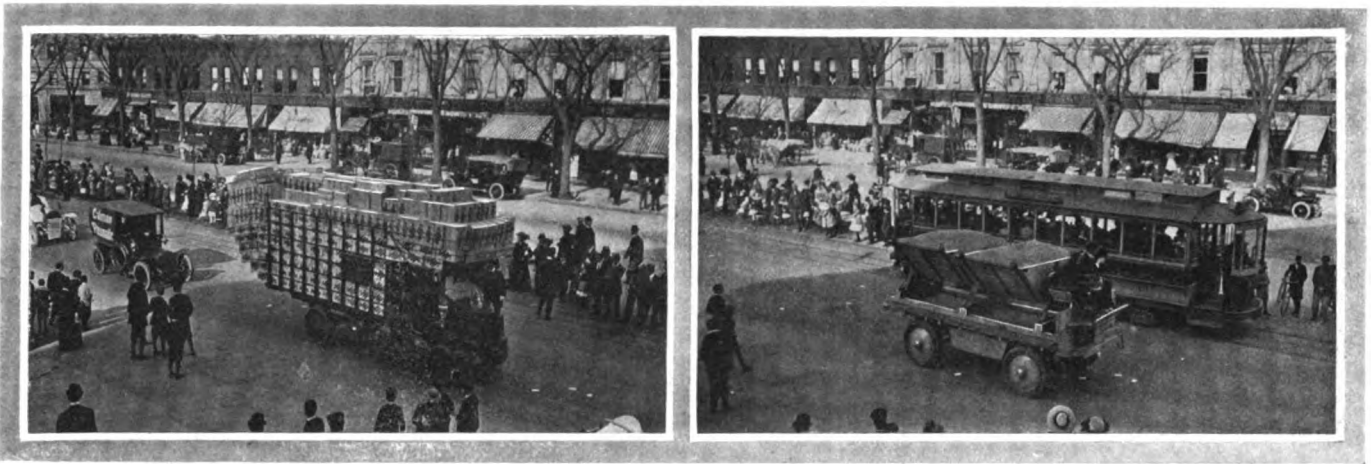

A Heavily-Loaded Packard Truck and Double-Tip Couple Gear Truck That Were Features of the Commercial Division.

went to the Matheson Trophy car, in which trophies won by Matheson cars were shown on a large stage finished in white with columns at the corners, and a golden throne on which was seated a girl at the rear of the float. The Goodrich float with its huge tire in the centre and garlands of flowers and leaves, was also much admired, and the calliope car with its air com-

Eighteenth street, returned down the other side of the street to Forty-eighth and thence crossed to Fifth avenue, which was traversed to One Hundred and Tenth street, where the cars were disbanded. The judges made their choice of the winners on the stand, and the results were carried to Carnival Headquarters by messengers, so that the prizes were immediately given.

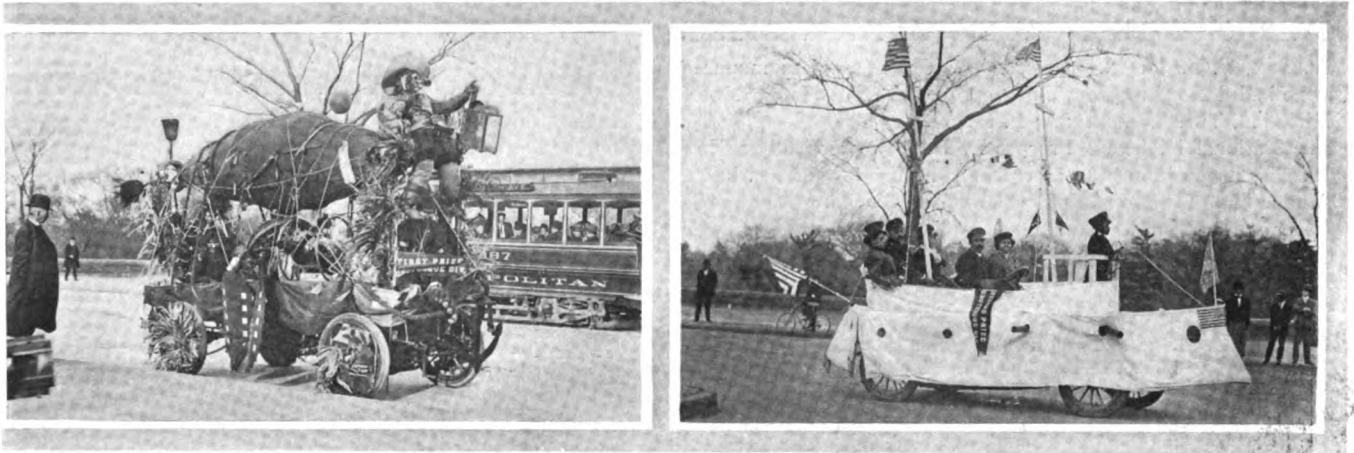

In the Grottesque Division "Teddy in Africa," and the Colored Marines in the Reo Warship, Were Leading Prize Winners.

pressing plant on a small trailer attracted attention by the music played at intervals along the route. The remainder of the sixty cars in this division consisted of trucks and delivery wagons, those of the daily papers making a good showing.

After the procession passed the reviewing stand at Ninety-second street and Broadway it continued to One Hundred and

One Gallon Efficiency Test to Be Held Friday.—The one gallon efficiency test postponed from Friday of last week will be held to-morrow (Friday). The results will be figured on a ton-mile basis. A radical cut in the fee, and the personal solicitation of entries by the interested and efficient committee, has resulted in a large increase in the number of entrants.



The Effective Tire Displays by Representative Manufacturers in the Commercial Division Showed Their Progressiveness.



The Michelin Bibendum Twins.



King Guy Sitting in State.



Matheson Float with Trophies.

QUESTION JAMAICA STRAIGHTAWAY COURSE.

According to a story printed in the New York *Globe*, Tuesday, the Hillside avenue course at Jamaica, L. I., was 235 feet short for the mile, and 270 feet short for the two-mile stretch. According to the *Globe* story, John Middletown, civil engineer of Brooklyn, in the presence of C. R. Hendricks, Ralph De Palma, and W. J. Morgan, measured the course and discovered the discrepancy. According to members of the committee in charge of last week's races, this measuring must have been started from the wrong mark. On this point they are very positive.

GOVERNOR HUGHES WILL GRANT A HEARING.

ALBANY, N. Y., May 5.—Governor Hughes this noon announced that he had decided to grant a hearing on the Allds-Hamm Motor Vehicle bill, Tuesday next, at 4 P. M.

The National Highways Prospective Society, practically a New York City proposition, was energetic in asking for the hearing.

A meeting of directors of the New York State Automobile Association has been called at Albany to-morrow (Friday). Automobilists will use their united influence in convincing the Governor that the proposed law exactly meets present needs.

AMERICAN LOCOMOTIVE JOINS A. L. A. M.

Announcement was made Wednesday of the admission of the American Locomotive Company to membership in the Association of Licensed Automobile Manufacturers. Included in the publicity matter from the A. L. A. M. is the following:

"That such an important company should acquire license under the Selden patent at this time is not only a matter of considerable interest, but perhaps very significant, inasmuch as the trial of test cases of the Selden patent, which is claimed to cover all gasoline automobiles now being commercially made, is about to be had in the United States Federal Court; the cases being on this month's calendar."

FLINT COMPANY BRINGS LICENSE SUIT.

Against several members of the Association of Licensed Automobile Manufacturers, the Flint Automobile Company, of Flint, Mich., Tuesday, began in the United States Circuit Court, Brooklyn, a suit for \$75,000 damages, alleging that it was prevented from conducting its operations because it refused to pay royalty on the Selden patent. Of course, many of the allegations by the plaintiff are repetitions of items in the litigation long pending.

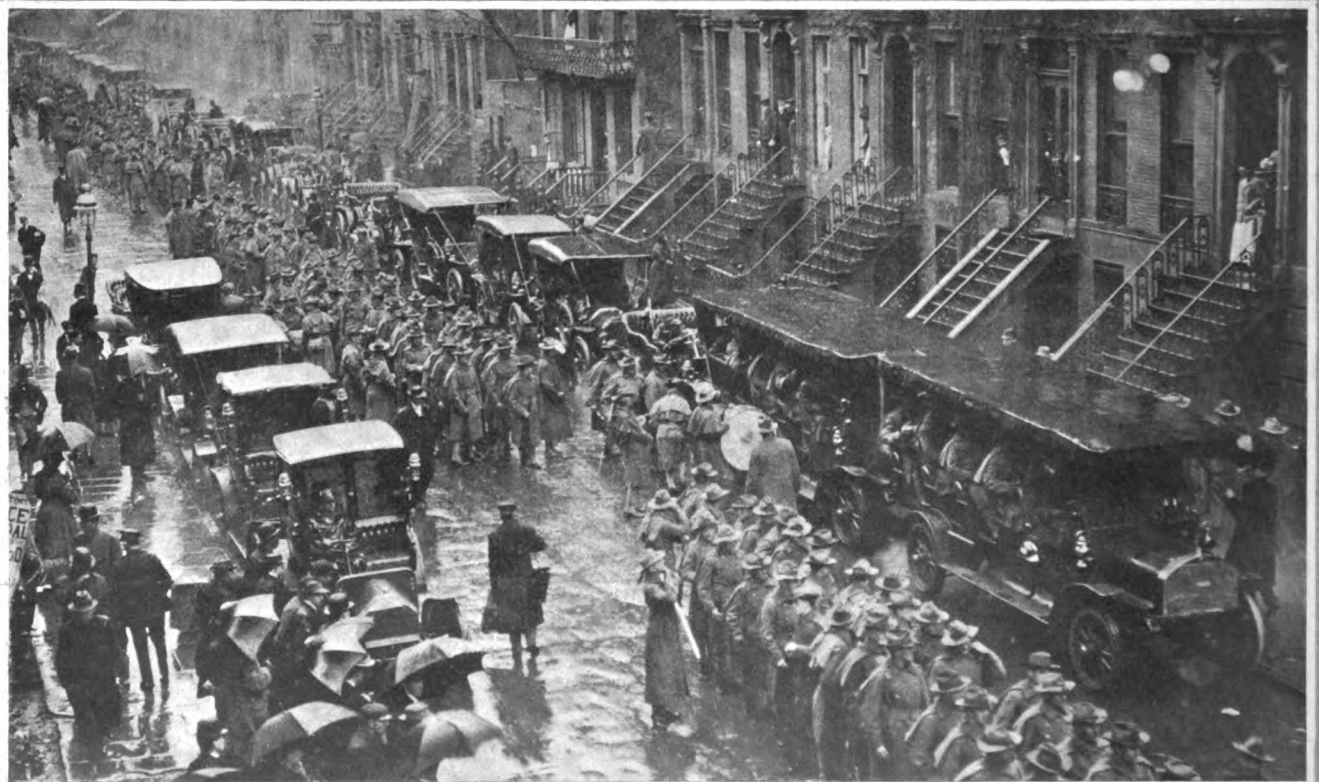

Beginning of the Abandoned Effort for the April 29 Military Demonstration Which the Rain Peremptorily Ended.



Arrival of the Endurance Contestants at the Nation's Capital, Coming Up Pennsylvania Avenue.

HARRISBURG, PA., May 6.—Historic and picturesque Pennsylvania and Maryland are this week the scene of a four-day reliability contest—the third of the Motor Club of Harrisburg. Valleys, hills and mountains are on the route of the 694 miles, with all possible road surface conditions, and coupled with rigorous rules and other requirements to thoroughly test those cars which are essaying the trip. The start was made Monday morning; distance, 153 miles, to the national capital, Washington, and interspersed with four checking stations. A return to Harrisburg occupied the second day, with four controls, and the route was entirely different from the outbound run, a length of 170 miles. A still longer route was that for Wednesday, following the Susquehanna Valley and then bearing eastward to Wilkes-Barre, 180 miles, for the night. The Pocono Mountains are being crossed to-day, in the final lap, the longest of them all—189 miles—back to Harrisburg.

As a contest, this one is thorough and exacting, the roads being the prime testers, and as the result of these and in connection with them come the rules and time schedule. Other runs have had more entries, and it was expected that the list would be larger, but the strenuous nature of the event probably discouraged participants. Fourteen cars started, and their drivers include those noted for success in affairs of this kind.

There are four trophies, one for each class, that for the large touring cars having been donated by Governor Edwin S. Stuart, who is an enthusiastic automobilist. That for the smaller ones was given by the Harrisburg Board of Trade, and of the two in the runabouts classes one is given by the Washington automobilists, known as the National Capital cup, and the other is the Harrisburg Patriot cup.

Chairman Becroft, of the technical committee, marshalled his forces early on Sunday afternoon, J. C. Kerrison, of Boston, and Mr. Wright, of this city, acting as his assistants, and the work of examining and sealing the cars commenced. Some few notations were made at the instance of the drivers as to parts or accessories on their cars, which, while doing the required work satisfactorily, would not class as perfect. Play in steering wheels was noted in degrees, and then the seals attached to coils, battery boxes, floor boards, hoods, and other parts of the cars through which work might be done. It afterwards developed that the seals were of little use, inasmuch as they were allowed to be broken at noon for oiling, or at any control, and during the remainder of the days the parts were unsealed. The committee was able to complete the examination by evening, and at a meeting held in the clubrooms the details of the event were explained to drivers, mechanics, observers, and mere tourists by Referee Johnston.

Regulations used in previous runs of the club had proven so satisfactory that with few alterations they were adopted for this year. Briefly, they included the following: A definite time schedule, with numerous intermediate checking stations; observers to report any work done for which there was a penalty, except that of oiling at stated times and places; a thorough technical examination. The remaining rules hinged mainly on these three. As an average the schedule called for between 18 and 20 miles per hour, with time lost in repairing tire troubles not taken out, but for unavoidable delays time was allowed. Penalties were inflicted for motor stops, except when filling with gasoline, or at the noon control, and if the motor was stopped momentarily, as by stalling, an easy start set aside any reason for penalty. For making adjustments two points per man per minute was inflicted, with five for broken seals. Herewith is the list of all cars, contesting and official, participating in the run:

CONTESTANTS.

CLASS A—TOURING CARS CATALOGUED AT \$2,250 AND OVER.

No.	Car.	H.P.	Cyl.	Piston	Bore.	Stroke.	Model.	Cyl.	Driver.
1.	Oldsmobile	60	4	3-4	4	3-4	Z	6	T. W. Berger.
2.	Pullman	40	5	5	1-4	M	4	4	R. L. Morton.
6.	Rambler	45	5	5	1-4	45	4	4	F. W. Darnstaedt.
8.	Maxwell	24-30	4	1-4	4	1-4	DA	4	C. E. Goldthwaite.
10.	White	40					M		Walter C. White.
11.	Thomas	40	3	5-8	4	5-16	6-40	6	M. R. Graupner.
12.	Franklin	28	4	1-4	4	D	4	4	C. S. Carris.

CLASS B—TOURING CARS CATALOGUED UNDER \$2,250.

4.	Pullman	30	4	1-2	4	1-2	K	4	A. B. Cocklin.
9.	White	20					O		W. B. Rheineck.

CLASS C—RUNABOUTS CATALOGUED AT \$2,000 AND OVER.

3.	Pullman	40	5	5	1-4	4-40	4	4	H. P. Hardisty.
15.	Peerless	50	4	7-8	5	1-2	25	6	Ed. Burnshaw.

CLASS D—RUNABOUTS CATALOGUED UNDER \$2,000.

5.	Pullman	20	3	3-4	3	3-4	L	4	J. G. Goodman.
7.	Middleby	25	4	4	4	D	4	4	E. B. Hume.
16.	Maxwell	24-30	4	1-4	4	1-4	K		J. E. Sellers.

OFFICIAL CARS.

	H.P.		
Pullman	40	Pilot	C. C. Cumber.
Pullman	30	Patrol	Watt Davis.
Stoddard-Dayton	45	Patrol	Cox Auto Co.
Oldsmobile	45	Chairman	C. R. Misner.
Rambler	32	Patrol	A. W. Bruhaker.
Pullman	40	Referee	W. Graupner.
Maxwell	24-30	Press Car.	A. Redmond.

THERE WERE PENALTIES ON THE FIRST DAY.

WASHINGTON, D. C., May 3.—As soon as the contestants were started from the public square in Harrisburg their troubles began, for there was a short run over the Susquehanna river bridges, a drop into mud, more mud, and deep holes. Penalties were bound to occur after a run of that character, and that there were as few as were recorded is evidence of sturdiness.

Six absolutely clean scores were placed on the official record in place of fourteen perfect ones when the morning began. Of the remaining eight, however, deliberation may change the marks against the cars, inasmuch as four have been announced as incomplete, such as those that were blocked, or took wrong roads, etc., while one car was withdrawn, and three penalized definitely. Walter C. White was one of those to suffer penalty, seven points being his share, five of which was for breaking the seal of his hood to examine a leaking water union and two points for the minute or less needed in which to tighten it. The Maxwell roadster turned a spring shackle, not a matter for concern in ordinary touring, but in a contest an occurrence for which two points is the price. The Thomas Light Six received 17 points, five for breaking the seal of the hood and the remainder for oiling when not in a control and for fixing a rod which is between the front goosenecks of the frame, broken en route. The car withdrawn is the small White touring car, which had a key on the rear axle shear off. This necessitated the replacement of the part, and some work, but the car arrived this evening, and will continue as a non-contestant.

Two hours and a half was the time allowed for the first control, that between Harrisburg and historic Gettysburg, a distance of 37.7 miles, made up of roads which could hardly be much worse and still be passable. When the tourists were not being precipitated into some puddle or hole they were standing up in the cars while passing over waterbreaks, so that the entire ride was a rough one.

The second lap of the day, from Gettysburg to the famous old town of Hagerstown, was 34.3 miles long, and the time called for was two hours, so that the average of 17 miles per hour gives an indication that allowance was being made for tedious work. The roads were not muddy as the autos approached the Mason and Dixon line; in fact, they were so dry that the dust was thick, but very rough, with a hard surface. To Frederick—always associated with Barbara Freitchie—from Hagerstown was 25.9 miles, and the schedule called for a time of 1 hour 25 minutes; then there was a stretch of 23.6, with an hour and a quarter given; and finally Washington, 31.7 miles, in 1 hour 40 minutes.

The National Capital road laws received a great deal of bitter and apparently well-deserved criticism from the members of the party, for not only are the speed limits extra low, but the drivers of wagons have no conception of the meaning of "keep to the right," nor do the people seem to care whether they are walking on the street or the sidewalks. Three of the party were arrested for "speeding" at fourteen miles an hour.

SIX CLEAN SURVIVORS ON SECOND DAY.

HARRISBURG, PA., May 4.—The run was planned with the idea that Harrisburg should see more of the contestants than is usual, and so the city not only has start and finish, but also a night control en route. From Washington, D. C., to-day the cars returned, but by a different route. Baltimore, York and Lancaster were prominent points in the itinerary, and the roads were generally rough, with the exception of the stretches from the "City of Magnificent Distances" to Baltimore.

Roughness and dustiness had little effect on the contestants, for of the three penalties inflicted only one involved a car which had a perfect score previously. Another minus mark went to a car with a low record against it. The Rambler, Middleby and Maxwell roadster were the sufferers. In the score announced at Washington there were four given as incomplete: Pullman roadster, driven by Hardisty, was set at 9 points for lateness; another Pullman, a small runabout, driven by Goodman, received 19 points for the same reason; the Rambler, which is slated at 735—241 for lateness and 494 for work done; and the Middleby, which was later set perfect.

The run of to-day has affected two of these: the Rambler, which is again given as incomplete, for a few adjustments were made to-day that may lead its driver to decide upon withdrawal rather than to carry a heavy handicap of points. The Middleby had not arrived at a late hour, and so is put down as incomplete

again. The Maxwell roadster had an exciting experience, and for work done there is a penalty of 56 points, while its time record had not been calculated completely.

As a result of two days of touring there are three clean scores in class A, out of six starters; two clean in class B, out of three; one clean in class C, out of two at the beginning, and there is none clean in the small runabout class.

Oldsmobile, Franklin; Pullman touring car, driven by Morton; Pullman touring, driven by Hardisty; Maxwell touring car, driven by Goldthwaite, and the Peerless roadster are perfect.

With no roadside troubles of moment, and just as little tire changes, there were two incidents happening en route to attract attention, aside from that of the beautiful scenery and the road conditions. One occurred to a Maxwell roadster, driven by J. E. Sellers, which met a man with two horses near York. One was being led and the other loose, and at just the critical moment the latter jumped across the road and was hit by the car. Sellers set his brakes, skidding the rear wheels, and from hitting the heavy animal and the road conditions the car turned upside down. The driver and observer were thrown free, the latter being stunned and the horse's left front leg was broken. The motor continued to run bottom side up, and when the car was righted, with the assistance of passengers in official cars, there was little damage apparent except bent fenders. The car proceeded, reaching this city somewhat late.

The Stoddard-Dayton touring car, which was carrying the checkers ahead of the run, scared a horse in Westminster, causing the animal to break a shaft and the top of the buggy to which it was attached. The driver of the car was held to await action for damages, as is usually the case happening to autoists whether they are to blame or not, and the checkers were taken on by Referee R. H. Johnston's six-cylinder Thomas.

The "Capital City" was left at 7 o'clock, with the day a beautiful one, and the ride to the outskirts of Baltimore was generally magnificent, as hard and smooth as a floor, with the few rough intervals being put into shape, so that the route will be one of the best examples of excellent road building in existence.

The Automobile Club of Maryland supplied box lunches and in other ways made the short stay extremely pleasant.

Cordial enthusiasm was shown between Baltimore and Harrisburg, many automobiles being parked along the country roadside, while other people drove to the route in carriages, and work was generally suspended in smaller towns. Hanover and other larger places turned out in force, while at Steelton the police force kept the paved streets clear while many of the drivers took advantage of a sign which read "Speed Limit, 95 Miles per Hour."

Herewith is the score at the second day's conclusion:

COMBINED SCORE FOR FIRST AND SECOND DAYS.

CLASS A.							
No.	Car.	Time.	Work.	Seals.	Oil.	Gas.	Water. Total.
1.	Oldsmobile	0	0	0	0	0	0
2.	Pullman	0	0	0	0	0	0
8.	Maxwell	0	0	0	0	0	0
12.	Franklin	0	0	0	0	0	0
10.	White	0	2	5	0	0	7
11.	Thomas	0	12	5	0	0	17
*6.	Rambler	241	494	0	0	0	735

*Second day penalties not yet computed.

CLASS B.								
No.	Car.	Time.	Work.	Seals.	Oil.	Gas.	Water. Total.	
4.	Pullman	0	0	0	0	0	0	
9.	White—Withdrawn,	continue as non-contestant.						0

CLASS C.							
No.	Car.	Time.	Work.	Seals.	Oil.	Gas.	Water. Total.
15.	Peerless	0	0	0	0	0	0
3.	Pullman	9	0	0	0	0	9

CLASS D.							
No.	Car.	Time.	Work.	Seals.	Oil.	Gas.	Water. Total.
7.	Middleby	0	0	0	0	0	0
5.	Pullman	19	0	0	0	0	19
16.	Maxwell*	0	58	0	0	0	58

*Second day penalties not yet computed. sturdiness of the cars.

WEDNESDAY REDUCES PERFECT SCORES.

SUNBURY, PA., May 5.—The first leg of to-day's course, 58 miles, reduced the number of perfect scores to three: Franklin, Peerless, Oldsmobile. All others are late. Roads are in terrible condition, as result of high water, and tire troubles are numerous.

"Andy" Auble, Oldsmobiler, wins Pittsburgh Endurance Race



Start from Hotel Schenley

PITTSBURGH, May 3.—For just one-half of the past week the automobilists of western Pennsylvania occupied the center of the stage. The "doings" consisted of an extremely well-fought "mud plug," officially known as an endurance run. This was planned by the *Chronicle-Telegraph* and the *Gazette-Times*. The dates first selected for the run were later changed in the hope that the muddy country roads would be in better condition. This was a delusion, for with the heavy rains which lasted nearly all the week conditions on many of the roads traveled could not have been worse. The extended preparations for the run, however, served to create tremendous enthusiasm all along the line, and there was not a town or village on the route which had not been fully advised of the event and which did not in some way show its appreciation of the honor.

The route lay over hilly, rough, and muddy cross-country roads, through the unsettled portions of eight counties surrounding Pittsburgh, beginning in a terrific rain and hail storm, and ending on the third day in a snowstorm, that was blinding in its ferocity.

Thirty-seven cars were entered, twenty-four started, and eleven finished. After the technical examination, not a single perfect score remained.

Pos.	Make.	Class.	Driver.	Time.	Penalties Rprrs. and Total Adjustm't
1	Oldsmobile	B	A. Auble	18	17.0 35.0
2	Knox	B	W. J. Murphy	63	.9 63.9
3	Premier	B	Ray F. McNamara	65	1.5 66.5
4	Oldsmobile	B	F. G. Folberth	70	1.2 71.2
5	Chalmers-Detroit	B	C. B. Lorimer	70	13.0 83.0
6	Packard	A	George F. Titlow	86	3.2 89.2
7	Peerless	A	O. E. Vestal	87	6.6 93.6
8	Franklin	B	C. S. Carris	102	.0 102.0
9	Corbin	B	W. C. Urling	257	25.9 282.9
10	Maxwell Roadster	D	C. E. Goldthwaite	302	17.9 319.9
11	Maxwell Baby	E	E. G. Gager	1013	2.6 1015.6

The run was divided into three days, starting from and finishing at the Hotel Schenley. A different route, laid out in a different direction, was pursued each day, with the cars operating under time limits. This meant penalties each day, in addition to which the referee and judges took the cars in hand after the close and went over them in search of replacements or repairs. The result of their search, added to the previous accumulations of trouble, gave the final standing. When this was announced joy reigned supreme in the Oldsmobile camp. Not only did "Andy" Auble, in Olds No. 11, win hands down, but Folberth, driving No. 12, edged in fourth. As this was the only make to have two cars finish, the adherents of it made "some" noise.

Some famous drivers were entered in the contest. C. E. Goldthwaite, who was in the Maxwell 10,000-mile non-stop contest, also drove a Maxwell in this run. "Perfect Score" Franklin Carris had to doff his plumes, for he was penalized 102 points. Earl Kiser, of racing fame, found it rather monotonous eating mud, but stuck to the game pluckily. The mighty Hans Wagner, without whom the Pittsburgh baseball team would be a sorry affair, entered his car for the run with explicit instructions to the driver that it should not be marred. It was ready for the paint shop at the end of the first day.

Assisting Referee Ferguson at the start were Drs. W. C. Cook and W. R. Stephens, the judges, and Chief Observer I. F. Bailey. Pilot E. W. Cole left at 5 o'clock in the morning in a Velie car provided by the Keystone Automobile Company. W. N. Murray, president of the Standard Automobile Company, in a Packard, handled the official car of the route.

From a social standpoint the endurance run was a great success and the newspaper management was warmly commended on all sides for the cordial way in which they helped along the making of acquaintances and the firmer bonding of old ties among the automobilists of western Pennsylvania. The dinner given by the newspapers to the contestants and their friends Tuesday evening was followed by a banquet to the contestants Friday evening. At the latter several of the city officials were present and experiences were "swapped" for several hours, over a choice menu that was evidently relished.

No serious accidents occurred on the run. Tire troubles and upsets, the latter due generally to ignorance of the routes, were the worst feature reported. On the second day out L. R. Lorimer, driver of a Chalmers-Detroit, demonstrated that "necessity is the mother of invention." When his tire gave out he bought a bushel of oats from a farmer, crammed the tire full, poured in a pail of water, laced it up and on the swollen grain rode 14 miles before he had to take to the bare rim again. At Washington, a Knox car, driven by W. J. Murphy, was struck by a street car and badly injured, but stayed in the contest. The Corbin, with unlucky "13" tied to it, had all kinds of trouble near Uniontown, but managed to get into running condition again. A country constable near New Castle was bent on showing his authority and caused the arrest of two drivers for speeding. They were promptly released after giving bail, and when the circumstances were explained to the higher authorities the constable's efforts went for naught.

WHY AUTO INDUSTRY DOES NOT RESEMBLE PREDECESSOR

By CHARLES CLIFTON, PRESIDENT A. L. A. M.

It is frequently remarked by those associated with the automobile business, as well as by comparatively unthinking laymen, that the automobile business will follow in the footsteps of the bicycle business. This statement is generally accepted as a sage prophecy, the unthinking prophet assuming to himself the virtue of wisdom. But the history of the rise and fall of the bicycle business will not be repeated in the automobile industry.

As one of those associated in the bicycle business, and conversant with the history of the transition from the bicycle to the automobile as a means of transportation, I have made a careful study of the problem and arrived at certain conclusions. The only common element of the two industries, aside from each representing a method of locomotion, arises from the fact that the early development of the automobile in a commercial way occurred at a time when the bicycle business, as a large industry turning out a popular product, had commenced to wane, its doom being plainly written. The situation was such that a large amount of capital, energy, producing and selling brains was rendered comparatively idle, and consequently those forces were logically attracted to the automobile business, which had alluring prospects and called apparently for the same essential elements. Thus several of the earlier bicycle makers were pioneers in automobile development; and many mechanics, theretofore engaged in the bicycle industry, being skillful in detail, have in minor capacities aided automobile development in either invention or shop practice. Naturally the automobile attracted to it a selling force, including bicycle dealers. The latter brought into the new industry a rich experience, which unfortunately too few of them realized to the fullest extent, particularly as to the proper function of adversity. Many of them transplanted lax business methods, extravagances and other undesirable phases. They were fond of referring to the new industry as a "game," as to a sporting event, or a hand at poker. Early the old selling methods began to show themselves in instalment sales and questionable methods of attracting and holding business. But in the new industry these elements were, naturally, short-lived.

Many people are prone to say that overproduction killed the old bicycle business. But if they would reflect on the decreased number of wheels in use, I think the answer is obvious. The bicycle was comparatively short-lived on account, in my judgment, of its own limitations. In its day it was regarded as a wonder of convenience in the solving of the essential transportation problem of how best to accomplish a given distance on common roads. It also had the fascination of a healthy outdoor exercise. But it always involved more or less hard work, more or less of the discomforts of the road, and always the limitation of the rider. It, moreover, did not admit of discrimination whereby the love of display, the superiority purchasable by money, or the essential comfort of the individual could be expressed.

As the result of the expenditure of an enormous amount of money and work by the American pioneer makers, nearly all of whom are members of the Association of Licensed Automobile Manufacturers, the automobile as a means of transportation has become a part of our national life. It is rapidly supplanting the older forms of individual mechanical locomotion; and will endure because it not only supplants, but far surpasses, anything of its kind we have ever known. It will not decline, but grow, because ever since civilized man has been obliged to move from place to place, for pleasure, convenience, or profit, he has had to use the horse, the mule, or the camel, with much limitation in point of distance and speed, and at all times with uncertainty. The new means of common road transportation is untiring and limitless. It has proven itself to be what the people want. It has individuality in form, and variety, and is built to suit any purse.

In the minds of thoughtful people, of those who think conservatively, the automobile as a means of conveyance has but one menace to its supremacy, and that is navigation of the air, which, if successfully accomplished as to safety and economy, will undoubtedly make the automobile in a way old-fashioned. But even when that day arrives, there will still be numberless people who prefer to be on the ground.

HOW MUCH DOES AUTO WEAR OUT ROADS?

By invitation of the executive committee of the American Automobile Association, Logan Waller Page, director of the U. S. Office of Public Roads, in the Department of Agriculture, was present at the meeting Tuesday at national headquarters, 437 Fifth avenue, New York City. The result was a decision to hold, probably in June, a series of severe tests to determine: First, just what damage the automobile does to the road surface; and, second, what will be the best measures in road building to prevent the breaking up of road surfaces from constant automobile traffic. Under the auspices of Director Page tentative tests of this character recently took place on a special road near Washington, controlled by the War Department.

"The object of the coming tests," said Mr. Page, "is to get at facts. So many theories have been advanced regarding the causes of road damage by motor cars and the best preparations to preserve these roads that it is high time to ascertain the real truth of the situation. At these tests all of the State Highway Commissions will be invited in addition to the County and local Highway Commissioners where the tests are held. An exhaustive report will then be made, which will be sent to all of the legislative bodies throughout the country and others interested in the good roads question."

The executive committee authorized the tests and referred the matter to the Good Roads Board, of which George C. Diehl, of Buffalo, is chairman. If satisfactory roads can be found, the test will be held in the vicinity of New York.

In the tentative specifications drawn up, it was agreed that there should be two stretches of macadam road, one about three

miles long, practically level and with as few curves as possible, while the other should be a road of a similar character about one mile long with a grade of about 6 per cent. Twelve automobiles will be used, four being light high-speed cars, preferably stripped for racing, four touring cars, and four heavy limousine cars.

In the opinion of the committee the trials should be made as follows: On a straight, level course, two miles from the start 400 yards should be measured off and an apparatus arranged for measuring the speed. At the beginning of these 400 yards four high-speed cameras will be stationed to take right angle pictures. A second station will be placed 100 feet farther on, and a third station at 200 feet. The cars will go over this 400-yard section at speeds of 5, 10, 15, 20, 25, and 30 miles per hour, and in regular increments of five miles increased until the maximum speeds are obtained. On the 6 per cent. grade the cars will go up the grade at maximum speeds and down a grade at approximately the same speed, coasting.

In addition, it is also proposed to hold a test over a road with the surface being bound by a dustless preparation.

At the executive committee meeting over which President Speare, of Boston, presided, there were present: Samuel A. Miles, N. A. A. M.; E. P. Chalfant, A. L. A. M.; Alfred Reeves, A. M. C. M. A.; W. E. Metzger, L. J. Powers, Jr., and Secretary F. H. Elliott.

The committee voted to recommend to A. A. A. clubs the week beginning June 1 for orphans' day outings.

The Hermitage Automobile Club, Nashville, Tenn., and the Tampa Automobile Club, Tampa, Fla., secured membership.

Automobile Gasoline and Other Available Fuel

BY THOS. J. FAY

Part IV

ORDINARILY, in view of the proneness of automobile gasoline to enter the cylinders in liquid form, the need of quite a length of tubing in the make-up of the carbureter manifold would seem to be an actual necessity. Since the gasoline enters the intake as a liquid, and since the amount of heat available in the air that enters, is not enough to assure vaporization, the greater the length of the manifold, within certain limits, the greater will be the chance of vaporizing the gasoline, since some heat will pass through the walls of the manifold, especially after the motor heats up, because some of the heat will be communicated to the entrained liquid in the mixture, while in the manifold. Then there is the problem involving the delivery of an equal weight of mixture to each of the cylinders; if the mixture is not a homogeneous gas there is small chance of delivering an equal weight of the same to the respective cylinders for the reason that the question of condensation, together with the mechanical separating out of the unvaporized gasoline, in a manner not likely to be uniform in the several cylinders.

In a measure, then, this question of a uniform weight of mixture to the respective cylinders cannot be brought about unless the mixture is free from gasoline in the liquid state. All that is

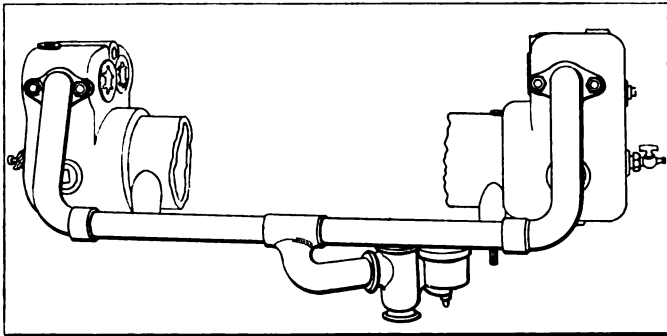

Fig. 11.—Good practice in manifolds for double-oppoed motors, showing connections on one side of motor for both cylinders.

wanted in the cylinders of a motor is a fixed amount of homogeneous mixture, the same for each of the cylinders, under like compression and fired at a common angle of advance. On the face of it the mixture must be made, and up to the standard, before it will be profitable to talk about its used and if it is not uniform, equality of distribution will be quite out of the question, so that on the whole the principle problem lies in the process of carburetion.

There Is a Story Connected with the Intake Manifolds.—

If the mixture from the carbureter is in the right proportion, and provided entrained gasoline is done away with, it becomes a question of the right distribution of the same to the respective cylinders. In a single-cylinder motor it would seem as if the problem would present itself in the most simple form, and such is the case provided the manifold is of adequate area, and if the hydraulic grade is toward the carbureter. That the manifold should be of some length seems to be a settled requirement, but there is a limit which must not be exceeded if it is true that motors must crank without much, if any, priming, and if the gasoline in the fuel is to be enough and uniformly provided.

In many cases, and in the past in some schools of design, it was assumed that the carbureter should be as near the cylinder as possible, and when the same was placed at a distance it was regarded as bad practice. The area of the manifold was generally increased with the hope that losses would be minimized,

but the results did not always show that the practice was a good one, and in the long run it was considered that the area should relate to the valve area, or better yet, to the piston displacement of the motor. Why this is true was not well stated, but experience has taught that the mixture is better when the conditions

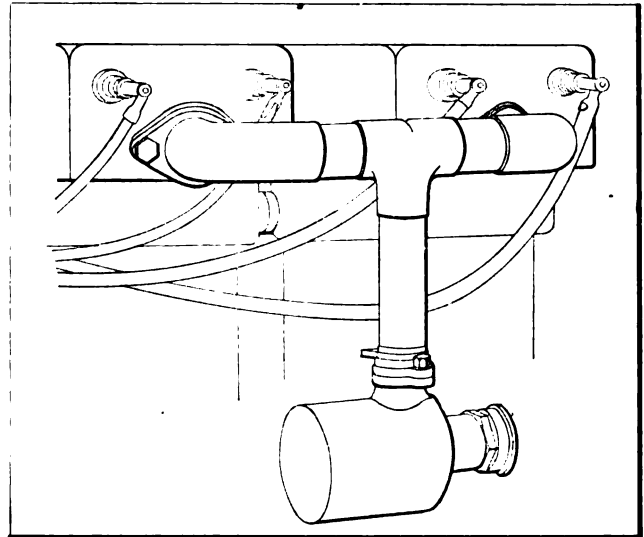

Fig. 12—Make-up manifold showing right-angle turns, involving a raiser and two branches.

that obtain take into account the lack of imperfect carbureter performance. In some cases it was the practice to consider that the intake manifold was really a part of the carbureter, in that vaporization must take place therein, if this important part of the performance does transpire outside of the motor cylinders, which is a moot question, in these days, due to the properties of automobile gasoline, considering the lack of volatility, as indicated by the boiling point of the same, which has been shown to be above the boiling point of water, for the most part.

That there is a happy medium, which depends upon the carbureter used, and the characteristics of the motor in each case is the one conclusion that would seem to stand the light of systematic investigation, and that the rules should not be applied too generally is also true. If, in a single-cylinder motor, the area of the manifold is one-quarter of the area of the piston, and if the length is four times the stroke of the same, it is then that the mixture will be allowed to rest in the manifold

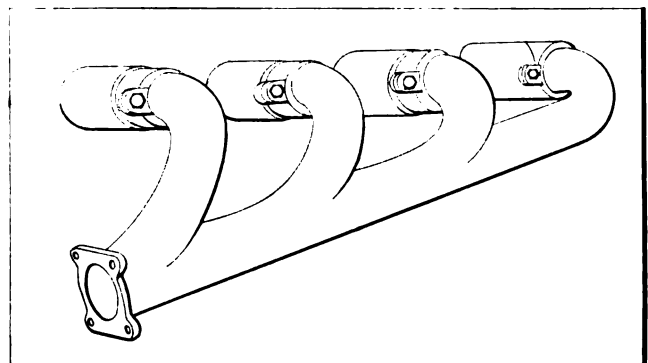

Fig. 13—Manifold so contrived to assure equal distances for all cylinder-ports from depression chamber in carbureter.

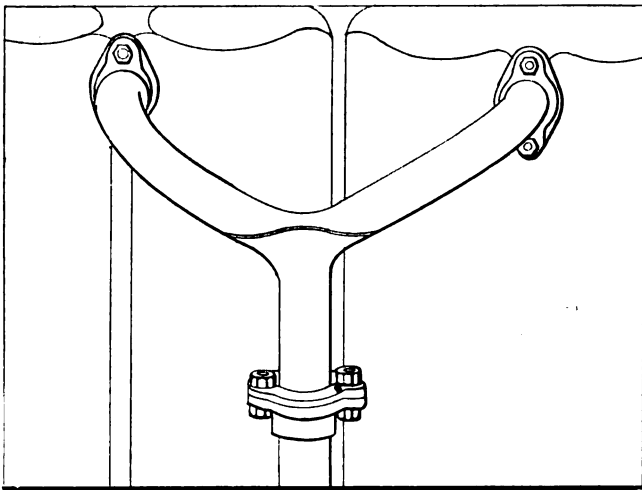

Fig. 14—Manifold of the Y class, with a long, slender raiser and easy bends at all points.

for a time equal to one complete cycle in a four-cycle motor. If the motor delivers maximum power at, say, 1,600 revolutions per minute, the mixture will be allowed to rest in the manifold for a period of time equal to:

$$t = \frac{S}{60 \times c} = \frac{1,600}{60 \times 4} = 6.6$$

when,

t = ratio of time that the mixture will lie in the manifold, considering a single-cylinder motor,

S = angular velocity of the crankshaft in revolutions per minute,
 c = cyclic period of the motor.

NOTE: During one-quarter of this time the mixture will be enroute to the cylinder, during which period the mixture will not actually lie still in the manifold.

In a single-cylinder motor it is not difficult to regulate the volume of the intake manifold in relation to the piston displacement, but when the number of cylinders are increased the problem becomes more complex. If the relation of the manifold to the piston displacement is not maintained, the torque of the motor may fall off as the speed increases, which is what happens, but not at the same point in the piston speed in all makes of motors. Fig. 11 is illustrative of fairly good practice in two-cylinder motor work, in which it will be observed that the intake is long and slender and the connections in the cylinders come in such a way that the distribution to the respective cylinders is about equal. That the distribution should be so is one of the points to be made, and it certainly is worth something to be able to readily remove the manifold if, in service, it becomes desirable to do so. In this example the hydraulic grade is greater than the net requirement, due to the desire to clear other parts of the motor; this is not necessarily a fault, and it may be that

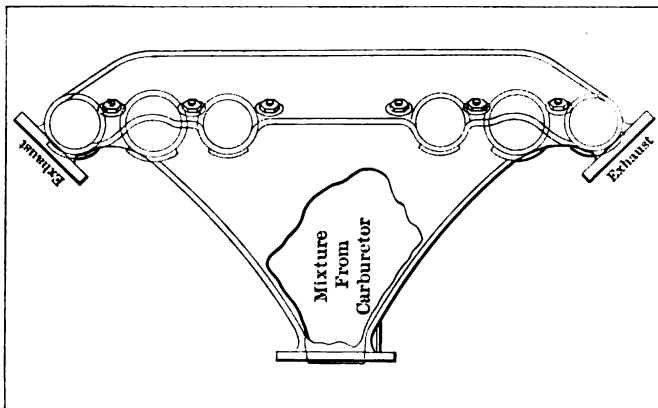

Fig. 15—Manifold of a box-like character, with provision to utilize exhaust heat.

it is an advantage to have the mixture travel through a vertical distance, with the hope that some of the entrained liquid will be weeded out by the gravitational process.

As the number of cylinders are increased, the practical applications become more diversified and there is one more point to be made in that the several methods in vogue seem to work, each in a way to satisfy the needs of the occasion, hence the only question is: Can the trend be picked out of the flock, and has it an upward tendency?

Some Methods in Vogue with Four Cylinders.—However light air may be, even so, it weighs something, and inertia has to be taken into account. When the stream of gas is in motion its tendency is to remain in motion, and to change direction, without suffering a detriment, requires that the conditions be right. The first principle of good designing has for its basis the form under which no change in direction will be required, but if it is the purpose to abandon this principle, then the wise plan will lie

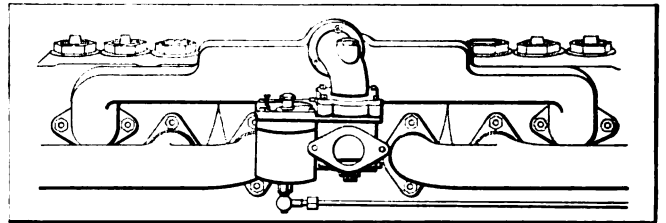

Fig. 16—Enlarged T-shaped manifold, with rather abrupt reductions in the lateral portions.

in having equal and opposite forces, so that the ills of the scheme will not be transferred to the motor.

Fig. 12 offers a plan in which the manifold for the intake is made up, and owing to the form of construction, the bends are right angles. This manifold consists of a raiser and two

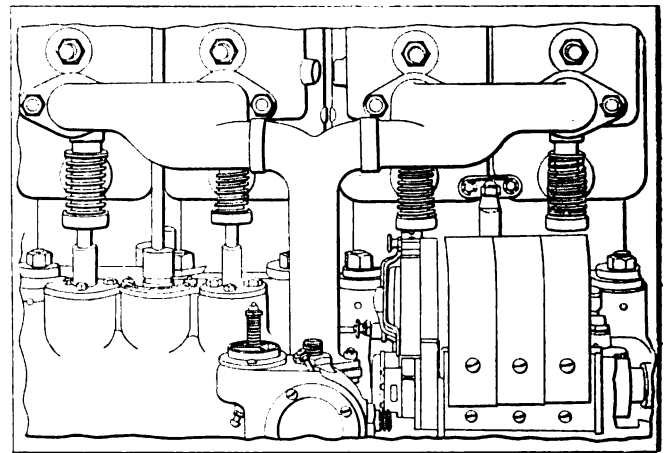

Fig. 17—Another manifold, differing in detail from that shown in Fig. 16, with easier bends from the raiser.

branches, each of which leads to twin cylinders. Considering the usual order of firing a four-cylinder motor, the gas will be sucked into each branch alternately, and that inertia will rob the mixture of its accustomed density is believed. The two arms of the manifold are horizontal and the result is that the hydraulic grade, that retards migration in the direction of the cylinders, is not taken advantage of.

As a refreshing diversion Fig. 13 is offered to utilize the benefits of a hydraulic grade, and tap the mixture off to the respective cylinders without changing its direction and to the extent possible, have all the cylinders the same distance from the carburetor. Considering "individual" cylinders, this manifold lends itself extremely well, and it will also look good when the casting is well made, which it can be, of aluminum.

If siamesed cylinders are used, the same result will be due to the use of a manifold as shown in Fig. 14, in that the carburetor is well below the valves of the motor and the Y is with long and

slender branches, emanating from the raiser, at a low point. If there is any trouble attached to this scheme, it may be traced to the ports, within the cylinders, rather than to the manifold. Still another plan is disclosed in Fig. 15, involving a Y-shaped manifold with a casting of a box-like character, possessing no dividing walls, excepting those which separate the mixture from the exhaust gases that enter a cored portion of the casting, near the cylinders, high up, for the purpose of aiding in the process of evaporation. In view of the large amount of gas that can be stored in the space afforded it is likely that benefits follow its use, although, in the absence of exhaust heat, the space might be regarded as excessive.

Fig. 16 shows still another way, in which the enlargement is

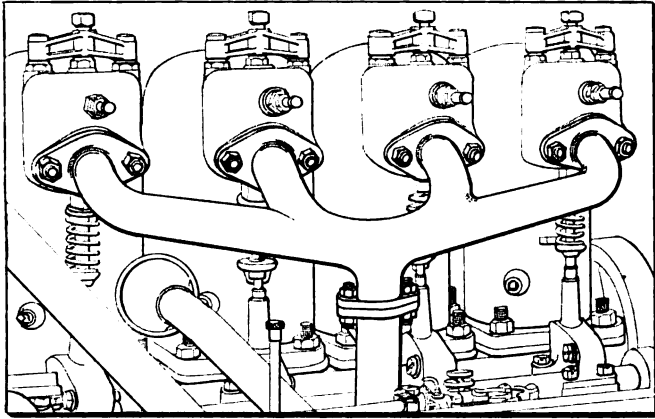

Fig. 18—Manifold for individual cylinders, on a four-cylinder motor, with easy bends, without change in direction of the mixture.

above the raiser although a part of it. This manifold is used on individual, four-cylinder motors, and it should be free from inertia trouble, even so there is danger of other complications in the absence of good carburetor work. This manifold does not offer a large surface for the transfer of heat, which is not a necessity if the carburetor is so devised that the mixture will be in the vapor state, free from entrained liquid. Fig. 17 is of another manifold that belongs to the same school, the only difference being that the enlargement is above the common level of

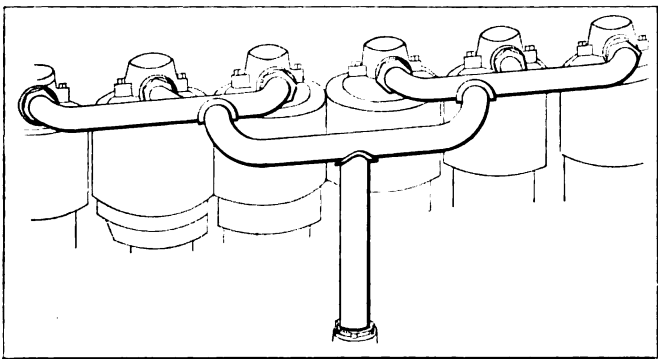

Fig. 19—Manifold for a "six" in which the gas must change direction, thus involving inertia, to some extent.

the portion that branches out to the cylinders. In this case the manifold is devised for six cylinders, and it seems to be a very good plan to get away from the troubles that attend the delivery of mixture to a "six." The hydraulic grade of the branches is not pronounced, but it is not always necessary to have the difference in level so very great. From the simple Y to Fig. 18 is but a step, probably right in that the mixture is not required to change direction, and a neat appearance attends the use of this class of manifolds.

When the plan, as shown in Fig. 18, is applied to a "six" it is not quite so handy, and it may be that it is attended by a certain amount of inefficiency. Fig. 19 is offered as illustrating the point to be made, and as will be observed, if gas inertia amounts to

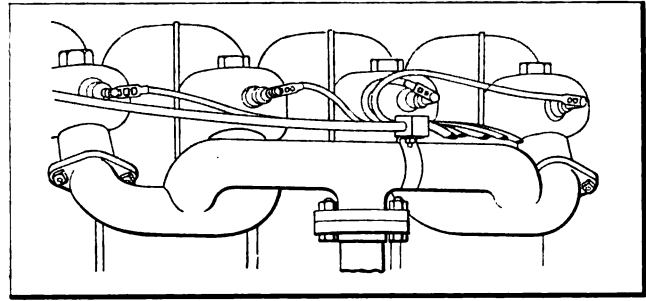

Fig. 20—Manifold, with an attempt to balance inertia forces, with easy bends as well.

anything of practical importance, whatever it does represent will be present in this class of manifold. In this case the gas has to go in the reverse direction to get to cylinders Nos. 3 and 4, while the distance to Nos. 1 and 6 is very great in comparison, although the direction is common to the general trend.

The Method by which Inertia Forces Are Balanced.—In contrast with the plan as shown in Fig. 19 the manifold depicted in Fig. 20 is offered, portraying an effort made to balance the forces due to inertia, in that the laterals leading to the respective cylinders are so connected that the gases will have equal difficulty in all directions. This is probably a very good plan and the reports in practice lend substance to the opinion.

As against this is the scheme depicted in Fig. 21 of a manifold for a "six" in which the pressures of the gas streams are equalized, although it is true that the flow is not in one (common) direction. In this case it is obvious that the designers were alive to the trouble attending the use of the manifold shown in Fig. 19, and it is a reasonable assumption that this way of equalizing is well worth the difference in cost of material. Moreover, the surface offered for the transfer of heat is a maximum, and this is also in the right direction, in the absence of perfect carburetion.

Proper Length of the Intake Manifold.—Considering the presence of carbon in motor cylinders as largely due to unvaporized gasoline, before the fuel enters the cylinders, which carbon is due to the breaking down of the gasoline structure, under the action of heat, in the absence of a right distribution of atmospheric air, rather than to a deficit of oxygen as respects totals, it is reasonable to assume that the manifold, from the carburetor to the cylinders, is, properly speaking, a part of the carburetor, and that the length of the manifold should be such as to do the most good, and that the gasoline, as it is sucked out of the nozzle of the carburetor, should be afforded every opportunity to vaporize. If the manifold is of the required length and if heat is applied to the mixture, through the walls of the manifold, at a constant (desired) temperature, it is then that the manifold becomes a part of the carburetor rather than a connection of convenience, as it is mostly regarded. That the shape of the manifold will influence the situation is rather to be expected, and in conclusion, strange as it may seem, it is better, in all probability, to have the manifolds with a limited area, rather than to employ them with so large an area that the friction factor will be a minimum. It is even possible to consider that benefits will follow a passageway which is tortuous and winding, provided the carbureted gas travels in one direction only.

(To be continued.)

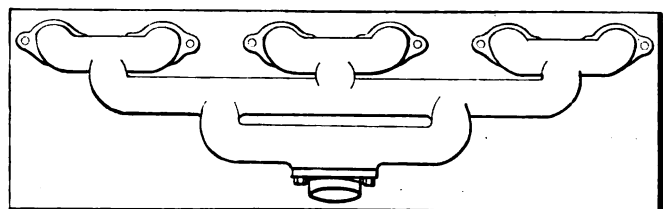
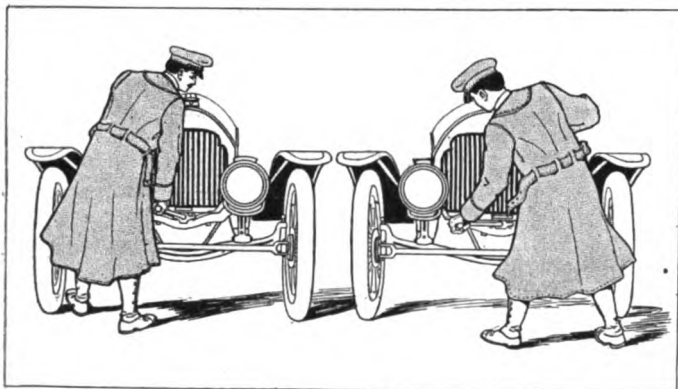

Fig. 21.—Compensating manifold for a "six," wherein the forces due to inertia are but slight and balanced.

Information for the Man Who Drives

Things to Remember About Starting.—One of the first things that the novice should learn is the proper method of starting. This, too, should be learned in a safe way, for there are methods in daily use which are not safe. Take, for instance, the ordinary way of cranking the motor. Most motors turn clockwise, that is, from left to right. Then, in starting, the



Shows the Improper and Proper Methods of Starting.

ordinary driver, who has just "picked up" driving, grabs the crank with the right hand and pulls on it until the top is reached, then pushes it over the center and the motor either starts or it does not. In the latter case he continues to pull it around. This method, whether right or wrong, may possibly work on a small engine, but wait until this plan is tried upon a large motor.

The driver, to crank in this fashion, must stand at the left and between the center of the car and the wheel or fender. At the top of the stroke, which is also the top of the circle of revolution of the crank, he is in a very awkward position. Worst of all, his arm is extended stiff and a back kick will operate directly against it. In this manner the arm is liable to be broken, or at least badly wrenched. In addition, the awkward position is such that the weight must be concentrated upon the right foot in order to balance. The least tendency toward backfiring is liable to destroy this balance, so that the driver may fall over. The writer has seen men start a car in this fashion, and finding the engine turn over more readily than they had expected and provided for, the very effort of starting was sufficient to upset their balance and they fell over.

With left-hand starting, on the other hand, these three objections are obviated. As the turn of the crank is away from the center of the car, its movement may be counted upon to give the driver more room in which to stand.

Instead of the last and hardest part of the cranking being in the nature of a push with the arms stiffened, with left-hand starting, it is more of a pull with the elbow flexed and therefore free. If the engine back fires it is easier to let go of the spinning crank, because it is exerting a pull on the hand, not a push as before. Then, too, the substitution of a well-balanced position for an awkward one helps to make the action of freeing the crank so as to let it turn freely much easier. The advantages of left-hand starting, then, sum up as: less danger to the operator's arm, easier balance of the body and less work.

The Amateur's Useful Diary.—One of the first things that the beginner should get is a motorist's diary. This should not take the form of a daily register of everything, making the work of keeping it a hardship. But on the other hand, it should contain a record of the time at which the principal things hap-

pened. Thus a form of mileage recorder should be secured and a note made of the mileage at which things occur.

So the diary should contain a record of the distance covered when things occur. It ought to include in this way the punctures, new treads or new tires, charging of batteries, grinding of valves, fresh oil in the transmission or crankcase, examination of various parts, replacements due to wear or accidents and many other little things worth knowing afterward, but forgotten at the time.

By keeping a record of this sort (and a person would be surprised how little time it takes) one can always answer questions directly and exactly. The total life of tires can be found, for instance. The writer knows of one prominent motorist who found out from a diary record of this sort that beyond a certain mileage it did not pay to have tires retreaded, no matter how good they looked. So he fell into the habit of taking the shoes off before that distance and sending them to be retreaded, although they did not then look as if they needed it.

How to Hold the Starting Crank.—In the apparently simple operation of cranking over an automobile engine there are many little points for the novice to consider. Among these the most important are those which make for increased safety. Thus the seemingly elementary action of grasping the crank handle is susceptible of two methods—one, right and safe, the other, not safe, and therefore, not right.

Ordinarily the driver will grasp the handle with a firm grip about as he would grasp a baseball bat; that is, with the fingers wrapped around it in one direction and the thumb around it in the other. Whatever method of cranking is employed this is wrong, for if the motor backfires the position of the thumb prevents letting go, at least quickly enough to be any service.

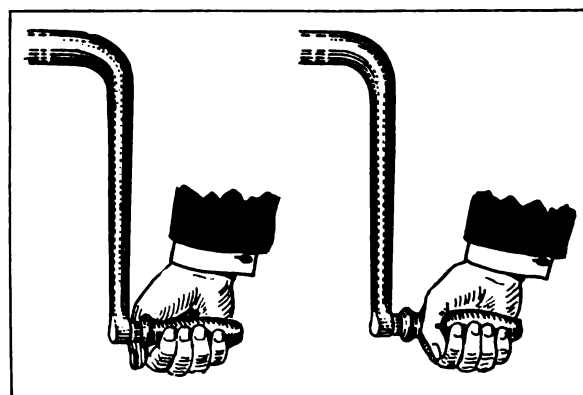

How to Hold the Crank, Correctly and Incorrectly.

The proper way, as the cut shows, is to take hold with the fingers around the handle, but loosely, never tightly. Then the thumb should not be used at all, but should be folded back alongside of the first finger and out of the way. The whole work is done by the fingers, and if anything happens the backward action of the crank simply opens the closed fingers and no harm is done. This particularly holds true when taken in conjunction with left-hand starting. In that case the latter and dangerous part of the starting action is a pull toward the operator. The arm is in tension, in which the greatest strength can be exerted. So, if the engine backfires, a person just stands still and holds the arm taut, while the backward action of the engine opens the hand and then rotates harmlessly.

Ready Remedies for the Roadside

WHILE the majority of automobiles are reliable and will run for quite a considerable period without the need of repairs or adjustments, still even the best machinery will sometimes need repairing, and the autoist who exercises his ingenuity will not only be able to continue his journey, but will save the cost of a repair bill and sometimes the ignominy of being towed behind a farm wagon. Repairs that call for experts' services and machine work cannot be performed on the road, and would be of no value to a stranded autoist, and are therefore not given here.

Repairing Leaks in Radiators.—Honeycomb radiators are given to "weeping" or leaking at the ends of the cells, and if a radiator plug is not at hand a substitute can be found in passing a long, thin bolt through the defective cell, fitting the bolt at both ends with leather or rubber washers or tire patches, backed with strips of metal, and screwing the nut down until the leak is stopped. If no such bolt is obtainable, a stick can be whittled to take its place and the washers retained by means of copper wire, as in Fig. 1. When a leak occurs inside one of the cells, a square peg cut from soft wood and covered with a piece of

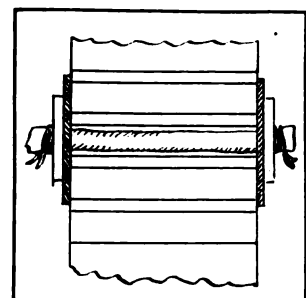

Fig. 1—Section of radiator showing washers held by wires on stick, to stop leak.

handkerchief smeared with white lead can be used as a stopper. In all of these operations only a moderate amount of force should be used, as the tubes are easily buckled. Leaks in gilled-tube radiators can be stopped by applying a rubber patch held in place by tire-tape and wire.

Twine Can Be Put to Various Uses.—Speaking of washers, when a lock-washer is missing a fine substitute can be made with twine forming a loop slightly smaller than the outside

diameter of the nut and wrapping twine around this loop, forming a "grommet," as the sailors call it. When the nut is screwed down on the grommet it will be held as firmly as if fitted with a nut-lock and will stay tight until the twine rots. Autoists should carry at least some 15 yards of twine in their kit, as it can be put to various other uses about the car, such as reinforcing weak spots in tires, protecting chafed wires and binding together split sections of the steering wheel.

Treating Circulating Pump Leakage.—Leakage of the water circulating pump occurs usually where the cover joins the pump body by means of a ground joint. A gasket of stiff paper dipped in lubricating oil inserted between the cover and the body will remedy this, the gasket being easily formed with the pocket knife. Asbestos cord is better than paper when treated with vaseline and graphite, but few autoists carry it. For leakage around the pump spindle the cord can be used, pushing it in with a piece of strip brass or other soft metal so as to avoid scratching the shaft. If no asbestos cord is at hand one of the strands of a piece of hemp rope treated with tallow will also answer.

When the Gasoline Pipe Gives Trouble.—When the gasoline pipe breaks, a short piece of rubber tubing forced over the broken ends will do for a short time, but as gasoline attacks the rubber too much dependence should not be put on it and the pipe should be brazed at the nearest shop. If the hole is only a small one a piece of soap squeezed in and held in place by a soaped rag and string will serve if gravity feed is used. For pressure tanks a piece of rubber tubing split lengthwise and

well soaped will temporarily stop the hole if wired tightly around the pipe, but the pressure must be kept low, otherwise the rubber tubing will be loosened and the leaking commence again. A leak is sometimes hard to locate, but if the pipe is rubbed with lather and blown through, the leak will be shown by bubbles.

Loosening Nuts and Screws.—Refractory nuts can be loosened by heating them with a red-hot piece of iron for a few minutes, when they will come off readily. If a screw cannot

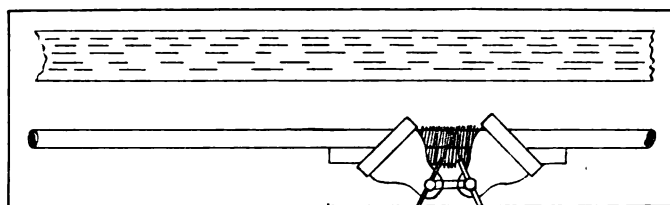

Fig. 2—Repaired drag-link, showing hand vises in place.

be loosened by the screwdriver the latter should be pressed hard against the slot in the head of the screw and turned by a monkey-wrench applied to the flat part of the blade. A tight radiator cap can be moved by winding a large amount of string or cloth tightly around it.

Broken Rods and Links Can Temporarily Be Mended.—The repair of a broken link in the steering gear can be effected by placing the broken ends together and fastening a rod or a piece of gaspipe against the link, winding the wire the entire length of the rod. If two hand vises can be obtained they can be attached as shown in Fig. 2. The rod is tied to the joined ends of the link with wire and the hand vises screwed down on both link and rod. Anything but slow running with either of these repairs is out of the question. Any other rod can be similarly repaired provided there is room for the pipe or the vises alongside of it. Wire cable can be substituted for brake rods, but the brake must be kept clear of the drum by some means when not in use.

What to Do When a Chain Breaks.—If a chain breaks and the autoist has no spare links the car can be driven on the other chain after the idle sprocket is secured so that it cannot revolve. An easy way to do this is to pass one end of the chain around the sprocket, fastening the end link to the chain with wire and attaching the other end of the chain to some part of the car, such as a running board bracket. On shaft-driven cars the universal joint pins sometimes work loose and drop out,

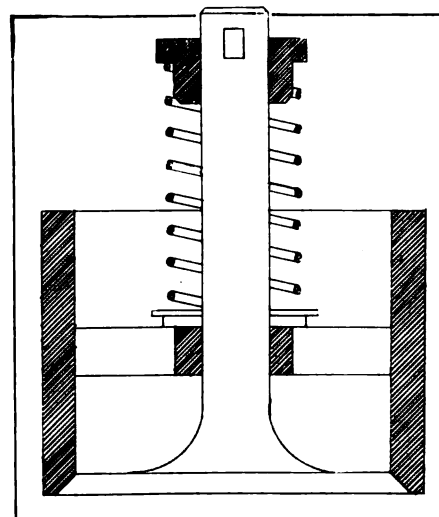

Fig. 3—Valve spring strengthened by inserting metal strips

but a temporary pin can be made from a bundle of wire or a small chisel held in place by wires or twine.

Strengthening Weak Inlet Valve Springs.—Mechanically operated inlet valves have superseded those of the automatic type except for two-cylinder opposed motors fitted in light runabouts and motor buggies. There is a surprisingly large number of these vehicles in service, and as at some time or other the inlet valve springs become weak or break, the following suggestions will not be out of place. If the spring is weak it can be strengthened by inserting strips of brass or the blade of a knife broken off for the purpose between the spring and the spider of the valve cage, as in Fig. 3. In thus strengthening

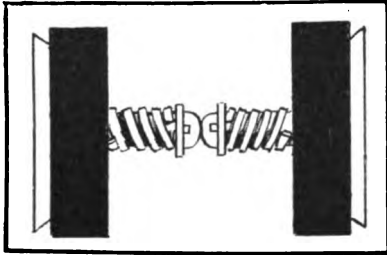

Fig. 4—Method of testing valve springs.

a spring it would be well to test it against another inlet valve spring by placing the ends of the stems together and pressing the cages toward each other as in Fig. 4. The strips of metal can then be put in until the valves both unseat equally, when the springs will be of equal power. If the spring is broken pieces of corset steel can be substituted for it, one end of each steel being notched to straddle the spider arm and being fastened to the collar wedge by wire passed through a hole near the other end as in Fig. 5. Even if the power of the steels is not as great as that of the regular spring the motor will run well enough to bring the car home. A corset-steel-fitted inlet valve was used on a runabout for four days while waiting for a new spring from the factory and was apparently capable of giving some more service when taken out.

Substitutes for Trembler Blades.—Corset steels can be used as blades for trembler coils, cutting them to the proper length and riveting the platinum button from the broken blade through the hole which is punched by the manufacturer near each end. After making the holes for the retaining screw the blade is complete. A piece of a clock mainspring will also make a good blade.

Remedying Squeaking Springs.—A frequent source of annoyance is the squeaking that indicates that the leaves of the springs require lubrication. The axle is jacked up until the wheels are clear of the ground and the springs quite flat. Then with a chisel or screw driver each leaf should be forced apart gently and a mixture of vaseline, oil and graphite spread between it and the next leaf with a knife or flat steel rule. Where parts are not easily reached by this method they should be squirted with oil. The leaf clips should be removed if necessary to allow of this being done.

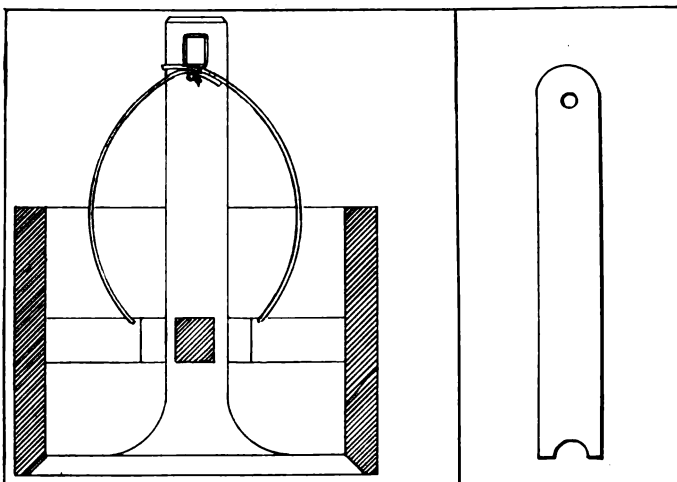

Fig. 5—Corset steels used as impromptu valve springs.

POINTS THAT MAY HELP YOU.

By A. D. HARD, M.D.

There is nothing more exasperating than to get into a small soft place in the road and have the driving wheels spin until the axle rests on the ground and all traction is gone. I used to hunt immediately a farmhouse and get help to haul the car out, but as I do not like to acknowledge dependence on farmers or horses when using an automobile, I have devised the following method of getting out of such predicaments unaided. The material necessary for constructing the device consists of four thick leather straps, 6 feet long and 1½ inches wide, and 26 pieces of hickory wood, 10 inches long, 2 inches wide and ¾ of an inch thick. One-quarter-inch holes were bored at two inches from the ends of the pieces of wood, and the straps riveted to the pieces of wood in such a manner as to make a flexible ladder with leather "rungs," six inches apart from center to center and with 4-inch open spaces between them.

Use of the Strap Ladders.—This gives me two strap ladders, 6 feet long and 10 inches wide. They are snugly rolled up with the strips of wood alternating so as to occupy but little space. When the situation calls for some help to get out of a mud hole I place a trace chain around the rear axle and the frame to prevent the spring expanding, and with the jack under the rear corner of the frame lift the driving wheel up as far as the jack would permit, then unroll the strap ladder on the mud in front of the wheel, with one end under the tread. The other wheel is treated in the same manner, and with low gear the machine will travel over the 6 feet of strap-ladder track with perfect ease. If this does not reach solid ground, I simply repeat the trick until the trouble is passed. This has helped me out of several very trying situations and made me feel independent of outside help, which was very pleasing.

Novel Test for Missing Cylinder.—Frequently my engine misses explosions in one of the four cylinders when under a load, though acting very properly when running free where I can watch it. In order to locate the offending cylinder, I stop the engine and touch each cylinder with the business end of a match. The cylinders which are hot from action will ignite the match, and the offending cylinder will not.

Use Single Tube Tire as Inner Tube.—If you wish to avoid tire troubles you should select a single tube tire of proper size and use it for an inner tube to a clincher casing. If the single-tube tire is too small in cross-section to fill the casing properly, slit an old inner tube around its inner or concave side and place it over the single-tube tire to increase its diameter. Two or even three may be superimposed if needed. Tire lugs will not be needed, and the tire should be pumped up extra tight.

A Priming Kink.—If your motor does not start easily, owing to not getting a rich enough mixture at slow speed of cranking, tie a small bunch of waste with a wire so that it will be close to the air intake of the carbureter. Prime by saturating the waste with gasolene, and the added vapor will make starting easy.

Emergency Filling for Differential Casing.—In case you are unable to obtain oil or grease for the differential casing, beeswax can be used as a substitute, and the car will not skid as much as formerly.

Safe Cranking of the Engine.—The principle involved in safely cranking an engine is to get the explosion when the crank is pulling on the fingers, so that if the kick comes the force will simply pull the handle out of the grasp and not expend its force against the body weight and applied force. Do not attempt to turn the crank all the way around; adjust it to begin against the compression and then give a quick pull upward.

Dry Cells Satisfactory for Ignition When Properly Connected.—Dry cells will give very satisfactory ignition for a four-cylinder motor if you will use four sets of four cells each, coupled in series multiple, so as to get a voltage of only six volts. The secret of light battery consumption, as a rule, is in having the vibrator respond quickly to the traction of the magnet in the coil. The slightest current should open the contact points.

VALVE MECHANISM FOR INTERNAL COMBUSTION MOTORS

THE majority of internal combustion motors in use to-day are fitted with mushroom-head inlet and exhaust valves working in separate chambers or cages and actuated by cams. There have always been dissenters from this, the received method of valve mechanism, who employ rotating valves, oscillating sleeves and various other devices. Since the demonstration of the commercial success of the Knight motor considerable interest is being taken in such mechanisms and a number of new devices have appeared. The most recent of these is designed to do away with cams and separate valves for both inlet and exhaust and substitute a piston and sliding sleeve which will perform the functions of both valves. In the following description of the mechanism and its action which is that given by the inventor Alden E. Osborn, of New York City, some of the statements have not been proved, as the device is as yet in the experimental stage. He says:

"This valve gearing was invented and designed by me after considerable study and planning of several other forms, and is believed to be new and to possess advantages not only over the present cam-operated valves, but also over other forms of mechanism that have been brought out. The gear shown in the drawing consists essentially of a small piston operating in a cylinder having communication with or opening into the combustion chamber of the motor and combined inlet and exhaust passages in this valve cylinder which are uncovered and put into communication with the combustion chamber by the movement of the piston valve away from the combustion chamber. A means for actuating the piston valve is provided whereby it is given a relatively slow movement at one end of its stroke and whereby it moves faster in one direction than in the other and a valve for throwing the passage above referred to into communication with either the inlet or exhaust chamber of the motor is also fitted.

"In the drawing the main or piston valve *A* is shown in the position it assumes when the motor piston is at the top of the compression stroke, the passage *B* controlled by this piston valve being in communication with the exhaust chamber by the forcing up of the distributing valve *C* by the collar *D* on the piston valve stem. The main valve is actuated from the half-speed shaft by means of a connecting rod *E* pivoted directly on the lower end of the valve stem below the half-speed shaft. The connecting-rod pivot is considerably offset, and this together with the length of the rod, length of valve stroke, size and position of ports and position of distributing collars are so proportioned as to give the correct timing. When the main valve reaches nearly to the bottom of its stroke and the motor piston the end of the exhaust stroke it comes into contact with and forces down the distributing valve thus closing the exhaust *G* and opening communication with the inlet passage *F*, which remains open until the distributing valve is again raised by the collar on the piston-valve stem.

"The distributing valve need not be a very close fit and would be a very light shell both to minimize the shock in removing it and to enable it to be held in place by the ring friction. It should be understood that while this method of operating the distributing valve by the same means as the main valve is new and is very simple, and, it is believed, would be perfectly satisfactory, other methods, such as the operation by a separate crank mechanism or the use of a rotary distributing valve having suitable ports and rotating around the main valve at a speed sufficient to give the correct timing, may be used.

"In cases where high power and efficiency are especially desired the main valve may be in the cylinder head and work downward, thus giving a spherical combustion chamber and a particularly free passage for gases. The cooling of the valves would not present any difficulty, as the only part of the piston valve subject to the hot gases is the top, instead of both top, underside and stem as with the ordinary exhaust valve, and the

fresh charge passes through all parts that would be heated, greatly assisting in cooling them. It is believed that this valve system is particularly suited for use with air-cooled motors, it being shown in connection with a small motorcycle motor, but its cooling qualities would be very advantageous in connection with other cooling means. For water cooling suitable passages would be provided around the valves, while in very large sizes the water could even be circulated through the valves them-

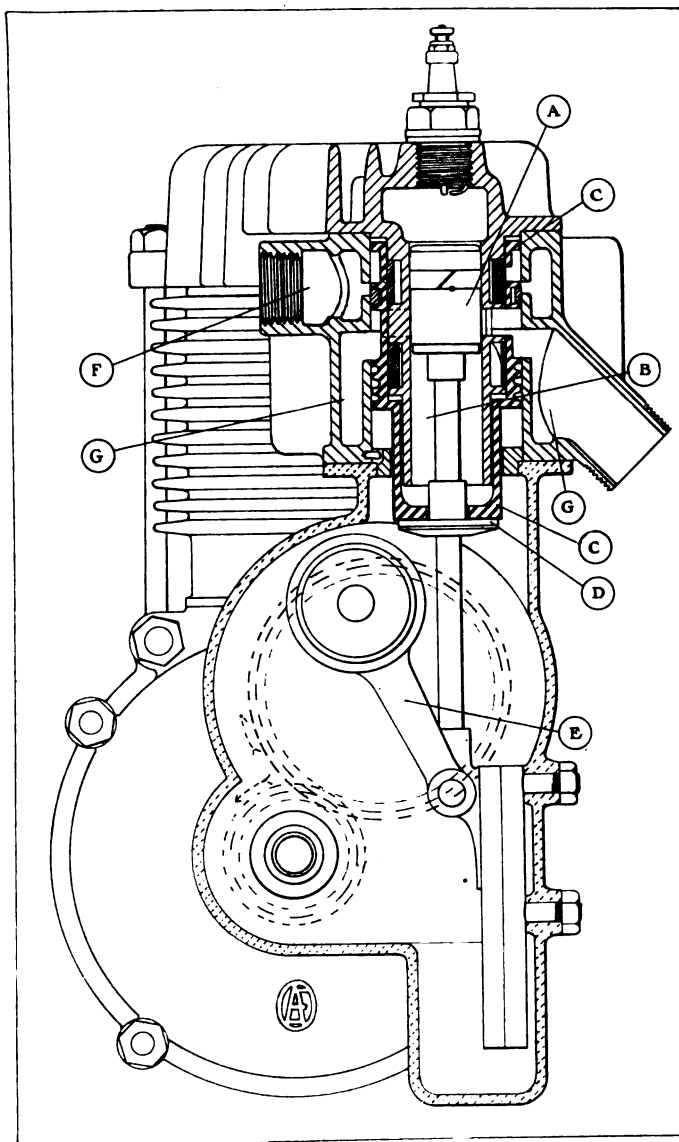

Osborn Valve Mechanism Applied to a Motorcycle Motor.

selfes. From the foregoing it will be seen that this valve mechanism is of extreme reliability and simplicity, does away with all springs, cams, rollers, etc., eliminates all adjustments, noise and necessity for valve-grinding or other attention and gives a very desirable quick port opening and free passage for both inlet and exhaust gases."

When Emery Paper Is Forgotten.—Should the autoist neglect to carry emery paper or a swiss file, and the spark plugs need cleaning, a substitute can be found in the igniting composition on a box of safety matches. This can be used in the same manner as the emery paper and, while not quite as good, will clean the plug quite effectually.

Letters Interesting and Instructive

COST OF RUNNING A CAR.

Editor THE AUTOMOBILE:

[1,863.]—I am considering the purchase of an automobile, and, being a man of moderate means, I wish you would give me some information as to the cost of running a car. I do not care for a large car nor a fast one, in fact I would prefer a light slow car to learn on, particularly as I have been told that extra speed costs more.

H. BENSON.

Shenandoah, Ia.

Any figures as to cost of operation would be guess work, unless a person was able to quote you actual figures supplied by a friend, well-known for both careful driving and honesty.

We are fortunate in being able to give you some such figures. These were, however, made in England, and in the consideration of them you should take into account the fact that the roads over there are better than the average roads here. Second year's use of a single-cylinder 6-horsepower Jackson car:

Item.	Cost.	Cost per mlie.
209 gallons petrol.....	\$63.68	\$0.0122
Repairs, grease, oil, etc....	131.81	.0262
Special items, new lamps, etc.	31.10	.0060
Insurance	35.82	.0069
License for car.....	10.23	.0020
Driving license.....	1.22	.0002
Total	\$273.86	\$0.0526

The above represents the total expense of running 5,210 miles. The driver and owner of the car, says that in the two years he has had the car, he has driven a total of 10,109 miles at a total cost of \$512.34, which works out \$0.0506 per mile. The above itemized figures then err, if at all, on the side of safety.

These figures selected, at random, so to speak, and showing a total cost per mile for a small light car, such as you would want, of 5 1-4 cents per mile, should reassure you on the score of excessive expense, providing care is exercised.

SOME DIFFERENT RULES.

Editor THE AUTOMOBILE:

[1,864.]—Will you kindly publish whatever data you might have relative to the testing of the different grades of gasoline (that is deodorized, 74 and 76 degrees test) in the way of starting motor, economy, and power. What kind of ether is used to increase the power of motor, and what per cent. of ether to the gallon of gasoline. What are the relative merits and demerits in its use. Would you mention the names of reliable cheap air pressure gauges for tires.

S. KNOX.

Woodbine, Md.

The higher degree test liquids are more volatile, therefore they vaporize more quickly. From this it is easy to deduce that, using them, the engine would start more readily. That is, you could start easier and quicker with 76 degree gasoline than with 64 degree. However, this is just a supposition, as there is no more of either 74 or 76 sold. With the liquid now sold, the interval between any two being less,

the noticeable difference in starting effort would be less. As to economy, the same remarks would not hold, as given enough heat to vaporize, the heavier gasolines, which would test up lower, say, about 64 degrees, contain a greater proportion of heat units. They would thus be more economical. The nigger in the woodpile is that they are not pure, and the impurities are higher in proportion with the heavier fluids. Also, there is some question about sufficient heat being present to vaporize.

The usual liquids added to fuels are oxygen carriers. Of these ether, picric acid, chlorate of potash, and pure oxygen have been used. The use of any of them except the latter is to be deprecated, as their presence renders the liquid fuel explosive. The majority of them, also, have a detrimental effect upon the parts of the engine and fuel system exposed. Picric, for instance, attacks cast iron. The first noticeable effect is the rapid pitting of the valves. The percentage varies with the one selected. Aside from increased speed and power, there are no advantages. The increased cost of fuel, of maintenance, and repairs, taken with the explosive nature of the mixture, more than offset this.

The absorption of acetylene gas by gasoline is also used to increase the explosiveness, and consequently, the power from the liquid fuel.

By turning to the advertising columns of THE AUTOMOBILE you will find a number of reliable air pressure gauges for tires, from which you can select one that fits your pocket-book.

HOW TO PAINT BRASS.

Editor THE AUTOMOBILE:

[1,865.]—I am having my car painted and told the painter to paint over the brass parts of the radiator. He told me that the paint would not adhere to the smooth brass after being subjected to the heat of running conditions, but would peel off. Is there any way to prepare brass so that it will take paint and hold it permanently?

F. P. WHITTAKER.

Grantwood, N. J.

The painter was right; paint directly applied to smooth brass parts subject to heat will not stay in place. To prevent the peeling action, have the painter apply a very thin even coat of shellac. When this is dry in place, the paint may be applied over it in any number of coats you wish to have. You need have no fear of the paint peeling off, as the shellac will stand a much higher degree of heat than will ever obtain in a radiator, higher than the temperature of boiling water, in fact, before cracking. If you do not wish to apply a large number of coats, the shellac may be colored, so that the brass will not show through it. In this way, the painting can be completed with one or at the most two coats of paint.

USE OF TWO MUFFLERS.

Editor THE AUTOMOBILE:

[1,866.]—Will you please inform me through the columns of "The Automobile" if better results cannot be obtained by the use of two mufflers instead of one on a horizontal motor. Also advise me if better results can be secured by using double-chain drive on a high-wheel auto with 1 1-2-inch tires, or would you suggest direct rear-axle drive?

W. COOPER.

New York City.

If the engine on your car is large enough so that you can spare a little power, two mufflers would reduce the noise very markedly. However, with a properly designed and fitted muffler there should be no necessity for the additional one. All this is said regardless of the type or size of the engine, as the type does not influence the muffling question, while the size only enters in determining the muffler size.

As to the chain versus shaft proposition, the chain is said to have a superior efficiency as a power transmitter, but enclosing it complicates the care and repair of it. The shaft drive, on the other hand, is easily enclosed, and when so covered is clean, quiet, and readily accessible.

A FEW ENGINE QUERIES.

Editor THE AUTOMOBILE:

[1,867.]—Will you please answer the following questions: (a) Which of two engines would vibrate the most noticeably, a four-cylinder 4 1-2 by 6 or a four-cylinder 5 by 5, and (b) which of the two would be most powerful at the same number of revolutions, say, 900 r.p.m., also (c) what horsepower would be considered good with valves in three different positions as: in the head, on opposite sides, all on one side, also (d) what percentage of the actual stroke should the compression volume be? J. M. St. Paul, Minn.

The force of the explosions vary with the size of the compressed charge, and with the explosion will vary the noticeable vibrations. The size of the charge will be greater with the greater volume swept out by the piston. In the case you cite: (a) this will be 95.4 cubic inches for the 4 1-2 by 6, and 98.2 cubic inches for the 5 by 5. On this basis, the latter would vibrate more noticeably. This is, however, in the nature of hair-splitting, for with as small a difference as this, the difference in vibration could actually not be noticed. All this is on the assumption that the two engines had the same compression. (b) The 5 by 5 would probably develop more power than the other. This is because the bore influences the power as itself squared, while the stroke only enters in the first power. The A. L. A. M. rating for the two would be 32.2 for 4 1-2 by 6, and 40 for 5 by 5. (c) It is not considered that the position of the valves influences the power, although the overhead valve doubtless does to a very slight degree. As between the other two, there is no choice, if power alone is considered. Even with the overhead

valve, this seldom, if ever, is the only thing considered. (d) This varies with the motor, power desired, etc. For a racing motor 1-4, or 25 per cent., would be considered good practice. In ordinary work, 1-3, or 33 per cent., would be more usual. This means 33 per cent. added to the volume swept out by the piston. In designing a motor, the common practice is to figure this so as to get the desired compression. To do this, the formula is used

$$PV^{1.35} = K = 14.7$$

from this, by transformation,

$$V^{1.35} = \frac{14.7}{P}$$

in this P is the desired compression pressure, and V is the ratio of the compression volume to the total volume.

By determining upon the compression, the expression for V is obtained from the above. Then from this, the volume swept by the piston being known, the other volume is readily found, using the equation:

$$V = \frac{\text{piston volume} + \text{compression volume}}{\text{compression volume}}$$

A slight error enters through the use of the constant 1.35, as this has never been accurately determined; however, it is close enough for ordinary work.

MUCH INTEREST IN WELDING.

Editor THE AUTOMOBILE:

[1,868.]—Will you please publish a list of the articles on oxy-acetylene welding or other welding processes which have appeared in the columns of "The Automobile" within the past year? I am very much interested in this subject and wish to read up what has been written on it.

H. M. EAST.

Melrose, Mass.

The following articles have appeared in THE AUTOMOBILE in the past year:

Vol. XVIII, January to June, 1908—"Autogenous Welding in Automobile Construction," pp. 877-879.

Vol. XIX, July to December, 1908—"About Repairing Broken Cylinder Castings," p. 156. "New Method of Autogenous Welding," p. 304. "The General Aspects of Autogenous Welding," p. 781.

Vol. XX, January to date, 1909—"Davis-Bournonville," p. 159. "Commercial Acetylene Company," p. 161. "Autogenous Welding Explained," p. 178. "Autogenous Welding Effective in Repair Work," p. 501. "Repair of Aluminum Castings by Oxy-Acetylene," pp. 655-656.

HOW TO GRIND VALVES.

Editor THE AUTOMOBILE:

[1,869.]—I am a newcomer, having recently purchased a car. Some time ago I decided that my valves needed regrinding and attempted to do the work myself. In this I fear that I have done a botch job, for the compression is even worse than before. Will you please tell me how to grind the valves properly?

A. R. SPACKMAN.

Allentown, Pa.

Really, there is nothing to valve grinding except care and the proper materials. First, you will need some very fine emery, the

finest you can obtain. Next, this should be mixed to a paste with oil, preferably a light cylinder oil. To use the paste, a screw driver, or if you prefer it, a brace and screw driver bit, will be necessary. Now, have the valve free of its spring, clean the seat off, and spread a very little of the paste over it. Put the valve into place on top of the paste, and with the screw driver or bit turn the valve on its seat about half a turn, then reverse, and turn back half a turn. All the time, pressure must be exerted upon the valve, so that the emery will take hold and cut. Then move the valve around to a fresh position, and repeat the alternate forward and back motions. The first and second positions will have covered the whole circuit, if just a half turn be used each time. In that case,

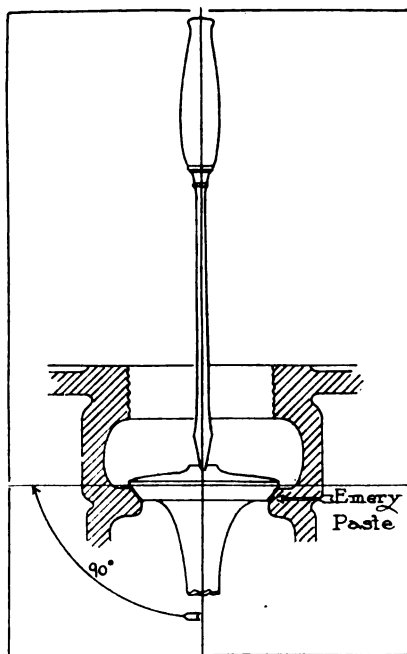

Showing How to Grind Valves.

the third move should be such as to grind on a space not wholly covered by the previous work.

Beyond this, the only really important point is to have the axis of the valve perfectly square with the seat. If the valve guide has become worn, there is danger of tilting the valve during the grinding process to one side. Then, when in use, it tilts back to the other side and the work of grinding has become useless. There is some danger of grinding off too much. To determine when you have ground enough, note when the pitting has disappeared. After that, grind very little longer before you test the seat. This is done by coating the freshly ground seat with a thin film of red lead, or by smoking it with the flame of a candle. Having thus marked it, set the valve lightly into place and rotate. If you have ground to a proper seat, this rotation will scrape off the lead or carbon used in a continuous ring. It does not matter how wide this ring is, but it must be continuous.

CARBURETER TROUBLES.

Editor THE AUTOMOBILE:

[1,870.]—I have a new automobile, Buick Model F 22-horsepower, on which I had installed a Remy magneto. I find whenever I get in a heavy pull and open the throttle pretty wide, my engine backfires in the carbureter. It never does this on smooth road, although I may have the throttle open wide. When I run on the batteries, I rarely ever have a backfire in carbureter, but when running on the magneto and in a heavy pull, it does backfire. I have used new spark plugs and new batteries, but it doesn't seem to remove the trouble entirely, although it helps a great deal.

If you can explain the cause of this, I will greatly appreciate it. I thought perhaps it was carbureter trouble, but have changed carbureters and still have the same back firing, so I know my carbureter is O. K.

ROY N. CHELF.

Brooksville, Fla.

From the record of your troubles we would have said the carbureter was at fault, but it appears that you have obviated any possibility in that direction. About the only other solution is that the magneto is slightly out of time, say to the extent of one tooth on the driving gear. As the result of this, on slow speeds and even at high speeds with but little load, the effect is not bad enough to be noticed. When working under a heavy load, however, even a slight error in the timing would be greatly magnified. The same results might be caused by the valves being incorrectly timed, possibly by the same small amount, that is, one tooth out of the way in the meshing of the driving gears. In case that a remedy for the trouble does not result from making the changes indicated above, look at your inlet valve springs, or to anything else that could possibly cause the inlet to close late or slowly. Look at the valve seats to see if they are in good shape, and finally read letter (1849) in the April 22 issue of THE AUTOMOBILE relative to the correction of sticking valve stems. If your trouble persists after trying the other remedies, try fixing your valve stems.

MORE RED-HOT PIPES.

Editor THE AUTOMOBILE:

[1,871.]—Will you please publish the following in answer to the letter from J. T. D. relative to a red-hot exhaust pipe (1835)? I have had similar trouble and after much working around and trying of new schemes and suggestions from others, I found that my muffler was clogged, and upon cleaning it, found a little improvement. This was not enough to satisfy me and I continued working on it until I finally decided that the trouble lay in the design of the muffler. This was so designed that there was too much back pressure upon the engine. The result was that it made the exhaust pipe into a radiator by allowing all the heated gases to remain in it. As each fresh supply remained in or was forced in, there resulted a constant increase in the temperature. Finally, this arrived at the point where the exhaust became red-hot, and as far back as the cylinders.

Upon arriving at this conclusion, I bought another muffler on trial, and as it proved satisfactory, I kept it. My hot pipes have entirely disappeared since putting the new one on.

V. K. MALONE.

Kansas City, Kan.

This brings out very clearly a point that was not touched upon in the answer to J. T. D., published in the issue of April 15. The point is well taken, and should be kept in mind by anyone having trouble with pipes heating up. Many think this necessary, but it is not.

French Newcomer with Aerial Engine

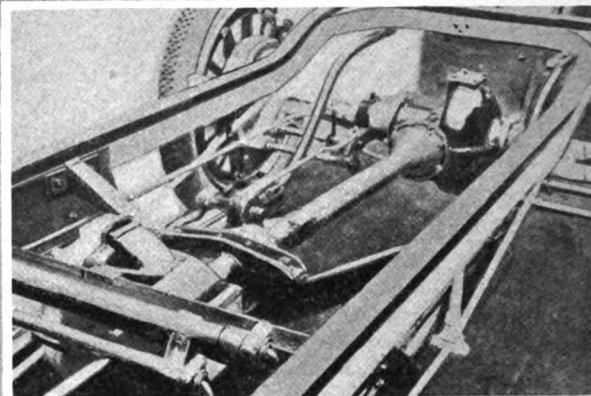
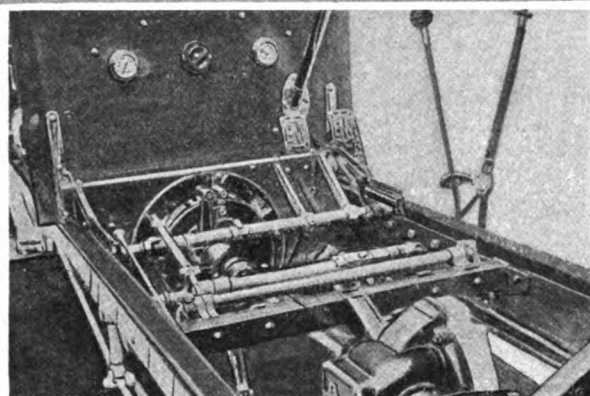

PARIS, May 1.—One of the largest producers of aeroplane engines in France is about to turn his attention to automobiles, and the advance notes of the car to be produced are of more than passing interest. In fact, to the casual observer, some of the details are in the nature of an amazing departure from current practice. The power plant details, in particular, present some new ideas adopted from aerial practice which will doubtless provoke much discussion.

Aside from the new and advanced features, the general appearance of the finished vehicle is not unlike that of a number of other French cars, as Renault, C. G. V., and the recently described Ampere.

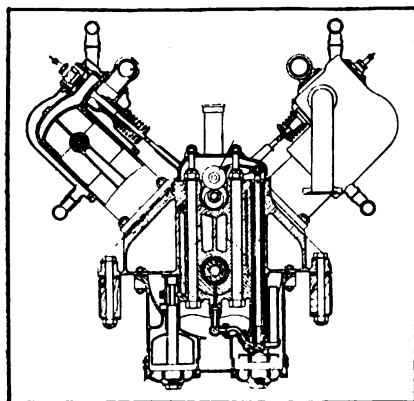

Cross-Section Showing Oil Pump.

The possible openings for discussion are shown by the statement that the engine used is the same as the one supplied many prominent members of the aerial brigade, viz., an eight-cylinder of extremely light construction. This gives an opportunity for a revival of the old discussion as to torque of motors with more than four cylinders. Is the torque more even than the four, to more than make up for the extra weight and cost? That is an open question, at least as to cost; but on the subject of weight the E. N. V. scores heavily, as, being built primarily for aerial use, where weight is reduced to the absolute limit, the ratio of weight to power is very low indeed. This will satisfy the advocates of light construction who are not partial to the air-cooled engine; in fact, this motor goes even the latter one better.

Thus the total weight of the engine alone is 330 pounds. At the moderate speed of 1,000 r.p.m. the power developed is 50, while by speeding up to 1,500 r.p.m. or more, 75 horsepower may be had. The former is 6.6 pounds per horsepower, while the latter speed reduces the ratio to 4.4 pounds. Putting this motor into a car will, with a car weight of 3,300 pounds total, be in the ratio of 44 pounds, which is less than the best "four."

Distinctive Features of the Engine.—The engine presents many distinctive ideas in automobile practice. The cylinders, 100 mm. (3.94 inch) bore by 130 mm. (5.12 inch) stroke, are set at an angle of 90 degrees to one another. In this manner there

are two groups of four cylinders on each side of the axis of the motor. The cylinders are cast separate, without water jackets, and are machined both inside and outside. This process results in each of the castings being of exactly the same weight as every other one, and the resultant saving in the total weight is considerable. Moreover, it allows of a much lighter cylinder casting than could be successfully used otherwise.

The position of the outlet and inlet for the exhaust and the carbureted gas are peculiar. The outlet is located at the side of the cylinder casting, and the castings are so placed that number one cylinder in both groups exhausts at the front side, while number two exhausts at the rear side. Three and four are just like one and two, so that there are four individual exhaust pipes on each side. They are conducted into a header, these being placed below the crankcase on each side. From each header, a pipe leads straight back to a muffler. In this arrangement not only does each group of cylinders have its own exhaust pipe and muffler, but down as far as the exhaust header each cylinder has an individual outlet.

The inlet, on the other hand, is placed in a position which would be best described as the middle of the front of the cylinder casting. This brings, when the motor is assembled, all of the inlets on the inside facing one another. Short pipes connect them, and from the middle of these—that is, exactly between cylinders two and three—a pair of pipes of drawn copper tubing lead to the carbureter, placed in front of the crankcase.

The waterjacket, of copper, is not riveted in position nor held by a junk ring, as is usual, but is the result of electro-deposition, all joints being thus proof against leakage. Moreover, so closely is the copper joined to the cast iron of the cylinder that it is impossible to distinguish the exact point where the iron leaves off and the copper begins. It is a method which has but one disadvantage, that of first cost. The water space is determined with accuracy, while minimum weight is obtained.

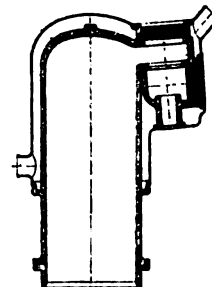
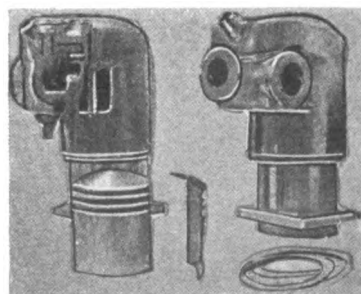

Cylinders Have Electrically Deposited Water Jackets.

The valves are not placed in the head, as is the ordinary practice with very light engines, but are placed side by side on the inside, so that a single camshaft operates the valves of all cylinders. The camshaft, for the operation of these valves, is machined from the solid metal, resulting in rigorously accurate cams, and again the extreme lightness is favored. The drive of the shaft is by means of a spiral gear of very large diameter. This means low friction losses and very quiet action. The cams are of a variable shape, from the point exactly under the valve outwards, and the shaft is slidable in a longitudinal direction.

The driver of the car has at his disposal the manipulation of this shaft, so that he may vary the lift of the valves at will and thus, if he so desires, effect the maximum fuel economy.

Very Lightweight Four-Throw Shaft.—The crankshaft is a fine piece of machine work. The circular webs are turned out, both inside and outside, and the crank pins are also drilled through. The shaft is of the four-throw variety, and, except for the great length of the pins, is not different from any ordinary crankshaft. The circular webs, which are heaviest at their extremities, or rather peripheries, in this respect aid in the flywheel action and allow of the mass and weight of the latter being reduced. They also increase the balance of the motor as a whole because of their location. As to balance, this is not quite as good as the six, but the difference is small. The longitudinal

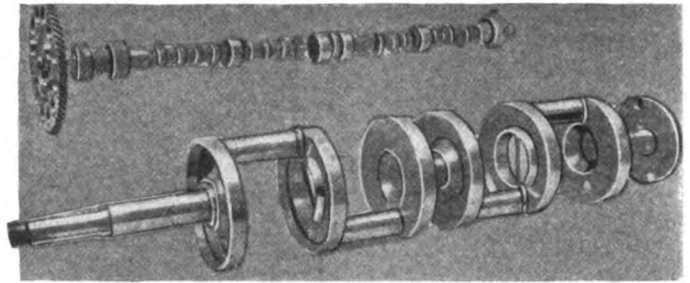

Camshaft and Crankshaft Are Made Very Light.

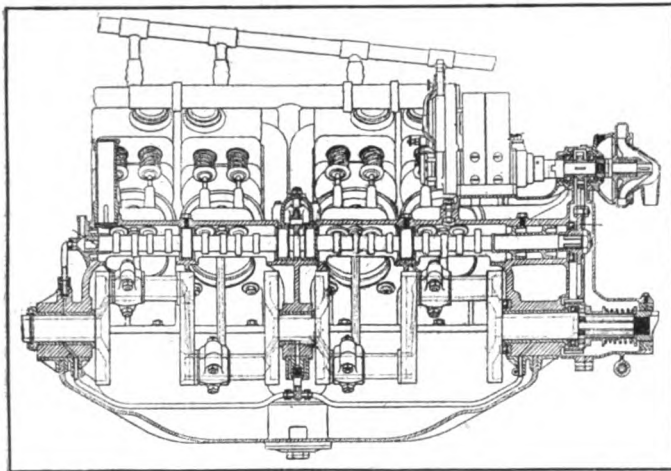

The Longitudinal Section Displays the Crankshaft.

couple is balanced, which is not the case with the six. The transverse couple, similar to the six, is completely balanced, and, in common with the fewer number of cylinders, the primary force is unbalanced. This, however, is very small on the sextuplet arrangement, while, with the eight it is very high.

The largest variation of energy due to the moving parts, or, more correctly, the reciprocating parts, is lower than the same for the more common sixes. So, too, the figure for the energy ratio is less than half that of a six, this being advantageous.

The torque is more uniform than any six, consequently the shocks to the parts of the mechanism are less, and the necessity for changes of speed are even less than in a six, one of the latter having been operated without a gear box.

Size and Length of Main Bearings.—Plain bearings are used and are of exceptional length, that is, at the ends. These have a length of about two and a half times the diameter of the shaft, which is, itself, of a very large size. The crank pins are of the same diameter as the bearings, and the pin length is also two and a half times the diameter.

The connecting rods are offset and have the ordinary I-section. The piston and rings, together with the piston pin and its method of fastening, present nothing novel. The piston has a domed top, which is machined all over. This procedure is expensive, but saves weight, and by making the pistons more nearly alike contributes very materially to the balance. Three rings are used, all placed above the piston pin, but another ring, or, more correctly, a lip, is turned into the inside of the bottom of the piston. This

catches and retains the surplus oil, and feeds it through small holes to the cylinder walls.

The lubrication differs from this construction in that it presents some element of novelty. Lubrication is of particular importance on an engine of as fine constructive workmanship as this one, for its very fineness would be less protection against the lack of oil than would the inferior but larger parts of a more husky machine. The lower part of the crank chamber forms an oil tank. The level of the liquid in this is controlled by a float. A lubricating pump driven off the end of the camshaft, the rear end, by the way, delivers a constant supply of oil to the central and main bearings of the main shaft, as well as the camshaft bearings. Both shafts are hollowed out, so that the oil circulates through them. The crank, in addition, is bored at all of the pins, so the oil circulates directly to them. The round webs are also bored and from them to the upper end of the rods a connecting tube of copper leads the oil up to that point. All surplus oil from the mechanically lubricated bearings flows to the crankcase, where it is led into the special chamber, from which the float regulates the return flow.

The water is also positively moved around by means of a large diameter pump of the centrifugal type. This is located on the extension of the magneto driving shaft, midway between the cylinders and rather high up. The magneto being driven at crankshaft speed, the water is moved at this same high rate. This high flow rate allows of somewhat smaller diameter water pipes, showing the faithful attention to small details which has resulted in the unusual weight reduction.

The water outlet is on top of the cylinders, from where a gradually increasing sized pipe leads up to the water tank. The pipes for the two groups are separate and enter the water tank, placed on the front of the dashboard, on opposite sides. The radiator is placed, C. G. V. fashion, forward in front of the engine and rather low down. An air-tight bonnet above the engine and an air-tight pan below it force the air after passing through the radiator to do double duty by passing over the length of the engine, in which cooling action is gained.

Ignition Is Regular Except for Magneto Position.—The ignition system presents those features which time and modern

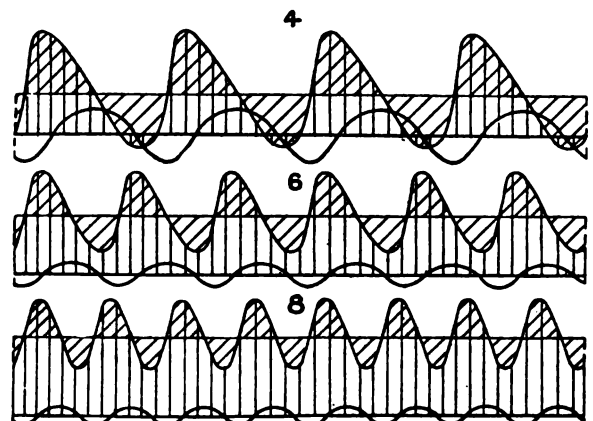

Torque Curves for Four, Six and Eight Cylinders.

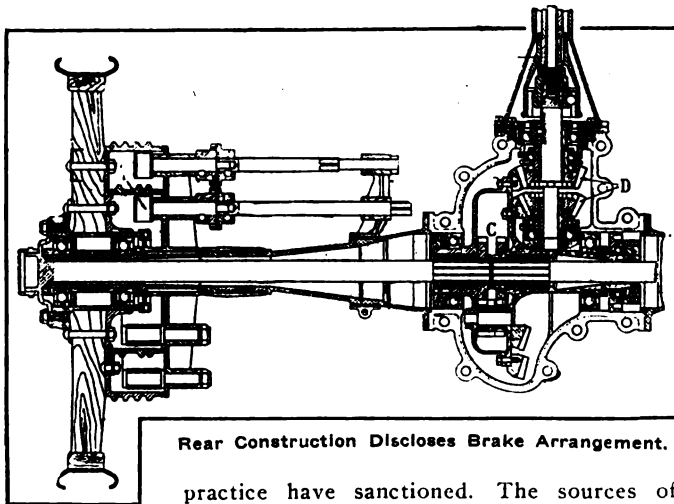

Rear Construction Discloses Brake Arrangement.

practice have sanctioned. The sources of current are two-fold, so the ignition is known as double. Storage batteries and a high-tension magneto are provided, the latter being mounted in an unusual position. This, on a shelf or platform formed by the upper half of the crankcase, is located midway between the groups of cylinders. It is closer to the front end than the rear, being nearly opposite to the first pair of cylinders. It is driven from the camshaft by means of a silent helicoidal gear, and carries the water-pump on its outer or forward end. It turns upon ball bearings, which are arranged to take thrust in both directions, thus caring for any possible thrust either from the pump or from the driving gear. A slip joint in the magneto shaft allows of its ready removal without disturbing the pump or driving arrangement.

Short Bonnet and Low Center Line Very Noticeable.—The construction of the motor is such that it takes up no more space longitudinally than any four-cylinder vertical of the same size would. From this the bonnet is short, much shorter than would be expected from eight cylinders. Another characteristic, noticeable at once, is the low center line. The low flat position of the cylinders allows of the center line being kept very close to the ground. In this way the center line is at the same level, and the straight line drive is obtained.

The first step in the transmission of the power from the motor to the road wheels is a band clutch. The two bands, fitted in a groove on the large diameter flywheel, are attached at their extremities to the ends of pivoting levers, in such a way that they have free movement and can shape themselves freely to the form of the flywheel. To clutch, the pivoted levers are so moved that the bands grip the surface of the flywheel. The operation of these levers is interesting. The inner extremities opposite to the bands carry toothed sectors, which are connected by an inclined shaft. This bears an external toothed gear, the movement of the shaft operating the sectors and the levers.

Three-Point Suspension for Transmission.—The transmission is located back of the middle of the chassis, being hung on a pair of cross members. These are of an inverted U-section, the metal being pressed steel of large breaking area. The forward support is straight, but the rear one is made with a deep drop. The depth is made necessary by the low position of the shaft. The cross member passes down and under the transmission case, while an additional short cross piece stiffens it above the shaft. The latter is of a U-section, and is a casting.

The transmission proper has a number of peculiar features, the speeds are four in number, although the eight cylinders are so flexible and give so even a torque that no transmission would be necessary. Of these speeds, two give a direct drive. The most noticeable point about the gear box is that it contains but two of the speeds and the reverse, the other two being incorporated in the gear box at the rear axle. The box in the middle of the frame gives the first, fourth and reverse. The case combined with the differential housing carries the gears which give second and third speeds.

Unusual Rear Axle and Speed Combination.—From the gear box to the rear axle the drive is carried by means of a propeller shaft and special universal joint. This is on the order of a pair of semi-circular hollow forks, which are free to slide around in the grooves of a spherical block. The latter is grooved in two directions, so that the forks, when in place, lie in two different planes, at right angles to one another. The rear end of the universal forms the clutch, which gives the change of speeds incorporated with this construction. To do this, a freedom of motion along the shaft is necessary, and the peculiar universal joint allows this.

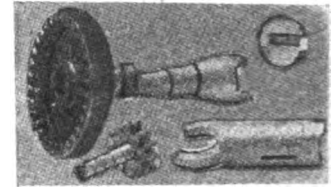

Peculiar Universal Joint.

A differential of the spur type is used, to which two bevels are attached. Two gears on the cardan shaft mesh with these, and by means of the clutch, just described, are thrown into or out of engagement.

The shaft is enclosed in a tube of large diameter and very thick, which acts as a radius and a torque rod at the same time. This forms a part of the rear housing, when in place, and is flexibly mounted at the forward end. From the differential housing of large diameter, to the spring seats, which are formed integral, the axle tube is of a tapering section.

The frame is of armored wood, a double truss reinforcing it between the springs. These are semi-elliptic both front and rear, the rear end of the frame being carried out rather far, and a dumb iron fastened to it carries the spring. The construction is such as to give the impression of a three-quarter elliptic. The front springs are of the very flat semi-elliptic type.

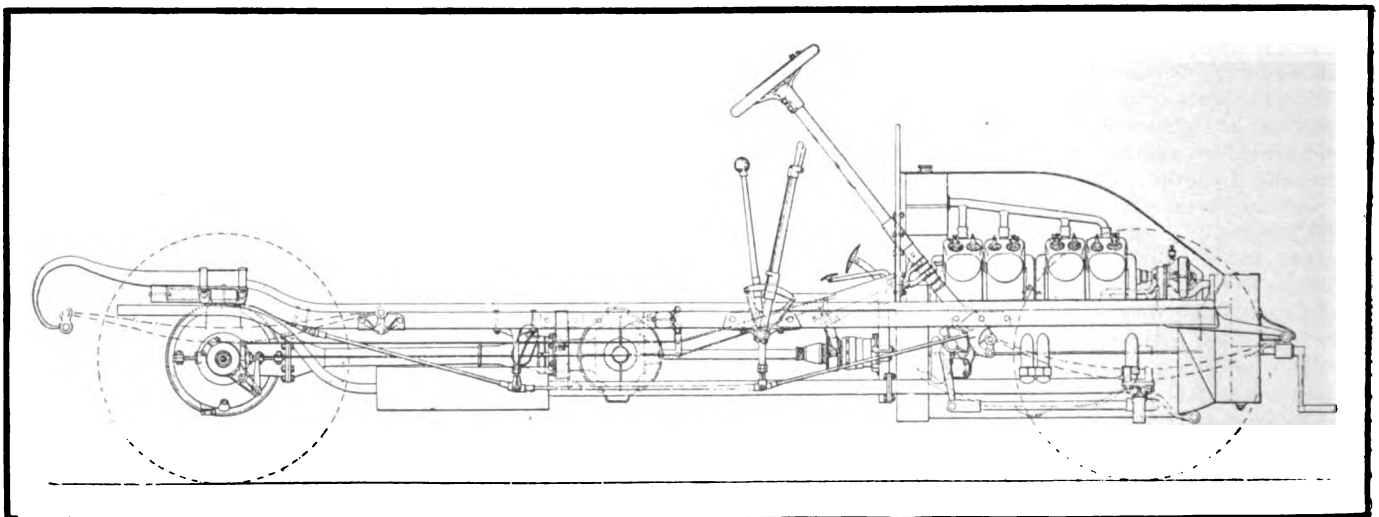

Complete View of the E. N. V. Eight-Cylinder Chassis, with Four Speeds and Armored Wood Frame.

NEW ENGLAND OFFERS MUCH TO AUTO TOURISTS

WHEN one plans an extended tour a great aid is the possession of a map from which one can gain a general idea of the territory to be visited. New England has diversified scenery, excellent roads, and hotels capable of supplying maximum comforts at reasonable prices. While one tourist may desire to plod along leisurely and make the day's run of reasonable length, the next man may find it necessary to utilize his time more sparingly and thus be compelled to drive from early sunrise to late sunset.

Comfort in touring means a good night stop, either in a spick-and-span New England city, or else at some picturesque resort by the seashore or in the mountains. And New England has cleanly cities and towns, rugged, foliage-covered mountains and peaceful valleys, and also possesses a coast line along which one can drive to the music of Old Ocean's ceaseless roar.

As an aid to the thousands of visitors who this season will enjoy six of the original thirteen States, the New England Hotel Association has outlined three tours for those tourists who do not want to be bothered too much in planning their own routes. The association is distributing folders containing a comprehensive New England map on which the three routes are emphasized in such manner as to give a clear idea, and also include a diversity of side trips and unlimited opportunities for "exploring" in all directions from the beaten path. These maps contain a reference to the pages in the "Official Automobile Blue Book," which give the complete running directions. Any one of the hotels belonging to the association will, upon written request, supply the folder maps.

Herewith New England Tour "A" is given and it will be supplemented with Tour "B" and Tour "C." Tour "A" follows the shore line from New York City to New Haven and New London, and then goes to Providence, swings around toward the Cape Cod country, and finally reaches Boston. Northward the route is to Portsmouth, then to Portland and Poland Springs, then the Connecticut River is followed, after which the Green

Mountains are crossed to Rutland. Vermont and western Massachusetts are covered, with the option of returning by two routes from Lenox—one going through Springfield, Hartford and Meriden, and the other by way of Winsted, Torrington and Waterbury. Of course it is possible for one to modify the trip in various ways: for instance, from Boston to Pittsfield, Athol, Greenfield and North Adams, which supplies an interesting cross-State tour. Indications are that New England will see more automobile

tourists during the coming season than ever before since the appearance of the motor-driven vehicle, and the preparations being made insure excellent treatment all along the line.

Another Blue Book Section.—The 1909 edition of "The Automobile Official Blue Book," Section No. 1, for New York, Canada and the West, is off the press. In this edition the Class Journal Company incorporates considerable additional road information throughout the territory. It is a leather-covered volume of 720 pages, covering in more detail than ever before the territory in New York State and portions of Canada, to which is added, for the further convenience of the tourist, the Erie — Pennsylvania—section, whose routes, on account of their peculiar location, enter both the territory of the New York State book, the New Jersey-Pennsylvania volume, and also the Middle-Western volume. In the first part of it is used an

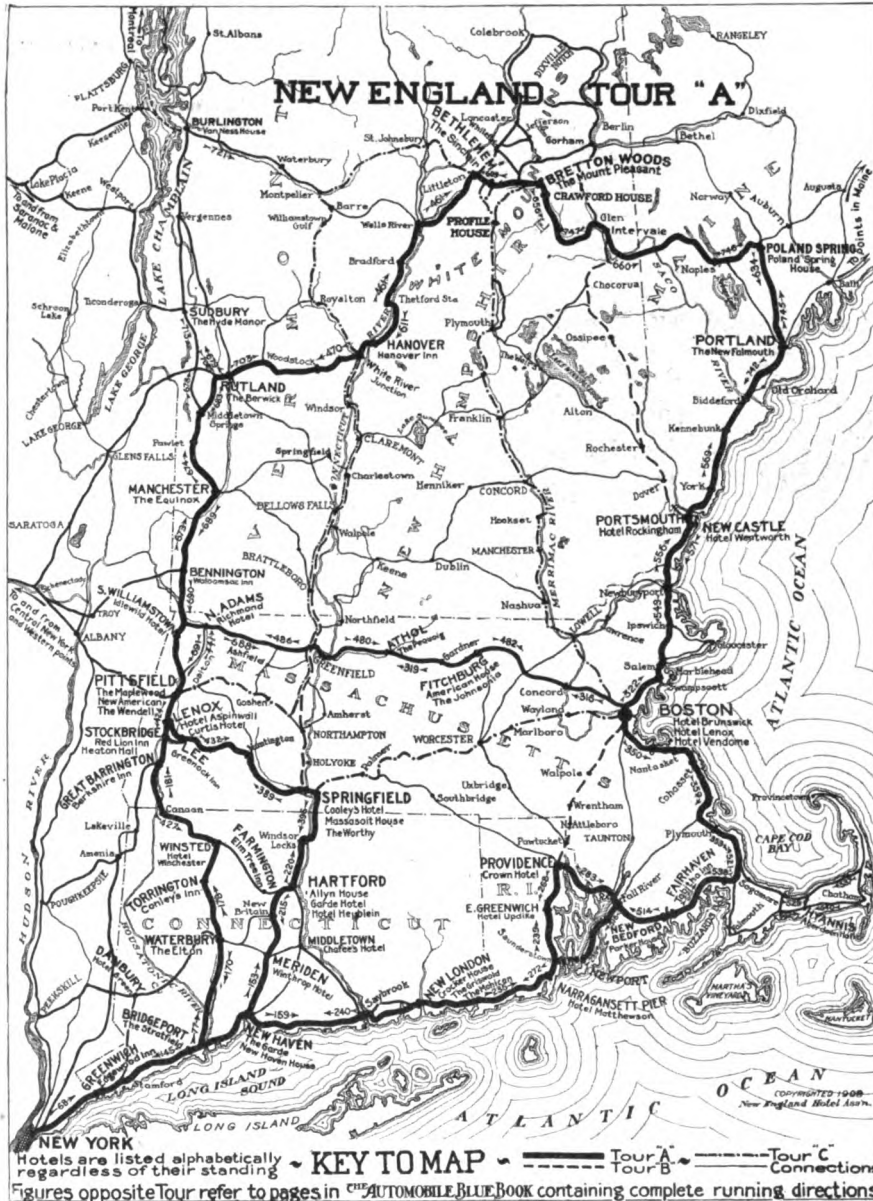

entirely new map of New York State. A new feature is a key supplied this map, which plan is carried into the index by a letter and figure, reference to which will enable the tourist to look up any place desired quicker and easier than has heretofore been possible. The index itself has been broadened in many ways, and a large number of smaller places have been added to the former lists. The great amount of road improvement on the lower west side of the Hudson River has furnished tourists a considerable number of new routes. Of the routes printed for the first time this year, one of the most notable is that from Montreal to Burlington, Vt., which will be found in the Canadian section this year, including odometer mileages, and a map specially drawn.



IN SOUTHERN ENGLAND

WAS NERO'S GERMAN CASTLE



IN ROTTENBURG MARKET PLACE

Why Americans Tour Abroad

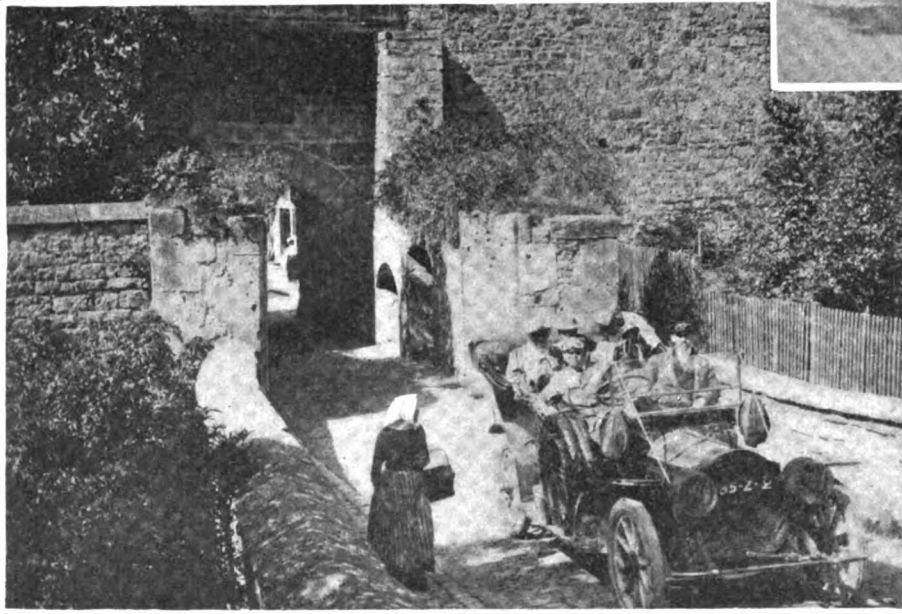

IN A GERMAN VILLAGE



IN HOLLAND



THE GATE OF ROTTENBURG



MONT ST. MICHAEL



PACKARD IN THE BLACK FOREST

AMERICANS FORMULATE EUROPEAN TOUR.

Automobile touring parties who are looking forward to spending the coming Summer abroad are already starting for Europe. Three Franklin cars, respectively from Denver, Oakland, and Salt Lake City, are in the van in this European invasion, with parties that will in their travels cover all the countries between Spain and Norway, Scotland and Turkey. The plans of the tourists are outlined as follows:

From Salt Lake City.—Starting on a tour of no less than ten countries, George T. Odell and party from Salt Lake City recently sailed from New York on *La Provence*, and in the course of the next four or five months they will travel between 6,000 and 7,000 miles, using a six-cylinder car.

Landing at Havre, the tourists will go to Paris and Bordeaux, and thence into Spain, there visiting San Sebastian, Saragossa, and Barcelona. Returning to France on the way to Italy, they will visit Montpellier, Marseilles, and Monaco, and in Italy will follow a route leading through Genoa, Florence, Rome, Milan, and Venice. In traversing Austria the party will tarry at Vienna, and in Switzerland at Zurich. Through Germany, by way of Munich, Stuttgart, Leipzig, and Berlin, the travelers will go to Luxemburg, and thence, by way of Ghent in Belgium, back to France, whence from Calais they will cross to England, going from London to Plymouth, Shrewsbury, and Newcastle. Crossing the Scottish border they will visit Edinburgh, Inverness, Wick, and Aberdeen. Returning through England, by way of Carlisle and Chester, they will make Liverpool their port of departure for home.

From Oakland, Cal.—Setting out on a tour of Europe which will extend over 10,000 to 12,000 miles and continue from six to nine months, Mr. and Mrs. Walter Morgan and Mr. and Mrs. A. F. Cornwall, of Oakland, Cal., are about to sail from New York on the *Rotterdam*. Landing at Boulogne, they will take a Franklin touring car, which has been shipped to Havre by another boat, and thereupon begin their wanderings, which will extend over the Continent and the British Isles.

The first four months will be spent in the countries of the Continent; then will follow two months in and about England, after which the tourists will spend a month in Norway and Sweden. In November they will leave the car and start for Egypt.

From Denver.—Shipping his automobile, a seven-passenger, 42-horsepower Franklin, to London, Dr. J. W. Harris and party will, June 15, leave his home in Denver for a tour of the British Isles and France. Arriving at London, he will tour north to Cambridge and York, and thence to Edinburgh and Inverness, then back to Glasgow, through the Burns country, and will cross to Ireland. The party will take a trip through the north of that island, going then to Dublin and south among the lakes of Killarney. Crossing to Wales, the tourists will traverse the north of that region and on the way back to London will visit the Shakespeare country and Oxford. Going to Folkstone, they will ship the car to Boulogne and will then spend three or four weeks in touring France.

HOYT SAYS AFRICAN ROADS ARE MAGNIFICENT.

NEW YORK CITY, May 3.—After a 5,000-mile motoring trip, Colgate, Hoyt, ex-president of the A. C. A., arrived home recently. He came direct from Southampton, but spent the month previous in Northern Africa, where his party toured from Algiers across an oasis in the desert to Biskra. Thence their route lay through the desert toward the northeast coast of Egypt and finally along the Mediterranean to Tunis, where they took a steamer. Many ancient cities were passed, including Carthage and Kabrouan.

Although warned of brigands, the trip culminated without any untoward incident. Speaking of the African part of the tour, Mr. Hoyt said: "We were all enchanted with the coast roads to the eastward of Algiers. Most of the roads were even superior to those of France. The trip was magnificent, whirling away over mile after mile of sand, ancient cities and historic spots."

MAXWELL PERSONALLY CONDUCTED TOUR.

One of the most novel tours of the Summer will be that which the Maxwell-Briscoe Company are now arranging for the early part of June. This will take the form of a pleasure tour, closed to Maxwell owners and the running schedule will be very easy. The daily mileage will not exceed 100 miles, over the most attractive roads of the eastern parts of New York, New Jersey and Pennsylvania.

No entry fee will be charged, and a number of interested Maxwell owners, who do their own driving, have already signified their intention of taking in the tour.

Starting from New York City, Monday, June 14, the tourists will proceed up the Hudson to Tarrytown, and thence via New Haven and Waterbury to Springfield. From there the route goes through the Berkshires to Poughkeepsie. The third stage will carry the Maxwellites over into Pennsylvania, by way of Port Jervis and the Delaware Water Gap to Philadelphia. Jersey will then be crossed to Atlantic City, where the tourists will rest over Sunday, the 20th. On the following day the return trip to New York will be made, traveling via Lakewood.



Victor Breyer at His Desk in His Paris Office.

FOREIGN A. A. A. TOURING ARRANGEMENTS.

Members of the American Automobile Association who expect to tour abroad this Summer will be interested to learn of the creation of a European touring bureau specially adapted to their needs. The main object of this bureau is to provide all members of the association going abroad with any information or help they may require. Its services are to be entirely gratuitous, except, of course, in cases where unusual expense is involved. The management and direction of this bureau has been intrusted to Victor Breyer, who is well known to the automobilizing fraternity, both in America and in Europe. He has been one of the leading writers of the European sporting press for nearly twenty years, and is thoroughly conversant with the English language, as well as with American methods and customs.

For the benefit of association members who wish to rent cars, either by the day, week or month, arrangements have been made with the best Parisian firms whereby they can secure special rates. Care will be taken to secure good cars and competent chauffeurs, and any complaints will be thoroughly investigated by the association, and measures taken to remedy them. A scale of prices for this service, varying according to power, number of passengers, and distance to be covered, will be sent on application. Mr. Breyer's address is 4 bis, rue Descombes, Paris, France.



NO softer, more delightful automobile touring ground exists than the French and Italian Rivas; and Italy, too, is now becoming the vogue among automobile tourists, as it has been for long years past with all other classes of travelers.

Taken all in all, that wonderful strip of Mediterranean coastline, from Marseilles to Genoa, has not its like on earth for picturesqueness and historic souvenirs, and it is blessed with good roads, too, throughout its length of four hundred odd kilos.

The Riviera gateway to Italy is the peer of all others for making one's entrance into that romantic land. While the Swiss-Italian and Franco-Italian passes are still snow-bound, or running rivers of slush and mud, one may pass the Pont Sainte Louis, between Menton and Vintimille, at sea level, amid the flowering blossoms of an early Spring, and between groves laden with oranges and lemons.

The itinerary is an historic one, and there is not a kilometer of the way but has a reminder of some Roman Antony, or a fleeing Pope, or some confident or down-hearted Napoleon.

We set out to cover the ground again, though already well known to us by road and rail; this time *en auto*. We set out from a little Mediterranean fishing village on the shores of the Golfe des Lions, where we had passed a happy Winter with a crew of artist folk.

The sunsets and the quaint customs of the fisherfolk, and the rare old house fronts, and the canals and quais of Martigues, the Provençal Venice, were quite different attractions from those to be found in the resorts out East, and more, much more, to our liking; and so it was that we had lingered on at that delightful spot the whole Winter through.

Just as King Carnival was sending out his invitations to come



A Niclos Whom We Met While On the Route.

and visit his cities of pleasure of the real Riviera, his *batailles des fleurs*, his *bals* and *fêtes* and *veglioni*, our thoughts turned thither, not to rest within his realm, but to pass through, simply, en route for Italy, where the genuine romance life of the Middle Ages still pursues its course, or something not very far advanced beyond, in many a little town of the Tuscan hills and Lombard plains, unspoiled by any such interpolations as the super-refinements of the Côte d'Azur, the world's loveliest and most dissolute playground. Italy is backward; there is no doubt about that, in the small towns at any rate; though Milan and Turin and Rome are as advanced as "Young Italy" can make them.

We were three, the author-mécanicien-chauffeur and two in the tonneau, when we set out from Martigues. We dodged around Marseilles and its twenty kilometers of horrors in the shape of badly-paved and worse encumbered roadways in and out. The automobilist down from Paris—if he knows his way about, and sticks to the "Route d'Italie" via Aix-en-Provence, leaving that leading into Marseilles to the right—does the same.

Just east of Marseilles we dropped down a red earth hillside into the little town of Cassis, there to renew acquaintance with another artist colony of folk, snugly quartered in the immaculate *chambres hygiéniques* of the quaintly-named Hotel Cendrillon, a modest inn which would never have existed at all had it not been for the initiative of the Touring Club de France, which pointed out the way and showed why and how it should be done. Result: happiness and prosperity for the proprietor, and contentment for the guests. Such a hotel is, of course, a success. Some English and American country innkeepers could get some points at the Hotel Cendrillon, if any of their craft should ever come this way.

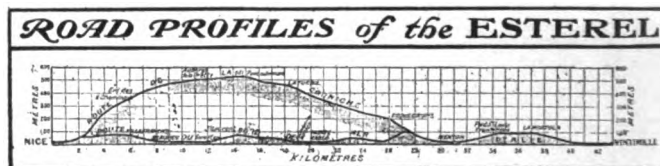

For sheer charm and beauty Cassis runs Martigues a close second, and the hotel is a wonder, and so is the white wine of Cassis, which is drunk as the accompaniment of fish and oysters. For these, and some other reasons, we found Cassis not at all bad, though we had a hair-raising fright as we dropped down the 10-kilometer slope of its hillside, with *lacets* and *virages* that were terrific, finally to land on the very quais of Cassis' little port itself. To get away again it is a 10-kilometer climb skyward, of course.

"Ate and slept well, and off again at daybreak," as Pepys would have said; following the coast-line eastward past Toulon to Hyères, one of the least-traveled itineraries (65 kilometers) of southern France, and one of the most delightfully envired. The main "Route d'Italie" passes through Brignoles and Le Luc, only coming down to the coast at Fréjus, 121 kilometers from Aix-en-Provence. One may take his choice, the main road is considerably "faster," though not much shorter, and decidedly less attractive.

After the magnificent road skirting the Bai de la Ciotat, its great Bec de l'Aigle pushing far out into the Mediterranean blue, the wondrous color of its waters and the green of its shores, one comes to Bandol, an incipient watering place, with a promenade lined with palm trees along the sea front (the gift of some Pacha from Constantinople, exiled doubtless for his country's good) and a "good-enough" hotel (de la Marine), of the conventional order, where one gets tourist fare instead of that of the country. There was another heart-breaking drop down from the road on the height as we came down to sea level at Bandol, but the brakes held and nothing happened. One must go slowly though; these finely-graded and well-surfaced French roads look often less steep than they really are, and it's a mighty easy maneuver to slip down at a dangerous pace when nothing is in sight, but more difficult to pull up suddenly if one has to.

After Bandol it was flat, easy going via the rocky Gorges d'Ollioules, always along the coast, via Sainte Nazaire du Var—where the trade in early Spring hyacinthes and narcissi has completely absorbed the population, who used to make a living at fishing, by Tamaris—where Georges Sand laid the scene of one of her romances, and so on and by Toulon—by Toulon and its great arsenal at *pleine vitesse*, for no one ever stops at Toulon unless he has to—and with good reason. Finally, 18 kilometers beyond Toulon, one reaches Hyères.

We lunched pompously at Hyères, in the vast Hotel des Isles d'Or, amid fifty or more English and American and five lonesome Frenchmen. If you don't care for that sort of thing don't come here, but go to the Hotel de France; it is of the soil and will do you quite as well in the feeding line, though less luxuriously. Having been there before ourselves, we changed off, though for no good and sufficient reason. The next time we are passing this way we shall change back again to the smaller place.



A Monte Carlo Gendarme.

Memories of the days when Robert Louis Stevenson lived at Hyères, and his little villa, which to-day is a notable literary shrine (to us, at any rate), was the only reason for our stopping anyway—not being partisans of tea or golf. Hyères, on the whole, is the most unconvincing French (*sic*) resort that ever was, but its climate is mild and one can play golf, tennis, and croquet without going far afield, and that is why it has become popular with a certain class of homeopathic sportsmen and sportswomen from this side.

Cogolin, forty odd kilometers further on, is quaint and the center of a flourishing industry which makes corks for bottles from the bark of the *chêne-liège*, which is gathered in the neighborhood in vast quantities. The process is interesting, and the young girls who mostly occupy themselves with the various processes are of a specious beauty which defies the author of these lines to describe with full justice. The susceptible should come and see for themselves.

Sainte Tropez for *déjeuner* would have been better than Hyères, for the Hotel Sube makes a *bouillabaisse* that is almost the rival of that of Chabas at Martigues.

"A plat there is in France that's famous,"

sang the poet; and he sang with reason.

Sainte Tropez is another artists' colony, and its "Golfe" is marvelously beautiful, and its top-masted, latteen-rigged barques are like nothing so much as great white birds as they come winging their way home at sunset.



Menton as Seen from the Frontier of Italy.

Sainte Tropez faces north and gets the *mistral*, that dread north wind, with full force when it blows. On the opposite side of the gulf, but facing south, is Sainte Maxime, with a few hundred regular inhabitants and as many more living in the magnificently named Grand Hotel. We gave the town and its hotel the go-by, though the place itself is really delightful. Fréjus was more to our liking; there at the Hotel du Midi we were out of the resort sphere of influence, and ate good, wholesome country fare instead of imitation Paris *plats*.

Fréjus is the deadest town on the map of France, and we ourselves, just here, nearly came to being included in the same category by reason of having run full tilt into a chain which barred the road at a railway level-crossing between Sainte Maxime and Fréjus. It was not an effectual barrier, either, for we tore off the front lamps and one mudguard. One might well be half killed and his automobile entirely wrecked by such idiocy, and yet the train might come along and finish him off before he had time to pull himself together. Some day, after a few more accidents of a similar sort, these railway crossing chains will be plainly marked by a white placque hanging in the middle, or, indeed, they may be suppressed altogether. Meantime automobilists will do well to go slowly on this delightful shore road.

Fréjus is a quaint old relic of Roman days, with its ancient



The FRONTIER



The DOUANE





triumphal arch, its arena, and its aqueduct still tangibly in view—though all are in a shockingly ruinous state. It is for this reason that we love Fréjus more than we do its more highly polished little brother, Sainte Raphael, just beyond, on the shores of the Golfe de Fréjus, now a resort of the first rank—a decadent fall since the days when Alphonse Karr, Gounod, the musician, Hamon, the landscapist, and Fromentin sought to make of it, and keep it, simply a quiet, unobtrusive little retreat.

The road Italywards divides just beyond Fréjus, the main road mounting the inner flank of the Esterels, via Les Adrets and its still existing auberge and its memories of the brigands Robert Macaire and Gaspard de Besse.

Via Sainte Raphael and the now wide-famed Corniche d'Or, that realization of a benevolent project initiated by the Touring Club de France, one of the marvels of modern road making, the road ultimately arrives at Cannes in about the same distance as the inland route, say forty kilometers.

Where Lives M. Baliff of the Touring Club.

To-day the surface of this new-made road is excellent throughout as it twists and turns and rises and falls by the water's edge, hanging perilously here and there on a narrow shelf of rock of porphyry red all the way to La Napoule, just before Cannes. M. Abel Baliff, the president of the Touring Club de France, lives midway along its length. Perhaps it is for this reason that the road is so well kept. We are thankful for such a treat, anyway, for it is the most delightful forty kilometers on earth.

Now commences the classic Riviera, a region we already knew of old, even in good old bicycle days. Its scenic charms are as great as ever; indeed, that strip of coast line from Cannes to Menton, by Monte Carlo's rock and on across the Italian frontier, is without doubt the world's most brilliant panorama.

Cannes, Nice and all the rest now string out for fifty-odd kilometers, a succession of gay playground cities, with all the distractions that pampered humanity can suggest.

In the cities and towns of the Riviera to-day all is as *bruyant* and encumbered as the Rue de la Paix of a mid-November afternoon, and the *corniche* road by the sea, from Nice to Monte Carlo, is now doubly dangerous with a double line of tram tracks and an endless procession of scorching automobiles.

By the "Grand Corniche," up around Mont Gros, the Observatoire, and the Col de Quatre Chemins, is the better route by far, and the view is quite as superb, with Eze and its olive trees and La Turbie and its great Augustan trophy—in memory of that noble Roman's victory over the peoples of Gaul in the foreground, and Monte Carlo, Cap Martin and Cap Ferrat stretching seaward in the background far below.

What hill-climbs there are hereabouts! But what gentle grades they have! No modern automobile will give even a gasp at them; one could mount to the skies on such easy rises as those which climb up out of Nice or Menton via Roquebrune.

After Fréjus we put in the night at Cannes, merely because we had some friends whom we wished to meet, and because the Hotel Beau Rivage had a most convenient garage, and because the hotel itself—though a resort establishment in every sense of the word—was one which catered for an exclusively French clientèle, and therefore omitted the eternal *omelette au jambon*, *bifteck* and boiled mutton from its menu. Did you ever remark the frequency with which the *plats* occur when you, a stranger, take your seat at a *petit table* in a hotel which serves one class

of fare for its table d'hôte and another for "*les étrangers*"?

Coming out from Cannes the next morning we ran over a sheep—which was "playing" in the public road with a dog. The dog escaped, but the sheep became mutton forthwith.

Goats Never Get in the Way.

In the Esterels there is a road repairer who is always accompanied by a pet goat, with a great brass collar and a bell hung around its neck. The goat never gets in the way of an on-rushing automobile which is trying to hold on to its speed as long as possible on the coming rise. It stands simply to one side and eyes the passing crowd with a genuine and intent interest. Wonderful beasts, goats! But sheep and dogs and chickens and small children—they are not in the same class!

The gateways into Italy from Nice and Menton are either via the mountain road over the col de Tende, via Sospel and the Italian Custom House at San Dalmazo de Tende, or via the shore road through the Pont Sainte Louis—where the Italian Customs arrangements take place—and Vintimille.

We chose the latter route on this occasion because we were bound on an itinerary which proposed following the Italian coastline all along to Reggio, where we were to cross to Sicily.

Leaving Cannes or Nice en route for Italy one might plan to take his déjeuner at that little seashore restaurant called the "Roches-Rouges," on the lower road just beyond Menton, on Italian soil. We had planned to do this because of pleasant memories of a former repast. This little Franco-Italian restaurant is really very good, though unpretentious, and you will be regaled while eating by the music of a quintette of smiling Italians, and afterwards have your photograph taken and printed on a half a dozen post-cards—at a cost of three francs—and the loss of ten minutes' time. Quick work!

The Route d'Italie leaves French soil and enters the neutral ground of the Pont Sainte Louis—marked by a great white painted triangle on the face of the cliff above—just beyond Menton. A moment after it boldly circles the face of the Maritime Alps of Piedmont, and in another six kilometers plunges through a tunnel and enters Ventimiglia.

And One Passes from France into Italy.

The Montée Sainte Louis or Avenue de la Frontiere at Menton is well known of all automobilists bound into Italy. Here, at one end of the bridge, is the cabin of the French *douaniers*, where you present your "passavant," giving the details of your automobile in case you propose entering France again. At the other end is the Italian customs bureau, where, between sunrise and sunset, you may enter your automobile temporarily for three months into Italy upon the payment—in gold—(not even French or Italian banknotes being accepted) of two hundred francs for each five hundred kilos of weight. If you have that open sesame, the *triptych*, issued by the Touring Club de France or the allied automobile clubs, showing that you have already paid a similar sum into the coffers of that association, the procedure of passing the Italian frontier is but a matter of minutes instead of hours if you have not supplied yourself.

We, fortunately—for "time is money," as even the Frenchman has learned to say—were in the former class, but a poor unfortunate who followed in our wheel tracks had not taken the same precaution and was forced to weigh up his machine on the spot, calculate the tax, and then go back to the office of the Credit Lyonnais at Menton to change eight hundred francs worth of French banknotes into coin that would be acceptable to the Italian authorities—which he wasn't able to do after all, the bank having closed its doors for the day before he arrived.

We all dined that night at the Hotel de Paris at San Remo (marked in the Annuaire de Route of the Automobile Club de France with a miniature knife and fork and a four-posted bed, indicating that food and lodging are good).

Our acquaintance of the road only arrived four hours after we did, however, and then only because he was able to bribe a customs official to change his notes into gold by the transference of a "Louis"—a ruinous piece of usury. Moral—go prepared!

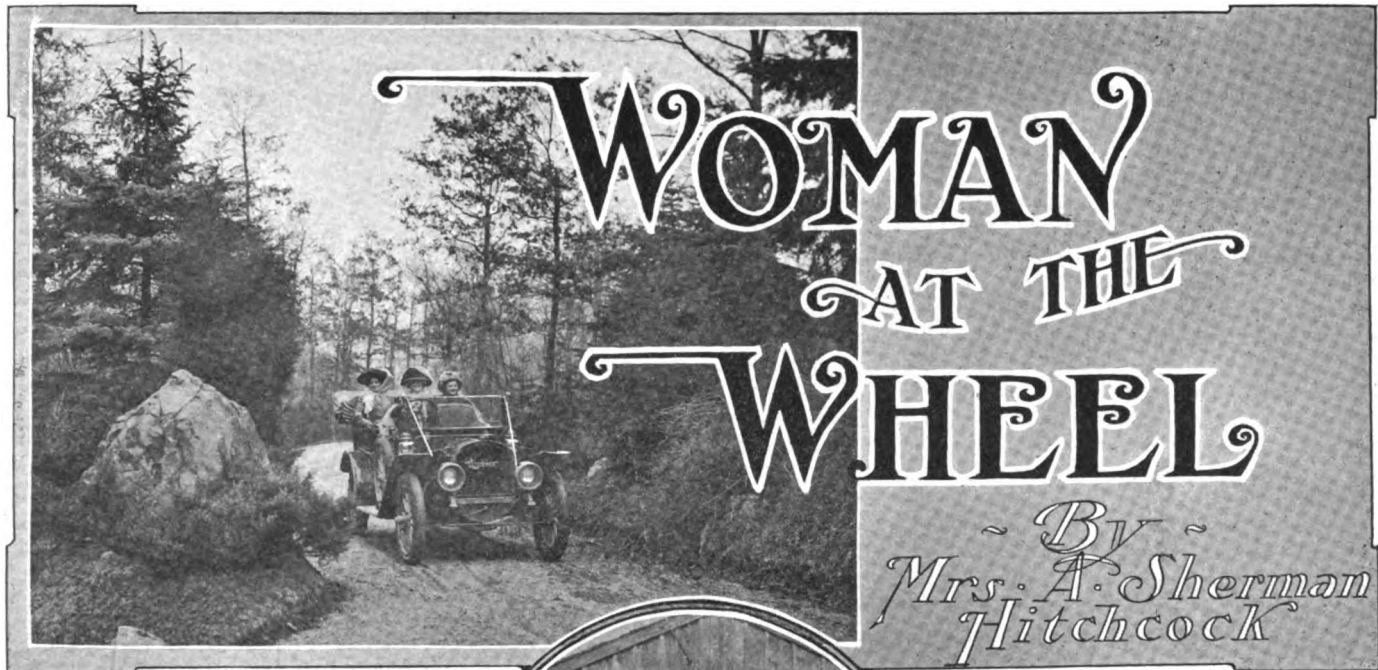

WOMAN who has acquired the ability to drive her car successfully is now speeding over the country highways and through the city parks, while Woman who is a novice watches for her more competent sister with wonder—not un-mixed with envy—and the desire is created to do likewise. The first time a woman operates her car without an expert to whom she can turn in a case of emergency she will have little confidence in her own ability, whether she has been taught by an experienced driver or otherwise.

Lack of Experience Leads to Confusion in Emergencies.—On each occasion when change of speed is necessary, when she has to avoid other vehicles and obstructions to her progress, it is exceedingly difficult for her to bear in mind even the most simple instructions. It is especially necessary at such times to have the car under complete control and to be possessed of presence of mind to do the right thing at the proper time. The ability to judge speed and distance and the knowledge of control are only to be obtained by actual experience; and careful study and keep observation, combined with intelligence, care and discretion, will in a short time give one complete confidence to drive a car with perfect safety. Until one has acquired confidence in herself it is very unwise to try to drive through congested thoroughfares, or in dangerous and out-of-the-way places.

Learning to Drive.—A clear road where there is plenty of room should be found for experimenting, and learning to steer properly should be the first thing attempted. The steering mechanism of a motor car will be found very sensitive to the woman beginner, the slightest turn of the wheel bringing an instant response that is rather confusing at first. The changing of gears should next be thoroughly learned, and to do this the best practice can be had by backing and turning around. This should be done repeatedly until there is an instinctive response to each condition. The woman motorist should avoid

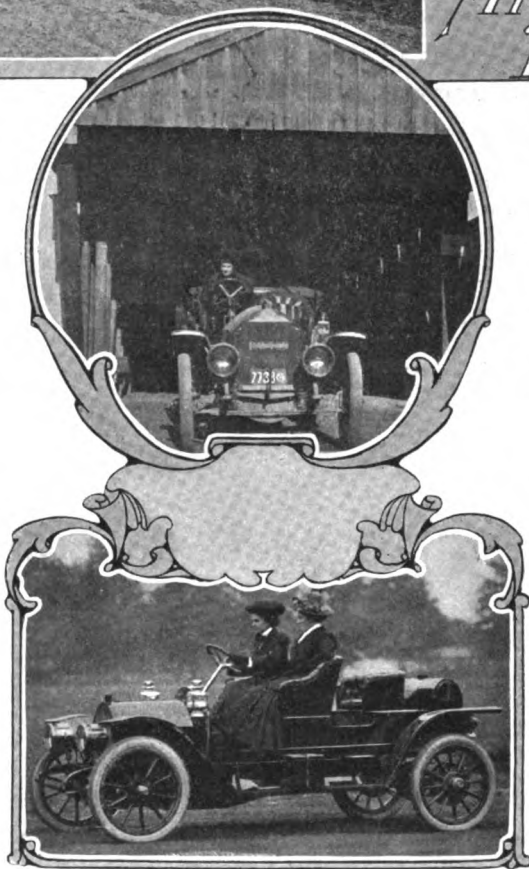

short turns until she has had sufficient practice to insure accuracy of control and judgment. After confidence has been fully established the operation of changing gears on a motor car becomes almost second nature.

Preparing the Car Before Starting Out.—The experienced driver will be able to detect any faults in the motor of the car she is driving and with the knowledge she should possess will usually be able to overcome the difficulty and thus prevent more serious trouble from arising. A woman autoist can never be too well informed regarding the mechanical features of her car, as she cannot always depend on others to help her out in case of trouble. Before starting out the tires should be examined to see whether they are in good condition and properly inflated and all the wearing parts of the car well oiled, particularly the steering pivots and joints of the steering gear and the change gear and brake mechanism. The crankcase, gearbox and differential case should be seen to have a sufficient supply of grease or oil and the gasoline, water and oil tanks

should be filled. The batteries should also be tested before the start and the spark plugs examined to see if they are clean. A good rule for the autoist is to test the brakes daily, the operation only taking a second, but being of the utmost importance for safe driving. No trip should be taken without extra spark plugs and inner tubes, and an extra battery should be provided in case of failure of the regular one.

Strict Attention Must Be Paid to the Driving.—The most important thing to be remembered by the autoist is to keep her attention concentrated on the work before her. It is bad practice to look around, wave to one's friends or become so interested in conversation with one's companion that the responsibility is overlooked, as one is apt to lose control of the wheel, strike a sudden obstacle in the road and dash into a fence, river or sidewalk before it is possible to prevent it. In starting off from a standstill the low gear should always be used,

the change into higher gear being made as the car gathers speed. If starting is attempted on high gear the motor will be stalled, which necessitates getting out and cranking.

Changing Gears and Negotiating Corners.—In general in changing gear time should be taken; one should not attempt getting into the high gear until the speed of the car increases sufficiently and the motor is running strongly. In taking a hill the motor should be given plenty of gas and the car driven up on the high gear as far as possible, but as soon as the motor shows signs of slowing down the change should be made to a lower gear at once. Corners should be taken at a slow rate of speed and plenty of room allowed in case of skidding. The autoist should not take chances, as it is better to lose a little time in slowing up than risking injuring some one or the car. Bumps and cross-walks should be taken at an angle, as it tends to distribute the shock evenly, whereas, if one drives straight over them the whole brunt of the shock falls on the steering gear and front wheels and this in the long run will send the car to the repair shop. Car tracks should be taken at as near a right angle as possible for the same reason.

Precautions to Be Taken in City Streets.—When the autoist has acquired sufficient control of her car to drive on roads having considerable traffic she can next attempt driving on city streets. Here the greatest care must be exercised; turns must be made slowly and obstructions avoided by liberal margins. The autoist must be ready at any time to slacken speed when in doubt as to the course to be taken by other vehicles and equally ready to move ahead quickly when the occasion demands it. When leaving the car standing by the sidewalk or road the emergency brake should be set and the switch plug removed to prevent possible accidents through people meddling.

Motor Faults and Their Detection.—The detection of motor faults is by no means difficult and the majority of them are readily recognized. For instance, an explosion is heard in the muffler. This is caused by too much gas being fed to the motor, and as this gas cannot be fired or exploded it is forced into the muffler, where it is exploded by the heat of the exhaust. Blue smoke from the exhaust is a sign of too much lubrication, but black smoke shows that too much gasoline is being used in the

mixture. If the motor slows down the fault will most likely be in the mixture or due to the battery being run down. If the motor stops suddenly the trouble can be attributed to an ignition fault. If it slows down and after a minute or two starts up again and runs for quite a while it is a sign that the battery is getting weak. Sometimes one cylinder will miss fire, and though the spark plug has been cleaned and examined and seems to spark well when the car is running on the level, it refuses to do duty on a hill being reached, it is a certain sign that the plug is short-circuiting. This may be due to dirt or oil on the inside or because the porcelain is cracked. The remedy is to change the plug for a new one.

When the Motor Overheats.—In the case of an empty water tank where the absence of water has not been discovered until the motor has overheated and the pistons seized, test the cylinders by sprinkling a few drops of water on them. If the water hisses and quickly evaporates do not refill until the motor cools off. Kerosene taken from the lamps can be poured into the cylinders—this can be done while they are hot. If the pistons have seized tightly the cooling process is a slow and tedious one. The careful driver will try to avoid this happening and will take prompt measures to overcome any symptoms of overheating, such as steam issuing from the filling nozzle or water coming out of the overflow pipe while driving. Other symptoms are continued firing after the ignition is switched off or a slight cloud of smoke rising from the motor.

When a Bearing Becomes Hot.—If a bearing should become hot the best and simplest way to cool it is to pour water on it until quite cool and then lubricate well before running again. In new cars the bearings are very apt to run hot. The least looseness in the bearings of a connecting rod or in the main shaft will set up a jarring knock or sound. This noise will speak plainly to an ear that has once recognized it, and if the motion that causes it is not immediately overcome it will prove most destructive. A common cause of loss of power in gasoline motors is poor compression. This may be due either to the piston rings failing to bear smoothly and evenly against the cylinder wall or to one of the valves, usually the exhaust, not closing tight, or not quickly enough.

THE AUTOMOBILE CALENDAR

AMERICAN.

Races, Hill Climbs, Etc.

May 7.....	Birmingham, Ala., Track Race Meet, Police Relief Association.
May 10-13.....	Detroit, Mich, Four-Day Endurance Run, Detroit Automobile Dealers' Association.
May 15.....	Washington, D. C., Reliability Sealed Bonnet Contest, 170 miles, Westminster and return, Washington Automobile Club.
May 18-19.....	Norristown, Pa., Second Annual Endurance Run, Norristown Automobile Club, to Hagerstown, Md.
May 22.....	Hartford, Conn., 200-Mile Endurance Run, Hartford Automobile Club.
May 22.....	Newark, N. J., Third Annual Endurance Contest, New Jersey Automobile and Motor Club, 190 Miles.
May 22.....	Albany, N. Y., Hill Climb, Kenwood Hill, Albany Automobile Club.
May 28-30.....	Denver, Col., Reliability Contest, Pueblo and return, Denver Motor Club.
May 31.....	Wilkes-Barre, Pa., Annual Hill Climb, Giants' Despair Mountain, Wilkes-Barre Automobile Club.
May 31.....	Bridgeport, Conn., Annual Hill Climb, Sport Hill, Automobile Club of Bridgeport.
June 1.....	New York City, Start of Transcontinental Contest to Seattle, for Alaska-Yukon-Pacific Exposition, M. Robt. Guggenheim Trophy.
June 12-14.....	New York City, Catskill-Berkshire Endurance Contest, New York Automobile Trade Association.
June 14-18.....	Philadelphia Reliability Run to Pittsburg and Return, Quaker City Motor Club.
June 17.....	Readville, Mass., Track Race Meet, Bay State Automobile Association.

June 18-19.....	Chicago, Stock Chassis Race for Cobe Trophy and Light Car Race.
June 21-26.....	Binghamton, N. Y., Fourth Annual Endurance Run, Binghamton Automobile Club.
June 22-28.....	Albany, N. Y., Fifth Annual Tour, Bretton Woods, Portsmouth, Boston, Albany Automobile Club.
June 24-26.....	Montreal, Blue Bonnets Track, Race Meet. R. M. Jaffray, Manager.
June 25-26.....	Philadelphia, 24-Hour Track Race, Quaker City Motor Club.
July 3 and 5.....	Wildwood, N. J., Straightaway Races, Motor Club of Wildwood.
July 4.....	Los Angeles, Cal., Southern California Automobile Dealers' Association. Road Races, 250 Miles for Large Cars; 150 Miles for Light Cars.
July 12.....	Detroit, Start of Sixth Annual A. A. A. Tour for Glidden Trophy.
Sept. 6-11.....	Lowell, Mass., Automobile Carnival, Lowell Automobile Club.
Sept. 15.....	Denver, Col., Start of Flag to Flag Endurance Run to Mexico City.
Oct. 7.....	Philadelphia, Second Annual Stock Chassis, 200-mile Race, Fairmount Park, Quaker City, M. C.
Dec. 29-30.....	Philadelphia, Fourth Annual Midwinter Endurance Contest, Quaker City Motor Club.

FOREIGN.

Races, Hill Climbs, Etc.

May 6-9.....	Austria, Small Vehicle Competition, Automobile Club of Austria.
May 8-23.....	Belgium, Antwerp, Sixth International Automobile, Cycle, Maritime and Fluvial Exposition.

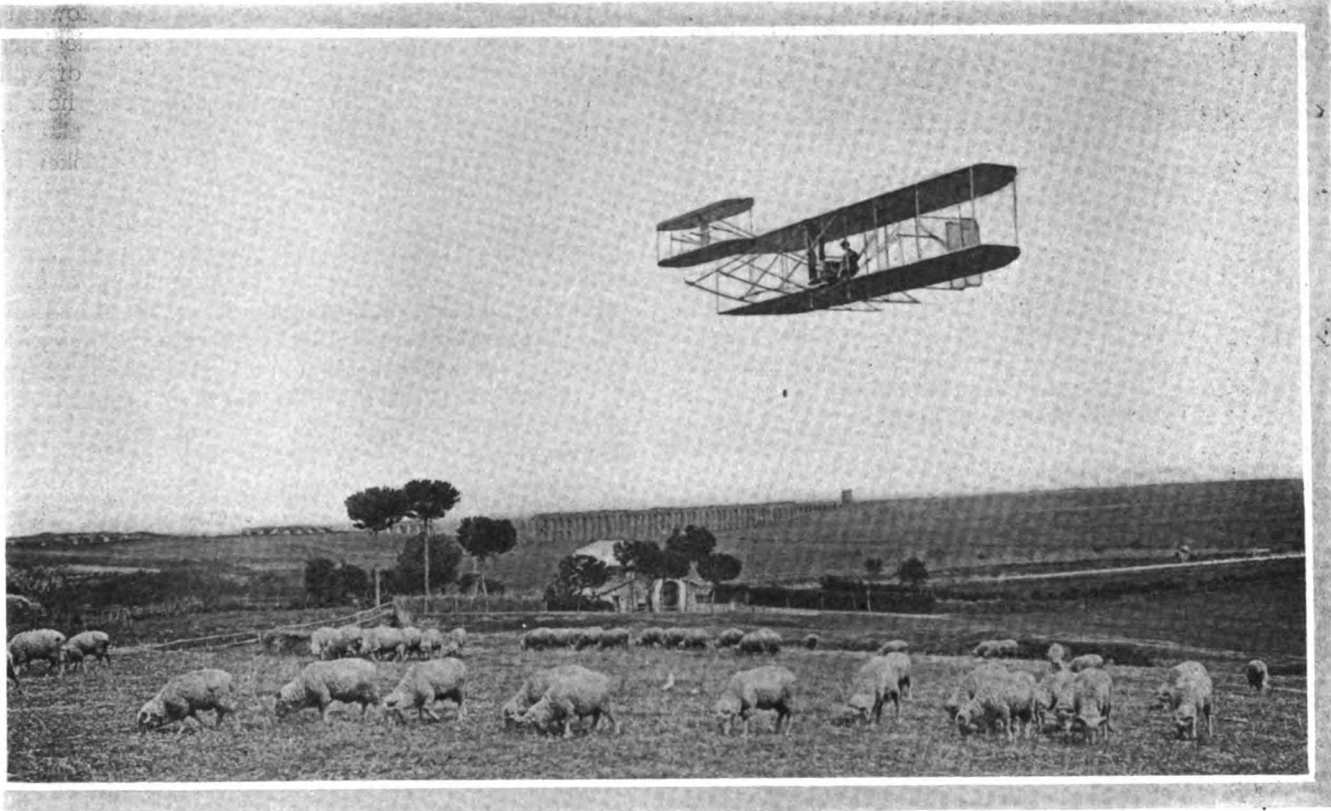

Wilbur Wright Astounds the Romans of To-day by Traveling Over the Applan Way Built Before the Cæsars.

WRIGHT BROTHERS ARE COMING HOME.

LONDON, May 3.—Wilbur and Orville Wright are leaving for America, Thursday, their principal idea being the completion of the trials for the United States Government at Fort Myer, Va.

To-night there was a remarkable demonstration of enthusiasm at the Institute of Civil Engineers, when the Aeronautical Society of Great Britain conferred on the Wright brothers its first gold medal. Those who had gathered at the institution to witness the presentation cheered and applauded repeatedly, while the Wright brothers blushing bore their honors through an hour of the warmest eulogies. Finally the entire assemblage rose up and gave three cheers for each of the brothers. They sang "For They Are Jolly Good Fellows," and ended by cheering Miss Katherine Wright. Sir Henry Maxim, Lieut. Col. Baden-Powell, Capt. F. S. Cody, an American, who is struggling, but thus far unsuccessfully, to perfect his own aeroplane for the British Army, and a large number of scientists and ladies were present.

Col. J. E. Capper, the War Office's aeronautical expert, referred to the Wright brothers as "unspoiled, as though they were nobodies," and declared that the nation which failed to keep pace with the flying developments might get badly left in war.

Both Wilbur and Orville Wright made speeches, tersely expressing their thanks. Earlier in the evening they were guests at a dinner at the Ritz Hotel, given by the Aeronautical Society.

The Wrights had a conference with War Secretary Haldane to-day, but the War Office is not likely to conclude arrangements with the inventors until their aeroplane has had a trial in England in the presence of experts. Their engagements in the United States and Germany, however, preclude the possibility of their being able to attend this personally for some months.

MAINE NOW HAS AN AIRSHIP COMPANY.

PORTLAND, ME., May 3.—That the men of the "Pine Tree" State are progressive is shown by the incorporation here of the Flying Auto Company, which will manufacture and sell aeroplanes and dirigible balloons. The capital stock under the terms of the incorporation is to be \$1,000,000.

FIRST WRIGHT FLYER GOES TO MUSEUM.

PARIS, May 1.—After a short but glorious career, Wilbur Wright's aeroplane, the one which went through the French campaign of 1908 and showed the world that flight was a reality, is about to be put in the Arts et Metiers Museum in Paris. According to the contract passed between the Wright brothers and Lazare Weiller, the machine should become the property of the French committee on fulfillment of the contract. This has now been done; but the committee, having no practical use for the machine, has decided to present it to the Paris museum, where it will occupy a position by the side of Ader's Avion, the first flying machine in Europe to rise from the ground, with Cugnot's steamer, built in 1770, and considered the father of the modern automobile, as a very near neighbor.

The Wright machine thus secured for the Paris museum was brought into France last year at a time when only one other similar apparatus existed. The other one was then in the hands of Wilbur Wright, but was practically put out of commission in the unfortunate accident at Fort Meyer. Both machines had been entirely built by the two brothers, even the engine being their own handiwork. The Wright aeroplane made its first public appearance on the Hunaudieres racecourse near Le Mans, but after a few short distance flights was removed to the Camp d'Auvours, further out of town, where its last flight was the winning of the Michelin prize by a journey on the last day of the year, lasting nearly two hours.

Now Wilbur Wright is using a French-built machine—made of American wood—and even his motor has come from a French factory. Fifteen of his machines are in actual service and others are almost ready for launching. Thus it was possible to remove the most glorious of them all from the flying ground and place it on a pedestal in a crowded city museum.

Gross II, Germany's New Airship, is to be stationed either at Metz or Cologne, on the German-French frontier. The dirigible is driven by two eight-cylinder Koerting motors of 75-horsepower each.



Vol. XX.

Thursday, May 6, 1909

No. 18

THE CLASS JOURNAL COMPANY

H. M. SWETLAND, President

281-241 West 39th Street, New York City

EDITORIAL DEPARTMENT

A. G. BATCHELDER, Managing Editor

R. F. KELSEY, Associate Editor

THOS. I. FAY

MORRIS A. HALL

W. MCKEAN WHITE

W. F. BRADLEY, Foreign Representative

BUSINESS DEPARTMENT

A. B. SWETLAND, Business Manager

LOUIS R. SMITH

FRANK B. BARNETT

W. I. RALPH, 1035 Old South Building, Boston, Mass.

C. H. GURNETT, 1200 Michigan Ave., Chicago, Ill.

F. W. VAN SICKLEN, Detroit, Mich.

H. H. GIEL, Philadelphia, Pa.

T. B. VAN ALSTYNE, Philadelphia, Pa.

Cable Address - - - - - Autoland, New York
Long Distance Telephone - - - - - 2046 Bryant, New York

SUBSCRIPTION RATES:

United States and Mexico	- - - - -	One Year, \$3.00
Other Countries in Postal Union, including Canada	- - - - -	One Year, 5.00

To Subscribers—Do not send money by ordinary mail. Remit by Draft, Post-Office or Express Money Order, or Register your letter.

FOREIGN SUBSCRIPTION AGENTS:

ENGLAND:—W. H. Smith & Sons, Ltd., 186 Strand, London, W. C., and all book-stalls and agencies in Great Britain; also in Paris at 248 Rue de Rivoli.
FRANCE:—L. Baudry de Saunier, offices of "Omnia," 20 Rue Duret, Avenue de la Grande Armée, Paris.
GERMANY:—A. Seydel, Mohrenstrasse 9, Berlin.

Entered at New York, N. Y., as second-class matter.
The Automobile is a consolidation of The Automobile (monthly) and the Motor Review (weekly), May, 1902, Dealer and Repairman (monthly), October, 1903, and the Automobile Magazine (monthly), July, 1907.

ENDURANCE TESTS NOWADAYS.

Clean scores in profusion will not be features of the endurance runs and contests of the current season. Once it was undoubtedly necessary, in order to demonstrate to the general public the reliability of the motor-driven vehicle, to have events wherein the rules duplicated in some degree the actual touring conditions which a man might meet with in a cross-country run. But the buying public has come to realize that the average automobile answers satisfactorily to the needs of any reasonable owner, and hence, in order to make contests valuable and at the same time to retain general interest, the rules must be drafted in such manner as to call for a more rigorous scrutiny of the survivors than in previous years.

This doesn't mean, however, that all the glory goes to the car which evolves as the winner, for all others performing creditably and in excess of what is demanded by the amateur owner are certain to obtain a commensurate amount of publicity for participation. Of course, in the big, complicated and long-distance contests competitors are certain to be few unless they have resources tracing back to the factory itself. In events of a local character the tendency is toward contests wherein the real amateur can compete against his own kind, and thereby extract a profitable and pleasurable experience. Meeting with other fellow autoists he gains much from observation of their methods, and, furthermore, there is

certain to be a greater spirit of helpfulness toward one another than is usually the case wherein trade interests somewhat interfere with candid expression of opinion and opportune aid in the way of suggesting how some remedy will meet the needs of the situation.

It is a difficult matter for the average onlooker to realize that things other than speed are involved in the running of a contest, and in consequence the repeated injunction of "Hit it up!" is certain to be heard for some time to come. The discriminating public, however, is beginning to learn that economy of operation and proven reliability are greater factors than speed in determining as to the car which best supplies all around utility.

True it is that there will be those who think that they must have excess speed, but the long distance traveler will continue to miss half of the delights of the healthful pastime in which he indulges in a swirl of dirt and leaves behind a trail of cuss words from those who consider him both partially insane and criminally inconsiderate of other users of the road.



NOW THE SLIDE VALVE ENGINE.

In the wake of the success of the British-Daimler slide valve engine, known as the Silent Knight, because of its American inventor, will doubtless come a number of motors along similar lines. This success was accentuated by the unusually severe tests to which the engine was subjected by the committee of the Royal Automobile Club.

The tests were such as very few makers of automobile engines would care to subject their products to, but in this case the Daimler company found it necessary to prove in an undoubted fashion the efficiency of their new motor. The discussion of this gained volume as time went by and no facts were forthcoming. Then it assumed the form of doubt and acrimonious reflections. Finally, the very life of the company being in jeopardy, in default of proof, the company decided to make a public trial that would prove once for all that their foster child was all that they had claimed for it.

The result of that trial is now well known, and with the publication of it the most carping of critics has become a rabid adherent. Any engine which can maintain for 132 hours a power output in excess of its rating, amounting to 42 per cent. of that rating, or that can maintain for five hours an output of 50 per cent. in excess, is good enough for anybody, regardless of principle or methods of construction.

If, in addition, a car equipped with the selfsame engine can run, immediately thereafter, a distance of nearly 2,000 miles on a basis of over 35 ton-miles per gallon—35.46 to be exact—it is then apparent that the engine is not only a good one, but a remarkably fine product and probably superior to many of the ordinary motors with mushroom valves.

This test and its unusual conclusion, without a particle of doubt, marks the beginning of an epoch in automobile engine design and construction—the slide valve epoch. While the engine of the automobile of to-day has improved in such marked degree that its earliest predecessor beside it looks like a bunch of junk, the final word has yet to be said, even though the improvement should be painstakingly gradual.

HOW NEW YORK OBTAINED A LIBERAL LAW

ALBANY, N. Y., May 3.—By the time this summary of what motor-vehicle legislation has been secured in New York this year is ready for issue, Governor Hughes may have signed the Hamn bill which outlines the new motor-vehicle law. Again, he may not, as the bill is among those the Governor may hold for 30 days. This bill embraces practically all there is to motor-vehicle legislation this year. In its Senate form it was killed by amendments in the Assembly, and was rescued in its Assembly form only the day before final adjournment. Its history is the story of the year on the subject.

It will be recalled that a year ago when the Legislature adjourned an agreement had been reached after several conferences and a bill introduced by Senator Armstrong and Assemblyman Hamn which contained no miles-per-hour clause and had an annual registration fee for autos. It did not pass, nor could the Governor be induced to recommend it for the extra session.

This year Senator Allds, who succeeded Senator Armstrong as the head of the finance committee, and Assemblyman Hamn reintroduced the old eleventh-hour bill of 1908 very early in the session. But nothing was done for three months. In fact, it became the policy of the autoists to press no sort of legislation of a general character, but to wait and ascertain what the Legislature was to do with Governor Hughes' recommendation that the registration fees on autos should be increased so as to provide a respectable fund for the repair of the improved highways of the State.

There was the usual grist of freak, hostile and restrictive legislation introduced, but the legislative leaders in both houses put a crimp in it from the start, and no committee reported a bill or bothered anyone with hearings on the bills.

Finally there was a conference called by the legislators at which the New York State Automobile Association, backed by the A. A. A. and the N. A. A. M.; and the A. C. A. and a few others, met and agreed without much difficulty on a bill which repealed the old motor vehicle law and substituted a new and revised motor vehicle regulation code, the chief feature of which was the abolition of the speed limit provisions of the old law and the substitution of a fair and equitable proposition putting motor-driven vehicles on the same basis as other users of the highways. Another feature was making horsepower the basis of tax or license fees and taxing the autoist for his registration certificate and number \$4 a year for machines of less than 20 horsepower; \$6 for those less than 30 horsepower, and \$10 for all over 30 horsepower.

There were other new features, such as a licensing of professional chauffeurs and the issuance of different colored badges each year; the prohibition of permanent anti-skidding devices on wheels; the establishment of a \$50 fine penalty, which is the limit of the jurisdiction of the country justice, thus taking out the absurdity of the old law where a fine of \$100 and more was decreed, notwithstanding no justice in the rural districts could constitutionally impose a fine of over \$50. There was at first a \$2 fee for chauffeurs on commercial vehicles, but as this created classes it was deemed unconstitutional and dropped, the final draft of the bill making the chauffeur's fee flat at \$5.

When the bill was first printed it left the enforcement through the collection of registration or license fees and badge or certificate issuing to the Secretary of State. Samuel Koenig, a Republican State committeeman, occupies that office now. He went to the legislative leaders before the bill passed the Senate and demanded more money to run that bureau in his office. Senator Allds, as head of the financial committee of the Senate and also introducer of the motor-vehicle law, did not coincide, and when the Secretary of State made the bluff that he did not want the bother of the auto tax collection, Allds promptly amended the bill to give the whole business to the State Highway Commission (where it properly belongs, as the motor-vehicle law is to be a

section of the State highway law and was so passed). The bill passed in that shape under an emergency message from Governor Hughes, who was undeniably interested in its passage.

Then Koenig got busy with the Assembly. Assemblyman Hamn did not amend his bill as he was supposed to do and exclude the Secretary of State. He left it in the rules committee, and Senator Allds' bill was reported out. On the floor of the Assembly the next day Secretary of State Koenig's friends joined with the rabid, rural anti-auto Legislators for two things: to either change the Allds bill to put the collection of fees in the Secretary of State's office and cut out the State Highway Commission or to emasculate the bill and let it die.

Assemblyman Howard, of Tioga, who wanted a speed limit, the making of all regulations by villages, towns or cities without reference to what other regulations were made, and a higher tax, put his amendments up, and on a rising vote they were carried and put in the bill. That killed the Allds bill so long, as the amendments remained in it. It could not be printed in time to pass regularly, and none would ask the Governor for an emergency message, and the autoists would not vote for the bill anyway while in that shape. The same night there was a conference with Sam Koenig, and on condition that the Hamn bill—identical with the Allds bill just amended save that it retained the Secretary of State as the fee collector—be passed the Koenig squad was called off from the opposition forces. As a further compromise and sop to the rural anti-auto legislators, the speed section was amended to take in the Connecticut law, making 30 miles an hour presumptive evidence of reckless driving when something happens. The "rules of the road" unintentionally omitted in the Senate bill were also put in. This and a few verbal amendments were all the changes in the bill, and thus the measure was practically what had been agreed upon before the bill started in the Senate.

This was passed in both houses the same day, and is now before Governor Hughes for his signature. It is the broadest gauge motor-vehicle law on any statute book, and purposely continues to omit that petty retaliation clause, which some autoists desire to have in, requiring every auto owner from another State where New York's license certificates are not recognized to take out a license here.

What takes the place of the old speed limit is section 287, and as amended in the Assembly when passed, reads thus:

"Every person operating a motor vehicle on the public highways of this State shall drive the same in a careful and prudent manner and at a rate of speed so as not to endanger the property of another or the life or limb of any person; provided that a rate of speed in excess of 30 miles an hour shall be presumptive evidence of reckless driving."

The rules of the road, to turn to the right when meeting and to the left when overtaking and passing, etc., are now in the bill to be a part of the highway law.

The Hill-Robinson bill to make joy riding a penal offense punishable as larceny went through, and to the Governor as a code amendment. It is provided for in the new motor-vehicle law, where both joy riding and malicious tampering with an auto is made a misdemeanor, and the chauffeur or other person may be fined \$100 for doing it and sent to jail for six months and may also be suspended from privilege of operating an auto, if a chauffeur.

Secretary of State Koenig a few minutes after the Hamn automobile bill was passed, received a letter from William H. Hotchkiss, State Superintendent of Insurance, applying for license 1 under the new law. This is the first application received by Mr. Koenig. Superintendent Hotchkiss gave a full description of his touring car, his home address as 20 Lincoln parkway, Buffalo, and said that as soon as the blanks are issued he will be pleased to send in \$10 for license No. 1.

STUDEBAKER PURCHASES CONTROL OF E-M-F COMPANY

DETROIT, May 3.—One of the most interesting deals with which the automobile world has ever been acquainted was consummated here Saturday when William E. Metzger, B. F. Everett and William Kelly transferred their interests, aggregating about one-third, in the stock of the Everett-Metzger-Flanders Company to the Studebaker Automobile Company, of Cleveland. The change involves a complete reorganization of the Everett-Metzger-Flanders Company, W. E. Flanders becoming president and general manager, C. L. Palms and Dr. J. B. Book remain on the directorate, and the new stockholders will secure two directors, one of whom will be Hayden Eames, of Cleveland, and the other Fred. S. Fish, general manager of the Studebaker Wagon Company, of South Bend, Ind.

Not the least important feature in connection with the deal, both to this city and the trade at large, is the entrance of the Studebakers into the automobile field on a scale in keeping with their operations in the vehicle line. Studebaker cars are well and favorably known, but this places the concern in the forefront in the medium-priced field that has already proved so profitable. The Studebaker Automobile Company, which is under their direct control, will after September 1 next become sole distributors of the E-M-F. "Thirty" cars.

The price paid by the Studebaker Automobile Company for the Metzger-Everett-Kelly stock is not made public, but it is known to have been between \$700,000 and \$800,000. This furnishes some interesting information regarding E-M-F affairs. The company was organized eight months ago, succeeding the old Wayne Automobile Company. Its capitalization was \$1,000,000, of which Metzger and Everett held one-third, Kelly's interest being about

\$75,000. In the transfer just made the two former are known to have received approximately \$4 for every dollar of money they had invested.

That the price paid by the Studebaker company was not exorbitant, but that, on the other hand, it must be regarded as a gilt-edged investment is shown by the fact that during the eight months it has been in existence the net earnings of the E-M-F company have been \$800,000. Not only this, the business is exceeding all expectations, the daily output of "Thirties" now being between 65 and 70.

The success of the concern is directly attributable to the efforts of two men—W. E. Flanders and E. LeRoy Pelletier. Flanders is recognized as one of the foremost factory men in the automobile world, and the fact that the E-M-F company will produce 7,500 cars this season reveals his ability in this direction in an unmistakable manner. Pelletier, whose fertile brain is responsible for tons of bright "copy," has made the E-M-F "Thirty" famous throughout the land. The change will in no way affect him, as he will remain as advertising manager of the reorganized company.

It is rumored that James Heaslett, formerly with the E-M-F company, will be made chief engineer, taking the post Mr. Kelly occupied. Mr. Heaslett is well known to the trade, having been identified with the Rainier and other companies as engineer. He designed practically all the Studebaker cars. Messrs. Metzger and Everett have not determined what they will do in the future. Both will spend some months traveling in Europe, taking life easy until next Fall, when there are intimations that they will once more enter the automobile field.

"OVERLAND" NEWS FROM TOLEDO.

TOLEDO, O., May 3.—The Kinsey Manufacturing Company, of Dayton, will move to this city about the first of July, and after that date will be maintained as a subsidiary concern to the Overland Automobile Company. The Kinsey Manufacturing Company is a large manufacturer of automobile parts, the principal portion of its output having been absorbed to date by the Stoddard-Dayton and the Overland companies.

Isaac Kinsey, principal owner of the concern, has sold his interests in the Dayton plant to the Dayton Motor Car Company, which will continue manufacturing automobile parts on a reduced scale, while the company proper will be removed to Toledo. This procedure was followed that the company's name might be transferred to the business in this city.

That Hitch in Pope Sale to Overland.

A temporary hitch has been experienced in the transfer of the Pope Motor Car Company's plant to the Overland Automobile Company. When the local concern built several additional buildings some years ago they were located on some of the city's property, which consisted of an unopened street. Now, in negotiating for the sale of its property, the Popes are unable to give a clear title, and the purchasers desire a bond insuring them from any trouble, a thing which the Popes will not agree to do. It is likely, however, that the city will vacate the street and give a good title, as the street is only 600 feet long and is in a part of the city which will never allow its being needed.

CARRIAGE CO. TO BUILD AUTO WHEELS.

The Shortsville Wheel Company, of Shortsville, N. Y., is preparing to go into the manufacture of automobile wheels, in addition to continuing its manufacture of carriage wheels, and has purchased a complete outfit of machinery for the purpose from the Defiance Machine Company, Defiance, O. The new department is to be entirely separate from the carriage wheel plant, and it is expected that a new factory will be erected in the Fall.

NIEUPOORT MAGNETO WORKS FOR DETROIT.

DETROIT, May 3.—While complete details are lacking, it is known positively that the Nieupoort Magneto Company, makers of the famous French magneto, will in the near future establish an American branch in Detroit. The men interested in the enterprise have been looking over American territory for some time with a view to selecting a location for a plant. The clinching argument was supplied when a local automobile manufacturer expressed his willingness to contract for a large number of Nieupoort magnetos, provided they were manufactured here.

Whether the company will manufacture magnetos in their entirety at the outset, or import the parts and have the assembling done on this side, depends largely on the success met with in securing a sufficient number of skilled employees. However, it is the intention to ultimately build a plant that will furnish employment to several hundred persons, next year's output of magnetos being placed at 25,000. French capital will, it is understood, hold a controlling interest of 51 per cent., the rest of the capital being supplied by Americans.

Zeglen May Locate in Detroit.

Detroit also may shortly number among its industries a factory devoted to the manufacture of a puncture-proof and impermeable automobile tire. C. Zeglen, of Chicago, has been here for some days looking for a site for a factory for the manufacture of auto tires that will employ in the neighborhood of 2,000 persons. Zeglen is maker of a bullet-proof cloth, and controls patents for a puncture-proof tire composition.

YORK ALSO MAKES ITS ENGINES.

YORK, PA., May 3.—The York Motor Car Company desires to have it unmistakably known that in addition to the manufacturing of its parts, it also makes its own engines. An article in THE AUTOMOBILE of recent date excepted the engines, and the York company desires to have the fact known that such is not the case, for it particularly prides itself upon the motor of the car.



General Managers Miles and Reeves Were Treated to a Tour of Fulton County and Were Guests at a Fried Chicken Supper.

MILES AND REEVES FIND FOR ATLANTA SHOW

ATLANTA, GA., May 1.—When S. A. Miles and Alfred Reeves, heads of the two big national associations of automobile manufacturers, returned to New York last night they had tentatively announced the dates of Atlanta's first show as November 27 to December 4, and also had made careful plans for the arrangement of exhibits in the big new Auditorium-Armory.

Atlanta's show has been in the air now only a few months. It was proposed by Atlanta's newspapers and worked up by the Atlanta Auto Trades Association, an organization formed for that very purpose; the Fulton County Automobile Club, and the Atlanta Chamber of Commerce. A few months ago delegates from these bodies went to New York and won over the joint approval of the big manufacturing associations.

This visit to Atlanta of the representatives of these organizations was the result, and the city spread itself to give the delegates a good impression. There were meetings with the Atlanta organizations interested, a careful inspection of the Auditorium-Armory, a tour of Fulton County in a fleet of Whites, and a regular "fried chicken supper" at the Fulton County Automobile Club's new house.

It was at the meeting of the directors of the Chamber of Commerce at which the show proposition was definitely completed. Those present, besides Messrs. Miles and Reeves, were:

President Candler, President Edward Inman, of the Automobile Club of Fulton County; E. W. Gans, president of the Atlanta Auto Trades Association; Major John S. Cohen and Clark Howell, of the Atlanta committee, who went on to New York and secured the show; S. E. Davidson, Frank Weldon, Frank S. Ellis, Rawson Collier, Asa G. Candler, Jr., Beaumont Davison, F. L. Seely, F. J. Paxon, D. Woodward, V. H. Kreigshaber, Mell

R. Wilkinson, H. A. Maier and Secretary Walter G. Cooper, of the Atlanta Chamber of Commerce. The contract as drawn up between the Atlanta committee and the National Association of Automobile Manufacturers was read, and the Chamber of Commerce gave its unanimous sanction and approval.

Clark Howell, at the request of the meeting, outlined the preliminary steps which led up to securing the sanction of the two automobile associations upon the Atlanta show, and secured an agreement whereby the two associations which hold shows at different times and in different buildings in New York City each year will work together in the Atlanta show just as they have done heretofore only in Chicago.

A New York-Atlanta reliability run has been scheduled to precede the opening of the show, the New York *Herald* and Atlanta *Journal* being the most energetic in the project.

The Auditorium-Armory in which the first big show in the South will be held is a by-product of an effort to have an exposition in Atlanta in 1910. About \$250,000 was raised for this purpose, but that was not considered enough to give a suitable "world's fair," and the men who had subscribed the money agreed to lend it to the city of Atlanta for the purpose of building an auditorium. The city agreed to pay back something like a third of the amount this year and gave it as an opinion that future administrations would pay back the remainder in smaller installments. The men who had put up the money agreed to take the chance, and the building was constructed. Committees of citizens and the architects examined every big auditorium in the country, spending weeks of time and thousands of dollars before they decided on plans. The result is a building which is as admirably suited for an auto show as it is for other purposes.

GEORGIA WANTS MORE AUTO RACING.

SAVANNAH, GA., May 3.—The three-day race carnival which is to be held in Fitzgerald, Ga., June 15, 16 and 17 is attracting wide attention just now in the automobile world. The course will be guarded by the State troops just as the Grand Prize race was in Savannah, and the races that are to be run are promised to be the best the South has had since the Grand Prize race.

If nothing about the Grand Prize race is heard from the Automobile Club of America in a very short time, steps will be taken by the Savannah Automobile Club to secure a race. It has been said that many of the members of the Savannah club are in favor of having their own cup, and if nothing develops it is probable that this will be done.

HARTFORD DEALERS RE-ELECT OFFICERS.

HARTFORD, CONN., May 3.—At the annual meeting of the Hartford Automobile Dealers' Association the following officers were re-elected: President, Ralph D. Britton; vice-president, Louis H. Elmer; secretary, S. A. Miner. The association already has plans under way to the 1910 show, which is to be held the second week in February. The following show committee was appointed: T. Dudley Riggs, chairman; B. F. Smith and R. D. Britton. Mr. Riggs resigned as chairman, and B. F. Smith was substituted. A uniform schedule for care and storage of cars was adopted, as follows: Storage for touring cars by the month will be \$20, and \$15 for runabouts. This price, it is announced, also includes washing and polishing of cars.

REAL ROADS AND SCENIC BEAUTY FOR JERSEY ENDURANCE RUN

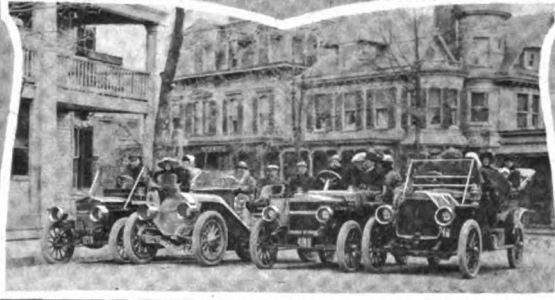

H. A. Bonnell, F. A. Croselmir, J. H. Wood and W. C. Crosby



Going down
Mendham
Hill

Jersey
Has
Picturesque
Little
Lakes.

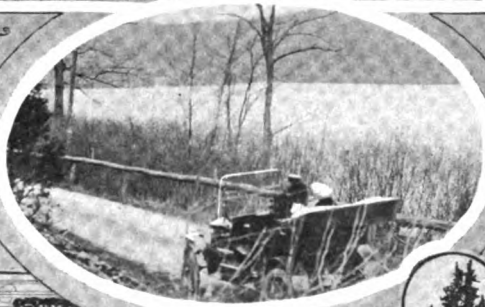

New Jersey still building roads; near Cranbury Lake.

NEWARK, N. J., May 3.—Arrangements are practically complete for the amateur endurance run of the New Jersey Automobile and Motor Club, scheduled for May 22, over a 95-mile circuit, which will be twice covered, thus giving a total distance of 190 miles.

Of course the start will be from Newark, and Hackettstown, 42 1-2 miles exactly half way, will be the only other checking place. The route includes some of New Jersey's best roads and most picturesque scenery, but there are some stretches of highway which could be improved upon.

To Hackettstown the course is one long ribbon of macadam, with the exception of Schooleys. Then comes the run through the prettiest section of country touched by the tour, near Tran-

quility. Beyond there will come the crucial test. If it is rainy during the run, or just preceding it, the drivers will have their hands full in reaching Stanhope with clean cars or clean scores; if it is dry and the weather is fine, they will encounter roads that are not macadam and which in some parts may be partially blocked by road repairing operations, but nothing that should hamper them seriously. It may be a bit hard on tires, but otherwise will cause little trouble.

Recently the committee in charge of the contest, H. A. Bonnell, chairman; F. A. Croselmir, A. D. Le Messena and H. A. Bowman, made a second tour of the circuit and found the route in better condition than on the original journey, some three weeks before.

The matter of observers has been satisfactorily settled by arranging to have students in the graduating class at Stevens Institute of Technology at Hoboken act in the capacity of officials. These men all have had an engineering training and know the difference between a spark plug and an inner tube. Most of those who will act have expressed a desire to stay on duty for the entire ten hours. No man will be allowed to stay on the same car for the complete run, however, but each will be shifted to another car when he reaches Newark at the end of the first lap, at about 1 o'clock.

CONNECTICUT DOESN'T WANT COMMISSIONER.

HARTFORD, CONN., May 3.—That pressure brought to bear from all quarters of the State to suppress the proposed bill for the creation of the office of commissioner of motor vehicles was successful is evident from the fact that the scheme has been practically abandoned, at least as originally outlined. There was much opposition to the proposed measure, and various officials of the Connecticut Automobile Association, of which W. F. Fuller, of Hartford, is president, were at odds over the matter, one faction being for and another against the proposed bill. Senator J. W. Alsop, Senate chairman of the committee on roads, rivers and bridges, made a motion in the Senate that this bill, together with the proposed amendment to the motor vehicle law proper, be recommitted to the committee. It is the intention of this committee to redraft the measures and make such changes as are deemed necessary. In the motor commission bill the committee has decided not to recommend the appointment of a commissioner at a salary of \$2,500, but instead to leave the enforcement of the law with the secretary of state (which is the present arrangement), and to provide for the appointment of a "supervisor of motor vehicles" at a salary of \$2,000 per year. The term of office is to be for four years, and appointment will be by the secretary of state, who shall also have the power to summon witnesses to hearings on complaints. The new bill does not clip the wings of the secretary of state, so to speak, as did the original proposed measure, much to the satisfaction of the opposition contingent regarding the original bill.

Aviation Grounds on Motor Parkway.—The meadow opposite the grand stand of the Long Island Motor Parkway has been made the official aviation ground of the Aero Club of America, according to President Cortland Field Bishop. Rights have been acquired for the erection of the necessary buildings. The Automobile Club of America will direct and control all aviation contests and have custody of the prizes, under authority of the International Aeronautic Federation.

What the Clubs are Doing These Days

A. C. OF PHILADELPHIA NOW HAS 740 MEMBERS.

PHILADELPHIA, May 3.—For the convenience of its rapidly growing membership the Automobile Club of Philadelphia has been compelled to establish easily accessible quarters on the ground floor of the Hotel Windermere, at the northwest corner of Broad and Locust streets, diagonally across from the Hotel Walton, where the Quaker City Motor Club holds forth. A suite of three rooms has been secured, consisting of assembly, reading and map rooms, where members will find all the necessary maps and data for laying out tours, etc. By an arrangement with the hotel management, the club has the benefit of most of the facilities afforded by a separate club house—restaurant, baths, barber shop, bar, cigar stand, etc., being located on the same floor with the A. C. of Philadelphia suite.

The club charter has been so amended as to permit of an increase in the number of directors to not less than nine nor more than twelve, the terms of office of one-third to expire each year. A limit of 1,000 has been placed upon the membership, and the maps, routes and signs committee and the touring information committee have been combined under the chairmanship of W. O. Griffith. Arrangements have been made whereby members of the club can secure fire and liability insurance, or either, at lower rates than when applying personally. Sixty-six new members were admitted at the last board meeting, and the total on the rolls is now 740 in good standing.

ACROSS PENNSYLVANIA AND RETURN RUN.

PHILADELPHIA, May 3.—After looking up the numerous routes for crossing the State, the Quaker City Motor Club has determined upon the one to be taken in its June run to the Smoky City and return. Starting June 14, the contestants will follow the usual route to Reading and will then leave the Harrisburg route and strike northwest to Pottsville, Bloomsburg and Williamsport, where the night stop will be made, a distance of 180 miles. From Williamsport to Johnstown, 143 miles, will be the course on the next day, through Lock Haven, where all the paper for government money is made, Tyrone, and Altoona. Mountain climbing will be a feature throughout the second and third days of the contest.

Pittsburg is merely touched on the third day, leaving Johnstown in the morning and traveling 72 miles for lunch, through Blairsville and Wilkesburg. Turning eastward again in the afternoon, the roads through Greensburg, Holidaysburg, Huntington and Reedville to Lewiston will be taken, 93 miles, making the distance for the day 165. Philadelphia is about that same distance from the night control, and will be reached over the route through Harrisburg and Lancaster. The entire trip will be about 725 miles in length.

PRICE CLASSIFICATION FOR SPORT HILL CLIMB.

BRIDGEPORT, CONN., May 3.—The climb of Sport Hill this year will be conducted by the Automobile Club of Bridgeport under the price classification recently announced by the A. A. A. This was decided upon at a recent club meeting and is one of the last matters to be definitely arranged. The climb will be held May 31, and will include nine classes. President Frank T. Staples has offered a handsome silver trophy for amateur driver, and the Board of Trade trophy and the one given by the Isotta Import Company, of New York, will again be open to competition. State troops will patrol the course and A. L. Riker will again act as referee. Entry blanks are now ready and may be secured from Ralph M. Sperry, Box 518, Bridgeport, Conn.

IOWA AUTOISTS STRENGTHENING STATE BODY.

MARSHALLTOWN, IOWA, May 3.—With the election of the Iowa State Automobile Association to membership in the A. A. A., the work of further organization of automobilists in the cities of Iowa is rapidly progressing. The charter members were the clubs of Council Bluffs, Marshalltown, Mason City and Sioux City, these incorporating the State body soon after forming it. Five other cities are now interested in the work, Dubuque, Davenport, Cedar Rapids, Boone and Fort Dodge.

The officers of the association are: President, Dr. T. B. Lacey, Council Bluffs; first vice-president, H. B. Groves, Sioux City; second vice-president, A. J. Zingre, Mason City; secretary, D. J. Denmead, Marshalltown; treasurer, W. H. Hanthorn, Mason City. These with J. L. Denmead, of Marshalltown, constitute the board of directors.

CROSBY PRESIDENT OF JERSEY'S BIGGEST CLUB.

NEWARK, N. J., May 3.—Without an opposition ticket, the annual election of the New Jersey Automobile and Motor Club was held to-night. These are the new officers selected: President, W. Clive Crosby; vice-president, Clarence H. Bissell; secretary, A. B. Le Massena; treasurer, George H. Simonds; trustees, H. D. Bowman, Jay L. Adams, Jr., and Paul E. Heller.

The new president of the organization is also president of the Associated Automobile Clubs of New Jersey. Reports of officers showed that the club has a membership of more than 1,500 and is the second largest in that regard in the A. A. A.

KNOXVILLE AUTOISTS FORM A CLUB.

KNOXVILLE, TENN., May 3.—Automobile interests in this city have been focused through the organization of a local automobile club. About twenty-five autoists met recently and elected the following officers: President, W. J. Oliver; vice-president, N. E. Logan; secretary, E. G. Oates; treasurer, U. D. Beeler. Several matters will receive the attention of the body, among them being the local speed regulation, the improvement of good roads around the city and the development of sport. There are no mountains which would give a chance for a climb similar to that of the Lookout Club at Chattanooga, but the pikes would be suitable for speed events.

BALTIMORE'S ORPHANS TO BE ENTERTAINED.

BALTIMORE, May 2.—The committee of the Automobile Club of Maryland in charge of the Orphans' Day outing, June 9, is arranging to make this event by far the best ever held. At least 500 children will be cared for this year, and the committee has assurances of enough cars for the purpose. The start will be from the center of the city, through Druid Hill Park to Electric Park, where the orphans will have refreshments and be the guests at an entertainment. The outing committee comprises E. A. Dolle, chairman; Dr. H. M. Rowe, Frank W. Darling, C. Howard Milliken, J. M. Zamoiski and James S. Reese.

MONTREAL CLUB SECURES OILED ROADS.

MONTREAL, May 3.—Co-operation between the Automobile Club of Canada and municipal authorities has resulted in the decision of the latter to have the city road department oil Park avenue, from Pine to Mount Royal avenues, in order to prevent dust. A combination of oil and coal tar will be used, and it is hoped that adjoining cities and country officials will see the advantage of the plan and do likewise.



Alco Tourabout Fitted with Special Alco Top.

HOW A NEW SPARK PLUG WAS INTRODUCED.

In this era of modern advertising the marketing of a new product is not only unique and successful, but the campaign is often wonderful in its results. This is true of the plans carried out in the introduction of the Red Head spark plugs by the Emil Grossman Company, of New York, and shortly to be reproduced in bringing public attention to the hydraulic windshields made by the same concern.

In the latter part of February the campaign was started through the use of considerable advertising space in *THE AUTOMOBILE*, *Motor Age* and one other paper, just mentioning the name "Red Head," followed by another series stating, "Red Head Is Coming," "What Is Red Head?" and "Everybody Is Talking About Red Head." The advertisements of small size each were sprinkled through the papers, and March 4, inauguration day, the Red Head spark plug was announced in double-page advertisements printed in colors, while in the same issue appeared a number of small cards using the words, "Red Head Is Here." On that day Mr. Grossman, who was in Chicago, sent out 550 telegrams to dealers calling attention to the advertisement in the various papers.

This first public announcement March 4 was followed by the first delivery March 16 by the manufacturers and in the issues of April 15, just one month later, there appeared a full page giving the names of 56 leading supply houses in 25 States which were then carrying in stock a full line of these plugs, covering the United States and Mexico from the Atlantic to the Pacific and from Maine and Oregon to the Gulf. Moreover, the number is increasing daily and demands became so urgent that the concern was influenced to insert an advertisement of a different character as early as April 1, which said: "Have a little patience! Red Head spark plugs are coming through as fast as human hands and improved machinery can make them." The advertisements, as a rule, are composed simply of a picture of the plug with the trademark prominent and little wording, only a few of the displays making comment on the features of the plug, the mere appearance seeming to bring orders from dealers, jobbers, and many automobile manufacturers.

After the first popularity was indicated from the results attained by the use of *THE AUTOMOBILE*, *Motor Age* and another

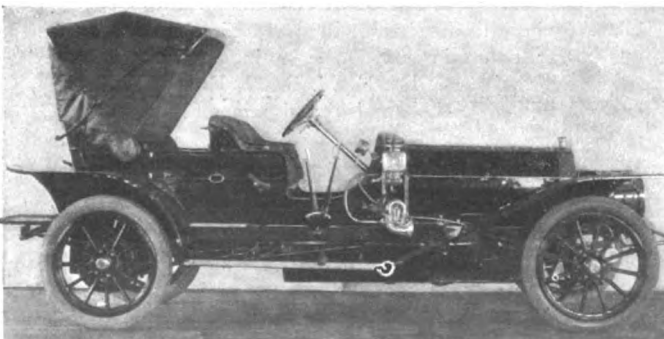

Six-Cylinder 48-Horsepower Pierce Arrow Miniature Tonneau.

publication, Mr. Grossman determined to attempt still another type of exploitation: that of supplying manufacturers, dealers and users with sample plugs with the proviso that they must be given a hard test and then the results made known. Consequently every dealer was supplied with an order blank in duplicate authorizing the delivery to them of two spark plugs each from any jobber and 15,000 plugs were thus distributed. At approximately the same time the manufacturers' interest was secured through offers to furnish them any number of Red Head plugs between 2 and 100 to be used by testers and reckless drivers with orders to resort to any means that "puts other plugs 'out of business'" and to note the result upon the Red Head. A campaign to the owners is being planned.

DETROIT HAS DELAYED IN TAXICABS.

DETROIT, May 3.—The old horse-drawn coaches and omnibuses that have for so long been a familiar sight to travelers stopping in Detroit, will be supplanted in a large measure by taxicabs in the near future. The Detroit Omnibus Lines Company, holding the contract rights for transferring travelers between railroad stations and steamboat landings, and also maintaining carriage stands about the city, has made arrangements with the Detroit Taxicab Company to place 75 taxis in commission.



Agent Evans' Frontenac with the Oldest Automobilist.

In the automobile carnival parade of Monday in New York City J. J. Evans, general agent for Frontenac cars, had as a passenger, Mrs. F. D. Cottle, who was 100 years old on March 12, 1909. She occupied the rear seat to the left of Mrs. Evans.

WHAT PART IS THE STRONGEST?

In the majority of cases where an automobile owner is asked as to his idea of the strongest part of an automobile he will mention such parts as the piston wrist-pin, the crankshaft, gears or driving axle. There is a great strain on these parts, to be sure, but when the question arose recently in the Pierce-Arrow Motor Car Company's factory it was settled, according to an official of the company, by going to the testing laboratory, where records are kept of the strength of the component parts entering into cars. The engineer in charge stated that the valve springs show the greatest tensile strength, reaching 272,211 pounds to the square inch in tests. The nearest to it was a French steel which tested 237,787 pounds.

RIDER-LEWIS COMPANY IS INCORPORATED.

MUNCIE, IND., May 3.—Articles of incorporation have been filed with the county recorder by the Rider-Lewis Motor Car Company, of Anderson, Ind. The capital stock is \$400,000, of which \$50,000 is preferred. The directors for the first year are: Clermont Rider, Muncie; George D. Rider, Kentland; Ralph C. Lewis, J. W. Lovett, Anderson; Arsomas Burkdoll, Chicago; H. D. Lingle, Denver, and C. A. Ulsh, Rising Sun. The factory is being built in Anderson and will manufacture automobiles, cars, trucks, buggies and all kinds of motor-driven vehicles.



A Typical Frontiersman.

Mr. Guggenheim Greets the Pathfinder in Wyoming.

Miller Meets Acquaintances.

A STATEMENT FROM THE M. C. A.

By order of the advisory committee of the Manufacturers' Contest Association, a press notice was issued April 29 under the heading of "M. C. A. Corrects a Misstatement." Herewith is the material:

A statement has been issued to the daily press by the promoters of the New York to Seattle contest, specifically stating that the rules of the contest have undergone certain changes "pursuant to the recommendations made by the Manufacturers' Contest Association at their meeting of April 6."

This statement is misleading and without foundation. The Manufacturers' Contest Association did not hold a meeting on April 6, nor has it officially made any recommendations whatever respecting a change in the rules governing this contest. At its only meeting held March 30, the members declined by resolution to support the Seattle contest for stated reasons.

The promoters have very sensibly undertaken to correct many of the objectionable portions of their rules, but are entirely without authority to make a public statement that the changes have been made at the recommendation of the M. C. A., for that organization has within a week by mall vote declined to re-open the subject of the New York-Seattle contest, having already officially disposed of it.

By order of Advisory Committee,
MANUFACTURERS' CONTEST ASSOCIATION.

It is understood that several M. C. A. members were not unfavorable to the event under revised rules, but they have accepted without comment the decision of the majority.

Seattle now has an Aeroplane Club, through the organization, in the western city, of a number of those interested in aviation, and that the club is in earnest is shown by the trip of its president, Harry Whitney Treat, to New York, to purchase a real aeroplane, and to arrange for an affiliation with the Aero Club of America.

A STATEMENT FROM THE PROMOTORS.

From Mills & Moore, the Eastern representatives, comes a press notice, released May 3, wherein is reaffirmed a claim of 13 entries made with 11 having paid the fee. The notice reads:

Some doubt has been caused in the public mind as to the attitude of the Automobile Club of America, in view of the activities of certain opponents to the Ocean-to-Ocean Contest. Chairman Robert Lee Morrell of the Contest Committee was asked as to the result of the letters reported to have been sent by the manufacturers to the president of the A. C. A., requesting that the club's sanction be withdrawn.

Mr. Morrell stated that the club's sanction would not be withdrawn and that the club's position had not been varied; that it would see that the contest be properly conducted and that the \$5,350 in cash prizes, which had been deposited by M. Robert Guggenheim and which was now in the hands of the Automobile Club of America, would be paid to the winners.

When asked if the number of entries would have any effect on the attitude of the club, Mr. Morrell said: "Not the slightest; if the Seattle Automobile Club and the Alaska-Yukon-Pacific were prepared to start only one car June 1, the club will be ready to carry out its obligations as the sanctioning body." This statement should set at rest, once and for all, the rumors that have been given circulation that the contest did not have the full support of the Automobile Club of America.

C. M. Hamilton announced Wednesday that he has practically completed arrangements to enter the transcontinental contest, with an Isotta standard 40-horsepower car.

Twenty entries have been received by the Swiss Aero Club for the Zurich Gordon-Bennett event, starting on October 3. This is three less than last year, but it may be that late entries will be forwarded. Switzerland, Germany, France, Italy, and Belgium are represented by three balloons each, Spain two, and England, the United States, and Austria pin their faith to one.

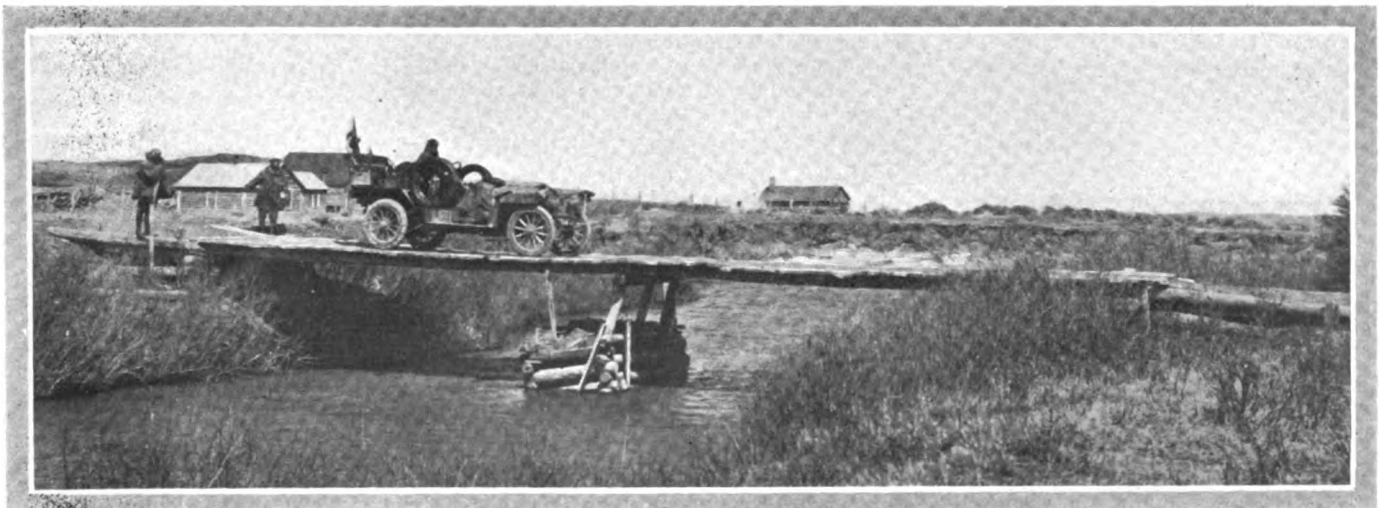

Typical Western Country Met with in Wyoming, Where Bridges Are to Be Crossed with Much Caution.



In Front of the Pennsylvania Capitol in a Franklin.

In the background, at the end of the avenue, in Harrisburg, is shown the \$13,000,000 State Capitol of the Keystone commonwealth. On the front seat of the air-cooled Franklin, Model G, are J. Clyde Mason, secretary of the Harrisburg Motor Club, and James Bell, of the Harrisburg Board of Trade.

An Amateur Trans-Continentalist.—From San Francisco to Portland, Me., and then back to the Pacific Coast by way of the northern route to Seattle is an automobile trip to be made this Summer by Mr. and Mrs. C. A. Littlefield, of Oakland, Cal. Mr. Littlefield has given considerable time and expense to preparations, both as regards his car and routes and roads. Marsh quick acting rims with Diamond 36 by 5 tires all around will be used, and the trip East, which will be by way of Los Angeles, New Orleans and Washington, includes also a visit to the Diamond rubber factories in Akron, O. The return journey will be via Buffalo and Chicago, thence for the most part along the route of the New York-Seattle endurance event.

Cameron Raises the Price.—The Cameron Motor Company of New York City, distributors of the four and six-cylinder air-cooled Cameron cars, announce an advance in price of three, four-cylinder models, as follows: Model 14, runabout, formerly \$900, raised to \$950; Model 14, three-passenger roadster, \$950, raised to \$985; Model 16, four-passenger roadster, \$1,050, raised to \$1,100. Harry Doherty, vice-president, states that the demand for the company's product is exceeding the most sanguine expectations, and that arrangements are already being made for the 1910 season.

Firestone Believes in Tire Contest.—With the approach of the Glidden Tour, and the discussion of penalties, H. S. Firestone, president of the Firestone Tire & Rubber Company, states that he favors a system of penalizations for tire troubles. He says: "A large per cent. of the stops en route are made because of trouble with tires, and it seems strange that tire service is not connected more closely with automobile efficiency. Penalties for weakness would inevitably raise the prevailing standard of tires."

Many One-Lung Autos in California.—H. J. Neumann, a Los Angeles, Cal., autoist, in sending along his renewal subscription to THE AUTOMOBILE says:

"People out in this country are just waking up in the buying of up-to-date cars, for I think all the one-lungers in the whole country are now used here, where we have a different name for almost everything pertaining to the automobile. For instance, most folks call a windshield a glass front."

Remy Equipments for Older Models.—The manufacture of equipments for attaching its magnetos to early models of automobiles has proven a success, according to the Remy Electric Company, Anderson, Ind. Many owners of cars built as recently as 1907, not originally designed to have a magneto have been furnished with them, and the company is making and keeping a full set of fittings, with instructions for attaching.

Benz Importers Have Open House.—To celebrate the recent victories of the Benz racing car, the Benz Auto Import Company, of America, had an "open house" on last Saturday, with "scribes and good fellows" as guests. Incidentally the Sir Thomas Dewar \$2,000 trophy, which was won at Daytona, was shown, and the improved business outlook made the cause for felicitations.

Cheyenne, Wyo., announces a Motor-drome.—The Cheyenne Motor Club has announced that it has completed plans for the construction of a five-mile automobile race track to built near the city. There will be a course within a course, banked curves and other features.

New Men in Gramm-Logan Company.—The Gramm-Logan Motor Car Company, Bowling Green, Ohio, has added to its officials several leading men of the Lima Locomotive & Machine Works. Increased capital and factory facilities have been obtained.

RECENT BUSINESS CHANGES.

Gibney Brothers Have New Quarters.—James L. Gibney & Brother, the Philadelphia distributors of Continental tires and general dealers in Gibney solid tires

and accessories, in order to relieve a cramped condition in their present quarters at 211-213 North Broad street, have secured the building next door at 215-217, and are having it thoroughly overhauled. The new store will soon be ready and will give a large, well-lighted salesroom, offices, stock rooms and tire repair shop. The building is a large three-story one, equipped with an electric automobile elevator and power.

Four Traction Auto Company Looks for Factory Site.—Minneapolis may be the location of the Four Traction Auto Company, the maker of the Kato trucks, according to factory officials. At present the machines are built at Mankato, Minn., but the necessity of increasing production has made a larger plant imperative, and Minneapolis sites have been examined. The concern was recently capitalized at \$200,000, and has a large business in making trucks, patrol and fire wagons, all with the four-wheel driver, which has been such a marked success.

Luitweiler Pumping Engine Company Moves East.—Rochester, N. Y., will soon be the location of the Luitweiler Pumping Engine Company, now situated at Los Angeles, Cal. The plant of the American Laundry Company has been purchased, and will be occupied about June 1, after extensive alterations are completed. The concern is engaged in building automobile fire apparatus, and steam, gasoline and electric pumping engines.

Utica Pliers and Nippers Marketed Direct.—The Utica Drop Forge & Tool Company, of Utica, N. Y., is now marketing its products, pliers and nippers, direct to the trade. The new policy was begun on April 1 and has been found successful. The plant is in full operation, more than an acre of floor area being under one roof, with over a mile of industrial railroad between the various departments.

Davidge Motor Car Company in Binghamton, N. Y.—John M. Davidge, of Binghamton, has filed a certificate with the county clerk, announcing that he will go into business under the name of the Davidge Motor Car Company.

Birmingham Auto Company Changes Hands.—Leo Loeb and J. H. Loveman, of Birmingham, Ala., have purchased the Birmingham Auto Company, carrying with it the agency for the Chalmers-Detroit and Thomas cars.

Nesmith Buys Auto-Shine Company.—The C. I. Nesmith Company, Reading, Mass., has recently purchased the Auto-Shine Company, of Buffalo, N. Y., manufacturers of "Auto-Shine" a varnish restorer and polish.

IN AND ABOUT THE AGENCIES.

Fry Spark Plugs.—The Standard Sales Company, of New York City, is introducing to the trade the Fry spark plugs, made in 1-2 inch, metric, and A. L. A. M. sizes, with interchangeable porcelain and mica cores. Manager J. Stewart Smith is enthusiastic over the future, which the simplicity and reliability of the plug insure.

United Manufacturers Establish Branch Offices.—The following distributing centers and branch offices have been opened by the United Manufacturers: Chicago, 1430 Michigan avenue; Detroit, 225 Jefferson avenue; Cleveland, 1032 Euclid avenue; Philadelphia, 422 Commerce street; Boston, 109 Massachusetts avenue.

Rambler, Atlanta, Ga.—The Rambler has just broken into Atlanta, with Baynard Willingham in charge of the agency. A warehouse has been converted into a comfortable and commodious garage at 70 South Forsythe street.

TAXICABS AND TRANSIT.

Philadelphia to Have Auto Patrols.—Director of Public Works Clay is contemplating the installation of an automobile patrol service. Garages for this service are to be built at the new Thirty-sixth District Station at Hunting Park and Germantown avenue, and also at the Twenty-first District Station at Woodland avenue and Market street.

Autos to Collect Minneapolis Mail.—Major W. D. Hale, postmaster at Minneapolis, has requested the government to furnish two automobiles for use in collecting mail, and it is believed that they will be furnished. The superintendent of delivery has gone to Milwaukee to inspect the operation of the auto mail wagons there.

Stage Line in New Haven, Conn.—A Knox sight-seeing bus of 30-passenger capacity, has been put into service by S. A. Lewis, on several streets of the city. Other cars of the same type will be used when needed, running as buses during the day and evening, and open to engagement for Savin Rock and other resorts along the Connecticut shore.

Pueblo, Cal., Get Taxicabs.—A Ford enclosed cab has been put into service here as the first of the taxicabs received by Robertson & Marks. It was run over the roads from Denver and has made a favorable impression in "sunville."

McKinney, Tex., to Establish Bus Service.—An automobile service will shortly be installed between Blue Ridge, Melissa and McKinney. A number of prominent men of Blue Ridge are interested in the service.

More Taxicabs for Dallas.—Increasing popularity of taxicabs has evinced itself to such an extent that four more machines are to be added to the present service of thirteen.

PERSONAL TRADE MENTION.

Percy Neel, president of the Automobile Sales Corporation of Philadelphia, which handles the Peerless and Cadillac, sailed last Saturday for a six weeks' trip abroad. Mr. Neel has just recovered from a long illness, and his physicians

prescribed a rest and ozone of a sea voyage to complete the cure.

Cadwalader Washburn Kelsey, of Philadelphia, who is not unknown to fame in connection with the Maxwell car, will be married June 2 to Miss Mariah Sharwood, of Bryn Mawr, in the Church of the Redeemer at that place. After a honeymoon abroad, Mr. and Mrs. Kelsey will reside in Tarrytown, N. Y.

G. C. Lewis has joined the selling force of the New York branch of the E. R. Thomas Motor Company. Mr. Lewis was formerly Boston manager for the Dragon car, and prior to that time was manager of the Wayne Automobile Company's branch in Boston.

Edward A. Kingsbury has accepted the position of business manager of the Chase Motor Truck Company, of Syracuse, N. Y. He was formerly connected with the Hudson Portland Cement Company.

P. O. Sheenan has been appointed city salesman for Boston for the Republic Rubber Company, of New York, and will make his headquarters at the local branch at 735 Boylston street.

Lee Dykeman for some time associated with the Dayton Motor Car Company has been appointed superintendent of the Firestone Automobile Company, of Columbus, Ohio.

R. E. Ross, of the Quaker City Motor Club, has been appointed chairman of the contest committee, by President Berger, succeeding the late Ferdinand M. Johnson.

NEW AGENCIES ESTABLISHED.

Knox, Pittsburgh, Pa.—Hiland Automobile Company, in addition to the Peerless and E-M-F.

Winton, Altoona, Pa.—Hollidaysburg Automobile Company, Montgomery and Mulberry streets.

Dixie Flyer, Minneapolis.—Sangstrom Motor Company. For the entire Northwest.

Chalmers-Detroit and Thomas, Birmingham, Ala.—Birmingham Auto Company.

Columbia, Chicago.—Fred R. Jenkins Company, 1330 Michigan avenue.

Rider-Lewis, Minneapolis.—Segerstrom Automobile Company.

Elmore, Waterville, N. Y.—Orrin Terry and Fred C. Bufford.

Maxwell, Brainbridge, Ga.—E. T. Hines and T. M. Battle.

Hupmobile, Milwaukee, Wis.—Samuel B. & Harry C. Taylor.

Peerless, Fort Worth, Texas.—Hugh H. Lewis, Jr.

Ford & Overland, Washington, N. J.—Hoyt Sharp.

RECENT INCORPORATIONS.

Union Auto Company, Little Rock, Ark.—Capital, \$10,000. To buy, sell, rent, repair, automobiles. Incorporators: President, C. B. Ledbetter; vice-president, C. K. Lincoln; secretary, L. E. Polk; treasurer, W. L. Hemingway; R. L. McKinney, J. F. Loughborough, D. H. Cantrell, J. L. Dibrell.

Garny-Mehserle Machine & Auto Company, Rochester, N. Y.—Capital, \$2,000. To manufacture motors, engines, wagons, cars and vehicles of all kinds. Incorporators: George Garny, Theresa Garny, Henry Mehserle and Katherine Mehserle.

Plainfield Auto Sales Company, Elizabeth, N. J.—Capital, \$25,000. Incorporators: C. C. Brown, C. C. Ropac and S. A. Aldrich. To manufacture and deal in automobiles of all kinds, and to deal in supplies and fixtures.

American Automobile Association Publishing Company, New York.—Capital, \$2,000. Incorporators: Lewis R. Speare, F. H. Elliott and J. H. Bruce. To conduct a printing and publishing business.

Munsing Motor Car Company, Jersey City, N. J.—Capital, \$1,000,000. To do a general manufacturing business. Incorporators: W. H. Buresmith, J. B. Franklin, C. H. Bellows, Jr.

Stoughton-Folkins Company, Portland, Me.—Capital, \$10,000. To manufacture motors, engines and vehicles. President, M. S. Folkins; treasurer and clerk, P. T. Stoughton.

Park Garage Company, Asbury Park, N. J.—Capital, \$125,000. Incorporators: A. M. Fisher, G. F. Mitchell and M. W. Bates. To conduct a general garage business.

Preston Auto Improvement Company, Boston.—Capital, \$100,000. Incorporators: R. N. Gowing and F. G. Preston. To conduct a general automobile business.

L. B. Repair Company, New York.—Capital, \$10,000. To deal in and repair automobiles. Incorporators: J. A. Lewis, F. H. Bonner and W. A. Rue.

McDuffie Motor Car Company, Denver, Col.—Capital, \$25,000. Incorporators: J. W. Ebert, C. H. McCausland, J. H. McDuffie.

McCord Manufacturing Company, Springfield, Ill.—Capital, \$750,000. Maine corporation to manufacture automobile supplies.

Albert Sterne Motor Car Company, St. Louis.—Capital \$15,000. Incorporators: Albert Sterne, M. L. Weiss, L. A. Fassett.

NEW TRADE PUBLICATIONS.

Xargil Manufacturing Company, Utica, N. Y.—Mufflers which do not create a back pressure upon an engine have long been sought, and those which create a vacuum would give an ideal condition. The Xargil Manufacturing Company is now producing a muffler which is known as the Xargil Vacuum Muffler, and is described in a new catalog published by this concern. This booklet includes the reproduction of a curve, plotted from a series of tests made of the muffler at the Franklin Company's works in Syracuse. This shows that at 1100 revolutions of a Model D Franklin car the pressure in the muffler is but .4 of an ounce. The muffler consists of an outside elongated steel cylinder, with two smaller interior ones, divided in turn into some thirty compartments interconnected. The exhaust is divided into innumerable small jets, as explained by the booklet.

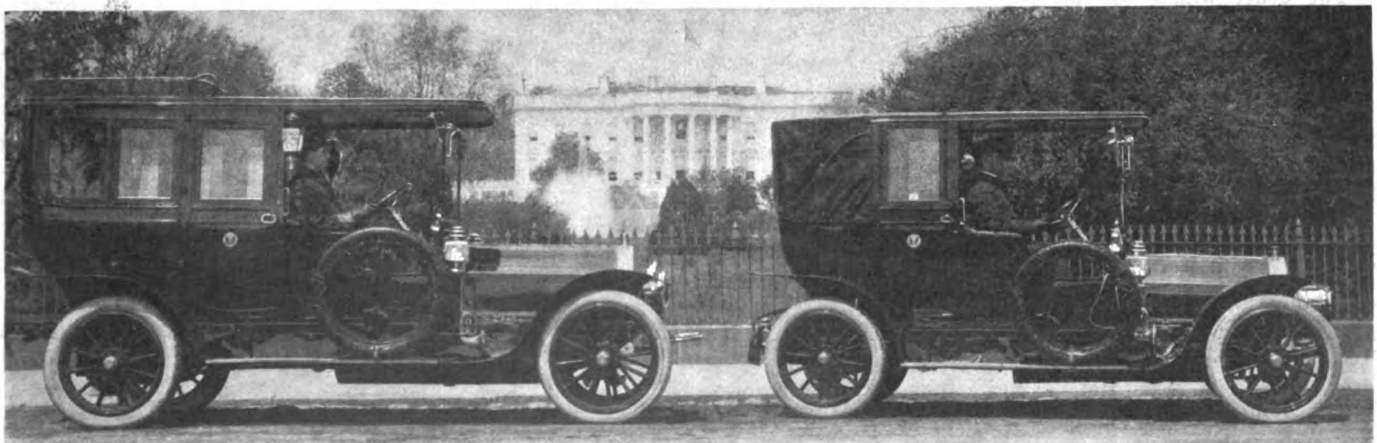

Six-Cylinder 48-Horsepower Suburban and Six-36 Landaulet Pierce Arrow Cars in the White House Service, at Washington.

Information for Auto Users

Red-Head Spark Plugs.—These plugs are made and marketed by the Emil Grossman Company, 232 West Fifty-eighth street, New York City, and the design, as shown by the illustration, is along the accepted lines of spark-plug construction, with features embodied therein designed to give special results to the user. The porcelain cores are made of a special clay, aged for nine months by a new process which does not make them brittle. These are then formed and baked, and can be thrown with great force against the floor or a hard surface, but will only rebound and not break. Under a red-hot heat it is asserted they do not even bend, and in exhaustive tests made by the Electrical Testing Laboratories, in testing for the dielectric strength it was found that the Red-Head porcelain under 17,400 volts arced over its surface; whereas of two porcelains taken at random one was punctured at 8,000 volts and the other at 6,600, arced through a puncture.



RED HEAD PLUG.

The shell or base is substantial and compact, turned from solid steel, with a solid brass bushing nut to surround the porcelain or mica core. The bushing may be forced down upon the shoulder of the porcelain to make a tight joint. One copper asbestos washer is used in packing the core into the shell, and it is claimed that sufficient packing is used to prevent its blowing out. Still another feature is in the electrode, which is extra large and

heavy, so that it will stand any heat from either a magnet or battery and coil.

The order which was placed by the Emil Grossman Company for the parts of the plugs was double the largest of its kind ever made, according to Mr. Grossman. There are three types of plugs in the Red-Head class: One-half inch, A. L. A. M., and metric, made so that the porcelain is interchangeable with mica cores, and the price has been made uniform, one for any style.

Umph Roller Timer.—Among the season's best productions in the realm of ignition, is the Umph roller timer, manufactured by A. R. Mosler & Company, 163 West Twenty-ninth street, New York City. The illustration shows a front view of the timer, with the cover removed. In construction the Umph is such that wobbling is overcome and irregular wearing of the roller and shaft bearings is eliminated by the

use of ball-bearings. In this timer the roller is itself a ball-bearing and is supported by a yoke which fits in a specially shaped slot in the front end of the hollow revolving shaft, so that the roller and its yoke can move radially under the

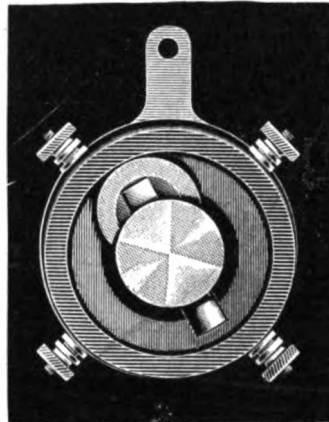

UMPH ROLLER TIMER.

action of a spring but cannot move sideways and therefore must keep true to the contact surface at all times. The shaft is mounted on two ball-bearings, the rear one running on a flanged ring and being held up to its work by a pinch-collar and arched spring-washer which fit over the rear end of the shaft. The front bearing revolves on a collar formed on the shaft itself. The segments are made of brass, each being of one piece, and are inserted by pressure from the interior of the casing. The rear end of the shaft is split, and is fastened on the timer shaft of the motor by means of the pinch-collar which in its turn is kept from sliding off by a horseshoe washer fitting into a groove cut in the shaft near its end. By removing this washer, the entire timer can be taken apart without the use of tools.

Irving Overhead Vehicle Washers.—These handy devices are made in four patterns by the I. J. Smith Mfg. Co., 4283 Park avenue, New York City. Indestructible washer No. 3, the subject of the illustration, is constructed principally of brass, and provided with automatic water cut-off. Inserted in the top of the washer is a plunger attached to a tube, which runs down the center of the washer to the movable joint in the bottom of the device. When the party washing a car desires water, he pulls down on the hose, thus drawing down the revolving arm of the washer, at the same time working valve in the center of the washer, which permits the water to run. The arm is held down in position by adjusting the counter-balance weight so that

the hose-arm is a few pounds the heavier. When it is desired to close the water off, a slight upward push on the hose will send the hose-arm upward, and in such a position it is retained by a catch to the supporting arm, and the water pressure at once closes the valve on the top of the washer. The sliding counter-balance weight can be so adjusted as to automatically close off the water the moment the hose is released from the hands of the operator.

With the indestructible washer, the party using same cannot put more than 10 pounds pressure on the center by pulling down on the hose, for on placing more than that force on the revolving arm, the spring and counter-balance allows the arm to give down, and when the man lets go the hose the arm goes back into position.

The other Irving washers are Nos. 1 and 2, and the Every Ready. These are not made with automatic cut-offs. They have arms varying from 4½ feet to 6 feet in length. Electric-light equipments can be ordered with washers Nos. 2 and 3. All washers are secured to the ceiling by four lag screws, and to the end of the revolving arm is attached the hose, which is always hanging and ready for use. By their use hose can not be run over, trod upon, or rot out from water lying in it, and it also prevents the hose kinking.

Shippey Shock Absorber.—"In all our output during the last three years, we have yet to hear of one broken spring," is the statement made by the George E. Shippey Company, Pittsfield, Mass., makers of the Shippey shock absorber, in setting forth its claims for a record. As can be seen by the illustration, the

Shippey is striking in its simplicity of construction and method of operation. The springs are made of the best crucible spring steel, oil tempered, and all wearing parts are specially hardened. No adjustment is necessary, once the absorber is applied to the car, and the easy movement of the springs is not affected on the smooth roads, but the device comes into play on the bumps. The absorber that is used on the front of the car is attached directly to the frame of the car at its top, and the connection on the bottom is made with a special clip. The rear absorber is attached inside of frame, under the body, using a plate as connection.

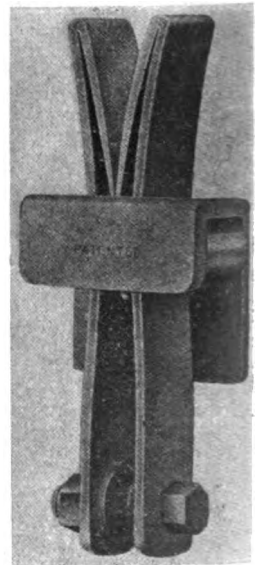

SHIPPEY'S SHOCK ABSORBER.

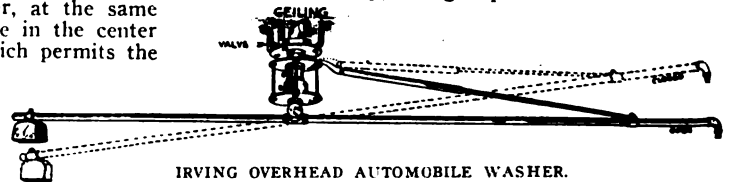

IRVING OVERHEAD AUTOMOBILE WASHER.

THE AUTOMOBILE

WASHINGTON'S RELIABILITY SUPPLIES A TIE

By H. G. Ward.

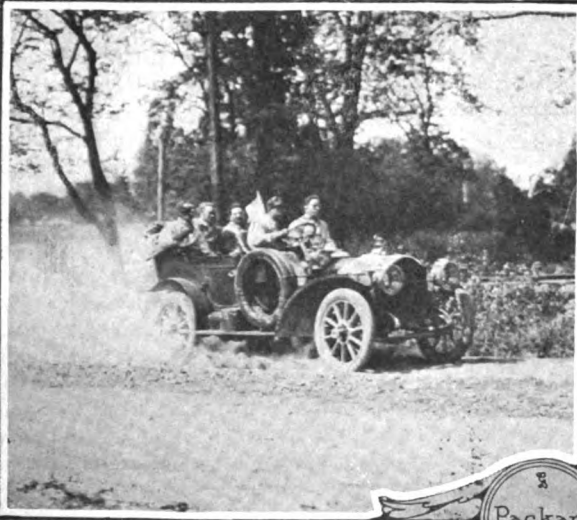

Packard

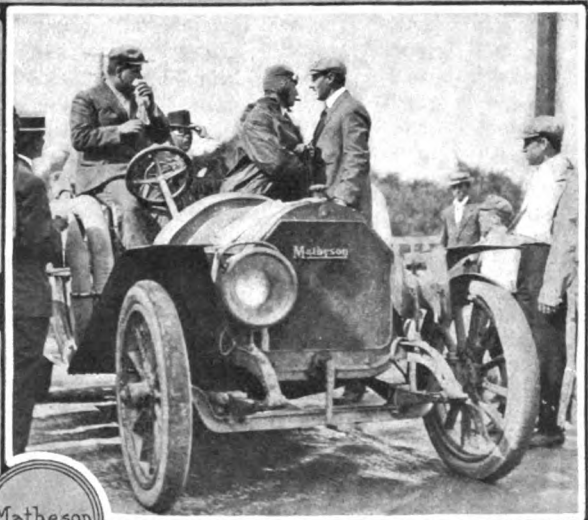

Matheson

WASHINGTON, D. C., May 18.—Packard and Matheson are tied in the top notch class of the reliability run of the Automobile Club of Washington, held Saturday last over a trying 165-mile course, which included Maryland and Pennsylvania roads, both good and bad. Apparently the Packard, driven by John Day, had survived the run with a perfect mechanical and road score. Subsequently a protest against this decision of the technical committee was filed by William Orme, entrant of No. 13 Matheson, which finished second with W. B. McBurney at the wheel, its score being four points away from perfect. Mr. Orme himself drove another Matheson car, which landed in the third place in the summary of Class A, with 26 points less perfect. The protest was based on the fact that the Packard had a loose grease cup on the rear spring, and, furthermore, it was claimed that the driver had worked on the car after the conclusion of the run and before it was turned over to the technical committee for examination. It is stated that at first the driver thought something was wrong with the ignition system, and subsequently he discovered that the trouble was due to the loss of a cover over the air valve in the carbureter. The driver had something to say about its having been tampered with, but eventually the cover was found in the pan underneath the engine.

The technical committee consisted of Robert B. Caverly, Fulton R. Gordon, and H. Chadwick Hunter. The cup for the class was

a handsome one offered by the *Washington Post*. Exactly what will be done with the tie is not known at this time, but it is among the possibilities that a run-off will be arranged in the near future.

Class B, the cup for which was donated by the *Washington Star*, had a Model 17 Buick winner, perfect in its road score, but having a penalization of two points for a dead battery.

Class C, with the *Washington Times*, the donor of the cup, fell to the Model T Ford roadster, penalized fourteen points, ten of which were for lost time and four for technicalities reported.

Twenty-one cars were entered in the contest, but three failed to start. A Model KA Maxwell did not arrive in time from the factory, a Chase delivery wagon was scratched because certain gears did not come to hand, and a Thomas-Detroit was disqualified because its observer did not show up.

The course was one calculated to try the endurance of cars and drivers, being over various kinds of roads and crossing three mountain ranges. At Waynesboro, Pa., which was half the distance, a half hour's compulsory stop was made, where the contestants were permitted to replenish with gasoline. Water and oil could be taken on at any time under the rules.

The two Matheson entries showed a good performance, the No. 13 losing only four points for lost body bolts, having otherwise a perfect road and technical score. The other Matheson lost 24 points, according to the observer's time record.

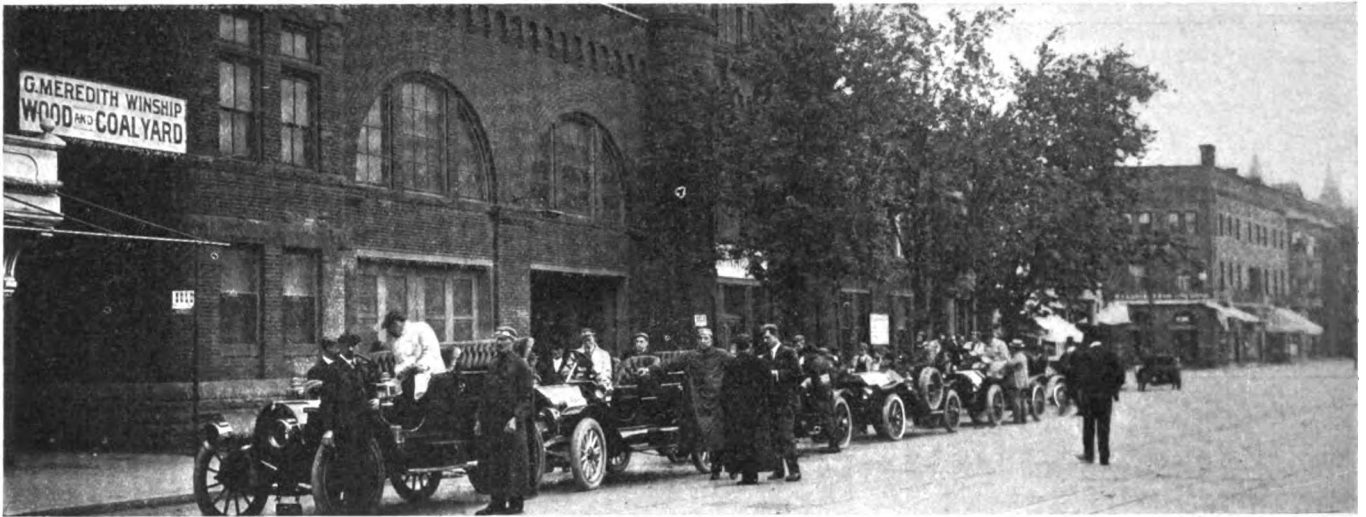

Concluding Preparations for the Start of the Reliability Run of the Automobile Club of Washington

Fourth in Class A was the Franklin with 45 demerit points, 4 being for four lost spring clips, 12 on the observer's technical report, and 29 for being late.

If there was one car penalized that certainly had a tough break in the luck bag it was the Oldsmobile, driven by O. W. Hoffman. This car was penalized 4 points for being late at the finish, a condition brought about by the melting of a connecting rod bearing, for which an additional penalty of 50 points was assessed. This happened only a few yards from the finish line and the car had a perfect mechanical and road score up to this time. The fact that the car was entered late, and was taken right off the sales floor of the local Oldsmobile dealer without having any tuning up whatever, accounts in a measure for the trouble.

Another Oldsmobile, a Model X Special, also came in for a bit of hard luck. It sustained a penalty of 65 points; 33 of which were levied on the observer's report. It also had 2 points against it for a turned shackle, 3 points for a loose frame bracket, 25 points for a damaged wheel, and 2 points for being late. Twelve miles from the finish this car, driven by Tyser, cast a front tire and it came home on the rim, being only a minute late. Tyser did a sensational piece of driving that was acknowledged with applause by the hundreds at the finish line.

The Columbia lost 2 points for a loose spring clip, 46 points for being late, and 25 points on technical examination. The Pullman sustained a loss of 154 points, 2 of which were for a loose muffler pipe, 2 for lost chassis bolts, 10 for a loose thrust bearing, 110 on the observer's report, and 30 for being late. The other Packard suffered the heaviest penalty of all, due to a broken spring. It lost 1,860 points for being late, 2 for a broken

seal, 35 for broken spring leaves, 2 for a loose spring clip, 2 for a loose muffler pipe, 2 for a loose mudguard, and 38 on technical examination.

In Class B the Chalmers-Detroit was assessed 16 points on the observer's technical report. Twenty-six points went against the Stoddard-Dayton, 2 for a broken oil lead, 1 for a loose spring clip, 2 for a turned shackle, 10 for lateness, and 10 on the observer's technical report. The Wayne was disqualified because it was removed from the official garage before the examination by the technical committee.

In Class C the Reo roadster had a loose oiler when the car started, but the driver forgot to declare this fact to the committee the night before the start. The technical examination disclosed this fact and 20 points were charged, together with 2 points for stalling the engine twice. A Ford, driven by Machin, had a time penalty of 22 and 2 points for a loose muffler pipe.

The two Brush entries had hard luck. No. 11, driven by Nichols, had a broken web, for which it was assessed 50 points; 284 points for being late; 25 points for a lost tool kit, and 2 points technical. The other Brush had a loose cylinder nut, costing 2 points, while 70 points were levied for being late.

CLASS A—CARS COSTING \$2,500 AND OVER.

Car.	H.P.	Bore	Stroke	Model	Driver	Penalty
1. Packard	30	5	5 1-8	30	John Day	4
2. Matheson	50	5	6	E	W. McBurney	4
3. Matheson	50	5	6	E	Jas. Orme	24
4. Franklin	28	4 1-4	4	I	M. S. Bates	45
5. Oldsmobile	40	4 3-4	4 3-4	D	O. W. Hoffman	54
6. Oldsmobile	35	4 1-2	4 1-2	X	Frank Tyser	65
7. Columbia	28	4 1-4	4 1-2	48	A. B. Cohen	73
8. Pullman	40	5	5 1-4	40	J. R. Thomas	154
9. Packard	24				I. Freund	1861

CLASS B—CARS COSTING FROM \$1,251 TO \$2,499.

1. Buick	30	4 1-2	5	17	J. Muehleiser	2
2. Chalmers-Detroit	24	3 7-8	4 1-4	F	A. S. Zell	16
3. Stoddard-Dayton	35	4	5	9C	C. Barnard	26

CLASS C—CARS COSTING LESS THAN \$1,251.

1. Ford	20	3 3-4	4	T	C. E. Miller	4
2. Reo	20	4 3-4	6		Geo. Thomas	24
3. Ford	20	3 3-4	4	T	H. G. Machin	72
4. Brush	8	4	4 1-2	BC	D. W. Bussey	72
5. Brush	8	4	4 1-2	BC	R. W. Nichols	1361

SAVANNAH TO AUGUSTA ENDURANCE RUN.

SAVANNAH, GA., May 17.—The Savannah Automobile Club is arranging for an endurance run from this city to Augusta, a suggested date being May 31. An extensive prize list is being planned, and a large entry is assured for the event.

DATE FOR DELAWARE ASSOCIATION RUN.

WILMINGTON, DEL., May 17.—At a meeting held recently the Delaware Automobile Association selected Saturday, June 12, as the date for the proposed sealed time run. The course will be from Wilmington to Dover and return.



Officials in Charge of the Reliability Run.

From left to right: Robert B. Caverly, referee; H. C. Hunter, judge; Wm. D. West, pilot and president of the club, and J. K. Heyl, clerk. An energetic quartet of Washingtonians.

"SONS OF OLD ELI" ARRANGE HILL CLIMB.

NEW HAVEN, CONN., May 17.—Shingle Hill will be enlivened for the second time by the annual hill climb of the Yale University Automobile Club, on May 26. Motorcycles and automobiles will have the right of way on that day, with three classes for the former, a popular mode of transportation around this city among the students, and seven classes for autos. Under the sanction and rules of the A. A. A. there will be a price classification for the cars, and a piston displacement for the two-wheelers, with free-for-alls for both. Shingle Hill is a winding road of macadam located near this city, about 5,000 feet long, and with grades varying from nothing to 20 per cent. There is an abrupt rise at the start, a short level stretch, at the end of which there is a sharp S turn and a steep climb to the finish. The record is held by David Bruce Brown, who made the ascent in the Fiat Briarcliff racer in 1:06 4-5.

Robert Lee Morrell will act as referee and C. H. Gillette as A. A. A. contest board representative. Post & Lester have donated a valuable cup for the free-for-all in the automobile division, and a gold medal will be given by the club to the member who makes the fastest time of the day. Cups will be given to the winner of each event. Entry blanks may be obtained from R. E. Wiles, secretary Yale Automobile Club, Yale Station, New Haven, Conn.

FOR THE BABY TONNEAU CLASS.

DETROIT, May 17.—Gliddenites contesting in the baby tonneau class will have an added incentive this year, as the result of action taken by the city of Detroit. When it was first determined that Detroit would be the starting point for the big tour in July Mayor Breitmeyer urged that the municipality offer a suitable trophy, to be put up annually, as is the case with the other cups that feature in the Glidden tour. The idea met with general approval, and the sum of \$250 was appropriated for the purpose. Rivalry was keen among local jewelers for the honor of furnishing the cup, the design submitted by Wright, Kay & Company finally being accepted by the committee. The cup is a massive affair of china, beautifully decorated with hand painting.

The Wyoming Auto Transit Company, which runs automobile stages from Rock Springs to Yellowstone Park is preparing to make a test of the autofreight truck. The distance from Rock Springs to Pinedale is 120 miles. It is expected to make the distance in 10 hours with a cargo of four tons.

AUTOISTS FIGHT GARAGE ORDINANCE

MILWAUKEE, Wis., May 17.—Several sections of the proposed garage ordinance for this city have been considered so drastic that the local tradesmen and the automobile club have determined to fight its adoption by common council. Among the provisions are the following:

No garage may contain more than ten gallons of inflammable liquid in approved safety cans or more than 550 gallons in underground storage tanks. Not more than 120 pounds of calcium carbide may be kept. All fires and lights shall be extinguished before the car is brought into the garage and shall not be lighted while the car is in it. No stove, forge, torch, boiler or other furnace, flame, fire, or fire heat, no electric motor, hoist or exterior sparking device, and no artificial light, except incandescent electric globes will be permitted in any garage or portion of a garage that is not provided with an entrance on the outside of the building and separated from the garage by unperforated, approved fire walls and doors. Electric charging apparatus shall not be installed in a garage equipped for handling gasoline or other volatile inflammable liquid until the plans and method of installation have been approved by the fire chief and building inspector. The ordinance absolutely forbids smoking. A plentiful supply of sand must be kept on hand at all times for fire fighting purposes.

DOZEN PERFECT SCORES IN TRENTON RUN.

TRENTON, N. J., May 17.—In the Delaware Valley endurance run held to-day by the Trenton Dealers' Association there were twelve cars with perfect scores, out of 21 starters. The course was about 158 miles in length, going through Princeton, Bernardsville, Hackettstown, Easton, and down the valley to the finish. The perfect score cars and drivers were: Peerless, Manning; Pullman, Hardesty; Oldsmobile, Druck; Crawford, Gillim; Stoddard-Dayton, Moon; Midland, Hayes; Regal, Aller; Ford, Mosher; Mercer, Wehner; Overland, Van Horn; Buick, Eisenberg; Maxwell, Toman. The cars ran on an eight-hour schedule, with penalties for being ahead or late, and for motor stops.

TIRES BURNED IN AKRON, O., FIRE.

AKRON, O., May 18.—Fire in the seven-story Hower block to-day practically destroyed the building and its contents, causing a loss which it is thought will aggregate \$1,500,000. The building was occupied entirely by light manufacturing companies. The cause of the fire is unknown. Both the Goodrich Rubber Company and the Diamond Tire Company had thousands of dollars worth of tires stored in the building. The tires are a complete loss. There is about \$800,000 insurance on building and contents.

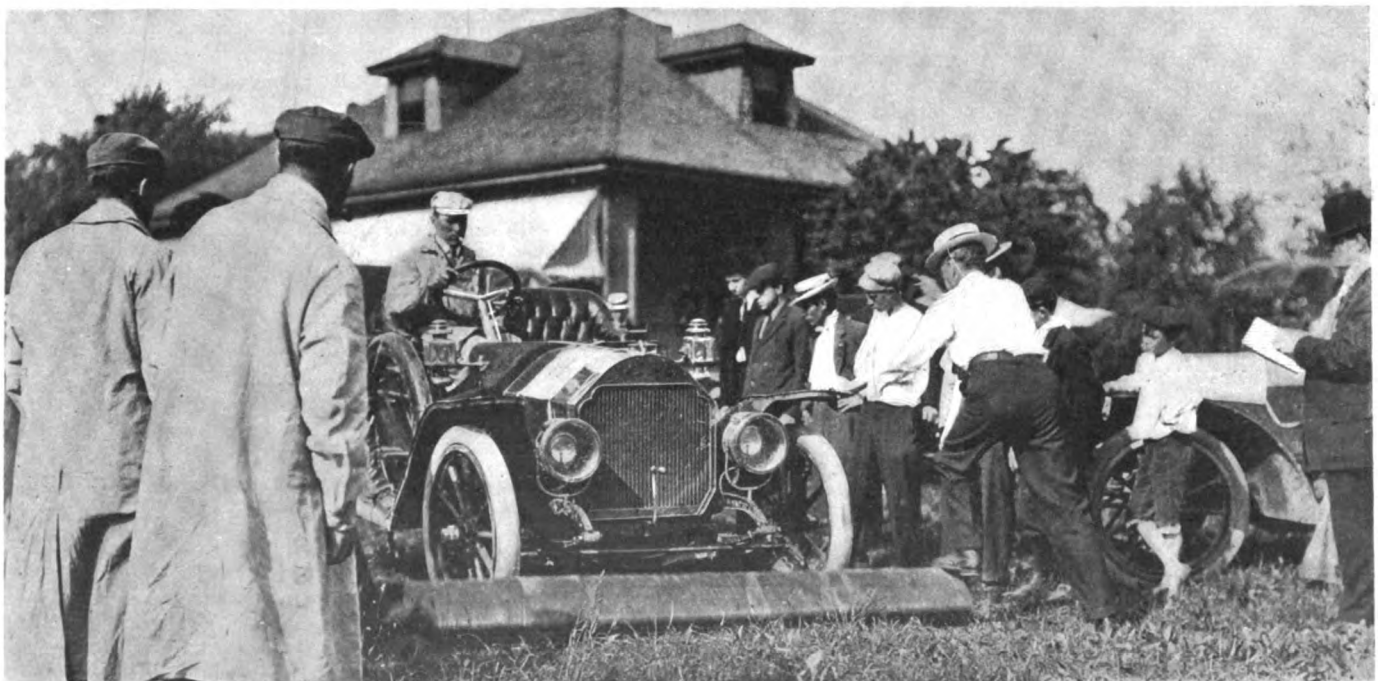

Clutch Testing of the Technical Inspection at the Conclusion of Washington Endurance Run.

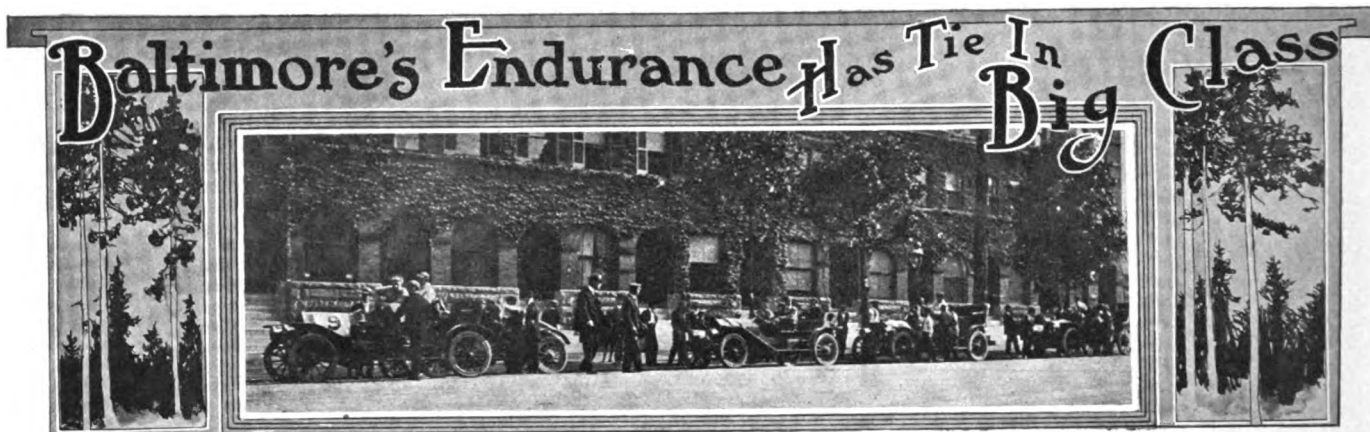

Lined Up Near the Automobile Club of Maryland, After the Return, for the Tests and Technical Examination.

SUMMARY OF WINNERS.
 Winton and Packard Tie In Class A.
 Studebaker Takes Class B.
 Franklin Perfect In Class C.

BALTIMORE, May 16.—Winners in the sealed bonnet contest and endurance run conducted by the Automobile Club of Maryland from Baltimore to Gettysburg and return, yesterday, were cars Nos. 1, 2, 3, 4 and 11. Cars Nos. 1 and 2, a 48-horsepower Winton, driven by B. B. Tatham, and a 30-horsepower Packard, driven by E. R. Marshall, were tied for first position in Class A, for touring cars over 30-horsepower, each being penalized two points. A loose fender bolt caused the Winton car to lose its points on technical examination, while the Packard was prevented from making a perfect score by taking on a quart of water. Car No. 3, the 40-horsepower Studebaker driven by Robert Yerger, captured the Class B event for tourabouts of over 30 horsepower, with a perfect score, while the 28-horsepower Franklin, driven by John L. Burns, was the headliner in Class C for touring cars under 30-horsepower, with a perfect mark. These were the only two cars of the twelve contestants that made the run without having a bad mark registered against them. The winner in Class D, for tourabouts under 30-horsepower

was the tiny 16-horsepower Hupmobile which was penalized two points because the chauffeur put some water in radiator. This infraction put two bad marks in the water test column for this midget machine. Even the two perfect score cars were at first held up on small technicalities, the Studebaker for dropping a New York license and the Franklin for using oil on the engine through a misunderstanding. The penalties in these two instances, however, were waived.

A novel stunt was put through by the entrant of the Winton cars. This was nothing less than the act of fastening over the usual quadrant, a steel plate with but two notches cut in it. In this way, it was impossible to engage other speeds than the high and the reverse as per the two notches, the steel plate covering up all others. The idea was to demonstrate the flexibility of the "six" in a startling but convincing manner. Owing to this plate, at one control it was necessary to run the engine no less than three hours and five minutes. The Winton arrived this much ahead of time, and had to keep the motor running or lose points.

The distance covered by the contestants was 136.5 miles and for the most part was over rough and rocky roads which proved a severe test for the machines. From Baltimore the motorists headed for Frederick, Md., where at James E. Solt's garage was the first checking station. This was a distance of 46.5 miles, during which many places of interest were passed. There were

SUMMARY OF THE SEALED BONNET RUN OF THE AUTOMOBILE CLUB OF MARYLAND, MAY 15, 1909.

CLASS A—FOR TOURING CARS OVER 30 HORSEPOWER.													
No.	Car	H.P.	Cyl.	Piston	Model	Entrant	Driver	Road Test	Water Brake Test	Tech'l. Exam. Total	Remarks		
								Penal-		ties			
1	WINTON	48	4 1/2	5	17-6	Winton Motor Car Co.	B. B. Tatham	0	0	2	2	Fender broke loose.	
2	PACKARD	30	5	5 1/2	30	M. S. Hess	E. R. Marshall	0	2	0	2	Took quart water.	
5	OLDSMOBILE	35-40	4 3/4	4 3/4		Olds Motor Works Branch	E. L. Leinbach					Broke pin in differential and withdrew. Contestant finished run in time, however.	
10	THOMAS	60	5 3/4	5 1/2	4-60	A. Y. Webster	L. J. Wellstood	0	2	0	32	34	Throttle control bad. Stopped motor.
CLASS B—FOR TOURABOUTS OVER 30 HORSEPOWER.													
3	STUDEBAKER	40	4 3/4	5 1/4	D	D. C. Walker	Robert Yerger	0	0	0	0	0	Dropped N. Y. license. Unpenalized.
7	GEETH	35-40	4 3/8	5 1/4	Type X	F. W. Sandruck	F. W. Sandruck, Jr.	0	0	0	45	45	Leaky gasoline tank. Muffler pipe broken.
8	STODDARD-DAYTON	45	4 3/4	5	K-09	Stoddard-Dayton Baltimore Co.	L. H. Schaab	0	12	0	0	12	Loose water connection.
CLASS C—FOR TOURING CARS UNDER 30 HORSEPOWER.													
4	FRANKLIN	28	4 1/4	5	D	Mar Del Mobile Co.	John L. Burns	0	0	0	0	0	Oiled engine through misunderstanding. Penalty waived.
12	OAKLAND	20	4 1/2	5		Little Joe Weisenfeld	E. C. Briggemann	8	2	0	57	67	Pin gone out of front spring and engine pound
CLASS D—FOR TOURABOUTS UNDER 30 HORSEPOWER.													
11	HUPMOBILE	16	3 1/4	3 3/8		Little Joe Weisenfeld	G. C. Cook	0	2	0	2	2	Water put in radiator.
6	MARYLAND	26				James G. B. Davy	James G. B. Davy	38	0	0	0	38	Delay due to 6 blowouts; otherwise perfect.
9	OVERLAND	30	4	4	30	C. S. Houghton	M. C. Jones	0	0	0	62	62	Pin out of rear spring. Loose distance rod and wheel.
14	REO	20	4 3/4	6		Little Joe Weisenfeld		0	0	0	1000	1000	Drooped gasoline tank.
15	HERRESHOFF	20				Ford Auto Co.							Failed to start.

OFFICIAL CARS.

Winton.....Pathfinder.
 Packard.....Pilot.
 Oldsmobile.....Press Car.
 Packard.....Pacemaker.

Referee—Frank S. Darling.
 Technical Committee—Dr. H. M. Rowe, George R. Snoddeal, and Frank W. Darling.

a number of water bars between these two points, but outside of these the going was comparatively smooth and easy. The first car to meet with a mishap was the 30-horsepower Packard car, driven by George A. Yakel, which was the pilot car. The pilot had departed from Baltimore at 6.54 A. M., a little more than an hour ahead of the first started in the run. When the Packard reached a point just outside of Ellicott City, about 12 miles from Baltimore, it lost its gasoline tank. This caused such a delay that it was passed by the pacemaker, also a 30-horsepower Packard, driven by E. R. Marshall, which, together with several other cars, arrived at Frederick ahead of the pilot. The latter was also behind in its arrival at Gettysburg. These accidents caused the pilot to be penalized 1,000 points on technical examination. The only other serious accident was the breaking of a pin in the differential of No. 5 car, a 35-40 Oldsmobile, driven by E. L. Leinbach, which made it necessary for Mr. Leinbach to break the seal. The car was immediately withdrawn, but after being repaired was taken over the course within the time limit by O. C. Hoff, Mr. Leinbach having in the meantime taken the steering wheel of the press car Oldsmobile.

As a means of settling the tie with the Packard, the Winton people propose to seal up everything on both cars but the gasoline and oil tanks, and then run the two cars in competition until either one or the other fails.

From Frederick the route was by way of Thurmont and

Emmitsburg to Gettysburg, where the second checking in was made at the Gettysburg Motor Car Company's garage. There the motorists were allowed an hour for luncheon or a spin around the battlefield. Those that laid over were permitted to stop their motors without suffering a penalty, providing no work was done on the cars.

From Gettysburg the trip was through Littlestown, Pa., Westminster, Reisterstown, Chattolane and Eccleston to the Pimlico entrance of Druid Hill park. From there the cars went through the beautiful park to the Automobile Club of Maryland, the last checking station. Two and three-quarter hours were given the cars for the run from Baltimore to Frederick; two hours running time from Frederick to Gettysburg, and three and three-quarter hours for the return trip from Gettysburg to Baltimore. Two of the cars that were entered in the contest did not start. They were the 20-horsepower Herreshoff, by the Ford Auto Company, and the 20-horsepower Reo, by Little Joe Wessensfeld. The other cars and the mishaps for which they were penalized for were the 26-horsepower Maryland, six blowouts; the 35-40 Gaeth, a leaky gasoline tank and muffler pipe broken; Stoddard-Dayton, 45-horsepower, loose water connection; Overland, 30-horsepower, pin out of rear spring and loose distance rod and wheel; Thomas, 60-horsepower, throttle control bad and stopped motor; Oakland, 20-horsepower, pin lost from front spring and engine pound.

SOUTH AROUSED BY NEW YORK TO ATLANTA HIGHWAY

ATLANTA, GA., May 17.—When a national highway from New York City to Atlanta was proposed by the *New York Herald* and the *Atlanta Journal*, to be fostered through the holding of an automobile contest between the two cities just before the opening of the national automobile exhibition here, it was hardly likely that the interest aroused was imagined. There has been nothing suggested in the memory of the Southerners of to-day which has caused this entire section of the country to stand up and concentrate its enthusiasm as has this movement. If a hundred circuses, the love of all people, should travel through the States of Virginia, the Carolinas and Georgia, it is hardly likely that the sentiment of welcome would be more hearty. Every little town on the three proposed routes, every county, mayors, congressmen, legislators and governors, are vying with each other in expressing support of anything that will give the South good roads, and consequently do more to benefit it than anything that has happened since the war. Railroads only tap a portion of the country, and it is hoped that with trunk lines of splendid highways there will be an awakening of great economic importance.

The two newspapers have offered prizes to the counties which have the best roads, the *Herald* giving sums of \$1,000, \$500 and \$200 for the sections between New York and some point midway to Atlanta, and the *Journal* giving corresponding amounts for those in the Southern half. Indeed the whole movement below the Potomac River has become one of the road question with the automobile endurance contest a mere means to an end. The action of the National Association of Automobile Manufacturers in deciding to hold an exhibition of national importance in this city from November 6 to 13 has been very gratifying, and the interest will be greatly increased by the endurance contest, for which cash or plate prizes will be given. The fact that there are three routes under consideration and the one selected must qualify by its highway condition has given additional incentive to work.

The routes suggested are combined from New York to Philadelphia, when one goes west to Harrisburg, thence down the Cumberland Valley to Harper's Ferry, and through the Shenandoah Valley to Lexington, crossing the mountains to Martinsville and Salisbury, N. C., where it joins the route of the second suggestion. From Philadelphia to Washington there are

two routes combined, one of which from the national capital goes to Rapidan, Charlottesville, Lynchburg, Danville, Greensboro and Salisbury, the two from that point running to Atlanta via Charlotte, Blackburg, Spartansburg, Hartwell and Winder.

The third course leaves Washington for Richmond, Petersburg, Raleigh, Columbia, S. C., and Royston, joining the others at Winder. The distance is about 900 to 1,000 miles on any of these routes, and so it is a matter of the one offering the best road. It has been suggested by the Richmond people that the Lincoln highway, being considered by Congress, would be more appropriate if built between Washington and Richmond, thus cementing the North and the South, than between the capital and Gettysburg. Another feature of this route is that it includes the capitals of all four of the Southern States, Richmond, Raleigh, Columbia and Atlanta. The difficulty is that the roads in this section are probably the worst to be found, taken as a whole, whereas those on the route through Harrisburg and the Shenandoah Valley are the best, except that they abound in water breaks and may be cut out on that account.

The first scout car has left Atlanta, a White steamer, driven by E. W. Gans, with the others of the party: Frank S. Welden, president of the Interstate Highway Association; E. H. Inman, president of the Fulton County Automobile Club; John S. Cohen, managing editor, and a *Journal* staff man. Early in June it is planned to start a car from New York and work down, the notes taken being responsible for the decision as to the best way South. Interest unquestionably is general and spreading.

MOTORDROME FOR ATLANTA WINTER RESORT.

ATLANTA, GA., May 17.—Feeling that an automobile race course is a valuable adjunct to the modern winter resort, promoters of a magnificent hotel to be built in this city, on which nearly a million dollars will be spent, have started plans for a motordrome. Asa Candler, Jr., and some of the wealthiest young men in the city have organized a company and secured options on 200 acres of land on which they say that about \$250,000 will be expended in making it a race track of note, with grand stands and accompanying buildings. This is part of the plan, it is stated, for the popularizing of the new hotel, and on a two-mile circuit there will be races several times a year.

OFFICIAL RESULT OF ONE-GALLON MILEAGE TRIAL FOR PLEASURE CARS, NEW YORK CITY, MAY 7, 1909.

No.	Style Body	Class	No. Passengers	Driver	Contest Car Weight		Weight in lbs.		Load % of Car	Avg. Ht. of Passenger, H.-m.	Distance Miles	Speed M.P.H.	Score Miles Per Gallon	Tan Miles
					Unloaded	Loaded	Live Load	Dead Load						
1	Franklin	Touring	C	S.G. Smith	2090	1900	980	51.5	196	2-57	358	12.1	10304	51 ²⁵
2	Cadillac	Runabout	A	L.R. Burne	2325	1625	700	43	146	3-6	426	13.8	9965	49 ⁵²
3	Lozier	Baby Touring	F	C.R. Emme	5230	4025	1205	284	172	1-19	171	13.1	8943	44 ²¹
4	Matheson	Touring	F	A.D. Hall	5600	4450	1150	258	164	1-10	155	12.0	8600	43 ⁴
5	Buick	Touring	B	H.P. Cook	3070	2230	840	376	168	2-7	282	13.3 ²	86574	43 ²⁰
6	Fiat	Coupe	E	R. De Palma	3260	2530	730	288	146	1-34	259	16.5 ²	84434	42 ²¹
7	Chalmers-Df.	Touring	C	E.M. Stevens	3045	2275	770	382	140	1-26	257	13.5	78300	39 ⁰²
8	Lancia	Touring	E	C.H. Targenton	3220	2550	660	257	165	1-25	239	16.0 ²	76950	38 ⁴²
9	Thomas(Taxi)	Cab	G	O. Kussen	3385	2730	655	24	54	1-41	227	13.5	76839	38 ⁴²
10	Chalmers-Df.	Touring	C	F.T. Carrigan	3205	2370	835	382	167	1-32	21	14.8	67305	33 ⁰²
11	Cadillac	Deft. Tour	C	I.N. Ungerer	3115	2530	585	232	146	1-27	2155	14.1 ²	67126	33 ⁴⁶
12	Overland	Runabout	B	G.O. Reiss	2580	2150	430	20	143	0-49	242	13.0 ²	62436	31 ⁵²
14	Renault	Leisurelet	F	P. La Croix	4215	3530	685	194	137	1-10	133	11.4	56289	28 ⁰²
13	Buick	Tourabout	B	I.D. Jones	2105	1695	410	246	137		27		56039	28 ⁴¹
15	Brush	Runabout	A	M. McLaren	1370	1080	290	268	145	2-39	406	15.3	65622	27 ²¹
16	DeDion(Taxi)	Cab	G	E. Corcher	3090	2460	630	256	126	1-19	18	13.8	55620	27 ²¹
17	DeDion(Taxi)	Cab	G	W. Cullen	3050	2400	650	252	162	1-26	178	12.5 ²	54290	27 ¹⁴
18	Overland	Baby Touring	D	H. Cassidy	3345	2690	655	244	164	0-49	16	19.5	53500	26 ⁷⁴
19	Kissel	Touring	C	J. Hopkins	3290	2435	865	351	171		133		43757	21 ²⁷
20	Brush	Runabout	A	H. Moore	1420	1110	310	274	155		209		29678	14 ⁰⁴
BB Totals:					62600	48775	14025							
Average for all cars					3140	2438	701	28.7%	Weight per HP 110 lbs.					

Start, Automobile Club of America, New York, over Queensboro Bridge and 17 miles east into Long Island, then south through Kings County, beyond bridge, average good pavement for American road, rolling terrain.

Class Winners

A 650 & under B 651 to 1250 C 1251 to 2000 D 2001 to 3000 E 3001 to 4000 F 4000 & over G Touring
 Cadillac 4-cyl. Buick 2-cyl. Franklin 4-cyl. Overland 6-cyl. Fiat 4-cyl. Lozier 6-cyl. Thomas 4-cyl.

Committee:

City Club of America
 Charles F. Clarkson
 L.M. Bradley
 William F. ...

ONE-GALLON CONTEST TOLD IN OFFICIAL STATISTICS.

THE two tables shown on these pages represent the final results of the New York Trade Association's One Gallon Economy Test, and an examination of them reveals some very interesting facts. The cars are arranged in the order of their final standing, with the winning Franklin at the head.

A study of the time-distance-speed columns show that the first four car drivers all adopted the same speed. This averages 12.75 miles per hour, while the average for all but three, whose figures are not available, is 14.37 miles per hour. The winning car had a speed which was the third lowest in the contest, the highest speed noted, on the other hand, being that of a car placed last of those whose time was given. From these facts one would argue that slow speed was more economical of fuel, the speed used among the first four being about equal to one-third the normal engine speed, with the direct drive or high gear engaged. It is to be regretted in this connection that the committee in charge did not have the observers secure data relative to the gear used.

The winner, for instance, used 32-inch wheels, and the gear reduction was 3 3-4 to one. Figuring backward from these and the actual average speed, the average engine revolutions were almost exactly 477. As the normal engine speed is given as 900, this is only 53 per cent. of full speed.

The next car in order for which reduction figures are obtainable, the Lozier, figures back to less than 300 engine revolutions if the high gear was used. As this very slow speed of the engine would not be an economical one, it is doubtless true that the driver of this car pinned his faith to a lower gear than the direct drive, figuring that other economies attendant upon this would offset the transmission losses on the indirect speed.

In connection with the speed comes the question of passenger mileage. This would be equal to the number of passengers times the mileage. In the first four instances the figures are: 1, Franklin, 179; 2, Cadillac, 170.5; 3, Lozier, 119.6; 4, Matheson, 108.3. The peculiarity of these figures lies in the large gap between the first two, averaging 174.75, and the second two, which only average 113.95. The two former being so close together, practically alike, while the others are also practically alike but with 60 passenger miles intervening, makes a very funny situation.

This same peculiar situation relative to passenger miles obtained in the two-gallon test held in May, 1906. The highest passenger mileage was then made by the Mack observation car with 171.3. Between this and the two closest competitors there was a very large interval, the Frayer-Miller scoring 119.75 and the Darracq 116.1. Here the first car made a score practically identical with the score of the first two cars in the One Gallon Contest, while the two next made totals almost identical with those of the third and fourth cars of last week.

The high efficiency of the first two cars rested on the proportion of live or passenger weight to the dead weight of the cars. These cars were two of the five which weighed less than a ton, but none of the other very light weight cars made a very good showing. An examination of the column headed "live load in per cent. of total" tells the story. The two highest percentages in the contest were those of the first and second place winners.

Windage areas tell a funny story, too. The apparent use of a small area, and consequent lessened wind resistance, was not taken into account by any one, as the results show that the large

and small areas in combination with large or small scores "just happened." In the group including the four best scores is included the highest wind area, while the fifth car had the second largest. On the other hand, the lowest frontal area went with the fourteenth place. The winner had neither a large nor a small figure, and in arranging the cars for wind area would come in seventh place. The only deduction possible from these figures is that the wind resistance does not enter up to a certain speed, or certain very large area, both of which were not exceeded in the contest under consideration. As a matter of fact the car making the greatest speed of the day attained but 20 miles per hour, so that this low speed accounts for the lack of connection between the frontal area and the result. The car just mentioned, by the way, stood tenth on the area list, only two others intervening between it and the winning Franklin.

Once more the officials in charge are to be congratulated on their painstaking efforts which resulted in the tables from which the above deductions are made.

PORTER HILL FOR CLEVELAND CLIMB.

CLEVELAND, May 19.—Its back to Porter Hill for the 1909 climb of the Cleveland Automobile Club. This is the slope that was used last year and is ideal with the exception of its unhandy location. The hill itself is practically ideal, being an exact half mile, with just enough room at the finish for a straightaway brush. There is practically no chance of an accident, while spectators can secure an excellent view from almost any point.

The club is starting an active campaign for entries and it is believed that the lists will be better filled this year than on any

previous occasion since 1906, the last time the climb was held at Gates Mills. As a whole, the local dealers are enthusiastic about the event, in marked contrast to their stand last year.

The roadway proper will be graded and smoothed by the Automobile Club officials at once, while the rural residents will give their assistance in this work, as they are in favor of the climb being held there.

WILL CLIMB DEAD HORSE HILL ONCE MORE.

WORCESTER, MASS., May 17.—On Saturday, June 12, the Worcester Automobile Club will hold its annual hill climb, Dead Horse Hill being once more the scene of activity. This is just a mile long, starting with a slight down grade and then rising abruptly. The first grade, after crossing the bridge, is of 10.3 per cent., but this is not the worst, as up at the half-mile post is a steep stretch which averages 12.2 per cent.

There will be a full list of events, totaling sixteen. These include the first of the M. C. A. classes as far as piston displacement and minimum weight are concerned. In price classification, however, six additional classes are provided. Event number six takes care of the motor cyclists, and numbers seven and sixteen will give the steamers their chance.

ALBANY HILL CLIMB FOR JUNE 5.

ALBANY, N. Y., May 17.—The second annual hill climb of the Albany Automobile Club has been postponed to June 5, that being the first day on which the roads can be closed. The entry blanks have been issued, and may be secured from the club headquarters. There are seventeen events on the program.

OFFICIAL RESULT OF ONE-GALLON MILEAGE TRIAL, NEW YORK CITY, MAY 7, 1909.—(Continued)

No.	Car	Horse Power	Rear Wheel	Engine			Carburetor	Ignition			Windsage Area Sq. Ft.	Cooling	Tires Make Size	Miscellaneous	Trans. ratio
				Bore	Stroke	Compression Ratio		Valves	System	Mag. Make					
1	Franklin	4-V 18	18	3 1/2 x 4	7 1/2	300/600	Own carburetor	1	dash	28"	Air	Goodyear 30x3 1/2	Tankon	3 1/2-1	
2	Cadillac	1-H 10		5 x 5		200/600	Own	1	d.c.	24"	vt. cont. pump	30x3 1/2	Std. Ball	2 1/2-1	
3	Lozier	6-V 51	50	4 1/2 x 5 1/2			Shedler	2	ster	30"	vt. cont. pump	30x3 1/2	Mess. Bright	2 1/2-1	
4	Matheson	4 40	45/60	5 x 6	60		Multi-jet	1	d.c.	25"	vt. cont. pump	30x4	Hgott	3 1/2-1	
5	Buick	2-H 16 1/2	18	4 1/2 x 5	65	200/600	Shedler	1	both	29"	vt. cont. pump	30x4	Hgott	3 1/2-1	
6	Fiat	4-V 16	12	50x100mm			Own	1		28"	vt. cont. pump	32x3 1/2	Std. Ball	3 1/2-1	
7	Chalmers-Dt.	24	24	3 1/2 x 4 1/2	60	1500	Mayer	2	ster	28"	vt. cont. pump	32x3 1/2	Std. Ball	3 1/2-1	
8	Lancia	9	12/10	90x100mm			Ten jet	1		25"	vt. cont. pump	32x4	Ball		
9	Thomas(Taxi)	18 1/2	16 1/2	3 1/2 x 4 1/2		1200	Mayer	1		29"	vt. cont. pump	32x4	Ball		
10	Chalmers-Dt.	24	24/30	3 1/2 x 4 1/2		1500	Mayer	2	ster	28"	vt. cont. pump	32x3 1/2	Std. Ball		
11	Cadillac	25 1/2	30	4 x 4 1/2		800	Own	2	both	22"	vt. cont. pump	32x3 1/2	Ball		
12	Overland	22 1/2	14/20	3 1/2 x 4 1/2		60	Shedler	1	d.c.	21"	vt. cont. pump	32x3 1/2	Ball		
14	Renault	22 1/2	18	3 1/2 x 3 1/2		900	Shedler	1	d.c.	27 1/2	vt. cont. pump	30x3 1/2	Tankon		
13	Buick	1-	7	4 x 4	65		Buffalo	1	d.c.	24"	vt. cont. pump	28x3	Ball		
15	Brush	4-V 14 1/2	12	3 x 4		1600	Automatic	1		26"	vt. cont. pump	32x4	Plain		
16	DeDion(Taxi)	14 1/2	12	3 x 4		1600	Zenith	1		26"	vt. cont. pump	32x4	Plain		
17	DeDion(Taxi)	6-	38 1/2	4 1/2 x 4 1/2	60	1100	Shedler	1	d.c.	23"	vt. cont. pump	36x4	Std. Ball		
18	Overland	4-	28	30	4 1/2 x 4 1/2	1000	Stromberg	1	d.c.	26"	vt. cont. pump	32x4	Tankon		
19	Kissel	1-	7	4 x 4			Buffalo	1	d.c.	24"	vt. cont. pump	28x3	Ball		
20	Brush	73	443												

Referee Alex. Chisholm
 Inspectors:
 Weights O. J. Stronachan
 Eng. & Carbu. Joseph Tracy
 Ignit. & Cooling E. T. Birdwell
 Gasoline & Tanks James J. ...
 Oil & Tanks W. J. ...
 Tires & Bearings A. H. ...
 Windsage Area J. W. ...
 Starter: ...
 Timer: Fred J. Wagner

Tanks
 Most cars had special small tanks on dash

Cooling
 All water cooled except Car No 1

Wind: about 15 miles across course first 7 mi following wind meter 22 mi
 vt. vertical tube
 r.c. round calorimeter
 s.c. square calorimeter
 f.t. fin tubes
 h.t. horizontal tube
 v.c. v. long vert. calorimeter

Total Passenger-Miles 1978 1/2
 Fuel, each 1 gal = 20 gals.
 @ gasoline @ 15¢ per
 Average cost per passenger-mile 1.22 cents

Total Ton Miles 692 1/2
 With gasoline @ 75¢ per gal
 Average fuel cost per Ton Mile = 4.2¢ mile
 Lowest - - - - - = 2¢

Data compiled and results prepared by H.F. CUNTZ ME



Chalmers-Detroit Tackling a Tough New Mexican Grade on Its Way to Mexico City.

EIGHT PERFECT IN DETROIT RUN, DESPITE WEATHER

DETROIT, May 17.—Eight perfect scores and one penalization protested to the A. A. A. was the outcome of the four days' endurance contest held under the auspices of the Detroit Auto Dealers' Association, and which ended Saturday afternoon in the midst of a good-sized cyclone.

The six hundred and fifty miles embraced in the tour were covered under conditions never before encountered by local autoists in a similar event, and the fact that eight crossed the line with a clean slate must be regarded as a high tribute to the staying conditions of the cars and the skillful work of their drivers. A week's steady downpour made it advisable to postpone the start for a day, in the hope that roads rendered well nigh impassable would improve a trifle. The run on Wednesday was through a sea of mud that made going anything but a joy. Before the cars pulled out Thursday morning J. Pluvius once more trotted out his watering pot, and the heavens leaked until participants in the run were soaked to the skin.

Friday's run was under a clear sky, but over roads from which the bottom had dropped until its recovery seemed impossible.

An hour before the close of Saturday's run the autoists ran into a rainstorm that quickly developed into a full-fledged cyclone. Barns were lifted from their foundations, trees blown down and not less than two-score telephone poles laid low across the path of the cars in something like two miles. Lee Lorimer, driving a Chalmers Thirty, was picking his way through a downpour of rain that made it difficult to see fifty feet ahead when there came a quick succession of reports and a long row of poles fell across the road with a crash, the first being but a few yards ahead of the car. Applying the brakes quickly, at the risk of putting the car into the ditch, Lorimer barely missed striking the pole. Almost at the same instant there were other reports at the rear, and looking back the occupants of the car saw three poles drop just behind them, with a Maxwell Thirty and an American Simplex just outside the barriers.

With the aid of farmers who came hurrying to the scene the three poles were lifted from the road, allowing the Chalmers car to back out and take another course followed by the other cars. This resulted in a delay of forty-five minutes on a schedule that was nearly exhausted, and from that point into the city it was a wild race to get under the wire.

There was no lack of excitement through the entire day, owing to the frightful condition of the roads. The confetti car stuck in the mud ten miles out of Port Huron, and the confetti

was passed over to the press car, and finally turned over to another machine, which marked the trail. More than once the cars were held up by the mud until fence rails could be laid down to form a roadbed, all hands assisting in the task, owners of rival cars vieing with each other in helping to remedy conditions that could not under any circumstances have been worse.

Tire troubles were so numerous that after the first day they attracted little attention. One of the contestants was compelled to make nine changes in three days, all due to punctures, and others were close rivals for second place in this respect. Cars were divided into three classes, in each of which the prize was a handsome trophy donated by the local press. The entries and official score of all cars entered follows:

CLASS A—CARS LISTED AT \$2,000 AND OVER.			
No.	Car.	Driver.	Score.
3.	Chalmers Forty	Machesky	1.000
4.	Stoddard-Dayton	Tuttle	1.000
5.	Chalmers Forty	Vincent	1.000
8.	Stoddard-Dayton	Neumann	1.000
10.	Franklin	Carris	1.000
6.	Stevens-Duryea	Scofield	.991
1.	Pope-Hartford	Bemb	.989
2.	American Simplex	Woods	.781
CLASS B—CARS LISTED AT \$1,500 TO \$2,000.			
11.	Chalmers Thirty	Lorimer	1.000
12.	Maxwell Thirty	Goldthwalte	1.000
13.	E-M-F Thirty	W. Lane	.994
15.	Chalmers Thirty	Bamford	.983
7.	Mitchell	Gillmore	.957
CLASS C—CARS LISTED AT LESS THAN \$1,000.			
19.	Maxwell Junior	Moran	1.000
18.	Hupmobile	Keeler	*.998
16.	Brush	McKenney	.923
17.	Brush	Huss	.915

*Penalization protested to A. A. A.

MISHAP IN FLAG-TO-FLAG RUN.

EL PASO, TEX., May 19.—On its first day's run into Mexico the flag to flag pathfinder, a Chalmers-Detroit Thirty, had a mishap with a serious accompaniment for its passengers. In laying out the route for an endurance contest from Denver to Mexico City, the car had left this city, crossed the international line, and was 56 miles away when a gear gave way. The car was midway between the two railroads, 46 miles from the nearest, and W. E. McCarton, a passenger walked that distance to catch a train to this city. He left shortly after with food and water for driver William Knipper and photographer F. Ed. Spooner, who had remained with car, without food, and only the water in the radiator to drink. Start was made again this morning.

Automobile Gasoline and Other Available Fuel

BY Thos. J. Fay

Part VI

SPECIFIC HEAT, unlike the latent heat of evaporation, refers to the heat required to raise a given (unit) weight of the elements and compounds through one degree of sensible temperature. Latent heat refers to the evaporation of a liquid, as before explained, and specific heat is involved when the temperature is changed, without changing the state of aggregation. From the point of view of scavenging, which is a condition that follows evaporation and combustion, the specific heat of the products of combustion would have to be taken into account in an attempt to fix the magnitude of the influence of the presence of such products. Assuming that the design is good and that a motor is in proper working order, the allowable compression depends upon several factors as follows:

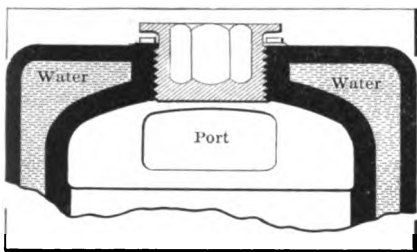

Fig. 27—Inadequate supply of water over combustion chamber is a prolific cause of pre-ignition.

of which gasoline is composed considering its complex character.

(B) The specific heat of the mixture, which will differ as the composition changes, it being the case that all the contents entering into mixtures are not of the same specific heat.

(C) The extent of scavenging and the heat of the spent products of combustion in the absence of complete scavenging.

(D) The temperature of the water in the water-jacket or the efficiency of the air-cooling process if air is used direct for purposes of cooling.

(E) The design of the cylinders and the extent to which the surfaces maintain an even temperature; if some one zone on the surfaces is at a high heat pre-ignition will follow, it being the case that this heated zone will be at the bottom of the trouble, nor does it matter if the zone is of small area. This trouble is most likely in cylinders of relatively large bore, in which the piston is likely to heat up at the axis of the head, which is the greatest distance away from the cooling medium, and it generally is the part in which the heat conductivity is a minimum because the metal is coated with a crust, due to elevated temperature, and the metal in the head is thin in order to have the piston as light as possible.

(F) If the valves are not properly water-jacketed they are likely to heat above the desired temperature and pre-ignition will be due to such over-heat.

(G) In some cases to make the motors as short as possible the water-jacket is so designed that but little of the cooling liquid will circulate over the dome of the combustion chamber, which is just the part that requires the greatest amount of cooling, and pre-ignition will be eminent in all such cases. Fig. 27 shows this construction.

(H) Fins, seams, perturbances, etc., due to defective designing or misplaced cores in the foundry process, will heat up and they will be the direct cause of pre-ignition.

(I) If the water circulation is not good, or if the amount of water circulated is inadequate, pre-ignition will follow. In some cases the water is enabled to short-circuit across from the inlet to the outlet without passing over the hot surfaces and this is a prolific cause of pre-ignition.

(J) Increasing compression tends to increase the terminal pressure, thus allowing and engendering an increase in speed

of the motor without pre-ignition because the conditions of scavenging improves as a result.

(K) Running on a "retarded" spark results in overheating and pre-ignition is likely to follow if the other (remaining) conditions are favorable.

(L) Running on a mixture that is too rich will cause excess heating, which is indicated by a steaming cooler, and pre-ignition is likely to be one of the manifestations.

The Good That Comes from Increasing Compression.—When motors were designed in such a way that compression was not taken advantage of it was found that the power was very feeble and, as before stated, compressing the charge was the greatest stride in the direction of maximum weight efficiency. If the weight efficiency is high the power will be high, for weight of motor and in automobile work as well as in certain other zones, it is desirable to have a high weight efficiency. Under the circumstances it is not wonderful or strange if the question of compression is much discussed, and in view of differences that can follow variations in design it is natural to expect that differences of opinion will creep in.

Some tests were made for the purpose of determining as to the practical limits of compression, using a motor with dimensions as follows:

DIMENSIONS OF MOTOR USED FOR TEST PURPOSES.

Bore.	Stroke.	H.P. (actual).
4 1-2	5 1-2	32.2

The compression was changed from a maximum of 95 pounds per square inch (absolute) down to 75 pounds per square inch (absolute) without altering the speed that the car was able to make, on a hard level road, with all the other conditions maintained, as nearly as possible, constant. The compression changes were by five pound increments, so that little, if anything, was taken for granted and the observations were carefully made.

What these tests indicated were that losses due to high compression made such inroads on the gains that the net result failed to show any advantage such as would warrant one in accepting the disadvantages. The disadvantages are by way of reduced flexibility, knocking under certain well defined road conditions and far higher depreciation, due to greater strains that will abound in the members that must take the shock. A practical demonstration does not prove everything, but it is worth taking into account and in the light of cold experience this question of compression reaches a limit and if account is taken of the service to be rendered and the happenings in view of service, it may be that the discussion can be simplified and the limit may be placed. In the first place, both from the point of view of abstract theory

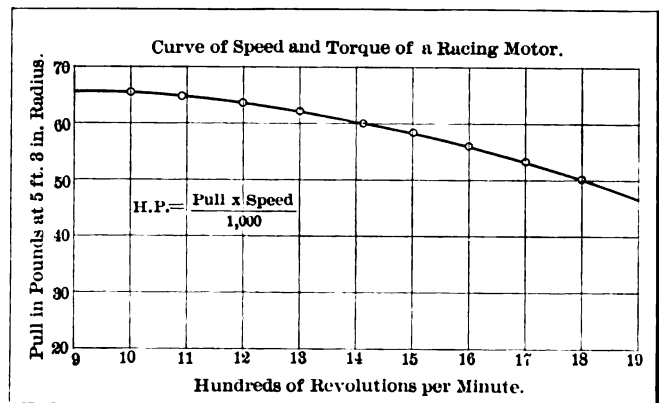

Fig. 28—Curve of speed and corresponding torque of a racing motor depicting high piston speed.

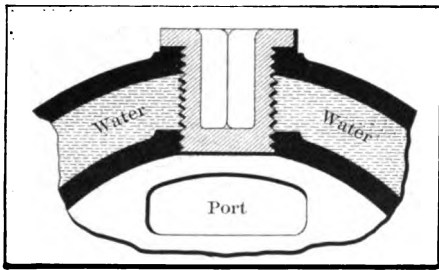

Fig. 29—Section showing defective cylinder plug allowing water to enter combustion chamber.

sion (on the compression stroke) and unfortunately the mean effective pressure is not increased in direct proportion to the increase in compression.

While it is true that power is lost during the compression stroke, it is equally a fact that power may be gained during the exhaust stroke (indirectly) due to increased compression if the speed can be increased and if the mean effective pressure does not decrease as a result of the conditions that increasing speed may dictate. It has been found in practice that with large valves, high compression and balanced forces, due to good mechanical design and construction, the speed can be very high indeed without suffering a loss of mean effective pressure, so that the power (in such motors) increases directly as the speed up to even 2,000 feet per minute of piston travel, which is double that taken as a basis of the accepted formula.

The accepted formula for horsepower in motors of the conventional (automobile) design is as follows:

Let

- H.P. = brake-horsepower of the motor,
- d = diameter of the bore of the cylinders in inches,
- n = number of cylinders (four-cycle),
- k = a constant taken on a basis of 1,000 feet per minute for the piston speed and agreed upon as 2.5.

When

$$H.P. = \frac{d^2 n}{k} = \frac{d^2 n}{2.5}$$

Obviously, at a constant torque, which would be assured were the mean effective pressure to remain a constant, doubling the speed of a motor, which would double the piston travel, would also double the power of the motor. In any attempt to discriminate, then, having in mind the best compression, the mechanical limitations must be uppermost. Having fixed such limits, the area of valves must be taken into account and then it will be proper to estimate the extent to which compression may be increased, having in mind the fuel characteristics. True, the question of cooling and all the other details will have to be favorable, and when everything else is taken into account, the road conditions will have to be kept before the mind's eye.

Of course, a racing car in the hands of a very skilled driver can have many things in its makeup that would scarcely be desirable in a car to be used by an average driver let alone men who know nothing about mechanics and whose minds are not of a mechanical bent. In fixing the compression, then, account must be taken of the service to be rendered and cars may well be divided into classes as follows: (a) Pleasure vehicles in the hands of owners who may not excel in mechanical skill, (b) pleasure vehicles to be driven by professional chauffeurs, (c)

taxicabs, (d) commercial cars in general, (e) racing and speed cars.

If increasing compression demands increasing skill to match, as it does, beyond a certain point, the

compression should be a maximum in racing cars, somewhat less for chauffeurs, a good mean for owners of pleasure cars and the minimum for taxicabs and commercial vehicles. This grading is on the assumption that it is good practice to sacrifice power to simplicity in proportion as simplicity taken on a commercial value. Then, there is the question of the inroads that increasing compression will make on the net average result, as for illustration the performance of a car on a level hard road will be better than on a grade considering high compression. But this is another way of talking about the power curve (curve of torque) under different conditions of speed. When a motor is rotating at a high rate of speed as will be possible if the car is going on a hard level road, the effect of leakage of compression is minimized and losses to the water-jacket will be the least. As a result the compression pressure will be a maximum and it follows that the combustion pressure will be a maximum also. If so the chances of maximum power are good if the design of the motor is consistent and the strength of parts is adequate.

On a grade if motors slow down the losses due to leakage of compression will be a maximum and the water-jacket will absorb more heat so that the combustion pressure will be lowered, and to compensate for this the driver is nearly sure to adjust the relation of diluting air to gasoline in favor of an over-rich mixture. The motor will then heat up, power will reduce and the end will be knocking, especially toward the end of a long up-hill drive.

Knocking on a long grade may be due to increasing compression, attending decreasing speed, coupled with increasing heat, following a diminishing cooling effect, resultant of the influence of gradient in

that the power requirement is a maximum. Under such conditions pre-ignition will be the most likely cause of the knocking, but a small flywheel can influence the situation to a vast extent. Racing motors may be deliberately designed for the conditions such as will assure pre-ignition if on a grade of some length the power requirement is enough to lower the speed of the motor, thus increasing the compression and the heat, as above referred to.

The best way perhaps to illustrate this point is to show a curve of torque under several conditions of speed, using just such a curve as was furnished by a racing motor. Fig. 28 is offered for the purpose, and as will be observed, the best power came at a speed approximating 1,800 revolutions per minute, and since the motor was a four-cylinder, 150-millimeter (square), it follows that the piston travel was:

$$F = \frac{150}{25.4 \times 12} \times 1,800 \times 2 = 1,769.76 \text{ feet per minute}$$

The curve, Fig. 28, shows that the pull in pounds at 1,800 revolutions per minute of the motor was 50 pounds, and since the length of the lever arm of the prony brake (of the balanced type) was 5 feet 3 inches, it follows that the power of the motor was:

$$H.P. = \frac{50 \times 1,800}{1,000} = 90 \text{ horsepower.}$$

The torque of this motor increased with decreasing speed, which is the real matter of the moment, which increase was from 50 to 66 pounds, and the latter figure was noted at 1,000 revolutions per minute. Below this speed the torque fell away, due to leakage, effect of the water-jacket, etc., and it is a plain

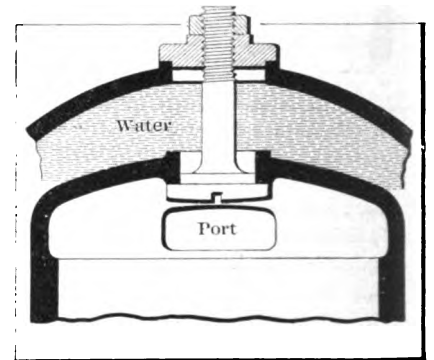

Fig. 31—Instead of a plug, covers are used, allowing water to reach all surfaces.

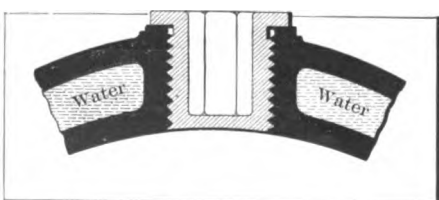

Fig. 30.—More perfect design with enough thread on plug to abort stripping.

deduction that pre-ignition would take place at 1,000 revolutions per minute, which speed would be that due to an overlead on a long up-grade, coupled with increasing heat. This would not of necessity be so were the motor of a low compression character considering the performance at the higher speed. In this case the compression was high at the high speed, which would be a fair indication in that the torque was equal to

$$T = 50 \times 5.25 = 262.5 \text{ pounds pull at 1-foot radius.}$$

The mean effective pressure (*M.E.P.*) was:

$$M.E.P. = \frac{90 \times 33,000}{(5.905^2 \times 0.7854) \times 1,769.6} = 63.3 \text{ pounds per}$$

square inch, corresponding to brake-horsepower.

When

90 = horsepower (actual),

33,000 = foot-pounds per minute for 1 horsepower,

5.905 = bore of cylinder in inches,

0.7854 = $\pi/4$,

1,769.6 = piston travel in feet per minute.

The formula as above gives the *M.E.P.* that is directly assignable to the actual horsepower of the motor, to which must be added such a percentage as will equal to losses in the motor from a mechanical standpoint. If, in a motor of this sort, considering the high speed, the losses are taken as equal to 25 per cent., the real *ME.P.* would have to be:

$$63.3$$

$$M.E.P. = \frac{63.3}{0.75} = 84.4 \text{ pounds per square inch.}$$

$$0.75$$

This phase of the subject is pursued to the extent necessary to bring out the fact that compression must be that which will afford the desired results considering the class of service to be performed by a motor, and it is plain that in a certain class of work it is even an advantage to court pre-ignition. In general service, however, it would be the height of fallacy to design for high compression rather than for acceptable speed, and on the whole it is the right course to consider the speed, such as the motor will thrive under, and fix the fuel compression to conform to the requirements.

Water in Cylinders Makes for Trouble.—Frequently it is found that water passes into cylinders through defects in castings in which slag is enmeshed or due to misplaced cores. In one case that came prominently to the notice of the author a large number of cylinders were so designed that the plug in the cylinder heads failed to satisfy the requirements and water found its way into the cylinders as a result. The defective design is illustrated in Fig. 29 and it will be observed that a plug (bronze) was screwed in, forming the connecting link between the inner and the jacket domes. In service due to differences in heat the thread on the plug stripped at the inner dome and water readily passed into the cylinders.

This problem is serious even when the cylinders are properly designed, but there is small chance of being able to realize much

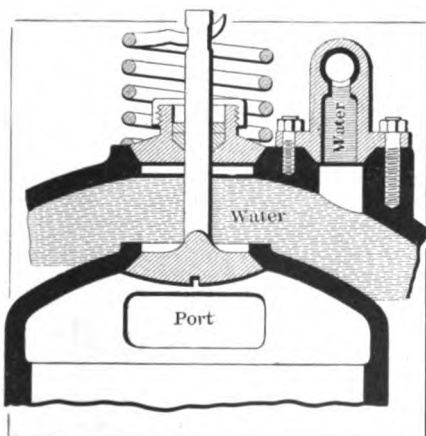

Fig. 32—Differences in expansion compensated for by using springs to hold covers in place.

satisfaction from a motor designed to include the construction as depicted in Fig. 29. Since this is a problem involving the mixture, rather than cooling, it is believed to be proper to discuss it under this head. Fig. 30 shows a modification of the defective plan as indicated in Fig. 29. The plug is screw in all the way and the inner and outer walls of the dome are joined. This is prob-

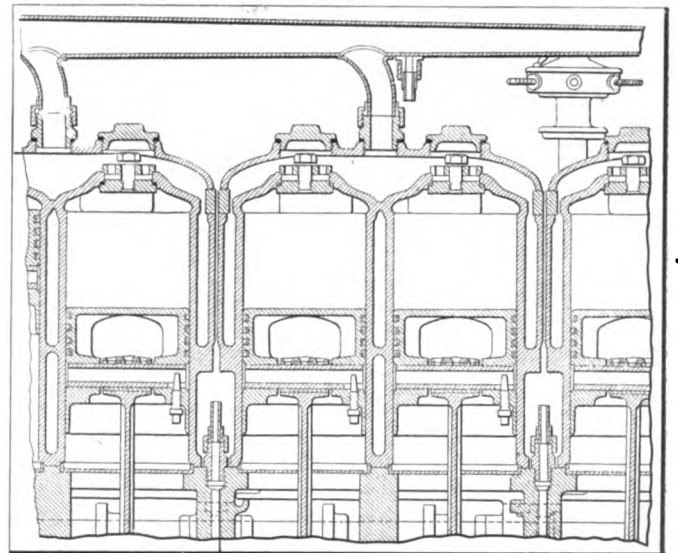

Fig. 33—Section of a Pierce motor showing correct method of providing differences in expansion.

ably a better form of dome than the other, yet even so, it is far from perfect, since it fails to take into account the considerable differences in temperature that must abound at this point in cylinders and the resultant strains.

Still another way to close up the head of cylinders is shown in Fig. 31, many of which have been used, and when the work is well executed this form of cap holds tight to a very satisfactory extent. In this form, as the illustration depicts, a flat-seated, valve-like structure is employed, and a cap is screwed down on the stem to cover the water dome with a nut outside, which is used to tighten the device sufficiently to spring the water dome toward the inner dome, thus bringing a considerable amount of work on the stem. If the stem is not of good material and of adequate section the end will be a leak to the combustion chamber due to elongation of the stem. In this case all joints are ground to a tight fit and once the cylinder is rendered tight if the stem is strong enough to stand the strain the job becomes permanent and tight.

Fig. 32 represents a theory involving the differences due to heat changes, in which the inner and the outer caps are held to their respective seats by means of a strong spring. In this case the stem is not subjected to the strains due to heat, but have to sustain against the pressure of the spring only. The seats are all at an angle of 45 degrees to be ground tight the same as a valve as used in the conventional way.

An excellent plan that works out well in practice and is used on motors of reputation is the one depicted in Fig. 33. In this case the dome of the combustion chamber is absolutely separated from the dome of the water-jacket, and means are provided to maintain each of the covers as tight as the occasion requires, in such a way as to assure entire freedom from all the ills of heat changes. As will be observed, water contacts with the cover over the combustion chamber, and in this way, all the heated surfaces are adequately cooled. The scheme is not complicated, and the cost of doing the work in this way is no bar to its use. The cylinders are cast in pairs, with separate dividing walls, and unequal expansion, which is likely to lead to leakage, with consequent loss of compression, is done away with.

This phase of the subject cannot well be concluded unless to point out that any defect which will let water in will allow the combustion products to escape, and it is a self-evident proposition that the combustion products, if they get into the water system, will soon make an outlet at the expense of the system. The author witnessed just such a case, and the bottom of the water tank was blown out by the force of accumulated pressure thus precluding a road repair.

(To be continued.)

Helpful Hints on Ignition Topics

By
MORRIS A. HALL

THE subject of ignition is one about which much of mystery and secrecy lingers, hence it is a very deep question for the ordinary driver to go into. As an aid to the man learning to drive his own car, and desirous of learning a little something about its component parts, a few of the more important parts of the ignition system will be taken up and explained.

There are in general use two methods of igniting the charge in the cylinder of an engine of the internal combustion type. These are the mechanical and the electrical processes. The former being the least important will be mentioned first.

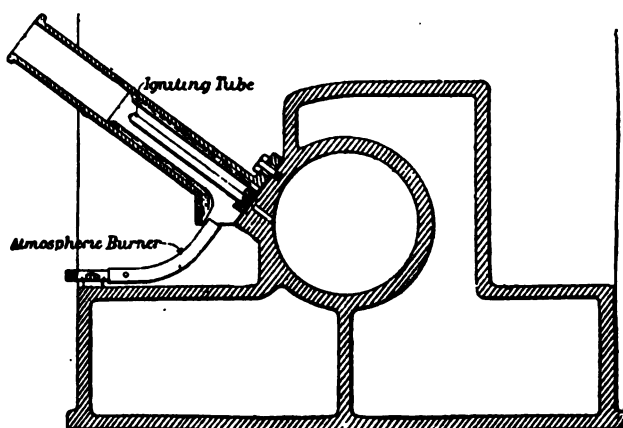

Section Through Typical Hot Tube Igniter.

It has of itself, two forms, the hot ball and the hot tube. The hot ball takes the form of a ball-shaped piece of metal projecting into the cylinder or closely connected with it. This is intended to be heated by the operation of the engine, and when so heated, gives its heat to igniting the next charge drawn in. So the action is in the nature of a preignition, but the location of the mass of metal is so chosen that the firing of the charge does not take place until the crank has so nearly approached center that a backfire will not take place. To start the engine in the first instance, it is necessary to heat the ball or mass of metal from the exterior, by means of a torch. This takes some time and so the process of starting is an extended one. As a result, the form of ignition is not a popular one, in fact, it is only used on a few stationary engines, which require starting but once a day, or at least not frequently.

In the early forms of automobiles, the hot tube was used extensively, as on the Daimler and the early French collaborators of his time. It consists essentially of an endless or blind tube of platinum or platinum and porcelain combined, which was heated by means of a small and independent flame. This flame is fed through a separate pipe leading to it from the gasoline tank. The heated tube ignites the charge in a somewhat similar manner to the hot ball, with this exception, in some cases, the hot tube is put into and out of communication with the working cylinder by means of a sliding or rotating valve. The latter amplification of this indirect method did much to regulate and improve the method as a whole. It had, however, a number of fundamental drawbacks, which no improvements could eliminate, and it languished. Obstacles to its success were:

(1) It will cause premature ignition when the heated portion is too near the cylinder, and the rest of the tube is clogged with burned or exhaust gas.

(2) It will cause misfiring when it becomes filled with burned

gas, which prevents the fresh fuel in the cylinder coming into contact with the incandescent walls.

(3) It may cause difficulty and possibly misfiring when the wind catches the flame and deflects it from the tube, which then becomes cold and unable to fire the charge.

(4) It may cause trouble through the derangement of or accident to parts of it, as cracked tubes, loose or faulty burners, or deficient fuel supply to the burner.

As against all these sources of trouble, the advantages were not numerous enough nor strong enough to save the day.

Self-Ignition by the Heat of Compression.—A secondary method of firing the charge has some of the features of the mechanical way, but in this the fuel is not admitted in the ordinary manner. It is sprayed in at the close of the compression stroke, this acting to compress air only. The act of reducing the volume of the air to a very small quantity increases its temperature to a very high figure. So when the fuel enters, in the form of a spray, it is instantly ignited by the highly heated air and burns rather than explodes.

TABLE I.—Variation of Volume and Temperature with Compression.

Gauge Pressure.	Volume.	Temperature.
0	1.000	60
2	.910	80.4
5	.810	106
10	.690	145
20	.543	207
30	.454	252
40	.393	302
50	.350	339
75	.276	420
100	.232	485
115	.213	518
130	.197	559
145	.184	580
160	.172	607
175	.163	632
200	.149	672

This method is not in general use, in fact, it is confined to a single maker, although of late some interest has been aroused in the subject of fuel injection, which carries with it the other

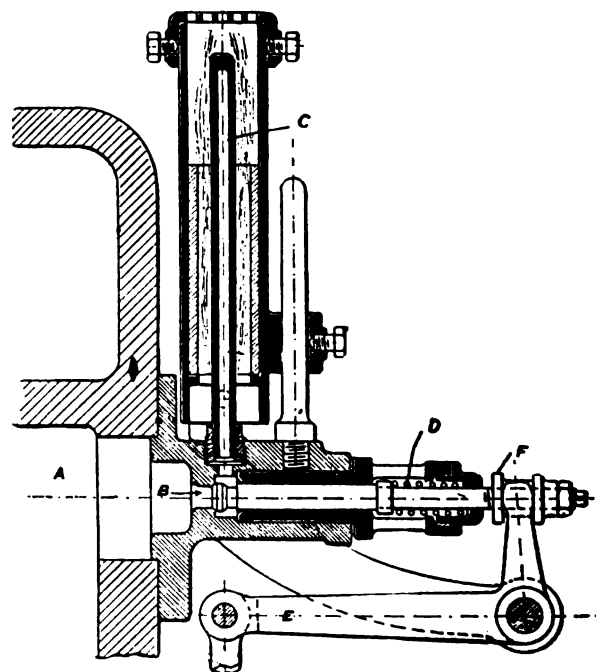

Hot Tube with Mechanical Timing Valve.

matter of self-ignition. The great simplification which it allows will doubtless bring it into favor before long, despite the constructive difficulties.

So, too, catalytic ignition comes really in the same class as the hot-tube method, the main difference being that the heat of compression heats the spongy platinum, which in turn, by catalytic action fires the charge. Like the hot tube, it cannot be closely controlled, but, on the other hand, it has no parts to get out of order and cause trouble.

Electric Ignition Much More General.—All of which leads up to electric ignition, the form in general use, one might almost say in exclusive use, to-day. As with each of the other forms previously mentioned, this type is subject to several subdivisions. The first is into:

(a) Primary electric ignition, and (b) secondary electric ignition.

In the common parlance, these are called low tension and high tension, the former being given the additional name of the make-and-break system, while the latter is more often called the jump-spark system. The latter is, moreover, subdivided again according to the source of current, although for sparking purposes, all sources are alike. These are:

- (a-1) Dry cells.
- (a-2) Storage batteries.
- (a-3) Magnetos or generators.
- (a-4) Small dynamos and all other sources of current.

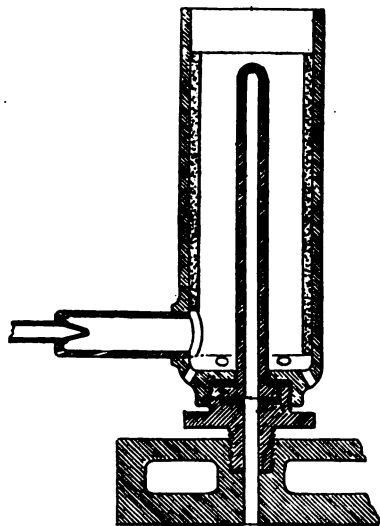

Porcelain Lining Has a Long Life.

The first, or dry cells, are very generally used on moderate and low-priced cars. They are simple in construction, comparatively simple in operation, and their action is easy to understand. Each cell is composed of three elements: The carbon, the zinc, and the electrolyte. The carbon usually takes the form of a round stick placed in the center of a cylindrical vessel made of zinc in sheet form. The space between the carbon and the zinc is filled with the electrolyte, generally a solution of sal-ammoniac, which is poured in on crushed coke. The top is closed or rather sealed with pitch to prevent the loss or evaporation of the liquid. Through this, project the ends of the carbon and the zinc, these being formed into binding posts for holding the wires. As this holding of the wires must be an intimate relation, the usual form is a threaded shank upon which a pair of nuts are mounted. Between these the wire to be connected is crushed or compressed by the moving together of the nuts.

The two poles or binding posts are called the positive and the negative, and are indicated by the + sign for the former and the - sign for the other. Carbon being the positive element, the + sign attaches to it. Now, the act of connecting these terminals together so as to allow a flow of current allows of two different methods of procedure, a right and a wrong way, it is true, but that was not what was meant.

The Two Forms of Battery Connections.—The idea intended was that by varying the mode of connecting the terminals, in one or the other of two ways, the output of the cells may be increased. These two ways are called series connection and multiple or parallel connection. To connect dry batteries in series, the terminals are joined alternately, that is, the zinc of the first is connected to the carbon of the second, the zinc of the second to the carbon of the third, etc.

When so joined, the positive element is left free at one end, and forms the positive terminal of the group, which is then

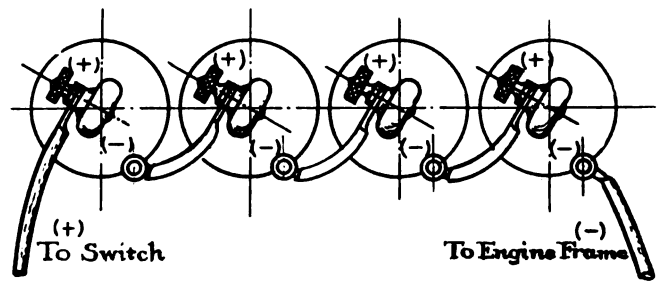

The Ordinary Battery Connection, In Series.

considered as a unit. Similarly, the other free end, the negative, forms the negative terminal of the unit. In this method of connection, the resulting current is the sum of the voltage of all of the cells comprising the group, or expressed otherwise, is the product of the voltage of a single cell times the number of cells. The figure shows how four ordinary small dry batteries are connected in series, which is the ordinary connection.

The other form of connection, the parallel or multiple, differs from the one just given in that the similar terminals are joined together, that is, all of the positives are on one wire. Likewise, all of the negatives are on the other wire. This mode of wiring up the cells gives a smaller output for the group. Thus if the individual batteries have an internal resistance which is low in comparison with the external resistance, the total output will be but slightly more than that of a single cell. If, on the other hand, the internal resistance is high relative to the external, the current will be roughly proportional to the number of cells.

The former is the case so much more than the latter, that it has come to be regarded as a truism that the current from a parallel connection is that of a single cell. A diagram is shown of a set of four dry batteries connected in multiple.

Where the cells are divided into sets or groups of a small number (four is usual), and more than one of these sets are used at a time, there are again two methods of joining them. These two are the same as before, viz., series and multiple. The former is very seldom used, if ever, but the other is rather common. When two or more sets of batteries, themselves connected in series are, as sets, joined in multiple, the whole is spoken of as connected in series-multiple.

The output from the composite group of many cells is no greater than from any one of the series-connected sets composing it. Usually the voltage of a dry cell is 1.1-1.4 volts. In multiple, four cells will still give 1.1-1.4 volts, but in series, the same four will produce $4 \times 1.1-1.4 = 5$ volts. In series-multiple, on the other hand, two, three or more sets of cells of four each will still give but 5 volts. Where then does the advantage of this connection come in, if there is any?

Multiple Series Advantages.—There are a number of advantages of this method, their weight being sufficient to more than overbalance the extra first cost, increased number of connections, and other so-called advantages of the use of the smaller number of batteries connected up in series, so as to produce an equivalent voltage output.

First, there is the greater length of life of the individual cells. To obviate the greater cost (say with twice as many cells it is just twice), the service must last at least twice as long. In fact, it does even better than this. Where four in series lasted but 20 hours, two sets of four each in multiple series lasted 70 hours, which is more than three times as much.

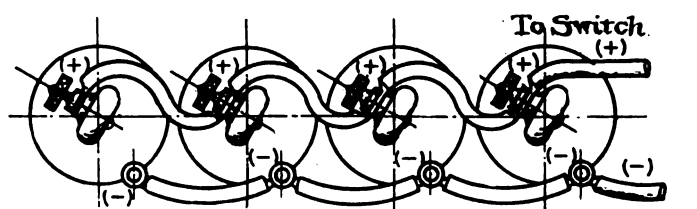

Parallel Connections are Not as Frequently Used.

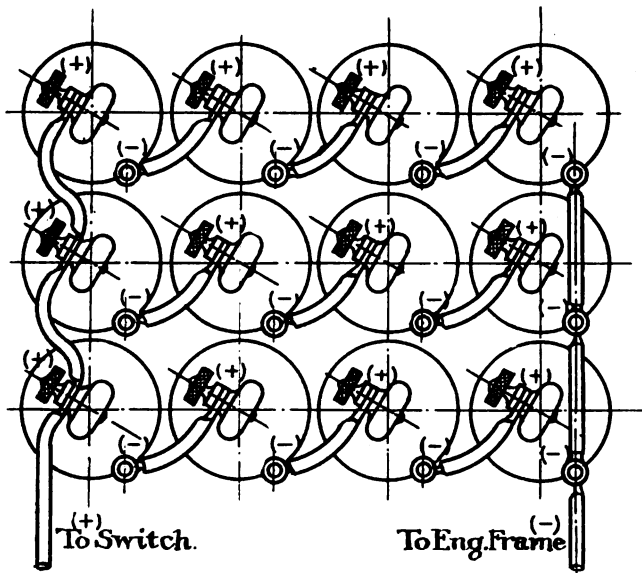

Three Sets of Cells Connected in Series Multiple.

Second, the cost per hour, mile, or on any unit basis decreases with the number of sets combined in the series-multiple arrangement, for the reason that the working life is greater. If batteries cost the same each, and a connection of eight, in sets of fours, gives a life of three and a half that of the four used alone, it is at once apparent that the cost of service per unit, whatever that unit may be, is reduced to two times one over three and a half, or $4/7$.

Third, in common with the two economies of current and consequent cost, as mentioned above, the life of dry cells being carried out to such a great extent, the driver's worry about the state or condition of his ignition current is reduced to a minimum. Given a sufficient number of cells connected in this

manner, it is possible to go through an ordinary season's running without giving the batteries a thought.

The fundamental difference between the dry cell and the wet or storage battery is that one is reversible while the other is not. Although both are chemical actions, that of the dry battery only works in one direction, so that the cell can only give out current until exhausted, after which it must be thrown away and new cells purchased. This is the point which makes the question of the life of dry batteries so important.

In the case of storage batteries, on the other hand, the matter of length of life is not of such grave importance, because the chemical action is a reversible one. So, when the cell has become exhausted and current no longer passes, it is possible to send a current through it, when the reverse action takes place and builds up the drained plates to a point where they are again self-sufficient and able to give off current.

Storage Cells Are More Popular.—For some strange reason, the storage, or, as it is sometimes called, the secondary battery, is more popular than is the very simple dry cell.

The ordinary storage battery is made with lead plates. These may be of two or three kinds, all of which are in daily use. The amalgamated plate has the surface of the lead coated with mercury, which then unites with the lead in such a way that any impurities present in the lead itself are covered while the lead united with the mercury in the form of amalgam is continually presented. The surface presented to the electrolyte is thus always that of pure material, and consequently the chemical action is sustained with equal force right down to the limit of the amount of metal in the plate.

Then there is the pasted plate, so-called because the surface presented to the fluid is composed of material in the form of paste, which has been added to the skeleton form of the grid. This paste is of two kinds, yellow oxide of lead, known as litharge, which is pasted to the negative plates, and red oxide of lead, called minimum, pasted to the positive plate. The shape of the grid to which the paste is added, varies greatly.

BORNE IN THESE DAYS WITH AUTO'S RISING TIDE

New Design for an Auto Funeral Car.—An adaptation of an automobile into a funeral car with new features has been patented by J. W. Butler, F. R. Briggs and E. G. Clarke, of Cleveland. In appearance it is unlike that of the usual funeral conveyance, differing only in size from the lines of a standard limousine, but large enough to displace the hearse and five carriages. On the way to a cemetery it is divided into two compartments by a partition, and in inclement weather this may be collapsed and the coach used as a chapel in which to conduct the service at the grave. The inventors have formed the Auto Funeral Car Company, Inc., and will shortly begin the production of the cars.

Dairymen and the Automobile.—At the recent convention in Chicago of dairymen from five States a remarkable situation in respect to the use of automobiles was revealed. Of those attending, 112 were asked as to the use and value of autos to them. It appeared that 38 owned autos, and 11 had more than one machine, mostly used to transport products, but several so equipped that they can operate separators, churns, etc. One runs a bottle washer and another pumps water to flush the dairy barn. Reports showed a steadily increasing interest in automobiles and good roads.

Voters Carried Wholesale to the Polls.—Automobiles have been valued adjuncts to political parties on election days in many parts of the country, the latest section to use them extensively being South Orange, N. J. At the recent election of the Board of Village Trustees 200 cars were pressed into service, and by means of them not a single voter was allowed to go to his place of business until he had cast a ballot.

Combines Duties of Clergyman and Auto Agent.—Rev. Harrison F. Miller, a bookbinder by trade, who resigned from the pastorate of the Chardon, Ohio, Disciple Church recently, has taken the agency for an automobile in that town, and intends to interweave his multitudinous callings. Mr. Miller states that he will not abandon the performance of his ministerial duties, and that in his mercenary pursuits with his touring cars he will be able to have a wider range of influence as a clergyman than ever before.

London Autos with Consciences.—To prevent undue speeding the police of London are contemplating a novel method of procedure, whereby the automobiles will loudly proclaim their movements. Taxicabs and omnibuses may be fitted with whistles, sealed so that they cannot be tampered with, which will be set to give a continuous warning as long as the machines travel at above a certain rate of speed. Thus the conscience of the driver will have more than moral support from his conveyance.

Noted Whip Sells Horses and Buys Autos.—Because automobiles are so numerous that he finds it uncomfortable to drive horses, former Mayor Welling G. Sickel, of Trenton, N. J., one of the most noted whips in the State, has sold his entire string of thoroughbreds, riding, and tally-ho horses. Of course his stables will be turned into a garage.

Trades Auto for House and Lot.—From Salisbury, N. C., comes the latest report of a novel exchange to secure an automobile. Robert Lowder, of Albemarle, wanted a touring car, and J. D. Kennerly, of Salisbury, wanted a house and lot, so the latter gave his \$3,000 touring car to the former in exchange.

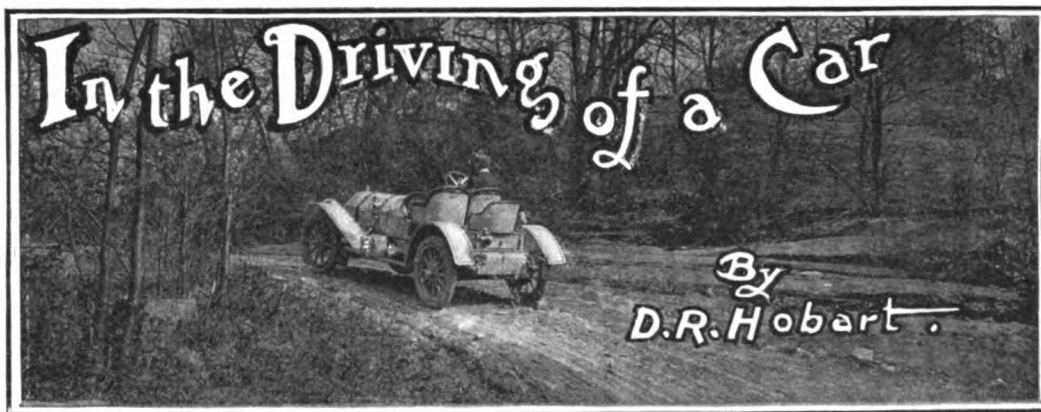

PRONOUNCEDLY prominent are two faults among those possessed by automobilists, and to these must be credited the majority of accidents for which the driver of the car is responsible. The first is that of overconfidence, the average driver considering himself a finished performer as soon as he is able to steer a car with any degree of certainty, and to vary his speed as desired without injuring the machine. As a matter of fact, he is just beginning to qualify as a driver at this stage of the game, as it is only then that he can really give his attention to the road and the conditions of traffic. It is at this stage that the greatest risks are taken, through ignorance in most cases, and even with the knowledge that the chances are greatly against him the overconfident autoist will fly past cross-roads and dodge in between moving trolley cars on slippery rails "on the chance." It has been said that a good scare is the best instructor in wisdom in driving locomotives, and this is true also with regard to automobiles. Once an autoist has run into some other vehicle or been forced to take the ditch to avoid being smashed by a train, he will be more careful about making turns and negotiating railroad crossings in the future. However, the knowledge of driving need not be so acquired, but can be gotten by experience on the road and by avoiding unnecessary risks at all times.

The Fault of "Showy" Driving.—The second fault is that of "showy" driving. A large number of autoists commit this error in taking corners at high speed on two wheels, cutting in in front of another car for the sake of taking a turn ahead of it, coming up to the stopping point at speed and setting the brakes on hard, and similar performances, imagining that such driving shows their skill and causes them to be greatly admired or envied. As a matter of fact, they are not envied nor admired, except, perhaps, for their luck in escaping destruction, but disliked for their lack of consideration for others and because of the danger which they constitute to all road users. Like the overconfident autoist, the showy driver takes crossings at speed, but does so with the full knowledge of what may happen, and is proud of the fact. That driving of this kind is unsafe is shown by the hospital reports, and that it is costly, by the size of the repair and tire bills. A few more plaudits are gained, but when the year's account is footed up the hurrahs come high.

The Question of Speed.—How fast one can travel with safety is a question that each must find out for himself. There are autoists who can drive safely and carefully at the highest speed at which the car can keep on the road, and others who cannot drive five miles an hour with safety. If an autoist is in doubt as to his own maximum safe speed, he would do well to figure it at the limit set down by the laws of the State in which he resides. As this limit is calculated for the majority of autoists in the State, the autoist can be satisfied that it is safe for him to travel at the legal speed, and by not exceeding it, he will be exempt from arrest for fast driving.

An excellent reason for not driving at speed is the discomfort experienced by the passengers on the rear seats, who are bounced about at every inequality of the road, even on cars with long wheelbases. If any autoist should doubt this, let him occupy one of the seats in the tonneau of a fast-driven automobile for sev-

eral hours and he will be thoroughly convinced. Another reason is the heavy strains to which the machine is subjected at speed tend to shorten its useful life and bring it to the repair shop sooner than necessary.

General Principles to Follow.—When on the open road, away from cities or towns, the following rule should be borne in mind: Drive with moderate speed on the level, slow speed down hill and wide-open throttle for hill climbing or getting up speed only. The condition of the road should be noted, the presence of mud or dust thereon furnishing a sufficient reason for slowing down somewhat for the sake of other road users, and grease, roughness or excessive camber for the sake of the car and its occupants. The ordinary rules of the road regarding the negotiation of turns and crossings and the overtaking or passing of other vehicles should be adhered to even though a lower rate of speed is involved. A sharp lookout should always be kept for traffic of all kinds as well as on approaching schools, churches or public buildings and also for road signs indicating danger, caution, etc. When on the road the autoist should show the same courtesy to other road users as he would if he met them on a city street. Courtesy is much appreciated in autoists and goes a long way toward removing the prejudice against automobiles which exists in many places at present.

Brakes and Their Proper Use.—Next to the motive power in importance come the brakes. There are a number of things that every autoist should know and remember about them, and the first and most important is that brakes vary in their effectiveness from time to time and that the difference between safety and disaster depends on their being kept in good condition and properly adjusted. Another and scarcely less important point is that while a brake may be perfectly satisfactory for slowing down, it by no means follows that it will bring a car to a standstill satisfactorily, nor hold the car from going backward. There is a great temptation to neglect the brakes, both before starting out and when they need setting up on the road, and it is most important that the brakes are tested before starting, and if any adjustment is needed while on the road it should be made at once. The brakes should be tested with the car in motion, the pedal or hand lever being applied until the car slows down and stops. The distance traversed in making this test should be noted and a greater distance allowed in making stops on the road. In applying brakes, the application should be gradual, reducing the speed of the car as quickly as possible, but not locking the wheels. As long as the tires retain their grip on the road, the powerful retarding action of the brakes on the car continues, but when the wheels are locked the brakes have little or no effect and the car will either slide along or skid, in either case being out of control of the driver. If the wheels become locked while descending a hill the brakes should be released until the wheels are again revolving and then reapplied gradually, when they will act satisfactorily.

Proper Procedure in Gear Changing.—In changing gears the autoist should endeavor to have the motor and car moving at nearly corresponding rates of speed before the clutch is engaged. With the planetary type of gear changing is simple, and

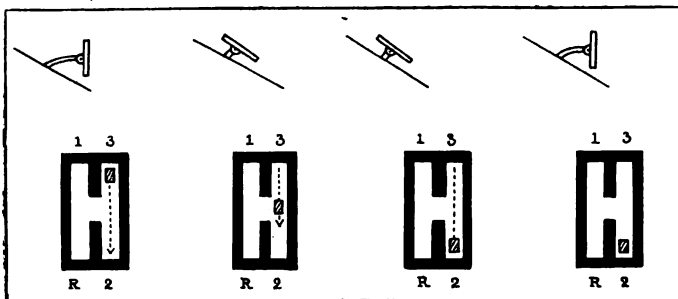

Changing Down from Third to Second Speed.

drivers usually guess at the proper period at which to make the change, any mistake in estimating the rates of the car and motor being of little consequence, as the bands will slip instead of transmitting the shock to the gear. A similar action occurs in the case of individual clutch or friction gears, but with the sliding type severe strains and shocks have to be taken up by the clutch and are usually transmitted in part to the gear if the clutch is not slipped. What applies to the sliding type in general applies to the other types as well.

Changing from a Lower to a Higher Gear.—In changing from a lower to a higher gear it will be necessary to speed up the motor by means of the throttle or accelerator in order to store enough energy in the flywheel to furnish the work needed to accelerate the car to its new speed. As the speed of the car increases the higher gear should be engaged, the autoist not being in too great a hurry to make the change. The movement of the change gear lever should be made quickly in order that the car does not lose way. When changing from a higher to a lower gear the change should be made as quickly as possible before the car has time to slow down. When climbing a steep hill it should be ascended as far as possible on the high gear by proper use of the throttle and spark, and the change down to the lower gear made as soon as the motor begins to labor or is in danger of stopping. The presence of an unusual number of passengers in the car will affect its ability to negotiate grades which ordinarily are taken on the high gear, and the autoist should remember this and not attempt to force the car to travel on that gear with the increased load, but resort to a lower gear.

Changing with Selective Gearing.—Of the two chief varieties of sliding gear the selective is in most common use. The most familiar form employs a sort of grid with communication between the two slots through a gate or passage cut in the bar at right angles to the slots. A lever works backward or forward in either of these slots and can be shifted from one to the other through the communicating gate. The ends of the slots represent the positions of the lever when certain gears are engaged, and in the illustration the lever is seen with the third or high gear in mesh. For changing from third to second gear the procedure is shown graphically. The first position is with the clutch engaged and the gear lever in third gear position, the clutch being shown above the grid. The second position shows the clutch disengaged and the lever being moved toward the second gear position marked 2 on the grid. The third shows the lever in second gear position and the fourth, the final step in the change, the clutch again engaged. The procedure is the same in the case of a progressive sliding gear.

Changing from Second to First Gear.—The second figure shows the change from second to first gear on the same grid. The upper line of figures shows the movement of the clutch pedal and the central line the corresponding movement of the accelerator or throttle. The first position shows the clutch in and the throttle open ready for the change. The second shows the clutch withdrawn and the lever moved along the slot until opposite the gate. The third shows the lever being moved through the gate and along the other slot toward the first gear position, this sideways and forward movement being combined in one continuous movement. The motor having speeded up as soon as the clutch is released, it is necessary to reduce its speed

somewhat before engaging the second gear, so the accelerator is shown partially released in this position. The gear is then engaged, the clutch let in and the accelerator again depressed, which is the situation shown in the fourth position. A change from first to second is made in the reverse order, except that the accelerator pedal is not released unless it is necessary.

Use of the Spark.—Upon the proper use of the sparking device depends the economy of the motor, and in many cases the safety of the driver. On some cars the sparking point on the magneto is fixed, and the autoist controls the car by the throttle only. There are a number of cars in use which employ the battery in connection with separate coils or a single spark system, or a magneto on which the spark can be regulated by the driver. When starting, the spark should be retarded in the case of battery ignition to prevent backfiring, and slightly advanced to a certain point, depending on the motor and magneto, in the case of magneto ignition. When it is desired to slow the motor down below the point obtained by throttling only, the spark is likewise retarded. In ordinary running, a position of the spark lever can be found which will give fair average results through a considerable range of speed without changing its position, and this position varies with each motor and can be found by experience. When a higher rate of speed is desired, the throttle is opened and the spark advanced gradually. If a grade is to be negotiated it should be "rushed" if possible, the throttle being opened full and the spark well advanced until the motor begins to slow down and "knock," when the spark should be retarded to correct this. The autoist should always keep the spark as far advanced as possible, without causing the motor to knock. When accelerating or retarding the spark should follow the throttle, the latter always being operated first.

Driving at a Constant Speed.—One of the best lessons in the proper method of driving a car is that of driving at a constant speed, no matter what the road conditions. The autoist should previously determine a speed compatible with the nature of all roads over which the car is to pass, and should see that the speedometer hand keeps at the determined speed throughout, regulating the spark and throttle and changing gears if necessary. Considerably more will be learned about the flexibility and power of the motor in driving in this way for a few times in numerous drives in the ordinary way.

Reversing Is Usually Neglected.—Among other things connected with driving which is apt to be neglected is reversing or driving a car backward. Usually a car is never reversed for more than a few yards at a time and the maneuvering involved requires no great skill. Steering a car when running backwards is diametrically opposite to that when running forward. A turn of the wheel to the left steers the car in the opposite direction to the right, and vice versa. The usual mistake made in reversing is in turning the steering wheel too far and describing zig-zags in the road as a result. The autoist should remember that the reverse gear of a sliding change gear should never be engaged until the car has been brought to a full stop.

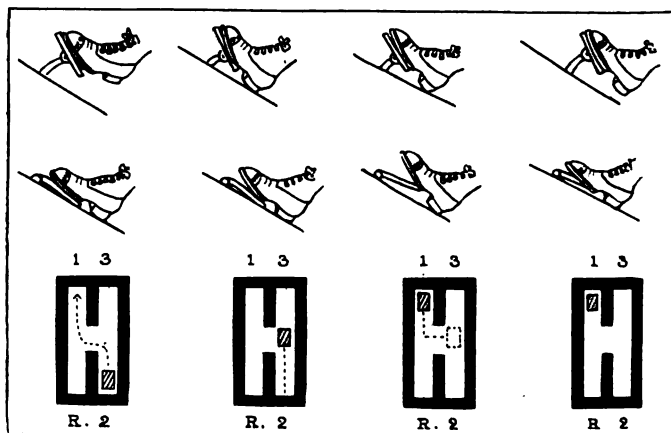

Changing Down from Second to First Speed.

Pointers on the Care of Vehicle Batteries

By Howard Greene

AT least once a week the battery cells should be flushed. That is, clean cold water should be added, if necessary to bring the electrolyte, as the liquid is called, half an inch above the tops of the plates. This should be done before charging, so that water will become thoroughly mixed with the electrolyte. If it is found that an individual cell repeatedly requires considerably more flushing than the others, look carefully for the reason. There may be a slow leak in the jar, in which case there will probably be a wet spot under the cell. Some internal trouble may cause the cell to heat and the water to evaporate more rapidly than from the other cells. In case of a leak, the continued addition of water will bring down the gravity of the sulphuric acid, or whatever liquid is used, and in case of internal heating, the temperature of the cell will give the necessary warning. In either case, the cell should come out and go to the expert.

Care to be Used or Destruction Results.—To continue using a cell that heats, or one that leaks, is to invite the destruction of that cell and delay on the road. This is a continuous performance, that is, the hotter the cell becomes, the more rapid the evaporation, and the lower the level of the electrolyte will fall; the lower the electrolyte falls in the cell, the hotter it will get. The electrolyte soon falls so low that current cannot be forced through, and the vehicle will be brought to a stop. When this occurs, the cell will be found steaming hot, the plates in a sad condition, the separators destroyed and very likely the jar cracked from the heat. A cell that has gone through this experience can be made useful again only by a long course of tender nursing, or it may be completely ruined.

If a jar springs a leak and it is not possible to replace it with a new one for some time, cut the connections to the adjoining cells with a "plumber's saw" and lift the elements from the jar, putting them, if possible, into a vessel of electrolyte or, at least, into clean cold water. Leave the old jar in place as a space filler, or else fill in with a wooden form of the right size and shape. Connect across the space by burning in a lead strap or, if this cannot be done, by a heavy copper wire secured to the strap ends with brass screws and washers. Lose no time in having repairs made. Have the cell fully charged before cutting it out. If the elements are placed in electrolyte, put the fluid in a glass, wood or hard rubber vessel, as the acid has a vigorous corrosive action on metals other than lead. In any case, make sure that there is no metallic connection between the plates.

Beware of Loose Connections.—A loose or imperfect connection anywhere about the battery is apt to cause trouble which may become serious. The resistance established thereby to the passage of the current causes the loss of just so much energy, and, furthermore, the overcoming of the resistance is accompanied by heat. If the resistance is sufficient, the heat may become so great as to cause the fusion of the conductor at the faulty contact. The heating power of the current, from even a moderate sized vehicle battery, is surprising to one unfamiliar with such matters. A film of oil, between surfaces that should be in contact, can do damage very quickly. The heat carbonizes the oil and the carbon grows extremely hot until finally the metal melts when a heavy current passes. Consequently, one should see that all separable connections are kept clean and bright at the contact surfaces.

Look Out for Local Short Circuits.—If a strap breaks while the battery is delivering a heavy current, it is possible that there may be fusion of the lead at the point of fracture, and that particles of the loose metal may fall into the bottom of

the cell and cause local short-circuiting and heating. This possibility should be taken into consideration if a cell which previously gave no trouble shows a tendency to heat after a broken connecting strap has been re-burned. It is also possible that a careless burner may have allowed lead scrapings or particles of molten lead to fall among the plates, with the same result. Such carelessness is, of course, inexcusable.

A very low temperature—below freezing—will reduce the capacity of the battery and also its voltage, although both will recover as the temperature rises and there will be no permanent damage. The battery should be kept, when not on the road, in a place where the temperature does not fall very low. The temperature at which a battery works best is about the same as that most comfortable for the driver.

In course of time the active material in the plates becomes disintegrated and falls to the bottom of the jars. If allowed to continue long enough, the deposited paste or free metal would reach the bottom edges of the plates, which are sometimes supported on ribs rising from the floors of the jars on purpose to keep them clear of this sediment. When there is only a quarter of an inch between the top of sediment and the bottom of plates, the jars must be cleaned. In order to ascertain when it will be necessary to clean a battery, one pair of straps is disconnected and the plates lifted out of the jar, permitting the depth of the deposit to be measured, after the battery has been charged, say, 50 times, or has worked 50 days. Suppose the ribs are $1\frac{1}{4}$ inches and there is sediment of half an inch.

Rate of Deposition Indicates Time for Cleaning.—Clearly at the same rate the sediment would be $1\frac{1}{2}$ inches deep, or within a quarter of an inch of the plates, after 100 more charges; but, as the plates grow older the rate increases, and it is usual to allow for a 20 per cent. increase. This would make it necessary to clean the battery after a total of 120 charges—50 before examination of the single cell and 70 after ward. The cleaning should be done by an expert, who will at the same time examine the whole battery carefully and take the opportunity to do whatever other work is necessary.

Every precaution should be taken to prevent dust, dirt or foreign matter of any kind from getting into the cells. When in place in the vehicle the battery should be thoroughly protected from rain and snow, or there will be, perhaps, a weakening of the electrolyte that will be difficult to account for. Keep the exterior of the battery as clean and dry as possible, and the trouble will be well repaid.

Electrolyte will burn its way rapidly through cloth, and one may as well say farewell to any clothes used when working steadily about batteries. If acid is splashed on clothes that are wanted for further use, put ammonia, sal soda and water—or, if these are not at hand, plenty of clean cold water—on the places and disaster will be averted. Acid will make the skin of the hands dry and harsh; the remedy is to wash them in glycerine in the evening. If the acid gets into a cut or scratch, it will instantly make its presence felt by the sharp stinging that will follow. Cold water will stop this at once.

In conclusion, it may be emphasized that it is not worth while, even from the point of view of a lazy man, to postpone giving to a battery the attention it requires. The trouble will wait, and very likely will improve the time by multiplying itself, so that an hour saved this week may stretch out until it becomes a day's work next time. The effect on the owner's pocket may be even more marked, for time is money, and money spent for repairs, that could just as well have been avoided without expense, makes a great deal of noise sometimes.

The Flywheel as a Gyroscope

By Henry M. Russell, Jr.

NUMEROUS opinions have been expressed from time to time on the gyroscopic action of the fly-wheel of an automobile and various advantages are claimed for certain cars in which the fly-wheel is placed in an unusual position. In claiming these advantages, comparison is made with the Schlick gyroscope to prevent rolling in vessels and the Brennen mono-rail car. In these comparisons the fact has apparently been lost sight of that the conditions upon which the operation of the last named devices

depend do not exist in an ordinary automobile.

If we attempt to rotate the axis of a rotating fly-wheel in one plane, the axis will tend to rotate in another plane at right angles to the first. If the axis is free to rotate in the second plane it will do so and the force applied will be expended in producing this rotation, and no rotation will be produced in the first plane. If the axis is not

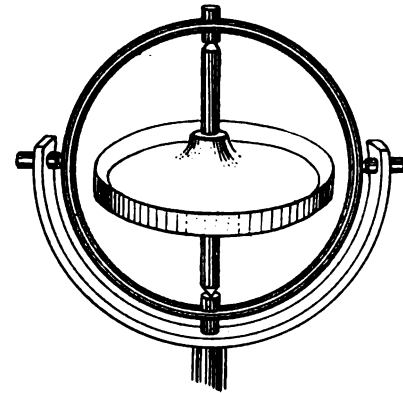

The Gyroscope Top Is Well Known.

free to rotate in the second plane, then the effect will be to rotate the axis in the first plane, precisely as if the flywheel were not spinning about the axis except for resistance due to friction.

These are the laws of the gyroscope, the common impression to the contrary notwithstanding. For example, if a fly-wheel is spinning about a horizontal axis and we attempt to raise one end of the axis, it will tend to rotate in a horizontal plane, the direction of the rotation depending upon which way the fly-wheel is spinning about its axis. If it is free to rotate in the horizontal plane, the apparent effect will be resistance to the force applied. If it is not free to rotate in a horizontal plane then we shall be able to raise the end of the axis exactly as if the fly-wheel were at rest, except for friction in the bearings. As the forces are large this friction may be considerable and it has undoubtedly led many experimentors who neglected this point to erroneous conclusions.

No Gyroscopic Effect with Common Position.—With the fly-wheel as commonly placed there can of course be no gyroscopic effect which would tend to turn the car over sideways since the bearings will not transmit any force in this direction. The only possible effects are that if the front wheels be raised by an obstruction the car will tend to change its course to one side or the other, depending on the direction of the rotation of the fly-wheel. This effect is probably negligible. Conversely, when a car rounds a curve the gyroscopic action will tend to lift or depress the front wheels according as the curve is right or left handed. This effect is probably small but may help sometimes in making a car skid by lessening the pressure on the front wheels.

Turning now to the cars in which a fly-wheel placed horizontally and revolving about a vertical axis is supposed to prevent the car from over-turning sideways, we find that the conditions are fundamentally different from those of the Schlick and Brennen applications of the gyroscope. In these applications both in the boat and the train the rotating wheel is so hung that its axis can turn in a fore and aft plane independently

of the rest of the vehicle. It is upon this that their action depends, and in its absence there will be no gyroscope effect.

Herr Schlick in one of his papers expressly states that if the axis were fixed with respect to the hull of the vessel, the only effect would be to lengthen the period of rolling without decreasing the amplitude. This may be shown from theoretical considerations, but was proved experimentally on Schlick's boat. The axis is and must be fixed with respect to the frame of an automobile because of the necessity of transmitting the power to the wheels. The only effect therefore of the gyroscopic action would be to lengthen the period of rolling and not to prevent the car from upsetting.

Action of the Gyroscope of a Curve.—In turning a curve in one direction the pressure on the front wheels would be increased and in the other directions it would be diminished, depending on the direction of the rotation of the fly-wheel. The converse of this would also be true, that is, if we lift the front wheels the gyroscopic force produced will tend to turn the car over sideways; now it might very well happen that the front wheels would meet an obstruction while the car was rounding a curve and if the curve happened to be in the right direction the gyroscopic force would be added to the centrifugal force due to the curve and would actually increase the liability to upset the car on turning the curve.

Since these conditions would undoubtedly occur sometimes it may be said that the placing of a fly-wheel horizontally instead of decreasing the danger of upsetting sideways would increase the danger of such an accident eventually happening. The writer does not know whether the forces developed at ordinary speeds would be great enough to make any particular difference but the makers of the horizontal fly-wheel cars evidently believe that the forces are worth taking into account, so we may assume this in our discussion of the question.

It would of course be possible to mount the motor and its fly-wheel so that they could swing in a longitudinal plane as Schlick and Brennen do, and then of course the effect would be

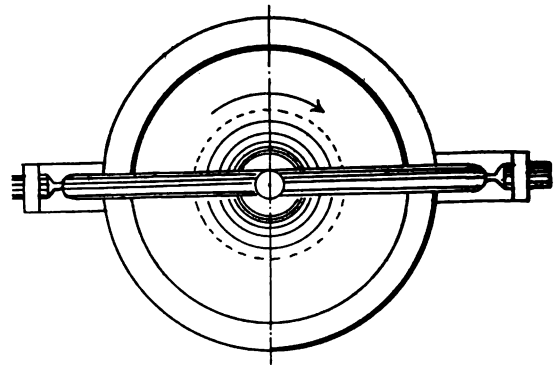

Top View of the Gyroscope, Showing Rotary Action.

to prevent upsetting and we would even be able to run on two wheels. The writer believes that such a car has been built as an experiment, but none of the cars on the American market have, so far as he knows, adopted this plan and, as at present constructed, the horizontal fly-wheel increases instead of decreases the chance of the cars sometime upsetting when rounding a curve. Interested readers are referred also to the Jan. 16 and Feb. 20 issues, *The Automobile* for 1908.

Letters Interesting and Instructive

AUTO SIGNALING CODE.

Editor THE AUTOMOBILE:

[1,882.]—Having read the article in "The Automobile" of March 18 on the use of the horn or gong for a signal code (No. 1,795), I am pleased to say that the signal code which I will describe herein has been used by me for the past several years, and is the combination of lumbermen's and steamers' signals with no variations, and with the addition of using train signals.

- | | |
|---|--|
| (1) When running ahead and going to make port, or to stop, | One long and one short blast of horn, to be sounded not less than 30 yards from point of stopping. |
| (2) When coming to a standstill, or have made port, | One short blast. |
| (3) Going to start ahead, or leave port, | One short blast. |
| (4) When standing still and going to back up, | Two short blasts. |
| (5) Starting ahead slow on bad roads, slippery or muddy, | Three short blasts |
| (6) Going to turn to left at road crossing, to be sounded before starting to turn, | Four short blasts. |
| (7) Going to turn to right at road crossing, | Two short and one long blast. |
| (8) In passing a slower car on port side (left), | One long blast. |
| (9) In passing when abreast on port side, | One long and one short blast. |
| (10) When crossing in intersecting roads, signal must be blown at least 20 yards distant from crossing. | Two long and two short blasts. |
| (11) Coming to forks of road, if any, cars, teams, vehicles coming in opposition use marine signal code; will turn to left; always keep on right side of roadway. | (Port) One long blast.
(Starboard) Two long blasts. |
| (12) Calling for assistance, if stalled on the road. | Five long blasts. |

In saluting other machines and occupants courtesy must be respectfully paid by proper use of horn. Any amount of noise will not do, as it would be confusing to other autolists. Several quick sharp blasts of horn will do. Blowing of horn unnecessarily is deemed inadvisable by the best autolists.

I have not seen any signals in a comprehensive form printed yet, and if these signals have been printed before in any magazine, I have not come across them.

Since 1903 I have been reading your magazine, "The Automobile," and several others, not being a regular subscriber, as I travel on the continent quite a bit, but now I will be at the Seattle A. Y. P. E. for the season of 1909, and I buy "The Automobile" at newsstands generally.

Hoping that the signals as used are easily understood by anyone.

COUNT JOHANN VON BUTALA.

Seattle, Wash.

We give the letter and code in full above, but would make the criticism that there are three pairs of signals, which are alike, and while it would appear that there is no danger of their conflicting with each other, it would be best to have different signals for the present duplicates. So we are suggesting changing three of the above as follows:

- (3) From one short to five short.
- (9) From one long and one short to one

short and one long, a transposition.

(11) From one long to three long or possibly it would be better to leave this as it is and change

- (8) From one long to three long.

TIMING OFFSET CRANKSHAFT.

Editor THE AUTOMOBILE:

[1,883.]—Will you please tell me how to time an engine with an offset crankshaft?
A. E. MOORE.

Haverhill, Mass.

To time an engine having an offset crankshaft, the inclination of the axis of the con-

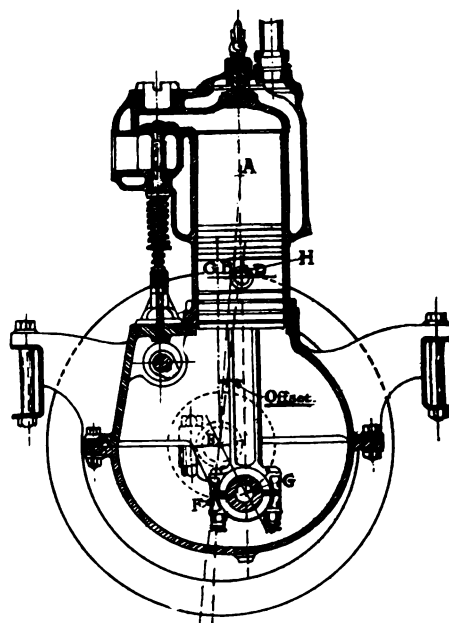

Section Through Engine with Offset Crank

necting rod must be taken into account. As the figure shows, the connecting rod is vertical, and if the shaft center were not *de saxe*, the flywheel would be marked at the exact center of the upper face, namely at C. In the case where the center is set over, the rod, when in a vertical position as at G is not at the end of its stroke. If the flywheel were marked at C it would

not indicate correctly the lower dead center. This does not appear until the three centers, piston pin, crank pin, and crankshaft are in line, as shown by the line D E F. The flywheel should be marked at this point, and the mark may be on a vertical line through the crankshaft center or on a diagonal as the line just indicated. In the latter instance, the mark for the lower center would be at H.

Similarly, the upper dead center, if marked, would be at a vertical point above the shaft center as C, but would assume a different position, located on a diagonal, as at A, on the center line A B E.

Of course in actual timing, the upper and lower centers are not used, as good practice decrees an overlap for the valve action, but they have been used as an illustration in this case because their use simplifies the matter.

In the second figure, at the bottom of the page, the actual marking of a flywheel is shown for a complete cycle. In this the angles selected follow the best modern practice, being as follows: Inlet opens at 8 degrees past the upper center, and closes at 26 past the lower center, giving an inlet opening, total, of 198 degrees. Exhaust opens at 46 degrees before the lower center and closes at 5 past the upper. This gives the whole angle for the exhaust, 231 degrees on the crankshaft.

As shown, the markings are put on the flywheel directly above the center of the crankshaft, but the offset is taken into account.

CHEMICAL RECTIFIERS.

Editor THE AUTOMOBILE:

[1,884.]—Can you inform me of the name of the chemical or chemicals used in a corrector or rectifier for transforming alternating to direct current for charging of ignition batteries? The chemical I have reference to is of a crystal form, looking somewhat like borax. If you or any of your readers can tell me this, I would very much appreciate it.
B. M. JEWETT.

Claremont, N. H.

Of course we cannot be sure of the exact chemical which you have reference to, as

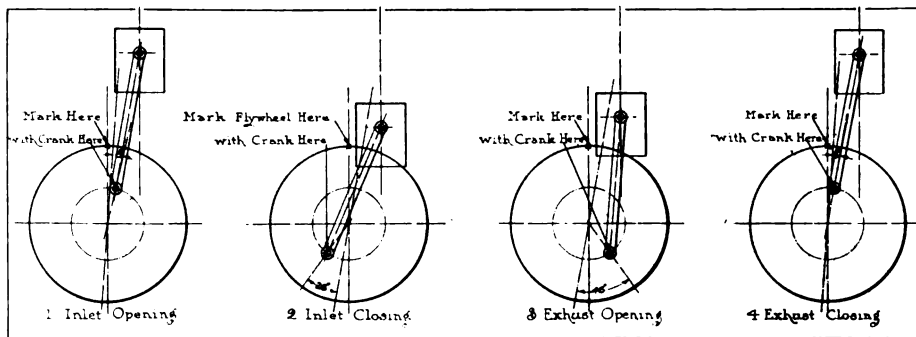

Diagrams Showing the Four Positions of the Offset Crankshaft.

a number of them are in use. Thus, if you use an aluminum-lead rectifier, the electrolyte may vary. This variation also affects the voltage of the current which may be higher with one electrolyte than with another. Dilute sulphuric acid will not allow the use of higher voltages than 20, while with potassium or sodium phosphate, as high as 200 can be handled. Ammonium phosphate raises the figure to one that allows of converting the ordinary electric light circuit of 220 volts. With a 110-volt circuit, a saturated solution of common baking soda can be utilized.

In practice, two of the aluminum-lead cells are placed in series, and there are two pairs of cells, one working with each half of the current. These are coupled in such a way that the whole current passes in the same direction through the accumulators to be charged. These cells have a very high internal resistance, and the lamp resistance ordinarily used must be passed through lamps intended for a current 20 volts below the ordinary to allow for the drop due to the internal resistance.

The mercury rectifier is more commonly used and a very complete description of one of these will be found on page 344, of THE AUTOMOBILE, issue of February 25.

HYDROMETER DESCRIPTION.

Editor THE AUTOMOBILE:

[1,885.]—In recent articles in "The Automobile" I have often seen the word hydrometer used; will you please describe this instrument and its functions?

J. M. STEELE.

Tekonsha, Mich.

The hydrometer is an instrument for measuring the specific gravity of liquids, in other words, the density. It is an instrument resembling a thermometer with a large bulb on the bottom. The latter is filled with lead, mercury, or other very heavy substance, placed in there to make the instrument sink into the liquid even when thick and heavy. In the issue of April 8, THE AUTOMOBILE, several hydrometers are shown in position in liquids which are being tested. These will show you both the instrument itself and its use.

ON A VARIETY OF SUBJECTS.

Editor THE AUTOMOBILE:

[1,886.]—Will you please answer the following questions for me:

- (1) What is the record for a bicycle, on a straightaway?
- (2) Would not a three-cylinder two-cycle engine equal a six-cylinder four-cycle, as far as the smoothness of running is concerned?
- (3) What is the difference between a low and a high-tension magneto?

L. E. HOWE.

Liberty, Ind.

(1) You do not say what record you wish, that is, the question is too broad. To get an exact answer you would have to say definitely: the distance for which you wanted the record; the kind of rider, as amateur or professional; the kind of contest in which the record was made, as handicap or open race; whether in actual competition or against time; and if the lat-

ter, whether paced or unpaced; and if paced, whether ordinary or motor pace was used.

(2) Yes, a three-cylinder, two-cycle engine would run as smoothly as a six-cylinder, four-cycle. For equal size, it would not deliver as much power, and probably would consume more fuel.

(3) The difference between the two types of magneto is that they generate two entirely different kinds of current. Thus, the true high tension magneto will produce a high-tension current, the armature windings being such as to give this result. The low-tension machine, on the other hand is designed and wound so as to give a low-tension current. Under no consideration whatever can the high-tension machine be used for purposes where low-tension current is desired or necessary. The reverse of this does not hold, in fact, a number of ignition systems employ a low-tension magneto, the current from which is intensified by means of a coil, the resultant product being a high-tension current.

The difference in the use of the two forms of current lies in the fact that with high tension, the momentary intensity of the current is such as to jump a large air gap, as in the ordinary spark plug. With the low tension current, on the other hand, this does not hold and the current must be mechanically broken.

The devices for doing this are numerous and varied, too much so for a description here.

CYLINDER THICKNESSES.

Editor THE AUTOMOBILE:

[1,887.]—Will you please give me an empirical formula for figuring the thickness of cylinder walls for gasoline engines as used in automobiles?
T. H. HEATH.
Buffalo, N. Y.

Thurston gives

$$T = aP_m d + b$$

in which T is the desired thickness, and a is a constant, for vertical cylinders the value of which is .0004, and for horizontal cylinders .0005. b is also a constant, with the value .2 for vertical and .5 for horizontal. P_m is the maximum pressure in pounds per square inch, and d is the diameter of the cylinder. Lucke gives T = .075d, and for cylinders above six inches in diameter T = .075 d + .3. Rice compiled from

$$\text{current practice, } T = \frac{pD}{5300} - \frac{1}{8} \text{ inch for}$$

light automobile practice, which takes into account the average maximum internal explosion pressure.

FINE SCREW THREADS.

Editor THE AUTOMOBILE:

[1,888.]—I notice in the April 22 issue that fine screw threads have been standardized. Will you please publish the table of these as now standard? I have been waiting for this for many years and I believe that it would be of interest to many readers.
C. V. ARMSTRONG.

Fulton, N. Y.

Although this table has been published before, we reproduce it herewith as taken from the "Automobile Trade Directory," pages 599, 600 and 602, for the benefit of Mr. Armstrong.

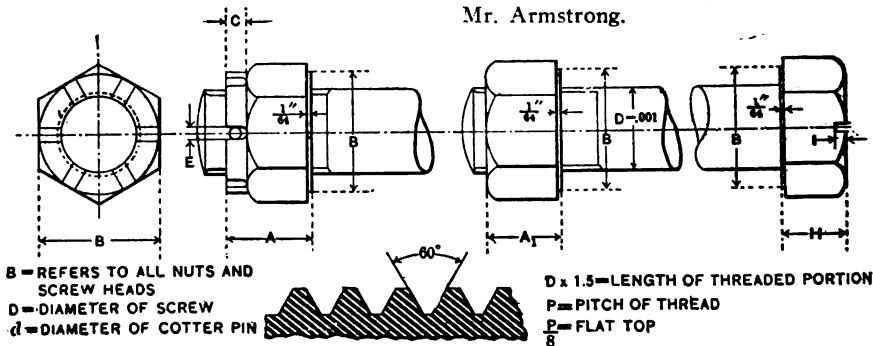

D	1/4	5/16	3/8	7/8	1	1 1/8	1 1/4	1 1/2	1 3/4	2	2 1/4
P	28	24	24	20	20	18	18	16	16	14	14
A	1/8	1/4	3/8	1/2	3/4	1	1 1/4	1 1/2	1 3/4	2	2 1/4
A ₁	1/8	1/4	3/8	1/2	3/4	1	1 1/4	1 1/2	1 3/4	2	2 1/4
B	1/4	1/2	3/4	1	1 1/4	1 1/2	1 3/4	2	2 1/4	2 1/2	2 3/4
C	1/8	1/4	1/2	3/4	1	1 1/4	1 1/2	1 3/4	2	2 1/4	2 1/2
E	1/8	1/4	1/2	3/4	1	1 1/4	1 1/2	1 3/4	2	2 1/4	2 1/2
H	1/8	1/4	1/2	3/4	1	1 1/4	1 1/2	1 3/4	2	2 1/4	2 1/2
I	1/8	1/4	1/2	3/4	1	1 1/4	1 1/2	1 3/4	2	2 1/4	2 1/2
K	1/8	1/4	1/2	3/4	1	1 1/4	1 1/2	1 3/4	2	2 1/4	2 1/2
J	1/8	1/4	1/2	3/4	1	1 1/4	1 1/2	1 3/4	2	2 1/4	2 1/2

Table of A. L. A. M. Standardized Fine Screw Threads.

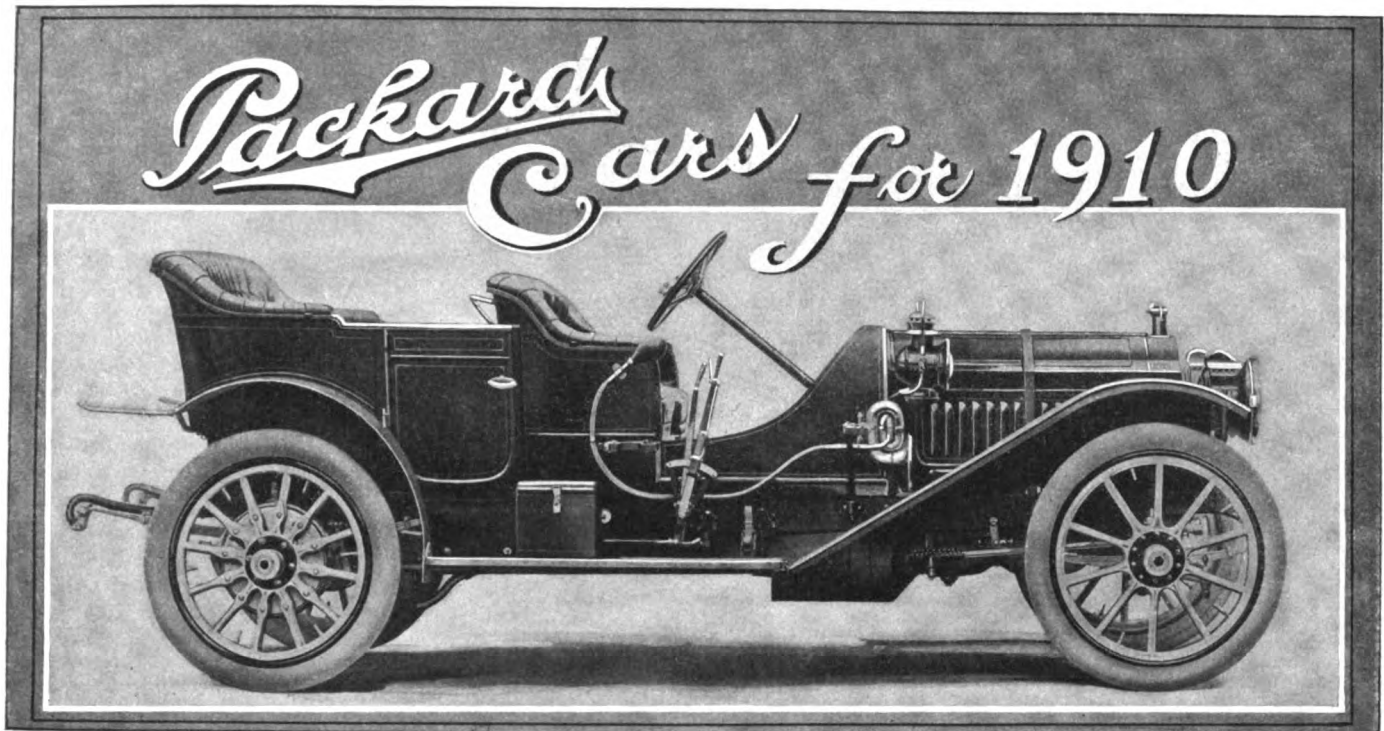

Latest Type of Packard "Thirty," Showing New Phaeton Body.

HAVING just completed the scheduled number of cars for the 1909 season nine days ahead of the time limit set, the Packard Motor Car Company of Detroit, Mich., is now announcing the details of the models upon which it will concentrate the energy of the enormous plant on the Boulevard for the coming year. This does not include any radical features, but is on the order of a continuance of its previous policy of confinement to a single quality product, in two sizes. These are the well-known "Thirty" and "Eighteen."

An examination of the appended details shows that the only very noticeable change is in the clutch, the type of which is a radical departure from previous Packard practice. Otherwise, the changes are all in the nature of small refinements, rendered advisable in the light of an additional year's experience.

The 1910 Packard "Thirty" may be obtained as the standard seven-passenger touring car, as a runabout, a limousine, a landaulet, with close-coupled body or with the new phaeton body. The latter body has been introduced as a practical vehicle meeting the demand for a fast, powerful car with low seats and small tonneau. The "Eighteen" is supplied as the standard five-passenger open car, a runabout, a limousine, or a landaulet. Both cars are the same in design and construction, the essential differences being in size.

The chief features in which the 1910 Packard differs from the 1909, apply equally well to the "Eighteen" as the "Thirty." Those who are familiar with the car and the company's long-established policy, know that each successive model, instead of being a radical departure from the preceding one, is, instead, a careful development of it. Consequently, the engineering work, and the improvements each succeeding year, have reached a

stage where the development comprehends even the most trivial feature of the car, tending toward mechanical refinement.

The motor is substantially the same as that of the 1909 car, improvements being confined to the mechanical detail. In order to obtain quiet running and efficiency under heavy duty, the main crankshaft bearings are of large diameter.

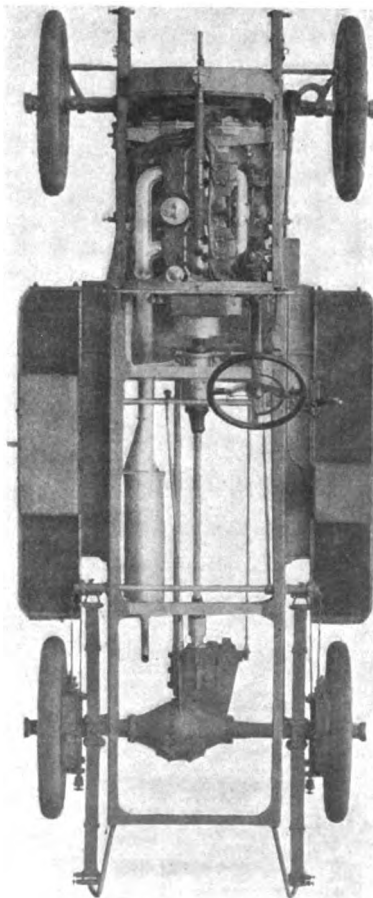

"Thirty" from Above Shows Simplicity.

Motor Shows No Changes.—The motor of the "Thirty" has four vertical, watercooled cylinders of 5-inch bore by 5 1-2-inch stroke, developing 30 brake horsepower at 650 revolutions. The "Eighteen" motor is of 4 1-16-inch bore by 5 1-8-inch stroke (103 x 130 mm), and develops 18 brake horsepower at 650. The cylinders are cast in pairs with integral water jackets and valve chambers. Cylinders and pistons are ground and interchangeable. The pistons are fitted with four ground rings. The three crankshaft main bearings are bushed with parsons white brass and are supported by massive webs. All bearing surfaces are ground. The connecting rods are drop forged. The crankpin bearings are bushed with parsons white brass and the piston pins with a special bronze. The valves are mechanically operated and interchangeable, the inlet and exhaust valves, on opposite sides of the cylinders. The camshafts are positively lubricated and protected, being encased within the crankcase. The camshaft, magneto, and water-pump gears are equally certain of lubrication and protection from dirt, being contained in a separate, but integrally-cast, oil-tight extension of the crankcase.

The crankcase is cast of a special aluminum alloy in three horizontal sections. The upper section, which forms the engine base, is supported directly on the side members of the main frame. All motor parts are completely protected by

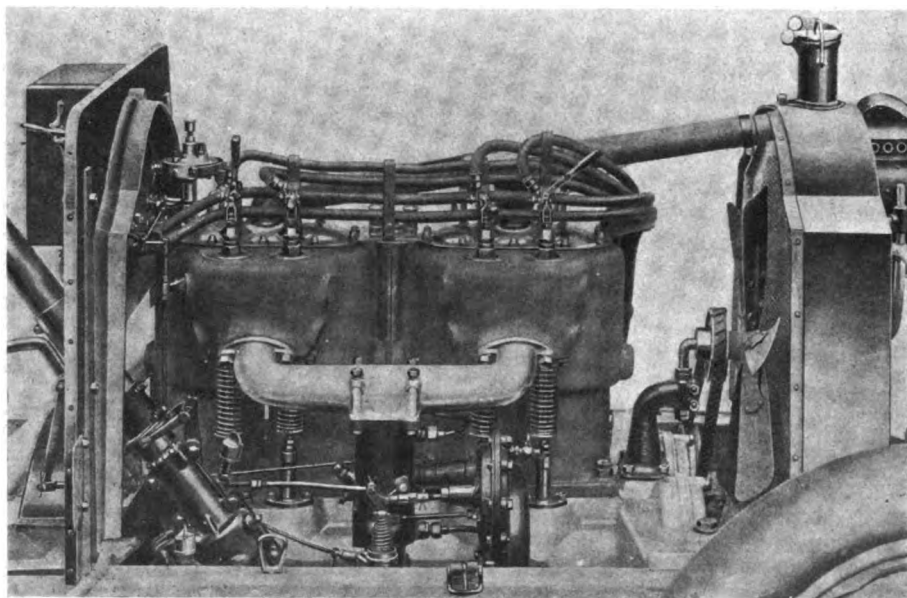

Right Hand Side of Motor of Packard "Thirty," Showing Carburetor and Governor.

an integral web between the transverse supporting arms on each side, entirely enclosing the space between the motor and frame. The crankshaft bearings are held between the uppermost and middle sections of the crankcase. The bottom section is an easily removable oil well. The crankcase is divided into front and rear compartments by a central partition, which supports the middle crankshaft bearing.

No change has been made in the carburation system. The carburetor, which is of Packard design and manufacture, is of the float-feed, aspirating nozzle type with an automatic auxiliary air-inlet. The nozzle is in the lower portion of the cylindrical and vertical mixing chamber and above it is a butterfly throttle controlling the quantity but not the quality of the fuel mixture. The auxiliary air-inlet, which automatically governs the intake of air to keep mixture at correct proportion for all engine speeds, is a poppet valve under control of an adjustable coil spring. Spring tension to suit different atmospheric conditions is regulated by a small lever on the dashboard. Uniform temperature of the carburetor is maintained by the circulation of warm water through a jacket around the mixing chamber. A primary air-intake shut-off assists starting in cold weather.

Fuel Feed Is by Gravity.—The gasoline feed is by gravity, from a copper tank under the front seat. The total capacity, including reserve supply contained within the main tank, of the "Thirty" standard chassis, is 21 gallons. In the case of runabouts, the gasoline tank is on the rear of the frame and the feed is by a simple automatic pressure system. A convenient gasoline valve controls the main supply, reserve and shut-off.

The water-cooling system is practically the same, with two small but valuable improvements. The suction strainer in the pump is quickly removable for cleaning, without the necessity of breaking any water connections. The filler cap has a new type of fastening which allows it to be quickly opened and closed and yet positively tightens it against leaking.

The water circulation is positive, by a gear-driven centrifugal pump. The radiator is of the cellular type. The capacity of the water-circulating system is five gallons. Forced draft, to increase cooling efficiency, is obtained by a belt-driven, ball-bearing fan, so mounted as to pro-

vide easy adjustment of belt tension. In the ignition system there are two detail improvements. The primary wiring, from the battery to the coil box, is carried within a neat protecting tube. The switch handle on the coil box is made in the form of a small lever, which is easily reached and turned by the driver, either with his hand or foot.

Features of the Ignition System.—The jump spark ignition is by the special Packard system. The current is supplied by an Eisemann low-tension magneto, mounted on the left side of the motor bed between the first and second cylinder pairs, and driven directly by enclosed gears. A storage battery, for starting the motor from the seat, is always in reserve, and is carried in an enclosed box on the right running board. The transformer coil for the magneto current and the vibrator coil for the battery current are arranged as a unit in a box on the dashboard. Between them is the combination hand and lock switch above mentioned.

The commutator, to make and break the battery primary current, is on a vertical shaft at the rear of the motor, being driven from the exhaust valve camshaft by enclosed bevel gears. Combined with the magneto is a distributor which, like the high-tension wires and the spark plugs, is common to both magneto and battery systems. There are universally jointed knife switches at the spark plugs.

The splash lubrication system is the same simple, positive system formerly used. A double plunger oil pump feeds the front and rear compartments of the crank case, in which are independent oil levels. The oil pump strokes being adjustable, the oil feed is easily regulated. The pump is accessibly located at the left of the motor and is driven by a worm on the exhaust valve camshaft. Oil is taken from a vertical copper reservoir close to and between the pairs of cylinders, this location insuring uniform temperature and fluid, easily-flowing oil, even in the coldest weather. The capacity of the oil tank of the "Thirty" is one gallon. There are two drip sight feedings on the dashboard and the crankcase drain cocks have anti-clogging devices of practical construction.

Motor speed is automatically and effectively regulated by an easily con-

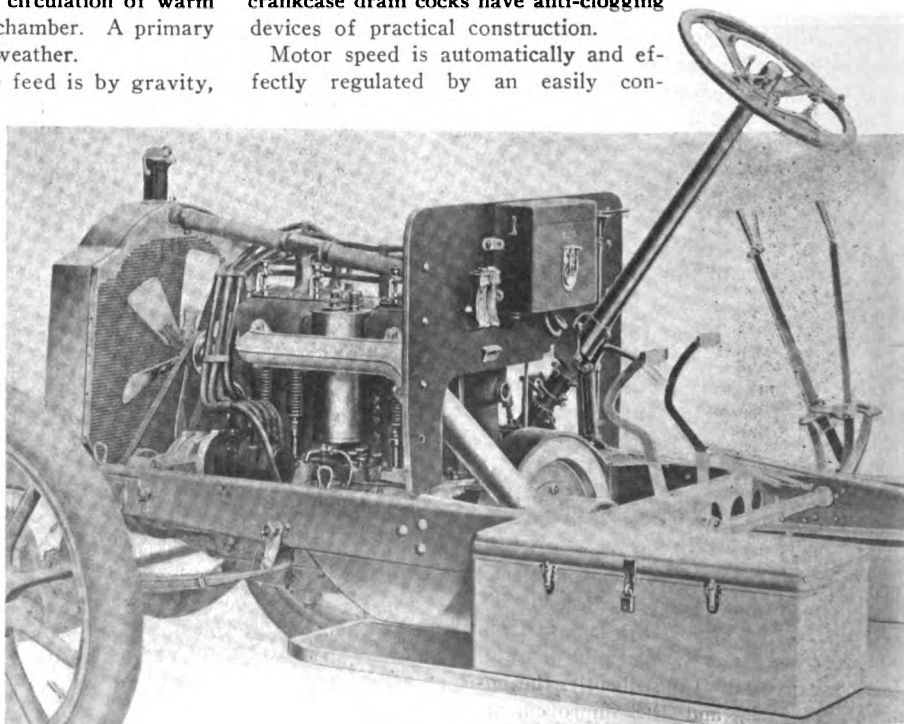

Dashboard and Left Side of Regular "Thirty" Chassis, Showing Control Levers.

trolled hydraulic governor, incorporated in the water-circulating system and acting directly on the throttle. A pedal, cutting the governor out of action, provides for instantaneous acceleration and high-speed running. The throttle also is under control of a hand lever on the steering wheel. Another hand lever on the steering wheel advances and retards the spark.

The starting crank, which previously had been held by a leather strap, when not in use, is now held in an upright position by an automatic latch.

Clutch Shows the First Big Change.—One of the most noticeable mechanical improvements in the 1910 Packard is the new dry plate clutch. This clutch affords the desirable feature of gradual engagement, and, as it operates without lubrication of any kind, provides the same action in cold as in warm weather. By the use of a special lining material between the plates, the clutch will not burn, even under the severest usage.

An addition has been made to the gear-shifting hand-lever quadrant, which gives the lever a selective action in the same quadrant slot. This lever is at the rear of the single slot in the quadrant for first speed and at the forward end of the slot for third speed. The introduction of small shoulders on opposite sides of the slot allow the lever to be hurriedly and positively shifted in either direction into second-speed position. Reverse is obtained by the lateral movement of the same lever into a cross slot on the inner side of the quadrant and opposite the neutral position of the lever.

The toggle operating the reverse gear, which has been an exterior feature, is now protected against dirt and used by being enclosed within the transmission gear housing. The other general features of the transmission are the same as have previously been identified with the Packard.

Three forward speeds, providing the most efficient gear ratios for all kinds of driving, and the reverse are obtained by sliding gears, the third speed forward being direct drive. This gear set, as formerly, is combined with the bevel-gear final drive and the differential, to form a rigid rear axle unit, which is contained in an aluminum housing. The latter is internally ribbed to obtain maximum strength and rigidity. The differential gear unit is supported by its own bearings so that the live rear axle may be withdrawn without disturbing the gears. All gears in the transmission, final drive and differential, as well as the rear axle, run on imported annular ball bearings. The extremely long propeller shaft has effectively encased universal joints at each end.

All Brakes Located in the Rear Hubs.—There are four brakes, all acting on the rear wheel brake drums, thus obviating the application of braking power on the transmission. The external contracting brakes are operated by a pedal for regular use. The internal expanding brakes are operated by an emergency hand lever. A drum disc entirely encloses and protects each internal brake. The expanding brake segments are now secured by bayonet locks, preventing rattle.

The improved steering wheel provides greater comfort for the hands, because the wood covering entirely encloses the metal rim and also extends onto the spokes. Another slight change in the steering gear is

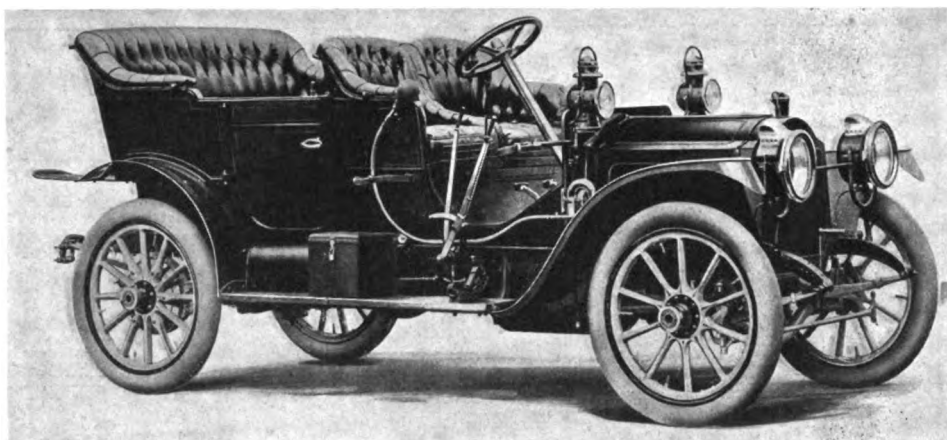

Packard "Eighteen" with Touring Body—Is Also Made with Runabout Body.

the addition of grease cups supplying lubrication directly to the steering sector shaft bearings.

The worm and sector are forged integrally with their respective shafts. The spindles and jawtype yokes are drop forged. The connecting rod, between the knuckles and the steering column, is placed above the front axle in a manner which minimizes stresses, vibrations, and consequent jar on the driver's hands. There are ball thrust bearings in the steering knuckles. The steering rod joints are encased and all connections have grease cups.

There are four wide semi-elliptical springs. In the "Thirty" the front springs are 40 inches long and the rears 56 inches long. In the "Eighteen," the front springs are 40 inches long and the rears 50 inches long. All spring shackle bearings are now lubricated by compression grease cups. The front axle is of steel tubing, of large diameter and heavy gage. The stationary sleeves of the rear axle are steel tubes, pressed into, and riveted within, the flanged collar of the differential housing.

Some of the Figures Are Interesting.—The wheelbase of the "Thirty" touring car is 123 1-2 inches and the tread standard, or 56 1-2 inches. The wheelbase of the "Thirty" runabout is 108 inches. The wheelbase of the "Eighteen" standard chassis is 112 inches, while that of the "Eighteen" runabout is 102 inches. The tires on the "Thirty" are 36 by 4 inches in front and 4 1-2 inches in the rear, except in the case of the runabout, on which they are 36 by 3 1-2 inches in front. On the "Eighteen," the tires are 34 by 4 inches, front and rear, except on the runabout, where they are 34 by 3 1-2 inches in front.

In all the standard bodies, the chief exterior differences are in the front mud guards and aprons, which have been carried farther forward to increase the protection against mud thrown backward alongside the bonnet. The price of the Packard "Thirty" touring car, runabout, phaeton or with close-coupled body, in standard finish and equipment, is \$4,200. The price of the Packard "Eighteen" open car or runabout, in standard finish and equipment, is \$3,200.

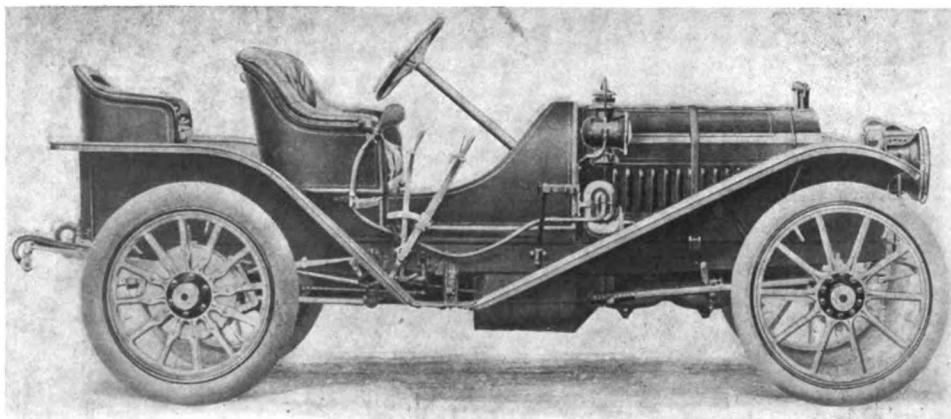

An Attractive "Looker" Is the Runabout Body on the "Thirty" Chassis.

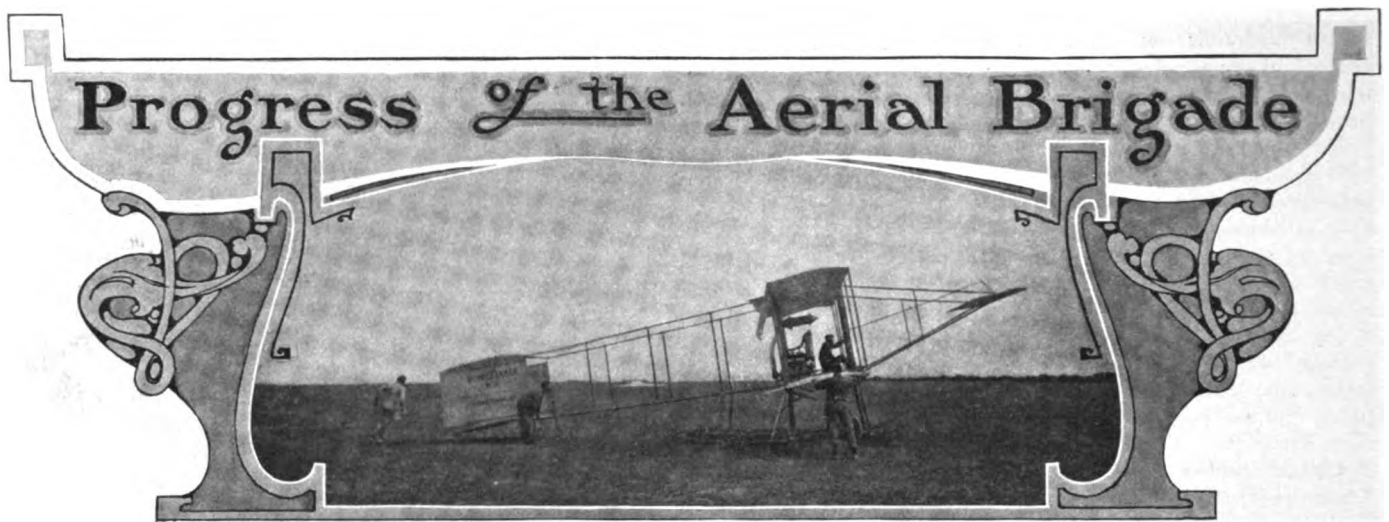

Henry Farman's Own Aeroplane in Readiness to Make Its First Flight.

PARIS, May 14.—A sum of \$20,000 voted by the French government for the encouragement of aeronautics is now being distributed to various promoting bodies. The manner of disposing of the entire sum has not been decided upon, but it has already been announced that the Aero Club of France shall have \$8,600, the National Aerial League \$7,000 for the formation of aerial pilots, and \$1,000 to the Society of Aerial Navigation. Others that will receive grants are the towns of Pau and Douai, and the Aeronautique Club of France.

The Aero Club of France has decided that \$2,800 of its government subvention shall be awarded as a cash prize for the longest aeroplane flight made this year away from a specially prepared aerodrome. One thousand dollars of the prize will go to the pilot of the machine, \$800 to the builder, \$600 to the constructor of the motor, and \$400 to the builder of the propeller. Another prize of \$1,800 will be awarded to the owner of the aeroplane which has remained in the air for the longest period between May 31 and December 31 of the present year. In the dirigible balloon class there is a prize of \$1,600 for the longest round trip, or journey from town to town. Small airships, not exceeding 1,500 meters cubic capacity, will be awarded \$400 for a journey of not less than 31 miles, starting and finishing at the same point.

Clement Working to Win Deutsch de la Merthe Prize.

Adolphe Clement, head of the Bayard-Clement automobile factory, has resolved to win the Deutsch de la Meurthe prize with one of his new airships now under construction at the Astra factory. Engagement has already been made for the prize, to win

which the balloon must fly 125 miles, starting from above the terrace of St. Germain, passing over the towns of Senlis, Meaux and Melun, to return to St. Germain. If successful, the owner of the balloon will be entitled to a gold cup valued at \$2,000 and a cash prize of \$4,000. The prize can be competed for on three successive years, each winner holding the cup for one year and being entitled to the cash prize of \$4,000. The winner on the third year will retain the trophy. On the first occasion no time limit will be fixed during which the trip must be made, the only condition being that a regular speed shall be maintained. For the two following years the trip must be accomplished in a determined time.

Giant Garages for Airships "Liberte" and "Russie."

At Moisson, 30 miles to the northwest of Paris, the largest airship garage ever built is now being erected for the Lebaudy brothers. The huge building, which has a length of 430 feet, a height of 95 feet, and a width of 131 feet, will serve for the simultaneous construction of the two airships *Liberté* and *Russie*, the former for the French and the latter for the Russian government. Both airships are expected to be ready for their trial trips about the month of July. The huge sheds have a framework composed entirely of wood covered with red tiles. The end of the shed forming entrance will be closed by immense canvas screens mounted on rollers.

Germans Plan Airship Line—From Lucerne or Friedrichshafen to North Germany, via Frankfort-on-the-Main, will probably be the route of one of the first regular airship lines.

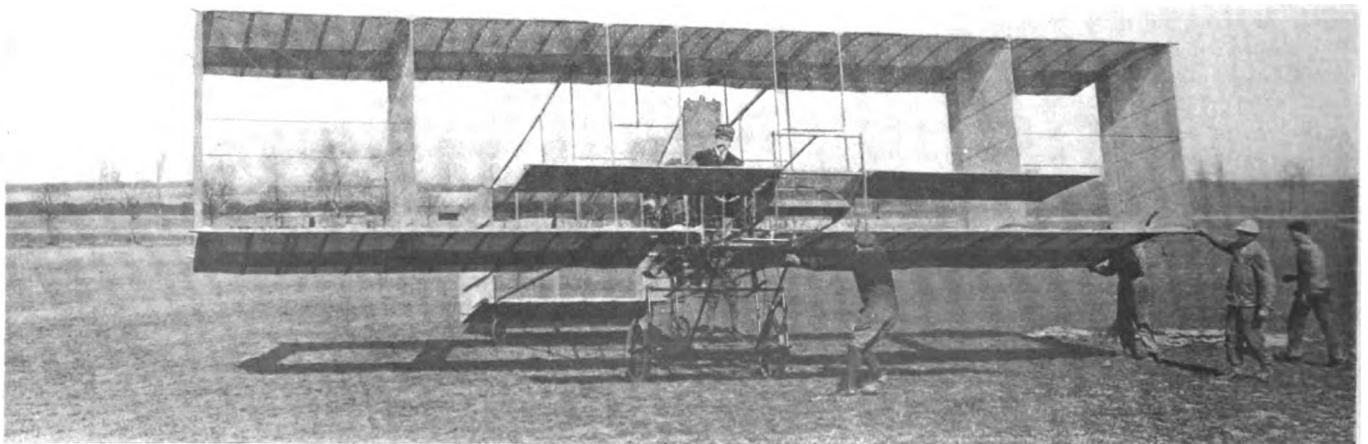

Baron de Caters Who Has Just Flown on a Volsin Biplane, Equipped with Gobron Eight-Cylinder Motor.

CANADIAN GLIDER BEING CONSTRUCTED.

OTTAWA, May 17.—Although this part of the Dominion has been rather backward in aerial experiment, a prominent resident of this city, Dr. Mark G. McElminney, is making great progress with his gliding machine, and hopes soon to be sailing through the air, from hill to hill. The machine, which is nearing completion, measures but 20 feet over all, will have 160 square feet of surface, and weighs but 50 pounds. With it Dr. McElminney expects to learn much about the gentle art of flying, the Gatineau hills being the scene of his experiments. Others are watching his work very closely, and if the machine is a success not only will he build a larger one, but numerous others will also build. It is barely possible, says the doctor, that the present machine may form the framework for an airship, power being added to it later.

KRUPPS FIGURE IN A WRIGHT COMPANY.

BERLIN, May 17.—In the formation of the Wright Flying Machine Company, in this city, it has developed that three of the largest corporations in Germany are interested in the new one. They are the Krupp Works, of Essen, the Allgemeine Elektricitäts Gesellschaft (General Electric Company) and the Ludwig Loewe Company, the last being a leading manufacturer of machinery and machine tools. It is thought that this presages the broadening of the aeroplane branch of aeronautics, and the building of machines upon a large scale. The new concern is called the Flug Maschine Wright Gesellschaft.

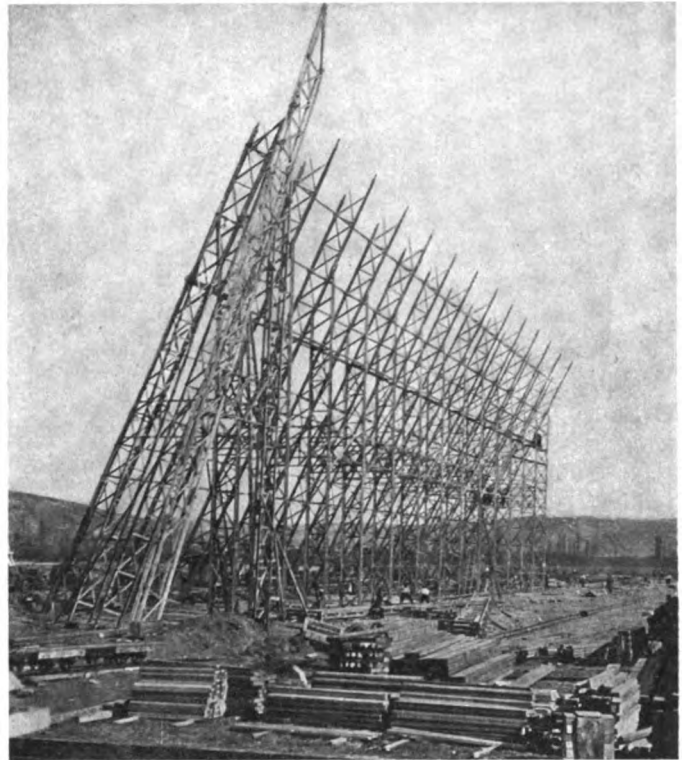

Putting Up the Framework for the "Russie's" Garage.

FIRST FRENCH WRIGHT MACHINE USED.

CANNES, FRANCE, May 17.—Comte de Lambert yesterday ascended in the first of the Wright aeroplanes to be built in this country. Four successful flights were accomplished at the Aerial aerodrome, each of a mile and a quarter, in which several difficult turns were taken.

CODY BREAKS ENGLISH RECORD IN FLIGHT.

LONDON, May 17.—S. F. Cody last Thursday broke the English record by flying a mile at a height of 30 feet with an army aeroplane at Aldershot. The Prince and Princess of Wales heard of this and asked Cody to repeat his flight, but in the attempt he smashed into an embankment after going 250 yards. The aviator escaped without personal injury, but his aeroplane was considerably damaged by the collision.



Needlewomen Sewing Big Envelope for Airship "Russie."

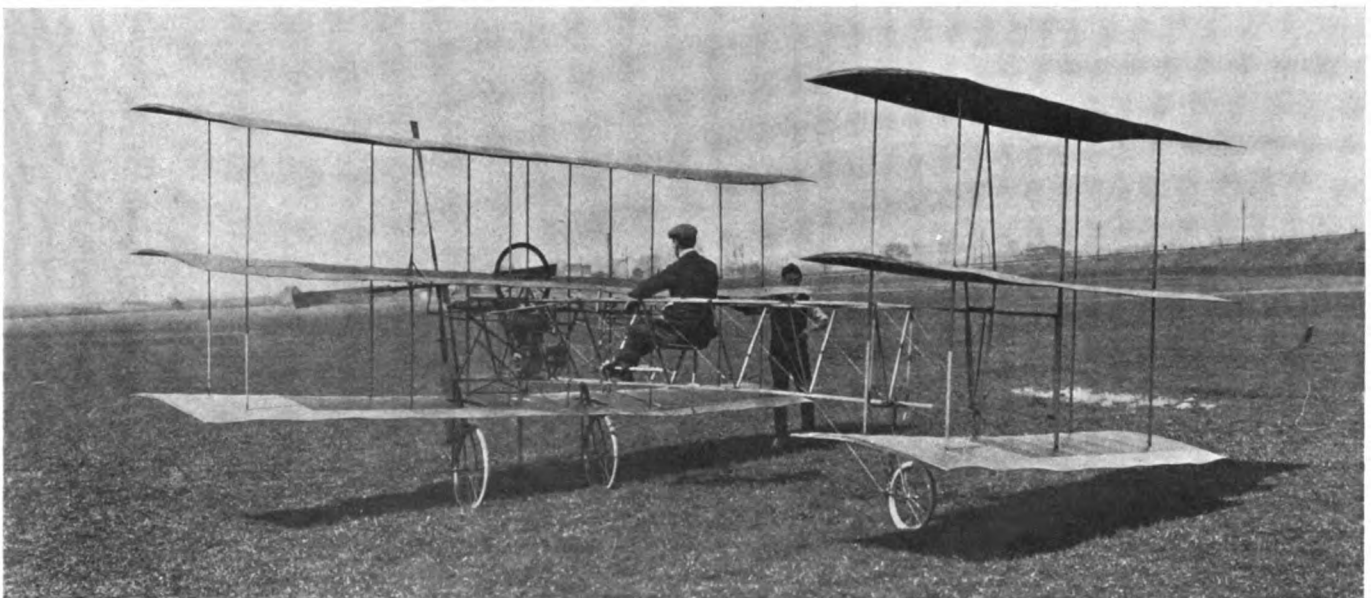

British Tri-plane That is Being Tested on Lea Marshes, by A. V. Row—It is Driven by Six-H.P. Jap Motor.



General View of Starting and Finishing Point—Italian Aristocracy to Be Seen In Foreground.

CIUPPA, AMATEUR, DRIVING SPA, WINS THE FLORIO

PALERMO, SICILY, May 5.—The Targa Florio, the Sicilian mountain race that has seen the exploits of Lancia, Nazzaro and other captains of the steering wheel and which has as its previous winners Cagno, Nazzaro and Trucco, was this year a race of eleven amateurs mounting machines of widely different powers. Ciuppa, a young Italian sportsman, who has not previously been heard of in connection with big races, came home first, having covered the single round of 93 1-5 miles, including the changing of two tires in 2:43:19, which means that his Spa car, one of the most powerful in the group, had maintained an average speed of 34 2-5 miles an hour.

As the drivers were exclusively amateurs, Vincenzo Florio, the millionaire sportsman who is responsible for financing and donating more automobile races than any man living, felt justified in running for the gold cup and \$1,200 in cash. He mounted a Fiat four-cylinder of 4 4-5 bore—the car which had Lancia as its driver in the Targa Florio of 1907—on which he went away first and finished first to the wild enthusiasm of his compatriots. But there was the dashing Ciuppa, started 19 minutes later, who had to be reckoned with, and when he arrived and the time allowance had been made another cheer had to be raised, for the Chevalier had gone down to second position exactly one minute behind the unknown amateur.

Third place went to Airoidi, driving a fine little Lancia four-cylinder car of but 3 1/2 inches bore, which finished twelve minutes behind the winner, beating a Spa with cylinders of the same size, but six in number, by a margin of 25 minutes. Deseta's big Itala, with a four-cylinder engine of exactly the same size as that driven by the winner, could not get better than fifth place, one minute behind the fourth car. A little four-cylinder De Dion, with a piston diameter of slightly less than three inches, came in sixth, but was outshone by its two-cylinder stablemate having a moderate 10-horsepower rating. Berliet had trouble with tires from beginning to end, with the result that he was a

tailender with a small De Dion voiturette entered more with a view to showing reliability than with a hope of capturing the gold cup.

Last year Trucco, on an Isotta-Fraschini, made the record, with an average speed of 35 1/2 miles an hour, the race then being run for 379 miles compared with but 93 miles this year. The tabulated result of the race is as follows:

Car.	Driver.	Time.
1. Spa, 4 cyl., 5.1 inches bore.....	Ciuppa	2.43.19
2. Fiat, 4 cyl., 4 4-5 inches bore.....	Florio	2.44.19
3. Lancia, 4 cyl., 3 1-2 inches bore.....	Airoidi	2.55.25
4. Spa, 6 cyl., 3 1-2 inches bore.....	Cortese	3.20.40
5. Itala, 4 cyl., 5.1 inches bore.....	Deseta	3.21.56
6. De Dion, 4 cyl., 2 9-10 inches bore.....	Stabile	3.21.52
7. De Dion, 2 cyl., 3 1-10 inches bore.....	Olsen	3.34.55
8. Berliet, 4 cyl., 4 7-10 inches bore.....	Rebolla	3.37.57
9. De Dion, 2 cyl., 3 1-10 inches bore.....	Tracona	3.58.46

PEUGEOT WANTED THE CUP.

PALERMO, SICILY, May 5.—Messina in ruins appeared to be a sufficient reason for abandoning the usual Spring automobile races round the mountainous Sicilian course, and instead of an entry blank an invitation was forwarded to the Lion Peugeot firm to return the trophy which they won with one of their single-cylinder cars last year. But the firm preferred to keep the trophy and sent an engagement of three cars, thus forcing the race to be held. De Dion being the only other firm invited to take part in the contest, but six cars started.

When the first of the two rounds was finished Guippone was leading with his teammates, Goux and Boillot, not far behind. The three De Dion cars were still in the run and going well, but were somewhat lacking in speed. Just when it seemed that Guippone would bring his Lion Peugeot home first and beat last year's time, he came to a stop with his gasoline tank empty. The finishing post was three and a half miles away, and was the nearest place at which more fuel could be obtained. Jumping

out of his car and seizing the bicycle of a spectator, the Italian driver of the French machine sped down the precipice-bordered road and in a very short time was back again with a gallon can of gasoline on his handlebars.

The mishap cost him first place, for while he was held up his team mate, Goux, went by and definitely captured the trophy for Lion Peugeot, his time for the 186 miles of mountain scaling being 6:48:2. Giuppone got home second, a little less than four minutes behind the leader. The third Lion Peugeot fell a victim to one of the hundreds of bad turns, leaving third place for Olsen on a De Dion Bouton in 7:47:55.

HEAVY TAXES ON BRITISH MOTORISTS.

LONDON, May 6.—While the imposition of fresh taxes on automobiles has for long been regarded as inevitable, few motorists were prepared for the drastic measure introduced by Lloyd George, Chancellor of the Exchequer, in his budget yesterday. At present, apart from the registration fee of £1, an annual tax of £2 2s. is the sole charge on cars, whatever be the power. The new taxes vary according to the horsepower, and for this purpose the R. A. C. rating of D³N over 2.5 will be used—for the present, at any rate. The scale is as follows:

Under 6.5 HP.....	£2 2 0	Under 33 HP.....	£ 8 8 0
" 12 ".....	£3 3 0	" 40 ".....	£10 10 0
" 16 ".....	£4 4 0	" 60 ".....	£21 0 0
" 26 ".....	£6 6 0	Over 60 ".....	£42 0 0

Motorcycles are £1 each, regardless of power.

These taxes come into force at once and are payable annually. A concession is made in the case of doctor's cars, for which only half the above amounts will be charged. Public service vehicles, including motor busses and taxicabs, are exempt from these taxes and will only be rated under the old system.

This is not all, for a tax of 3 pence per gallon has been imposed on petrol, subject to a rebate of 50 per cent. in the case of public service vehicles. These taxes are expected to raise a minimum of £600,000 per annum and the whole of this money is to be expended on the "improvement" (as opposed to "upkeep") of main roads. It is too early yet to record the opinions of the industry's leading men, but the feeling seems to be that the new taxation will mean a general reduction in horsepower for next season's cars, and may lead to extensive development of the long stroke and the two-stroke cycle engine. The tax will also press heavily on the public service companies.

LUMINOUS FRENCH REGISTRATION NUMBERS.

PARIS, May 14.—The decision of French authorities that all cars shall carry their rear registration number in the form of transparent letters and figures lighted by a lamp at the rear, or by an ordinary lantern placed in such a position that the plate can be read as easily by night as by day, has caused considerable disturbance among owners and as much activity among inventors. A box with a luminous front and containing an oil or kerosene lamp is at best such a delicate and dirty contrivance that there is every encouragement to replace it by electricity if this can be done economically.

An interesting device on these lines, consisting of a metal case the necessary length and height to conform with the police regulations, and a plate front with transparent figures, has been produced by Engineer Lacoste. The depth of the box is only 1½ inches, which thus gives a luminous number plate of smaller dimensions than anything else on the market and as easy to fix as the simple plate of regulation size. The plate carrying the figures is secured in position by entering two grooves, and maintained by an end plate fastened by two screws. Within the box is a very small electric lamp, receiving its current from a storage battery carried on any convenient part of the car. The feature of the appliance is a number of mirrors within the box by the use of which the whole of the figures and letters are perfectly illuminated with a minimum consumption of current. Two screws are sufficient to attach the box to the rear of the car, a cable connecting the lamp with the storage battery and a switch are all that are needed to secure a rear number that will never go out, and that will never become smoked so that it cannot be read "as clearly by night as by day," in accordance with the police regulations.

GERMAN COMMERCIAL TESTS IN PROGRESS.

The German military and commercial car tests are now well under way, forty vehicles in all having started from Berlin. Those participating in the latter event wind up their tour in Stuttgart on May 13, while the competitors in the military trial have to get back to the metropolis by May 21. A motor train, fitted up as a workshop, accompanies this section, which, having to be much longer on the road, have shorter daily tasks put them than the industrial section, although the stages are the same.

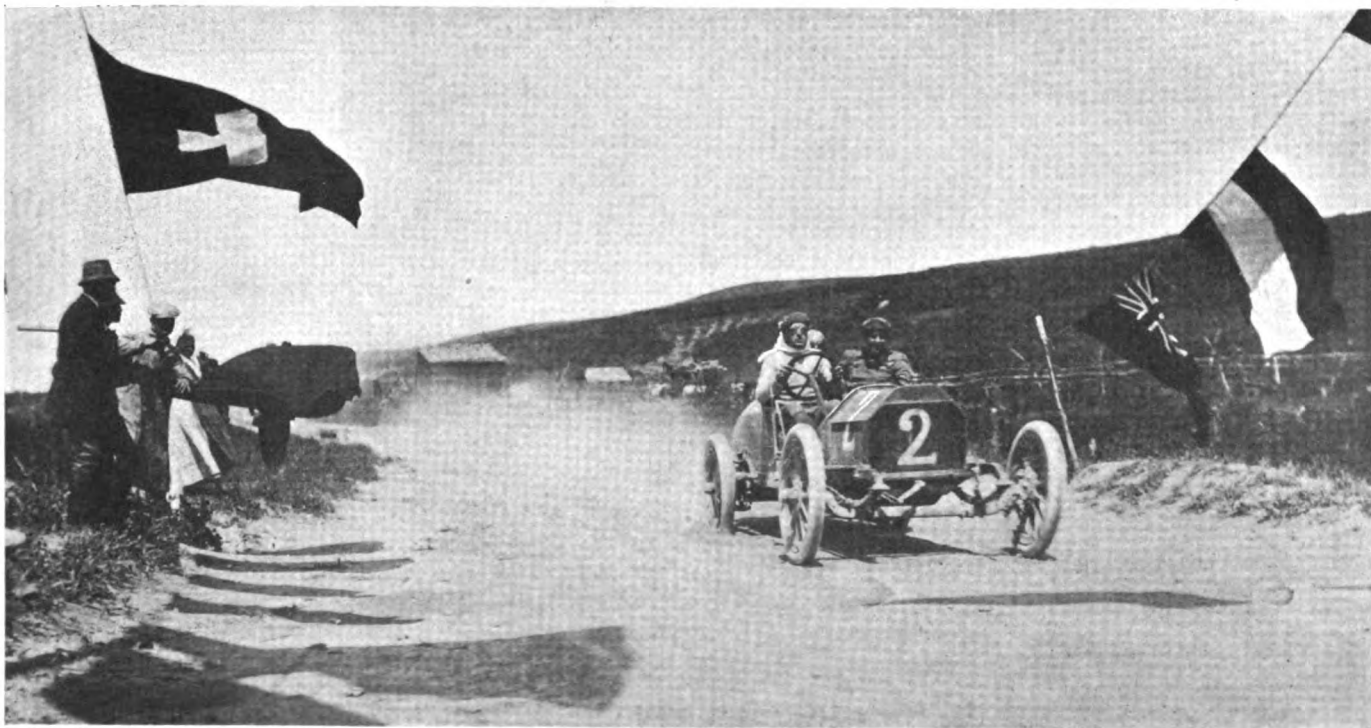

Arrival of Airoldi and the Little Lancia, Which Finished a Comfortable Third.

LATEST IDEAS IN ABOLISHING VIBRATION

PARIS, May 14.—Shock absorbers are one of the minor improvements that still interest both inventors and automobilists alike, and will doubtless continue to do so until bad roads cease to exist. One of the latest ideas in this direction, produced by Leon & Ballet, two French engineers, consists of a cylindrical metal case attached in a vertical position

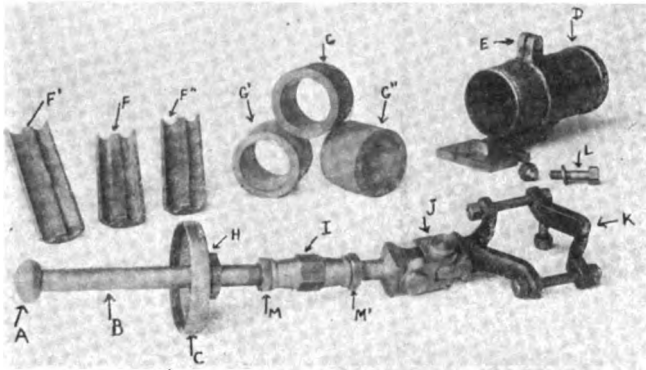

Leon & Ballet Shock Absorber Entirely Dismounted.

to the side member of the car, and containing a piston the prolongation of which is secured in a suitable manner to the car axle. Within the cylinder, D in the illustration, are three superimposed rubber rings G G' G'' forming a lining for the hardened steel plates F F' F'', forming three grooves when assembled together. It is within these grooves that the round headed end of the connecting rod A is lodged. When not subject to a shock, the ball head occupies a central position, with a play of about one-eighth of an inch all round.

On the car, springs being depressed, the ball head is, of course, driven upward, and as the grooves become shallower as they near their upper and lower end, the three plates are expanded against the rubber wall, thus progressively braking the movement. After passing the central position on the recoil, the same braking effect takes place in the lower portion of the slides. It will be noticed that there is a universal joint in the connection between the ball head and the axle and that the connecting rod can be regulated in length to suit the requirements of the car or to take up wear.

Another inventor, Georges Levi, would abolish vibration and road shocks by the use of a double set of springs, the second set being carried above the first set and united to them at the extremities by a suitable coil spring connection. The system can be applied to any type of suspension, but where the platform

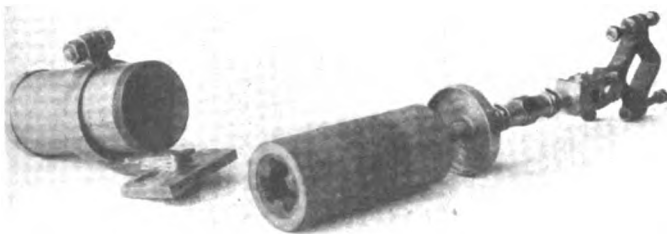

Showing Same with Piston and Rubber Rings Outside Case.

type is used it would be fitted to the transverse spring. In the case of a three-quarter elliptic it would be the quarter-length that would be supplemented.

It is claimed for the system that under a light load only the upper set of springs would be called into action, thus removing the disadvantages of hard springs so disagreeable on many cars when running light. Under a heavy load the two springs practically become one and work as one unit. On striking a rut in the road the two springs receive the shock together, but it is the lower one that ceases operation first, the load being left on the upper one alone, which has not sufficient power in itself to oscillate the body. The apparatus has the quality of simplicity and from tests that have been made appears to remove a large amount of vibrating and pounding on rough roads.

NEW AMBULANCES OF THE PARIS MUNICIPALITY.

PARIS, May 14.—The Paris municipality has adopted an improved type of ambulance which, though possessing little that is luxurious, is well equipped with practical appliances for the benefit of its occupants. The chassis has nothing that is distinguishing, being a standard Panhard 16-22, with chain drive. The body, built by Lamplugh, provides a rear entrance to an entirely metal-lined interior. The hospital bed is run onto a cradle down one side of the vehicle, attached by means of coil springs to the walls, and a suitable arm. A plentiful supply of

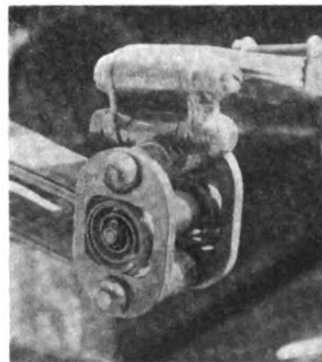

Levi Compensating Spring.



Same on Platform Type.

both hot and cold water is provided, the tanks being on the outside of the vehicle to the left of the driver. Within the ambulance is a washbasin similar to those used on trains and a single two-way tap providing either hot or cold water at will. Artificial lighting is by means of a special dynamo carried on the footboard and run off the transmission shaft; this supplies current for the head and side lights, as well as for the interior. A series of these ambulances are about to be put into service in Paris, replacing the present horse-drawn vehicles.

NEW AUTO ROAD TO SURMOUNT THE ALPS.

PARIS, May 14.—The Touring Club of France is responsible for a subvention of \$37,600 toward the construction of what will be the highest road in Europe open to automobile traffic. The new Alpine highway in which the club is interested will unite Thonon and Nice, following as closely as possible the Italian frontier, and passing through some of the most picturesque parts of the Alps. The highest elevation is on the Col de l'Iseran, over 8,000 feet above the level of the sea.



After Leaving Sedalia, Colorado, the Approach to the Snow Clad Rugged Rockies Is Imposing in Sublimity.

SURVEY OF GLIDDEN TOUR ROUTE PRACTICALLY COMPLETE

ROUTE-MAPPING for the course of the Glidden Tour is practically completed, for this week has been used by Dai H. Lewis, the official pathfinder in the E-M-F touring car, in covering the roads between Denver and Kansas City. As the run from Omaha to Denver was one long hill climb, the four days to be spent between the western turning point and the finish will be just as long a coast, a feature of the last leg of the contest. The pioneer party reached the "Mile-High City" last week, Wednesday, rested there until Friday, and then began the "trek" across southeastern Colorado and Kansas, expecting to consume a week in the distance to be dealt out to the contestants in four sections. Night stops will be made at Hugo, Colorado, and at Oakley and Salina, Kansas, with Pullman accommodations at these points, as will be the rule through part of Iowa and Nebraska on the westward journey.

The drop in altitude from Denver to Kansas City is 4,489 feet, or about seven-eighths of a mile. The road mileage by the chosen route cannot be stated, of course, until after the pathfinding is completed, but the route follows closely the line of the Union Pacific railroad, and the distance by rail is 640 miles. The second day out from Denver, going from Hugo to Oakley, there is a grand coast of 2,046 feet, or nearly half a mile downward in about 160 miles. This gives an average grade of thirteen per cent. and good braking will be at a premium. The next day, from Oakley to Salina, there is a drop of 1,818 feet, but the distance is nearly 200 miles, so the average of grade is a little less than 10 per cent. Those two are the big coasts, the final day offering only a drop of 482 feet in 190 miles. These will be

royal days, as well for keen competitive sport and for scenery. At night the contestants will camp in sleeping cars standing on lonely sidings near small towns. It is probable that, except for the big fête days at Minneapolis and Denver, these last few stages of the tour will be the most memorable of all.

Thus as mapped out at present the runs of the several days are as follows: First, Detroit to Kalamazoo, 142.2 miles; second, to Chicago, 173.2 miles; third, to Madison, Wis., 175 miles; fourth, to La Crosse, 154.4 miles; fifth, to Minneapolis, 178 miles; sixth and seventh, in Minneapolis; eighth, to Mankato, Minn., 132 miles; ninth, to Fort Dodge, Ia., 143 miles; tenth, to Omaha, Neb., 186 miles; eleventh, to Kearney, Neb., 200 miles; twelfth, to Julesburg, Col., 206 miles; thirteenth, to Denver, 208 miles, and then after a Sunday in that city, the four days across the plains to Kansas City, finishing July 29.

Inasmuch as there were enough evidences of the number of cars to enter by May 15, to insure the Pullman company of sufficient patronage to operate the minimum number of sleeping and dining cars, the entry list at \$200 per auto will be held open until June 15. Thereafter an additional hundred will be added to the entry fee. The Pierce-Arrow Motor Car Company has announced its entry of four six-cylinder cars, two of 48 horsepower each for the Glidden contest proper, for touring cars, and two runabouts of 36 horsepower each for the Hower Trophy.

An interesting feature of the pathfinding trip is the rapidity with which the news of the progress of the car has been communicated to the inhabitants of the country through which it has passed. Everybody seems to be waiting for it.



An Old Adobe Home in the Prairie's Midst.



Pathfinder Lewis Is Greeted by a Cowboy.

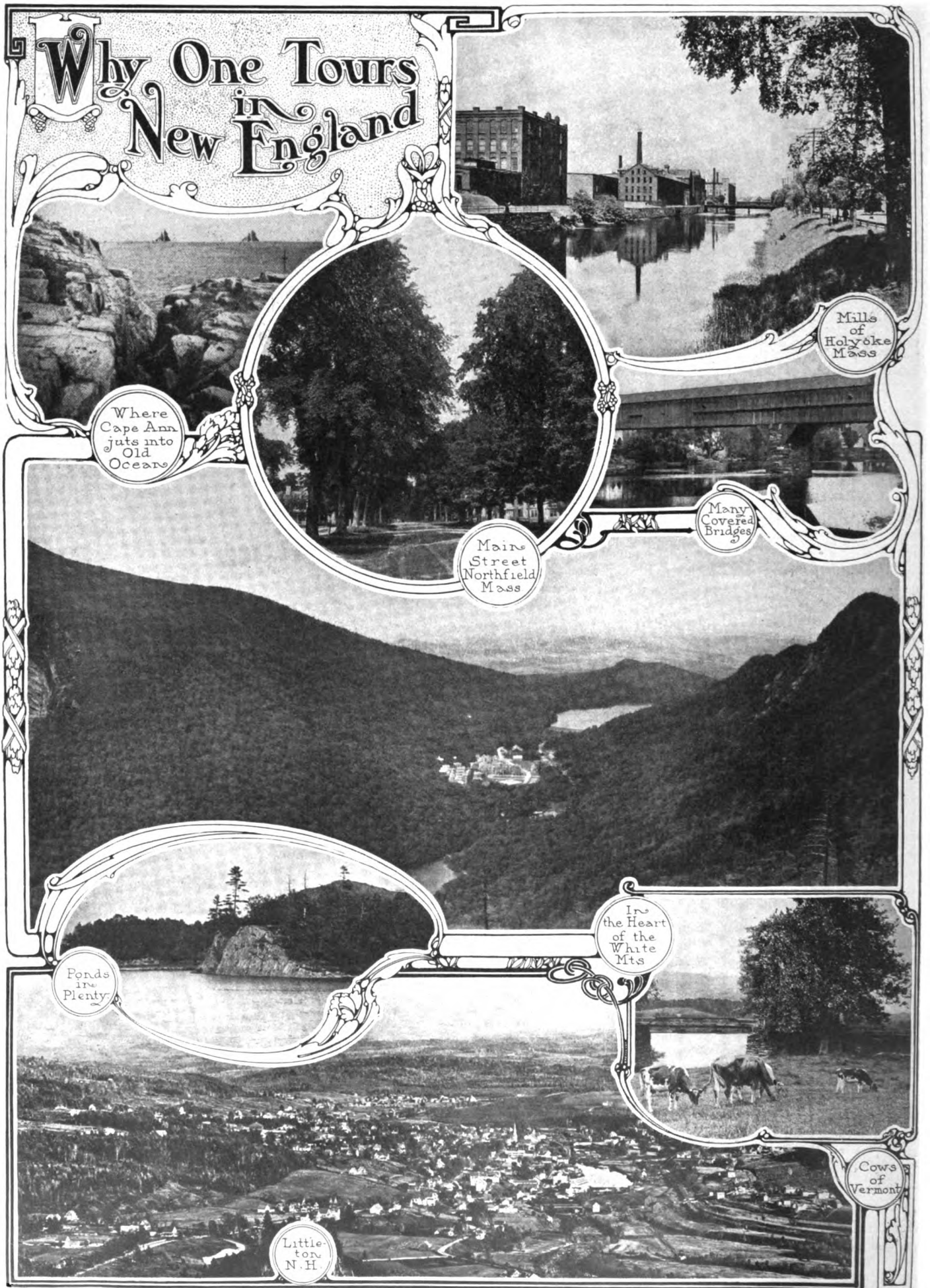

For a number of these photographs the courtesy of the Boston & Maine and Boston & Albany railroads is herewith acknowledged.

TOURING 'MID NEW ENGLAND'S VARIED SCENERY

NEW ENGLAND is replete with magnificent scenes and routes for the automobile tourist, and a trip through a valley conceded to be one of the most picturesque of all the beautiful valleys along the Atlantic seaboard, that of the Connecticut River, is the second of a series outlined by the New England Hotel Association. From New York City to the White Mountains and return is a tour of great popularity with automobilists from all over the country, because in these runs of between 700 and 1,000 miles there are views which are distinctive in their natural beauty, and roads which are the best that can be built. These pertinent features, combined with hotels of marked superiority, give those who tour conditions which equal the far-famed ones of the old world. Compiled in connection with the "Official Automobile Blue Book," the routes suggested by the hotel men are such as to offer either leisurely runs, with stops for luncheon at inns of recognized merit, or of a hasty trip with long daily mileage when necessary. It is hardly possible to go more than a few miles without passing the headquarters of members of the association.

Three tours have been chosen as those best suited to the owner of an automobile who would tour in the eastern-most tier of the United States, designated as "A," "B" and "C." The first was described in The Automobile of May 6, showing a tour of nearly 1,000 miles through the Berkshire Hills, the Green Mountains, the White Mountains, an extensive run along the sea-coast of Maine, New Hampshire and Massachusetts, and the shores of Long Island Sound. Tour "B" which is presented here is different in its nature, with delightful characteristics of its own, an itinerary that can be used either as a supplement to any of the others or as a route in preference to them. The route out of busy New York is a common one to the series as far as Bridgeport, where "A" goes north, or as an option as far as Springfield, where "A" turns northwestward and "B" continues northward. The shores of Long Island Sound are followed on the famous old Boston Post road to New Haven

through some of the most beautiful suburbs of the metropolis, between shady lawns surrounding imposing residences, with the views of the water meeting the eye every few hundred yards.

At New Haven a turn is made, the Yale campus passed and a short run taken to the State Capitol, Hartford, first going through Meriden and New Britain, both busy manufacturing places, so that when the Connecticut River is seen at Hartford, and later crossed, its beauty is realized. For about 225 miles

of the total 790 the auto will be driven along the banks of the river, through four of the six States. The roads are generally excellent and at no place less than good, or perhaps fair, while the fertility of the country, the verdure-lined banks of the stream, and the general thriving appearance is sufficient to relieve the most overworked mind, and thus is a source of a real vacation and a thorough pleasure. In addition to the main route, however, there are numberless points from which pleasant detours may be made, all of which are given in detail in the "Blue Book." Massachusetts is entered below Springfield and crossed directly to the north, through Holyoke, Northampton and Greenfield, at the last place meeting the route from Boston through Fitchburg and Athol. From the southern border of Vermont to the White Mountains at Bethlehem or Bretton Woods the tourist is led back and forth

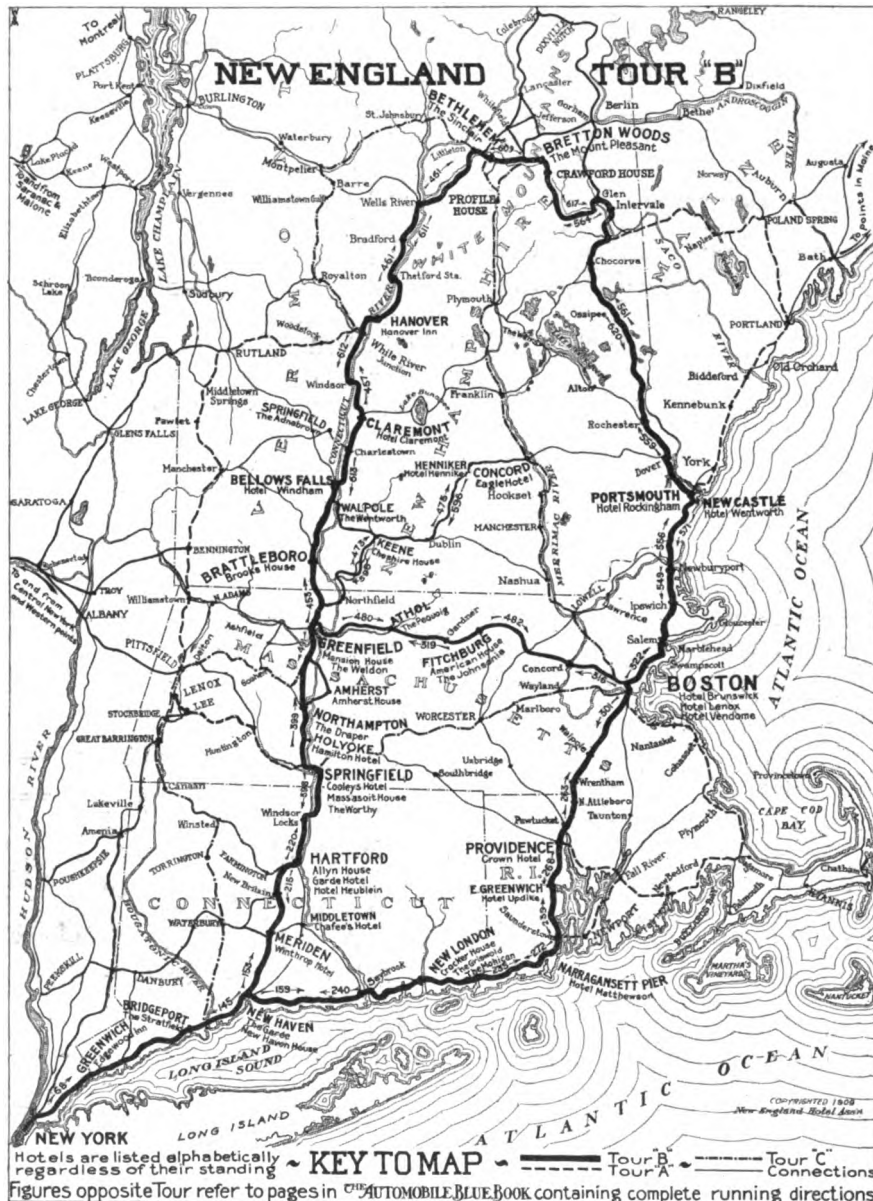

into New Hampshire, through fine pastoral scenery, into mountain passes that compare with anything the world possesses.

A wealth of wild and fascinating country is offered around the mountains, and then one of three routes may be chosen for the trip to the "Hub," the one under consideration being a middle one, direct to the ocean at Portsmouth. From Portsmouth to Boston is over roads that are famous for their hard surface, the delight of the autoist. Providence and Narragansett Pier are prominent points touched in Rhode Island, then New London in Connecticut; at New Haven the outward bound route is met, and the run into New York city a familiar one. Of course, the trip can be made in the opposite direction if desired.



Vol. XX.

Thursday, May 20, 1909

No. 20

THE CLASS JOURNAL COMPANY

H. M. SWETLAND, President
A. B. SWETLAND, Business Manager
231-241 West 39th Street, New York City

EDITORIAL DEPARTMENT

A. G. BATCHELDER, Managing Editor
R. F. KELSEY, Associate Editor
THOS. J. FAY MORRIS A. HALL W. McK. WHITE D. R. HOBART
W. F. BRADLEY, Foreign Representative

ADVERTISING DEPARTMENT

M. C. ROBBINS, Manager
W. I. RALPHE, 1085 Old South Bldg., Boston
C. H. GURNETT, 1200 Michigan Ave., Chicago
F. W. VAN SICKLEN, }
LOUIS R. SMITH, New York
FRANK B. BARNETT, Cleveland
H. H. GILL, Detroit
T. B. VAN ALSTYNE, Philadelphia

Cable Address - - - - - Autoland, New York
Long Distance Telephone - - - - - 2046 Bryant, New York

SUBSCRIPTION RATES:

United States and Mexico - - - - - One Year, \$3.00
Other Countries in Postal Union, including Canada - - - - - One Year, 5.00
To Subscribers—Do not send money by ordinary mail. Remit by Draft,
Post-Office or Express Money Order, or Register your letter.

FOREIGN SUBSCRIPTION AGENTS:

ENGLAND:—W. H. Smith & Sons, Ltd., 186 Strand, London, W. C., and all book-stalls and agencies in Great Britain; also in Paris at 245 Rue de Rivoli.
FRANCE:—L. Baudry de Saunier, offices of "Omnia," 20 Rue Duret, Avenue de la Grande Armees, Paris.
GERMANY:—A. Seydel, Mohrenstrasse 9, Berlin.

Entered at New York, N. Y., as second-class matter.
The Automobile is a consolidation of The Automobile (monthly) and the Motor Review (weekly), May, 1902, Dealer and Repairman (monthly), October, 1903, and the Automobile Magazine (monthly), July, 1907.

INFLUENCE OF LARGER WHEELS.

The fact of the influence of large wheel diameters, so thoroughly discussed a few years ago by manufacturers and resulting in the adoption of 36-inch wheels by nearly every maker of large cars, is coming to the front again as the result of recent meritorious performances of the wheels with increased measurements. Carriage manufacturers have long recognized the material advantages accruing to the use of the larger sizes, but it was not until recent years that the automobile manufacturers generally took up with the idea.

Beginning with the agitation of two years ago, sizes were increased all along the line, but a few braver ones did not stop with the generally accepted 36-inch size. Now it appears that the latter were in the right, and sizes again may be subjected to an upward revision which will make a new standard for large cars.

There are now on the American market two cars which may be had with large, or, as they have been called, "carriage-sized" tires. One of these, the one expressing the preference for the larger size of the two, recently came through a very severe endurance contest with a nearly perfect score, while the large tires were the only ones in the whole "bunch" of contestants which went through without any trouble.

In many cases of trouble with deep mud and other severe road conditions, the bigger wheels were always

"on the job," and, as in mud, their very size was an advantage to the car so equipped.

Thus also in the recent one-gallon economy contest in New York City the larger sizes were always to the fore. Of the first four but one was small, and that not very small. The average of these four was 34 inches, which is commonly regarded as a large size. Down at the end of the table are found all of the small sizes and but one of the large ones. This would almost allow of the deduction that large tires, meaning large diameter wheels, are a form of added economy. In this connection it is to be regretted that two exactly similar cars with different sized wheels were not in the contest so that this point could be settled. It is believed that 38- or 40-inch wheels, and a gear ratio which took this into account, would have allowed the winner to improve even the excellent and very noteworthy score made.

One factor which formerly contributed to the use of small diameter wheels, or rather which made them a necessity, is no longer in force. This is the matter of tire sizes. At first, pneumatic tires were made only in small sizes, which meant small wheels or solid tires. Now, this no longer holds, as tires may be had in any desired size, and tire manufacturers would gladly make other larger sizes if the demand warranted. So, one by one, keeping pace with the increase in demands, the obstructions and possible factors which have held back the use of larger wheels have been removed, or reduced to a negligible quantity.

All of the arguments applied to the use of any size larger than 28 inches apply with equal force to the still larger sizes above 36 inches. Summing up all of the points, the time appears ripe for another increase in the size of automobile wheels.



WHERE PREPARATION MEANS MUCH.

While it is probably true that there are a great many people capable of starting out on a long-distance automobile tour without bothering much in the way of preparation, trusting to the mood of the moment for the picking of a night stop and following unexplored roads, the wisest plan in this country of doubtful hotel accommodations is to plan the route carefully and pick a hostelry of known reputation for the sleep which always comes after a day on the open road. Nothing spoils so much the pleasure of automobile traveling as poor accommodations for the night and the invariable accompaniment of mediocre replenishment for the hungry inner man. Don't endeavor to do too much in a day, and it is much the better to make an early start and get well along on the day's run before the laggards of the highway have appeared for their midday siestas or else their eleventh-hour scorching to reach the next big town.

A mingling of town and country in the matter of picking the journey's interruptions adds variety to the trip, which is especially sadly missing when only the crowded city entices the traveler greater than the lure of the green-dressed country with its valleys, and lakes, and rippling streams. Hence, study well before you start out for a long trip, leaving the hit-or-miss episodes for near-home chances, for it is a case of where time spent in preparation will be hours gained on the road, to say nothing of the consequent comfort from utilizing the carefully compiled information of the Blue Book series.

PENNSYLVANIA LAW EFFECTIVE JAN. 1.

HARRISBURG, PA., May 17.—Automobilists from outside of Pennsylvania should make note of the fact that the new Pennsylvania law does not go into effect until January 1, 1910. The first impression was that the clause in regard to reciprocity to non-residents of those States granting reciprocity to Pennsylvania autoists would become effective at once. According to Joseph W. Hunter, State Highway Commissioner, this clause of the law awaits the application of the entire act, which does not become effective until January 1, 1910. Hence, it is stated regretfully, that Pennsylvania will continue the present year to ask non-residents to obtain licenses as before from the State Highway Commissioner, the fees remaining at \$3 for driver's license, yearly renewal January 1; registration of car unnecessary, but driver's license tags must be carried.

IN ENFORCING NEW JERSEY'S LAW.

TRENTON, N. J., May 17.—In filing complaints and evidences against non-resident automobilists with the State Motor Vehicle department, magistrates must hereafter accompany same with a 30-cent fee and the necessary mileage. This decision was handed down last week by Assistant Attorney-General Gaskill in settling a dispute between Magistrate Noar, of this city, and Motor Vehicle Commissioner Smith. The former contended that the latter was compelled to push all cases sent to him by magistrates; the commissioner said that in many cases the costs of prosecution would be prohibitive. Attorney-General Gaskill's opinion states that the Motor Vehicle Commissioner may issue summonses in cases "which he regards as meritorious." It seems certain that future prosecutions will be confined to those cases where there is a good chance of getting at the culprit.

NEW PHASES OF OHIO AUTO LAW.

COLUMBUS, O., May 17.—Several important rulings relative to the operation of automobiles have been made by the Ohio automobile department and the attorney-general. The department has decided that when a member of the family owning a car drives it is not necessary to take out a chauffeur's license. Identification by the tags is considered easy when the car is driven by the owner or a member of the family. In contrast to this is the statement from the attorney-general that when a car is owned by a corporation and used by many of the officers and stockholders, each one will have to provide himself with a license as chauffeur, because the ownership of the machine by the corporation does not identify officers and stockholders.

WISCONSIN SENATE PASSES AUTO LAW.

MILWAUKEE, WIS., May 17.—Recklessness determined by the occasion may be the speed limit of automobiles in this State, with a nominal limit of 25 miles per hour, if the bill which has passed the Senate goes through the Assembly and is signed by Governor J. O. Davidson. The bill was prepared by Senator E. E. Page of this city and practically wipes out the speed limit, substituting the terms of recklessness, and amendments were made in the upper body requiring operators to slow down at corners and prohibiting persons under 16 years of age from running a car unless accompanied by parent or guardian.

PENNSY'S CROSS-STATE ROAD MUST WAIT.

PHILADELPHIA, May 17.—After long and serious consideration, Governor Stuart, on Friday last, reluctantly and sorrowfully vetoed the cross-State highway bill. This measure, which the Governor bent every effort to put through both houses of the Legislature, called for the expenditure of \$5,000,000 within three years, and with so many demands upon the treasury from schools, hospitals, the indigent insane and the consumptive poor, His Excellency could not find it in his heart to sign the bill.

MRS. LONGWORTH GETS OHIO TAGS.

COLUMBUS, O., May 17.—Fred H. Caley, superintendent of the Ohio State automobile department, has shipped to Mrs. Alice Roosevelt Longworth a set of tags for a gasoline machine with which she expects to do considerable touring in Ohio this Summer. The tags were shipped to Washington, D. C.

FUTURE OF GRAND PRIZE WORRIES SAVANNAH.

SAVANNAH, GA., May 17.—The Solid South is interested in the action of the Savannah Automobile Club relative to the future of the Grand Prize Race. The club held a meeting recently at which the matter was talked over. In a letter received from the Automobile Club of America there seem to be very little hope of having another international race, as the foreign manufacturers have agreed not to enter future races, but neither the A. C. A. nor the Savannah Automobile Club have given up the idea and everything possible will be done to have one held. Mayor Tiedeman will leave for Philadelphia on Tuesday and will go to New York, where he will talk with officials of the A. C. A.

WESTERN EDITION OF THE BLUE BOOK.

Robert Bruce, editor of The Official A. A. A. Automobile Blue Books, has just returned to Chicago, where he has been located with his staff for some time past editing the Western edition. Mr. Bruce has been preparing a series of trips from Chicago in every direction and has covered up to date over 6,000 miles of territory never before adequately described. In the meantime Blue Book Car No. 1, in charge of E. R. Mixer, is nearing Chicago through Ohio and Indiana, preparing and now revising main routes from the East. The new section of the "Blue Book" will cover Ohio, Indiana, Illinois, Michigan, Wisconsin and Kentucky, and will connect by the best roads the principal cities west of the Mississippi River.

BOSTON DECIDES TO HAVE 1910 SHOW.

BOSTON, May 17.—Success in such a large measure resulted from the 1909 show in Mechanics Building that the Boston Automobile Dealers' Association last week took official action in regard to the 1910 exhibition. The corresponding week of next March will be the date and Chester I. Campbell will again manage the affair. Reports of the last show have indicated that it was the most successful ever held, considered from any angle, the gate receipts were larger than usual, the general interest was greater and the effects are still being felt as a sales stimulus. The dealers have decided to take an active part in the Orphans' Day outing on June 9, and will take the blind children of the Perkins Institute on a trip to Sharon later in the same month.

ORPHANS' DAY IS APPROACHING.

Orphans throughout the country will have their annual automobile outing on June 9. This will be the fifth celebration of the day in some cities, and already preparations have been made for making the 1909 event the most memorable of them all. The automobile trade has always been a supporter of orphans' day, and this Summer a special campaign will be outlined to secure the machines from private owners as well as dealers and manufacturers. W. J. Morgan has the metropolitan outing in charge and it is his idea to present to the orphans' day committee a plan of having each make of car in the run fly a pennant with its name and number. This little feature is partly advertising and partly because nowadays the public is more interested in the make of the cars taking part than any of their entrants or drivers. The Quaker City Motor Club will engineer the celebration in Philadelphia and cars for nearly 1,000 children have already been promised. With plenty of cars at their disposal and plenty of small children ready to fill them, the committee expect to make the event one that will be long remembered.

What the Clubs are Doing These Days

COLUMBUS ASSOCIATION ELECTS OFFICERS.

COLUMBUS, O., May 17.—At the annual meeting of the Columbus Automobile Association, held in its club rooms recently, the following officers were elected: President, Max Morehouse; first vice-president, P. B. Monypeny; second vice-president, Dennis Kelly; secretary, N. O. Aeby, re-elected; treasurer, Herman Hoster. The club has arranged to start a series of short runs on Saturdays and Sundays, and the national orphans' day will be celebrated by taking the little folks to the Country Club. An automobile show will be held in the Fall.

ATLANTA'S CLUB NOW HAS FINE NEW HOME.

ATLANTA, GA., May 17.—The Fulton County Automobile Club is now well settled in its club house and is fortunate in the possession of a fine old country place. This house was built as a residence by one of Atlanta's wealthy citizens and when it was thrown on the market the club gobbled it up. The house is



Fulton County Automobile Club's House Near Atlanta.

located on the Peachtree road, about five miles from the city, and is situated far back from the road in a grove of fine old forest trees. It is fitted up with all the taste of the homes of the wealthy and cultivated and it is doubtful if any automobile club in the country has a more artistically furnished house.

WALLA WALLA AUTOISTS ORGANIZE.

WALLA WALLA, WASH., May 17.—Temporary organization of automobilists of this city was changed into a permanent one at a recent meeting attended by nearly all local autoists. The following officers have been chosen: President, Dr. E. E. Shaw; vice-president, J. W. Lankdon; secretary, Tom Drumbeller; treasurer, W. W. Baker; board of directors: T. A. Paul, Dr. E. E. Shaw, W. J. Corkrum, W. W. Baker, Tom Drumbeller, J. H. Morrow, John Langdon, C. J. Bowers, Gilbert Hunt, George Kellogg, J. M. Crawford, E. H. Preston.

PROSPECTS FOR NEW CLUBS IN WISCONSIN.

MILWAUKEE, WIS., May 17.—The usual spring activity in club circles is manifesting itself now, and a number of new clubs are being formed. The commercial association of the Eau Claire is taking steps to form a club, which will affiliate with the State and national bodies. A number of owners at Lancaster are considering the proposition to form a local club.

CLEVELAND CLUB ACTIVITY—GOOD RESULTS.

CLEVELAND, May 17.—The Cleveland Automobile Club is at the present time taking a most active interest in autoing conditions in Cleveland and northern Ohio, and as a result is receiving the co-operation not only of motorists but of the police force, in addition to the state board of registration.

For some time there has been an epidemic of stealing in this city which the police have been powerless to prevent. After waiting some time for the police force to make a definite move, the Automobile Club stepped into the breach with an offer of a reward of \$100 for the arrest and conviction of any one caught stealing an automobile or any part thereof, with the result that the thieves have grown wary and cars standing on the streets at night are now practically safe. "Joy riding" has been practically stopped by revoking licenses.

Perhaps the most important action of all those taken by the club relates to reckless driving and speeding. Threatened with the passage of an eight-mile-an-hour ordinance in all parts of the city, the club proceeded to join hands with the police and an effective campaign against law-breaking drivers is now on in full force. A bureau has been established at the club to assist in this work, and the club members are requested to send in the numbers of speeding cars. The owners of these cars then receive warning notices from the secretary's office, and after repeated offenses the numbers are voluntarily turned over to the police with a request that drastic action be taken. As a result of these crusades the club is coming into the limelight in northern Ohio, and the membership is increasing by leaps and bounds toward the 1,000 mark.

PITTSBURGH ACTIVE IN GOOD-ROADS WORK.

PITTSBURGH, PA., May 10.—Allegheny County roads are being constantly improved through the activity of the Automobile Club of Pittsburgh, in co-operation with the road supervisors and engineers. The influence of the club has been directed by George T. Barnsley, good roads engineer and chairman of the road improvement committee. The county is now spending about \$1,000,000 per year for the purpose of bettering its highways, and 60 miles of macadam will be constructed this year. As a result of its interest in the supervisors there are now 15 road drags in use and reports show that the cost of keeping the roads has been reduced from \$35 to \$8.50 per mile, the drag needing only three men instead of six.

Secretary Wolff and other officials recently met with the supervisors of Mercer County, aiming to get the road from Mercer to Zelenople and Meadville macadamized. Mercer, 50 miles north of this city, is on the main route to Buffalo. The club will issue its road book on June 1, containing 110 routes in detail.

SAVANNAH ENDURANCE RUN TO BE MAY 31.

SAVANNAH, GA., May 17.—The next event of interest to the automobilists of this vicinity will be the endurance run to Augusta and return, a distance of 132 miles each way. The Automobile Club at a recent meeting decided to hold this on the last day of the month, starting at seven o'clock in the morning.

It is not to be in any manner a speed test, but endurance will be the standard by which merit will be measured. It is likely that twenty cars or more will make the trip and the car with the least stops will be rewarded the trophy. Secretary Arthur Solomon was given the duty of preparing a list of penalties which will govern the run. Another point of interest brought up was that ladies would be allowed to make the trip.

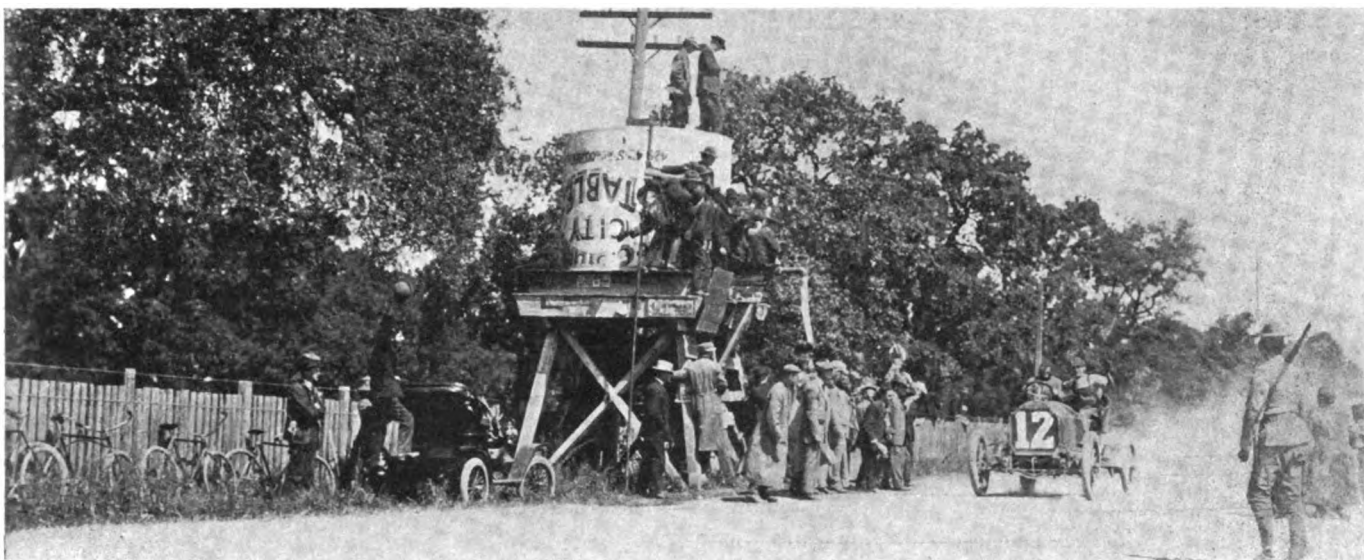

Ben Noonan, Winner of the Santa Rosa Road Race, Crossing Finish Line in His Stoddard-Dayton.

CALIFORNIAN RACE HAS A STODDARD-DAYTON WINNER

SAN FRANCISCO, May 10.—Under the joint auspices of the Sonoma County Automobile Association and the San Francisco Motor Club, the first road race in the northern part of California, held yesterday near Santa Rosa, had a Stoddard-Dayton as a winner. The course was 40 miles long, and a particularly hard one because of the many turns and the condition of the road surface. The first 15 miles constituted a very badly twisted "straightaway," with a number of turns at an angle of nearly 45 degrees. The road surface was rough for fast work, and that an accident did not occur is little short of a miracle. After this came the greatest test, in what was known as the "Loop." The road winds from Geyserville through the Dry Creek country, and back to the so-called "straightaway." It is full of sharp turns, many of them at the apex of steep grades.

Twelve cars started, eleven of which practically came to grief, although six reached the finishing line. The honors of the day went to the Stoddard-Dayton, entered by A. D. Plugoff, and driven by Noonan. The elapsed time of the winner was 1:05:18, which won for it the \$500 trophy. The Moore Motor Supply Company's trophy, which was second prize, went to the Stevens-Duryea, entered by the Pacific Motor Car Company, and driven by C. Ontank. He covered the course in 1:07:30, despite trouble encountered. In the loop the car crashed into a fence and cracked the frame, which broke when driven over the rough ground on the homestretch. Ontank finished, however, and crossed the line

in second place. The Stoddard-Dayton, which came in third, was driven by Fred Wiseman, who lost time in recovering a battery which dropped off. Fay Sheets, at the wheel of the Acme, drove the last 17 miles on the rim of the left front wheel from which the tire had been thrown. He swayed and careened over the finishing line, having covered the course in 1:11:37 1-2. The Buick, which arrived fifth, came to grief through a broken gas-line feed pipe, caused by hammering over the rough roads. Several minutes were spent in repairing the pipe, and the car's elapsed time was 1:15:12 1-2. The Tourist, a California-built car, entered by H. W. Bogen, came sixth.

It was a fine day for the spectators, but a most expensive contest for the owners of most of the cars that participated. The course was patrolled by a squad of the State militia, assisted in handling the immense crowd by the supervisors of Sonoma county, the police of Santa Rosa, and the officers of the two automobile associations.

Those who had charge of the event were: Starter, William R. Johnston; assistant starters, Captain Fred A. Marriott, Jr., W. B. Morrell; clerk of the course, A. D. Plugoff; chief timer, P. F. Gillette; timers, W. B. Lloyd, W. W. Peterson, William Pedlar, William Hinklebein; judges, Fernando Nelson, William M. Klinger, J. H. Gray, J. W. Griffith, R. R. l'Hommedieu; referee, C. C. Donovan; contest committee, Don C. Prestiss, chairman, and J. R. Leppo.

CHICAGO'S ROAD RACES ARE RAPIDLY FILLING

CHICAGO, May 17.—Entries to the Chicago Automobile Club's races, set for June 18 and 19 over the Crown Point-Lowell course, will close officially June 5 with Frank H. Trego, although provision is made for possible stragglers by giving them five days of grace in which they can enter upon payment of \$250 extra per car.

At the present time there are sixteen actually in hand—eight in each race—while the outlook is that there will be twenty at least in each contest, General Executive Trego having a long list of prospectives. The last name to be added to the entry list was that of Knox, which has named two cars for the Cobe cup, the blanks for which came to hand Saturday. This was preceded earlier in the week by the nomination of a Fiat by E. A. Hearne, of Chicago, the owner of the car, and who already has had racing

experience through having been a competitor in the light-car race at Savannah. The Isotta, Benz and Renault also are on the likely list, while it is reported that Apperson and the Locomobile will be in inside of a week. The Pennsylvania is counted on for two, while the Thomas people are now tuning up a 1910 little six. As the list now stands there already are in the Cobe race two Knoxes, two Stoddards, three Buicks and a Fiat.

In the light-car event there are the Moon, three Buicks, two Stoddards and two Marions, the last named having been nominated earlier in the week. Two Chalmers-Detroits are expected.

As a result of a careful odometering of the course by General Executive Trego, it is announced by him to-day that the circuit is exactly 23.6 miles in length. In the Cobe cup race the cars will make seventeen laps and in the Indiana trophy ten laps.

CHANGES IN YORK COMPANY PERSONNEL.

YORK, PA., May 17.—President S. E. Baily and General Manager and Designer James A. Kline have severed their connections with the York Motor Car Company, manufacturers of Pullman automobiles. For some time this move has been rumored in automobile circles, but has just been announced officially and a number of changes have thereby been made. Mr. Baily withdrew recently and Mr. Kline on Saturday, selling part of their stock to New York parties and retaining some, it is understood. The report that the General Motors Company was interested is said to be unfounded, and the local concern will hereafter be directed by Oscar Stevenson and Thomas C. O'Connor, formerly secretary and treasurer and vice-president, respectively. The former will act as business manager.

Mr. Baily, who has an extensive business in carriage building, has started the erection of a new concrete automobile factory in which commercial cars will be built at first, and then the lines of pleasure cars added.

As general manager and designer Mr. Kline has contributed largely to the success of the York company, bringing it to a point where the supply of Pullman automobiles is less than the demand. He has propositions from a number of automobile concerns which he is considering. At present he is attending to private interests in this city and Harrisburg. As the entrant of Pullman automobiles in all of the important track and endurance contests of the east, aside from his business relationships, he has gained a wide acquaintanceship among the trade.

TRACY TESTS NEW DIAMOND RIM AND TIRES.

As a preparation for the Cobe trophy race, and to give a critical test to the new demountable rims developed by the Diamond Rubber Company, Joseph Tracy recently made eight laps of the 1908 Vanderbilt race circuit, maintaining an average speed of 60 miles an hour, and reaching a maximum of 92 on the motor parkway. According to his report, as issued by the Diamond company, the new rim and the Diamond grip tire for racing and anti-skidding work, after going through the mill of every kind of a test Tracy's experience could suggest, were not affected. The tire casings were not materially injured and the rim in the same condition as at the start. No change of tires was necessary in the entire eight laps, and on the full set not more than a score of steel studs were loosened. The car used was a 90-horsepower Simplex, and to demonstrate the time necessary to change tires, the car was brought to a quick halt from full speed at the end of the eighth circuit, and Tracy states that it took just 30 seconds to take off the tire and rim and place fresh ones on the wheel. This test has assured the Diamond company to its own satisfaction of the ability of the rims and tires, and an active participation in current races is planned.

MORE ADDITIONS TO RAMBLER FACTORY.

KENOSHA, WIS., May 17.—Enlargements now being made to the factory of Thomas B. Jeffery & Company in this city, when combined with those buildings to be erected within the next few months will give the plant an additional space of 186,256 square feet. Added to the present space, the total will be approximately 800,000. Rambler factory construction will be followed, that of one story, solid concrete structures, with steel frames, and saw-tooth roofs. One building now under way, with an area of 98,688 square feet, will be devoted to inspection and exterior finishing departments; 41,120 will be the area of the addition to building number 7, used by the final inspection department, and number 5, the assembly and stock rooms, will secure 16,488 additional. The original Rambler factory, building 1, will be enlarged by the addition of 30,000 square feet, all of these together greatly increases the capacity of the plant. A new laboratory for testing materials will be installed, and within a year a new office building will be started.

THE DEATH OF DANIEL W. MARMON.

INDIANAPOLIS, IND., May 17.—Daniel W. Marmon, president and one of the founders of the Nordyke & Marmon Company, died at his home in this city last Monday, after an illness of seven months. Death was not unexpected as he had been in a serious condition for some time.

Mr. Marmon was born in Ohio, moving to Richmond, Ind., with his parents when two years old. After completing his education in the schools and Earlham college in that city, he purchased an interest in the firm of A. and H. Nordyke, manufacturers of flour milling machinery. This company was then reorganized as the Nordyke & Marmon Company and in 1876 moved to this city. When automobiles became used so generally a few years ago, the company was one of the first in the city to engage in their manufacture. Associated with Mr. Marmon in the business were his sons, Walter and Howard C., who with the widow and a daughter survive. The funeral services were held last Thursday afternoon.

The factory and down-town salesrooms were closed on Tuesday, Wednesday and Thursday. Mr. Marmon was also president of the Indianapolis Light and Heat Company.

PACKARD TRIES OUT THE ZEGLEN.

DETROIT, May 17.—That tire troubles are due to be reduced to a minimum if not entirely eliminated as the result of his invention is the confident prediction of a Chicagoan named Zeglen. Nor are his claims impaired any as a result of tests he has been conducting here, with the cooperation of the Packard Motor Car Company. Taking two heavy planks, Zeglen filled them with sharp pointed nails of varying lengths. On the back of each of these another plank was securely fastened so that the nails could not be pushed back. Then a Packard car equipped with Zeglen tires was run over these nail-studded planks, slowly and at a speed of twenty to thirty miles an hour. Singularly enough, the tires, which are made of bullet proof cloth treated with rubber and vulcanized, did not show the slightest effects of the hard usage to which they were subjected. More exhaustive tests are being arranged for the Packard people, while Zeglen is planning to erect a factory here for the manufacture of non-puncturable tires.

THIRTEEN ENTRIES FOR RUN TO SEATTLE.

NEW YORK, May 17.—Announcement has been made of thirteen entrants for the transcontinental endurance contest, which will start June 1 for Seattle. They are as follows:

FORD	Ford Motor Company.
FORD	Ford Motor Company.
ACME	Acme Motor Car Company.
STEARNS	Oscar Stolp.
SIMPLEX	Simplex Automobile Company.
SHAWMUT	Shawmut Motor Company.
THOMAS	Gus Buse.
RENAULT	W. G. Houck.
THOMAS	E. R. Schmidt.
FRANKLIN	S. S. Mapes.
WELCH	L. H. Perlman.
STEARNS	Chas. Watson.
GARFORD	Wally Owen.

Mills & Moore, the Eastern managers, have given out this list with the statement that several others may enter before the start. In the meantime the Thomas pathfinder has finished its survey of the roads around Boise, Idaho, and is now within striking distance of the finish. The Seattle authorities have about completed the building set aside for the cars which finish the contest.

NEW COMPANY FORMED IN CLEVELAND.

CLEVELAND, May 17.—Within a few weeks, the Cleveland Electric Vehicle Company, formerly the Cuyahoga Motor Car Company, will begin the manufacture of electric taxicabs. The reorganized concern is capitalized at \$300,000, and Francis J. Wallace, formerly of New York, who floated the Citizens' Taxicab Company in this city, will handle the sales.

Told in the Progress of the Industry

Pierce-Arrow Factory Additions.—When the new factory of the Pierce-Arrow Motor Car Company, at Buffalo, was completed about a year and a half ago, it was thought that it would be sufficiently large for a long period. The first addition has become necessary, however, and it will be to machinery hall, one story in height, 201 feet long and 50 feet wide, giving 10,500 square feet additional floor space. This will be utilized for the installation of new machinery and will give machinery hall a complete floor space of 92,705 square feet. The new section will be built of reinforced concrete. A second addition will be built to enlarge the body-building department. It will be 60 by 75 feet in size and three stories high, giving an additional floor space of 24,000 square feet and making that of the department 167,040.

Winton Self-Starter Holds Its Pressure.—The Winton Company is frequently asked whether the pressure on its self-starting system holds during long periods of inaction, and the following letter received from B. A. Armstrong, of New London, Conn., is cited as the experience of one owner. Mr. Armstrong says: "Referring to my new 1909 Winton, it is a fact that this car was jacked up in my garage late in December or early in January. My chauffeur says the pressure was 110 lbs. when we left it. I spent the Winter in Florida, returning on the 10th of April. A few days later we put the car in commission and we found the self-starter pressure was 90 lbs., and the car was started without cranking; in other words, the self-starter was in full operation after the car had stood nearly four months."

Palmer-Singer Makes Hard Run Across Desert.—Clarence E. Conent, of El Centro, Cal., has recently made a trip in his P. & S. Six-Sixty car, which is notable among the hard trips possible on the Pacific Coast. He drove from El Centro to San Diego, 260 miles, over trackless deserts, and then crossing the mountains. After a day in the latter city he returned to his home in a day, both going and returning without a mishap, part of the distance running where there was no road, and for the greater part where there was a mere outline of wheel tracks. The route is considered one of the worst in California, and generally impassable for automobiles. Mr. Conent's car is over a year old, and the two hard runs seemed to have no deleterious effects upon it.

Mrs. Ramsay Plans Transcontinental Tour.—Final preparations for a tour in her Maxwell car from the Atlantic to the Pacific are being made by Mrs. Alice R. Ramsay, of Hackensack, N. J. She expects to leave New York City on June 9 in her new 30-horsepower car, and hopes to reach San Francisco by July 15 over a route through Albany, Rochester, Buffalo, Toledo, Chicago, Cedar Rapids, Omaha, Julesburg, Cheyenne, Granger, Ogden and Reno. Accompanying her will be Mrs. N. R. Powell, Mrs. W. Atwood and Miss H. Jahns, all of Hackensack. Mrs. Ramsay is an experienced

tourist, the president of the Women's Motoring Club of New York, and of the women's section of the Maxwell-Briscoe Motor Club.

Where the Old Cars Go.—"There has always been considerable mystery in the mind of the public where all the old cars go," says "Tommy" Forbes, sales manager for the Overland and Marion cars, "but for me this mystery was dispelled during a recent trip to the West. Hundreds of old-timers made back in 1901, 1902 and 1903 are being used there and are giving perfect satisfaction. I saw many rear-entrance cars, and it is no uncommon matter to hear the chug-chug of 'one-lungers.' Many beginners in the West are using these old machines and I find that many are finding a lodging place in the Y. M. C. A. and other automobile schools."

Credit Where Credit Belongs.—By a regrettable oversight in connection with the photographs taken by night, which were published in THE AUTOMOBILE May 13, the omission of the word "Bureau" from the copyright credit, attributed the ownership to the Technical Press, a printing concern in New York, instead of to the Technical Press Bureau, which makes a business of supplying articles on automobile and motor boat subjects. The three night photographs were taken by Harry W. Perry, and are copyrighted, but the daylight photos are not copyrighted, and the notice should not have appeared upon them.

Kokomo Concern to Make Carbureters.—The Planhard Manufacturing Company, of Kokomo, Ind., has been formed to manufacture carbureters and other automobile accessories. The officers are: President, W. D. Parr; secretary, W. B. Voorhis; general manager, F. L. Kingston; factory superintendent, C. H. Felske. Mr. Kingston has been connected for a number of years with Byrne-Mr. Felske has been with the Apperson Kingston & Company, of Kokomo, and



The De Lisser Trophy.

This handsome cup is offered by the president of the Ajax-Greib Rubber Company for the Maxwell-Briscoe Motor Club's June Tour.

Brothers Automobile Company. It is expected that the new plant will be open about June 1 and will employ a force of 25 men.

Locomobile Company Will Increase Factory.—Plans have been made by the Locomobile Company of America for a large addition to its factory at Bridgeport, Conn. The new part will cover an area of 40,000 square feet and enable the factory production to be made 1,200 automobiles a year. It will be possible to add from 300 to 600 mechanics to the present force, and under the present plans the cost will be about \$60,000. The wing on the north side will be continued three stories in height, of brick and steel construction, and ready for occupancy early in the Fall.

"Tailor-Made" Wind Shields.—From the fact that no two automobile makers use the same kind and size of dash, requiring the manufacturer of glass fronts or wind shields to keep on hand samples of all makes, the Banker Wind Shield Company, of Pittsburgh, Pa., has adopted the expression "tailor-made" as applicable to its products. These shields have to be made to fit each dash to a nicety, and to do this templates of all various sizes and widths have to be kept on hand, and necessitates fine machinery and manufacturing facilities.

Electric Vehicle Receivers' April Report.—The April report of the receivers of the Electric Vehicle Company covering business done shows sales of \$87,819.35, with purchases of \$35,902.13. The cash receipts were \$247,526.69. There was derived from royalties under the Selden patent \$150,382.70. The disbursements amounted to \$203,601.97, one item of which is \$40,270.45 paid to George B. Selden, and there was also paid over to the Licensed Association \$61,840.95. The balance on hand on April 1 was \$151,356.13, and on May 1 \$195,280.85.

Novelty Manufacturing Company Will Issue Catalogue.—The Novelty Manufacturing Company, of Waterbury, Conn., makers of specialties in metal goods, announces that it will shortly issue a catalogue of automobile hardware and accessories. Its automobile department is now in charge of F. L. Cowles, formerly of C. Cowles Company, New Haven, and late executive secretary and treasurer of the National Association of Carriage Hardware Manufacturers. He is well known in both carriage and automobile lines.

Milwaukee Crippled Children Ride in Ramblers.—Milwaukee's blind, deaf, crippled and invalid children were given a theater party last week, and through the courtesy of A. W. Shattuck, manager of the Rambler Garage Company, of Milwaukee, the branch of Thos. B. Jeffery & Company, Kenosha, Wis., the little ones were given an automobile ride to the theater and another ride following the performance.

Enlarged Plant for Mayo Radiator Company.—Manufacturing of automobile radiators has so increased that the Mayo Company, of New Haven, has had plans

drawn for the addition of two buildings to its plant. The main one will be one story high, built of brick, 150 by 300 feet in dimensions, and the smaller one will be 40 by 60 feet, and used for a box shop.

According to Arthur Jervis: "Taxicab drivers in New York, where twenty blocks on the avenues measure exactly a mile, boast that on rainy days they can register a mile every seventeen blocks, on the asphalt, because of the skidding of the wheels."

Diamond Tires on Flag to Flag Car.—The Chalmers-Detroit car, which is acting as pathfinder for the flag to flag endurance run from Denver to Mexico City, is equipped with Diamond tires and Marsh quick-acting rims.

IN AND ABOUT THE AGENCIES.

Cleveland Adds to "Fifty Cars Sold Here."—Local automobile trade, which has had a war cry of "Fifty cars sold here," will have to change this, for another agent has come to town, and still another is expected shortly. The arrival is the agency for the United Motor Buggy Company, placed with the Auto Sales Company, the Hupmobile agent, at 1122 Chestnut street. The Schutt buggy, of Cincinnati, will soon be represented by the Weddell House Garage, the interstate agent, on Frankfort avenue, N. E.

Premier, Philadelphia.—The most recent addition to the Quaker City's "Gasoline Row" colony is the Motor Company, which has secured the local agency for the Premier car, and will be exploited from large and handsomely appointed quarters at 132-134 North Broad street.

Dayton Rubber Company Opens New York Branch.—Under the management of Arthur L. Manley, a branch in New York has been opened by the Dayton Rubber Manufacturing Company at 1595 Broadway. Dayton airless tires will be handled from this location hereafter.

TAXICAB AND TRANSIT.

Mail Automobiles for Japan.—Advisability of transporting mail by automobiles is being investigated by the Japanese minister of communications, according to newspapers of that country. It is proposed to establish a system of distribution and collection in the principal cities at first, and to gradually extend that to distant points not reached by railroads. Tokio and Osaka will get the first of the cars and it is said that Tomijiro Oguri, a merchant of the former place, will act as a contractor to supply them. If the autos are imported they will be free of the 50 per cent. duty ad valorem now levied, but it is likely if the proposition is favorably considered that the cars will be constructed in Japan, only the motors, tires, coils, and a few parts being imported.

Plainfield to Metuchen, N. J.—On a 45-minute schedule a passenger, mail and package line has been instituted between Plainfield and Metuchen, via Oak Tree. Two cars of 20-passenger capacity will be put into operation immediately, with an additional one held in reserve for rush hours, and orders will be placed for larger machines to seat 36 people, with a double-deck arrangement. The distance is 9.4-5 miles and the machines have been tested over the route at a three-quarters of an hour headway, giving satisfactory results.

Nashville Gets the Habit.—Taxicab service is about to be instituted in Nashville, Tenn., by a company which has been formed there with a capital of \$30,000. A number of cabs will be purchased very shortly and put into immediate use. The concern is composed of a number of wealthy business men, among them being Major E. C. Lewis, D. S. Williams, G. E. Bennie, Banks Bennie, H. S. Frazier and James Frazier.

Rome to Adairsville, Ga.—Capitalists of Rome, Ga., are planning to establish an automobile line between that city and Adairsville, a distance of 18 miles, over the fine roads of Bartow and Floyd counties. The railroad schedules are inconvenient, and two round trips daily are suggested for the autos.

Atlanta, Ga.—For the use of its fire department chief the city has appropriated \$4,000, with which to purchase an automobile. A choice will be made shortly, and the car selected must have a body suitable for carrying two fire extinguishers and other apparatus.

Swarthmore, Pa.—A company has been organized to be known as the Swarthmore Service Company, and will run an automobile 'bus line between the station and the town.

PERSONAL TRADE MENTION.

William B. Hurlburt Will Remarry.—A marriage license has been issued in New York to William B. Hurlburt, manager of the New York branch of the E. R. Thomas Motor Company, and Miss Mary Elizabeth Malloy. Mr. Hurlburt and his former wife, Mrs. Charlotte Hurlburt were divorced in Detroit two weeks ago.

Peter Dumont, who was connected for over two years with the Pope-Waverly, and for five years as manager of the automobile department of the New York Studebaker branch, has joined the commercial vehicle forces of the Baker Motor Vehicle Company, with headquarters in the New York branch at 1788 Broadway.

A. S. Blair, who recently severed his connection with the Mar-Del Mobile Company of Baltimore, has accepted a

position on the sales force of the Zell Motor Car Company, representative of the Peerless and Chalmers-Detroit.

O. P. Smith, who has been manager of the Studebaker electric department in Kansas City, Mo., has resigned to take a position as manager of the Hathaway Electric Car Company at 1606 Grand avenue of the same city.

Wallace C. Hood, well known in Baltimore automobile circles, has become the general sales manager of the Motor Car Company, the agent in the Monumental City for Thomas, Stevens-Duryea and E-M-F cars.

James Joyce, manager of the American Locomotive Company automobile department, who recently spent two weeks at the Country Club in Farmington, Conn., will, it is said, make his Summer home in that town.

Warren J. Shay, formerly salesman with the Denver agency for the Stearns, has taken a position as Cleveland salesman for the Gaeth Automobile Company, of Cleveland.

NEW AGENCIES ESTABLISHED.

Frontenac: Nassau County, L. I., N. Y.—Anton T. Smith, Motor Parkway Garage, Jericho turnpike and Tyson avenue. Floral Park, N. Y.

Pierce-Arrow: San Antonio, Tex.—Lumby-Wood-Brownlee Auto Company, direct agent, formerly sub-agent of Houston Motor Car Company.

Babcock: Philadelphia.—Stoyel & Vogel, in addition to the American, Grout and Midland.

Jackson: Utica, N. Y.—C. H. Childs & Company, Lafayette and Seneca streets.

Chalmers-Detroit: Indianapolis, Ind.—Indiana Automobile Company.

Rambler: Atlanta, Ga.—Baynard Wellingham, 70 South Forsyth street.

Frontenac: Brooklyn, N. Y.—P. J. Forbes, 86 Schermerhorn street.

Brush: Plainfield, N. J.—Laing Machine-Auto Repair Company.

Mitchell: Lambertville, N. J.—O. M. Driscoll, East State street.

Haynes: Kansas City, Kan.—Seberlin & Boyd, 1 Fifth avenue.

Fuller: Boston.—E. P. Blake, Haymarket Automobile Station.

Hupmobile: Brooklyn, N. Y.—Parkside Automobile Station.

Gaeth: Minneapolis, Minn.—McAllister-Newgord Company.

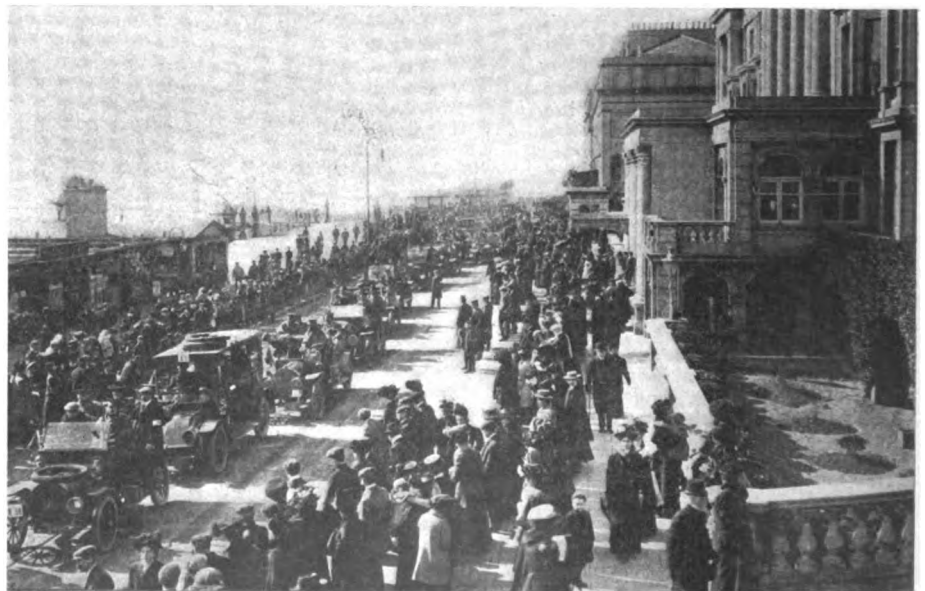

Reo Leads the British Army a Merry Chase.

Reo car at the head of the parade of automobiles, carrying 1,000 soldiers from London to Hastings in the recent military tests of the utility of the automobile in time of war by the British Government.

SOME SELECTED AUTOMOBILE PATENTS

Issue of May 4, 1909.

920,167. Internal Combustion Engine.—John J. McIntyre, Hartford, Conn. Filed Feb. 28, 1907.

In this engine McIntyre has a new cooling scheme, the casing of the air-cooled cylin-

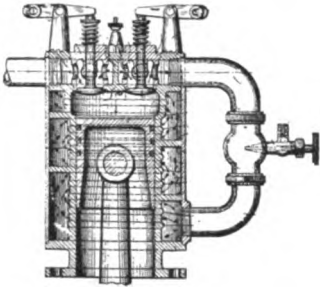

McIntyre's Air Cooling Scheme.

ders, which have extending flanges, being formed into a continuous and circular passage within which the air is circulated. The heated air as it finally emerges from this passage is sent to the carbureter.

920,190. Transmission Mechanism.—Benjamin F. Seymour, Denver, Col. Filed Dec. 12, 1907.

Here is a transmission device, which is capable of being carried out to great limits, thus providing many more speed changes than are now used. And still this is not a friction drive. An immense bevel gear, with

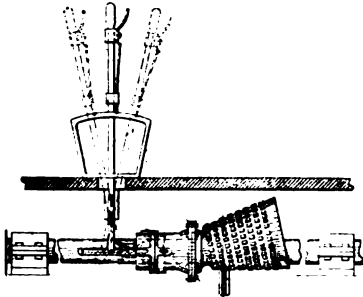

Seymour Multiple Speed Transmission.

teeth cut in rows so as to form a number of different bevels, is in mesh with a regular spur gear. The big cone-shaped gear is slidable, so that any desired combination may be had, thus giving any desired speed. Seymour also has his own method of securing the speed changes.

920,411. Starting Device for Explosive Engines.—Howard C. Bailey, Philadelphia, assignor to Elsie L. Bailey, Philadelphia. Filed July 12, 1907.

Bailey has a scheme here for starting by the pull of a hand lever, which releases a spring and at the same times causes a spark. The spring turns the engine over, and the spark fires the charge then drawn in and

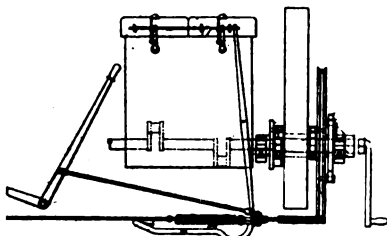

Starting Device by Bailey.

thus keeps it turning over. No means being

provided for correctly timing this spark, it is hard to see how it is to be effective.

920,257. Sparking Plug.—Ralph C. Browne, Salem, Mass., assignor to Browne Apparatus Company, Salem, Mass. Filed April 25, 1903.

920,289. Pneumatic Tire.—James W. Earnhart, Los Angeles, Cal. Filed Sept. 23, 1907.

920,326. Sparking Mechanism for Automobiles.—George S. Hill, Bradford, Mass., assignor to Hill Motor Car Company, Haverhill, Mass. Filed Nov. 20, 1905.

920,363. Transmission Mechanism.—Frank H. Merrill, Plainfield, N. J. Filed Feb. 3, 1905.

920,404. Resilient Hub for Wheels.—Albert E. J. Smith, Battersea, London, Eng. Filed April 3, 1907.

920,486. Vehicle Wheel.—Henry O. Jackson, Chicago, assignor to Jackson Wheel Company, Chicago. Filed June 6, 1908.

920,515. Starting Device for Explosive Engines.—Joseph Zagora, Chicago. Filed March 7, 1908.

920,642. Automatically Governed Carbureter.—Otto Pfander, Brussels, Belgium. Filed March 25, 1907.

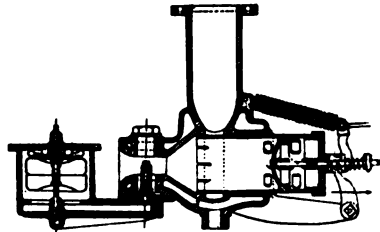

Automatically Governed Carbureter.

This is not as automatic as the title would lead one to think. The automatic part consists in the control of the auxillary air supply. It is so connected up that any variation in the main air supply, by hand operated means is also exerted to change the auxillary air ports automatically. Otherwise the carbureter presents no unusual features.

920,724. Electrically Operated Starting Device.—Harold H. Brown, Boston. Filed July 27, 1907.

Issue of May 11, 1908.

920,916. Control Mechanism. Howard E. Coffin, Detroit, Mich. Filed April 13, 1908.

This is the clutch and change gear control of the Chalmers-Detroit 40, as now

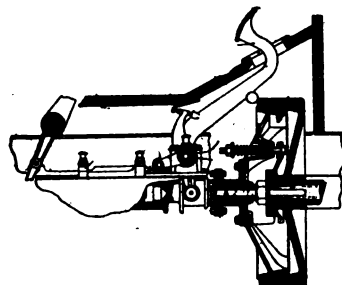

Chalmers-Detroit Control System.

used. The clutch is a cone, leather faced, and its action is interlocked with the speed changes, and the shaft brake on the main drive shaft. The clutch action is also interlocked with the emergency brake lever, so that the application of the brake throws out the clutch.

920,979. Carbureter. Gardner E. Morehouse, Kansas City, Mo. Filed Jan. 25, 1908.

920,984. Vehicle-Wheel Hub. Thomas L. McConnaughey, Hagerstown, Ind. Filed Dec. 26, 1907.

920,989. Combustion-Engine. Oscar P. Ostergren, New York, N. Y., assignor to William M. Power, East Greenwich, R. I. Filed Oct. 15, 1904.

920,991. Valve Mechanism. Harry E. Perreault, Detroit, Mich. Filed Oct. 24, 1907.

921,035. Internal-Combustion Engine. Carl W. Weiss, New York, N. Y. Filed Oct. 14, 1907.

921,078. Speed-Changing Mechanism. Frederick C. Brunhouse, Philadelphia, Pa. Filed Oct. 24, 1908.

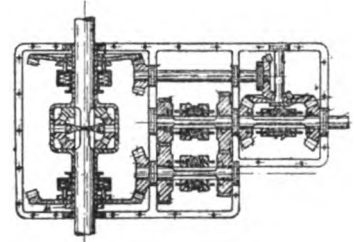

Individual Clutch Transmission.

Brunhouse has here a new way of operating and constructing an individual clutch type of transmission. There are a number of clutches to be operated, too many in fact, as some of them appear needless. The transmission apparently gives more than the usual number of speeds.

921,174. Pneumatic Tire. William H. Snyder, Kenton, Ohio. Filed Dec. 23, 1907.

921,233. Variable-Speed Mechanism. James A. Goodner and Albert P. Kendig, Rocky Ford, Col. Filed Sept. 23, 1907.

921,264. Gas Engine. Cyrus E. Mead, Dayton, Ohio. Filed March 25, 1908.

The recent agitation for rotary valves has stirred up the inventors and one of these, Mead, has an idea which appears to be all right. The two valves for the inlet and ex-

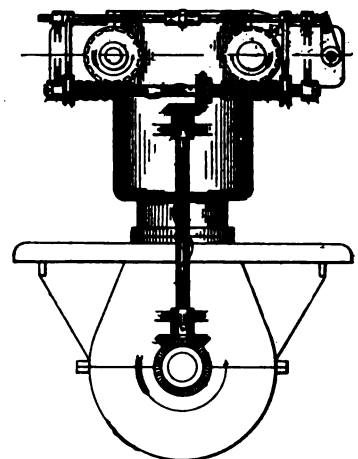

Mead Engine with Rotary Valves.

haust appear to be separate, which is different from the ordinary rotary valve, in which simplification is aimed at and attained by the use of a single valve for both.

921,283. Resilient Wheel. Jean Reuse and Charles Reuse, Hal, Belgium. Filed March 14, 1908.

921,491. Driving Mechanism, for Railway Cars. Rollin H. White, Cleveland, Ohio, assignor to the White Company, Cleveland, Ohio. Filed Sept. 14, 1906.

Information for Auto Users

Air-Tight Steel Tanks for Gasoline.—The action of the more progressive municipalities in specifying that all gasoline must be stored underground, has created an unusual demand for steel tanks suitable for this purpose. The Air-Tight Steel Tank Company, of Pittsburgh, report so large a demand for tanks that even with their large facilities for this class of tanks they have been unable to fill all orders. The equipment which is put out consists of an absolutely air-tight steel tank, made in one, two, three and five-barrel sizes, with brazed joints, no rivets nor solder, a superimposed dome, and fitted with a special lock which rises only a few inches above the ground after the tank has been properly placed in the ground, a supply pipe for filling, and a special pump for drawing the gasoline into the car or boat.

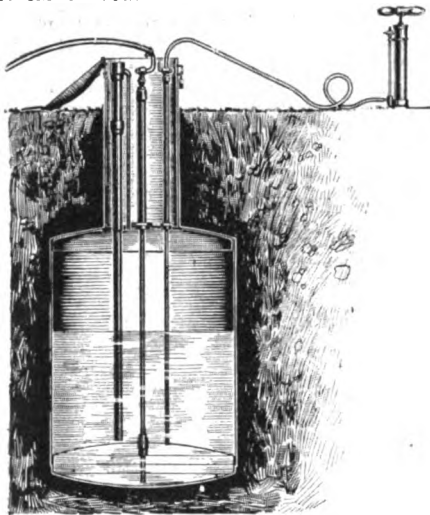

AIR-TIGHT STEEL TANK.

When the tank has been installed and the dome locked, it is not only almost invisible, but there is no odor as with an ordinary gasoline reservoir. For drawing the fuel out, the supply pipe is fitted with a rubber-tube extension, which conducts the gasoline directly into the reservoir. A similar rubber tube is connected with the special air pump, and by the operation of this pump forces the gasoline through. A few strokes of the pump is sufficient to raise a tank full. When this is full, the air in the tank is allowed to escape and as it does the surplus fuel is drawn back into the air-tight tank.

Hydraulic Windshields.—Emil Grossman Company, of New York, is marketing a new type of windshield known as the Hydraulic or Springaction, in which a feature is the set of cylinders and pistons which prevent the folding part from slamming and breaking. On each side of the shield is placed this device, as hydraulic, filled with oil or glycerine, or with a spring, and they operate automatically and positively, according to the makers. When the shield is either up or down, all that is necessary is to start it to the other position and the

spring action does the rest. The procedure is much similar to that of door checks. The frame is made of heavy brass, with a filling-in board of mahogany or walnut. A sub-channel of copper lined with felt forms a cushion for the glass and does away with the rattle. The strip of brass across the middle of the shield at the dividing point is narrow.

Economy Garages.—Inasmuch as the problem of storing an automobile is a pertinent one with the prospective purchaser of a touring car or roadster, the use of private garages has become very popular. The Nicola Building Company, Farmers' Bank Building, Pittsburg, Pa., in a recent booklet issued, gives the details of its "Economy" garages, illustrated by blue prints and colored plates. These buildings are not portable ones; they are ready-made and permanent, fitted together before leaving the factory and giving the buyer only the work of assembling. They are made of wood, raised from the ground on solid supports, and of ample size. A work bench and a tool closet are included.

B. & S. Auto Kit.—A handy kit of tools for use on automobiles is being placed upon the market by the Billings & Spencer Company, of Hartford, Conn. The kit is made up of drop forged steel tools exclusively of the same high quality as, and selected from, the large variety of the machinists' tools manufactured by the company. It is believed that the selection in this kit will reach the needs of the average automobilists inasmuch as there is very little work done upon a car, except perhaps in shop overhauling, which cannot be handled by the B. & S. outfit. A well-made canvas bag is used to carry them, rolled up, and of such size as to fit snugly into a tool box. In the roll are the following instruments: a screw driver, nine inches long; a ball pein hammer, weighing 8 ounces; six full finished general service wrenches, with twelve openings varying in size from one-quarter of an inch to fifteen-sixteenths, by sixteenths of an inch, and if desired some other set of sizes may be

substituted for this one; a six-inch pair of nickel combination pliers; a nickel monkey wrench; three double-end socket wrenches, giving six openings for nuts varying in size from three-eighths of an inch to seven-eighths, hexagon; a tool for pulling out cotter pins; a center punch; and a three-eighths of an inch cold chisel. This shows the comprehensiveness of the outfit, and the inclusion of a set of socket wrenches will be greatly appreciated by autoists who have tried to get nuts loose from difficult places by the ordinary monkey or S wrenches.

Novel Muffler Cut-Out.—Many an autoist has wished for a good cut-out valve, one that is so arranged as to prevent the destruction of the muffler in case of an accidental backfire, and yet is simple and easy to operate. These will be pleased to hear that such a device is now put on the market and may be obtained from any dealer. It is the Clamp valve, made by the Motor & Manufacturing Works Company, Geneva, N. Y. The name is given to it because it may be applied without taking anything off, as the construction is such that it clamps over the pipe. The valve is arranged to open outward, and in the event of a muffler explosion, this will open and allow the gases to escape. Thus, it acts as a safety valve as well as a cut-out valve.

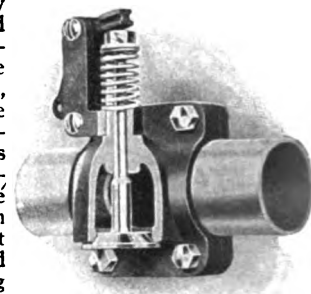

CLAMP VALVE FITTED TO PIPE.

The yoke which carries the lever is free to turn around the valve stem and is then held in the desired position by means of a set screw. This allows of setting the lever so that the pull from the foot pedal is always in a straight line, and obviates the necessity of a pulley in this line. The valve will work equally well in any position, and is designed to meet the requirements of the repair man, or to be used wherever it is necessary to attach a cut-out valve to an engine on which the piping is already connected. It is made in all sizes from 1 inch piping up to 3 inches, and other larger sizes will be made to order. The only work necessary to attach one of these is to cut a V-shaped notch in the pipe with a hack saw before clamping on the valve, which is simply a matter of bolting in place.

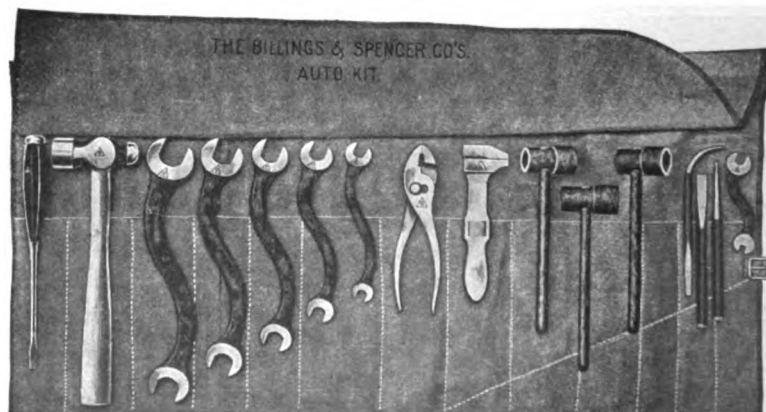

BILLINGS & SPENCER AUTO KIT, WITH A FULL SET OF WRENCHES.

THE AUTOMOBILE

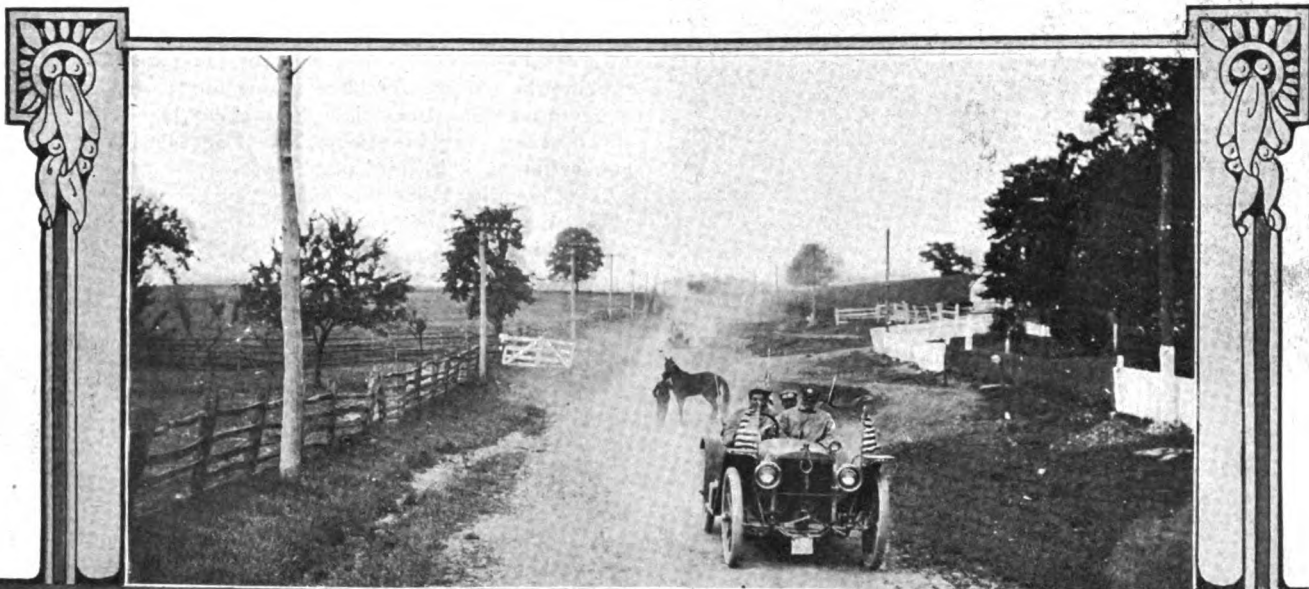

IN TWO DAYS, FROM NORRISTOWN, PA., TO HAGERSTOWN, MD., AND BACK—373.9 MILES

BY G. M. SCHELL

Near Chambersburg, Pa., Where Horses Are Still Receiving Automobile Education—American Leading the Procession.

NORRISTOWN, PA., May 24—Popularity of automobile endurance contests, when the components include a beautiful and interesting course, a good system of computing the abilities of the participants, and a classification which invites the private owner as well as the trade to join, gave last Tuesday and Wednesday, May 18-19, the occasion being the second annual touring event of the Norristown Automobile Club one of the largest lists of any affair of its kind ever held. Fifty cars left this city for picturesque Hagerstown, in Maryland, a distance of 168.1 miles, on the outbound route, and 205.8 on the return. The rules for the manufacturers' and dealers' classes made the test a rigorous one, for it included a time schedule for these classes and the contestants not affiliated with the trade, so that with the technical examination at the conclusion definite winners were secured. T. Warren Berger in his six-cylinder Oldsmobile tourabout and Frank H. Yerger in a Studebaker roadster have been announced as capturing the honors in their respective

SUMMARY OF NORRISTOWN RUN.				
No.	Car.	Class.	Driver.	Points Lost.
2.	Oldsmobile	A-1	T. W. Berger.....	.2
24.	Studebaker	B	F. H. Yerger.....	4.4
32.	American	A-2	G. P. Parker.....	0*
33.	Pierce-Arrow	A-2	P. V. Hoy.....	0*
40.	Elmore	A-2	F. Hardart, Jr.....	0*
41.	Cadillac	A-2	J. E. Lee.....	0*

*Not examined technically.

classes of the real endurance run with the critical inspection, while in the class for club members, who had to keep to a time schedule only, there is a four-cornered tie between George Parker's American, P. V. Hoy's Pierce-Arrow, Frank Hardart, Jr.'s, Elmore, and J. Elwood Lee's Cadillac. Of the

non-contestants, there were ten, and as each one of these finished in good form, satisfactory to the judges, it was given a certificate of perfect performance.

The road conditions were such as to furnish a thorough trial of the automobiles, and the method of arranging the schedule one which made it imperative for the drivers to run more consistently than many are accustomed to doing. Fine State pikes, good but dusty country roads, rough mountain paths, and plenty of climbing over the Blue Ridge mountains featured the route to the famous Maryland town, and valleys whose roads abound in waterbreaks were traversed on the return. The average speed required was either the maximum allowed under the

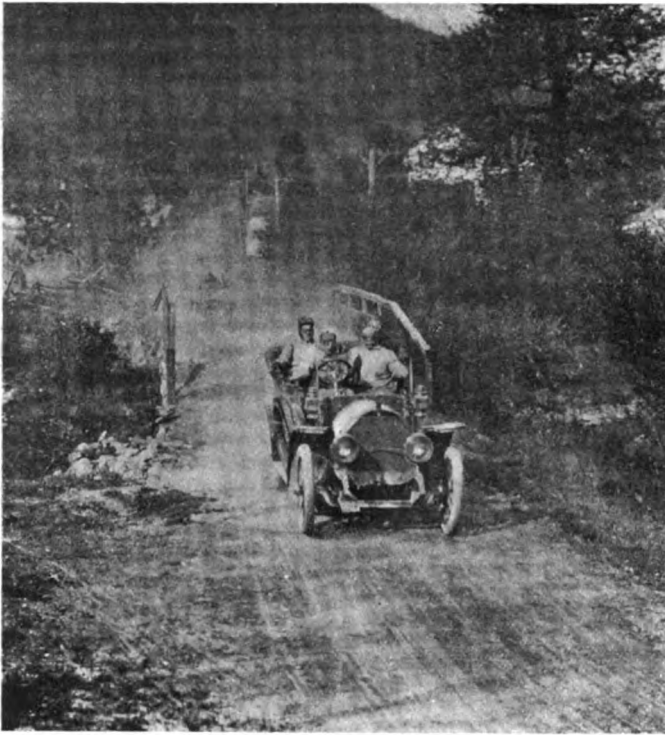

Matheson Third in the Big Class.

law, or very nearly that; and, in addition, there was the stipulation that the drivers were allowed not more than ten minutes' leeway between each control, the remainder of the time being taken up in actually moving forward. This prevented racing, and towards the end of each control very often necessitated a snail's pace. Dry weather favored the contestants, for in many places the roads were such as would have been well nigh impassable had there been rain.

Nineteen perfect scores were held at the completion of the first

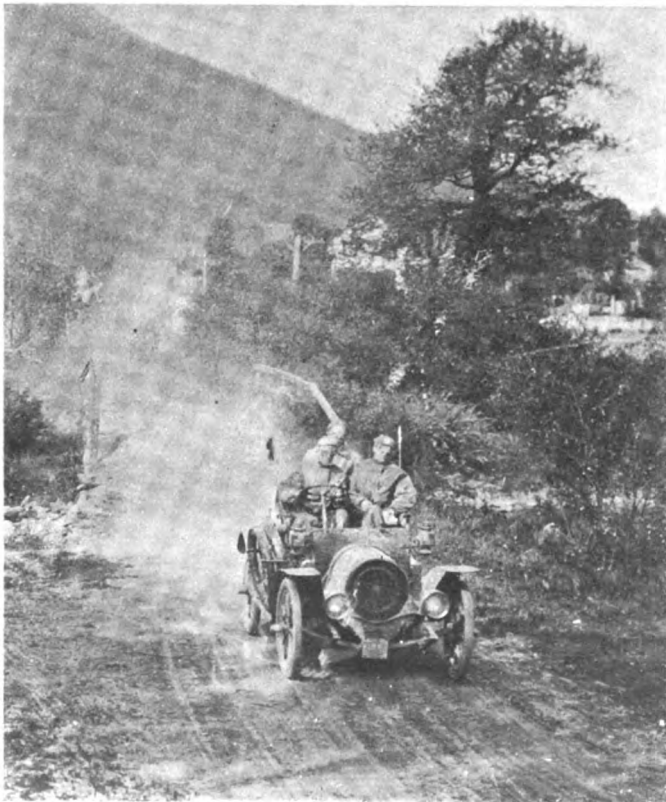

Franklin a Close Second in Class A.

lap out of the thirty-one in the time contesting classes in the morning. Five were eliminated from this list on the second day, so that when the event ended in this city there were eight tied in the main class for touring cars or tourabouts, two among the runabouts or roadsters, and the four in the club members' contesting division. The technical examination was sufficient to make a decided change, however, giving the Oldsmobile the Block trophy, the Studebaker the Club trophy, and the four who claimed equal title to the Contestant's Club trophy arranged to leave it in the custody of the club, with the proposition of competing again for it in the annual contest next year.

Although the technical committee had decided to make no announcements as to the nature of the technical penalties, it became known that the .2 of a point imposed upon Berger was for a loose chassis bolt; that the 4.4 demerits set against Yerger were for loose cylinder nuts and pan bolts; that the 2.1 against Carris, who took second place among the touring cars, was for loose spring clips, leaky sight feed, and a loose chassis nut. A slight looseness of the steering wheel gave Hall's Matheson 4.2 points, putting it in third place, and a loose crackcase bolt and a loose steering connection sufficed to give the Interstate 28.8 and fifth position. Harry Walls' Oldsmobile passed an excellent examination, being penalized only 6.7 points, but a road mark lowered its standing. Of the enormous total of 300.4 against W. T. Taylor's six-cylinder Oldsmobile, all but .4 of a point

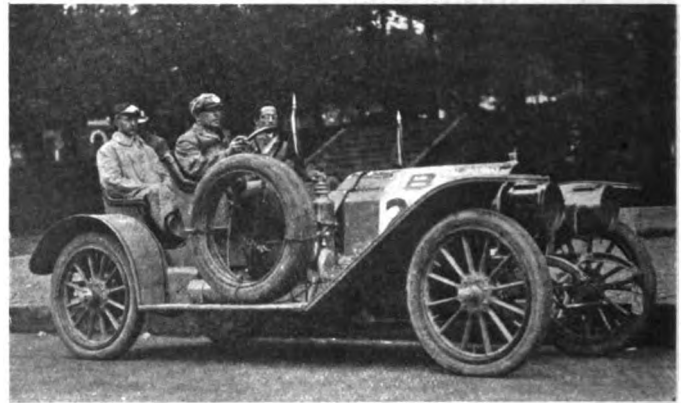

Studebaker Which Captured Class B.

was registered against him for having lost his acetylene gas tank. It was picked up on a long hill below Pottstown and traced to his car in the examination.

Walter M. Cram, whose Mitchell "30" was the only other clean score in addition to the Studebaker among the runabouts, was penalized 37.1 points mainly for a damaged rumble seat and a loose steering connection. Crawford's 18-horsepower Franklin in the same class had 18.6 points against it, but a road penalty put it into third place. A special contest between Van Peacock, driving Perry Gresh's 15-horsepower Ford, and Joseph Graham, in his own car of the same make and model, was declared a draw, for both cars made the run on time and without adjustments of any kind.

En Route to Hagerstown Over the National Pike.

Scenic beauties of the trip had been talked of as much as had the contesting nature, so that the tourists had an additional interest on the run through the southeastern part of the State, skirting the Hundred Mile Woods, in which Washington and his Continental army spent a gloomy winter; then through the fertile Lancaster valley, considered to be one of the richest sections of the nation; bending southward after crossing the long bridge over the Susquehanna at Columbia; through York, civil war country around Gettysburg, right into and over the mountains which had been sighted long before, and finally dropping right into Hagerstown for the night. There was the usual tale of road experiences to be heard, for enough had happened to cause the fading away of a dozen clean record possibilities. A.

LaRoche headed the list in T. W. Twining's Regal, which struck one of the many bad ruts near York and snapped a front spring, an occurrence that is not uncommon to the autoists of that section, and thirty miles further on the other front one went down under the extra strain. A fence rail and a sledge hammer improvised a repair that enabled the Regal to reach all but the last control on time, and during the night a new set of springs were procured, so that the car finished the run on Wednesday without further mishap as a non-contestant. Taylor, in the Oldsmobile, ran out of gasoline in the mountains, a mile and a half from nowhere, and 43 points penalty piled up. The Kissel-Kar lost 29 points, 18 of which was for time lost in consequence of the motor's stalling on a sharp up-grade. Five marks were placed against the midland.

Class B for roadsters and runabouts driven by manufacturers' representatives had a number of its contestants scored upon. The little Maxwell Junior, which made a 3,000-mile non-stop run around Philadelphia during the winter, suffered greatly from tire

while, if for no other reason, through the battlefield of Gettysburg, then up the famous Cumberland valley to the State capital, and across from the Susquehanna valley to the Schuylkill at Reading, thence to the finish. Inasmuch as Hagerstown is right in the heart of the Blue Ridge, it was necessary to do some steep climbing to get out of it. Jack's Mountain was the first encountered, and it was so near the start that a number of the second division cars with a comparatively easy schedule blocked the contestants in the first section who had not gotten an early start, and were wanting to make up time. The beautiful Cumberland valley was nearly obscured to the tourists because of the heavy pall of dust raised by the caravan, varying in color from white to red, to gray, or brown, depending upon the color of the roads, and the cloud was so nearly impenetrable that one machine could hardly get near enough to another to pass with safety. From the capital to the Berks county metropolis, Reading, the run was just a pleasant amble, and the result was that the party reached that city in a bunch.



Route Had Scenery in Profusion—Mitchell Second In Class B Passing the Committee Car.

trouble and caused the contest committee much consternation when it was found that the observer had mixed up his records, and it was necessary to give its score as incomplete. It was driven by W. C. Longstreth. The scores of the two Middleby cars were also listed as incomplete. The Brush single-cylinder runabout, the lowest-powered in the run, driven by D. T. Busse, had to stop at Hanover for seven hours because of a loose connecting rod bearing, but a new one was secured from York. Then the road through the mountains was lost and the car reached Hagerstown just in time for breakfast and to check out on the second day's run. There were loud calls for a more rigorous schedule for the return trip at the meeting of the contestants after the arrival at Hagerstown, and it was decided that the maximum should be given for the run to Norristown.

The checking stations on the outward bound run were established as follows, with the distance between each: Norristown to Coatesville, 29.4 miles; Lancaster, 27; York, 24.4; Hanover, 21.5; Frederick, 39.3; Hagerstown, 26.5; total, 168.1 miles. The running time for division I cars was 8 hours and 33 minutes, and for division II cars was 9 hours and 42 minutes.

Return Through Harrisburg and Famous Valleys.

With prospects for a run of 205.8 miles before them the contestants were lined up at an early hour for the return trip. Again there was scenery ahead which made the run well worth

There was a surprise in store for them, however, in the route between Reading and Pottstown, for the usual one was not followed, and in its stead the cars were taken down through Birdsboro, along the banks of the Schuylkill and of a canal. The road wound around the latter so much, and so many times crossing on short bridges high up in the air, with sharp approaches and still steeper descents, that for a time drivers were worried.

The only accident of the trip occurred to the Kissel Kar soon after leaving the Harrisburg control, when it had a collision with a wagon and a steering knuckle was broken. The driver, W. H. Rodgers, observer Kirkbride and passenger Aschenfelter were thrown out, and Kirkbride lost several teeth, while the others were badly shaken and bruised. They were attended to by the Red Cross party in Paul Huyette's Peerless. W. J. Sprankle's Fiat was one of the first to suffer, a rear axle breaking on Jack's Mountain, causing the withdrawal of the machine from the contest. The four-cylinder Oldsmobile, driven by Walls, had carbureter trouble, which made it late at several controls; and the six-cylinder Oldsmobile, driven by Taylor, lost its gas tank, which told its tale later, although the car had a clean record for the day. The little Maxwell, driven by Longstreth, had another succession of tire troubles, and, with eight punctures, it was seriously delayed several times. The last five miles were finished on one rim and the machine withdrawn. The Midland, Franklin runabout, two Middlebys, and Pope-Toledo were penalized.

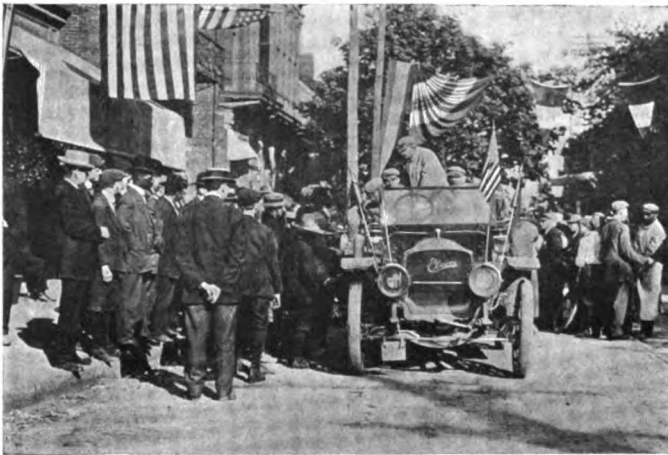

Elmore, One of Tied Four in Club Trophy.

Incomplete scores were given to Detweiler's Overland, Ballard's Franklin, and Miller's Chalmers-Detroit. These were caused mainly by the inexperience of observers, and were considered by many as real reasons for the adoption of rules which would penalize the car appointing the observers rather than the machines in which they rode. The Mitchell driven by Jacob Beideman butted into a curb while maneuvering for the start in the morning and broke a steering cross rod. The car was withdrawn.

The checking stations and distances of the second day were: Hagerstown to Gettysburg, 35.4 miles; Chambersburg, 24.9; Harrisburg, 51.8; Reading, 54.7; Pottstown, 18.5; Norristown, 20.5; total, 205.8 miles. The running time for division I was 10 hours and 20 minutes, and for division II was 11 hours and 45 minutes.

The technical committee took the division I cars in charge as soon as they checked in for the examination, and this was completed on Friday, when the results were compiled and the winners announced. An interesting feature in connection with the trend towards larger wheels was seen in the tire conditions of the winning Oldsmobile, with 42-inch Goodrich tires. These were used throughout the recent grueling test of the Harrisburg club and had covered a large mileage previous to that, and then previous to this one, but the car went through both events without touching the tires, and the shoes do not seem a bit the worst for the wear.

Many women participated in the run, among them being Mrs. J. S. Rex, Mrs. L. E. Taubel, Mrs. S. E. Ballard, Mrs. William Mogee, Mrs. J. F. Boyer, Miss Skillman, and Mrs. Crissman. Lunch was given to the tourists by the Motor Club of Harrisburg and appreciated by the entire party. At Hershey, thirteen miles east of Harrisburg, the cars were pelted with boxes of Hershey chocolate.

The official cars were donated by the following: Pilot, Win-



Reading's Club Generously Supplied Refreshments.

ton, A. E. Maltby; referee, American, Stoye-Vogel Auto Company; red cross, Peerless, P. B. Huyette; starter, Matheson, W. W. Davis; checkers, Autocar, Autocar Company; press, Locomobile, S. deB. Keim.

SUMMARY OF ROAD AND TECHNICAL PENALTIES.

CLASS A—DIVISION I—TOURING CARS—Block Trophy.

No.	Car.	H.P.	Cyl.	Driver.	Road Penalties.			Total.
					1st Day.	2d Day.	Tech'l.	
23.	Oldsmobile	60	6	T. W. Berger	0	0	.2	.2
13.	Franklin	28	4	C. S. Carris	0	0	2.1	2.1
14.	Matheson	50	4	A. D. Hall	0	0	4.2	4.2
3.	American	50	4	Samuel Truitt	0	0	26.7	26.7
5.	Inter-State	35	4	D. F. Templeton, Jr.	0	0	28.8	28.8
10.	Cadillac	30	4	F. L. Paxon	0	0	30.4	30.4
12.	Buick	30	4	C. W. Mann	0	0	37.8	37.8
9.	Oldsmobile	36	4	H. E. Walls	0	39	6.7	45.7
4.	Midland	35	4	E. O. Hayes	5	11	34.6	50.6
7.	Jackson	30	4	W. J. Hayes	0	0	100.0	100.0
8.	Oldsmobile	60	6	W. T. Taylor	43	0	300.4	343.4
6.	Flat	45	4	W. J. Sprankle	0	0	Withdrawn.	
11.	Kissel-Kar	40	4	W. H. Rodgers	29	0	Withdrawn.	
1.	Regal	30	4	A. La Roche	Out	0	first day, broken spring—continued.	

CLASS B—ROADSTERS AND RUNABOUTS—Club Trophy.

24.	Studebaker	40	4	Frank Yerger	0	0	4.4	4.4
22.	Mitchell	30	4	Walter Cram	0	0	37.1	37.1
23.	Franklin	18	4	W. Crawford	0	42	18.6	60.6
27.	Middleby	28	4	E. Smith	Incomp.	48	87.6	135.6
25.	Middleby	25	4	H. L. McCullough	"	97	98.8	186.8
26.	Brush	7	1	D. T. Busse	Broke down	0	first day, but continued after repairs.	
21.	Maxwell	10	2	W. C. Longstreth	Incomp.	0	Withdrawn.	

CLASS A—DIVISION II—Contestant's Club Trophy.

32.	American	50	4	George Parker	0	0	*	0
33.	Pierce-Arrow	50	4	P. V. Hoy	0	0	*	0
40.	Elmore	35	4	Fk. Hardart, Jr.	0	0	*	0
41.	Cadillac	30	4	J. Elwood Lee	0	0	*	0
37.	Pope-Toledo	50	4	Alan Wood, 3d.	0	97	97	97
38.	Mitchell	40	4	J. Beideman	0	0	Withdrawn.	
39.	Overland	30	4	W. H. Detweiler	Incomplete.	0	Incomplete.	
43.	Franklin	24	4	S. E. Ballard	Incomplete.	0	Incomplete.	
45.	Chalmers-Det.	28	4	W. G. Miller	Incomplete.	0	Incomplete.	
35.	Crawford	30	4	A. H. Roop	Withdrawn	0	at Hagerstown.	

* Not examined technically.

CLASS B—NON-CONTESTANTS' CERTIFICATES.

51.	Mitchell	30	4	R. A. Jackson	Perfect.			
52.	Overland	40	4	J. Frank Boyer	Perfect.			
53.	Buick	18	4	Tom Smith	Perfect.			
54.	Overland	30	4	Frank Heavener	Perfect.			
55.	Buick	30	4	F. Hamill	Perfect.			
56.	Locomobile	40	4	H. Beideman	Perfect.			
57.	Locomobile	35	4	Jos. Coulston	Perfect.			
58.	Ford	15	4	J. N. Cassell	Perfect.			
59.	Ford	15	4	H. K. Kalas	Perfect.			
60.	Overland	30	4	W. G. Dyer	Perfect.			
61.	Autocar	28	4	Sewell Crissman	Perfect.			

MATHESON GETS WASHINGTON'S BIG PRIZE.

WASHINGTON, D. C., May 22—No. 13 Matheson, entered by William Orme and driven by W. B. McBurney, one of the Matheson factory experts, has been declared the winner of Class A in the reliability contest of the Automobile Club of Washington, held May 15. At the conclusion of the run, No. 4 Packard was declared by the technical committee to have finished with a perfect technical and road score. Against this decision a protest was filed, making certain allegations, one of which was that the driver of the Packard had to do some work on his car before he was able to start it. This protest was heard by the technical committee and resulted in four points being marked against the Packard for carburetor trouble. This decision was unsatisfactory to the entrant of the No. 13 Matheson, and he protested to the American Automobile Association.

Subsequently the Packard was withdrawn by its entrant, the Luttrell company. The protest of Mr. Orme, filed with the A.A.A., was thereupon withdrawn, and the Class A Trophy was officially given to the Matheson. The mix-up relative to the winner of the top-notch class has caused considerable hard feeling, but it is believed this will be overcome in time.

Wrights Will Fly at White House—In connection with the exercises incident to the presentation of the Aero Club of America gold medals to the Wright brothers, it is possible that they will consent to giving one or two flights on the White House grounds on that date, June 10. The aviators have signified their willingness.



also on the stretch between Crown Point and Cedar Lake. There are two gangs of men at work. The one fixing the road includes thirty teams and thirty helpers, while in the taroid gang are twenty teams and fifteen helpers. In addition there are two scrapers, two steam rollers and a sweeper.

Colonel Sanborn figures out it will take 800 members of the First regiment to patrol the course, and in his plans he calculates on dividing the circuit up into three zones, in which there will be forty-one stations. In the first zone stations 1 to 9 will be included, and also No. 41. A major will be in command and the section will include the grand stand site and also the congested streets of the town of Crown Point. Three hundred men will be needed for this one zone. As many more will be required in the second zone, which will include the district in and about Lowell, with a major in charge. In the third zone the Cedar Lake district will be included, while the other stations will be in the country, the district being divided so that each squad will include eight men in charge of an officer.

The regiment will be moved to Crown Point the night of June 17 and will pitch its camp in the rear of the grand stand. There the soldiers will live during the meet, and it is expected they will add a picturesque touch to the landscape. Each morning they will be distributed at their stations by means of motor trucks, which General Executive Trego is securing for the purpose. Also there will be half a dozen motor ambulances.

The Cobe trophy, a design for which has just been shown, is of an unique nature. It will stand 39½ inches and be of sterling silver. The base is to be of malachite marble, which in turn stands on an ebony base. The base consists of a convoluted section of Ionic design, surrounded by miniature winged motor-car wheels, sprinkled with sprigs of laurel and oak. Ionic plates with appropriate wording appear on the front and reverse of the trophy, one bearing the inscription, "The Cobe Trophy, Western Stock Chassis Race," and the other being left blank for the names of the winners. Above the broad frieze which surmounts the base is an allegorical depiction of the Spirit of Speed, which includes the nude figure of a woman with wind-blown hair, seemingly gliding through space. Her left hand rests lightly on the surface of the urn, while her right arm is outstretched to cleave the air before her. Swallows, with wings outspread, accompany her. Below the mouth of the urn is a circlet of laurel leaves.

Prominent Drivers for Fal-Cars.

CHICAGO, May 24—With the nomination of two Fal-Cars for the stock chassis race in connection with the carnival to be held on the Crown Point, Indiana, course, two drivers of prominence have been added to the lists. E. M. Harrison, who has raced Darracq, DeDietrich, and Mercedes cars in famous English and Scotch races, will be at the wheel of one of the Fal-Cars, and A. H. Pearce, who was well known as a driver of Pullman cars, will have the other. Both Pearce and Harrison are now familiarizing themselves with the circuit and preparing their racing cars. H. R. Averill, the sales manager, has outlined a policy which will keep the new cars before the public.

CHICAGO, May 24—Progress in the promotion of the two road races of the Chicago Automobile Club—for the Cobe cup and the Indiana trophy—is rapid, and there is every reason to believe the events of June 18 and 19 will be huge successes. Rules were completed last week, the Lewis company is hurrying to complete the work of resurfacing the course; Colonel Sanborn has mapped out his plans for the policing of the circuit with the First Regiment of the Illinois National Guard; the sale of seats, which was thrown open to the public this morning, is good; President Cobe has received a wash drawing of his trophy, and the entries give promise of big fields.

Up to this morning there had been received in all nineteen entries, of which nine are Cobe cup candidates and ten are in the curtain-raiser. The last to come in was an Apperson Jack-rabbit, nominated by Edgard Apperson, who names Herbert Lytle for driver. This is one of the two that will run for the Kokomo concern, it being the intention to make the other nomination at the end of the week. The Apperson goes on the same tab that already includes three Buicks, to be driven by Strang, Chevrolet and Burman; two Knoxes, to be driven by Denison and Bourque; two Stoddard-Daytons, with Miller and Englebeck up; and a Fiat put in by E. A. Hearne, who intends driving himself. In addition there are expected a couple of Locomobiles, and perhaps a Thomas little six. Two more Fiats are possibilities. No new entries have been received for the light car event since the two Chalmers-Detroits were turned in last week, but it is expected that a Corbin and a pair of Locomobiles will come to hand before the lists close. The ten in now are the two Chalmers-Detroits, two Stoddard-Daytons, three Buicks, two Marions, and a Moon.

Visitors to Crown Point yesterday found that the work of scraping the circuit has been nearly completed. The new stretch on the north leg is ready for rolling, while three miles of the east leg has been completed. In all, seven miles are ready, except that four miles must be rolled. This is on the east leg, and



President Ira M. Cobe of the Chicago Automobile Club.

Connecticut Reliability Replete with Perfect Scores



Renault Perfect Score Leading the Procession on the Beautiful Connecticut Highway.

HARTFORD, CONN., May 24—Reliability is a term well revered and understood in the central part of the Nutmeg State since the second annual endurance or reliability contest of the Automobile Club of Hartford. The hope of securing definite winners in each of the five classes had led the club to select a course of 213 miles which was considered hard enough to eliminate the usual preponderance of perfect scores, but the reliability of the 26 starting autos was a point previously underrated, for 15 finished with their records clean and there was a winner in but two of the divisions, those for the very smallest run-arounds and for the very largest and most expensive.

Road and weather conditions combined in furnishing a test of real merit, and the drivers will testify as to its rigidity, but nevertheless there was a tie of unusual proportions when the event was completed in the dust of a dismal evening. Outlining in their course the figure of a four-leaf clover, the contestants were sent out of this city four times, each in a different direction, and were sent far enough away to give them all kinds of Connecticut highways, from the fine ones constructed by the State to the poor country roads yet unimproved, and each time bringing them back to the capital so that the interest in this city might be increased five-fold. Rain throughout the trip made traveling rather disagreeable and necessarily more difficult over a route considered strenuous even in dry seasons. These features, therefore, made it all the more of a surprise that there was not a dearth of the clean score genera.

Conducted under the A.A.A. rules, the cars were divided by their selling price, and a running time of ten hours given to the largest entrants, with that for the others arranged upon a handi-

cap basis, so that the average speed required was between 17 and 20 miles an hour. There was a schedule of penalties for road work and for stalling of motors, but there was no technical examination—this not being thought necessary when the route was decided upon. The list of contestants was one that included well-known makes of American cars and one foreign representative. Yet of all there were just two definite winners after the run was concluded, a little Maxwell Junior obtaining an unqualified hold upon its class, for it started with one competitor and finished with none; and the other was the Renault, which captured Class A. The cars which had perfect scores were: Three Ramblers, two Chalmers-Detroit, two Buicks, Maxwell, Knox, Renault, American, Stoddard-Dayton, Franklin, Corbin, Inter-State. The Inter-State has been protested.

A distance of 45 miles was provided for the first lap, passing through New Britain, Meriden, over Southington Mountain, Plainfield and Farmington. By the time that the last-mentioned city was reached the cars had strung out into a line and continued throughout the day, only once in a while getting bunched, for the rules were such that the contestants had to keep pretty well to each individual schedule. Southington Mountain was expected to furnish the first excitement of the day, but it was easy, for the road had been improved, and, in fact, the only poor road of the distance was at the entrance to Farmington, where the ooze was deep. All checked in and were sent away on a run of 57 miles, this time to the northeast, through Manchester, Rockville, West Stafford, Windsor Locks and Windsor. Macadam, sand and clay roads were met with in order and then varied after the first few miles were covered with the

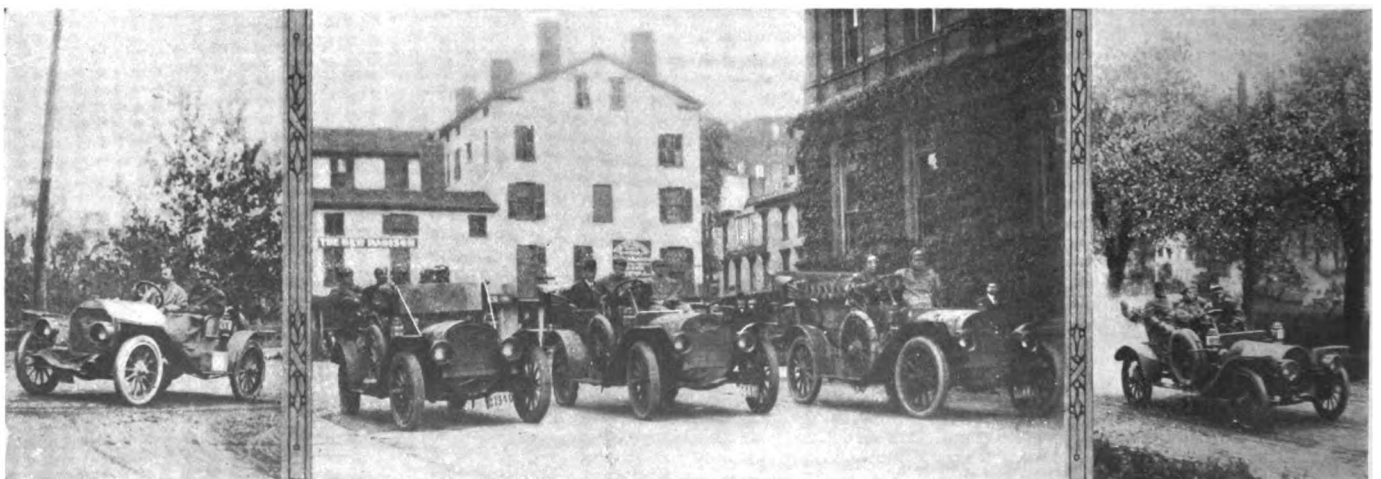

Stoddard-Dayton Checking.

The Trio of Ramblers That Made Perfect Scores.

Six-Cylinder Franklin.

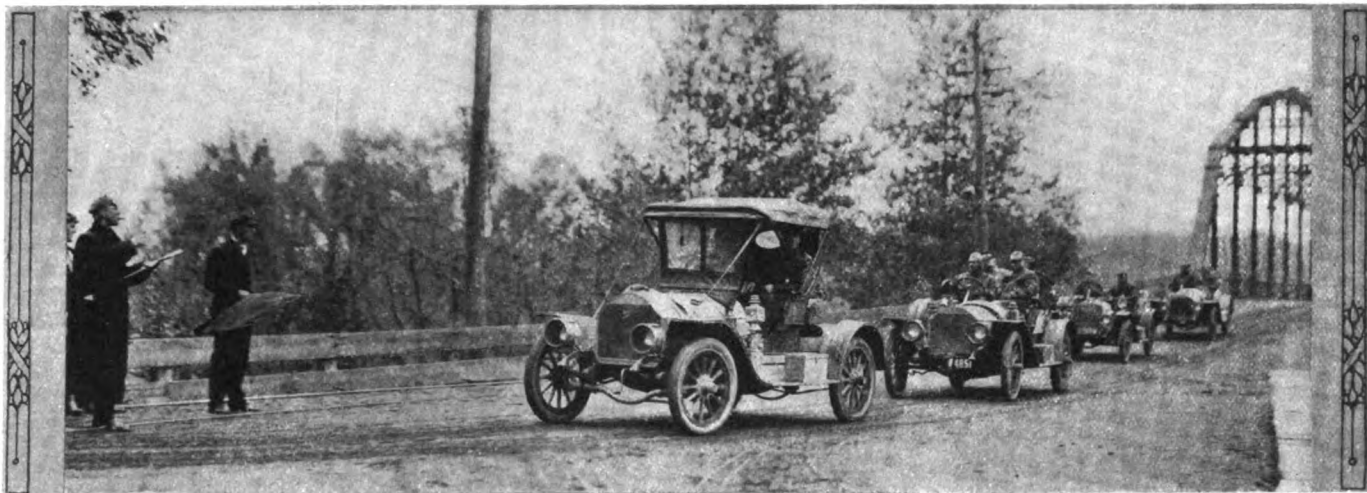

Dennison's Knox, Mertens' Columbia, Goss' Corbin (Perfect) and Reid's Columbia.

mud giving the excitement, for the constant rain had no effect upon the sand. Hartford was made a noon control with a stop for lunch and a chance to take account of stock. In the second control at Enfield the Hon. H. R. Coffin's Columbia, driven by Mertens, was penalized for stopping its motor when it ran out of gasoline and having to renew its supply away from the control. Bourque in a Knox and Lorimer in a Chalmers-Detroit each changed a tire apiece during the morning, but there was a noticeable absence of the autoists' bugbear during the day. Another car joined the party at the completion of the first round, a Jackson, driven by E. L. Lazarro, which should have started with the other contestants. The car was sent around the three remaining laps, but was given no standing, although it made a perfect run at that distance.

The real endurance run of the trip was that of the afternoon, through two laps, the first of which was to Glastonbury, Marlborough, Colchester, Portland and Middletown, a distance of another 57 miles. The rain had made the thirteen Colchester hills very slippery and the whole run was a harder one than those of the morning. As far as Glastonbury there was macadam, but after that sand and clay put forth their best efforts, seemingly to impede the tourists. The little Buick, driven by Hooker, had trouble with its timer and was forced to withdraw, and Dennison accidentally stalled his motor when his foot slipped from the accelerator pedal, costing him one point. Shortly thereafter the Corbin, driven by Goss, took a notion to slide around inasmuch as there were no chains upon its tires, and after twice considering a ditching was brought up straight. Lorimer lost a point by stalling the motor of his

Chalmers-Detroit and Miner's Pierce had ignition trouble which caused a halt and the loss of the clean score. The Mitchell, driven by Smith, had to make a stop for an adjustment to its oiling system and was accordingly penalized. Currier was another to stall his motor, a Columbia, showing that the road conditions bothered even the best of operators by the number which lost control for a moment. A detour was necessary at Rocky Hill, where a new State highway is being built, and the dirt road was used, but it caused no material inconvenience.

"Last, but not least," was the characterization of the fourth lap, one of 54 miles length, taking in the towns of Bloomfield, Tariffville, Granby, New Hartford and Talcott Mountain. The beautiful scenes along the route seemed to be a mockery when looked upon as compared to the road, for after the macadam at Bloomfield was left the cars dropped to the hubs in soft mire. The town authorities had made this worse by recently paring off the edges and throwing the loose turf into the center. The result was that the first car through plowed two deep furrows which every one had to follow, and the tracks grew still deeper until the axles began to level them off. Both men and machines took on a coating of mud, but all pulled through safely in spite of an up-grade a mile and a half long. There was a repetition or troubles, the same ones which were delayed on the third lap, because of deranged ignition or lubricating systems, having to stop on the fourth. Talcott Mountain was a feature of the last part of the day, for the fog was so thick that it was impossible to see more than 100 feet ahead, both on the ascent and then on the coast down into the Connecticut Valley. Reid's Columbia broke an oil valve on the base of his crank case, necessitating a



Rankin's Chalmers Checking.



Harry Hart in His Perfect Score American.



Pierce-Arrow Checking In.

Automobile Gasoline and Other Available Fuel

By Thos. J. Fay

Part VII

CALCULATIONS for compression rarely accord with the actual compression in practice, due in a large measure to a mass of variables that cannot well be reduced to definite values. In the first place, it is very difficult to fix upon the initial pressure, p , which would be 14.7 (nearly) pounds per square inch, were the mixture to enter the cylinders without the aid of a vacuum. Suction is a necessity under the conditions that must obtain if carbureters are used of the class in which a float is present to regulate the flow of gasoline, or if any other method is employed involving piston displacement in the process of inspiring the mixture.

The absolute compression in pounds per square inch will be more or less depending upon the initial pressure, as well as upon the clearance volume in per cent. The curve, Fig. 34, shows the relation between clearance volume in per cent. and absolute pressure in pounds per square inch, taking the exponent "N" as equal to 1.3, in which there is a good chance for error, due to the difficulty involved in calculating for this value.

Exponent "N" Valuable in the Process of Determining Compression—The numerical value of the exponent "N" has been variously stated by the several authorities between 1.20 and 1.40, which difference is enough to assure that the results of calculation will be of small avail in practice. In any case the value of the exponent "N" will depend upon the speed of a motor and as a result it is only possible to calculate for clearance space on a basis, taking into account some one speed. What the clearance space ought to be then is a subject that will remain in the land of speculation to a vast extent, although it will be possible to approximate the same at some one speed of a motor. To find the actual clearance of a finished motor the method long ago adopted by marine engineers will be the most exact, in which the whole space is filled with water and the weight of water required is then ascertained. The water is then spilled out down to the level in the cylinder representing the top of the stroke and the weight of water in the clearance space is then compared with the weight of water left in the cylinder, which latter amount represents the cubical volume due to the sweep of the piston.

In designing cylinders, if they are not too irregular it is possible to calculate the respective volumes with a fair amount of accuracy, but all such calculations should be checked by the water displacement method before the calculations are accepted as final. This will, of course, put a nick in the store of conceit of the average designer, but it is better to do so than to have a large number of motors on the market in which quality is conspicuous for its absence. With a

view to showing something of the ills that will follow errors in calculating clearance it is but necessary to assume a case. If pre-ignition is eminent in a motor at an absolute compression of, say, 100 pounds per square inch, which is a matter depending, (a) upon the completeness of scavenging, (b) the quality of the gasoline, (c) temperature of the motor, (d) various design features of the motor. The curve, Fig. 34, shows that 100 pounds per square inch, absolute compression, will be the result when the clearance is about 20 per cent. of the total volume of a cylinder. Increasing the clearance by 5 per cent. will reduce the absolute compression to about 80 pounds per square inch. An error of 5 per cent. is not impossible in work of this character and if the design is to be with a very high compression, as in certain classes of motors, to run at a high speed, an error of less than 5 per cent. will lead to trouble in all probability.

Taking motors for touring service it is not uncommon to find that the clearance is even as much as 30 per cent. of the total volume and 25 per cent. is a very common figure. When the clearance is to be fixed in the cylinders of a motor it is necessary to consider the factors as follows:

(A) The bore of the cylinders because the leakage factor will change and the loss of charge due to valves and manifolds as well as ports will undergo alteration.

(B) Increasing speed demands a decrease in the clearance space for the reason that the amount of mixture that will enter reduces in weight as the speed increases hence the compression falls off and the results are not so good. Part of this need will be due to ignition trouble in that the rate of flame propagation will be retarded; brought about, to be sure, by a reduction in compression as speed increases.

(C) If the cooling is direct, as in air-cooled motors, the heat transfer is at a higher level and the weight of fuel (mixture) will be reduced due to rarefaction of the mixture so that the clearance should be decreased to compensate for the loss of weight. On the other hand, the heat being higher, the result is that the gas expands more than enough to offset the difference in weight of fuel so that the net situation represents the equivalent to an increase in the clearance space in such motors. In air-cooled work it is not impossible to consider a clearance space of 35 per cent.

(D) In very slow-speed motors, especially for motor boats and in stationary motors, the clearance space should be higher, even 40 per cent. In this class of work the question of ignition does not influence the situation at all, in that there is ample time in which to ignite the charge, and the pistons can be so long with such a number of rings

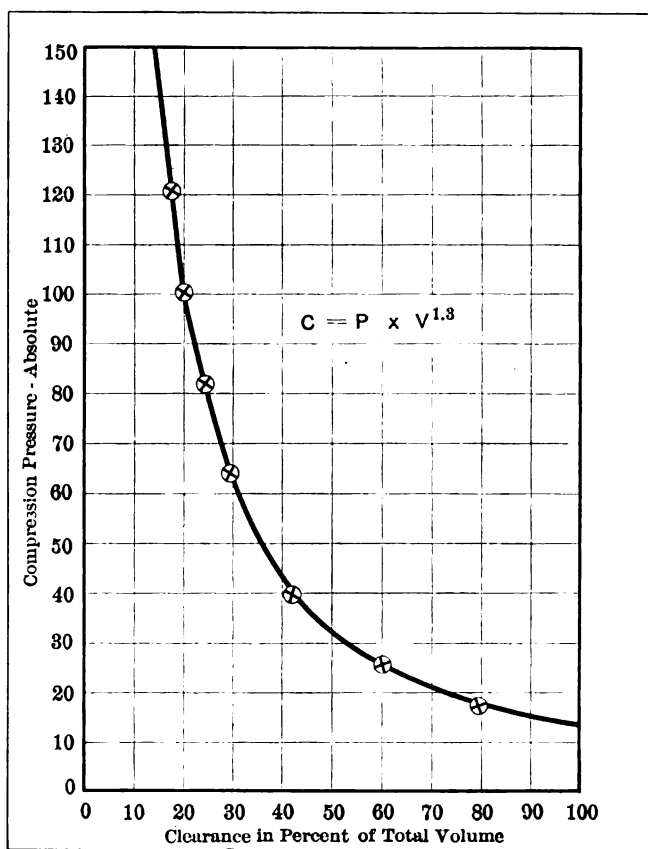

Fig. 34—Curve showing the clearance space for different values of compression when the exponent "N" equals 1.3.

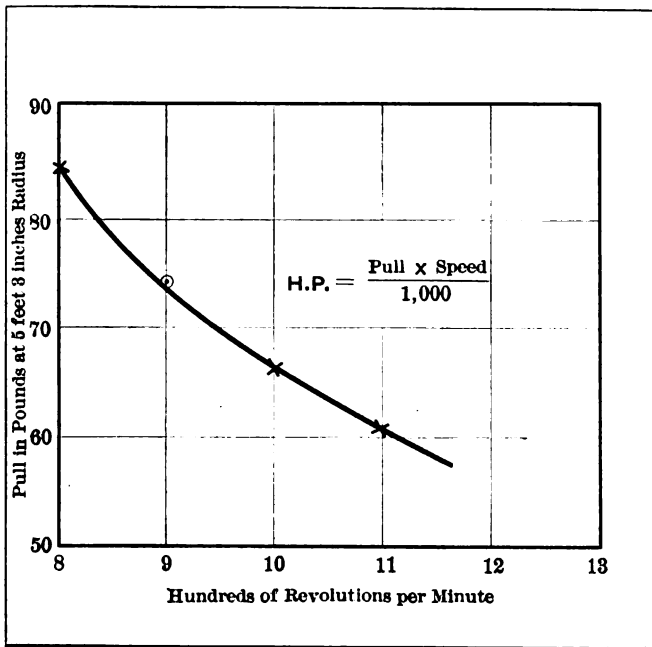

Fig. 35—Curve of torque of a flexible motor used in touring cars in which the speed is relatively low.

that leakage will not be a serious factor; moreover, there will be little or no loss in the ports, manifolds, etc.

This question of clearance space is not to be reduced to a rule that can be applied equally to all makes and sizes of motors and were it possible a means for adjusting the clearance for different speeds as well as for the several other conditions would be an advantage. True were it possible to adjust the clearance it would not be so necessary to adjust the spark under different conditions of speed. Indeed it might be quite possible to dispense with the spark changes were it easy to adjust the clearance instead, and for changing speed.

The fuel problem from all appearances is present in this question of clearance to a vast extent, and if it is true that the best results would follow were it possible to adjust the clearance as the speed changes it is equal to saying that motors have to be designed, taking into account the speed at which the designer intends to realize the most power coupled with such other details of design as will afford the maximum of flexibility.

That flexibility is not present in all motors is too well known to require proof; moreover, this question of flexibility is coupled with the compression more than is generally well understood. Take, for illustration, the larger sizes of racing motors; they are the worst kind of performers at low speeds. Why? The clearance space is much restricted, due to a desire to afford the

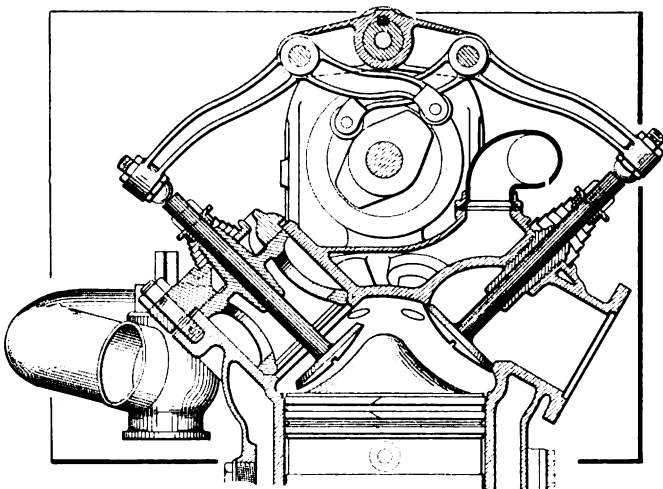

Fig. 36—Depicting a spherical dome contrived to afford the least surface and the quickest means of disposing of the exhaust.

best results from the ignition point of view at the higher speeds. The torque curve as shown in Fig. 28, plainly illustrates an increasing torque with decreasing speed, as against an increasing power with increasing speed. This is quite the reverse to what one would expect as a general proposition, although it is true that the power of a motor is maximum when speed multiplied by torque is a maximum rather than when speed or torque is the highest.

The exponent "N" should be as high as possible, all other things constant, for, as will be shown if a problem is considered, when the exponent "N" is low relatively, the density of the charge will fall off to correspond. In ordinary work it is very likely that the absolute pressure will be as low as 13 pounds per square inch (or even lower) during the suction stroke of the motor with the chance that it will not hold to this value during the whole stroke. In some cases the absolute pressure has been found to be higher, and even 14 pounds might be considered as having obtained in some cases with fine carbureters.

Increasing speed should reduce the absolute pressure during the suction stroke, and if this is true, it is then reasonable to assume that the weight efficiency of a motor will increase as the absolute pressure decreases within certain limits, which is so when the power of a motor increases as the speed increases up to a certain point, during which period the absolute pressure is on the decrease. For a given speed then the absolute pressure should hold to a maximum during the suction stroke, although it is true that the power will be higher if the speed is increased provided the torque does not fall off at a rate greater than the rate of increase of speed as it generally does.

Conventional Formula Involving the Exponent "N"—The exponent "N" was taken as 1.30, which is a good average value in motors if the absolute pressure is 13 pounds per square inch on the suction stroke. If the absolute pressure increases to, say, 14 pounds per square inch on the suction stroke the exponent "N" would fall off and the average value of the same might well be placed at 1.25 or slightly above. For the formula the following will hold:

Let

V_1 = total volume of a cylinder, which includes piston displacement as well as clearance volume,

V_2 = clearance volume of the cylinder, which is the total volume less piston displacement,

p_1 = absolute pressure corresponding to V_1 ,

p_2 = absolute pressure corresponding to V_2 ,

then

$pV^n = c$ = clearance in per cent. of whole volume.

and

$$p_1 V_1 = p_2 V_2,$$

therefore

$$\frac{p_1}{p_2} = \left(\frac{V_2}{V_1}\right)^n$$

and

$$n = \frac{\log p_1 - \log p_2}{\log V_2 - \log V_1}$$

What Practice Would Seem to Indicate—If a motor is to be used for racing, taking into account such conditions as will be indicated by high speed, in which no notice will here be taken of what is generally designated as flexibility, the compression should be very high at low speeds in order that it will be enough at high speeds to well serve the purpose. If, on the other hand, the motor is to do general service, in which flexibility is of the greatest importance, it is then that the compression should be low enough to assure a fair measure of flexibility, which, to be sure, will thwart the performance at high speed. If the motor will not run at a high speed the weight efficiency will not be a minimum and the power (on the higher level of speed) will be that as indicated by a receding torque curve, as shown in Fig. 35. That this is a good torque characteristic for motors that are to serve under ordinary conditions would seem to be true primarily because the flexibility question is in better

shape and the chances of cylinder trouble due to high strains will be reduced. In this case the power was a maximum at about 800 revolutions per minute of the motor crankshaft, which is very different from the performance of the racing motor as portrayed in the curve, Fig. 28, in which case the maximum power was at about 1,800 revolutions per minute of the crankshaft.

Power Corresponding to Torque—In view of the length of the leverarm of the Prony brake, as used in the test of the motor, the curve of which is given in Fig. 35, the formula is very readily determined in the manner as given in the curve, an example of which will be as follows:

When

H.P. = actual horsepower of the motor

P = pull in pounds at 5 feet 3 inches radius = 85

S = speed of crankshaft in revolutions per minute = 800

then

$$H.P. = \frac{85 \times 800}{1,000} = 68 \text{ horsepower.}$$

HORSEPOWER AT DIFFERENT SPEEDS AND TORQUE VALUE

Speed.	Torque.	Speed x Torque.	Horsepower.
800	85.0	68,000	68.00
900	74.2	66,780	66.78
1,000	66.7	66,700	66.7
1,100	60.61	66,671	66.67
1,200	52.5	63,000	63.00

As the curve shows, the power is almost constant for all speeds between 800 and the maximum speed above given, and in the test it was found that the power fell away in inverse proportion as the speed decreases below 800 revolutions per minute and the power decreased as speed increased above 1,200 revolutions per minute. On the face of it there was no use in gearing this motor to run at speeds above 800 revolutions per minute and that the motor would last longer in service at 800 revolutions than it would at 1,200 revolutions is too plain to require any proof at all. The natural inference is that this motor was not well designed; this inference will be sustained by the facts provided a racing motor is in the mind's eye. Obviously this motor was designed with a relatively low compression and with valves so small that beyond a certain point the speed would not increase even with a proper fuel adjustment and with the spark timed for the best results as well as running free.

That a motor such as this would be capable of doing good work without having to place a governor to limit the speed as the load falls off (as it does when the clutch is withdrawn) is one of the points in its favor, and as to the weight efficiency, it was high enough in this case to class the motor as satisfactory on the ground that the weight efficiency was on a basis of 13.3 pounds per horsepower, which is a fair average figure, although it is true that racing motors deliver on a basis of about 10 pounds per horsepower, or even better.

Weight Efficiency Is a Matter of Design—If a motor is to last for a long time in the hands of men of no great skill it follows that the design must take all the conditions into account, and when the fuel, which is the real source of power, is to be used on a highly efficient basis, then the weight efficiency must be high and the life of the motor will be reduced accordingly. This is not a question that will involve the actual transfer of energy from the fuel, for the reason that this transfer can easily be the same in the motors of different weights under fair conditions. In this case then it is a question of the mechanical efficiency of transfer, and as a matter of fact, high weight efficiency may mean low mechanical efficiency as well as an increase in the factor of depreciation.

Designers have their choice between high weight efficiency, with its attending short-

ened life and lower mechanical efficiency, as against a lowered weight efficiency, increased life and, of necessity, increased weight, which may affect the final results to the extent of reducing the ultimate fuel efficiency. In the final sum-up of fuel efficiency it is a question of "ton-miles" per gallon of fuel or per pound of the same. If the motor is heavy and the car is on the same basis, it is a moral certainty that the load that the car will carry will be reduced accordingly. On the other hand, if the motor is light and the car is along the same lines, it is more than likely that the safe load on the car will be limited. In any design then, taking into account the fuel, with the idea of realizing the greatest result per pound of the same, some standard must be established such as will represent all the conditions that go to form good success.

Strike a Balance Involving a Happy Medium—In all probability the conservative course lies in a design that will embody enough weight to do the work for a long time, which time should be related to the first cost of the car as well as the actual service that it will render so that the "burden" a car will safely sustain under is an important detail to be taken into account. The actual

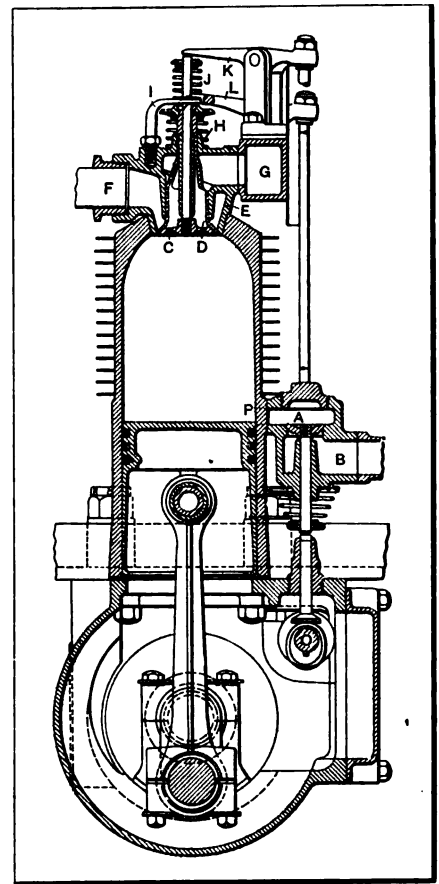

Fig. 37—Franklin air-cooled motor, presenting a spherical dome and concentric valves, as well as an auxiliary valve for the quick elimination of exhaust products.

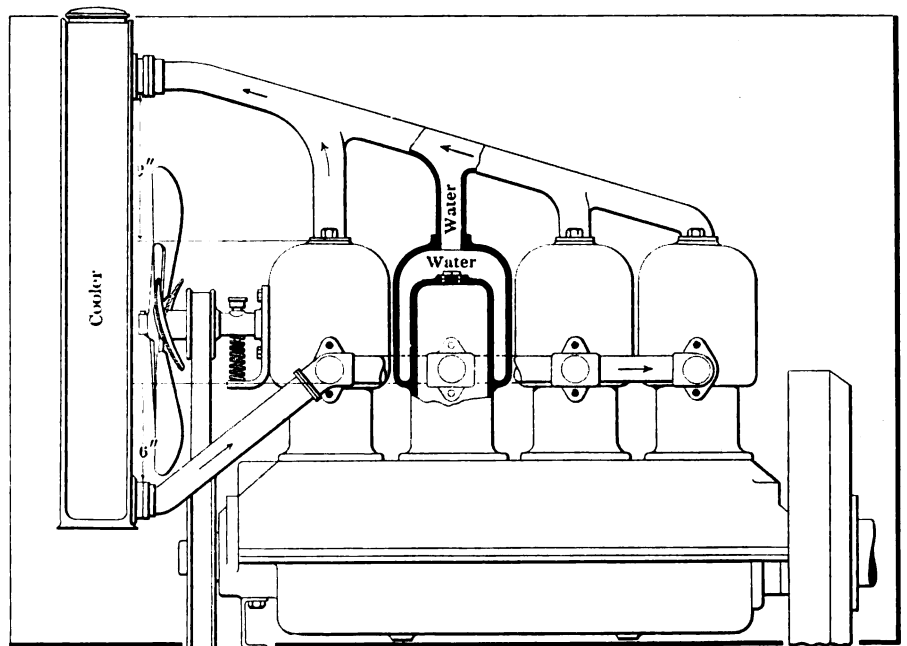

Fig. 38—Thermo-syphon system in which the boiling jacket-water influences the thermal efficiency of the motor.

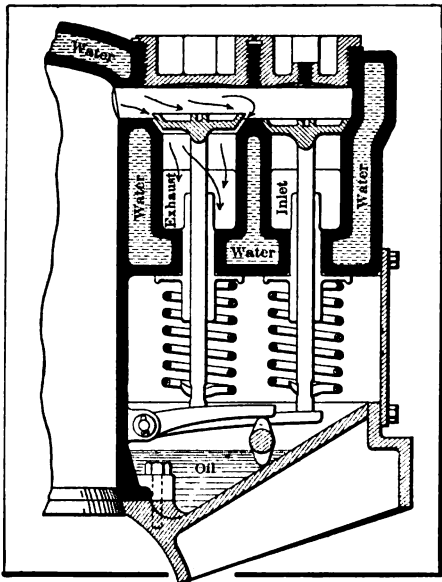

Fig. 39—Valves in lateral tandem and spark-plug over the intake, adjacent to the heated exhaust valve.

in the absence of other important considerations. Take, for illustration, the shape of the combustion chamber; there is no denying the contention that the results can be influenced thereby. The least surface for a given volume will be due to a spherical contour. That the surface should be the least possible is generally conceded on the ground that the losses to the water-jacket will then be reduced to the lowest possible point.

A spherical head demands the location of the valves in the head of the motor and this is probably the best reason why some very efficient racing cars are provided with motors in which the valves are in the head, one of which is illustrated in Fig. 36. In this case the piston head is probably not in accord with the rest of the design, but this is a detail outside of the main question, for the reason that the piston is not water-jacketed, and the losses to the water-jacket are not therefore involved.

The same idea is embodied in Fig. 37 of the Franklin (air-cooled) motor, only that in the Franklin the piston is in accord with the main theory and the valves are so designed that the combustion chamber is almost a true sphere. The fact that the Franklin is air-cooled makes no inroad on the accuracy of the main conclusion for the very good reason that all motors are air-cooled (some of which, direct, as in the Franklin, and the rest are indirect, as in the water-cooled examples). The losses to the cooling medium must be taken into account in any case and, as before stated, if the surface is small the amount of heat that can pass off will be reduced in consequence.

In the Franklin motor it will be observed that the valves are in a concentric nest, and referring to the illustration, Fig. 37, *A* represents an auxiliary valve which is a great aid in scavenging the motor and the exhaust leaves through the port *P*, passing off to the pipe *B* and thence to the muffler. The main exhaust valve *C* is provided with a seat by the intake valve *D* and the exhaust passes off to the manifold *G* while the intake is shown at *F*. The exhaust valve is mechanically operated by the arm *K* and the spring *J*, while the inlet valve is mechanically operated by the arm *L* and the spring *H*. The bent arm *I* serves to resist the pressure of the spring *J*. That the fine performance of the Franklin is largely due to the valves provided is assured, and the auxiliary valve is regarded as of the greatest utility in air-cooled work. The idea, while it takes into account the question of scavenging, is most important from the point of view of disposing of the heat in the shortest possible time.

Differences Due to Methods of Water Cooling—It is common to claim that the water as it is led to the water-jacket of a motor should be entered at the hottest part in order to enable the

fuel efficiency of automobiles will best be known by performance under ordinary road conditions rather than as the result of special economy trials, yet even so special efforts lead to knowledge of the requirements and designers are enabled to make improvements when they know what to improve.

Some Details That Influence the Situation—Mixture alone, or even the best mixture and the most suitable compression will fall short of the requirements

water to absorb the greatest amount of heat of which it is capable in the short time allowed. This idea is a good one up to a certain point, although it is contrary to the idea of maximum thermal efficiency because the greater the difference in heat the more will be the loss to the water-jacket. In the thermo-syphon systems the water is handled in the manner as shown in Fig. 38, and as will be observed, the boiling water is allowed to raise directly above the dome of the combustion chamber thence away to the cooler. That the water does boil and that steam does form above the combustion chamber is a matter that will be easy to prove in many cases at any rate, and that the thermal efficiency is increased thereby is a moral certainty. The thermo-syphon system is in the nature of a middle practice between the direct and the indirect methods of cooling, and since both the direct and the indirect methods work in practice there is nothing to prevent the thermo-syphon system from serving well the purpose rather with the expectation that the result will be as a happy medium between the two.

From the fuel point of view these matters have to be taken into account on the ground that it is the fuel problem that dictates the cooling rather than the mechanical problem. Lubricating oil is now to be had of a character suitable for use under the most severe conditions, from the temperature point of view, so that, as before stated, it is the fuel question that influences the major effort in the cooling problem.

Location of Spark Plugs Must Be Considered—There are two sides to this question, in that the mixture must be suitable for the purpose as well as it is true that the ignition system must be of the greatest possible efficiency. For the present it is the mixture phase of the subject that will be treated. Since the mixture is not equally homogeneous in all parts of the combustion chamber, leastwise in motors in general, it is a fair inference that the spark plug should be located in the zone that will afford the greatest uniformity, for then the results will be the most satisfactory. Fig. 39 shows a design of cylinder in which the inlet valve is placed outside of the exhaust valve on the same side of the cylinder, and as will be readily understood, the mixture comes in and passes over the heated exhaust valve so that while the exhaust valve is thereby cooled it is also true that the mixture is heated up at that point and it becomes very inflammable as a result.

In cylinders of this design it was found that the spark plugs worked very much better over the inlet valve than they would when placed over the exhaust valves. This was found to be true after repeated trials with the spark plug in the respective places at different trials and the only way to account for the difference is to assume that a more uniform mixture is to be had over the inlet valve with the possibility that the close proximity of the heated exhaust valve has an influence for good. All of these questions of the location of the spark plug take into account the question of scavenging, for were the cylinders completely emptied of the exhaust products, it is highly improbable that the location of the spark plug would be a matter of such great moment.

There is one other phase of this question, although it is but a variation of what has already been stated. If the carbureter is an imperfect device and if liquid gasoline enters the cylinders of motors the spark plug should not be located in a highly heated zone, for then the coking process will take place in contact with the nodes of the spark plug with the result that the plugs will soot up. When the spark plug is in a pocket on one side of the combustion chamber it is probable that the coking process is sufficiently isolated from the spark plug to enable the same to perform its functions without sooting up.

Since water is one of the products of combustion and in view of the short-circuiting effect of a drop of water on the nodes of the spark plug, it is also desirable to locate the same out of the zone of direct and intense combustion rather with the hope that water will not form on the nodes. This question of water interfering with ignition will stand some more investigation.

(To be continued.)

Some Further Ignition Hints

By
MORRIS A. HALL

A QUESTION often asked relative to the popular use of storage batteries for ignition purposes is, is this popularity deserved or not? In their favor it must be said that they do the work and do it well; even enemies will admit that. But it is a fact that the general automobiling public do not understand the action of a storage battery, and as a result those who shun its use are numerous. So, it will be an excellent idea to look into its action and see wherein it is simple and where, if at all, it is complicated.

First of all, it will be necessary to say that in what follows much is described which pertains to storage batteries for the propulsion of cars and other heavy work, rather than for the lighter simpler work of gasoline ignition. The excuse is offered, however, that in principle and in action all storage cells or accumulators are alike, so that a description of one is a description of all of them.

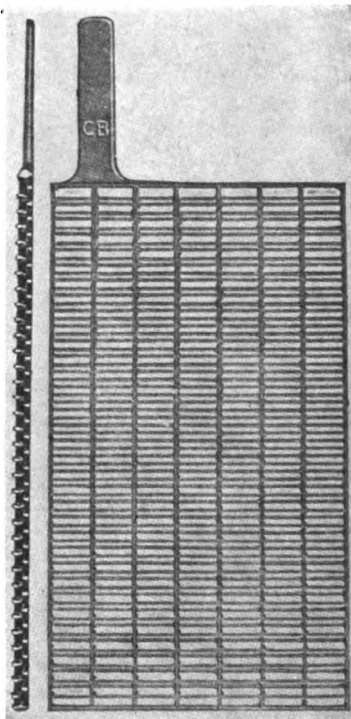

Staggered Positive Battery Plate.

Primarily, the action of generating a current in a storage cell is a chemical one, so any explanation of the internal action must go into the chemistry somewhat. Ordinarily, the lead battery is used, in which lead in two different forms is used for the two electrodes. These electrodes are placed in dilute sulphuric acid which attacks the lead, with the result that a lead sulphate is formed and the acid reduced to water or atoms of free hydrogen.

The water used should be pure distilled water and should not be poured into the acid. The proper method of procedure is to pour the acid into the water. The influence of a small addition of acid to water is very small, practically negligible, while adding water to a body of concentrated acid, sets up a chemical action which is liable to be a violent one,

the heat liberated by the action in this case being very great.

The Fundamental Battery Equations—This fundamental action is best expressed in the form of an equation, or more correctly, several equations, which represent correctly the action taking place in the battery. Thus we have:

Charge

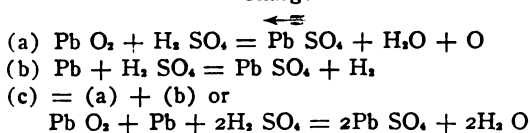

Discharge

in which (a) is the reaction at the positive plate, (b) the action at the negative plate and (c) the combined effort or the fundamental equation of the lead storage battery. This equation shows

that on charge, both electrodes start as lead sulphate, Pb SO_4 , and combining with the dissociated gases of the water in the electrolyte, at the negative plate, turn into lead, and at the positive plate into lead peroxide, respectively. Also, the SO_2 is re-

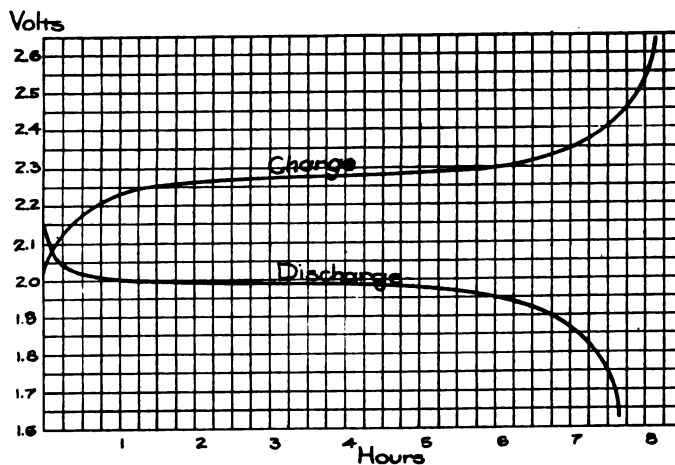

Typical Diagram of Charge and Discharge.

leased which combines with the water in the electrolyte to form sulphuric acid, $\text{H}_2 \text{ SO}_4$. Reading from left to right for the discharge, as indicated by the lower arrow, it is seen that the action is the change of lead and lead peroxide, respectively, on the negative and positive plates, into lead sulphate, and the reduction of sulphuric acid into water.

This, of course, represents only the initial and final reactions, as scientific men have never been able to prove or even agree upon the various intermediate reactions. Among the products said to be formed, each having somewhat of a following, are: Persulphuric acid, $\text{H}_2 \text{ S}_2 \text{ O}_8$; perplumbic acid, $\text{H}_2 \text{ Pb}_2 \text{ O}_7$; hydrated lead peroxide, $\text{H}_2 \text{ Pb}_2 \text{ O}_6$, and many others. Without going into this matter, which at best is beyond the scope of this paper, it will be sufficient to say that this action, although chemical, produces an electric current and it flows, when the two terminals of the positive and negative plates are connected by means of a substance, which is a conductor of electricity. These are usually copper wires, but the terminals of the battery itself are usually wide strips of lead.

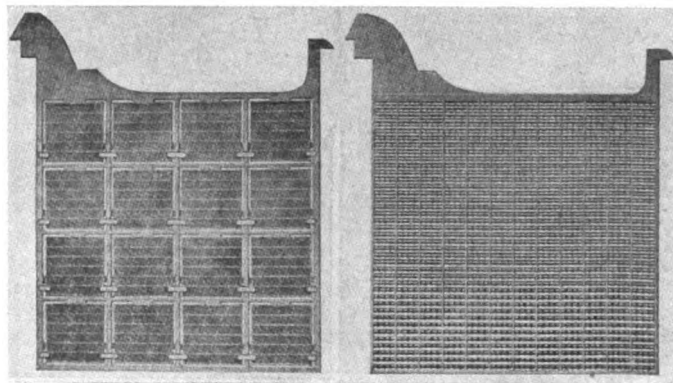

A Comparison of Ordinary Positive and Negative Grids.

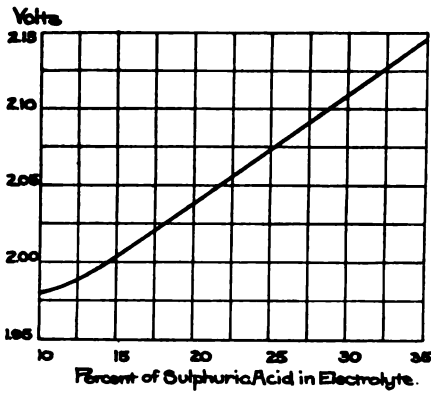

Adding Acid Increases Density.

There are three necessities in battery plates, which cause the varied use of substances differing so widely as those found on commercial examples. These three are: Strength, rigidity and high conductivity. Strangely enough, no one of the active materials now in use possesses a

single one of the qualities enumerated. Lead, spongy lead and lead peroxide are in very general use and no one of them possesses any one of the requirements mentioned.

This means that battery plates must be made in two parts, the active material, which does the work and produces the current, and the rigid framework, called a grid, to which the material is added, and which possesses the required qualities. The rate of current flow at which the battery may be discharged depends upon the area of the surface on which the electrolyte acts. This area may be large or small, but as a high-flow rate is very desirable the area is made as large as possible. The active area is measured in square inches and is the product of the length times the breadth times two, because both sides are active. This is for one plate, and must be multiplied by the total number of positive plates.

Unit of Capacity Defined—The usual or standard unit for measuring capacity is the ampere hour, the product of the rate of discharge (previously spoken of as the rate of current flow) by the time which the battery takes to discharge at the standard rate 1.8 volts. Units of capacity vary with the rate of discharge, the unit being less at a rapid rate than at a slow rate, although the contrary might be thought to be more reasonable. The eight-hour rate is normal, that is to say, this is the usual time in which the battery will discharge its rated current without falling below the set figure of 1.8 volts. As an example, a battery rated at 80 ampere-hours will discharge 10 amperes continuously for eight hours without falling below 1.8 volts.

Electromotive Force, abbreviated E M F, is defined as the electric pressure or difference in potential between two points, in this case, the positive and negative electrodes, causing

current to flow. Now the sulphion SO_2 is abstracted from the electrolyte on discharge as the fundamental equation shows. If this were carried to extremes, and all of the SO_2 taken, then only water would be left, and the E M F would be but 1.46 volts. But SO_2 is actually only taken from the acid where it is in contact with the plates. As it is removed the density is decreased, which causes circulation, thus allowing fresh acid to take the place of the exhausted. The chemical action is quickest in the minute pores of the plates, where the circulation is most difficult. When the cell is allowed to stand these minute areas are flooded with fresh electrolyte and the voltage will rise a very marked amount. The foregoing is the explanation of the recuperative power of a storage cell, which allows the voltage to rise after discharge has taken place, if the battery be allowed to stand on open circuit for a few minutes.

Success Requires Many Things—The principal requirements of a satisfactory storage battery are many and total at least seven. These are:

(1) The arrangement of the grid and actual material must be such that the current flows equally through all parts of the plate. This requires that the resistance be the same from any two points to the lug, which is obviously impossible theoretically, but in practice is approximated.

(2) The construction of the grid must be such as to allow of expansion and subsequent contraction under the heat of charging and discharging. As the source of most of storage battery trouble this has been given much thought without remedying the trouble. One could almost say that this requirement is impossible of attainment. The expansion on formation, or charging as it is called, is very great.

(3) Fastening of the active material to the grid is most important as is also the electrical contact at the lines of fastening. Usually both are good at first, but on subsequent expansion the electrical contact is lost first, resulting in the ultimate loss of any actual contact. When that happens the battery is useless.

(4) Construction of the grid should be such as to resist the corrosive action of the acid. While practically impossible, the material is so selected and proportioned as to last as long as the active material, so that in replacing the latter it is easy to also replace the former.

(5) Local action must be prevented, which is done by making the grid of such a material that no action is set up between the plate and the active material. In many cases sheet lead is used and serves well the purpose.

(6) Provision must be made for the circulation of the electrolyte, this being fully as important as any of the foregoing.

(7) Last but not least, the active material must be so disposed as to present the greatest possible surface to the acid.

As of interest and pertinent to the subject, a number of different grids are shown. The usual shape is nearly square, but in some exceptional cases it is desirable or necessary to have a long or narrow shape. With this, the depth of the acid assumes a more important place than in the case of the ordinary plate. As of equal concern to the novice, all of the parts of a storage cell, built primarily for sparking purposes, are shown, even to the hard rubber jar, and the wooden box which encloses the whole. Another illustration shows a different sparking battery assembled but with a corner cut out to display the manner in which the parts are correlated when ready for use.

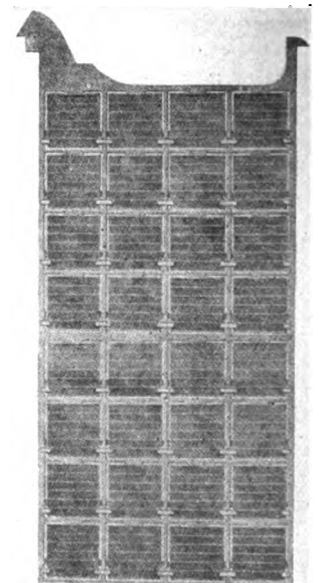

Sometimes the Grids are Made Long.

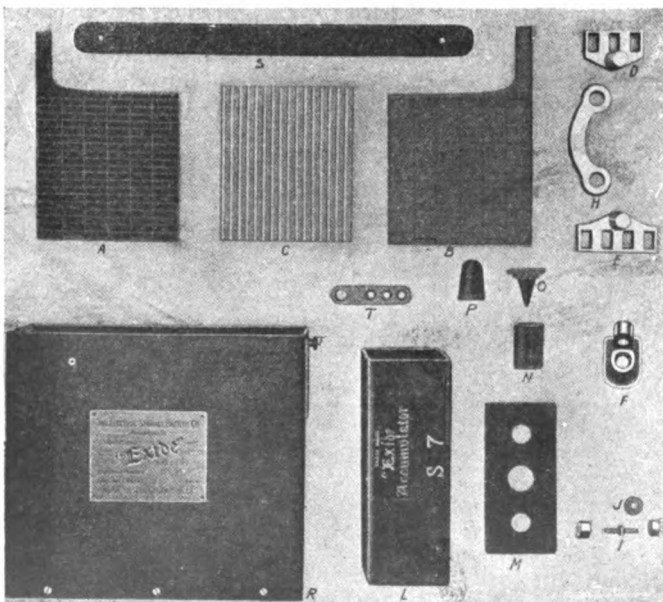

Complete Set of Parts of Sparking Battery Dissembled.

To contrast with these, a full set of cells for car propulsion is shown, connected up ready to be put in place. These show little of the internal construction, but give a good idea of the size and space necessary for a vehicle's motive power.

Charging and Discharging Display Peculiarities—In the first diagram is shown the phenomenon of charging and discharging, represented graphically. From this it will be seen that the two operations are by no means the reverse of one another. On charge, beginning with two volts, the current rises rapidly in the first hour to 2.25 volts, from which the increase is more gradual during the ensuing time up to about the seventh hour.

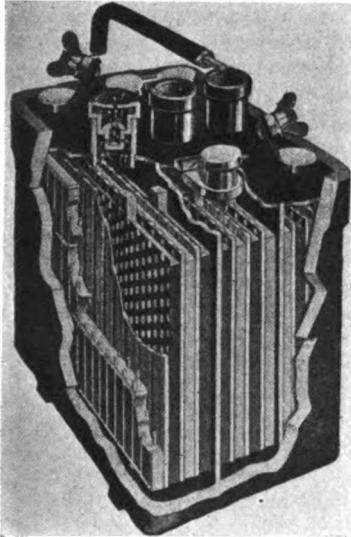

Battery Cut Open to Show Construction.

At this time the cell is nearly charged, and the voltage rises with great rapidity to 2.65, during which latter rise much care must be exercised else the battery will be overcharged with consequent damage.

Upon discharge, an entirely different set of results are met. Commencing at a high voltage of 2.15 the drop within the first fifteen minutes is very noticeable. After this it is more gradual up to the end of the first hour, beyond which it assumes a very slow, gradual drop to the end of 5½ hours. At that time the drop becomes more pronounced, and beyond the seventh hour must again be carefully watched else the cell will be drained down below a healthy point, causing damage which cannot be repaired, at least not readily or without proper facilities.

Storage cells exhibit a number of peculiarities, some of which are very interesting. For instance, if a cell is fully charged and then allowed to stand for a long period without being used, when put into use and discharged the voltage does not begin with a decided drop as in the ordinary case, but on the contrary rises for nearly an hour and a half. Beyond this point, however, the drop is more sharp than in the ordinary case, at least for the middle period. At the end of the discharge the drop is much less rapid than in the case of a cell which has not been allowed to stand, fully charged, before using. This condition is shown in one of the curves, and persists through several alternations of charge and discharge, before resuming a normal condition, such that the voltage at the beginning of discharge is high, falling off rapidly during the first few minutes.

A second peculiarity is even more strange. When a cell is used and allowed to stand, it recuperates and, as spoken of above under the heading of electromotive force, the action is a sharply defined one. At any rate, a large amount of additional current may be obtained without damaging or destroying the

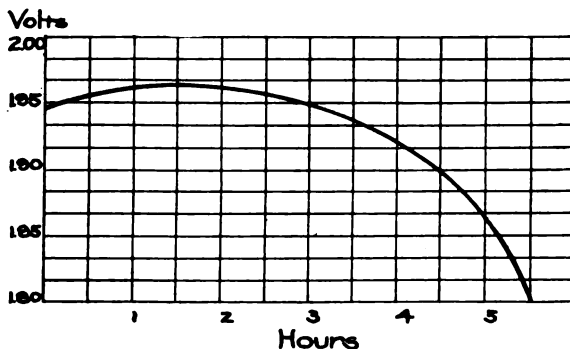

Cell Which Has Stood for Some Time, Fully Charged, Has a Peculiar Discharge Curve.

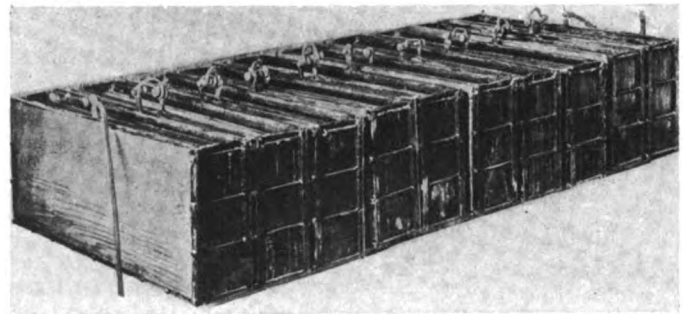

Electric Car's Power Plant Ready to Be Put In Place.

cell. If now, the cell, in the first instance, be discharged very rapidly, allowed to stand, and used a second time, the recuperative current will be very large, so much so that the total of the first and second discharges will be far in excess of the summation of the two in the first or more ordinary case. In other words, by discharging at an initial high rate, a greater total amount of current may be obtained from the battery. This method of increasing the amount of current flow is to be deprecated, as a high flow rate usually warps the plate, causing subsequent current loss as brought out under requirement three.

Current Varies with Electrolytic Density—It is a well-known fact among storage battery men that the voltage of any cell may be and is, influenced by the density or specific gravity of the acid solution, also, as a matter of fact, by the internal resistance and the temperature. Considering the two latter as fixed the output can be increased by an increase in the density of the electrolyte. This is done by adding a larger percentage of acid. The specific gravity of pure concentrated sulphuric acid is 1.850. As this is weakened by the addition of water, the density falls and the normal figure is about 1.250 for a fully charged cell, which decreases to about 1.150 on discharge. The curve shows how the addition of acid affects, favorably, the voltage.

There are a few general pointers which may be given to drivers who attend to their own storage batteries. The density of electrolyte, just mentioned, should be kept low, for this prevents sulphation. The temperature coefficient is negative, the resistance increasing with increased temperature, and decreasing with a drop in the thermometer. The electrolyte should be of acid made with sulphur and not from pyrites, as the latter is liable to contain injurious substances.

Mechanical Current Generators More Popular—While persons using storage batteries soon get into the habit of gauging the time of a charge, and planning forward to having it recharged at such a time as to keep the car out of commission the shortest possible length of time, the mere necessity for constant recharging has prejudiced many against it. Among these a form of mechanical generator is preferred for its ability to furnish current as long as the engine runs.

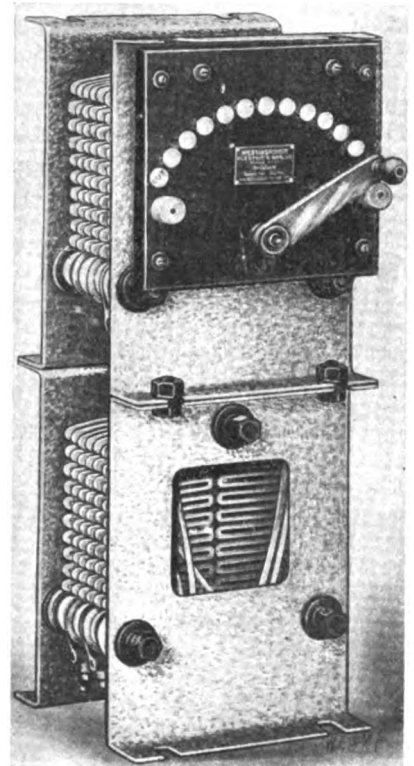

Storage Battery Charging Rheostat for Direct Current.

Compact Dynamometer Embodies Distinctive Principle*

By Prof. Wm. H. Kenerson

THE author has received from time to time many requests for a simple transmission dynamometer, and has himself often felt the need of one which would be more generally applicable than those now in use. These continued requests, together with the requirements of a definite problem whose solution demanded a rigid transmission dynamometer in the form of a coupling, led to the design and construction of the instrument described below. The accompanying illustrations show the construction of the dynamometer and its method of application and use. In Fig. 1 and

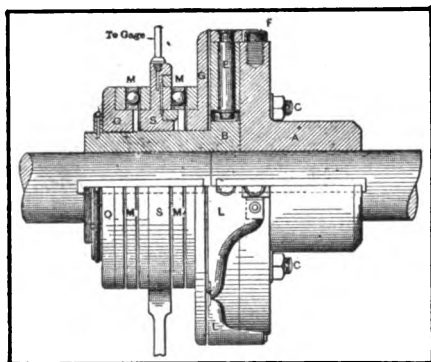

Fig. 1—Dynamometer shown in section.

Fig. 3 the corresponding parts of the dynamometer are given the same letters and are referred to in the body of the text. The couplings *A* and *B*, each keyed to its respective shaft, are held together loosely by the stud bolts *C*. The holes in the flange *A* are larger than the studs *C*, so that these studs have no part in transmitting power from one shaft to the other. The power is transmitted from *A* to *B* through the agency of the latches *L*, four of which are arranged around the circumference of the flange *B*. These latches are mounted and are free to turn on the studs *E*. The two fingers of the latches engage the studs *F* on the flange *A*. On the ends of each latch are knife-edges parallel to the stud about which the latch turns. For either direction of rotation of the flange *A* the latches *L*, which are in effect double bell-crank levers, will exert a pressure on the disc *G*, tending to force it axially along the hub of the coupling *B*, and this pressure, it will be seen, is proportional to the torque.

Between the end-thrust ball, or roller, bearings *M M*, is held the stationary ring *S*, which is the weighing member. *O* is a thrust-collar screwed on the hub of *B*, and *P* is its check nut, which is ordinarily pinned to the hub when in position. The stationary member *S*, in the form of a ring surrounding the shaft, is prevented from rotating by fastening to some fixed object the attached arm. In this ring is an annular cavity covered by a thin diaphragm of sheet copper, *D*, against which the ball-race of a thrust-bearing presses. The edge of this ball-race is slightly chamfered to allow some motion to the diaphragm. The cavity is filled with a fluid, such as oil, and connected by means of a tube to a gage. The oil pressure measured by the gage is proportional to the pressure between the thrust-bearings, which in turn is proportional to the torque.

The instrument may be calibrated in the torsion-testing machine or by means of a sensitive friction brake. Fig. 4 is an actual calibration curve for a small instrument, obtained by hanging standard weights at proper distances from the shaft on a horizontal lever attached to the shaft, and reading the pressures indicated by the gage for the various torques shown in the diagram. For ordinary purposes, however, it is not necessary to calibrate the instrument by actual trial, since computations of the oil pressures for the various torques from the lengths of the lever-arms and diaphragm area check very closely.

It will be seen that the weighing means is similar to that employed in the Emery testing-machine, which is recognized as being extremely accurate. It will be possible to employ the Emery flexible steel knife-edges on the levers if desired, but this has been found in practice an unnecessary refinement.

The construction makes the coupling as nearly rigid as materials will permit, the movement of the diaphragm being extremely small. The only flow of oil through the copper connecting-pipe is that sufficient to alter the shape of the Bourbon tube, if that be the form of gage employed. As soon as the normal position of the gage is reached this flow ceases, hence there can be no fluid friction. It is possible, therefore, to use as long and as small a tube as desired without introducing error. Where the gage is placed at a distance above or below the level of the coupling correction should, of course, be made for the difference in static head.

Other means than the gage shown may be employed to measure the fluid pressure. Where extreme accuracy is desired it will be well to employ the weighing-device used with the Emery testing machine. The manograph has been used in this connection to measure variations in torque too rapid for indication by the ordinary gage. For example, the variations in torque in a single revolution of the shaft of a three-cylinder gasoline engine have been recorded with its aid.

Where the rate of rotation of the shaft is variable and it is desired to indicate the horsepower direct, the combination of gage and tachometer shown in Fig. 5 is employed. The hydraulic gage is connected to the coupling described, its pointer therefore indicating torque. The pointer of the tachometer shows the number of revolutions per minute. Being a function of the revolutions per minute and the torque, the horsepower will be indicated by the intersection of the two pointers and suitable curves on the dial as shown. Arrangements for recording or integrating the work done may also be attached to the coupling in any ordinary manner, or a gage may be used.

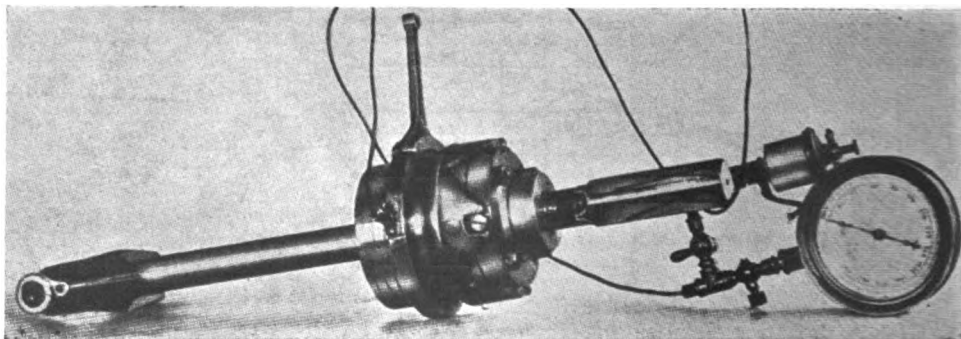

Fig. 2—Transmission Dynamometer in automobile propeller shaft, 30-horsepower at 500 R. P. M.; weight, 25 pounds.

*Presented at the Washington Meeting (May, 1909) of the American Society of Mechanical Engineers.

A summary of some of the more important characteristics of the instrument follows:

a The instrument is compact. The example shown in Fig. 2 and Fig. 3, which is designed to transmit 30 horsepower at 500 r.p.m., is about 5 3/8 inch in diameter and weighs about 25 pounds.

b It is as rigid as an ordinary flange coupling.

c It may be made in the form of a coupling, and will then occupy about the same space as the usual flange coupling, or it may be made in the form of a quill on which a pulley is mounted, or any other suitable form. This form may be made in halves for application to a continuous shaft.

d It will indicate for either direction of rotation of the shaft.

e The torque may be read and recorded or the work integrated at a considerable distance from the coupling.

f The readings do not require correction for different speeds of rotation. All parts containing oil are stationary, hence are unaffected by variation in speed. Other parts are likewise unaffected by the action of centrifugal force.

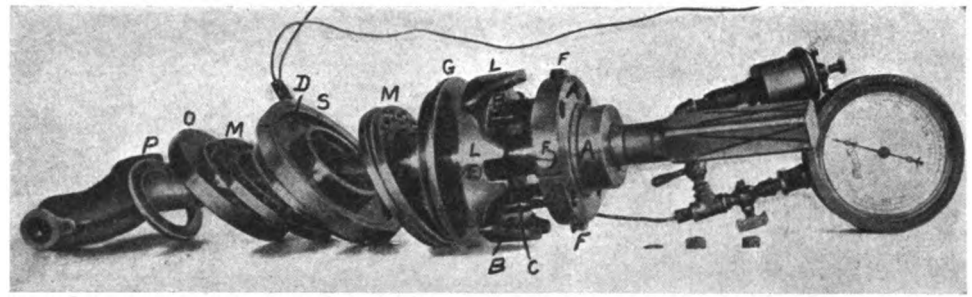

Fig. 3—Transmission dynamometer taken apart to show construction of constituent parts.

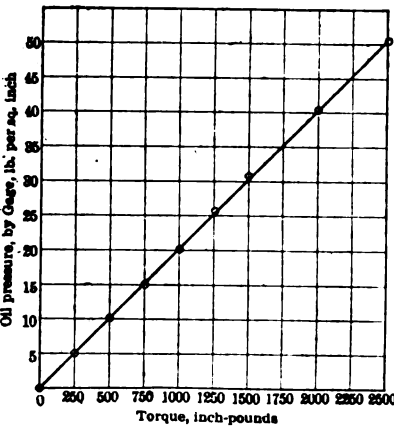

Fig. 4—Calibration curve for transmission dynamometer.

the means employed to measure the fluid pressure, of which a number of forms, other than the usual pressure-gauge, are available. The latter, however, is the more usual.

h The only power absorbed is the small amount due to the friction of the ball, or roller, bearings, and this can be determined from the pull of the retaining arm. It is unnecessary to make correction for this, however, since the amount is so small as to be negligible.

i Since the only wearing parts are the ball, or roller, bearings, which may be lightly loaded, the instrument should not be deranged easily. Because of the very small volume of oil contained in the weighing chamber, ordinary temperature changes do not affect the calibration. All parts containing oil are stationary, hence all joints may be soldered and leakage entirely prevented, which is a feature of this device.

j With suitable material and ordinary workmanship, it is believed that there is little likelihood of failure of any part of the instrument. It is conceivable, however, that the balls or rollers, although lightly loaded, might crush; the diaphragm might shear; or the stationary member, although bearing only its own weight and lubricated, might seize to the hub. Remote as are any of these possibilities, should any or all of them occur, the worst that could happen would be the tearing-off of the oil pipe and retaining arm, when the whole would revolve as a solid coupling. In no case can the coupling fail to drive the shaft because of its variation from the standard form, since, in addition to the driving latches employed to carry the load normally, the same number of connecting bolts may be employed

as in the ordinary coupling, which will still hold the coupling together should the latches fail. Since, however, these latches are farther from the shaft, they should, if properly constructed, be less likely to fail than the connecting bolts usually employed.

It is believed that uses for the instrument here described will suggest themselves, and it is with the hope that the device will prove of some interest to those who deal with the use and transmission of power that the matter is presented.

A NEW SOLDER FOR ALUMINUM.

The problem of soldering aluminum has troubled experts in the soldering line for many years, and most of the liquids brought out for the purpose have developed some unsurmountable drawback when put into use. As a result of this the idea became prevalent that no liquid would do the work.

However, the lack of an effective flux caused the formation of oxide, which always prevented a proper joint being made. Prompted by the conviction that without an intermediate it was impossible to make a good soldered joint, Otto Nicolai, Boppard-on-Rhine, Germany, managed to make a good flux after many years of experimental work.

But the great problem was not really solved without having a solder with the same fusing point as the flux. The inventor's next step was therefore to find a suitable solder. He ultimately succeeded in getting over this difficulty as well, so that an effective solder can now be had. An important feature is that one need only scrape the aluminum to make it clean before soldering and then to wipe the joints with the Nicolai flux.

Solder mixed with the flux is now put on to the joint and will run into the crevices by itself; it will cover surfaces of several square centimeters in area, and the joint obtained in the end is inseparable. Sheets with a joint can be hammered quite thin without injuring the joint. This solder and flux are being used at the imperial dockyard in Kiel and at the royal gunpowder factory in Spandau. At the imperial dockyard in Wilhelmshafen the inventor soldered a new bottom on to a tea kettle of the kind used by bluejackets. The length of the seam was 75 cm. A flask which had become leaky was also soldered.

This and much other work of a soldering nature was passed upon by the Government engineers and pronounced perfect, at least as far as the quality of the weld was concerned. So, Mr. Nicolai has the stamp of approval of the German Government upon his process, which, alone, speaks highly of it. This solution of the aluminum problem is a welcome one.

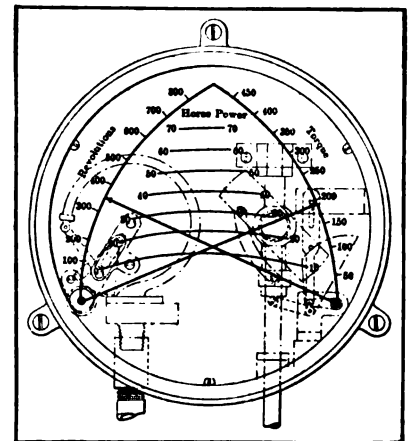
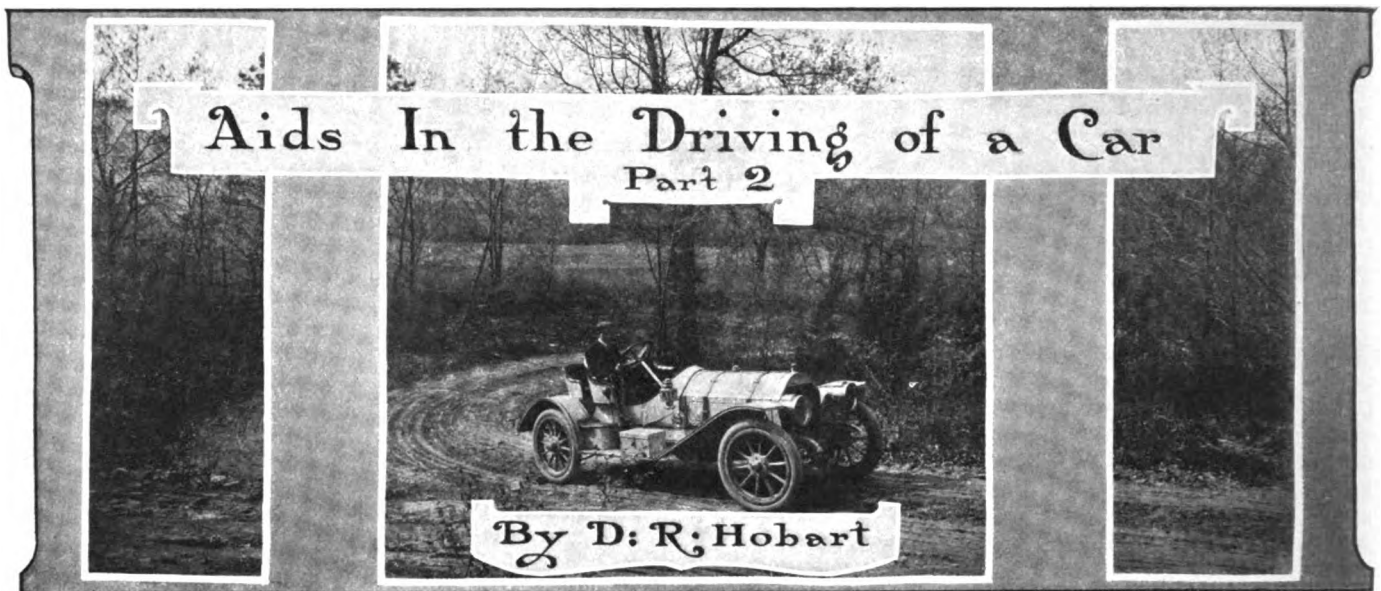

Fig. 5—Combination pressure gauge tachometer, indicating torque, revolutions per minute and horsepower.



ALTHOUGH autoists pay attention to the mechanical details of driving, such as the adjustment of spark and throttle, gear changing and brake operation, the extremely important function of oiling is not given the care that it deserves. Since the car has been tested and adjustments have been made before leaving the factory, it is presumed that everything will continue to operate properly when on the road. To the credit of the manufacturers this is true in a large majority of cases, but even the best oiling devices suffer by neglect, sight feeds clog up or the driving belt may break, with unhappy results. The autoist should take no chances, but constantly observe the sight or circulation feeds and as soon as a cessation of flow is noted it should be investigated and the trouble repaired at once. The oiling directions given in the instruction book should be followed to the letter, and if the conditions of the run are abnormal oiling should be performed oftener than usual. In every instance an excess of lubricant is more economical than worn or broken bearings.

Caution Needed in Overtaking Vehicles—There are two general principles to be remembered in overtaking or passing vehicles on the road. These are: Be sure that there is a clear way ahead before the overtaking or passing is attempted, and never to cut things so fine that a swerve on the part of the other man will cause a mishap. Quite a large proportion of road collisions come from either of the parties concerned taking chances that the other will do the right thing, which seldom happens. In overtaking another vehicle, care should be taken to ascertain that the driver is aware of your presence, particularly if he is driving a covered vehicle or one that is noisy. It is often difficult to make the other man hear, and the chances of his swinging out are too great to warrant any risk being taken. A tendency on the part of the driver to turn off to the side of the road, apparently to let the autoist go by, may be the result of an involuntary pull on the reins or may have been done to avoid a bad place in the road, and this turning off is often followed by an equal swing in the opposite direction. In following a vehicle the autoist should not keep in the other vehicle's tracks, but should stand off diagonally so that he or one of the passengers in the car can see the road ahead and observe the actions of other vehicles. Sufficient distance should be kept so that the autoist can turn in behind the leading vehicle in case of the sudden appearance of others coming in the opposite direction. When the way ahead is clear, the autoist should pass as quickly as the nature of the road permits.

Passing Moving and Stationary Vehicles—The chief point to be remembered in passing moving vehicles is to always allow plenty of room for both. The passing of another vehicle so closely that there is hardly room for a sheet of paper between

them, may be looked upon as brilliant driving, but sooner or later some one will miscalculate and an accident will occur. All passing should be done according to the rule of the road prevailing in the section of the country in which the car is being driven, as the great majority of road users follow this rule, and in case of accident the vehicle which held to the proper side of the road is generally exonerated in the courts. In passing stationary vehicles or those about to start, a strict lookout ahead should be kept for pedestrians or vehicles suddenly emerging from the rear, or in the case of a trolley car, for alighting passengers and those rushing to board the car. It is not sufficient to blow the horn and count on its being heard by those behind the other vehicle. The chances are that the sound has not been heard, and nothing but slow speed can be indulged in with safety. The same need of slow speed and extreme caution occurs in overtaking stationary vehicles as in passing them.

Passing on the Wrong Side—As a rule, all vehicles should be passed on the proper side according to the rules of the road, but there are occasions when it is unsafe to pass in this manner and the autoist has either to pass on the wrong side or wait until conditions are such as will allow him to pass according to rule. Such an occasion often presents itself in overtaking a heavily loaded vehicle or one which has been disabled and has not been withdrawn to the side of the road. Once a loaded van or truck leaves the crown of the road, it has some difficulty in getting back again, especially if drawn by horses, and the driver will generally refuse to turn aside except for other equally heavy vehicles. As the autoist is conducting a vehicle

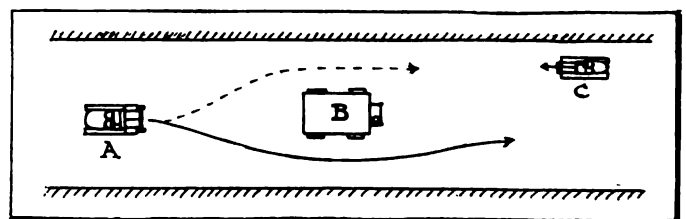

Case When Car May Pass On Wrong Side.

of greatly superior speed and mobility than that of the truck, the latter can be considered as a stationary object for the time being and passed on the wrong side, provided the road is clear. The situation is shown in the sketch where *B* is a truck and *A* a car about to pass the truck. The road being clear, car *A* can take the course *a*, passing the truck on the wrong side. Should the course *b* be taken, a collision is likely to occur between the car and another car *C* proceeding in the opposite direction, unless great caution is exercised by both drivers. If

there is any doubt as to the road not being clear, the autoist should take no chances but wait until the way on the left of the truck is clear and then pass on the proper side. Situations like the above occur from time to time on the road and the autoist should use his judgment in coping with them. Legally it is not justifiable to depart from the rules of the road except to avoid accidents, and this should be borne in mind at all times.

Passing Horses on the Road—The majority of horses encountered on roads frequented by automomiles to any extent, pay comparatively little attention to them, even when passed at fairly high speed, and of the remainder it is safe to say that most are not nearly so alarmed as their drivers, who communicate the alarm to the horses through sawing on the bit, shouting or dropping the reins. The exceptions are young horses or those which have not been given sufficient road driving. In passing horses, the autoist should not only observe the actions of the horse, but also those of the driver as well. If the horse exhibits signs of being restive, the voice has a very quieting effect. Expressions such as "Whoa, boy," said in a reassuring tone will in many cases be sufficient to soothe the animal until the car can pass.

The best manner in which to pass a standing horse headed in the same direction as the car is to cross to the far side of the road and drive by quietly at the legal speed. The horse will be only slightly startled, if at all, and will not bolt or back, as the alarming object and its terrors are gone. More care is necessary in passing a horse headed in the opposite direction, as the animal can see the car coming and has time to become fidgety. If the driver has the animal under control, the car can be driven past at the regular pace unless signs of fright are seen, when the car should be slowed down or stopped if necessary. The car should pass on the opposite side of the road and as soon as it is by speed can be increased in order to get out of hearing as soon as possible.

Procedure in Leading a Horse—It may be necessary in some cases to stop both car and motor and to lead the horse past the car. As a number of accidents have occurred through the horse freeing his head from the bridle through improper leading, a word on proper leading a horse will be timely. Both reins should be taken in the right hand about 6 inches from the bit and the horse patted and reassured by the voice. The autoist should then face forward and start off, walking alongside the horse's head until past the car. Should the animal rear, the grip on both reins prevents him from tearing free from the bridle and bolting. The usual mistakes made in leading are in grasping one rein only which hurts the horse's mouth and may break the bridle, and in dragging the horse along while walking backward. As a horse will not willingly walk over a man and as this is the position usually assumed by drivers when hitting the animal over the head, instead of having a soothing effect the operation is rendered harder through alarming and confusing him.

Proper Negotiation of Road Crossings—In approaching road crossings the autoist should slow down to a speed at which he can pull up on the brake within the length of his car, and blow his horn for the purpose of warning other road users of his presence. As the car approaches the crossing, a sharp look-out should be kept for traffic on the intersecting road, and as soon as the way is seen to be clear the crossing should be taken as quickly as possible. Particular care should be exercised at crossings where one road is partially or totally hidden from the other until the crossing is reached, especially in the smaller towns, as light carts, bicycles or in fact vehicles of any kind frequently emerge from the side road at speed and in the most careless manner, even when those in control are unable to see anything that is approaching on the main road. In anticipation of such performances the car should be kept to the center of the road so as to be able to turn aside to avoid a collision, as even if the horn has been blown, there is no way of knowing that the driver of the other vehicle has heard it. Even if vehicles on

the intersecting road can be seen, great caution must be exercised, as there is no indication that they are going to continue along the side road nor in which direction they will turn into the main road. Passing partially hidden road crossings at speed is absolutely dangerous because of the long chances which reckless autoists take at such places.

On Approaching a Blind Turn—Frequently encountered in suburban towns is the blind turn, where a cross street or road terminates in one of the main roads and the view from either road is obscured by buildings or fences until the turn is reached.

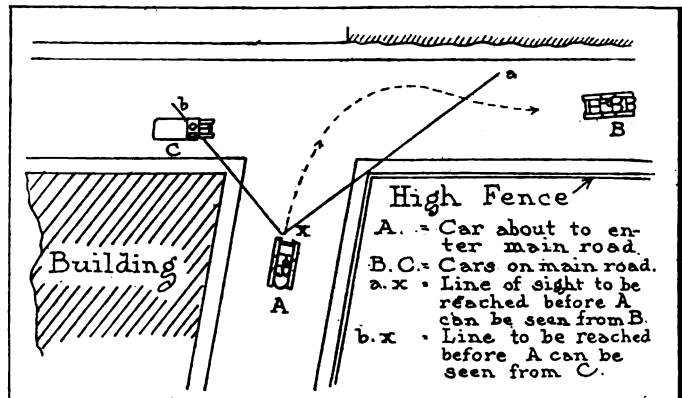

Illustrating Blind Turn and Its Negotiation.

At such turns the chances of accident are greater than at road crossings, as at these latter places an autoist has three directions in which he can turn to escape collision while at blind turns there are but two, with the chances in favor of the car on the side road. Referring to the sketch, *A* is a car about to enter the main road and proceed thereon in the right-hand direction, and *B C* are cars proceeding along the main road. Owing to the high fence on one side and the building on the other, *A* cannot be seen from *B* or *C* until the lines *ax* and *bx* are reached, nor can *B* or *C* be seen from *A*. The sound of a horn from either road likewise cannot be heard from the other. Under the circumstances, car *B* should keep to the center of the road as in negotiating road crossings and car *C* should keep to the right-hand side of the road and proceed cautiously. When the car *A* makes the turn into the main road, it should take the path shown by the dotted line, swinging well out to avoid a possible collision. Car *B* has thus an opportunity to turn aside and avoid *A*. Should *A* turn to the left into the main road, car *C* is in no danger even if the driver of the former car cuts the corner closely. The positions shown in the sketch should be assumed at all times when approaching a blind turn whether the presence of a car on the other road is known or not.

The Right of Way at Turns and Crossings—Regarding the right of way at turns and crossings, the vehicle which arrives first has the priority of passage according to actual road practice. In case of a "dead heat" between two cars, it remains for both drivers to agree as to which shall proceed ahead of the other, the driver yielding the way giving a signal with the hand. Generally speaking, horse traffic gives the precedence to automobile traffic as a matter of safety, but the autoist should not consider that he has the absolute right of way over all other road users for this reason. Every user has equal rights on the road, but because the autoist has a vehicle of great physical superiority due to its weight and speed, he is not entitled to lord it over those not so well equipped. It does no harm to yield the road to a horsed vehicle even if the action necessitates a change of gears or a stoppage of the motor. On the contrary, the courtesies shown will do much toward removing the prejudice against automobiles in that portion of the country. In general, the autoist should exercise his discretion as to what is proper under the circumstances, departing from road practice if necessary, and his individual sense of fair play should cause him to have regard for the rights of others at all times.

(To be continued.)

AN INTERESTING NEW AIR COOLING SYSTEM

ADDITIONAL light is being shed upon the subject of air— or, as it is sometimes called, direct cooling, by a number of experimenters working along new and radically different lines. The idea of an Englishman, E. H. Morgan, is to circulate air through the regular water jackets, so that it circulates around the heated cylinders. The use of air as a medium in the water jackets means less weight, and less complication. The latter, in particular will be emphasized by Morgan's scheme, for he proposes to dispense with the fan and induce the air to flow by the action of the exhaust in an ejector pipe.

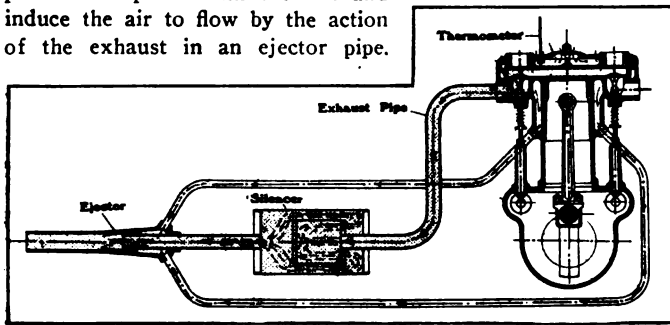

Diagram of Morgan's Air-Cooling System Showing Action.

In this way, as the cut shows, the pump and its drive is not only dispensed with, but the fan and fan drive, is also done away with. The muffler used (the English call it a silencer) is a very simple one, being merely a cylindrical shell about nine inches long by seven inches in diameter. Within this is placed another drum of smaller dimensions, to which the end of the exhaust pipe is fastened. The gases are allowed to flow into the one end and strike the other, when they turn and escape by the front end, which is perforated. Once more, the shape turns them through 180 degrees, and thence they escape into the induction pipe or ejector as it is marked on the cut.

This is of large diameter and the gases pass rapidly through it at a high speed, this varying with the work which the motor is doing and not with the speed alone. The latter is said to be the chief objection to the ordinary method of blowing air against the exterior of the cylinders by means of a fan or blower operated from the engine itself. This means that the speed of the fan, and consequently the speed and volume of the air, vary

with the rotary speed of the engine. Now, at the time when the greatest amount of air is necessary, as at slow speeds on a hill the least amount is being furnished.

This has been carried beyond the theoretical point by means of thorough tests. The latter were made on a Milnes-Daimler four-cylinder engine 96 mm. bore by 130 mm. stroke ($3\frac{3}{4}$ by $5\frac{1}{8}$), the rating for which would be $22\frac{1}{2}$ horsepower.

In the actual test, the motor developed much power in excess of this. The temperature of the air within the water jackets just previous to the commencement of the run was 70 Fahr. Three minutes after applying the load to the prony brake (ten minutes after starting the engine), it had risen to 190 degrees. Five minutes later 240 degrees was reached, and a further running of fifteen minutes caused it to go to 275 degrees.

Mr. Morgan ran the engine with very little oil purposely, and many thought that he was courting disaster to use so little, in view of the high temperatures. Examination of the exhaust showed not the slightest trace of oil, and no effects of the lack of it were observable. The engine ran with perfect regularity during the test, maintaining a speed of 840 revolutions, at which the power developed was 38. After 35 minutes' continuous running the prony brake band seized, due to lack of water, and the motor was stopped. At this, the temperature within the jackets rose to 440 deg., and some difficulty was experienced in restarting.

The engine was started again, and run at the same speed but with a lower load, so that the power was but 31.5. This run continued for over 20 minutes, when trouble with the brake band, due to lack of water, caused the second stop, and with it the observed temperature in the jackets again rose. This apparently had no other effect than to burn the film of lubricating oil from the cylinder walls. There was no evidence of pre-ignition at any time during the tests, and the average of careful observations of the temperature of normal running showed it to be in the neighborhood of 275-280 deg. Fahr.

This was by far the most unsatisfactory of all the tests made, but the figures for the others are not available. It may be seen that the normal figures deduced from a not wholly satisfactory test are just midway between the maximum figure for water-cooled motors and the recommended temperature for air-cooled engines, namely, 205 deg. for water and 350 deg. when air is used. These two average 278 deg.

THE AUTOMOBILE CALENDAR.

Shows, Meetings, Etc.

- Nov. 6-13.....Atlanta, Ga., Auditorium-Armory, National Automobile Show.
- Jan. 8-15.....New York City, Madison Square Garden. Tenth National Show, Association of Licensed Automobile Manufacturers.
- Feb. 5-12.....Chicago, Coliseum, Ninth Annual Automobile Show, National Association of Automobile Manufacturers. S. A. Miles, General Manager.
- ### Races, Hill Climbs, Etc.
- May 28-30.....Denver, Col., Reliability Contest, Pueblo and return, Denver Motor Club.
- May 29.....Wilmington, Del., 106-Mile Sealed-Time Run, Delaware Automobile Association.
- May 31.....Wilkes-Barre, Pa., Annual Hill Climb, Giants' Despair Mountain, Wilkes-Barre Automobile Club.
- May 31.....Bridgeport, Conn., Annual Hill Climb, Sport Hill, Automobile Club of Bridgeport.
- June 1.....New York City, Start of Transcontinental Contest to Seattle, for Alaska-Yukon-Pacific Exposition, M. Robt. Guggenheim Trophy.
- June 5.....Albany, N. Y., Hill Climb, Kenwood Hill, Albany Automobile Club.
- June 9.....National Orphans' Day.

- June 12.....Worcester, Mass., Annual Dead Horse Hill Climb, Worcester Automobile Club.
- June 12-14.....New York City, Catskill-Berkshire Endurance Contest, New York Automobile Trade Association.
- June 14-18.....Philadelphia Reliability Run to Pittsburg and Return, Quaker City Motor Club.
- June 14-21.....Annual 660-Mile Spring Tour Maxwell-Briscoe Motor Club, New York City via Waterbury, Stockbridge, Newburgh, Delaware Water Gap, Philadelphia, Atlantic City, to New York.
- June 17.....Readville, Mass., Track Race Meet, Bay State Automobile Association.
- June 18-19.....Chicago, Stock Chassis Race for Cobe Trophy and Light Car Race.
- June 21-26.....Binghamton, N. Y., Fourth Annual Endurance Run, Binghamton Automobile Club.
- June 22-28.....Albany, N. Y., Fifth Annual Tour, Bretton Woods, Portsmouth, Boston, Albany Automobile Club.
- June 24-26.....Montreal, Blue Bonnets Track, Race Meet. R. M. Jaffray, Manager.
- June 25-26.....Philadelphia, 24-Hour Track Race, Quaker City Motor Club.
- July 3 and 5.....Wildwood, N. J., Straightaway Races, Motor Club of Wildwood.

Letters Interesting and Instructive

TIME FOR VALVE GRINDING.

Editor THE AUTOMOBILE:

[1,889.]—Will you please advise me how often I should grind in my valves. The motor is a four-cylinder, water-cooled, one of 30-horsepower, and recent make.
Carbondale, Pa. R. T. TRUESDALE.

There is no hard and fast rule which can be given aside from grinding when it is necessary. A careful driver may get four to five thousand miles out of his valves with one grinding, while another, with the selfsame car and engine, may only get one or two thousand miles per grinding. There are many factors which enter into the life of a valve seat, and in the frequency of grinding all of them have to be taken into account. Some of these are: imperfect cooling of the seats, as described in THE AUTOMOBILE for last week (May 13 issue); too strong springs, which cause hammering and thus wear out the seats prematurely; over-lubricating, which causes spitting and sooting, both of which reduce the active life of the valve seat.

Other causes are contributory negligence on the part of the driver in not examining them more often, which examination often results in the discovery of something in the way of soot or dust caught in between the valve and seat, and being gradually pressed into the latter.

A habit followed by professional drivers is to grind valves as soon as a certain distance has been covered, this being predetermined by experience with a single or many cars. This habit might well be followed by amateurs, as soon as they have driven enough to determine the critical mileage.

ANOTHER ROTARY VALVE

Editor THE AUTOMOBILE:

[1,890.]—I have noticed the excellent article in "The Automobile" for May 13, by W. F. Bradley, in which he speaks of a new Italian engine with a rotary valve. Has not an American motor been built with a rotary valve and if so, will you please tell me something about it and where it was built?
Philadelphia, Pa. H. F. WHITE.

In 1907 Messrs. Howard and Frayer, the latter formerly chief engineer for the Oscar Lear Company, builders of the Frayer-Miller car, built for M. W. Kouns, of Sandusky, O., an air-cooled engine with rotary valves, one rotary taking the place of two ordinary reciprocating valves. These were placed in the cylinder heads, lengthwise of the engine, and a single camshaft driven from the crankshaft by means of worm and gear drives all of them.

The valve, shown in the illustrations, rotates at one-fourth the crank speed, so that it completes a cycle in one-half a revolution. The exhaust works first in the direction of rotation, after which the passage of the incoming charge cools the valve. Circular

rings on the full part and straight strips, spring-actuated, at the cut part, serve to make the valve gas-tight. An additional advantage which this device had was the ability to reverse. Upon the vertical shaft is placed a pair of gear- and a couple of

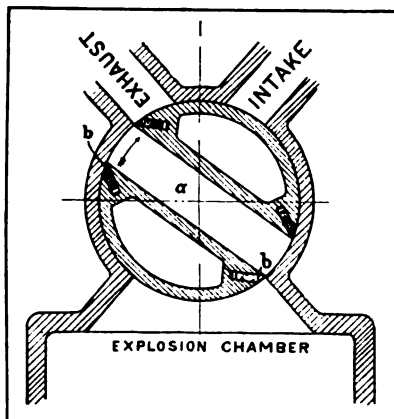

Rotary Valve Shown in Section.

dog clutches. By using one, the valves rotate in one direction and with them the engine. When the other clutch is thrown into mesh, the valves, and with them the engine, turn in the opposite direction.

The second illustration shows the air-cooled cylinders to which the valves were fitted, and one of the valves.

These engines were to be marketed by the Ohio Manufacturing Company, Upper Sandusky and Columbus, O., in sizes from 12 to 40-horsepower, but whether this firm is still in business or not is more than can be said.

Charles E. Duryea, who was formerly in business in Reading, Pa., building water-cooled engines, is a prominent advocate of the rotary valve, and his design, in which the valve is water-cooled, has many points of superiority over the one shown.

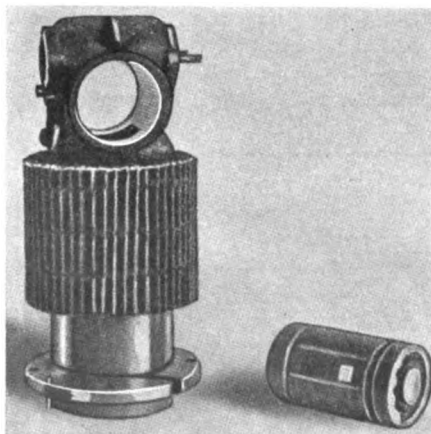

Cylinder and Valve as Actually Made.

FIXED FIRING POINT PUZZLES.

Editor THE AUTOMOBILE:

[1,891.]—Will you please explain to me the action of a magneto which allows with the disposal of the spark advance lever? These are, I believe, said to have a fixed firing point.
Dayton, O. A SUBSCRIBER.

The answer is that the intensity of the current increases and the moment of maximum intensity advances, as the speed of the armature increases. Therefore, as the engine speed increases the timing automatically adjusts itself to the conditions. The opposite also holds true, so that for starting the moment of maximum intensity is so far retarded that it is safe to crank the engine over. All of this allows of dispensing with the usual spark advance lever, with consequent simplification.

DIFFERENTIAL ELIMINATION.

Editor THE AUTOMOBILE:

[1,892.]—In reference to the article in the April 29 issue of "The Automobile" regarding the Ampere car, will you please advise me at what angle the inside road wheel is released on a curve; also, whether the current is wholly cut off at this certain point, or is there a preliminary gradual weakening of the current?

New York City REGINALD E. JORDAN.

To quote from the description of the Ampere car, on page 704, "The differential will at once be missed, and the resulting simplification noticed." And further along, "When current is turned into the magnet E, * * * the corresponding plate P * * * is attracted and as long as the current passes and energizes the magnet, is driven by the rotating axle. As soon as the current is cut off, the wheel is freed and is no longer driven from the motor."

This explains the action of the device. Now for the current, quoting once more from the same page: "The steering gear turns free up to a certain angle, at which it automatically cuts off the current to the inner wheel." The manufacturers advise that this cutting off action begins to manifest itself at an angle of 5 degrees out of a straight ahead line, beyond which the current gradually weakens continuously up to 35 degrees, at which latter angle the whole of the current is cut off and no flow of current to these magnets takes place until the wheels are turned back.

The action on straightening the wheels is just the reverse of this, when the wheels are turned back to 35 degrees out of a straight ahead line, the current begins to flow weakly, but constantly increasing in strength up to 15 degrees, at which point it has its full strength, and the wheel is fully engaged.

The makers say that these two angles have been carefully determined experimentally, as the result of several years of test-

ing work in this field of endeavor, and are therefore correct for this class of work.

This solution of the problem of the differential is an excellent one, and well worthy of imitation by our American manufacturers in their striving for simplicity.

GAS TURBINES.

Editor THE AUTOMOBILE:

[1,893.]—Will you please tell me something about the gas turbine, its prospects, a description of it, and list of books on the subject?
J. W. FRANKLIN.

New York City.

The subject is too large to be gone over in this space, but it might be said that some experimental work has been done on gas turbines, more particularly on the other side. Some work has also been done in

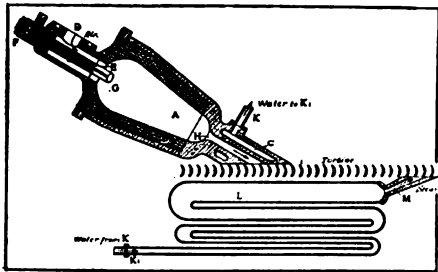

Diagram of Gas Turbine.

this country. None of the resulting machines have been declared successful, nor have they been put on the market for sale.

A prime reason for the lack of success in this direction is the impossibility of an air or, better, a gastight casing with frictionless rotation. If the former is secured, it is at the expense of the latter, and the resulting output will not be enough greater than from the reciprocating type to warrant the use of the excessive speeds of the turbine which run ten times the ordinary.

So, too, if the latter, frictionless rotation, is secured at the expense of the gas tightness, the result would not warrant a change to the newer prime mover.

In "Steam Turbines," by Stodola, a chapter is devoted to this interesting subject, as is also the case in Neilsen on Steam Turbines. A new work is entitled "Steam Turbines," by Moyer, and in it will be found several chapters on the subject. This paper, THE AUTOMOBILE, has also spoken of it at different times, although no extended article has ever been published.

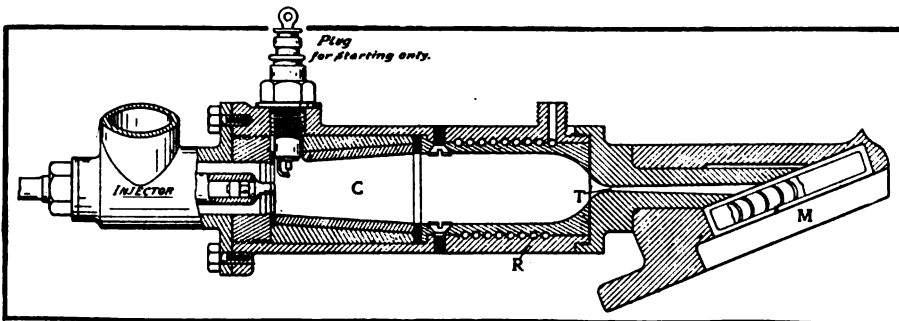

Another Gas Turbine Without the Steam Jet.

We are giving, for Mr. Franklin's benefit, two reproductions of gas turbines as proposed by prominent experimenters. One of these uses steam in combination with gas, the effect of the former being to cool the blading of the rotor as heated by the exceedingly hot gases of combustion. In the view of this, the larger of the two, A is the combustion space. B is the carborundum wall. F, D, G and E are the air and gasoline feeding pipes. I represents the rotor of the turbine. C is the nozzle water jacket. L shows the small boiler receiving hot water from the water jacket C, and also heated by the exhaust gases around the outside. M is the steam nozzle.

The other is somewhat similar, the use of carborundum for the combustion chamber walls, water for cooling, and all features of the first except the use of steam, being found as on the one first described.

PROOF OF ACID IN OIL.

Editor THE AUTOMOBILE:

[1,894.]—Will you please give a simple method of testing lubricating oil for acid contents, one that any amateur could use. I understand the presence of even a trace of acid in the oil will, in time ruin the ball bearings and other fine parts of my car.
H. D. BLAKESLEE.

Detroit, Mich.

You are right, a trace of acid in the oil will ruin the balls and races of bearings.

Pure mineral oils contain little acid, and what they do contain is readily determined. Vegetable and animal oils, on the other hand, all have oil contents and under the action of heat these may be liberated.

A simple home test may be practiced as follows: Secure from a druggist a solution of sodium carbonate in an equal weight of water. Place this in a small glass bottle or vial. To test an oil, take a small quantity of the lubricant, and an equal amount of the sodium solution. Put both in another bottle, agitate thoroughly, and then allow it to stand. If any acid is present, it will settle to the bottom as a precipitate, the amount of the precipitation being a measure of the amount of acid present.

Another method is to allow the acid, if there is any, to attack some metal. To do this proceed as follows: Soak a piece of cloth or preferably, wicking in the oil suspected of containing acid. Select a piece of steel at random and polish it to a bright surface. Wrap the steel in the soaked rag or wicking, and place in the sunlight but

protect from wind or weather. Allow it to stand several days, and if there is no sign of etching of the surface, repeat with a freshly soaked rag, being careful to use the same oil as before. After two trials if no sign of the etching appears, you may take it as free from acid.

LIGHTER THAN GASOLINE.

Editor THE AUTOMOBILE:

[1,895.]—Will you please tell me if there is any known colored liquid which is lighter than gasoline so that I could use it to make a gauge glass with? What I want is something which will float on gasoline so that I can arrange a gauge glass outside of the tank, and have the colored liquid, by floating on top of the gasoline, indicate the level of the fuel within the tank.
New Rochelle, N. Y. R. R. ROBERT.

The three necessities for the liquid to serve your purpose would be: colored, lighter than gasoline, and nox-mixable with the latter. The lightness of gasoline is measured with the hydrometer, on which (Baume) ordinarily 70 is the figure. This is equivalent to about .71 specific gravity. Now from a list of liquids of known specific gravity select one lighter than this. Here is a list of liquids and their specific gravities:

1. Rhigoline	.615-.625
2. Petr. Ether	.630-.640
3. Sulph. Ether	.716
4. Petroleum	.780-.880
5. Kerosene 135 test	.786
6. Kerosene 150 test	.788
7. Pure Alcohol	.793
8. Alcohol 95 per cent.	.816
9. Alcohol 94 per cent.	.820
10. Fuel Oil	.828
11. Alcohol 90	.834
12. Naphtha	.848

From this you can see that but three liquids qualify as lighter, numbers 1, 2 and 3, all of which will mix with gasoline, so that nothing that can be called to mind will answer your purpose. An additional fact which you should bear in mind is that such a proceeding as you have in mind is dangerous, and should not be tried. If the glass became broken in any way the inflammable gasoline would be free to flow out and ignite, which might mean the loss of your car.

KEROSENE AS FUEL.

Editor THE AUTOMOBILE:

[1,896.]—Will it be possible for me to use kerosene as a fuel for my double opposed 16-horsepower engine without expensive changes in construction? I am greatly interested in the fuel question and want to experiment with it, but do not want to spend a lot of money.
Colorado Springs, Col. R. H. OTIS.

Kerosene has been and can now be used in carbureters designed for gasoline, but not with any marked degree of success. It is fair to assume that you wish to determine the comparative cost of the two fuels. It is not advisable to use an ordinary carbureter, without alterations which will give kerosene a fair chance.

The main difference between the two lies in the difficulty of vaporizing the heavier fuel with the available heat. In many kerosene vaporizers this difficulty is overcome by heating the fuel before as well as during vaporization.

U. S. SEEKING THE REMEDY FOR ROADS' WEAR AND TEAR

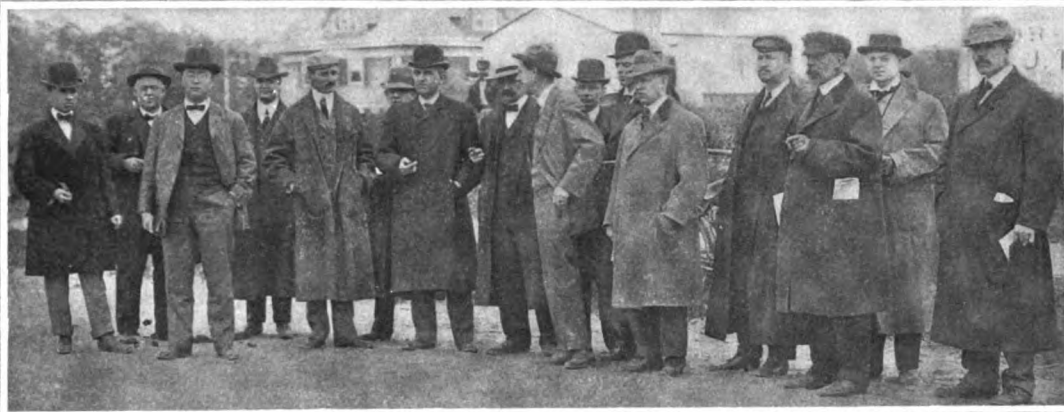

Those Who Helped to Do the Work at the Long Island Test, Held on Hillside Avenue, May 20.

Reading from left to right: Lieut. Warren T. Hannum, Engineer Corps, U. S. A., Washington; John P. Coghlin, president, Worcester Automobile Club; Vernon N. Pierce, chief engineer, Office Public Roads; F. H. Elliott, secretary A. A. A.; Col. Spencer Cosby, Supt. Buildings and Grounds, Washington; Jos. A. Anglada (in back), New York City; David Sheridan Stanley, Major Quartermaster, U. S. A.; Major Jay Johnson Morrow, Engineer Corps, U. S. A.; L. W. Page, Director U. S. Office Public Roads; P. St. J. Wilson, State Highway Commissioner of Virginia; Alex. Floyd Armstrong, New York State Department of Highways; George C. Diehl, Engineer Erie County, N. Y., and chairman A. A. A. Good Roads Board; Herman F. Cuntz, M.E., of A. L. A. M.; James Owen, C.E., representing New Jersey State Commissioner of Roads; Coker F. Clarkson, engineering department, A. L. A. M., and Thomas J. Fay, Society of Automobile Engineers, New York City.

FULLY alive to the needs of the moment, the Office of Public Roads of the United States Department of Agriculture, under the supervision of Director Logan Waller Page, is seeking to solve the natural sequence of the problem presented by the greater use of the highways through the coming of the motor-driven vehicle. Some time ago experiments on road surfaces were made in the vicinity of Washington, and again on Thursday of last week another series of tests took place on Hillside avenue, in Jamaica, L. I. These tests were brought about with the co-operation of the good roads board of the American Automobile Association, of which George C. Diehl is the chairman. In attendance were the highway commissioners, or their representatives, from nearly a dozen different States, officers of the Engineering Corps of the United States Army, a plenteous delegation from the Office of Public Roads, and automobilists of national reputation.

While the results were not as thoroughly satisfactory as many wished, at the same time undoubted progress was made in the premises, and the facts adduced will be utilized in arriving at the ultimate result.

Hillside avenue is in a more or less worn-out condition and appears to be a combination of a macadam and gravel road, with frayed sides. Frequently the cars traveled over a part of the real road and the dusty side. There were trials at low speed and high speed, and brake tests, with and without chains and anti-skids, and horse-drawn vehicles entered into the producing of photographic evidence, which was supplemented by the tape measure.

A technical committee composed of Herman Cuntz and Coker F. Clarkson, of the A. L. A. M.; Thos. J. Fay, Jos. F. Anglada and O. A. Stranahan, of the Society of Automobile Engineers, and C. F. Drake examined the cars carefully in order to be able to fix upon the value of the test data, taking into account all the factors that might have bearing on the results. A summary of the observations made by the technical committee will best tell the story, though it will be at the expense of some time, many more tests, and much discussion before the whole story will be told, reaching conclusions of a dyed-in-the-wool character.

There were 36 tests involving speed, taking into account the several makes of tires, and with an idea of judging of the amount of dust raised photographs were taken from all angles.

Then the effect on the roadbed was observed by the committee. In the brake tests the White steamer, with tires on the rear wheels in which the word "Firestone" was embossed, had the advantage of excellent traction, and at the same time it was not actually necessary to use chains. In these severe brake tests it was adequately indicated that the tread of the tires was not damaged, although, of course, the tread did indent the roadbed when the steamer, going at 40 miles an hour, came to a dead stop inside of 140 feet, and again when going at 30 miles the car came to a stop in 74 feet.

In the speed trials when chains were applied it was expected that they would do much damage relatively, and it came as a surprise to the observers when it was found that the chains had no such effect at all. As a matter of fact, the chains did not damage the road as much as smooth tread tires when the speed of the car was high enough to cause slipping to a considerable extent. It was the common belief, taking such evidence as was afforded, that under ordinary conditions chains do not damage the roadbed, and when the speed of a car is high, in the absence of some such equivalent as the Firestone tread, the chains would seem to be an actual advantage from the point of view of the maintenance of the road.

On the whole the tests were a little tame during the speed trials, and it was not until the brake tests were innovated that the large party of road builders and automobile engineers essayed to become particularly interested. It was not anticipated that so much good information could be had in the simple process of trying out cars for the purpose of determining the distance in which they could be brought to rest. Nor was it supposed that a mounted policeman going at 25 miles per hour would experience difficulty in stopping his horse inside of 152 feet. But No. 3815 failed to do better, and he made a splendid run of it, being a veteran of the U. S. Cavalry, finely mounted, and a horseman beyond question. This same officer, going at a rate of 10 miles per hour, came to a stop inside of 17 and 12 1-2 feet respectively, as the result of two trials.

The motorcycle test was of interest, and it was also one of the surprises of the day. The motorcycle, going at 40 miles per hour, stopped inside of 157 feet, thus showing that the mounted policeman and the cyclist are about on an equal footing.

The span of horses, hitched to a rig, would not stop in an

orderly manner at all when the pistol was fired as a signal to the driver, but in the absence of the shot the same horses, going at a speed of 10 miles per hour, were brought to a stop inside of 27 feet. The carriage used was a frail affair, and the horses would be classed as a little short of "ginger." As the affair turned out, the horses failed to come to a stop any quicker than the automobiles under the same conditions of speed, as the following tabulation will adequately testify to.

AUTOMOBILE BRAKE TESTS AS MADE BY THE COMMITTEE.

Car.	Miles Per Hour.	Stopping Distance in Feet.
Simplex	20	42
Simplex	30	109
Simplex (empty tonneau)	40	187
Simplex (three in tonneau)	40	146
Simplex	25	70
White Steamer	20	41
White Steamer	25	53
White Steamer	30	74
White Steamer	40	140
White Steamer	10	16
Peerless	20	65
Peerless	28	96
Peerless	40	151
Peerless (steel studded tires)	20	55

One test showed that weight over the rear wheels, when they are the traction members, influences the situation to a considerable extent, in that a car can be brought to rest in a much shorter distance when the tonneau is provided with a weight of passengers. The Simplex car, with the tonneau empty, was brought to rest inside of 187 feet, and the same car with three average weight passengers in the tonneau came to rest inside of 146 feet.

During the dust trials the motor vehicles were operated at speeds of 10, 20, 30, 40 and 50 miles per hour. The Fiat Cyclone and the Simplex "50" were driven at the utmost speed when the condition of the road permitted, and maximum speed of 78 miles per hour was attained by the Fiat and 71 miles per hour by the "50" Simplex. Above forty miles an hour the speeds were most carefully determined by a chronograph operated by Dr. L. J. Briggs, of the Department of Agriculture, Washington, D. C.

While Director Page would not make any official statements regarding the value of the work done, it is believed that the experiments were satisfactory. It is understood that when the photographs have been developed, the moving picture films studied and the mathematical problems figured to a nicety, Mr. Page will issue a formal report from Washington.

Among those who were present as interested spectators and scientific observers were:

- L. W. Page, Director U. S. Office Public Roads, Washington, D. C.
- Col. Spencer Cosby, Superintendent of Buildings and Grounds, Washington, D. C.
- Maj. Jay Johnson Morrow, Corps Engineer, U. S. Army, Washington, D. C.
- David Sheridan Stanley, Major Quartermaster, U. S. Army, Washington, D. C.
- Lieut. Warren T. Hannum, Corps Engineers, U. S. Army, Washington, D. C.
- Vernon N. Pierce, Chief Engineer, Office Public Roads, Washington, D. C.
- Dr. Lyman J. Briggs, Physicist, Dept. of Agriculture, Washington, D. C.
- L. L. Williams, Official Photographer, Dept. of Agriculture, Washington, D. C.

- Roy Crandall, Expert, Dept. of Agriculture, Washington, D. C.
- James C. Wonders, State Highway Commissioner of Ohio.
- Col. Wm. D. Sohler, State Highway Commissioner of Massachusetts.
- Francis A. Price, State Highway Commissioner of Delaware.
- P. St. J. Willson, State Highway Commissioner of Virginia.
- Alex. Floyd Armstrong, State Dept. of Highways, Albany, N. Y.
- R. D. Beman, Deputy State Highway Commissioner of Pennsylvania.
- James Owen, C. E., representing State Commissioner of Roads of New Jersey.
- James R. Rablin, Chief Engineer, Metropolitan Park Commission, Boston.
- George Lyman Rogers, counsel, Metropolitan Park Commission, Boston.
- Jesse T. Vogdes, Chief Engineer and Superintendent Fairmount Park, Philadelphia.
- John J. McLaughlin, Chief Engineer Borough of Queens, Long Island.
- George C. Diehl, Engineer Erie County, N. Y., and Chairman Good Roads Board A. A. A.
- Herman F. Cuntz, M.E., Association Licensed Automobile Manufacturers.
- Coker F. Clarkson, Engineering Department, A. L. A. M.
- Charles Thaddeus Terry, Chairman A. A. A. Legislative Board, New York.
- Frederick H. Elliott, Secy. American Automobile Assn., New York City.
- John P. Coghlin, President Worcester Automobile Club, Worcester, Mass.
- Fred J. Wagner, official A. A. A. starter, New York City.

DINNERS "ALL HOT" SERVED A L'AUTO.

PARIS, May 23—How to deliver a dinner all hot from the establishment to a customer's house is a problem that has puzzled many a French caterer specializing in high-class dinners served *à domicile*. The problem is not confined to complete dinners, for every restaurant proprietor has some specialty that he is constantly called upon to furnish promptly, fresh and hot.

The way out of the difficulty was the automobile, and the vehicle most suited to this particular class of work was the Roval, a French production, with its power plant, a single cylinder De Dion, set over the rear axle and transmitting by means of a very compact gear box and clutch to the road wheels through side chains. Such an arrangement left the whole of the vehicle ahead of the rear axle free for bodywork, while at the same time leaving the engine as accessible as if it had been under a bonnet forward. The traveling cook shop is the usual type of Roval car with special heating arrangements. The body is divided into three distinct compartments, reached through the two side and the one front doors, and each one maintained at a correct head by pipes through which the exhaust gases and the cooling water circulate. A sheet-metal lining backed with felt retains the heat sufficiently to assure any of the dishes being carried to customers as hot as when they came out of the oven.

COMMISSIONERS STUDY CLEVELAND ROADS.

CLEVELAND, May 24—Franklin county commissioners will spend several days in this city next week studying the roads in and around Cleveland, with a view to improving their own along the same lines. While here the commissioners will be entertained by the Ohio Good Roads Federation, of which M. M. Maxwell, well known in automobile circles in northern Ohio, is secretary.



White Steamer In the Brake Test.

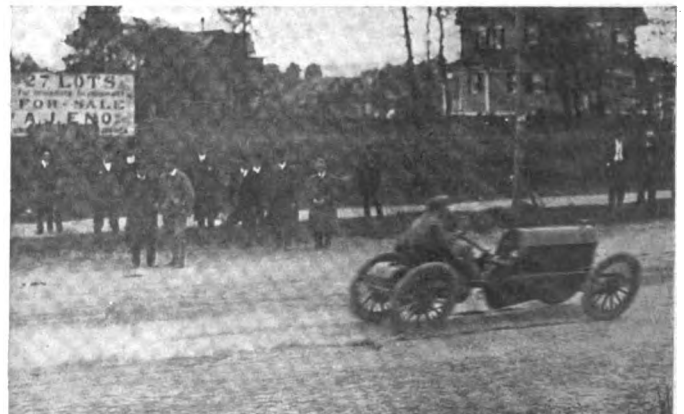

Fiat Cyclone Traveling at Speed.

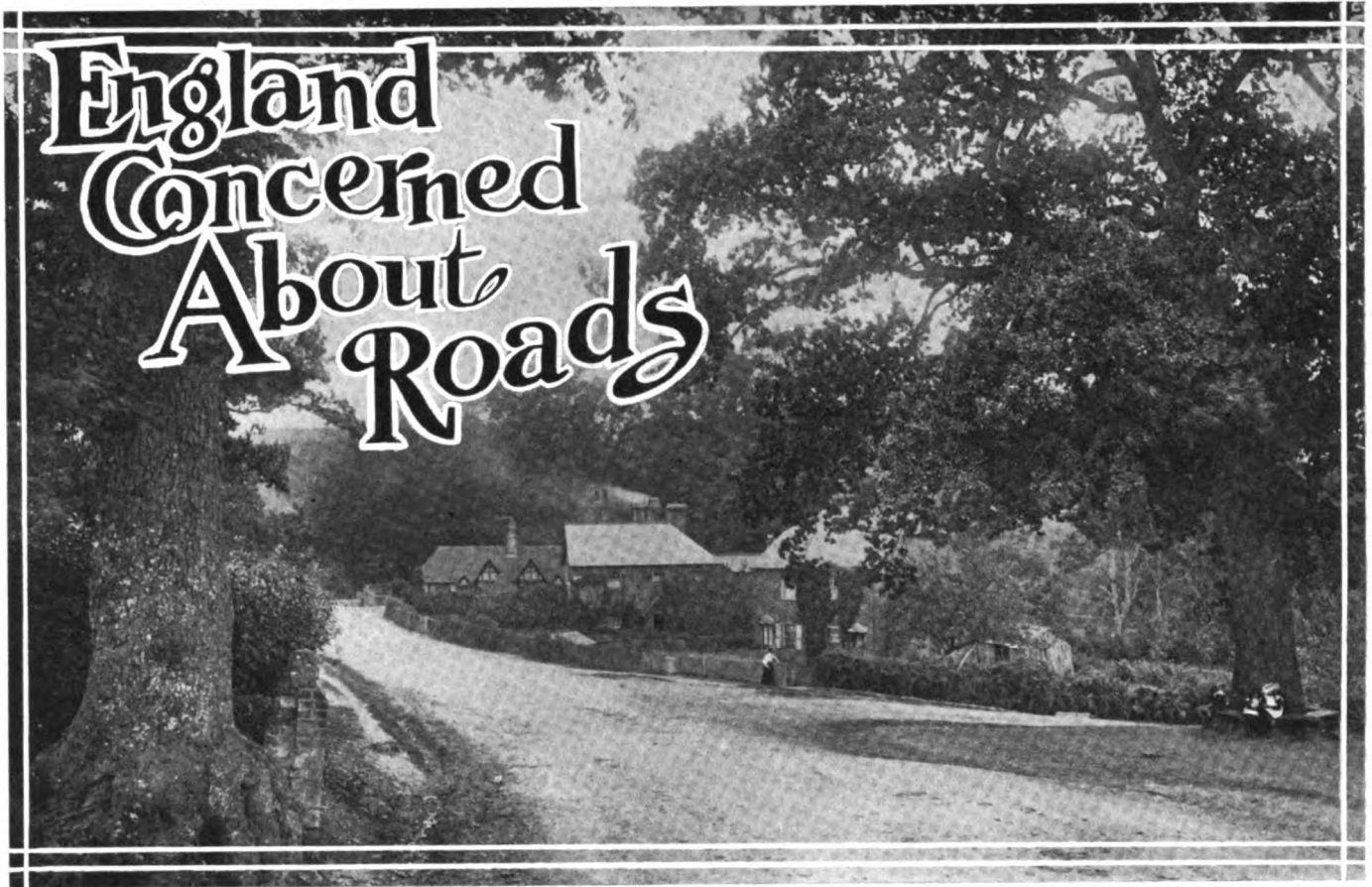

A Typical Stretch of Highway In the British Isles, Where There Is Much Concern About Road Preservation.

LONDON, May 15—Interest unquestioned was manifest in the National Road Conference, organized by the County Councils Association, and the result of the recent sessions in London indicates that England is certainly concerned about the future of its roads. Papers innumerable were presented, and the subject was attacked from almost every point of view.

Resolutions adopted embrace a system of standardizations to facilitate the collection of facts about roads and traffic; classifications of all roads under the two headings, primary and secondary; increased government grants for the maintenance of all primary roads; codification and consolidation of the highway law; the use of tar and similar means for rendering roads waterproof; power to close roads temporarily to heavy vehicles at times when serious damage would be done by them; legislation to prevent any vehicle from bringing mud on to the roads upon its wheels; additional regulations restricting the weight of vehicles in relationship to their speed, and to the size and nature of their wheels; application of all funds derived from motor taxation to the improvement of the road.

A summary of a few of the most important papers will indicate more than anything else the diversity of the proceedings and the thorough manner in which the entire matter received consideration.

First Damage by Horse-Drawn Traffic: Then the Auto.

The passage of vehicles over a road produces several effects which it is important to distinguish. There is first, the grinding and crushing action of the wheels and horses' feet on the surface; secondly, the effect of the load in giving rise to bending and cross breaking strains throughout the whole thickness of the road coating.

Another damage that has now to be met is the scrubbing off of the road surface owing to fast motor traffic.

Almost the whole of this damage results through the roads being constructed of a water-bound granite, which in itself must of necessity be to a large extent friable.—[Albert D. Greatorex, M.I.C.E., Borough Engineer and Surveyor, West Bromwich.]

A very simple and decisive demonstration could be made to settle the question whether it is horse traffic that acts primarily

and directly in disintegrating the highways. Let a short loop be made at a convenient place where the road is frequented by horse and autocar traffic. Let both sides of the loop be laid down exactly in the same way, and direct each class of vehicle to use one side of the loop only. I can say from my own experience that the result is certain. Where I live in summer there are two avenues. On one there is practically no horse traffic, and the autocar tracks are smooth and free from holes. On the other there is daily horse traffic—railway and tradesmen's carts, etc. On that avenue holes are constantly forming and have to be filled up. One can watch from day to day the formation of these holes by the picking and crushing action of the horseshoes and narrow metal tires.—[The Right Hon. Sir J. H. A. MacDonald, K.C.B.]

In the first place the greatest creators of dust may be taken to be the hoofs of animals. Although wheels create dust also, even when rolling over the road without exerting any propelling force, they do not make dust to anything like the same extent.

The second most potent creators of dust are narrow-tired, heavily-laden carts.—[The Right Hon. Lord Montagu of Beaulieu.]

Use of Various Surface Preparations.

To cope with the dust nuisance, surfaces have been sprinkled with calcium chloride solution, and, although the nuisance has been somewhat minimized, the success has not been great. On each section of road that has been sprinkled in the manner indicated it has been noticed that the surface has worn into holes more rapidly than the adjoining surfaces which were not sprinkled.

With the present experience the author is of opinion that tar spraying or painting the surface of a road well constructed with hard stone on a strong foundation promises the best and most economical results, both in the matter of dust abatement and suitability for modern traffic. Waterproofing the roads in this manner enables the camber of the road to be reduced to a minimum. Care should, however, be taken to properly construct the road with hard surface material on a sound foundation, and to tar the surface before it has been worn into holes or depressions, as it must not be expected that tarring of the surface will convert a bad road into a good one.—[Geo. A. Phillips, A.M.I.C.E., County Surveyor of Glamorgan.]

Taking into consideration the items of utility and cost and the facilities for construction and repair, the author is of opinion that of macadamized roads, one constructed with good stone (water-bound) on a proper foundation, and the surface properly coated with hot coal-gas tar, is the best. The system of tar-spraying roads by machinery has greatly facilitated and reduced in cost what the author considers one of the greatest boons conferred upon the

users of macadamized roads. It lessens wear and tear, prevents damage by suction of pneumatic tires, reduces dust to a minimum, reduces mud, and generally increases the life of the road.—[Henry E. Stilgoe, M.Inst.C.E., Birmingham City Engineer and Surveyor.]

It may be safely said that the best method by which the effect of these dust-creating agents can be counteracted is to make the road waterproof, and the cheapest way to make it waterproof is to tar it. If, therefore, it is possible to lay tarred material at the start, that plan is the best of all. But if not, a coating of tar is the next best thing. The complete removal of dust from our roads is, from an engineering point of view, perfectly practicable, and the only problem now is one of cost.—[The Right Hon. Lord Montagu of Beaulieu.]

Sucking Action of Pneumatic Tires Not Proven.

It is necessary here, therefore, to point out that what is called the "sucking action" of pneumatic tires has never been proved to exist. Certain portions of the Great North Road, which two years ago showed grooves due to the action of the studded tires, since they have been repaired and tar sprayed to a sufficient depth to ensure the tar penetrating $\frac{3}{4}$ -inch from the surface, now at the same places show no sign of grooving. At the same time, I deprecate the use of steel-studded tires. The crushing pressures and the forces of impact of pneumatic-tired wheels are so low that little is gained by increasing their diameter. It is fortunate that this is the case, as increasing the diameter of rubber-tired wheels is a very expensive luxury.—[Col. R. E. Crompton, C.B., R.E., M.I.C.E., M.I.E.E.]

On surfaces which have been treated with tar, or are made of a hard, unyielding material, the motor car wheel causes practically no damage, and it should produce no appreciable wear compared with steel-tired wheels. A steel-studded tire is, however, far more destructive in its effect than an ordinary plain rubber tire. But as long as dangerously skiddy surfaces exist it would be undesirable to absolutely prohibit the use of a metal-studded tire.—[The Right Hon. Lord Montagu of Beaulieu.]

Advocates of Increased Wheel Diameters.

It appears likely that the only practical method of reducing these crushing strains is by increased wheel diameters, and by reducing the axle weight by dividing the load carried or propelled over a greater number of axles.

With modern wheels made of iron or steel, the weight of the wheels for equal rigidity, durability, and strength increases only as

the diameter, and I hope that the removal of this error may encourage designers to increase the wheel diameters in future road vehicles.

The question of the springing of road vehicles running at a high rate of speed remained until recently a mystery confined to a few coachbuilders, but, thank to Mr. Lanchester and others, the science of springing, and of the location of the vehicle so as to obtain the best results, has received a great impulse.—[Col. R. E. Crompton, C.B., R.E., M.Inst.C.E., M.Inst.E.E.]

There is not the slightest doubt that a light car is the coming vehicle for all purposes, but before the weight of the car can be appreciably reduced, the condition of the roads must be improved. A better road surface will render unnecessary the extra weight called for to resist the shocks of defective roadways. To obtain this and the most economical rolling contact between the wheel and the road, the skill of the two different people concerned is required.—[Sidney H. Chambers, Engineer and Surveyor, Hampton Urban District Council.]

All Users of the Road Should Pay Their Share.

The remedy is not to be found in returning to the exploded system of taxing the actual wheels that pass over the road surface, and the enemies of motors will be well advised not to press this contention too far. If those who use the roads and those who destroy the roads are to pay for them, it may well be found as the result of a scientific inquiry that the tax will fall with overwhelming weight upon the horse-drawn vehicles, which seem now to flatter themselves that they have some exclusive right to destroy the roads uncriticized.—[Earl Russell.]

Necessity for a Central Government Supervisory Department.

It is submitted that these considerations show the absolute necessity for a central government supervisory department, or, perhaps, a specialized branch of the local government board, whose duty would be to inspect the main roads throughout the country and satisfy themselves (a) that those roads are maintained at a proper standard, and (b) that the standard is obtained by the most efficient and economical methods.

Since it appears that the chief defects in the existing system are capable of improvement by comparatively simple means, it is submitted that the county, aided by the purse and inspected on behalf of the government, would form the most convenient and experienced unit for main road administration throughout the country.—[F. H. Berryman, Chairman of the Highways Committee of the Somerset County Council.]

GERMAN STATISTICS NOT ASTOUNDING.

BERLIN, May 20—According to figures up to January 1, 1909, there were the following number of motor vehicles in the German Empire on this date: 39,475 vehicles, used principally for conveyance of persons, among these being 20,928 motorcycles; 9,434 cars of up to 8 horsepower; 5,441 of up to 16 horsepower; 3,595 of 16 to 40 horsepower, and 77 of 40 and more horsepower. There were further 2,252 vehicles principally used for the conveyance of goods; 248 of this number were cycles; 1,035 cars up to 8 horsepower; 502 from 8 to 16 horsepower; 448 from 16 to 40 horsepower, and 19 of 40 horsepower and more.

Of the vehicles used for the conveyance of passengers 395 were in the service of public departments, such as post, army, navy, home, etc.; offices; 2,340 were public conveyances (cabs and omnibuses); 16,110 served industrial and commercial ends; 427 were in agricultural usage; 4,641 were used by other professions (medical, land surveying, etc.) and 15,562 for sport and private use, a figure that seems intolerably small to English and American ideas.

The goods vehicles are divided as follows: 143 in the service of public departments; 2,059 for commerce and industry; 24 for agricultural purposes and 26 others not classified.

The Austrian *voiturette* reliability tour of the Austrian Automobile Club on the Vienna-Trieste-Klagenfurt-Vienna route, May 6 to 9, brought another victory for the Opel cars, as the only one entered and driven by Koch forged ahead early in the event and eventually landed in Vienna far ahead of all competitors. The very difficult first day's run of 500 kilometers knocked several *voiturettes* out of the competition, but all those that arrived in Trieste held out to the finish. The team prize went to the Austrians, which came in third, fourth and fifth.

AUTO NEWS MADE IN GERMANY.

The guarantee fund for the Frankfort Aeronautic Show has now reached a million marks; a sum of 13,000 marks has been presented by various persons for prizes.

The first speed trial of the Prince Henry Tour will be held on the flat between Guben and Krossen, over a stretch of six kilometers. The road leads through a forest, has hardly any intersecting paths, and no traffic worth mentioning.

The Prussian War Ministry has bought a large territory on the Russian frontier on which to erect a balloon station. The news that Metz is to be the home of one of the Parseval has aroused much activity in France, and it has been decided to construct two sheds on the other side of the black and white sign posts, one at Nancy and the other at Epinal. The easily aroused Frenchmen are much disturbed over the incident.

The German commercial car trials have come to a successful end at Stuttgart, while the military vehicles will return to Berlin by road. The last stages passed over so quietly that the daily official reports only dealt with the roads taken and the exhibitions at the various industrial centers the cars passed through, and this in spite of the tortuous roads South Germany is so rich in. All through Baden and Durttemberg road men were posted at every wayside stone with pencil and book, the authorities being so much on the alert that they gave rise to a much laughed at incident. At Freiburg a police official was sent out with a bell to cry out the news that the great motor race would pass through the town that morning and parents had best look after their children. The race idea spread by police headquarters at Karlsruhe reached over to Baden-Baden, as at the Oos cross-roads numbers of smart motors were pulled up to watch the "race," and when the heavy monsters came lumbering into view disappointment was rife.

NECESSITY OF STATE GOOD ROADS ASSOCIATIONS

By GEORGE C. DIEHL, CHAIRMAN GOOD ROADS BOARD, AMERICAN AUTOMOBILE ASSOCIATION.

THE importance of State good roads associations is not appreciated in the majority of the States throughout the country. This is especially true in the States which have built a great many miles of roads with State aid. In many States the only good roads organizations are those which are composed entirely of the motorists. While the motorists, consistently supported by the Association of Licensed Automobile Manufacturers, the National Association of Automobile Manufacturers and the American Motor Car Manufacturers' Association, do not begrudge the time which they spend in these organizations, they feel that more valuable results could be obtained by having associations representative of not only the motorists, but of the farmers, the county commissioners, county boards of supervisors and the minor highway officials throughout the States.

Such organizations permit the chief highway officials of the State to keep in touch with public sentiment, and disseminate the knowledge gained through the experience of such officials. They also act as a check upon the chief highway officials when inclined to follow unwise counsels. These State associations should meet regularly, and suggest the proper form of new highway laws and desirable amendments to the existing statutes.

These State associations should meet regularly, and suggest the proper form of new highway laws and desirable amendments to the existing statutes.

Two important subjects which State highway associations could properly urge are:

First—The construction of permanent masonry bridges.

Second—The improvement of town or lateral roads.

Bridges—Few of the States aid in the construction of bridges. The entire burden of construction must be borne by the township or local municipality. The result, in sections where bridges are numerous, has been that inferior structures have, owing to lack of funds, been erected. The type usually adopted in such cases has been a light iron or steel superstructure, with plank flooring and railroad-iron pile substructure—or poorly laid rubber abutments. The life of such bridges does not exceed usually thirty or forty years, and if not promptly replaced they constitute a menace to all users of the highway. The usual renewals consist of placing an inferior iron or steel bridge over the old weakened foundation.

The local highway officials not having technical training are frequently misled or corrupted by unscrupulous agents. The bridges constitute an absolutely essential part of the highway and should be erected under State supervision and in part at least at State expense, with the result that in place of weak and inferior structures, solid, attractive and durable concrete bridges will be erected, as an enduring monument to the highway officials in charge of such work.

Concrete Bridges—The cost of erecting a reinforced concrete bridge is little, if any, in excess of the cost of a properly designed steel structure. The cost of repairs and maintenance of concrete bridges is nothing; consequently they endure for

ages. Such structures are attractive in appearance, safe at all seasons, pleasing to the eye and eliminate probability of accident.

Town Roads Materials—So much has been said about brick, stone and macadam pavements that the fact that the vast majority of roads must for many generations be dirt roads, is rather lost sight of. By proper care and supervision, under appropriate laws, these roads can be made, for the greater part of the year, almost as satisfactory as hard-surface roads. To show the impossibility of macadamizing all of our roads in one generation, or in any limited period of time, it is sufficient to say that there are over two million miles of roads in the United States; macadamizing costs not less than \$5,000 a mile, and usually more than that. At the lesser cost the aggregate expenditure to improve all the roads in the country would be 10 billions of dollars, or a hundred million of dollars a year for 100 years.

The main roads, upon which traffic is heaviest, and which accommodate the greatest population are estimated to be less than 10 per cent. of the whole. The ultimate improvement of these main roads can be reasonably anticipated, if public sentiment is properly aroused.

Improvement of Main Roads—This should not take all the energy and appropriations, but should go forward hand in hand with the improvement of town roads. In some localities for many years the entire amount of highway taxes, whether payable in cash or labor, has been expended in temporary work; while nothing has been spent for permanent improvements, with the result that the condition of the town roads remains unchanged. The roads in some places are no better to-day than they were 50 years ago, notwithstanding the labor and money expended.

There is annually expended on the town or lateral roads of the country \$55,000,000 in cash and \$20,000,000 in labor. To secure a proper improvement of the town roads it is necessary to abolish the labor tax which is in vogue in about 35 States and to substitute a money tax. It is also necessary to spend a certain amount each year for permanent improvements, in order that each year may see constantly improving road conditions. Many local officials are inexperienced; it is desirable to have the chief highway officials of the States advise and superintend the work done by local officials upon the town roads. Such supervision implies that there should be State aid in cash for town roads.

Under such circumstances it is not difficult to enact fixed rules and regulations which can provide in most cases that not over one-half of the town highway tax shall be expended for highway repairs and maintenance and that the other half shall be used to construct permanent improvements.

Under such a system, in addition to such State and national aid as public sentiment might enforce, there would be expended for permanent betterments about forty millions of dollars annually on the lateral roads through the counties.

The more important lateral roads connecting with the main State roads should be first improved. We must have a steady increase in total mileage of improved roads, main and lateral.

ROAD IMPROVEMENT EVER THE PARAMOUNT ISSUE

By G. VERNOR ROGERS, SECRETARY AMERICAN MOTOR CAR MANUFACTURERS' ASSOCIATION.

WITH the coming Spring and renewed touring, the matter of good roads is once more, and more forcibly than ever, a paramount issue with the automobilist, horse owner, the farmer, the pedestrian and, above all, the country school children who have to travel considerable distances from their homes to the district schools. Again has the fact been thrust upon us that the greatest and wealthiest of all governments—the United States—is far behind foreign countries in good road building. The whole country is stirred as never before, relative to this great

question of highway improvement. If there is anything in the world that a good citizen who loves his State and that his civic or State pride delights in, it is to have the city and the State reputation maintained.

To-day the finger is pointing as never before to the attitude of the States toward this question; and a State's reputation for enterprise, progress and all that goes to make it worth living in, is determined very largely by the character of its roads—the arteries through which flow the business and pleasure life of a State.

Whenever a farmer loads his wagon he has in mind the worst part of the road over which he has to go, whether that be one or five or six hundred feet long, or has a hundred feet or a hundred miles of good road at each end. He knows that its worst hill or mud hole limits the size of the load he can haul.

Because this is so, every bit of road connecting those on which state money has been spent should be made so good that no mud holes, steep grades, no "worst spots," in short, will be left to limit the wagon-load to less than can be, without difficulty, hauled the entire length of the system of improved roads. There should be no breaks in this chain; no interruption in these great arteries through which flows our industrial life.

The Country Life Commission recently appointed by President Taft, in its report to Congress, makes many interesting statements which, if adhered to, will ultimately result in universally better roads in this country.

The demand for good highways is general among the farmers of the entire United States. Education and good roads are the two things most frequently mentioned by farmers. The Commission in its report says: "We hold that the development of a fully serviceable highway system is a matter of national concern, co-ordinate with the development of water ways and the conservation of our native resources. It is absolutely essential to our internal development. The first thing necessary is to provide expert supervision and direction and to develop a national plan. All the work should be cooperative between the federal government and the states. The question of federal appropriation for highway work in the United States may well be held in abeyance until a national service is provided and tested. We suggest that

the United States government establish a highway engineering service, or equivalent organization to be at the call of the states in working out effective and economical highway assistance. That highway improvement is the most important economic reform, has long been urged by the farmers, who, through their principal organization, the National Grange, have been persistently agitating for the adoption of a policy of federal aid for good road construction and maintenance."

The declaration by the Country Life Commission that the establishment of a fully serviceable highway system is a matter of national concern, absolutely essential to our internal development, should serve to hasten the enactment of legislation, provide for the creation of a National Highways Commission, and make liberal appropriations for carrying on its work. This is in full accord with the desires of the American Motor Car Manufacturers' Association which has already contributed a considerable sum of money toward the betterment of good roads in this nearly up-to-date country.

The need for a new kind of country school cannot be met, so long as our dirt roads, which at certain seasons, are almost impassable, prevent the attendance of the farmer's children at centralized schools where they can have all the advantages of a graded school in connection with a high school. Central schools of those kind are now being established in some sections of the country, where good roads permit of the pupils of the entire township being transported to them daily from their homes, and with the extension of improved roads, its school system would become general. In this way, better roads mean much higher education for the country children, a wholesale blessing.

TOURING BECOMES A NATIONAL HABIT

By S. D. WALDON.

AN epidemic of touring is over the land. Largely as the result of the work of the pioneer American manufacturers, constituting the Association of Licensed Automobile Manufacturers, the one-time boulevard autoist now seeks enchantment on the broad country road. He rolls from asphalt to macadam, from macadam to gravel, and from gravel to dirt.

There are now over two hundred thousand motorists in this country. Joyously they take to the wandering ways, among tall shade trees, in the midst of green garbed hills and stone-empaled valleys, or free on the open prairie, in mountain fastness or out on the desert lands.

Many a man who has driven his car around the four corners of his own and neighboring States could not tell you the name of the winner of a Vanderbilt cup race. But these tourists take thousands of roads in scores of kinds of cars and have tens of thousands of stories of pleasant autoing experiences to tell. Collectively, they represent one of the greatest movements for countrifying city-tired denizens.

Individually, the tourist, despite the serious import of the part he plays, is often interesting. He is essentially a modern highly-developed man, taking no part in the spectacular features of autoing. Few accomplishments have created as much

general interest as the recent Pacific to Atlantic trip of a business man and his family, five in number.

The intent of many miles of travel does not rob them of their enchantment or of the pleasure afforded by the many shifting scenes. There is always to be encountered a fresh picture; some tourist trying out the roads in a new way.

The road ahead, say, winds recklessly along the crown of a ridge to where the sky, coming down, blue and fluffy, meets the Alleghanies going up, dark and solid. Or the road turns and ends in a wall of underbrush. It comes out of the forest from above, but the connecting link between the path under-wheel and the one sticking out of the trees to the very top of the mountain is lost. So is a moving picture halted by cutting out a strip of the endless film.

Thus the autoists go. Some bold, some timid; some fast, some slow. Every mile of their many pournays is crowded with incident, like a long story which upwinds, chapter after chapter, always telling something new.

It is all a part of experience, which, multiplying, will dot the landscape with automobiles. Thus we are making a new national habit and yet, we hope, a lot of national pikes. Which is the most beneficial to the country as a whole is hard to say.

MARYLAND MAY EMPLOY CONVICTS ON ROADS

BALTIMORE, May 10—Convict labor will be used in constructing good highways in this State if the efforts of Governor Crothers, backed by the Democratic party, are successful. The chief executive will request the next General Assembly to pass a law making it permissible for prisoners now incarcerated in the Maryland penitentiary in this city, the house of correction, and the county jails to do this work. This is in line with Governor Crothers' economic ideas of roadbuilding. While the last Legislature authorized a loan of \$5,000,000 for improved roads in the counties and this city, it now looks as though it will be necessary

to ask the next General Assembly to make another appropriation of \$6,000,000 to complete the work mapped out by the Good Roads Commission. The Governor believes that the employment of convict labor, together with the revenues to be derived from the proposed tax on automobiles, leases on oyster beds, inheritance taxes, and a probable income tax, will enable the State to satisfactorily meet the interest payments on the present loan and any other loans that may be granted in the future. So is the cause of good roads forwarded all over the country, each State, county and township, in its own individual way, furthering the same end.



Georgia Convicts Cutting Road Through Solid Rock.

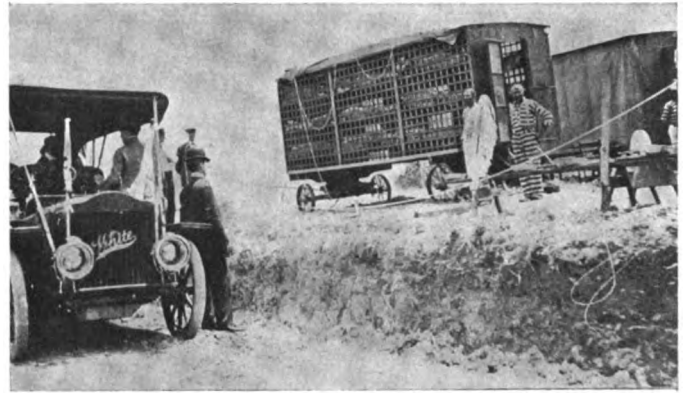

Convict Sleeping Wagon Near Lawrenceville, Ga.

GEORGIA NOW SEES THE NECESSITY FOR REAL ROADS

ATLANTA, GA., May 20—Traveling steadily for nearly five days and covering 490 miles in that time, the White Steamer, scouting for the *Atlanta Journal*, rolled back into Atlanta after having threshed out with extreme care some proposed routes for the New York-to-Atlanta endurance test.

This last day's run will presumably cover about 120 miles and will carry the tourists from Greenville, S. C., to Atlanta. Using this run as a basis the scout car worked out with no small difficulty the routes to Atlanta, which are two in number.

The limiting of the number of routes is the result of a typically Southern condition of affairs—a lack of bridges. To go from Greenville to Atlanta the Savannah River must be crossed. And on anything like a direct line between the two towns there are just two ways to cross—by a ferry on the south route and by a bridge on the north.

In threshing out these two ways between Greenville and Atlanta the scout car cruised about for five days, tackling roads of all sorts, from highly polished macadam to lumpy, gullied, rocky, steep side-hills with only faint tracks indicating where a road was supposed to be.

The first day's run was from Atlanta to Lavonia and was without event save that at every town on the route the citizens and city officials—mayors and councils, ordinaries and extraordinaries, sheriffs and convict keepers—turned out to welcome the car and to show cause why the run from New York to Atlanta should come directly through that town. The enthusiasm was in no way short of marvelous. Little towns where perhaps not more than an automobile or two was owned would turn out with the two cars to meet the scout and escort it into the city limits, where there would be a brass band to welcome the delegation and a general outpouring of citizens.

"What do you want done to our roads?" was ever the question, and by taking road commissioners and road builders out in the car and showing them exactly what was needed a lot of great educational work was done. Georgia has convicts on the roads at last and is prepared to do vast amounts of road building. Intelligent directions are now the only things needed.

From Lavonia the car went first to test the Knox Bridge over the Tugalo River. This was found to be in good condition. Then the machine doubled back over another route toward Atlanta, then turned again at Commerce and went straight to Anderson, S. C., where the second night was spent. The Savannah River was crossed at Brown's Ferry.

This ferry is an antiquated bit of machinery—a flat-bottomed craft, just big enough to hold one automobile. At each end of the boat is fastened one end of a long cable. This runs through pulleys fastened on each bank. When the boat is pushed off it is fastened at such an angle that it crosses the stream as a result of the action of the current—after awhile.

A little mathematical calculation shows a bad defect of the route that includes Brown's Ferry. It takes 30 minutes for each

round trip and only one car can be carried over at a time. It takes but six hours to run from the west side to Atlanta. Therefore if each car got away immediately after it was ferried across the first car would be in Atlanta when the thirteenth was getting over the river. If there were as many as 30 cars in the run the last one would not be across by dark if the first one started by daylight.

The third day out the car doubled back from Anderson to the river, this time examining the South Carolina side of the route to Knox Bridge and then doubled again and returned to Anderson by another route. From that point the car went straight on to its most northeasterly destination—Greenville.

The return trip was made in two days. On Monday the White ploughed its way over hills and down terrible grades through the shank end of the Blue Ridge, across Jarrett's Bridge and to Gainesville, Ga. Then it had an easy home run.

"Herald" Scout Car Leaves New York

NEW YORK CITY, May 25—To lay out the route of the proposed endurance run from this city to Atlanta, under the auspices of the *New York Herald* and the *Atlanta Journal*, R. H. Johnston and a party in his White steamer started Southward this morning. They expect to travel via Philadelphia, Gettysburg, and Staunton, Va., stopping overnight in each of these places, and will continue South wherever the roads are best. There is an Oldsmobile traveling northward, and when the two meet the Olds will turn and both work towards the southern terminus of the contest. This route is a tentative one, and may be changed if some other itinerary in the South proves more acceptable. With Mr. Johnston were Major John S. Cohen, managing editor of the *Journal*; Nathan Lazarnick, the photographer, and Hamilton Peltz, of the *Herald*.

Georgia's Substantial Auto Enthusiasm

ATLANTA, GA., May 22—At a meeting of business men and automobile enthusiasts at the Atlanta Chamber of Commerce, May 22, \$100,000 was subscribed in ten minutes toward the \$225,000 necessary to build Atlanta's two-mile auto track. Already land has been purchased near Atlanta and work will be started at once. It is proposed to have the track, grand stand and whole plant finished by November and to have the first race meeting of any importance take place at that time. Thus, a race will be pulled off as quickly as is possible.

Georgia's eight endurance runs to Atlanta in November, all so timed as to bring the cars to the city just before the automobile show, promise to be notable events well worth racing in. Already \$5,000 has been hung up in prizes for cars and roads. The scheme was started by the *Atlanta Constitution* and that paper put up \$2,500. Other donations have been: Fitzgerald, Ga., \$1,000; Savannah *News*, \$500; Savannah Automobile Club, \$500; Atlanta *Journal*, \$1,000.

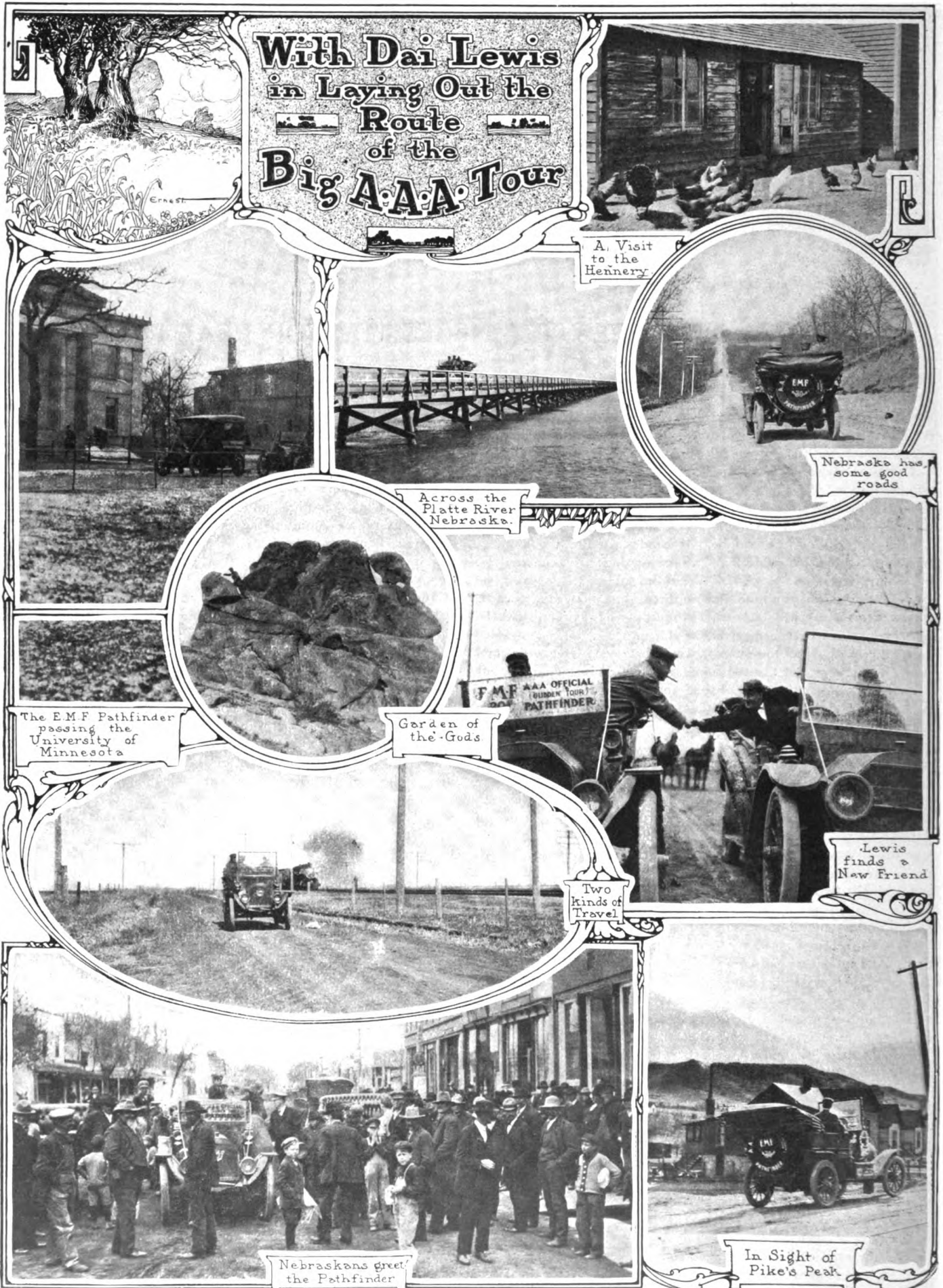

**With Dai Lewis
in Laying Out the
Route of the
Big A.A.A. Tour**

A Visit
to the
Hennery

Across the
Platte River
Nebraska.

Nebraska has
some good
roads

The E.M.F. Pathfinder
passing the
University of
Minnesota

Garden of
the Gods

Two
kinds of
Travel

Lewis
finds a
New Friend

Nebraskans greet
the Pathfinder

In Sight of
Pike's Peak

GLIDDEN PATHFINDER WILL SEEK NEW ROUTE TO OMAHA

THOSE automobilists who expect to participate in the Glidden tour of the A. A. A. this summer have been calling for the most strenuous test yet held, but at the same time they will want roads which are passable. Inasmuch as parts of the route mapped out by Dai H. Lewis, the pathfinder in the E-M-F touring car, were well-nigh bottomless, it has been decided that a different course should be taken. According to directions from Chairman Hower, the E-M-F was shipped last week to Minneapolis after having completed a circuit to Kansas City, and a new direction towards Omaha will be tried. The Iowa gumbo on either side of Fort Dodge, extending northward into Minnesota, was such that oftentimes the pathfinder could hardly move, and this condition must not be when the tourists are on the road. Therefore, it is possible that the car will go directly south from the Twin Cities to Mason City, and diagonally across Iowa, but even the direction remains to be seen. It is not known whether Fort Dodge will be touched or not, although Mr. Lewis says that he does not like to cut off places where he was royally entertained, and where even the farmers went out on the roads ahead of the car, and tried to improve them so that some head-way could be made.

After several exciting experiences in southeastern Colorado and in Kansas the car reached the terminus of the route, but

under difficulties, for rain, snow, hail, and washouts interfered. The weather in that part of the United States cannot be depended upon, and according to best authorities the fact that roads in the East are better in summer than in winter or spring does not guarantee that such will be the case in Iowa next July. The route which will be examined within the next few days by Lewis will follow a ridge of higher country than the route tentatively selected early in the month. It is also very hilly, and more picturesque on that account, and Mason City is said to have better hotel accommodations for such a large party than has Mankato. The outlining of the route has not been the only matter which has given the authorities concern, for they are constantly being besieged by enthusiastic autoists of the Middle West, who want to entertain the party as it passes through, and who want to have the night stops arranged to occur every few miles. Council Bluffs and Omaha had a very spirited contest, but it is likely that the latter city will be chosen. In Denver the pathfinders were tendered a banquet, which was attended by Governor J. H. Shafroth, Senator T. M. Patterson, Senator John S. Irby representing Mayor Speer, and many officials prominent in State and city affairs. The car was met on the outskirts of the city and a parade of 147 automobiles made up to escort it through the streets.

FROM MAKERS, BUT INTERESTING TO USERS

FRANKLIN ENTRIES IN THE GLIDDEN.

Editor THE AUTOMOBILE:

We are forwarding you herewith a statement showing the position of the Franklin company in regard to the making of a conditional entry of Franklin cars for the Glidden Tour.

H. H. FRANKLIN MFG. CO.

The fact that the entry of four cars for the coming Glidden Tour has been made conditional by the H. H. Franklin Manufacturing Company places emphasis upon the growing effort to secure stricter rules and more rigid enforcement for this event. It specially brings out one matter in connection with the schedule of daily running time.

It is insisted by the makers of the Franklin that if these cars are to participate in the tour the time schedule for the daily runs shall be unalterably fixed before the start of the tour instead of being revised from time to time during the tour at the wish of some one whom those in charge may see fit to listen to. It is urged that a fixed schedule is fair to all and that, on the contrary, it is favoritism to change the running time when weather changes produce road conditions which some of the cars are by reason of their construction much less able to cope with than others. The Franklin company wants all to take conditions as they come, sharing alike and letting the results accentuate the difference in what the several cars are able to do.

The authorities are also called upon to fix in advance of the tour the deterioration rules and leave them unchanged up to the finish, each regulation being given specific interpretation in advance so that there may be no conflict of opinion later. There is determined opposition to the possibility of a committee watching part or all of the actual performance of the cars in the tour before deciding what the relative penalization shall be for the various items of deterioration.

These calls for specific and rigidly enforced rules are a part of effort which has been made to have penalization provided for defects and deterioration of every part of the car, including tires, brakes, carbureters and clutches.

THAT GAETH PENALIZATION IN BALTIMORE RUN.

Editor THE AUTOMOBILE:

We note in connection with your published statement of the Baltimore reliability run, in the miniature tonneau class, that you had the Gaeth penalty consisting of 45 points due to leaky gasoline tank and exhaust pipe.

Our Baltimore agent, F. W. Sandruck, advises that the total penalty was only 12 points, due to the breaking off of rear muffler pipe, and we wish that you would take the opportunity as soon as possible of publishing this correction and stating the fact as above.

We hope you will appreciate the situation, as an incorrect statement in a matter of this sort creates a very bad impression.

THE GAETH AUTOMOBILE COMPANY,
L. E. STONE, Secy. and Treas.

LOZIER GEAR REDUCTION AND DIRECT DRIVE.

Editor THE AUTOMOBILE:

The deduction which you make from the official statistics of the One Gallon Contest in the last number of THE AUTOMOBILE are quite interesting, but we wish to set you right on an assumption you have made regarding the gear used by the writer on the Lozier 6-cylinder car which won first place in the big car class, and third place in the contest—we refer to the following statement, viz.:

"The Lozier figures back to less than 300 engine revolutions if the high gear was used. As this very slow speed of the engine would not be an economical one, it is doubtless true that the driver of this car pinned his faith to a lower gear than the direct drive, figuring that the other economies attendant upon this would offset the transmission losses on the indirect speed."

The official table gives the gear reduction of the Lozier car 2.4 to 1. As a matter of fact, this is the reduction of the fourth speed, but which, as a matter of fact, is an indirect gear, the direct drive to which you refer being the third speed, and which is generally used in touring and in speeding up to fifty-five miles per hour.

The direct or third speed with a gear reduction of 3 to 1 is the gear which was used from start to finish, and this gear was not shifted, except in three or four cases, when the fourth or indirect high gear of 2.4 to 1 was used on level stretches or down hill.

As you state, it would be natural to assume that the slow speed of the engine would not be an economical one, but as a matter of fact, at the average speed of thirteen miles an hour, which was maintained during the run, the speed of the engine varied from 400 to 750 revolutions per minute.

We may be pardoned for stating that the performance is all the more remarkable through this fact, as the official statistics show that the car had the greatest windage, had the highest-powered motor, and carried the largest live weight of any car in the contest.

LOZIER MOTOR COMPANY,
C. A. EMISE.

The amended facts as set forth by Mr. Emise above show that the engine speed figured from the gear reduction of 3 to 1 would be 367 revolutions per minute average, and not 400 to 750, as he states.

This year's international automobile conference takes place June 15 at Vienna, when the Austrian Automobile Club will play the part of host. About thirty delegates are expected, and they will be in time to join in the festivities in honor of the Prince Henry Tour, which is booked for Vienna on this date. Much interest is being aroused as the time draws near.

THE AUTOMOBILE

Vol. XX.

Thursday, May 27, 1909

No. 21

THE CLASS JOURNAL COMPANY

H. M. SWETLAND, President
A. B. SWETLAND, Business Manager
231-241 West 39th Street, New York City

EDITORIAL DEPARTMENT

A. G. BATCHELDER, Managing Editor
R. F. KELSEY, Associate Editor
THOS. J. FAY MORRIS A. HALL W. McK. WHITE D. R. HOBART
W. F. BRADLEY, Foreign Representative

ADVERTISING DEPARTMENT

M. C. ROBBINS, Manager
W. L. RALPH, 1034 Old South Bldg., Boston
C. H. GURNETT, 1200 Michigan Ave., Chicago
F. W. VAN SICKLEN, }
LOUIS R. SMITH, New York
FRANK B. BARNETT, Cleveland
H. H. GILL, Detroit
T. B. VAN ALSTYNE, Philadelphia

Cable Address - - - - - Autoland, New York
Long Distance Telephone - - - - - 2044 Bryant, New York

SUBSCRIPTION RATES:

United States and Mexico - - - - - One Year, \$2.00
Other Countries in Postal Union, including Canada - - - - - One Year, 3.00
To Subscribers—Do not send money by ordinary mail. Remit by Draft,
Post-Office or Express Money Order, or Register your letter.

FOREIGN SUBSCRIPTION AGENTS:

ENGLAND:—W. H. Smith & Sons, Ltd., 186 Strand, London, W. C., and all book-stalls and agencies in Great Britain; also in Paris at 248 Rue de Rivoli.
FRANCE:—L. Baudry de Saunier, offices of "Omnia," 20 Rue Duret, Avenue de la Grande Armee, Paris.
GERMANY:—A. Seydel, Mohrenstrasse 9, Berlin.

Entered at New York, N. Y., as second-class matter.
The Automobile is a consolidation of The Automobile (monthly) and the Motor Review (weekly), May, 1902, Dealer and Repairman (monthly), October, 1903, and the Automobile Magazine (monthly), July, 1907.

TWO KINDS OF TRAFFIC THE TROUBLE.

In the recent good roads conference in England a number of points were brought out which were so well taken as to compel attention. One of them dealing with the subject of road surface erosion, as brought about by rapidly passing automobiles, is that the fundamental idea of using the same roads made in the same way for two radically different kinds of traffic, such as the horse-drawn and the self-propelled, is wrong.

The discussion brought out good and sufficient reasons for this as follows: The horse, by means of the caulks on his shoes, loosens the surface into a number of small heaps of material, and the narrow-tired vehicle adds to the wear and tear, which the fast-moving automobile then scatters and carries along. The latter at any rate, and regardless of how it is done, disperses all of the loosened surface material, but does no further damage.

Reasoning from this, the present remedy,—impossible of course,—lies in the segregation of traffic into self-driven and horse-drawn, on roads reserved for each, and built each for its particular service, this being continued until the rapidly decreasing horsed traffic is reduced to a minimum, in which case the road reservation would no longer be necessary.

In the manner set forth, the surface of the horse road would remain in the position in which the horse left it until another vehicle rolled it back into place, with the

result that nothing would be lost. So, with the automobile road, the surface would not be cut up into dust for the rotating wheels to distribute over the landscape, because the road being made specially would be oiled or otherwise surfaced for the service which it had to undergo.

* * *

A LESSENERED NUMBER OF CYLINDERS?

Following the extreme swing of the power and number of cylinders pendulum of two years ago, toward the maximum and approaching what was once facetiously called "road locomotives," there is something of a tendency to-day toward the other extreme, the backward swing of the pendulum.

This was first apparent in the foreign market. Not only were cab chassis brought out in large numbers powered with the despised (of two years ago) two-cylinder engines, but also numerous private cars of small sizes. Following the lead of the Continental engineers, English makers took up the same trend, but more conservatively. Now, time having shown the wisdom of this policy in the success of the two-cylinder cabs plying in London, the makers of the Isles are about to throw conservatism to the winds and go deep, very deep, into the lowly two-cylinder vertical engine.

And what has been done in this country in the same line? how many cars of this type are to-day to be had in the open market, and what progress in experimentation is being made? This is best answered in figures. There are five American makers putting out engines with less than four vertical cylinders, but of these two are two-cycle and one air-cooled, which reduces the number to two, and both the product of the same engineer.

Seeing, then, that the American maker is apathetic toward this important question, let a few of the real and very apparent advantages be brought out for inspection, taking, for example, the two-cylinder engine. Poor balance mechanically is urged against it, but, in the light of modern progress in and fuller knowledge of the art of balancing, it would appear as if this one prominent disadvantage has been looked at so long that it appears out of all proportion to its importance. It is true that the two-crank two-cylinder engine has an irregular turning effort, but the two-cylinder single crank motor has not, as the explosions occur at regular intervals. With this arrangement, much used on aerial engines, the matter of balance reduces to one of compensating for the extra piston and connecting rod; surely not a difficult task.

There have been a number of reports of cars projected for the season of 1910, and these have included various engines differing from the regular four-cylinder, now general, but not one of those advanced has included the motive power discussed above, namely, the two-cylinder. If old-established houses with fame and prestige like Panhard, De Dion, Renault, C. G. V., and others in France; Adler, Laurin-Clement, Opel, and others in Germany; Siddeley, Napier, Arrol-Johnston, Humber, and more in England; to say nothing of Züst, and cars of similar quality elsewhere, if these firms can build and sell a two-cylinder vertical engine without damaging the reputation of years, but rather enhancing it, what have the American manufacturers to fear in following their lead? Surely here is the chance to capture the medium-priced trade of America's numerically great middle class.

OLD BAY STATE WILL HAVE AUTO MANEUVERS

BOSTON, May 24—When word is received by the Massachusetts military authorities some time between August 14 and 21 that the State of Massachusetts is threatened with invasion by a hostile naval force—the signal for the beginning of the summer military maneuvers—one of the first acts of Adjutant-General Brigham will be to call out the automobile corps that it is proposed to form. And from then on motor vehicles promise to play a most important part in the defense of the Massachusetts coast. According to the plans for the maneuvers only twenty-four hours' notice will be given of the advance of the enemy, which means that the State militia and the United States soldiers quartered in this State will have to work lively in order to protect the long line of coast from Newburyport to the tip end of Cape Cod and to Buzzards Bay, and it is for this work that the automobiles are to be enlisted.

It is proposed to ask the members of one of the crack military organizations, such as the First Corps of Cadets, to supply forty or fifty cars for the eight days of the maneuvers. If the First Corps can supply all the cars that are needed it may be organized as a motor corps and given special work all through the maneuvers. Otherwise a special motor corps will be organized with an experienced motorist and military man at its head. Besides the forty or fifty cars, the military authorities are planning to secure a number of motor trucks and many motor cycles, the former to carry baggage and supplies between the depot at South Framingham and from camp to camp, and the latter to be ridden by dispatch bearers.

One of the first things to be done after notice of the threatened invasion is received will be the placing of signal stations the whole length of the coast, and it is figured that this can be done with the help of automobiles in a few hours. A touring car with seven or eight men and equipment for field telephone and telegraph lines, flag, light and heliograph signalling apparatus, it is estimated, can establish a whole string of signal stations in a very short time and afterward act as supply car for a whole section of the coast. The cars and motor cycles will also be of value in securing and carrying information.

While it is the intention of the authorities to use the automobiles largely in the signal, medical and quartermaster's departments it is not improbable that experiments will be made in the transportation of troops, somewhat after the manner of

the recent experiments in England. For instance, if the main body of troops happens to be quartered at a certain point and an attack is threatened several miles away the automobiles will be used to transport the advance guard to the point in danger and to carry as many others as possible in advance of the main movement. The chief military authorities of the State are enthusiastic over the possibilities of automobiles in the maneuvers, and while their use will depend upon the exigencies of the situation, they are outlining some very important work for the motor corps. Individual automobiles probably will be stationed at the different headquarters and will be used by the commanding officers and the umpires, of which Gen. Leonard Wood, U. S. A., commander of Department of the East, will be chief.

Automobiles have been used before by the Massachusetts militia, for in 1905 the White company supplied several steamers for the camp at Westfield. But in previous maneuvers the automobiles have had to do cross-country work and were at a disadvantage. In the coming maneuvers, however, they will be in their proper element, for all along the coast are excellent roads and cars can make the trip from Newburyport to Cape Cod without leaving the macadam except in a few places. No call for automobiles has yet been issued, but it is anticipated that when it is sent out there will be a very general response from owners who are militiamen. The posts will be responsible ones, for the drivers will have to do much outpost work and will always be in danger of capture by a raiding force landed from some of the enemy's ships.

If the automobiles prove as valuable military auxiliaries as is expected it is not unlikely that steps will be taken for the formation of a permanent automobile corps. Owners of cars will be invited to register their machines at the office of the Adjutant-general, with their size, power and carrying capacity, with the understanding that in case of emergency such as a riot, conflagration or the like, the Adjutant-general may call the cars into service and that the State may use them as long as they are needed, reimbursing the owners afterward. The Chelsea fire, a year ago last April, demonstrated the value of automobiles as an aid to the militia, and it is for similar work that the permanent automobile corps is under consideration. General Wood is said to favor such an organization in every State and the Massachusetts military authorities believe in it thoroughly.

GEN. WOOD SUGGESTS ARMY MOTOR CORPS.

NEW YORK CITY, May 24—Major-Gen. Leonard A. Wood, U. S. A., commanding the department of the East, has interested a number of automobilists in a plan for the organization of an army motor corps. It has been suggested that only runabouts be used inasmuch as they would not be called upon to carry troops, but rather for scouting purposes, carrying besides the owner, a soldier or two trained in quick shooting from a moving auto. General Wood proposes to utilize the corps at the regular army maneuvers to be held from August 14 to 21, having the owners of the cars go into camp the same as do the regular troops, although it would not be necessary for them to enlist. The formation is in charge of Henry F. Caldwell, well and favorably known in automobile circles.

AUTO'S LATEST USE ; CHURCH ON WHEELS.

DETROIT, May 24—There is at least one man who does not think the automobile an unmitigated evil, for the Rapid Motor Vehicle Company, of Pontiac, has just shipped to Cincinnati a gospel wagon, equipped with pews, a platform for the speaker and a pipe organ. If anything has been overlooked in fitting up this newest agency for fighting evil it was not discovered. It will be utilized in soul-saving on a trip through the South by "Gipsy" Smith, a well known evangelist.

BANQUET TO REPLACE EUROPE'S BIG RACE.

PARIS, May 22—For lack of an annual road race to unite "Knights of the Steering Wheel," it is proposed that European race drivers should find a common meeting ground around a banqueting table. The idea put forth is that all drivers who have taken part in international road races during the past ten years and have finished among the first ten in any of these events should meet at a race drivers' banquet to be held somewhere in Paris. The idea has met with favor, and the race drivers' banquet will doubtless become an established institution.

Even the French voiturette race, which at one time seemed likely to provide good sport, is now in low water. The regulations have developed a freak type of car with a single-cylinder engine of slightly less than four inches bore and a stroke of ten inches, from which 30 to 35 horsepower can be obtained. Two firms in France, Sizaire-Naudin and Lion-Peugeot, have specialized in this class of diminutive speed monster, with the result that other firms, content to confine their efforts to the production of commercial models, find themselves unable to make even a respectable showing in such company. The consequence is that the voiturette race to be run at Boulogne, on June 20, has only received six engagements, with the possibility of obtaining but three more by the time for closing the lists. The organizers declare that they will hold the race whatever the entries.

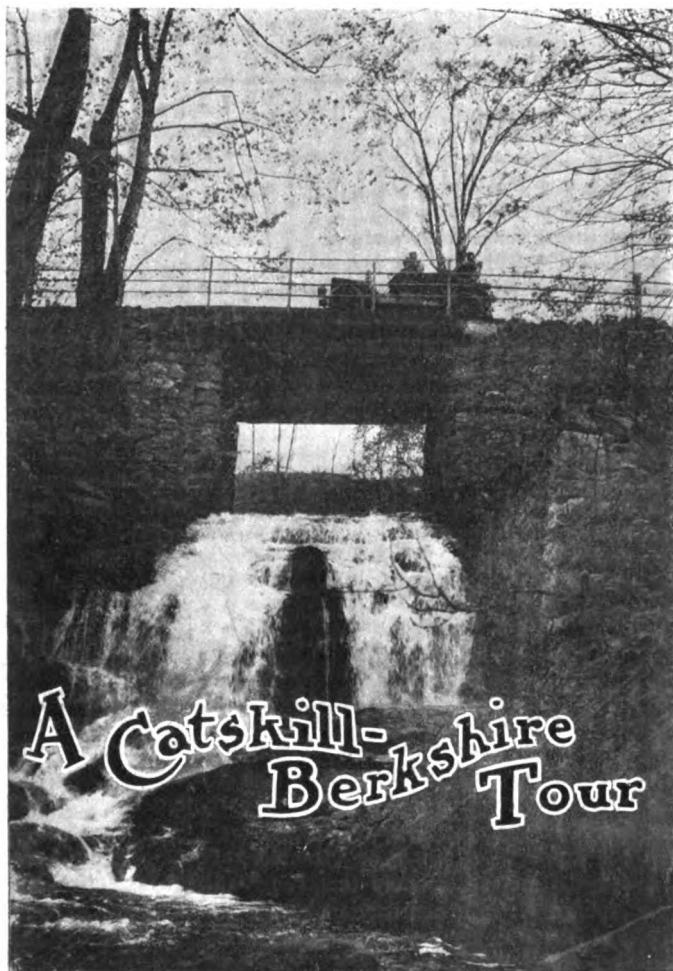

This Bridge Separates New York and Connecticut.

PREPARATIONS are going steadily forward for the three-day tour to be held June 12, 13, 14 by the New York Automobile Trade Association. Last week a pathfinding party went over the route in a 30-horsepower White steamer and brought back the report that there is no other three-day trip in the East which can compare in attractiveness with the one selected through the Catskill mountains and the Berkshire Hills. The party, consisting of Chairman Skinner, Photographer Lazarnick, and "Pathfinder" Johnston, besides compiling detailed road directions, made the necessary arrangements with the hotels and garages, and planned the schedule, checking stations, etc., in accordance with the varying road conditions.

The start of the contest will be made from the garage of the Automobile Club of America, in Fifty-fourth street. The cars will then proceed to the West Forty-second street ferry, and, on arriving in Weehawken, "over on the Jersey side," they will check out at one-minute intervals, and will commence to run "on good, old schedule time." The course will follow the Hudson County boulevard for several miles, and then, leaving the shores of the Hudson, will lead into Hackensack by way of the toll road. Arcola is the next town on the route; then comes Waldwick, Allendale, Ramsey, Mahway, with Suffern, the first checking station (28.3 miles from Weehawken). Then will come a ride through the beautiful Ramapo valley, passing through Sloatsburg, Tuxedo, Southfield and Central valley to Highland Mills. Here a detour will be made from the main route to reach the Lake View Hotel, the noon control (48.5 miles from Weehawken). Plenty of time will be allowed for luncheon and arrangements will be made for serving the tourists out of doors, the tables being spread on the shores of the beautiful little lake whose green slopes are surrounded by picturesque hills.

Leaving the noon control, the tourists will continue northward, and on nearing Newburg will once more catch a glimpse of the

Hudson. During the rest of the day's trip the route will closely parallel the river, except that, when nearing Kingston, a detour is made inland in order to reach the bridge spanning Rondout creek.

Highland, eighty-two miles from the start, will be the first checking station of the afternoon, and then will come a forty-three-mile run by way of Kingston to the night control, the Hotel Grant, Catskill. The hotel is large enough to accommodate the party without the slightest crowding and an informal dance is scheduled for the evening.

On the second day of the tour, Sunday, June 13, the tourists will have an easy time of it. It has been decided not to start from Catskill until after luncheon, so those in the party will have the morning to themselves. As the contestants will have the use of their cars after checking in at the night controls, some of them will undoubtedly spend the morning in driving to some of the nearby Catskill resorts.

After an early luncheon the tourists will be sent on their way to Albany, thirty-seven miles farther up the river. At Albany the route turns southeasterly and enters the Berkshire Hills. The schedule between Albany and Pittsfield, a distance of thirty-five miles, will be a liberal one, so that all may have an opportunity to enjoy the splendid mountain scenery.

The feature of the afternoon's ride will be the four-mile climb up Lebanon mountain and the long coast down on the other through the quaint Shaker village to Pittsfield. The night control will be at the well-known Hotel Wendell.

The third day of the tour, Monday, June 14, will begin with a trip through one of the most famous resort regions in the world. Leaving Pittsfield, the route leads almost due south, first to Lenox, then to Stockbridge, then through Great Barrington, South Egremont, Salisbury, and Lakeville to Sharon, the first the checking station (46 miles from Pittsfield).

From Sharon the route turns southwesterly through Amenia, Millbrook, and Washington Hollow to Poughkeepsie (77 miles from Pittsfield). After leaving Amenia, the country flattens out considerably, and the run into Poughkeepsie is through comparatively level country.

Poughkeepsie will be the noon control, and the tourists will take luncheon at the Morgan House, in front of which will be the checking station. Located next door to the hotel is "Van's" garage, so that the drivers may readily take on supplies here for the 75-mile run back to New York over the usual touring route. There will be an intermediate checking station at Peekskill (110 miles from Poughkeepsie) and the final checking station of the contest will be in front of the Automobile Club of America clubhouse (150 miles from Pittsfield).

WHAT MASSACHUSETTS LAW MAY BE.

BOSTON, May 24—The Roads and Bridges Committee of the Legislature, which has had before it the uniform automobile bill for more than two months, this week reported the measure to the House of Representatives. It contains the graded-fee provision, cars of less than 20 horsepower to pay \$5 a year; from 20 to 30, \$10; from 30 to 40, \$15; from 40 to 50, \$20, and more than 50, \$25. A new provision is that a dealer may have five sets of number plates for \$25 and must pay \$5 for each set in excess of five. The motorcycle fee is \$2 and that of commercial vehicles, \$5. The maximum speed limit remains at 20 miles an hour, but the limit for thickly settled sections is increased from 12 to 15 miles. The limit at corners, curves, etc., remains at 8 miles. The plan to make the maximum limit 25 miles and driving in excess of that limit conclusive evidence of infraction of the law has been abandoned. A non-resident or his chauffeur may operate in the State ten days without registering.

The bill as reported provides that no person shall allow an automobile to stand in a public way without having the brakes securely and effectively set. If a driver of a horse signals an automobilist must bring his car to a stop and in approaching a street car which has stopped to allow passengers to alight the

car must be slowed down and, if necessary, stopped altogether. Local speed regulations, if made, must have the approval of the highway commission. A deposit of \$100 in cash will be accepted instead of a bail bond in cases of arrest for violation of speed regulations. A second conviction of operating while under the influence of liquor is made punishable by imprisonment for not less than one or more than two years. Owners of all public garages are required to keep a record of the movement of all cars so that the same may be at the disposal of the Highway Commission at all times.

SAVANNAH CLUB PLANS FALL RUN.

SAVANNAH, GA., May 24—In connection with the general plan for automobile runs to Atlanta next Fall, previous to the opening there of the national automobile show, the Savannah Automobile Club has decided to arrange an endurance contest to go via Augusta. A cash prize of \$1,000 will be given to the winner, half of which will be donated by the club and the other half by the *Savannah News*. It is planned to secure low rates upon automobiles from the North via the steamship lines, so that cars may be sent here and run to Atlanta to the show and return here for the Grand Prize race. The spreading campaign for good roads has been responsible for the action of the enthusiastic autoists of this city.

SOUTHERN CLUB PLANS BIG RACING STUNT.

SAVANNAH, GA., May 24—The Automobile Club of Fitzgerald is deep in the preparations for a big event and its contagious enthusiasm aroused the whole county. At a meeting held last Wednesday, the dates June 15, 16 and 17 were finally decided upon and a committee appointed to look after the advertising and publicity, while other committees to attend to prizes and programs were selected.

RHEIMS WILL HAVE THE AERONAUTS.

PARIS, May 22—Chateauland, after obtaining and losing the French automobile Grand Prix, has been promised and lost its aeroplane race. As soon as it was known that the automobile race would not be held, an effort was made to put an aeronautical carnival on foot. After a considerable amount of work it has to be recognized that this is an impossibility, for the only date available is so close to the Rheims meeting that the Anjou gathering would certainly end in failure. Thus there will only be one great aeronautical demonstration in France this year, on the vast plains outside the Old World city of Rheims. The races begin Sunday, August 22. The Gordon Bennett aeronautical cup will be competed for on the closing day, Sunday, August 29.

AIRSHIPS RUIN LAWNS: A PROBLEM.

LOS ANGELES, CAL., May 24—Residents of this city who are progressive and yet appreciate beautiful lawns are "under" a problem. How to prevent sand, which is used by airships and balloons as ballast, from marring the grass plots, without seeming to rail at progress in aeronautical science, is being seriously considered. Complaints have been made to the chief of police by owners of residences in the vicinity of the city where the Aero Club is holding its flights. It is said that the lawns are being ruined by the sand thrown by the aeronauts in their flights, and the only way of preventing it seems to be under the city ordinance which prohibits the depositing of refuse or rubbish in any place but cans.

Austria's first aeroplane factory has now been called into existence under the assistance of the Austrian Daimler Company and the Austro-American Rubber Company. The capital at present amounts to 300,000 kroners.

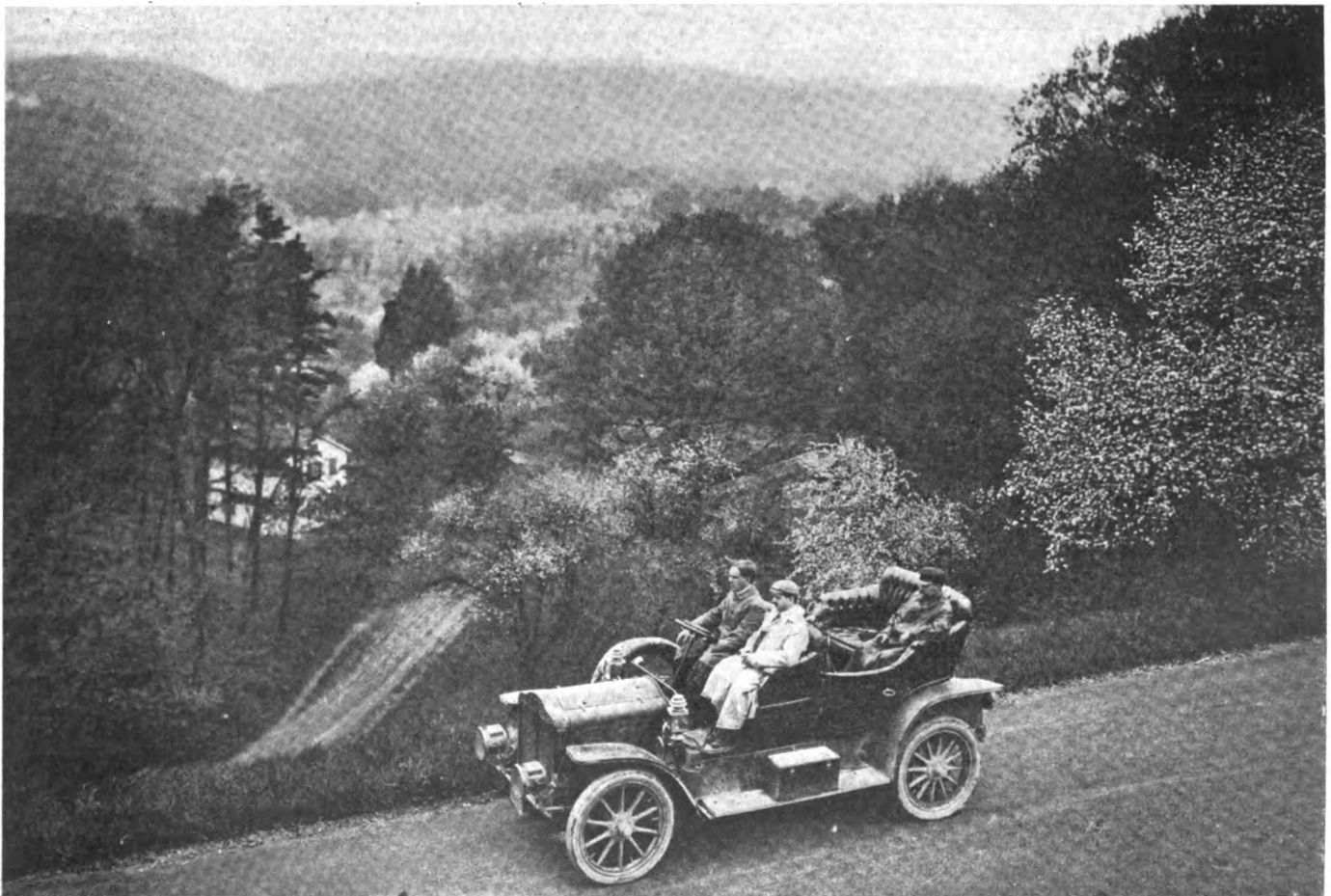

Into the Heart of the Picturesque Catskills, Redolent with the Luxuriant Foliage of Spring.

THE MERCER CAR FROM TRENTON, N. J.

TRENTON, N. J., May 24—Newest in automobile trade circles is the Mercer car which is being built by the Mercer Automobile Company. Occupying the former factory of the Walter Automobile Company, the new concern has been organized by local capitalists, with the business and technical affairs guided by experienced automobile men. In two months a car which seems to embody the essentials for a successful career was designed, extensive tests made over the roads, and already six of the autos have been completed with others being prepared. Constructed along lines which are recognized as standard, the cars have motors of 25-horsepower, with the exception of the taxicabs which are given 18-20; selective sliding gear transmissions; and shaft drive. At present the plans call for the production of three models, the chassis of which will be nearly alike. There will be a touring car; a series of roadsters with several body styles; and the taxicab.

The factory has been taken over entirely and 65 men are at work on the Mercer. The first shop order is for 50 machines, and it is stated that the next will be for 500, for agents have already been secured and orders received. The medium price of the car has been an attractive feature.

In the recent endurance run of the local club, through the Delaware valley, a new Mercer was entered and taken right out of the factory for the trip. It made a perfect score and the motor kept running from early morning until evening. The Mercer Speedster, it is said at the plant, will be the type used in contests, and a racing team for the light car events is under consideration.

Papers for the incorporation of the Mercer Company are ready to file. In all probability Charles G. Roebing will be elected president, and J. L. Kuser, secretary and treasurer. The other incorporators are F. W. Roebing, and Col. A. R. Kuser. R. L. Kingston is the general manager, and the designs for the car were made by Mr. Kingston and E. T. Georges.

DUTY ON AUTOS MAY BE INCREASED.

WASHINGTON, D. C., May 24—Automobiles are again in the public eye, and again the Senate has been amused by the tirades of certain of its dignified members, for the duty on autos may be increased. Over an hour was given to the consideration of the part of the tariff relating to "these engines of destruction," and the committee accepted an amendment increasing the customs duty to 50 per cent. on automobiles and automobile parts, leaving the present rate of 45 per cent. on motorcycles, bicycles, and their parts. Senator Heyburn was the principal speaker against the machines, supported by Mr. Hale and Mr. Bailey. Mr. Heyburn, who is from Idaho, a State which recently made large appropriations for building good roads for the ocean to ocean automobile contest, said: "I should like to see a tax of 100 per cent. on these machines, and I am amazed that the courts should have decided that they have the same rights as other vehicles on our country roads. People must flee to places of safety while these engines of destruction pass along the roads. Laugh? Why the rich shout with glee while the farmer flies through the air to be distributed over nearby fences."

ORPHANS' DAY WIDELY REMEMBERED.

Although June 9 has been set by the A. A. A. as the national orphans' day, when clubs, trade associations, or other automobile bodies, would give an outing to the little folks in city charitable homes, a number of cities have found it convenient to select some other dates. A few of those chosen are mentioned here, with the name of the place, and of the body in charge. They are:

New York City, June 9, W. J. Morgan's Voluntary Committee.
Philadelphia, June 9, Quaker City Motor Club.
Brooklyn, N. Y., June 8, Long Island Automobile Club.
Pittsburgh, Pa., June 3, Automobile Club of Pittsburgh.
Cincinnati, O., June 3, Cincinnati Dealers' Association.
Columbus, O., June 19, Columbus Automobile Club.

NEW BOOKS FOR AUTOMOBILISTS.

An Old Friend with a New Name—The fourth edition of the French trade directory "L'Annual 1909," previously known as Baudry de Saunier's Annual, is larger and more complete than its predecessors. Within the stout cloth cover are more than one thousand pages of closely printed matter arranged in alphabetical order for convenient reference. The Annual really comprises two distinct works, the first portion being a list of all firms, persons, clubs, associations, newspapers, etc., in any way connected with the automobile industry. Every French firm and most of the foreign ones have their place in the alphabetical list, the information concerning them being complete and accurate. The second section is a technical dictionary, in which all technical terms are explained by text and drawings in a manner that has not been attempted in any other publication. Persons having any connection with the French automobile industry, or having to deal with French technical terms, will certainly find this work a valuable one to have constantly at hand. The publisher is M. Hubert Baudry, 58 Rue de Monceau, Paris.

Factory Organization and Costs—The recent great interest manifested in these subjects has resulted in the production of this very extensive work on the subject from the able pen of J. Lee Nicholson. Mr. Nicholson is a certified public accountant of New York city, with a large and varied experience in this class of work, consequently he knows whereof he speaks. Although intended primarily as a handbook for manufacturers, it is so arranged and written that it may also be used as a book of reference by the cost accountant, and a textbook for the student. Its 404 large pages are divided into two general parts; first, the subject matter as indicated by the title, under some 39 chapter headings, and, second, mechanical office appliances. The latter is extensively treated in nine chapters, the various machines now on the market being described in detail.

Wage systems are dwelt upon to the extent of 18 pages, while the important subjects of cost accounting, 10 pages, and distribution of indirect expenses, 20 pages, are well and thoroughly covered in the space devoted to them. Distribution, in particular, is worked up in a very comprehensive manner. The balance of the book is devoted to typical forms and their explanation. The work is published by the Kohl Technical Publishing Company, New York City, and as sent out is handsomely bound in three-quarter black morocco.

"Artificial and Natural Flight"—In this small work from the pen of Sir Hiram S. Maxim, one of the first to appear on the subject, there are eight chapters, six of which are devoted closely to the subject, *per se*. Of these chapter four, treating of Screws, touches very briefly upon the screws in use, but confines himself mostly to theory upon which they act. Farman's screws are described and illustrated. The following, or fifth, chapter is an excellent one, treating, as it does, of various experimental work with rotating arms in general, and Professor Langley's in particular.

Amateurs interested in building a machine will refer to the sixth chapter dealing with Building of Flying Machines, in which is to be found a first-rate table of woods; their strengths, weights and comparative efficiencies for aerial use. The closing part of the text matter is a chapter on various subjects, in the last part of which, headed Some Recent Machines, an unwarranted and cowardly attack is made upon the Yankee champions, the Wright Brothers. The sting of the statements is but partly removed by the insertion in the book of a final statement that "recent events show that the Wright Brothers are able to outdo anything that was reported in the American press, etc.," and "the remarkable success of the Wright Brothers has placed the true flying machine in a new category." The book is from the press of the Macmillan Company, 66 Fifth avenue, New York City. The press work is of a high order, the type good and the paper excellent.



Chalmers-Detroit Stranded in Mid Desert.

THE "FLAG-TO-FLAG" DESERT STORY.

Automobilists all over the country read with interest the reports of the experiences of the "Flag-to-Flag" pathfinding party, which was stranded recently in a Mexican desert. The detailed story of the adventures has just been received, as told by W. E. McCarton in the *El Paso Times*. Four men, Mr. McCarton; William Knipper, the driver; F. Ed. Spooner, the photographer; and James Howard, the guide, in a Chalmers-Detroit "30" constituted the outfit, en route from Denver to Mexico City. When the stop came, they were 46 miles from the nearest railroad and 60 miles from El Paso. Mr. McCarton says:

"We left Jaurez on Friday morning, passed Gaudeloupe, and were about to turn around Candalaria Pass shortly after 2 o'clock, when we stuck fast in the deep sand. Our trip all day had been a battle with a terrible sand storm, which drifted like snow, and we seemed to be in an ocean of sand. This district is the worst desert on the North American continent, but notwithstanding the difficulties we made good time until we struck a hidden lake on the mesa, and then we plunged into a depression and were up to the hubs in soft sand. Poles and tackle were of no avail and we started to make the best of conditions. Our water had about given out and all that we had left was some prepared bean soup. We could not get a fire started and when we tried to pitch our tent that was also a failure, because we couldn't drive a stake that would stay. Howard volunteered to go for help, and started out over the pass to look for a ranch house. He was gone over two hours when Spooner and I started out in the same direction, and we met him coming back.

"By 6 o'clock we were getting desperate and Howard and I started west to strike the Mexican Central tracks, while Spooner started back to wait with Knipper. We walked all night over mesa, guided by the north star, and by daylight were completely fagged out, without having seen a sign of habitation. I was all in and by 6.30 could go no further. Howard went on alone and a good many miles further found some water and brought it back to me. We reached the railroad about 2 o'clock that afternoon and caught a train into El Paso. As soon as we recovered and rested a relief party was organized, and went out with food and water for Spooner and Knipper, who had nothing to eat and only the water in the radiator to drink."

JERSEY TRADESMEN HONOR WORKERS.

NEWARK, N. J., May 24—Eulogized as having been mainly responsible for the better automobile legislation now enjoyed in this State, President W. C. Crosby and Joseph H. Wood, of the New Jersey Automobile and Motor Club, were recently presented loving cups by the New Jersey Automobile Trade Association at a dinner given in their honor. In addressing the two guests President George Paddock ascribed to them the services which did most to obtain the new statutes, and expressed for the entire automobile fraternity the gratitude due to them.

NEW PENNSYLVANIA LAW IN FORCE!!!

PITTSBURG, PA., May 24—Just which way an automobilist is to turn in the State of Pennsylvania has been a quandary for several weeks, but Attorney-General Todd has advised the Automobile Club of Pittsburg that the new law is now in effect. This means that tourists from other States, at least those granting reciprocal courtesy to Pennsylvanians, may use Pennsylvania highways for a period of 10 days without taking out a license. The maximum speed is 24 miles per hour. There has been considerable misunderstanding about this matter, and the authorities have given out conflicting statements; but it is believed that the opinion of the State's legal adviser will settle the question.

E. P. CHALFANT TO BECOME A PACKARDITE.

E. P. Chalfant is to transfer his base of operations from New York City to Detroit, whither he will go in about a fortnight to become one of the big cogwheels in the well-planned machinery of the Packard Motor Car Company. Mr. Chalfant's resignation as general manager of the Association of Licensed Automobile Manufacturers will receive attention at the June 2 meeting of the executive committee of that organization. No successor has yet been mentioned, but it is well understood that Mr. Chalfant's occupancy of the place has been very satisfactory to the members.

1910 WHITE STEAMERS WILL USE KEROSENE.

CLEVELAND, May 25—Official announcement has been made by The White Company to the effect that kerosene may be used as fuel on all 1910 models. This is made possible by the fitting of a special kerosene burner, the result of ten years' work on the part of the company. This new burner may be adjusted so as to burn gasoline also, if preferred to the cheaper fuel. The use of kerosene as a fuel will relieve the fast growing scarcity of good gasoline and thus aid to clear up the fuel situation.

PHILADELPHIA HOUSE ADOPTS AUTOMOBILES.

PHILADELPHIA, May 25—Recently the large and old-established firm of Strawbridge & Clothier began a strenuous and protracted test of an Autocar delivery wagon. This test has now been concluded by the purchase of several with bodies of the type shown in the illustration. These are in use for suburban deliveries, which they are enabled to make, not only more expeditiously, but more cheaply as well. Since started on regular service, the cars have not missed a day, nor a trip, and have displaced two two-horse wagons and six with a single horse. In the picture, one of the new self-propelled cars is shown starting out in the morning on its first trip to the suburb with its load of carpets and other things for the suburbanites, whom the management say the cars bring into closer touch with the store.

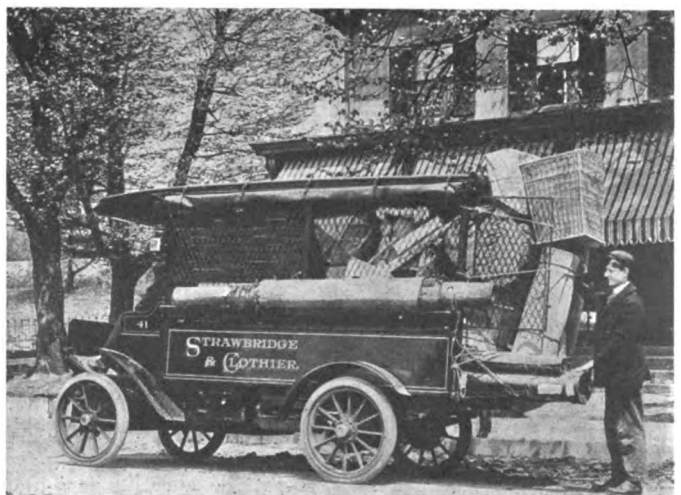

Autocar Delivery Wagon for Philadelphia Merchants.

BOSTON HAD FIRST Y.M.C.A. SCHOOL.

BOSTON, May 24—The Boston Y. M. C. A. in 1903 established the first automobile school in America. Prior to this time there had been instructions given to a selected few by the garages and factories. Since then the school has continued to prosper and grow in equipment and attendance until now it is acknowledged as one of the foremost schools of automobile construction in the country. It includes not only a high grade of young men who are entering the automobile business as a profession, but also prominent professional and business men who take the course to gain a thorough knowledge of automobiles, not perhaps to drive their own car, but to know whether they are getting maximum results and whether their chauffeur knows his business.

To meet a demand the Boston Y. M. C. A. has established a department devoted entirely to supplying first class automobile help of all kinds to dealers, garages and private owners throughout New England. These men are experienced in driving different cars and in repair work, and have satisfactory recommendations from former employers, but it is only after the investigation of the department that they are pronounced to be of ability and character. The best men, and the ones that are recommended the highest, are graduates of the school who have gone out and received the training of from one to five years' actual road or shop experience.

Another advantage of the department is the elimination of undesirable applicants who are not qualified for the position on account of inexperience or other cause. This is obtained by requiring a statement from the employer as to the requirements of the situation. From this information a man is selected from the list who will fill these requirements.

The department receives the support and recommendation of the largest dealers in Boston, and also their assistance by furnishing experienced chauffeurs whom they can recommend as reliable operators for their particular cars. The department also supplies competent men for the position of helper, or second chauffeur, who are capable of driving and caring for cars under the supervision of an experienced man. This should appeal to automobile owners and dealers in New England, as they are certain of obtaining reliable and competent help without trouble or expense.

BOSTON HOME FOR PACKARD AND CADILLAC.

BOSTON, May 22—Ground was broken in this city to-day for a structure which, when completed next fall, it is believed will be the largest and most complete automobile establishment owned by any dealer in the United States. This is to be the service depot of Alvan T. Fuller, local agent for the Packard and Cadillac, and it will cost, including the land, approximately \$200,000. The new building is to be four stories high with a basement and the ground plan will be 70 x 340 feet. The structure will be of reinforced concrete, fireproof throughout. The land, purchased by Mr. Fuller a couple of months ago, is on Commonwealth avenue, corner of Malvern street. It is a conspicuous location and the building will be a prominent landmark on the main thoroughfare leading into and out of Boston from the Western suburbs.

Mr. Fuller will not give up his salesrooms in the Motor Mart in Park square, but will place in the new building a most complete equipment for every kind of work that may be required on the cars he represents. He has long made a specialty of overhauling Packards and Cadillacs and to this work the larger part of the depot will be devoted.

Baltimore, Md.—The new salesroom and garage of the Baltimore-Stoddard-Dayton Motor Car Company, on West Royal avenue, is nearing completion. It will be used exclusively by this company, which handles the Stoddard-Dayton and Renault cars. Leo Schaab is the manager.

DIAMOND TIRES NOT IN AKRON FIRE.

AKRON, O., May 24—It has developed that the Diamond Rubber Company did not lose any tires in the recent fire in this city. The first reports stated that this concern had a large amount of product stored there for shipment, but this was incorrect. The Diamond company had \$150,000 worth of fabric in the building, but it was removed a month before the fire.

R. M. OWEN PLACES LARGE CONTRACT.

NEW YORK CITY, May 24—R. M. Owen & Company have placed with the Reo Motor Car Company what is said to be the largest order for automobiles ever contracted for in the history of the industry. The deal involves the marketing of \$50,000,000 worth of Reo automobiles by the Owen company. Since the organization of the Reo company, the New York house has sold the product and the plan will be continued.

SEVERE TEST FOR 1910 MITCHELL.

RACINE, WIS., May 24—California has been selected as the testing ground for the 1910 Mitchell car, which has been completed by the Mitchell Motor Car Company. J. W. Bate, the designer of all the Mitchell cars, will ship the new machine to the Pacific coast, and accompanied by General Manager William Mitchell Lewis, will give the car a thorough trying out in the mountains and over desert roads, a varied road condition impossible to be found in the flat country at Racine.

RAPID TRUCK SAVES A TOWN.

CAMPTOWN, PA., May 24—This town owes its existence at present to a rapid freight and passenger truck owned by the Auto Transit Company, which pulled a fire engine from Wyalusing recently to fight a fire that was destroying the town. A most disastrous fire started in a country store and when the alarm was given chauffeur Stone of the Rapid truck started on a record run to the neighboring town for the fire apparatus. Pulling the hook and ladder and carrying twenty-three Wyalusing fire fighters it returned in time to save several buildings which were in imminent danger.

STUDEBAKERS SECURE IMPORTANT CONTRACT.

NEW YORK, May 24—Great significance is attached by those interested in the development and more general use of commercial vehicles to the contract recently executed between the H. C. Piercy Company, of this city, and the Studebaker Brothers Company. By this the former will purchase from the latter an equipment of automobiles which will transform its immense delivery service from a horse-drawn to a mechanically propelled one, and its effect may be realized from the fact that this move will replace the horse delivery service of at least 66 prominent business firms of the city. The Piercy Company's business was started in 1870, and its horses, wagons and men have been organized to a high point of efficiency, directed from a central station, with a substation in Brooklyn. Almost a year has been consumed by the management of the concern in arranging with the engineering department of the Studebaker Company the details of the proposed change, until now it is felt that not the least friction will be noticed in making such a radical alteration and extensive improvement.

The present headquarters are located on West Fifteenth street, consisting of a six-story building containing 90,000 square feet of floor space, sufficient to house 500 automobiles, and with two elevators capable of raising the heaviest ones. The equipment and stable fittings were installed recently with a view to dispensing with them if necessary to make the building a garage. The Brooklyn station will accommodate 50 machines, and it is projected to locate substations in the Bronx and in New Jersey, so that heavy loads may be taken to these points.

NIGHT WORK NEEDED AT SPLITDORF FACTORY.

PRODUCING two hundred magnetos every day, over one thousand spark plugs, and about two hundred coils, the factory of C. F. Splitdorf, in upper New York City, is now in the midst of one of the busiest seasons of its history. Working day and night, closing only on Sundays, it has become the effort of the management to so arrange manufacturing operations as to fill as much as possible the orders which are received from automobile factories and retailers all over the country. Having been established in 1858, the Splitdorf laboratory is one of the oldest in the business of making electrical ignition apparatus, and in its comparatively new structure, with its large output, is one of the largest. Six floors and a basement are utilized, and it has been found necessary to make additions on the vacant ground adjoining in order to produce sufficient material to meet the demand. The area of the structure is large in itself, so that there is room for about 600 employees, with the various departments located to economize in space.

Over 150 machine tools are in operation throughout the building; lathes, drill presses and special machines being run at a maximum compatible with producing goods of quality. Everything that goes into the makeup of the apparatus is manufactured by the Splitdorf company; the iron for the magnets is treated, formed and magnetized; the armatures are wound; the magneto parts are machined from the castings; gears are cut; coils entirely formed and packed; and, in fact, every process can be seen from the receipt of the supplying materials to the shipping of the finished products.

On the top floor of the big plant the spark plugs are manufactured, and in their construction are seen some Splitdorf features, such as the winding of mica insulation laterally on the spindle, the claim being that this method is superior to the use of mica disks because it prevents the oil from penetrating to the spindle and short-circuiting. Porcelain is used only as a protector between the top of the metallic bushings and the binding post. A small compression space is designed for the purpose of causing any oil which may get into it to be blown out by the force of the explosion. Of the thousand plugs made, some are of the standard Splitdorf in half-inch, metric, Winton, and A.L.A.M. sizes, and some are low-tension plugs.*

The fifth floor is used partly for constructing the coils, sev-



Coil Assembling Room in the Splitdorf Factory.

eral types being made, those for one, two, three, four, and six cylinders, with or without the Splitdorf system of synchronizing and to be used with or without magneto, or for both batteries and magneto. It is stated that about 120 coils for two-cylinder cars are made each day; about ten for four-cylinder cars; about twenty-five for use on marine engines; about ten for the synchronized system, and the remainder for various service. The boxes are all made of mahogany, with the exception of a few made of quartered and polished oak. There are many different styles, for the makers of automobiles want the boxes to fit each individual make of car dash, and for this purpose special sizes and designs have to be followed.

Two entire floors are given over to the mechanical work in connection with the magneto systems, magnetizing the horseshoe-shaped bars of iron, machining the parts, in assembling the finished sections and in testing the sets. The Splitdorf arrangement gives a unit consisting of the magneto proper and a transformer, the office of the latter being to step-up the voltage from 45 to 31,000. One complete set is made every five minutes.

Splitdorf products consist mainly of six models of magnetos; nearly a dozen types of coils; timers of several kinds; spark plugs, cut-out switches and commutators. The factory office of the concern is in New York City, and branches are maintained in that city, Boston, Detroit, Chicago and San Francisco.



Where Splitdorf Magnetos Are Put Together With Painsstaking Care That Every Part Is Right.

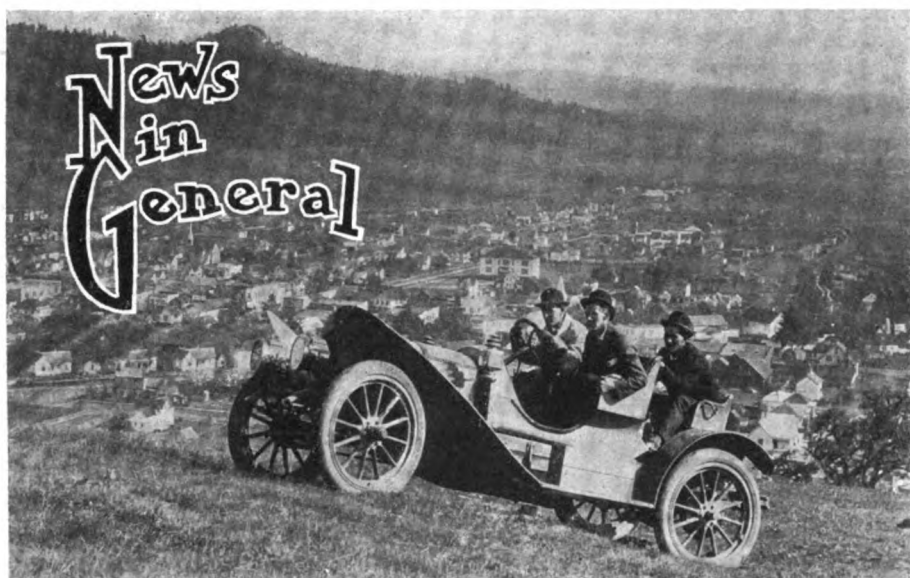

The Rambler Doing Duty as a Mountain Climber.

From time immemorial there has been rivalry over the honor of climbing McFarland Butte, one of the peaks of Mt. David, near cottage Grove, Oregon. Recently J. B. Van Winkle, of Eugene, Ore., stole a march on his rivals, when he made the ascent with a 34-horsepower Rambler, carrying two passengers besides the driver.

Records Kept of Pierce-Arrow Students—Although the school of instruction at the plant of the Pierce-Arrow Motor Car Company at Buffalo will be continued for some time, a sufficient number of persons have already taken the course to give a good idea of where the chauffeurs come from. An accurate record is easy to keep, since each man is required to give upon a card a notation of his previous experience, both along driving and mechanical lines, as well as his former occupations. The course covers two weeks and then a report upon the capabilities of each student is made. The reports so far show that only 47.3 per cent. of the men have had previous driving experience, and of these a comparatively large proportion have handled Pierce-Arrows, taking the course to refresh their knowledge. Of those who had no driving experience, many had been in lines which did not aid them in the automobiles, 13.8 per cent. having been coachmen who remained with their employers when a change from horses was made. About 14 per cent. were repair men and mechanics. Some of the reports are very interesting, as for instance: "An old coachman. Very willing and anxious to learn, but too old to master mechanical details. However, handles car well and carefully and with practice will develop into a good driver." Another reads: "Bright Irishman, formerly a coachman. Learned rapidly and handles car well. Will develop into very good man."

New Chicago Home for Studebaker—The Studebaker Company is erecting at the corner of Michigan avenue and Twenty-first street what will probably be one of the most elaborate and finely equipped automobile salesrooms and garages in this country. The building will be of solid concrete, seven stories in height, with a frontage on Michigan avenue of 75 feet and 175 feet on Twenty-first street. It is expected that it will be ready for occupancy about January 1, 1910, and as soon as completed the automobile department of the Studebaker Company, now located with the carriage repository on Wabash avenue, will take possession of the entire building. With three factories—the Stude-

baker-Garford, at Elyria, building 1,500 cars every year; the Studebaker E-M-F plant in Detroit, turning out 1,000 medium-priced cars every month, and the South Bend factory, making over 1,000 electric pleasure and commercial cars a year—the Studebaker will make the same bid for position in the automobile field as it has in the carriage business.

Prizes for Pictures of Rambler Autos—Thomas B. Jeffery & Company, Kenosha, Wis., the manufacturer of Rambler automobiles, has just awarded \$100 in cash for photographs illustrating the pleasure and utility of owning a Rambler car. The offer was made some time ago through the house organ, the Rambler magazine, and as there are 15,000 owners of Rambler cars in this country, according to the factory officials, it was but a short time until several hundred photographs were received. The prize winners are as follows: Rambler Garage & Supply Company, Norfolk, Va.; W. K. Cowan, Los Angeles, Cal.; P. W. Lochmiller, Albion, Neb.; H. W. Brown, Tifton, Ga.; J. H. Linsley, New Haven, Conn.; H. W. Davidson, Marietta, O.; C. M. Willis, Auburn, Cal.; M. H. McCarthy, Somerville, Mass.; Arthur Cummings, Winthrop, Mass., and John S. Butzer, Ephrata, Pa.

Waverley Makes Hard Cross-Country Run—In delivering a Waverley electric auto recently the E. Keeler Company, of Williamsport, Pa., was required to give the machine an unusually critical test. It was to be taken to Milton, 31 miles away, and in that distance the roads were none too good and there were seven hills to be climbed, some known to have inclines as steep as 20 per cent. Manager A. A. Maitland directed the test, the car being driven by Harry Knoll, and accompanied by Elmer Shrimmer, the purchaser. The distance was covered in two hours and twenty-five minutes' running time, without any trouble or endeavor to make a fast trip.

Oldfield Will Use National "Six"—Barney Oldfield has announced that this year he will outline an active campaign for racing on straight-away courses as well as on the track, and says that it is his intention to drive his own car without any connection with the makers. He

has recently ordered a six-cylinder National and is in Indianapolis at present superintending its construction. It will be a stock model, except that the chassis will be somewhat lighter than the one used at Savannah and in the New York Carnival races and hill climb.

Manufacturers of Lubricants Meet—The committee of manufacturers of lubricants of the Motor and Accessory Manufacturers' Association met recently and formally organized. George Baum, of Adam Cook's Sons, was elected chairman and W. M. Sweet, of the association, temporary secretary. The members present were: William B. Shedden, the Columbia Lubricants Company, of New York; L. H. Snyder, the Jos. Dixon Crucible Company, and George Baum, Adam Cook's Sons.

Turner Brass Works Secures Injunction—The Turner Brass Works of Sycamore, Ill., manufacturers of mechanical appliances, automobile specialties, etc., has secured a permanent injunction restraining the Appliance Manufacturing Company, of Chicago, from manufacturing or selling the Amco bumper. The Turner Brass Works is the licensee of the Harroun bumper patent, No. 873,544, upon which its litigation was maintained.

Swinehart Tire Company Will Not Move—It was reported recently that the Swinehart Clincher Tire & Rubber Company, of Akron, O., was about to consolidate with the Mansfield Rubber Company and would move to Mansfield, O. B. C. Swinehart, vice-president of the Swinehart Company, announces that this report is incorrect and that his concern has no idea of either consolidating with any company or of leaving Akron.

New Concern to Make Supplementary Springs—M. H. Cormack, of New York City, has organized and incorporated the firm of H. H. Cormack & Company, of which he is president. The concern will manufacture a line of supplementary spiral springs, together with several other lines of automobile accessories.

Auto Factory for Oklahoma City—J. B. Worthington & Company has purchased machinery to be used in an automobile factory in Oklahoma City, Okla. It has already been shipped to the Southwest and as soon as it can be installed will turn out completed cars.

Bosch Magneto on Flag to Flag Car—The Bosch Magneto Company is calling attention to the fact that the Chalmers-Detroit car which is blazing the way for an endurance run from Denver to Mexico City is equipped with a Bosch magneto.

IN AND ABOUT THE AGENCIES.

Haynes, Philadelphia—The Haynes Automobile Company, of Pennsylvania, which will handle the Haynes output in Philadelphia and adjacent territory, has opened handsome salesrooms at 211-213 North Broad street. James H. Johnson & Sons will manage the new concern.

Herreshoff, Philadelphia—To round out its line, which at present consists of the American, Midland and Babcock electric cars, the Stoye-Vogel Company, at the southeast corner of Broad and Race streets, has just secured the local agency for the Herreshoff car.

Reo, Savannah, Ga.—Charles P. Henderson & Company, general Southern agents for the Reo Motor Car Company, have opened new offices and salesrooms at 119 State West, to be occupied until their new building is completed.

RECENT BUSINESS CHANGES.

Pittsburg Truck Company Will Move—Having secured a factory at Ithaca, N. Y., the Pittsburg Motor Truck Company will move from the Smoky City to the town of Koppel, N. Y., and take its Ithaca plant to that place. The concern has been recently chartered with a capital of \$100,000 and will engage in the manufacture of automobile trucks.

Slack Mfg. Company, Springfield, Vt.—W. W. Slack, president, Gilman & Son, Inc.; H. K. Parkman, secretary, Gilman & Son, Inc., Springfield, Vt., and G. C. Parker, sales manager, Wm. J. Smith Company, New Haven, Conn., have formed a partnership for the purpose of manufacturing and selling Abrasive Metal Cutters, under the name of Slack Manufacturing Company, Springfield, Vt., all parties to retain their present positions with their respective companies.

John Kane Mills has announced his withdrawal from the firm of Mills & Moore, of New York City, the managers of the New York to Seattle endurance and other contests, and familiarly known to the trade as "accelerators of sentiment." Private business matters requiring his undivided attention at present are responsible for the move, according to Mr. Mills.

A. E. Schaaf will be the general manager of the American Fiat factory, which will be located at Poughkeepsie, N. Y. Mr. Schaaf was formerly general manager of the Pope Motor Car Company, of Toledo, and with Mrs. Schaaf is now taking a tour from Paris to Turin, the home of the Fiat, with Nazarro at the wheel.

J. Howard Morse and Mrs. Morse, of Hartford, Conn., have sailed for Europe to spend the next three or four years in touring upon the Continent. They will make their home in Switzerland. Mr. Morse was formerly president of the Automobile Club of Hartford.

Alfred Reeves, general manager of the A. M. C. M. A., has just returned from a trip to the various automobile factories in Pennsylvania and states that from the indications the Keystone State is now taking a lead in the automobile industry.

Hiram Percy Maxim, designer of the Maxim-Goodridge electric automobile and the Maxim tire inflater, has sailed for Europe to demonstrate his gun silencer. He will go to London, Liege, Paris, Berlin and Vienna.

F. A. Barker has accepted a position with the Overland Automobile Company of Indianapolis, Ind. He was formerly publicity manager of the Dayton Motor Car Company, of Dayton, O.

J. E. Finney has joined the sales forces of the Savannah, Ga., agent for the Reo automobiles. He was formerly connected with the Buick agency.

Wilbur C. Walker, secretary of the Pope Manufacturing Company, has returned to the factory from a business trip to the Pacific Coast.

NEW AGENCIES ESTABLISHED

Maxwell: Pasadena, Cal.—Maxwell Automobile Company, F. J. Purdy, sales manager, 161 West Colorado street.

Durocar: San Francisco, Cal.—W. A. Breen and J. A. Houlihan, Golden Gate avenue and Polk street.

Rider-Lewis: Minneapolis, Minn.—Segerstrom Automobile Company.

Rider-Lewis: Macon, Ga.—Napier Auto & Supply Company.

Gaeth: Milwaukee, Wis.—Auburn Motor Garage Company.

Rider-Lewis: Dallas, Tex.—White Sales & Garage Company.

Regal: Springfield, O.—E. D. Valentine, King Garage.

Rambler: Springfield, Ill.—Springfield Garage Company.

Gaeth: Chicago.—International Automobile Company.

Auburn: Orange, N. J.—J. J. Mayer, for the State.

Rider-Lewis: Iowa—J. A. Wicke, Marengo, Iowa.

Frontenac: Baltimore, Md.—Meredith Dryden.

E-M-F: Arcadia, Fla.—Major W. G. Welles.

Frontenac: Passaic, N. J.—E. J. Beuret.

Brush: Bloomsbury, N. J.—James T. Smith.

Ford: Opelika, Ala.—G. R. Spencer.

RECENT INCORPORATIONS.

Livingston Radiator & Manufacturing Company, New York.—Capital \$100,000. To manufacture cooling and heating radiators, automobile engines, cars, wagons, boats, aeroplanes, etc. Incorporators: J. N. Boyle, A. S. Rockwood, Thomas Roberts, 30 Broad street.

Belmont Automobile Manufacturing Company, New Rochelle, N. Y.—Capital \$100,000. To manufacture, rent, and sell automobiles. Incorporators: Douglass Hamilton, H. A. Meiser, H. A. Lucker.

Fred J. Titus Company, Newark, N. J.—Capital \$100,000. To manufacture and deal in automobiles, aeroplanes, airships, etc. Incorporators: Fred J. Titus, John N. Hance, Grace D. Hance.

Pittsburgh Motor Truck Company, Wilmington, Del.—Capital \$100,000. Incorporators: P. C. Benedict, Salamanca, N. Y.; C. C. Conkle, Pittsburgh, Pa.; M. E. Smith, Wilmington, Del.

Belmont Automobile Company, New Rochelle, N. Y.—Capital \$100,000. To manufacture, rent and sell automobiles. Incorporators: H. A. Meiser, H. A. Lucker, Douglass Hamilton.

Taxi Garage Company, Augusta, Me.—Capital \$200,000. To carry on a general cab and truck business by motor or other power. President, R. S. Buzzell; treasurer, S. W. Pike.

Times Auto Supply Company, New York.—Capital \$20,000. To manufacture automobiles, motors, motor boats, etc. Incorporators: C. O. Jones, B. H. Ellis, H. T. Johnson.

SOME SELECTED AUTO PATENTS

Issue of May 18.

921,656. Roller Bearing. Herbert W. Alden, Canton, Ohio. Filed April 15, 1907.

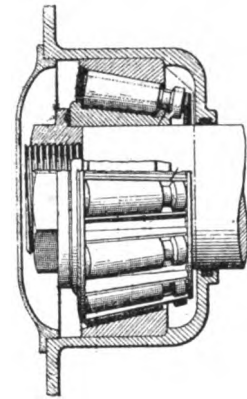

Alden Roller Bearing.

The feature of this invention of the well-known Timken engineer is the pressed steel cage which retains the rollers in place. While pressed steel cages have been used by the Timken people for some time, this one is constructed in a decidedly different manner. The rollers are retained by flanges and not by holes.

922,372. Propelling Mechanism for Motor-Driven Vehicles. Alexander Winton and Harold B. Anderson, Cleveland, Ohio. Filed Oct. 30, 1906.

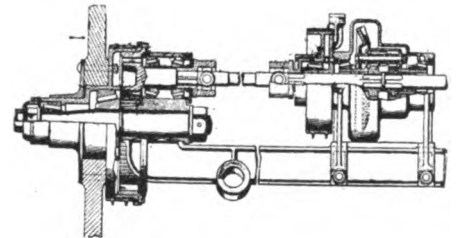

Winton Rear Axle Construction.

As the apparent handwriting on the wall, this looks like a new idea in Winton rear axles, along the same lines as that used in the De Luxe. The rear bevel and differential housing are carried above the rear axle proper, which has an I-section. From the driving shaft to the rear wheels, the drive is not direct but is by means of spur gears, housed within the rear hubs and brake drums combined.

921,679. Controlling the Exhaust from Internal-Combustion Engines. Thomas B. Doolittle, Branford, Conn. Filed Aug. 27, 1908.

921,705. Timing Gear Mechanism for Explosive Engines. Lindley D. Hubbell, Hartford, Conn. Filed April 27, 1908.

921,710. Pneumatic Tire. Grant Jacobs, Des Moines, Iowa. Filed March 13, 1908.

921,754. Transmission-Gearing. John M. Van Dyke and Fayette R. Rowell, Canastota, N. Y. Filed Sept. 8, 1908.

921,769. Starting Device for Gasoline-Engines. John L. White and Joseph B. Polo, Clear Lake, S. D. Filed Feb. 8, 1908.

921,802. Rotary Explosive-Engine. Schuyler H. Conkey, Minneapolis, Minn. Filed July 30, 1908.

921,862. Vehicle-Spring. Edmon F. Mayhew, Mooresville, N. C. Filed Nov. 11, 1908.

921,864. Valve-Motion for Gas-Motors. Gustav Mees, Dusseldorf, Germany. Filed Oct. 21, 1903.



The Governor's Trophy.

This is the handsome cup put up by the Keystone State's chief executive for the Harrisburg run, and won by a 28-horsepower Franklin machine, Carris driving.



Some Recent Trade Publications

Herz & Company, New York—Ignition specialties for automobile, marine, and railroad gasoline engines, manufactured by Herz & Co., New York and Vienna, are listed in the new catalogue of this concern, entitling it an edition for 1910. The Herz timers, with roller and wipe contacts, the new steel-shoed contact, and various other designs are taken up in detail, not only giving the prices of the completed devices, but also illustrating and rating every part. This feature alone would make the booklet especially valuable to designers and engineers, as well as to owners and supply dealers. The distributor, coils, and Herz Bougie Mercedes spark plugs are described at length, as are also the Herz importations of ignition cables and wires, battery connections and terminals, switches and copper-asbestos gaskets. The Herz Company is making a specialty of its air pumps for use in inflating tires, in self-starting devices, for whistles on boats, and many other places where compressed air is needed. Two types are driven by friction from the flywheel or other moving part, one of which is kept in contact with the driving part by a spring, and is bolted to the frame or some other convenient member, while the other is held against the revolving wheel or shaft by a handle, and is portable. In both of these the pistons and cylinders are of gray cast iron, with piston rings of the same material, no leather being used. Between the pump driving friction wheels and the pistons are sets of speed reducing gears. Each pump is tested at 120 pounds pressure, and will run at high speed, so that the largest tire can be quickly inflated. The motor boat outfit includes a tank and whistle, and safety valve. The pump with the handle can be taken to any part of the auto or boat and when not in use, the handle can be removed and the entire device packed in a small space. Two mechanically-driven pumps are also catalogued and described. Herz magnetos and the Paternoster shock absorbers are taken up in detail, with instructions as to their application and maintenance.

American Locomotive Company, New York—Alco gasoline automobiles, now licensed under the Selden patents, are ably described in a handsome catalogue just issued by the makers, the American Locomotive Company of New York and Chicago. These cars are the successors of the American Berliet, and continue in their construction the finesse of details and ability that characterized the Americanized French product. On heavy calendered paper, with clear and comprehensive cuts and text, the new edition of the Alco book is one of the finest seen, in regard to the 1909 automobiles. Detail illustrations give an idea of the type of the cars produced, a four-cylinder and a six-cylinder chassis being shown, the latter from above. Separate cuts of the two engines, transmission with its double bevel drive employing direct drive on both third and fourth speeds, transmission disassembled, multiple disc clutch, rear wheel assembly, are given. The body designs are shown by four illustrations of completed cars, two for touring and two enclosed. A rear view and details of the tonneau and front seat with control system are added. The text is of more interest to the casual reader than is often found in such booklets, giving the details of construction in a very pleasing and instructive manner, and at the same time convincingly showing the advantages of the types adopted for the Alco cars. Features are given as sturdiness, balance, anti-fatigue metal, and long life. Inasmuch as the 40 and 60-horsepower cars are the leaders in the line they are treated in greater length than is the 32-horsepower model, such as is used in the town cars and taxicabs, although frequent reference is made to the latter when its style is especially similar to that of the larger ones.

Locomobile Company of America, Bridgeport, Conn.—The latest publication of the Locomobile Company deals with the 1909 product. This is the eleventh annual catalogue and describes the new shaft drive and other models. Following a few pages of general text comes a very complete description of the mechanical details. These are

not general and vague, but specific and to the point. Besides the subject matter, dealing with the parts, the illustrations, about evenly divided as to photos and line-cuts, are very well selected. The scope of this treatment may be judged from the bare statement that almost four full pages, 9 by 12 in size, are devoted to the engine. The new shaft drive construction is elaborated upon to the extent of three pages. As this illustrates a new principle, and one that is worthy of study, the space is well used for that purpose. In this design all torsional stresses have been removed from the rear axle. The result is a stronger construction and one that rides easier. Naturally it is also productive of longer life, a point worth considering when purchasing. An interesting portion of the rear end of the book deals with the Fairmount Park races in Philadelphia during Founders Week. The road race at that time was won by the Locomobile entry, and a series of excellent pictures of the race are given. Some space is devoted to the Vanderbilt Cup race, also won by Locomobile.

Jewell Motor Car Company, Massillon, O.—Descriptive of the 1909 models of Jewell automobiles, the new catalogue is a beautifully compiled book of 32 pages, dealing with the entire construction of the regular 40-horsepower touring cars, limousine and roadster, and the Jewell-Keeton city and suburban car. The photographs and general make-up of the catalogue is in keeping with the "beauty and elegance of finish" which it attributes to the product of the concern. This is the third year of Jewell 40's, and little change has been made in the power plant and operating parts. The 1909 touring car is built with extra seats, making its capacity seven; the roadster can be equipped with either single or double rumble or bucket seats, and the limousine is designed to compare favorably with the finest output of other concerns. The engine, transmission, clutch, axles and other appliances are illustrated and explained in the book. The Jewell-Keeton car is one built along European lines, with thermo-siphon cooling, the radiator back of the engine forming a part of the dash, fixed spark advance and developing 24-30 horsepower.

S. F. Bowser & Company, Inc., Ft. Wayne, Ind.—Gasoline storage outfits of numerous sizes and types, lubricating oil wells, etc., are well described and illustrated in a catalogue received from S. F. Bowser & Company. From an illustration on the cover, which is said to be drawn "to arrest the attention" of a reader to the ten reasons for the installation of Bowser outfits, the book is of interest. Garage proprietors, owners of private garages, and prospective builders will find the booklet of extra use. A great many cities require that the gasoline shall be kept under ground, and where this is not so, the fact of economy in space and gasoline itself are commendable reasons for the use of such systems. Five distinct sets are illustrated and described in the Bowser book, any of which can be employed to store gasoline or kerosene, or both in separate tanks. Three types of oil tanks are mentioned, and an illustration given of an outfit in a private garage where the gasoline, kerosene, and two grades of lubricating oil are kept out of sight, and only the pumps enter the building.

Barrett Manufacturing Company—An attractive catalogue dealing with Tarvia for roads has been issued by the Barrett Manufacturing Company, beautifully illustrated with scenes from several parts of the country. The book is entitled "How to Construct and Preserve Macadam Roads and Prevent Dust," considering in turn the action of automobiles upon roads and the need for some better surfacing material, the endorsement of the tar treatment, and then Tarvia "A," "B," and "X." Experiences of prominent road engineers and supervisors are cited, and letters from a number are included. The photographs of roads treated with Tarvia products are highly interesting, not only from the standpoint of the Barrett interests, but also for their scenery. They have been well chosen from the possible many, giving views of good Pennsylvania

roads in the suburbs of Philadelphia, those in the outskirts of Boston, in New Jersey, Iowa, Nebraska, and many other places.

Diamond Rubber Company, Akron, O.—"Ten Years in the Ascendency" is the title given to the sixth edition of the Diamond tire book just issued. The booklet combines the features of a catalogue with a source of much valued information upon tires in general and Diamonds in particular. It is strikingly bound in blue, with a copy of the engraving which caused so much favorable comment during the shows, when used as a Diamond advertisement, that of the title on the cover. The typography is excellent and the cuts distinct in order to illustrate the features of treads and rims. Various types of Diamond tires are discussed, wrapped tread, non-skid, Bailey tread, and tubes; and of rims there are several—standard clincher, Fisk bolted-on, Marsh, and demountable, with instructions for changing tires. A set of "don'ts" and of "do's" is of interest to the owner of an automobile. This feature makes the book one of instruction and additional value.

New York & New Jersey Lubricant Company, New York—"A Cylinder Oil with a Pedigree" is the title of an attractive little booklet issued by the New York & New Jersey Lubricant Company on its new cylinder lubricant, "MoToRoL." The presentation of the cylinder oil subject assumes a new tone in this "MoToRoL" booklet, and the printing embellishments are unique. Basing argument on the fact that too often cylinder oil is selected at haphazard, or on the strength of some popular fallacy, the suggestion is offered that the reputation of the manufacturer is a safer basis for choosing a lubricant. "Non-Fluid" oils for the lubrication of transmissions and bearings in automobiles are well known, and their adoption by many automobile manufacturers is offered as warranty for confidence in the new production. The booklet states that "MoToRoL" is as effective for cylinders as "Non-Fluid" oils for transmissions.

Joseph Dixon Crucible Company, Jersey City, N. J.—What might be called a pocket edition general catalogue has been issued by the Joseph Dixon Crucible Company. This lists the principal products, such as crucibles, facings, lubricating graphite, greases, pencils, protective paints, etc., giving brief descriptions and prices. It is of value to the purchasing agent, engineer, contractor, superintendent, and anyone who uses or specifies graphite in any form. The booklet is of commercial envelope size, and will conveniently go in the pocket or desk pigeon-hole. It is substantially bound in tough cover stock, and attractively printed. Copies may be obtained from the Dixon Company.

Schacht Manufacturing Company, Cincinnati—A book recently published by this house gives a number of good pointers on the kind of an automobile to buy so as to get the greatest amount of satisfaction. A few of the subjects covered are trips to town, markets, neighbors, doctor, saving one-third of your time, healthful recreation, low first cost, run on less cost that feed for horses, always in the barn, ready day or night, get you there and back again. Just send your name and the manufacturers will send you this book free. The address is the Schacht Manufacturing Company, 2721 Spring Grove avenue, Cincinnati.

Morrison-Ricker Company, Grinnell, Iowa—The Morrison-Ricker Manufacturing Company of Grinnell, Iowa, has issued a new catalogue of its complete line of automobile gloves. The cover design is unique, artistic, and original; the colors striking and attractive. Everyone interested in auto gloves, whether dealers or wearers, are invited to send for a copy. "A glove to suit every requirement, every taste, and every season," is the announced aim of the manufacturers of Grinnell gloves.

General Automobile Supply Company, New York—J. C. Nichols, president of the General Automobile Supply Company, Inc., has issued the 1909 catalogue of automobile accessories and supplies. In it are described and listed almost anything an automobilist can think of with which to equip his car. Lamps, speedometers, coils, magnetos, oilers, oil cans, pumps, oils and greases, tires, tools, etc., are all mentioned with the General Company's rates. A mail order business is being carried on.

The Waverley Company, Indianapolis, Ind.—Bridge whist and Waverley electric automobiles are united in the latest publication of the Waverley Company. This is a bridge whist score book, and on each page is a cut of one type of Waverley with some hints on playing the game, and then as applied to the operation of the cars, from the opening lead to the return triumphant. These score books may be had upon application.

Information for Auto Users

Hill Folding Seat—As the demand for large cars of roomy capacity continues there is an equally strong demand for a suitable folding seat for the tonneau by owners who do not have the additional seats, although their cars are large enough for them. This great demand has induced a number of coach and body builders to bring out a seat for this purpose. Chief among these the product of the Hill Manufacturing Company, Buffalo, N. Y., is remarkable for its simple construction and the ability to fold to a very small size. The back folds down onto the seat, which then turns up into a plane at right angles to the floor of the tonneau. More than this, the whole folded seat may be swung around

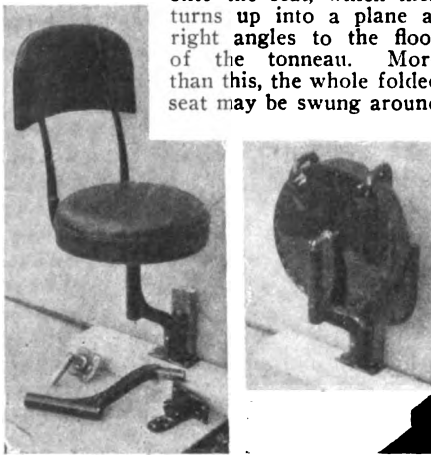

READY FOR USE. FOLDED UP.
HILL FOLDING TONNEAU SEAT.

so that it comes still closer to the sides. The application is very easy, consisting of fastening two blocks, one to the floor and one to the side frame, so as to form an exact right angle. To these two blocks the attachment requires but seven screws. The seat is trimmed in genuine machine-buffed leather over spring cushions. The form is that of a circle, 13 inches in diameter. The folding back is 17 inches high. The picture shows, besides the seat open and folded, an extra set of seat attaching irons.

Oilzum Automobile Oils—Of all the different petroleum produced the world over, the purity of a home product is the best. This is the Pennsylvania petroleum which is, on account of its purity, more expensive than other less pure products. In the production of a high-grade cylinder oil, the White & Bagley Company, Worcester, Mass., manufacturers of Oilzum cylinder oil, found that this was the only product pure enough for their use, despite the price. This use results in a pure mineral oil, containing no animal or vegetable matter, both of which are liable to decomposition and the formation of destructive acids, the effect of these upon cylinder walls being self-evident. One very desirable point in connection with the subject of lubrication, is a high flash point, and what usually goes with it, a high fire test. As might be expected from the re-

sultant of high-class raw material, and a high-grade process. Oilzum possesses both of these requisites.

Ordinary oils contain some carbon; in some this has been concealed by bleaching with acids; the best and most trustworthy way is by continuous filtration. This method is very costly but the resulting oil is good and worthy of the very best use, such as for cylinders. It is interesting to note that filtration is the only method which has ever been used in the preparation of Oilzum oils. This filtration sounds simple, but in practice it means passing the oil through graded Fuller's earth, not once nor twice, but times without number, at least up to a dozen or twenty.

Auto Type Ampere Meter—One of the greatest drawbacks of the storage cell for ignition purposes is the necessity for charging at frequent intervals. This is liable to come at a time when the use of the car is particularly to be desired, and any device which would prevent that from happening would go far toward increasing the popularity of the storage battery. A little meter just put on the market by the Sangamo Electric Company, Springfield, Ill., will go far in this direction. This is a small enough device to allow of its use on the dashboard, so that any one may attach it, after which the very beneficial use for which it is intended would be self-evi-

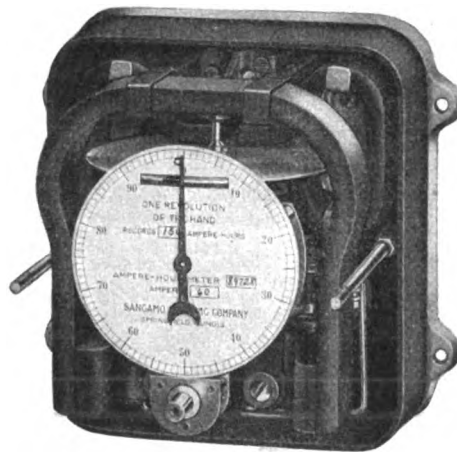

SANGAMO AMPERE HOUR ELECTRIC METER.

dent. It is also made in sizes sufficient for use with electric vehicles, for which it was brought out primarily. With one of these meters on the car it is impossible to get stuck out on the road, with the consequent chagrin attendant upon being towed home.

The illustration shows the meter with the cover removed, displaying the mechanism. The cover is simply a square box of metal, which fits rather closely over the mechanical parts, being held on by the two studs shown projecting from the back of the frame. The one shown is for a 60-ampere hour battery, but they may be had for any capacity.

Burr Self-Locking Block—One of the handiest things around a garage, using any form of block and tackle to lift cars or other heavy objects, is the Burr automatic safety tackle block, made by the Burr Manufacturing Company, Cleveland, O. This has a locking device, which comes into play as soon as a load is placed upon it, thus allowing of hoisting a car or weight off of the floor and leaving it suspended, without tying the rope or resorting to other and similar questionable means of fastening it. This distinctive Burr mechanism lets a person use the simple, cheap, and easily obtained hemp rope, instead of the more expensive steel cable. The Burr safety lift is made of the best selected steel, and has no teeth, wedges, eccentrics or springs to get out of order. Moreover, it works under any and all conditions, on wet or greasy rope, and at any angle, even when inverted.

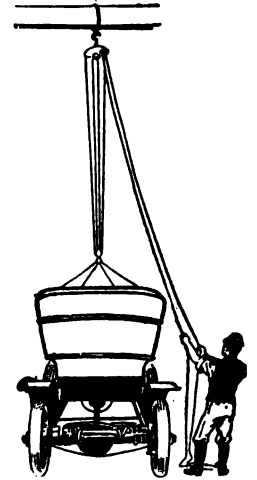

BURR AUTOMATIC BLOCK

The probable greatest field of usefulness for this block lies in the private garage, where the expensive chain block or more expensive duplex hoist represent an expense out of all proportion to the rest of the outfit. Yet a hoist of some sort is a real necessity, so that the safety lift will find a niche into which it will fit very nicely midway between the plain rope hoist, with very apparent disadvantages, and the expense of the more mechanical devices.

Elba Lighting Battery—There is at present a strong tendency toward the use of electric lights for automobiles and motor boats, and this tendency is being given proper support by the ignition specialists by the production of a battery especially designed and built for lighting work. The convenience and cleanliness of this method is daily attracting more recruits and these should take warning that it is possible to overload a battery on a lighting circuit. The Willard Storage Battery Company, Cleveland, O., are among the first to bring out a lighting battery for lighting purposes, the Elba. While this resembles in external appearance the ordinary storage battery, its internal construction is such as to allow discharge at a much higher rate than is the usual case, and without injury. The Elba battery is rated at the regular Pullman car lighting rate.



ELBA BATTERY FOR ELECTRIC LIGHTING.

**INDEX
TO ADVERTISERS**

Abendroth & Root Mfg. Co. 51
Acetylene Gas Illuminating Co. 49
Adams Co. 51
Air Tight Steel Tank Co. 64
Ajax-Grieb Rubber Co. 52
Aluminum Foundry Co. 50
American Motor Car Co. 75
Asphalt Ready Roofing Co. 72
Atwater-Kent Mfg. Works. 99
Atwood Castle Mfg. Co. cover
Austin Automobile Co. 105
Austro-American Separator Co. 49
Autocar Co. 104
Auto Car Mfg. Co. 84
Auto & Supply Mfg. Co. 49
Automobile Blue Book. 63-76

Babcock Electric Carriage Co. 84
Bacon & Fynney. 53
Baker Mfg. Co. 52
Baldwin Chain & Mfg. Co. 50
Berry, A. Hall. 61
Billings & Spencer Co. 48
Bi-Motor Equipment Co. 48
Black Mfg. Co. 73
Bongartz Co. 79
Borne Scrymser Co. 49
Bosch Magneto Co. 82
Boston Auto Gage Co. 49
Boston Y. M. C. A. 65
Bowser & Co., S. F. 65
Boyle & Co., John. 70
Bretz, J. S. 90
Briscoe Mfg. Co. 62
Brown Co. 73
Brown & Co., S. N. 52
Brownell Motor Co., F. A. 50
Brush Runabout Co. 77
Buckeye Jack Mfg. Co. 54
Buckeye Mfg. Co. 89
Buffalo Electric Vulcanizer Co. 59
Buffalo Specialty Co. 79
Buob & Scheu. 52
Burnett-Compound-Spring Co. 74
Burr Mfg. Co. 81
Byrne Kingston Co. 83

Cadillac Motor Car Co. 51
Cameron Car Co. 58
Canton Drop Forging & Mfg. Co. 50
Chadwick Engineering Works. 58
Chelsea Clock Co. cover
Clark Carriage Co. 52
Cleanola Co. 48
Cleveland Puncture Proof Tire Co. 69
Coes Wrench Co. 44
Conn. Tel. & Electric Co. 93
Continental Caoutchouc Co. 52
Continental Motor Mfg. Co. 56
Cooks' Sons, Adam. 69
Corcoran Clamp Co. 56
Corbin Motor Vehicle Corp. 76
Cornish Friedberg Motor Co. 51
Covert Motor Vehicle Co. 51
Crane Puller. 49
Cullman Wheel Co. 50
Cutter, G. A. 70
Dayton Motor Car Co. 77
Dayton Rubber Mfg. Co. 52
De Luxe Motor Car Co. 51
Detroit & Cleveland Nav. Co. 55
Diamond Chain & Mfg. Co. 50
Diamond Rubber Co. 90

Dietz Co., R. E. 92
Dixon Crucible Co., Joseph. 48
Doolittle Rim Co. 88
Dow Tire Co. 68
Driggs-Seabury Ordnance Corp. 65
Duplex Co. 50
Duplex Coil Co. 50
Edmund & Jones Mfg. Co. 53
Eldredge Electric Mfg. Co. 49
Elmore Mfg. Co. 102
Empire Tire Co. 69
Everett-Metzger-Flanders Co. 68
Excelsior Supply Co. 54
Excelsior Tire Co. 48
Firestone Tire & Rubber Co. 58
Fish, Geo. L. 66
Fisk Rubber Co. 86
Flentje, Ernst. 72
Fort Pitt Motor Car Co. 51
Foster Shock Absorber. 82
Franklin Mfg. Co., H. H. 74
Fried-Ostermann Co. 69

G & J Tire Co. 61
Gaeth Automobile Co. 59
Gearless Motor Car Co. 51
General Accumulator & Battery Co. 80
Goodman Co. 74
Goodrich Co., B. F. 107
Goodyear Tire & Rubber Co. 69
Gramm-Logan Motor Car Co. 51
Grossman Co., Emil. 87-57
Grout Automobile Co. 56

Ham Mfg. Co., C. T. 55
Hardy Co., R. E. 49
Harris Oil Co. 78
Hart-Kraft Motor Co. 54
Hartford Suspension Co. 71
Havoline Oil Co. cover
Haws, Geo. A. 52
Haynes Automobile Co. 75
Heinze Electric Co. 53
Hemmeter Spark Plug Co. 73
Henricks Novelty Co. 59
Hercules Electric Co. 57
Herschell-Spillman Co. 50
Herz & Co. 51
Hess-Bright Co. 85
Hill Dryer Co. 50
Hoffecker Co. 71
Hoffman, Geo. W. 49
Holtzer-Cabot Electric Co. 69
Hotel Woodstock. 55
Howard Motor Works. 51
Hoyt Electrical Ins. Works. 50

Indestructible Steel Wheel Co. 50
Interstate Automobile Co. 75
Jackson Automobile Co. 51
Jeffery & Co., Thomas B. 111
Jeffery-DeWitt Co. 86
Jewell Motor Car Co. 89
K-W. Ignition Co. 101
Karl Co., Adolph. 49
Kemizite. 103
Keystone Lubricating Co. cover
Kimball Tire Case Co. 55
King Top Mfg. Co. 52
Kissell Motor Car Co. 75
Knox Auto Co. 85
Konigslow, Otto. 50

Lansing Wheelbarrow Co. 72
Leather Tire Goods Co. 70
Lehman Mfg. Co., J. H. 49
Leland Co., W. H. 68
Lexington Motor Car Co. 76

Life Publishing Co. 49
Lobebe Pump & Machinery Co. 49
Locomobile Co. of America. 51
Long Arm System Co. 71
Long Mfg. Co. 74
Loring Auto Appliance Co. 49
Lucas & Co., John. 54

M. & E. Mfg. Co. 52
Maple City Mfg. Co. 56
Masury & Son, John W. 79
Mathewson Automobile Co. 109
Maxwell Briscoe Motor Co. 108
McCue Co. 98
Merrill Mfg. Co. 73
Metz, Chas. H. 74
Michellin Tire Co. 52
Midland Motor Co. 75
Miller, Chas. E. 80
Mitchell Motor Car Co. 94
Model Automobile Co. 89
Moline Automobile Co. 94
Moon Motor Car Co. 51
Morgan & Wright. 59
Morrison-Riker Mfg. Co. 81
Mosler & Co., A. R. 79
Moss Photo Engraving Co. 64
Motor Car Equip. Co. 52-55
Motz Clincher Tire & Rub. Co. 52
Muty Co., L. J. 52

N. Y. & N. J. Lub. Co. 86
N. Y. Sporting Goods Co. 51
National Brake & Clutch Co. 50
National Motor Vehicle Co. 77
National Tube Co. 70
Neustadt Auto & Supply Co. 74
New Departure Mfg. Co. 98
New Process Rawhide Co. 69
Nightingale Whistle Mfg. Co. 82
Nonkoroda Co. 54
Nordyke & Marmon Co. 91
Nuttall Co., R. D. 50

Oakland Motor Car Co. 94
Olds Motor Works. 51
Orange Machine & Mfg. Co. 72
Overland Automobile Co. 98
Owen & Co., R. M. 51
Packard Electric Co. 71
Packard Motor Car Co. 112
Palmer & Singer Mfg. Co. 51
Pantasote Co. 51
Parish & Bingham. 50
Parker, Stearns & Co. 52
Peerless Specialty Co. 77
Pennsylvania Auto Motor Co. 74
Perfection Non-Skid Climber Co. 81
Petrel Motor Car Co. 61
Peugeot Freres. 50
Portland Garage Co. 55
Prest-O-Lite Co. 77
Prosser & Sons, Thos. 59
Puritan Gas Tank Co. 58

Quincy-Manchester-Sargent Co. 50
Raimes & Co. 49
Remy Electric Co. 106
Republic Rubber Co. 87
Rex Wrench Co. 70
Reynolds, Harry H. 57
Robert Instrument Co. 49
Robinson & Sons Co., Wm. C. 52
Rome-Turney Radiator Co. 73
Randall-Faichney Co. 82
Rockwood Mfg. Co. 53
Royal Equipment Co. 49-71
Rushmore Dynamo Works. 94

S. M. Supplies Co. 73
Salisbury Wheel & Mfg. Co. 49
Safety Device Co. 61
Schenectady Spark Plug Co. 59
Schrader's Sons, A. 49
Schubert Bros. Gear Co. 52
Selden Motor Vehicle Co. 75
Shaler Co., C. A. 64
Sireno Co. 49
Skinner & Skinner. 78
Smith Mfg. Co., I. J. 71
Spacke Machine Co., F. W. 78
Spare Motor Wheel of America. 73
Speed Changing Pulley Co. 72
Speedwell Motor Car Co. 75
Spicer Universal Joint Mfg. Co. 50
Spittdorf, C. F. 69
Sprague Umbrella Co. 71
Standard Co. 89
Standard Roller Bearing Co. 72
Standard Sales Co. 49
Standard Sheet Metal Co. 80
Standard Welding Co. 58
Stanley & Patterson. 65
Star Speedometer Co. 100
Stearns Co., F. B. 83
Stein Double Cushion Tire Co. 70
Stevens-Duryea Co. 94
Stewart & Clark Mfg. Co. 67
Stitch-in-Time Vulcanizer Co. 52
St. Louis Supplementary Spiral Spring Co. 81

Stromberg Motor Device Co. cover
Studebaker Automobile Co. 75
Syracuse Alum. & Bronze Co. 50
Syracuse Chemical Fire Extinguisher Co. 59-68
Thomas Motor Co., E. R. 89
Timken Roller Bearing Axle Co. 92
Tiresole Mfg. Co. 58
Tray Plate Battery Co. 72
Trenton Rubber Mfg. Co. 62
Trimont Mfg. Co. 58
Tucker, C. F. 49

Uncas Specialty Co. 53
Underwood Typewriter Co. 83
Universal Tire Protector Co. 68
Van Wagner Mfg. Co., E. B. 50
Veeder Mfg. Co. 88
Velle Motor Vehicle Co. 84
Volcano Spark Plug Co. 70
Victor Tire Traction Co. 51

W. D. Spring Cushion Tire Co. 73
Waban Webbing Co. 50
Warner Instrument Co. 91
Weed Chain Tire Grip. 71
Western Motor Co. 72
Weston Elec. Instrument Co. 64
Wheaton & Utley. 76
Wheeler & Schebler. 96-97
White Co. 110
Whitlock Coil Pipe Co. 59
Whitney Mfg. Co. 74
Widmer Machine Works, C. A. 78
Willard Storage Battery Co. 78
Willett Engine & Carbureter Co. 80
Winton Motor Carriage Co. 70
Witherbee Igniter Co. 49
Wyman & Gordon Co. 48

Xargill Mfg. Co. 68
York Motor Car Co. 56
Zimmerman Mfg. Co. 84

FOR UNMATCHABLE QUALITY BUY

COES

STEEL HANDLE MODEL WRENCH

Coès New Auto Wrench

Sizes:

6-in. and 12-in.

Special Features:

Narrow Jaws Especially Made for Automobile Work, Without Sacrificing Strength

6"-size jaw opens 1 1/16".

Takes any spark plug.

12" jaw opens 2 5/16".

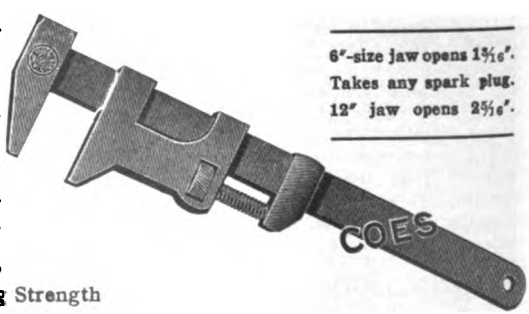

COES WRENCH COMPANY, Worcester, Mass.

THE AUTOMOBILE

Climbing "Giant's Despair" No Longer a Real Task

By
— A. G. Batchelder —

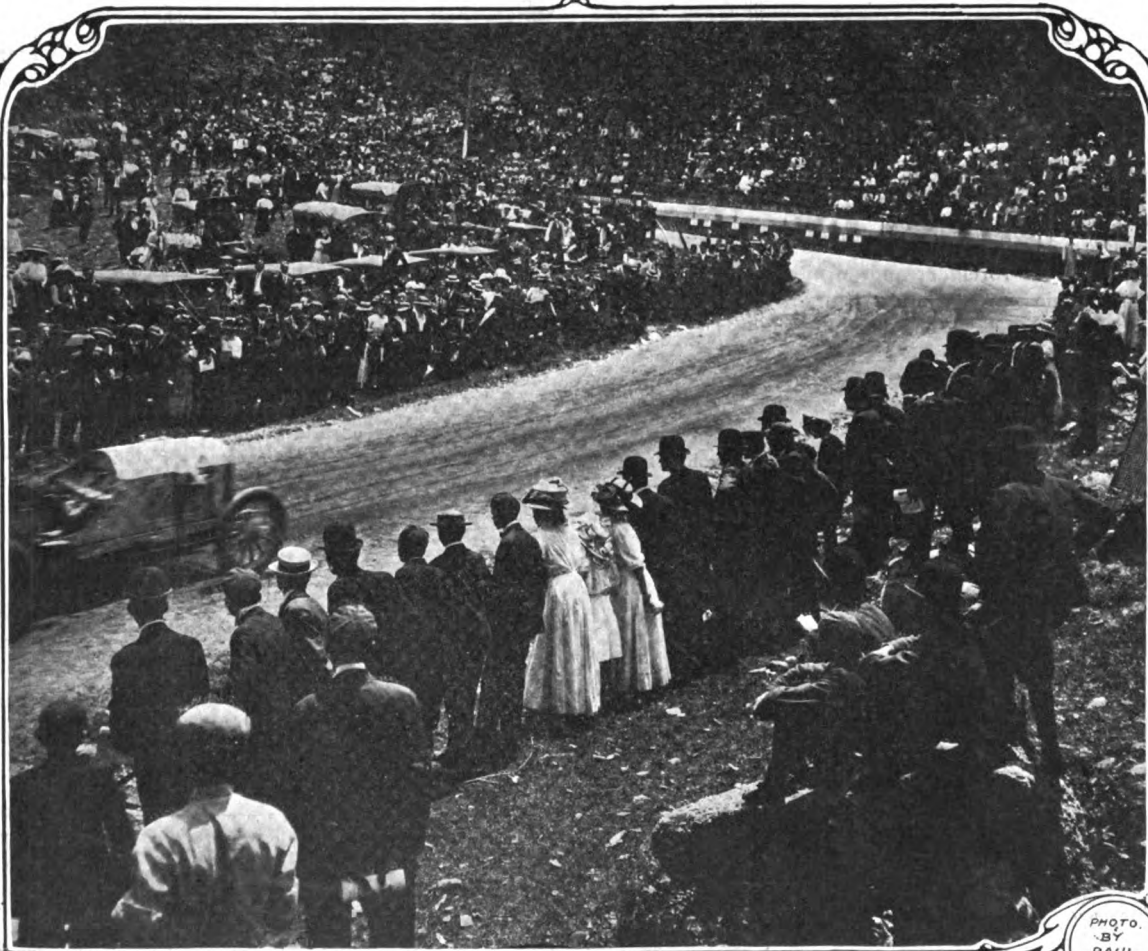
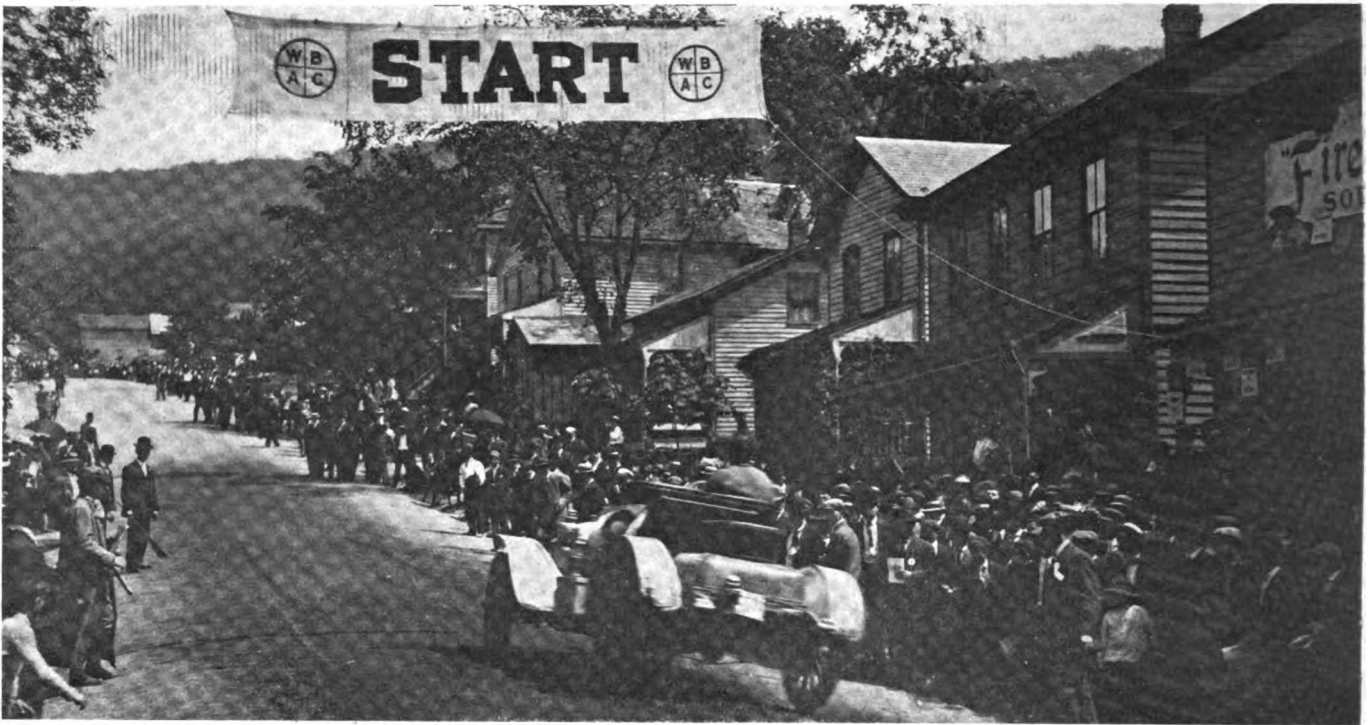

PHOTO BY PAUL THOMPSON

WILKES-BARRE, PA., May 31—"Giant's Despair" is the rugged name given to Wilkes-Barre Mountain. It's a real climb, a mile and an eighth long, contains a sharp turn designated as the "Devil's Elbow," and, of course, has an "S" turn. The rise is some 700 feet, with grades that vary from 10 to 22 degrees, and the surface is uniformly good, more than average. Once upon a time, in the early days of automobiles, more than one motor-driven vehicle discovered that the task was too great and therefore found it necessary to take another route. 'Twas

in the year 1906 that the mountain lost its terrors to automobilists, and few cars there were in that climb which failed to make the ascent. First of all was an English Daimler, driven by Harding; since then its figures of 2:16 1-5 being reduced each year by substantial cuts. Power and reliability are now synonymous. In 1907 Walter White's White Steamer appropriated the honors in 1:49 4-5, and in 1908 the Chadwick Six, with Willie Haupt at the wheel, accomplished the upward journey in 1:38 2-5. To-day the big Benz from Germany, with its 120-horsepower,



Cars Were Given a Rolling Start and Were in Good Action When They Struck the Electric Tape

plunged up the incline in 1:31 3-5, Brown, the amateur enthusiast, being at the helm and apparently enjoying the reckless pursuit of the phantom goddess, fame.

Less than five seconds slower was the Chadwick Six, of half the horsepower of the foreigner and adroitly handled by Larzere. DePalma made a notable climb with his Fiat skeleton flyer, and fourth best was the sturdy Knox piloted by Dennison and endowed with only 50-horsepower.

But the real honors of the climb belong to the stock car participants, it now being possible for anyone—and such is the case in most instances—to buy for his own use cars similar in construction and ability. If one wants a powerful road traveler, he can be sure of getting it in the purchase of a duplicate of the six-cylinder National which climbed skyward in 1:45; or in

"fours" he might pick a 60-horsepower Stoddard-Dayton, which made the trip in 1:46 2-5. Still continuing in the "Big Fellow" bunch, one could select a Simplex with an ascent of 1:47 2-5, or a 40-horsepower Knox, the figures for which were 1:57 3-5.

Close up in to-day's list are Mathesons and American Roadsters, not forgetting that the smaller-powered cars consistently climbed at better than 30 miles an hour without distress or hesitation. Even a Babcock Electric only required 3 seconds more than 3 minutes to reach the mountain's top.

The fourth climb of Wilkes-Barre's club figured as a "National" event and the preparations for it were conscientious and almost complete. The contest committee, of which George F. Lee was chairman, with Wright, Steelman, Moore, Meixell, Wagner, and Lewis as his co-workers, struggled indefatigably, and only went

astray in one real particular. That was in the guarding of the course. Thousands swarmed from the base to the top of the mountain, swarmed over the road, and seemed to be utterly oblivious or unconscious of the danger from the juggernauts that flew by in dangerous proximity. The next time, says Chairman Lee, there will be men and muskets in plenty, and there will be ropes alongside the tortuous climb its whole length. Then the fools will be kept out of harm's way. That a score or more were not killed was miraculous. It will be remembered that these same fools flocked all over the road at the Vanderbilt race. Here is what a local paper said about it:

"Fully sixty thousand witnessed the exciting contests, and remained on the course from 7 o'clock this morning until the last car had gone down the hill. The crowd began to

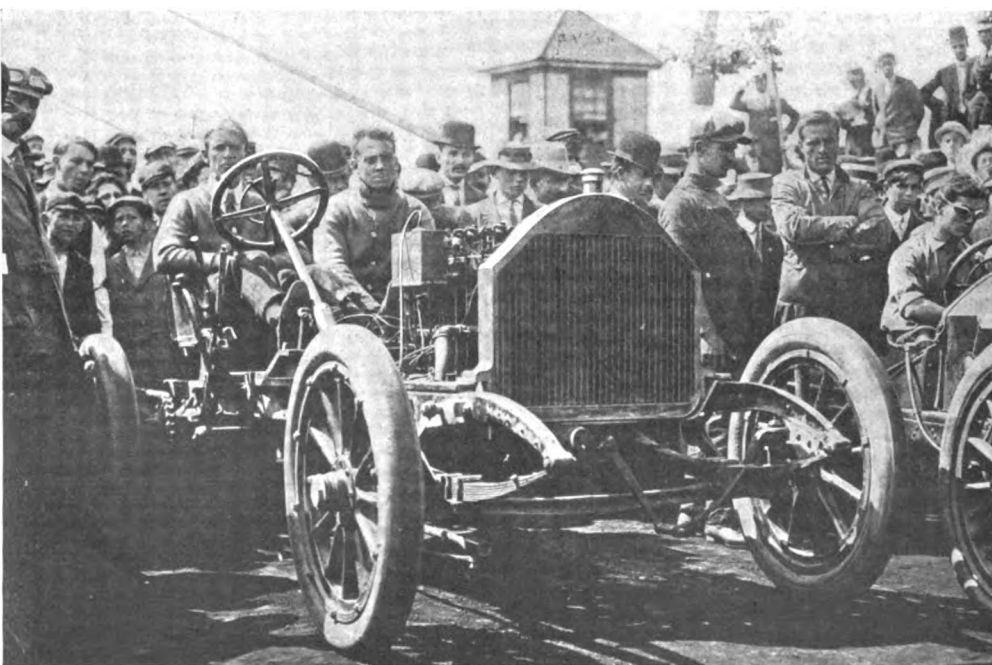

Knox Driven by Dennison, Which Was the Winner of Two Events

arrive early, some of the most anxious ones remaining out all night so that they could get a vantage point—that is, a place where a machine might be wrecked or a driver killed.

"The race was a second Vanderbilt in point of crowd and excitement. The visitors arrived yesterday and flocked to the local hotels and garages. The Sterling last evening was like the Garden City Hotel on the night before the much larger Long Island event.

"This morning everyone was out bright and early, and until 9 o'clock the cars kept going up the hill. It is estimated that there were fully two thousand cars parked along the course and neighboring fields. The crowd surpassed that of all previous years."

Yes, certainly it was not unlike a Vanderbilt race in the manner in which the crowd declined to give up the road to the contestants. Starter "Wag" expostulated and cursed and even fought in trying to keep the course clear near the start. Farther up it was even worse. But Providence must have been interested, for most fortunately no one was harmed and the catastrophes were minor in character.

Chevrolet, who is not noted for his caution, had a spill while taking a curve pretty fast, and DePalma went into the ditch, but neither suffered any damage, and the only man hurt was a spectator who fell off a wall and sprained his ankle.

Chairman F. B. Hower, of the A. A. A. contest board, lent his official presence to the occasion, the referee of which was Samuel B. Stevens, well known as an owner and driver of fast racing cars. These two had some embarrassment in disposing of the importunities of Mrs. Joan Cuneo, who had an awful time be-

cause she was unable to obtain permission to participate in the speedfest. But there was "nothing doing" in her case, and so she had to be content with a ride down the hill seated alongside a mere man.

For three days before the climb, the contestants had the opportunity of practicing on the course, the result being that while some obtained experience without damage to themselves, several were put out of the running through accidents which luckily involved only the cars themselves.

From a spectacular point of view the free-for-all held the public interest. The thousands wanted to see the cars extended to the danger limit and beyond. Amateur Brown is a pretty good pilot for the big Benz and there were gasps in plenty as he rushed upward through the lanes of people and around

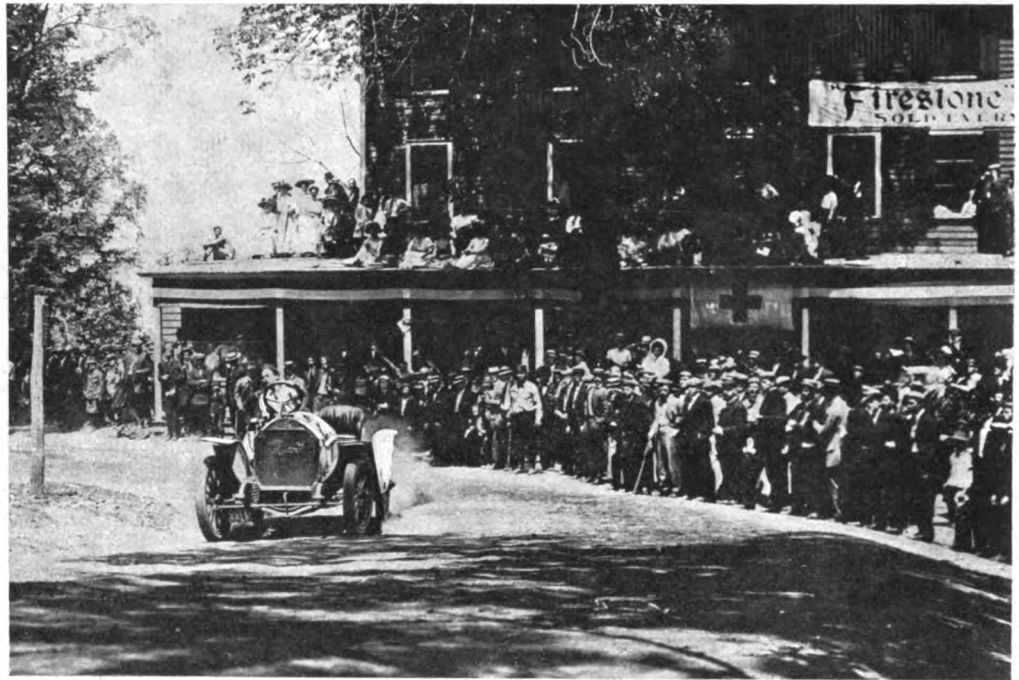

Stoddard-Dayton, a Two-Time Winner, Rounding Mountain House Curve

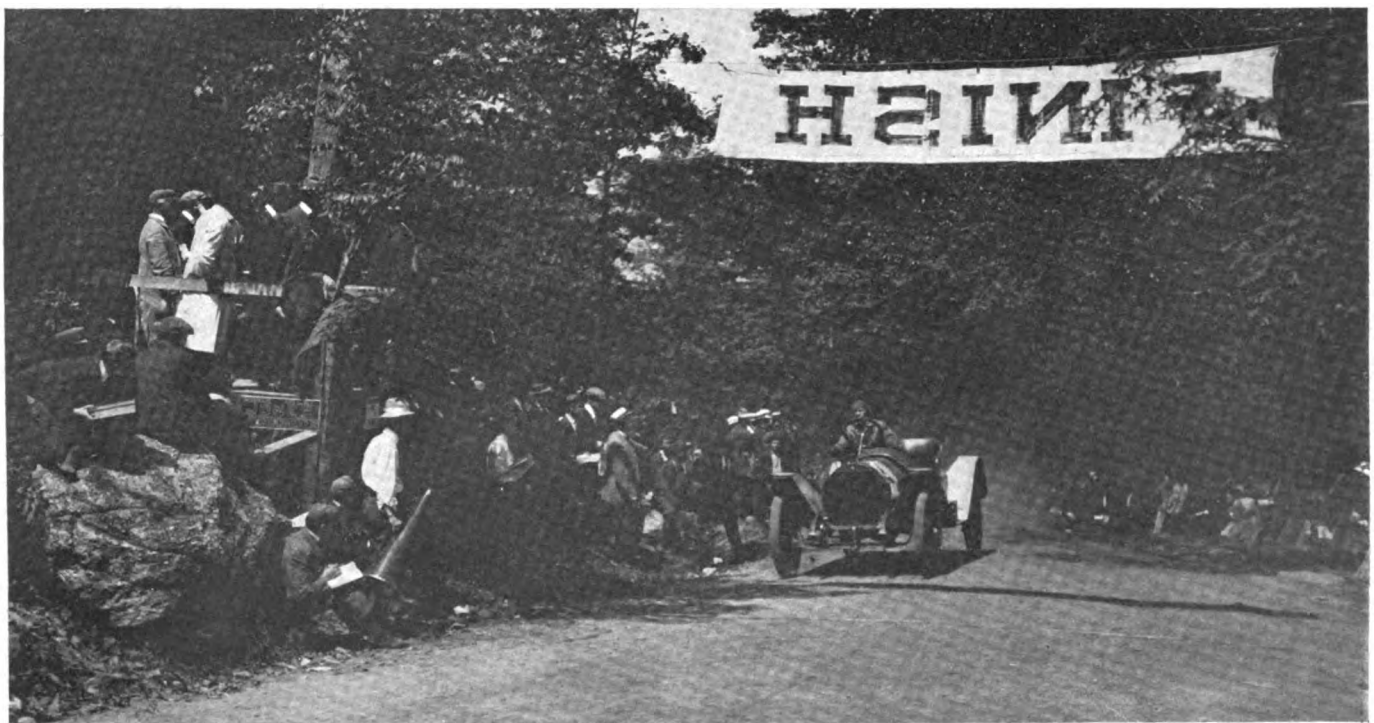

Charles Basle, Driving Matheson, Finishing at the Official Stand on the Top of Giant's Despair

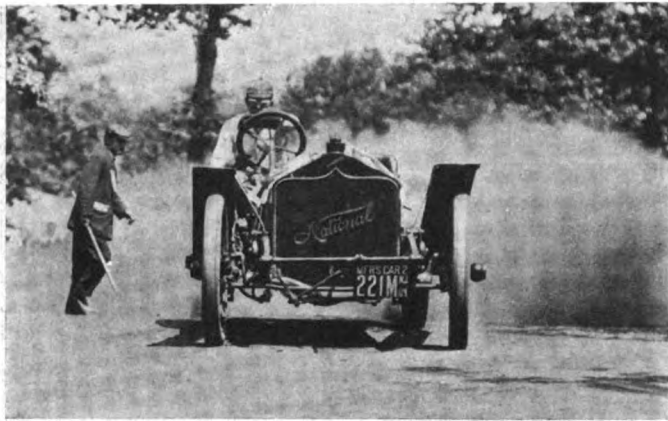

"National" Winner of the Six-Cylinder Event

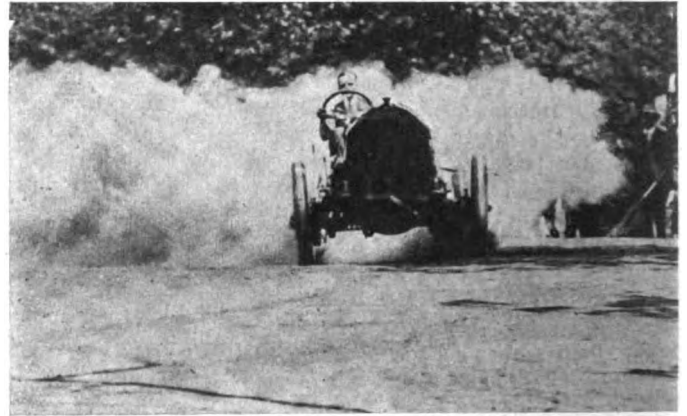

Pilot Larzelere Driving the Big Chadwick

the hazardous curves. Larzelere made almost as thrilling a climb with the Chadwick, which he subsequently repeated in the invitation event with time that was one-fifth of a second better. DePalma had an innings of ill luck. On his first attempt the electric timer failed to work; the second time he suffered a puncture, and on his third opportunity his lightweight racer nearly left the road.

The motorcyclists had a look-in and both events were captured by Wray with an Indian, his best in 1:41 2-5. The summary:

FOUR-CYLINDER GASOLINE STOCK, \$4,000 OR OVER

Pos.	Car.	H.P.	Name of Entrant.	Driver.	Time.
1.	Simplex	90	Simplex Auto Co.	Watson	1:48 3-5

SIX-CYLINDER GASOLINE STOCK, \$3,000 OR OVER

1.	National	60	Natl. M. Vehicle Co.	Merz	1:48
2.	Oldsmobile	60	Olds Motor Works	Berger	2:04 1-5

GASOLINE STOCK, FROM \$3,001 TO AND INCLUDING \$4,000

1.	Stoddard-Dayton	60	Dayton Motor Car Co.	Miller	1:50 1-5
2.	American Roadster	60	Louis G. Vogel	Haupt	2:10 1-5

GASOLINE STOCK, \$2,001 TO \$3,000—HOLLENBACK TROPHY

1.	Knox	40	Knox Auto. Co.	Dennison	1:57 3-5
2.	Matheson	50	Matheson Auto. Co.	Basle	2:00
3.	Stoddard-Dayton	45	Dayton Motor Car Co.	Wright	2:03 3-5
4.	Matheson	50	Matheson Auto. Co.	Basle	2:04 4-5
5.	National	35	Natl. M. Vehicle Co.	Aitken	2:11 1-5
6.	Knox	30	Robert Johnston	Johnston	2:33

GASOLINE STOCK CARS, \$1,251 TO AND INCLUDING \$2,000

1.	Oakland	40	Oakland M. Car Co.	Bauer	2:11 4-5
0.	Buick	30	Buick Motor Co.	Chevrolet	*

* Did not finish.

GASOLINE STOCK CARS, FROM \$851 TO AND INCLUDING \$1,250

1.	Buick	18	Buick Motor Co.	Chevrolet	2:34 2-5
----	-------	----	-----------------	-----------	----------

GASOLINE STOCK CARS, \$850 OR UNDER

1.	Maxwell	22	Maxwell-Briscoe M. Co.	See	2:38 1-5
----	---------	----	------------------------	-----	----------

GASOLINE STOCK CHASSIS, SPECIAL CLASS

Piston displacement of 451 cubic inches and not to exceed 600. Minimum weight of car, 2,400 pounds.

1.	Knox	50	Knox Auto. Co.	Dennison	1:40 4-5
2.	National	60	Natl. M. Vehicle Co.	Merz	1:47 3-5
3.	Stoddard-Dayton	60	Dayton M. Car Co.	Miller	1:48

GASOLINE STOCK CHASSIS, SPECIAL CLASS

Piston displacement of 301 cubic inches and not to exceed 450. Minimum weight of car, 2,100 pounds.

1.	Stoddard-Dayton	45	Dayton M. Car Co.	Wright	2:01
2.	National	35	Natl. M. Vehicle Co.	Aitken	2:03 4-5
3.	Matheson	50	Matheson Auto. Co.	Basle	2:11
4.	Knox	40	Knox Auto. Co.	Dennison	2:18
5.	Knox	40	Knox Auto. Co.	Dennison	2:23 4-5

FREE-FOR-ALL—CARS OF ALL TYPES AND MOTIVE POWER

1.	Benz	120	Jesse Froelich	Brown	1:31 3-5
2.	Chadwick	60	Lee S. Chadwick	Larzelere	1:36
3.	Flat	60	Fiat Auto. Co.	DePalma	1:36 3-5
4.	Knox	50	Knox Auto. Co.	Dennison	1:38
5.	National	60	Natl. M. Vehicle Co.	Merz	1:45
6.	Stoddard-Dayton	60	Dayton M. Car Co.	Miller	1:46 2-5
7.	Simplex	90	Simplex Auto Co.	Watson	1:47 2-5
8.	Babcock Electric	15	Lewis G. Vogel	Peck	3:03

MEMBERS OF QUAKER CITY MOTOR CLUB ONLY

1.	Knox	50	K. B. Harwood	Belcher	1:40 1-5
2.	Oldsmobile	60	W. T. Taylor	Berger	2:02 3-5
3.	American	60	Louis G. Vogel	Haupt	2:07 2-5
4.	Knox	40	Knox Auto. Co.	LaFluer	2:26 1-5

MEMBERS OF WILKES-BARRE AUTOMOBILE CLUB ONLY

1.	Knox	30	Robert Johnston	Johnston	2:21
2.	Oldsmobile	40	William S. Lee	Habblett	2:26
3.	Buick	30	E. A. Wilkie	Wilkie	2:34 2-5
4.	Regal	30	W. S. Moore	Moore	3:18

SPECIAL INVITATION—(WINNER OF FREE-FOR-ALL BARRED)

1.	Chadwick	60	Lee S. Chadwick	Larzelere	1:35 4-5
2.	Flat	60	Fiat Auto. Co.	DePalma	1:40 1-5
3.	Knox	50	Knox Auto. Co.	Dennison	1:41 1-5
4.	National	60	Natl. M. Vehicle Co.	Merz	1:48 4-5
5.	Corbin	30	Corbin M. Vehicle Co.	Swan	1:55 2-5
6.	Matheson	50	Matheson Auto. Co.	Basle	1:58

S. F. EDGE COMES TO AMERICA

S. F. Edge, the well-known British autoist, is taking a look at things American, having arrived Friday last on the *Celtic*. Mr. Edge will be on this side possibly for a fortnight, and during that period he intends to make the most of his time. His American impressions will be well worth the reading, and it is a certainty that such a good publicity expositor as he is will not neglect the opportunity to supply interesting "copy."

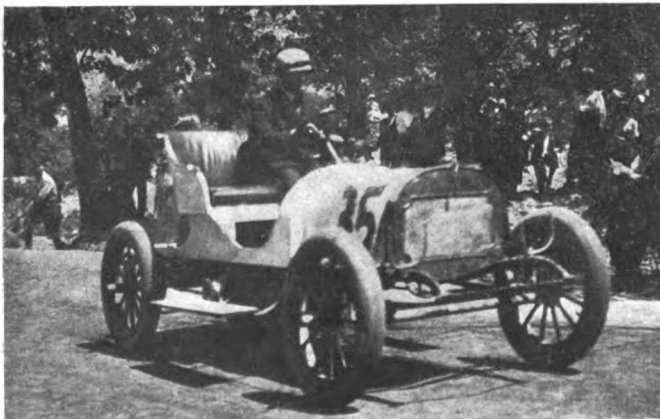

Babcock Electric Which Performed Creditably



Chairman Hower and President Lee Talking It Over

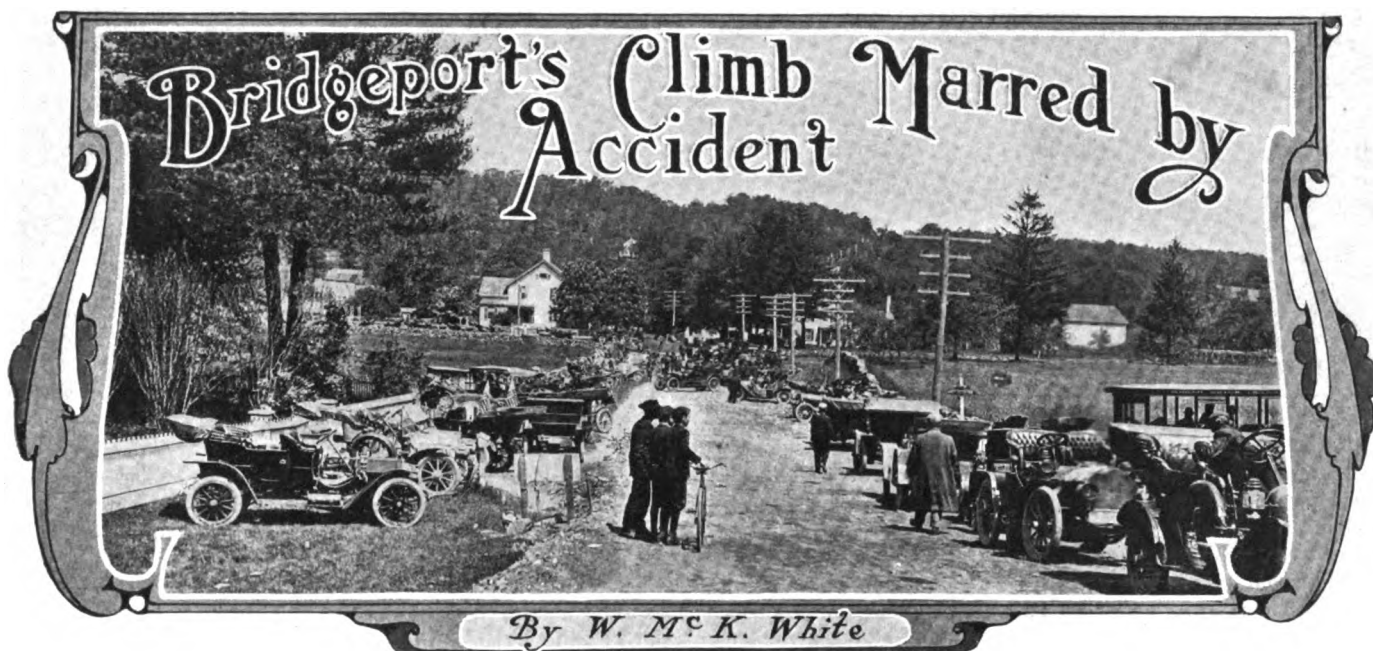

Scene at the Bottom of Sport Hill, Typically New England, with Stone Fences and White Painted Houses

BRIDGEPORT, CONN., May 31.—Sport Hill, the steepest within many miles of this city, was to-day the scene of the third annual climb of the Automobile Club of Bridgeport, and up its perfectly groomed slopes records made in previous events were completely shattered. Seven times did the performance which was considered phenomenal and best last year fall before the swifter cars this morning, and had not the free-for-all been most unfortunately interrupted it is probable that the former record would have been still further relegated to history. Tried racing cars and well prepared stock touring cars, roadsters or stripped chassis, competed with success, many driven by amateurs, until the best previous time of 1:17 was lowered to 1:09 3-5, with six intermediate marks, and two others which equalled the 1908 best.

Joe Tracy in 1907 set up a standard of 1:24 2-5 in a Locomobile Vanderbilt racer; and in the Isotta, which captured many laurels in 1908, Al Poole cut many seconds from that, placing the record at 1:17. To beat this trip of Poole's was the problem before those who rode to-day over a road perhaps slightly better than previously, and with weather conditions ideal. To H. W. Webb in a Panhard of 120-horsepower went the premier honors, his time of 1:09 3-5 setting the new record.

A most unfortunate accident marred the affair just at its conclusion. In the free-for-all, with just two more cars to make the ascent, Glenn Ethridge started up in John H. Tyson's victorious Isotta, and at the worst turn of the course was going very fast. A combination of circumstances—high speed, sharp curve and skidding over the crown of the road—slew the big car into the ditch and before Ethridge could get it

completely under control it had started for the crowd at the roadside. Six men fell before or around it, all seriously injured, one of them possibly fatally, with broken legs and internal concussions. Bicycles were demolished, a tree cut off and a stone wall struck. William Walker, the mechanic, rolled off the car, but Ethridge kept his seat until the machine stopped and the engine was shut down. The militia cleared the course and doctors were soon at hand to minister to the wounded. Surgeons had been stationed at the curve, and fortunately there were others on the course. Touring cars were used to carry the men to the city hospitals after they had received temporary treatment at the roadside. The contest was declared finished. It was the opinion that the Isotta had done most of the damage by side-swiping, rather than by actually running over any one, and no blame was attached to Ethridge. It had been difficult at all times to police the course, for there were at least 10,000 persons massed along a mile of roadway, and the company of the Coast Artillery, 14th Connecticut, under Captain Hawes, did its best to keep the spectators back.

Sport Hill, an even mile in length, has a location permitting of a rolling start, then a comparatively easy grade on a straightaway of about 150 yards, a slight curve to the left and a steeper ascent for 100 yards. The real test is just above this point, where an "S" curve occurs upon a grade of about 12 per cent. All of the faster cars swayed terribly in getting around the lower half and more than once the crowds thought that the machines would turn over. It was just such an occurrence that happened to the big Isotta. From the upper part of this difficult section there was a nearly straight run to



Bourque (Knox) Rounding a Turn



Chalmers-Detroit, Winner of the \$3,000 Runabout Class, Crossing the Bridge Near the Starting Point

the finish at the top on a practically level stretch. All along the way there were automobiles parked, perhaps 250 lining the upper reaches, and at vantage points the crowd was thickest.

Shortly after 8 o'clock the first car was sent away. It was a little Maxwell Junior in a class for gasoline cars costing under \$850, and it was followed by one of the new four-cylinder Maxwells, driven respectively by Barnes and Goldthwaite. The latter won in the good time of 2:19 4-5.

The record for the course had its first attack in the fifth event, a class for runabouts of the same price division as the touring cars in the fourth, and Lorimer piloted a Chalmers-Detroit roadster up the hill in 1:16 2-5, 3-5 of a second better than ever before done officially. Harry Tuttle, in a 45-horsepower Stoddard-Dayton roadster, was second in 1:23, and C. B. Tiley, in a "Tiley," a newcomer and the latest production of Bridgeport, was third in 1:27 2-5. The Tiley car has a "short" four-cylinder motor of 5-inch bore and 4 3/4-inch stroke and full floating rear axles with shaft drive.

The first large field of the day was brought out in the eighth event, one for amateur drivers of gasoline cars, and it had seven starters and six finishers. It was in this class that the big Panhard had its inning and made the record. The car went up very easily, and in comparison with others which traveled at high speed it had less trouble on the curves, hardly skidding at the "S" turn, although it went by like a flash of blue. Broesel in the Simplex was second, his time being 1:16, slightly better than when he won the class just ahead. Alden in a Chalmers-Detroit was third in 1:17 1-5, and Doig in a Stearns fourth in 1:21 2-5. Another Stearns, driven by McNeil, was but 2-5 of a second slower than Doig. The Tiley car showed consistency by ascending in exactly the same time as before, 1:27 2-5.

That the free-for-all was going to furnish excitement was evident as soon as it started, because of the remarkable manner in which previous records became back numbers. Bourque flew up in 1:10 1-5 in the Vanderbilt Knox car of 38-horsepower,



Maxwell, Winner of the Little Runabout Class

closely followed by Coffey in the stripped Columbia racer in 1:11 1-5, and then by Lorimer in a Chalmers-Detroit in 1:17. Harry Cobe had a six-cylinder Lozier in action, and its time was 1:22 1-5. Alden had a fast Chalmers-Detroit next, and it gained the under-the-record class by covering the course in 1:15 3-5. The Renault racer had difficulty in making speed because of its lack of a differential, and it skidded badly on the curves, thereby losing traction and time. Near the finish a tire blew out and that further retarded it, so that its time was snapped at 1:22 3-5. Following the Renault was the Isotta driven by Ethridge, and after it would have been the Panhard and another Isotta.

A. L. Riker acted as referee. The contest committee of the club is composed of: Chairman, Ralph M. Sperry, G. S. Bryan, F. W. Bolande, J. B. Lyford, F. A. Rantz, A. K. L. Watson, A. H. Canfield, W. W. Nichols, H. M. Lyon, H. B. Stoddard, F. T. Staples, B. H. Edwards, H. D. Gates, A. McNeil, Jr.; R. C. Sherwood, F. L. Mills, F. A. Strong, E. W. Hanke, E. W. Fairchild, H. D. Miller.

GASOLINE STOCK CARS, \$4,001 AND OVER

No.	Car.	H.P.	Cyl.	Entrant.	Driver.	Time.
36	Simplex	53	4	Carl A. Broesel	Broesel	1:16 3-5
42	Isotta	50	4	Bradley	Pepperday	1:17

STOCK CARS, \$3,001 TO AND INCLUDING \$4,000

35	A-K	48	4	S. E. Mooskovic	Hughes	1:18
20	P. & S.	51	6	P. & S. Mfg. Co.	Lescault	1:33 3-4

STOCK RUNABOUTS, \$2,001 TO AND INCLUDING \$3,000

18	Chalmers-Det.	40	4	C. H. Page & Co.	Lorimer	1:16 2-5
17	Stoddard-Dayt.	45	4	Harry Tuttle	Tuttle	1:23
19	Tiley	30	4	C. B. Tiley	Tiley	1:28 2-5
16	Columbia	29	4	Bell Brothers	Coffey	1:28 3-5
15	Knox	38	4	Knox Auto Co.	Bourque	1:30 3-5

STOCK TOURING CARS, \$2,001 TO AND INCLUDING \$3,000

14	Chalmers-Det.	40	4	C. H. Page & Co.	Lorimer	1:20 2-5
11	Knox	38	4	Knox Auto Co.	Bourque	1:33 2-5

STOCK CARS, \$1,251 TO AND INCLUDING \$2,000

10	Buick	30	4	Buick M. C. Co.	Burman	1:20 1-5
7	Buick	30	4	G. M. Hammond	Hammond	1:37
9	Chalmers-Det.	40	4	W. A. Maynard	Maynard	1:53
41	Pullman	20	4	A. McMullen, Jr.	McMullen	2:20 1-5

STOCK CARS, \$851 TO AND INCLUDING \$1,250

5	Buick	18	4	Buick M. C. Co.	Burman	1:30
4	E-M-F	30	4	Buckley Auto Sta.	Buckley	1:45 4-5
40	Overland	30	4	Fairfield Auto Co.	Kubey	1:58 4-5

GASOLINE STOCK CARS, \$850 AND UNDER

2	Maxwell	20	4	Maxwell-Briscoe Co.	Goldthwaite	2:19 4-5
1	Maxwell	10	2	Miller M. C. Co.	Barnes	4:51 4-5

AMATEUR DRIVERS OF GASOLINE CARS

34	Panhard	120	4	H. W. Webb	Webb	1:09 3-5
37	Simplex	53	4	Carl A. Broesel	Broesel	1:16
21	Chalmers-Det.	40	4	J. V. Alden	Alden	1:17 1-5
22	Stearns	60	4	J. Doig	Doig	1:21 2-5
39	Stearns	60	4	K. W. McNeil	McNeil	1:21 4-5
23	Tiley	30	4	C. B. Tiley	Tiley	1:27 2-5

FREE-FOR-ALL

25	Knox	38	4	Knox Auto Co.	Bourque	1:10 1-5
26	Columbia	29	4	Bell Bros.	Coffey	1:11 1-5
30	Chalmers-Det.	40	4	C. H. Page & Co.	Alden	1:15 3-5
28	Chalmers-Det.	40	4	C. H. Page & Co.	Lorimer	1:17
29	Lozier	50	6	Lozier M. C. Co.	Cobe	1:22 1-5
31	Renault	60	4	Bpt. Vehicle Co.	Rasslovitch	1:22 3-5
32	Isotta	50	4	J. H. Tyson	Ethridge	*

*Did not finish.

QUINETTE OF CARS LEAVE NEW YORK FOR SEATTLE

TWO Fords, a Shawmut and an Acme, of America, and an Itala of Italy are en route from New York City to Seattle as the contestants in the ocean-to-ocean endurance contest for the M. Robert Guggenheim transcontinental trophy. At 3 o'clock Tuesday afternoon, June 1, when it was just noon in Seattle, President Taft pressed a button in the White House which gave signals in the metropolis and in the city on the Pacific coast, starting the contest in the East and the Alaska-Yukon-Pacific exposition in the West. When the telegraph instruments showed to the group on the City Hall steps that the President had pressed the golden key, Mayor George B. McClellan fired a shot from a golden revolver, starting the five cars on their long journey from the Atlantic Ocean to the city on Puget Sound. The contestants had been parked in front of the public building some time earlier, fully equipped for a long distance journey, but the enormous crowd which gathered was kept at a distance by a cordon of mounted and foot police. At the shot the machines pulled into line, and, following a police officer in a conspicuous yellow taxicab, proceeded up Broadway, through "Automobile Row" and on toward Poughkeepsie, the first stop for a night, whither they were preceded by a pacemaker.

The Fords attracted a great deal of attention, not only because of their size but also because of their general get-up. The motors had no mufflers, exhausting through an opening in the side of the hood into the air. The body consisted of two seats for the drivers, with a platform at the rear for carrying baggage and supplies, covered with a brown canvas. The chassis was stripped of everything not absolutely necessary, such as fenders and the running gear was painted a dull gray. Natural colors remained in all other parts, such as aluminum unfinished for the bodies, sheet iron unpainted hoods, and unpainted gas and oil lamps. Henry Ford was on hand to see that the little machines were started safely, assisted by his New York and Philadelphia branch managers, Gaston Plaintiff and Louis C. Block.

The big six-cylinder yellow Acme was the only representative of the six in the contest, all of the others being fours. This car is fitted with bucket seats for four people, and the big gasoline tank is between them. Tires are carried at the rear and supplies in large boxes on the running boards. The Acme was the

largest of the quintette, and carried a full load of passengers.

Shawmut was the fourth to leave the plaza in the line, and it was particularly noticeable because of its extra large wheels, using 40-inch wheels and tires, with a body for four men, tires and supplies being carried between the two seats. These are extra high at the back and have small side strips carefully upholstered to act as head-rests when one set of drivers takes a sleep. The car is painted white.

The only foreign representative is the Itala, which was entered at a late moment, but it was fully prepared, with a special demitonneau body for four passengers and with the supplies carried in the tonneau and the tires at the rear. It is painted a lead color and stripped down as much as possible. The Shawmut and Acme are the only ones carrying running boards and mudguards. All of the tourists started in conventional khaki uniforms.

A six-cylinder Ford roadster is being used as a pacemaker and carries the Automobile Club of America representative, and will go ahead of the cars as far as St. Louis. The competitors will not be allowed to pass it. The rules provide that the cars must stop each night at certain places which have been selected. The run on Tuesday was to Poughkeepsie, 73 miles; that on Wednesday to Syracuse, 207 miles; to-day, Thursday, to Buffalo, 150 miles; Friday to Toledo, 296 miles; Saturday to Chicago, 244 miles, and Sunday to St. Louis, 283 miles. From St. Louis the contest is a free-for-all one, the only requirement being that the cars must check at certain points en route to show that they have not cut the course. The engine base, cylinders, transmission case, steering gear, frame, front and rear axle of each contestant were stamped by the A. C. A. The following are the names of the cars with their horsepower, crews and tires:

No. 1—Ford, 20 horsepower, Frank Kullck, H. B. Harper. Firestone tires.

No. 2—Ford, 20 horsepower, B. W. Scott, C. J. Smith. Firestone tires.

No. 4—Acme, 45-50 horsepower, George Salzman, F. R. Sheets, Jerry Price, J. A. Hemstreet. Firestone tires.

No. 5—Shawmut, 40 horsepower, T. A. Pettingill, Earl Chapin, Robert Messer. Diamond Tires.

No. 6—Itala, 45 horsepower, Gus Lechleitner, F. B. Whittemore, Elbert Bellows. Continental tires.

Pacemaker—Ford, 40 horsepower, F. W. Teves, John H. Gerrie.

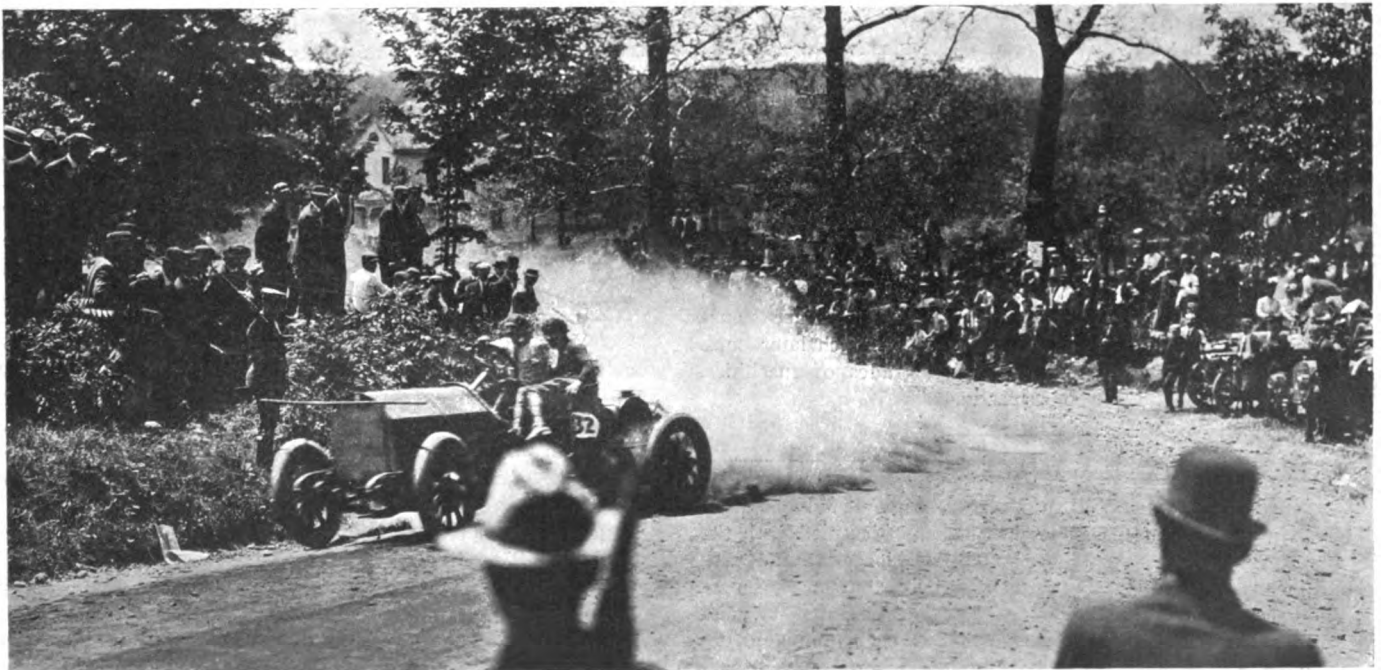

Ethridge Driving the Isotta at Bridgeport Climb, Just as It Began Its Fatal Dash Into the Ditch and the Spectators

FINAL ARGUMENT IN PROGRESS IN SELDEN SUIT

BEFORE Judge Hough in the United States Circuit Court, Southern District, there is being heard the final argument in the so-called Selden patent suit. One whole week was allotted for the concluding argument, it having begun on Friday last, and will end Friday of this week. From 10.30 A.M. to 5 P.M. daily, with an hour's intermission for lunch, the courtroom in the New York Post Office building has been thronged with the most notable array of attorneys, possibly, ever engaged in patent litigation at one time.

While it is true that any decision by Judge Hough may be carried to the Court of Appeals, the impression prevails that the effect of his decision will be substantial and satisfying to most of those concerned in the long-drawn-out story which began in the early days of automobiling in this country, due, to a great extent, to the organizing genius of the late George H. Day. Even opponents recognized the ability of this man.

The legal battle is in the form of suits brought by the Electric Vehicle Company and George B. Selden against the Ford Motor Company as manufacturer, John Wanamaker as dealer and agent, C. A. Duerr & Co. as dealer and agent, and the O. J. Gude Company as user of a so-called unlicensed car. Additional suits are against the American branch of Panhard & Levassor, of Paris, and Henry Neubauer, importer of foreign cars. Of course, the A. L. A. M. is the power behind the suits.

These various suits involving manufacturer and dealer and user and foreign maker and importer cover the entire situation. The legal talent is more than notable. The "licensed" list includes William Redding, well known for many years in patent matters; Betz, Sheffield, Bentley & Betz; Greeley & Austin, and Frederick P. Fish, of Washington, D. C., who will probably make the final presentation on Friday.

R. A. Parker and W. Benton Crisp represent the Ford Motor Company and also look after the interests of John Wanamaker, C. A. Duerr & Co., and the O. J. Gude Company. Cordoza & Nathan are also general attorneys for the Ford Company, while Coudert Brothers represent Panhard & Levassor and Henry Neubauer.

It is expected that the summing up Friday will attract many prominent men of the automobile industry, for brilliant arguments are assured. While it is considered probable that an appeal will go to the Court of Appeals, it is believed that nothing will ever reach the Supreme Court, which of its own volition only would interest itself in considering the evidence transmitted from the Circuit Court to the Court of Appeals.

A prodigious amount of testimony has been adduced from both sides, but it would appear from his occasional comments and rulings that Judge Hough has a fairly comprehensive idea of the importance of the suit being tried.

WILLYS ANNOUNCES TOLEDO PLANT PLANS

TOLEDO, O., June 2—The Overland Automobile Company has finally arranged all details for the purchase of the plant of the Pope Motor Car Company in this city, and prior to leaving for a seven weeks' trip to Europe, J. N. Willys, president of the Overland company, announced the policy of the company to be as follows:

"Within a few days contracts will be let for erecting a three-story addition to the Toledo plant, 80 x 35 feet. This new part is to be occupied by the Kinsey Manufacturing Company, of Dayton, O., whose plant is to be brought to this city. Almost the entire output of this concern, which consists of automobile parts, will be used by our company, and the working force of this department is to be increased to 500 men.

"The purchasing, engineering, and sales departments of the Overland company are to be brought to Toledo immediately, and within four months between 1,500 and 2,000 men are to be employed in the local factory.

"Orders have already been placed with us for 5,000 cars for next season, and the output will probably not be less than 10,000, and more likely 15,000. Of this number one-half are to be manufactured in Indianapolis.

"Contracts have already been let for over \$50,000 worth of new machinery, which is to be placed in the new department, and also to replace certain present machines which are somewhat antiquated, or at least can be replaced by much later ones. The present plan is to manufacture two grades of machines, selling for \$1,250 and \$1,500 respectively."

METZGER BECOMES INTERESTED IN WHEEL

CLEVELAND, May 31—William Metzger, who recently sold his interest in the E-M-F Company, has become identified with the Seaton spring wheel. As to the extent of his connection with the company nothing has yet been definitely announced, but it is understood that he will give considerable of his time to what will be known as the American Spring Wheel Company, the foreign patents of which will be handled by the International Spring Wheel Company. H. L. Olmstead has accepted the position of engineer for the American company.

AUTOMOBILES MET THE EMERGENCY

ATLANTA, GA., May 31—When the firemen of the Georgia Railway went on a strike and sewed up the entire line—some 307 miles long—so tight that never a wheel turned from May 23 to the night of May 29, they gave automobiles a wonderful opportunity to dash into the limelight.

The newspapers were the first ones to face the problem of getting into this territory. The night the strike became effective, the Atlanta *Constitution*, a morning paper, started a car down the Georgia road. The next afternoon the afternoon papers raced cars along the Georgia road, delivering seventy-eight miles down the line, despite roads softened by a two weeks' rain.

After various cars had tried their luck at fast running through the mud, the Southern Branch of the White Company cornered the paper transporting market, and five or six steamers were in service every day, carrying tons and tons of papers as long as the tie-up lasted. These newspaper cars carried mail as well as papers, and picked up an occasional passenger.

But the taxicabs and other motor cars did the main passenger business, traveling hundreds of miles up and down, parallel to the trainless Georgia Railway, and conveying to and fro such passengers as had urgent business and the wherewithal to pay.

NEW YORK WILL TREAT ORPHANS RIGHT

NEW YORK CITY, May 31—As the Annual Automobile Day approaches the interest increases and the prospects for the largest event in the past five years also improves. The committee is hard at work raising cash and securing the use of cars for the day. Up to date over 75 cars have been secured and more are in sight, of which 12 are taxicabs, 6 of the W. C. P. Yellow Cab line, and 6 red taxicabs.

Arrangements have been made with the management of Dreamland to throw the whole show wide open on that day, and there it is that luncheon will be served, although the problem of paying for it has not been solved.

A new plan of forming the parade and laying out the route will be adopted this year on account of the opening of the new Queensboro Bridge. The parade will form in the streets of Automobile Row, north of Columbus Circle.

Automobile Gasoline and Other Available Fuel

By Thos. J. Fay

Part VIII

TIMING the spark is not all that has to be done in order that the mixture will afford the maximum result. If valves are used, as they are in 4-cycle motors, they have to be timed in such a way as to admit the charge to the fullest possible extent, and to allow the spent products of combustion to escape. In 2-cycle motors valves are not used, and in them it becomes a matter of perfection of design in order to afford the desired results. The relative advantages will be discussed at the proper time, and for the present it will be the aim to point out a certain similarity in them, in so far as the fuel problem is concerned.

In general, no matter what may be the way of admitting the mixture and scavenging, the results will only be the same if the mixture is admitted at the same time and if the exhaust is allowed to escape under similar conditions. If a motor, because of defects in the methods of design, will not afford the requisite time for the mixture to enter the cylinders or the exhaust to escape, the power stroke will not be so effective and the power of the motor will be reduced.

In such a motor, if the exhaust is imperfect, the speed will be reduced, and in consequence the power of the motor will be reduced, because the number of power strokes will be less. In the same motor, if the intake is restricted, the torque will be diminished and the power will be reduced more rapidly as the speed increases, because the torque will reduce more rapidly than the speed increases. If it takes a given period of time for the mixture to enter a cylinder this fact will not be altered because the design of the motor is changed. An abstract fact is not changed merely because the design thwarts the plan, and the lesson to be drawn is obvious.

These are matters of more than a little importance when designs are being considered, and any design that prevents complete scavenging must offer other advantages to offset the disadvantages, or the results will be below a fitting standard. Torque is equal to the sum of the power strokes, minus the sum of the power-consuming increments. This same torque, which is but another name for torsional moments (torque, to twist), may be due to the power stroke in one or two more cylinders, and it may be due to:

(A) One power stroke for every four revolutions, as in 4-cycle motors.

(B) One power stroke for every two revolutions, as in 2-cycle motors.

(C) One power stroke per cylinder, per complete cycle, in any motor.

The sum of the torque increments might be the same, irrespective of the number of cylinders, and independent of the cyclic relation, for the reason that the torque is proportional to the weight of fuel burned to complete combustion, and it would seem as if practical limitations are such as to thwart all the designs beyond a certain point. Of course, there is a certain advantage to be expected from a

large number of light torque impulses, in comparison with a few of such impulses, in a given time. On the other hand, it is the general impression, gained in practice, that one good power stroke is of far more advantage than two "soft" power strokes. There is some truth in the idea.

The probabilities are that the practical way of putting it falls short of a true explanation, due to the complicated nature of the problem and the lack of understanding of both sides of the subject by any one of the practitioners. It cannot be claimed that the results will be different if the sum of torque increments of the power strokes are the same, considering two types of motors, but it may be true that one of the motors will deliver its impulses with greater regularity, due to better conditions of scavenging, from the point of view of regularity. That regularity is one of the grave necessities is true, and this phase of the problem is sometimes overlooked, nor can this much desired property be depended upon in a motor that does not enable the spent products of combustion to escape quite completely.

Valve-Timing Classes in the Fuel Problem—Independently of the mechanical means of accomplishing the desired results, the time allowed for the gases to enter and leave the cylinders should be the same in any given sized motor, considering a given result per power stroke and a conventional design of motor. The following general considerations will be in order:

(A) The inlet should be opened at the earliest possible instant, even before the exhaust is closed, in types of motors that will allow of the practice; which is true in 2-cycle work, as a rule, and in some 4-cycle motors, especially when the crankshaft speed is high, as it is when the stroke is short.

(B) The inlet should not, of necessity, close at the end of the suction stroke, nor is it good practice to set the closing of the inlet the same in all designs of motors.

(C) The exhaust should open before the end of the power stroke, as it does in 2-cycle motors, and in nearly all 4-cycle motors as well. Just when to open the exhaust is a matter that

is not easy to settle upon, and that it will not be the same in all designs of motors is a matter to be taken for granted. In a long-stroke motor, for illustration, while it would do no harm to open the exhaust early, very early indeed, the advantage in doing so would be but slight. In short-stroke motors the advantages of an early opening are assured, and disadvantages are also present.

(D) The closing of the exhaust is of equal importance, and if the motor is of the high-speed variety it is probable that the valve can remain open until after the inlet is opened.

(E) Valve-timing, from what has been said, is a matter that must take into account the speed of the crankshaft and the stroke of the piston. It is a case of balancing the gains against losses.

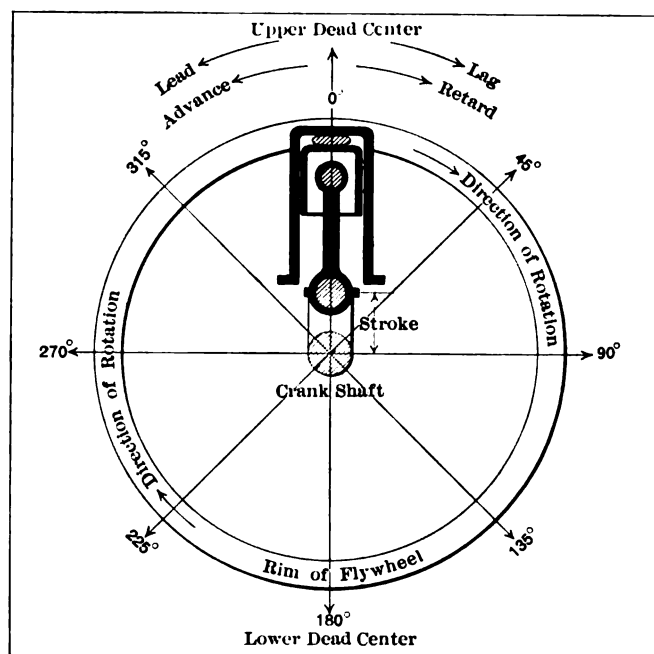

Fig. 40—Diagram depicting relations of advance, retard, lead and lag in the process of timing valves and the ignition.

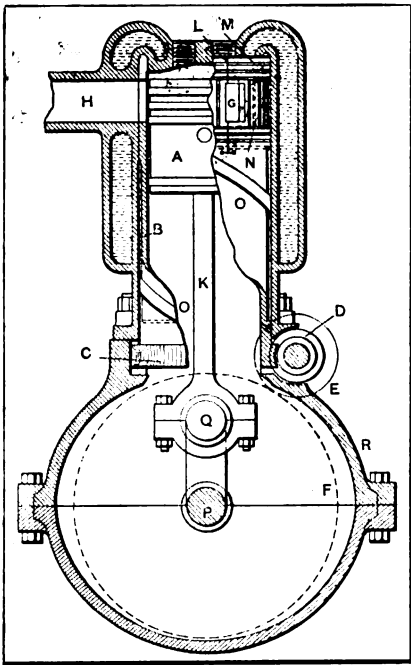

Fig. 41—Cross-section of a Ledru two-cycle motor, showing a rotary valve system.

Fig. 40 will render clear the terms advance, retard, lag and lead. As the figure shows, when the spark, for illustration, is advanced, it is caused to propagate earlier in the revolution of the crank, so that to advance the spark it is necessary to cause the same earlier, and the word "advance" really means that the spark is advanced against the revolution of the crankshaft. Likewise, a retarded spark is one that is propagated late in the revolution of the crankshaft. A fully retarded spark is one that is produced under ordinary conditions

(on the power stroke) at about 5 degrees. A fully advanced spark is one that is produced (on the compression stroke) at about 315 degrees, which angle represents 45 degrees, before upper dead center, and $360 - 45 = 315$ degrees. This angle is more than is customary in motors in general, yet even so it is not more than the mechanism should afford, in view of the conditions that are possible in modern high-speed work.

The upper dead center is marked as 0 degrees, so that all angles are computed from this point. In dealing with the early and late opening and closing of the valves (on the bottom dead center), all valves that close before 180 degrees close early, and all valves that close after 180 degrees close late. If the admission valve remains open for 15 degrees beyond the bottom dead center, for illustration, it will close late, and the angle of closing will be 195 degrees on the inspirating stroke. On the other hand, if the exhaust valve opens 45 degrees before the bottom dead center it is said to open early, and the angle of opening will be 135 degrees on the power stroke.

Example of Angles in an Average Valve Timing—Considering a motor at a speed of 1,400 revolutions per minute of the crankshaft as representing an average case, the valves would do satisfactory work were they timed in the manner as follows:

- Lead given in opening the exhaust valve.... 45 deg.
- Lag in closing inlet valve..... 15 deg.
- Lag in closing exhaust valve..... 7½ deg.

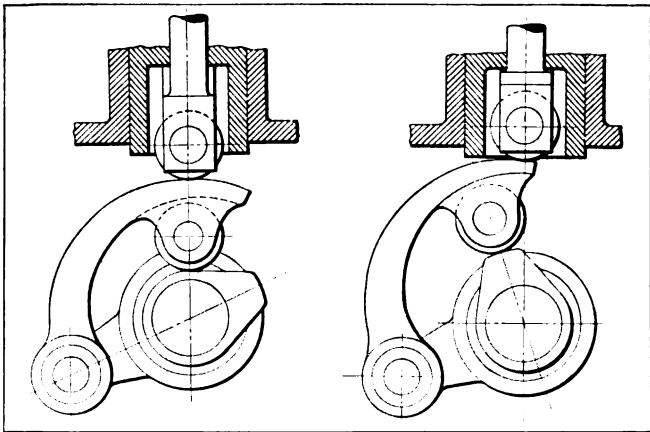

Fig. 42—Scheme for accelerating the process of adjusting the timing of valves by means of a cam-follower.

- Lag in opening inlet valve..... 15 deg.
- Exhaust valve opens on the power stroke... 135 deg.
- Inlet valve closes on the compression stroke. 195 deg.
- Exhaust valve closes on the suction stroke... 7½ deg.
- Inlet valve opens on the suction stroke..... 15 deg.

Under certain conditions it would be possible to open the inlet valve early and close the exhaust valve late, but this is not a condition that is to be recommended as a general proposition, in the absence of definite information in relation to the motor and the service to be rendered by it.

In closing the inlet valve late on the bottom dead center it is the aim to take advantage of the inertia of the gas stream, and if the design is right there is no question as to the resulting gain. There is one other point to be considered—it is only possible to time the valves if the design is such that the inlet and exhaust valves are separated from each other, as they are in poppet-valve motors. Take the rotary valve, for illustration; it is not one that will lend facility to a plan of overlapping the opening of the inlet with the closing of the exhaust. Indeed, there must be a period of time when both valve ports will be closed, since there must be a separating wall between the inlet and the exhaust ports. Fig. 41 shows a motor in section, in which the timing of the valves is due to the rotation of a sleeve inside of the cylinder walls, within which sleeve the piston reciprocates.

In this motor, which is of the "Ledru" type, the action is on a two-cycle basis, and while it is not of a design that will lend itself to timing variations, it is the aim to compensate for this by two-cycling, thus doubling the number of power strokes. Referring to the figure, it is to note that the piston A works inside of the sleeve B, which sleeve is rotated by the worm-gear C, actuated by the worm D, driven, in turn, by the gear E, taking its power from the crankshaft P through the large gear F. The rest of the performance is not of interest from the point of view of this discussion, hence this type of motor will be dropped for the present.

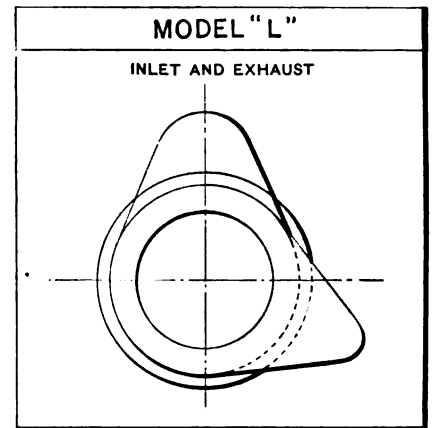

Fig. 43—Maxwell camshaft for inlet and exhaust valves combined, showing contour.

Means for Adjusting the Timing of Valves—Even when poppet valves are used it is not possible to alter the timing after the design is completed, excepting within narrow limits, unless some special device is introduced for the purpose, and even then it is a question if the added complication is not considerable of a load to carry, considering that the design might be made once and for all on a basis to exclude all such complications. Fig. 42 shows one way of affording a means of ready adjustment, a description of which was given as follows:

Variable Valve-Timing Mechanism—"It will be seen that the cam follower remains the same as in average practice, as does the cam also, but that the action between the cam and the so-called follower is not direct. Surrounding the camshaft, and using it as a fulcrum, is a lever. To the outer end of this lever is fulcrumed a second lever, which carries a roller for making contact with the cam directly and communicating the motion of the cam through itself to the reciprocating follower. In action it is possible with this device to vary the times of valve opening and closure through rotating the first of these levers about the camshaft in the desired direction."

Timing as It Is Practised in Maxwell Cars—What actually transpires in practice is of the greatest utility, particularly when the results are commendable. The table that follows shows the

practice in connection with Maxwell cars of the several types, and the cams are shown in Figs. 43, 44, 45, 46 and 47. The figures are given full size, so that it is possible to note the contour, and it is one of the points of merit in these cars that the action is noiseless and the cams are efficient and durable. The table is sufficiently clear to require no further explanation, and, while the angles of opening and closing of the valves may not fully accord with the practice in some other cases, it seems to be right for Maxwell motors at any rate.

In Further Relation to Opening Inlet Valves—It rarely ever happens that the inlet valves are opened early, nor can it be shown by any line of reasoning that an advantage will follow if inlet valves are opened early. A late opening assures that there will be a depression in the chamber when the inlet valve opens. That there should be a depression in the chamber at the time of opening of the inlet valve is one of the points that can be made, and it is also true that a considerable lag, in degrees, on the periphery of the flywheel means but a small depression in the chamber. It will come as no great surprise, then, to note that in some motors the inlet opens very late indeed. As an illustration of a case with a very late opening, attention is called to the Unic, 20 H.P., in which the inlet was found to be 34 degrees late. In the Maxwell cars, as the table shows, all the inlet valves open at 15 degrees late, which seems to be a good average figure in general practice, considering motors of the speed of the Maxwell.

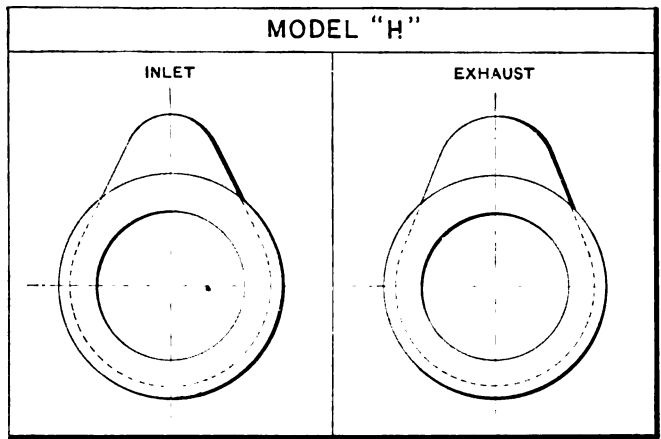

Fig. 44—Maxwell cams, showing a round-top contour in the inlet side, thus assuring an adequate opening.

while the valves may open on time and, in so far as they are concerned, do all that can be fairly expected; even so, if the exhaust is retarded (beyond the valves) the results will be inferior.

Fig. 48 depicts an effort on the part of the Pierce designers to afford an easy exhaust; indeed, they go so far as to attempt to generate a vacuum in the exhaust manifold, with the idea

TABLE SHOWING TIMING ANGLES FOR MAXWELL MOTORS AND OTHER DATA OF INTEREST

MODEL	TIMING OF VALVE IN DEGREES AND EQUIVALENTS OF INCHES ON FLY WHEEL								Diam. of Fly Wheel	Stroke of Cylinder	Diam. of Cylinder	No. and Type of Cylinders	H.P. of One Cylinder	Normal Speed Rev. per Min.	Max. Speed Rev. per Min.
	INLET				EXHAUST										
	Opens		Closes		Opens		Closes								
Degrees	Equiv.	Degrees	Equiv.	Degrees	Equiv.	Degrees	Equiv.								
L.....	15° late	2 3/8"	40° late	6 1/4"	40° early	6 1/4"	10° late	1 9-16	18"	4"	4.5"	2 horiz.	6	800	1200
H.....	15° late	2 1/8"	40° late	7"	40° early	7"	10° late	1 1/4"	20"	5"	5"	2 horiz.	8	750	1000
Q.....	15° late	2.289"	40° late	6.104"	40° early	6.104"	10° late	1.526"	17 1/2"	4"	3.75"	4 vert.	4.5	900	1400
K.....	15° late	2.487"	40° late	6.633"	40° early	6.633"	10° late	1.691"	19"	4 1/4"	4.25"	4 vert.	6.5	800	1200
M.....	15° late	2 1/8"	40° late	7"	40° early	7"	10° late	1 1/4"	20"	5"	5"	4 vert.	10	800	1200

NOTE—In timing valves, piston should be on upper dead center.

In any event, there is one point that is assured on the face of it: there is nothing to be gained in opening the inlet valve sooner than gas will flow in, and that is when a depression is created. On the other hand, there is a decided advantage in keeping the exhaust valve open as long as possible, and this is only practicable when the inlet valve is opened late, unless it is desired to have both valves open at the same time. That they can be open at the same time is true in high-speed motors, but it is a question if flexibility will still be present. Certainly there is some chance of popping in the intake if the two valves are so open, provided the speed of the gas is slowed down sufficiently, which will be true when the motor speed is low enough. Flexibility, then, is probably sacrificed in the motors that are so timed that the inlet valve opens before the exhaust valve closes. In the Maxwell cars the exhaust valves close 5 degrees before the inlet valves open, and this is an ample margin for safety. It is even a question if the Maxwell has not erred on the safe side, which, by the way, is a good fault in cars to be placed in the hands of users.

Certainty of action is one of the great points in favor of a fine performance in automobile motors in particular, on account of the entire absence of mechanical skill on the part of many autoists, and this certainty is not to be regarded as present unless the motors will perform when they are heated up as well as when they start out for a day's run. On this account it is necessary to pay attention to the exhaust to a marked degree, for

of pulling the exhaust gases away from the valves, and in this way an attempt is made to increase the power of the motor. The idea is very simple, consisting only of so shaping the exhaust manifold that a nozzle effect will be engendered, and the area of the manifold is so calculated that the resistance against the efflux of gas is but slight, and well regulated besides. Tests

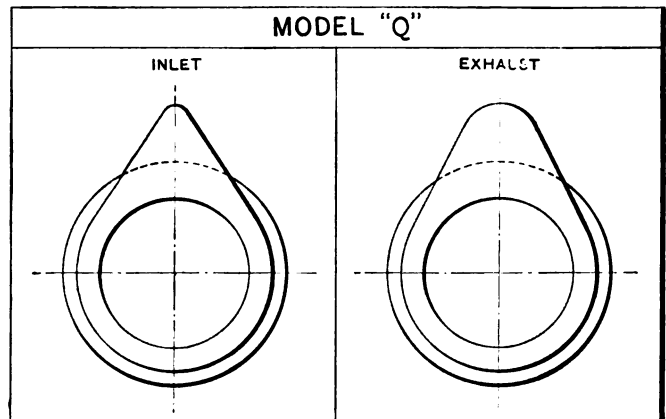

Fig. 45—Maxwell, with inlet cam, designed for the characteristics of Model Q motor

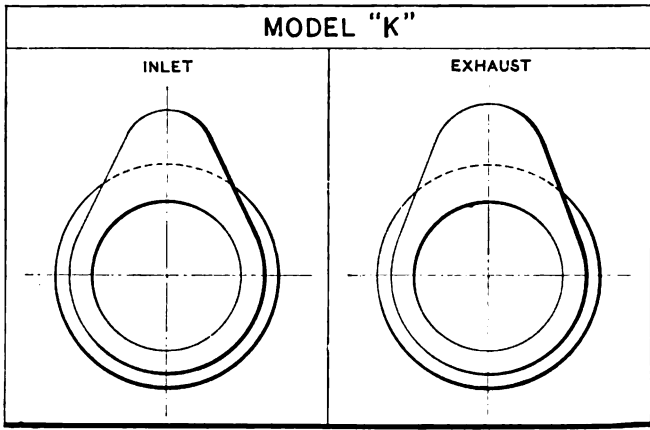

Fig. 46—Rounded cams on Model K Maxwell motor offering an easy action and aborting noise.

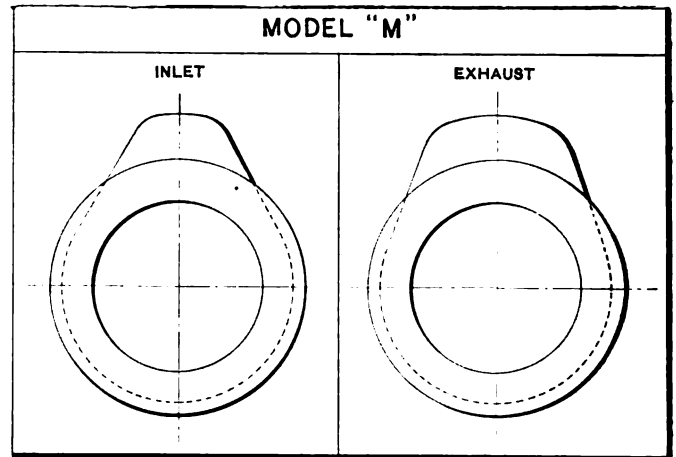

Fig. 47—Model M Maxwell showing cams that assure a long time opening and easy action.

of the Pierce exhaust manifold, as reported by the engineer in charge, were such as to encourage attempts of this character, and certainly it is at small cost, excepting as to skill, that matters of this nature can be incorporated into motors.

In some types of motors, notably in air-cooled work, the valves in the head are small, due to the manner in which they are placed, as depicted in Fig. 49, excepting that the illustration includes a way of keeping the valve springs cool, in that the springs are outside of the air jacket. That the valve springs have to be kept cool is a matter that proves out in the examples that do not include a means of cooling them. If the springs

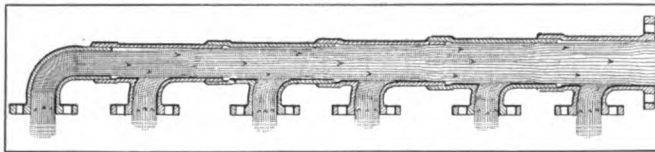

Fig. 48—Pierce exhaust manifold, designed to afford a vacuum, and an increase in power.

lay up against a heated wall, particularly if the wall is that which obtains in air-cooled work, it takes but a little while for the springs to become lazy. When the springs fail to work in a manner to assure quick closing, noise is made when the rollers fail to follow the contour of the cams, and what is more to the point, the timing is reduced to indifference. The design as depicted in Fig. 49 is defective, in that the valves are not in separate housings, although this is a matter that was mentioned earlier in this discussion.

As an example of very exact work, in which the question of the temperature of the springs is adequately cared for, Fig. 50 is offered, which represents a Pierce motor cross-section, and, among other details, a commodious roller hugs the cam, so that the life of the parts should be long, which is besides the point to be made here, i.e., once the motor is timed, if the "tuning up" operation is properly done, it will stay so for a long time. This has not always been so in motors in general, and it is a matter of very serious purport, for when a car is handed to a motorist

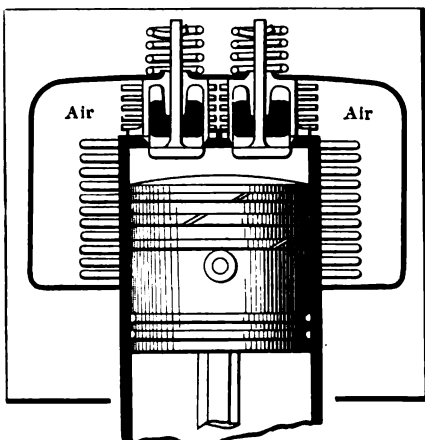

Fig. 49—Air-cooled motor with valves in the head and means for keeping the springs from over-heating.

it frequently happens that it is to one that has never before "tried his luck."

If the timing will not stay adjusted, and it will not unless the parts are properly made, the poor motorist will soon have to place himself and his car at the tender mercy of a garage keeper, who, in all truth, can do no more to remedy this defect than the owner of the car; the garage man can bill his time, nevertheless. Fig. 50 is also noteworthy in that it shows exact means for adjusting the valve-lift; moreover, the work can be done with ease by a man of no great skill, for the very simple reason that an adjustment is provided. In this case the adjustment consists of a special shaped cap-screw, threaded to screw into the lift, and a lock-nut is available to secure the cap-screw once the adjustment is properly made. In the head of the cap-screw, just where

the stem of the valve contacts, a cushion is provided, the function of which is to prevent noise, which is so noticeable in the class of motors that make no provision to dampen the tapping sound. In this case the cushion is imbedded into the head in such a way that it cannot flatten, nor is the material prone to crumble. This is a point well worth taking into account.

The lift is of good proportions, with ample bearing surfaces, and the guide is of suitable bearing bronze, so that the life of the parts, which is really measured by the noise that will ultimately have to be taken into account, is nil, in this case, due to the manner of design, use of suitable materials and provision against eccentric pressures and harmonious relations of the parts.

(To be continued.)

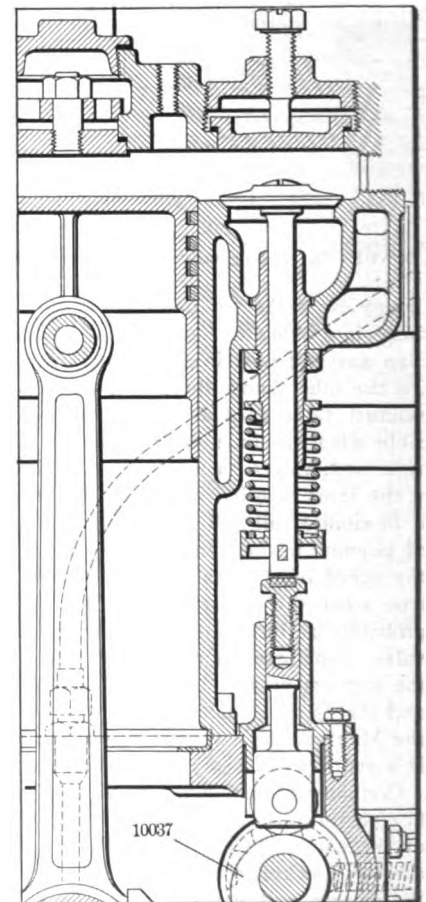

Fig. 50—Pierce valve-motion, showing manner of adjusting the timing and noise-preventing cushion.

ELECTRIC LIGHTING for AUTOMOBILES

BY MORRIS A. HALL.

It will be welcome news to many that much good work is being done along the line of substituting electricity for the present sources of light. This will be particularly attractive for use with headlights or searchlights where superior strength is more necessary, although it is possible that the present side and tail lamps may not undergo any alteration in this respect even with available electricity. This offers many advantages, such as cleanliness, convenience, superior light with its accompaniment, greater carrying capacity—that is, greater length of road illuminated. Providing that a proper source of current is provided there are no real disadvantages worthy of the name. The furnishing of this current up to date has been the insuper-

able obstacle to the use of this very desirable form of lighting and even now it is not an assured fact that the previously existing difficulties have been wholly overcome.

The Prime Sources of Current—The current supply is susceptible to treatment along two lines—that is, there are two possible



Typical Storage Lighting Battery

sources of current supply. These are the dynamo and the storage battery. The former is a rotary current generator and actually produces current, while the latter gives this out only by chemical action, in the course of which material is altered in its form after the complete alteration of which a reverse or building-up action is necessary before more current is produced. That is, the storage cell for electric lighting purposes is only a different form of the storage battery used for ignition and is subject to the same failing, the necessity for recharging.

For car lighting a high discharge rate is a necessity, this being much higher than the ordinary discharge rate necessary for ignition. The question of ultimate use must be considered in the construction of the battery because the rate of current drain influences the internal construction. That is, if the cell was constructed for a low discharge rate and then is used for lighting or some other purpose requiring much current the greater rapidity of action is not only liable, but certain, to warp the grids or plates composing the battery. This results in both mechanical and electrical losses which can only be stopped by replacing the warped plate with a new one.

With a battery specially constructed for large flow the size, shape and arrangement is such that it does not effect any harm. This sums up in the statement that the battery if of the storage or accumulator type must be especially constructed for electric lighting purposes. Such batteries are now upon the market and may be had at any supply store. As the illustration shows, the external appearance is no different than any other storage battery, all of the changes being internal and hence not visible.

Dynamo Also Must Be Specially Built—Like the storage cell, the ordinary dynamo or magneto is not available without a number of internal changes, which amount to practically the rebuilding of the whole machine. First, the biggest problem in this connection is not the construction nor the winding of the machine, but the lack of a satisfactory governor to regulate the speed. To mention briefly the requirements is to outline the difficulty without further mention. These are: The speed of the engine or any other rotating shaft in the car is constantly varying; the dynamo must be driven from one of these change-

able speed shafts and positively, yet its own speed must be very constant; in fact, in the best electric light work the maximum permissible variation is but 2 per cent.

From this one may get an excellent idea of the difficulty, yet there have been many serious attempts at it and one of the latest looks very good. One way ordinarily used is the centrifugal governor, which at best is a rough means, while the problem would seem to demand a very delicate treatment. In an English machine, the Leitner, electrical methods have been substituted for mechanical means with this object in view, namely, the attainment of a continuous output at a constant pressure.

The dynamo shown in one of the small cuts is of the bi-polar shunt-wound enclosed type. The enclosing case shuts out the dust, keeps in the lubricating oil and is the acme of simplicity. The armature is mounted upon ball bearings to reduce the friction of rotation to as near zero as possible. In addition to the usual brushes another auxiliary pair are fitted which fulfill the function of regulating the pressure of the outgoing current regardless of the speed at which the generator is driven. They are set slightly in advance of the neutral axis and are connected in series between the ordinary shunt coils of the field magnets.

Auxiliary Brushes Add to the Current at Medium Speeds—At slow speeds and while the dynamo is being speeded up these brushes are picking up a small amount of current, which goes to assist the normal shunt current in the magnetization of the poles. As the speed continues to increase and approach a predetermined maximum, the magnetic field becomes more and more distorted until at the maximum point the original lead of auxiliary brushes is neutralized and the neutral zone has advanced and overtaken them. At this point the auxiliary brushes have no effect, and when the speed is further increased the distortion increases with it and current drawn from the armature by these brushes acts as a back EMF or in opposition to the normal shunt current. Throughout this whole range of change of speed only a change of potential takes place in the exciting current.

By so selecting the angle of advance of the auxiliary brushes any desired speed range may be obtained and the output of the machine controlled within these limits by the progressive assistance and neutralization of the excitation. So well have these angles been worked out that in actual tests it has been impossible to detect any variation in the main current using a voltmeter. Two pictures of the dynamo complete and of the rotating armature, with the field magnets in place just as the armature was withdrawn from them, are shown.

The action of the machine, which is the basis of a whole new lighting system, is to change the electrical conditions and thus,

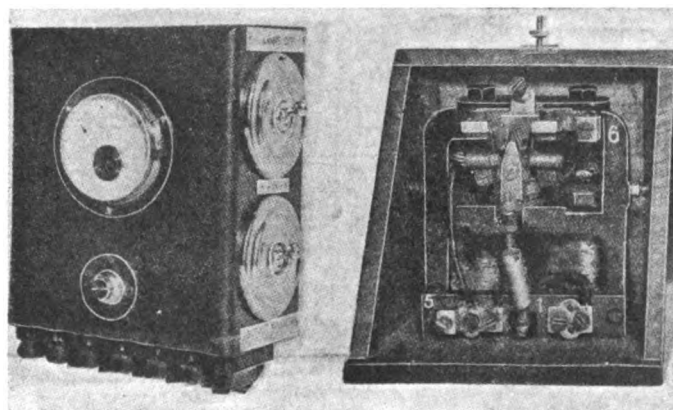

Switchboard and Automatic Cut-Out In Two Views

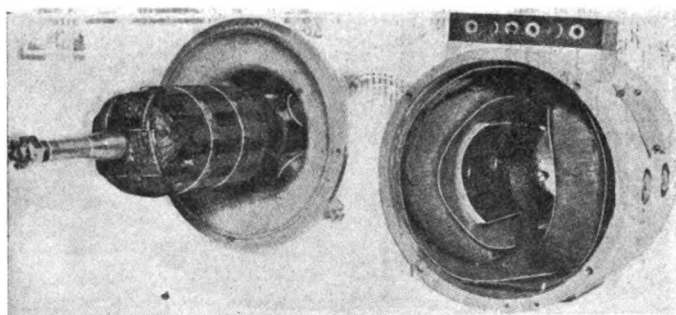

Armature and Magnet Case of the Leitner Dynamo

rather than by varying the speed alone, govern the electrical output within well-defined limits.

Automatic Switch Plays an Important Part—This newer system also includes an automatic cut-out switch, the function of which is to act as a non-return valve to the battery. The latter are fitted as an intermediary between the dynamo and the lights, the former being used to charge the battery, which in turn is used as the immediate source of current. When the generator is in use charging the cells the current flows through this switch in a normal manner, but as soon as there is a flow in the opposite direction—that is, from the battery to the generator, the switch is automatically pulled out owing to the reversal of the two poles of one of the magnets. Similarly the switch is automatically pulled in when the current from the generator becomes large enough to charge the battery.

In either case the action of the switch is electrically positive and it is magnetically held in the position into which the electric action forces it. This continues until the conditions again change and is not affected by vibrations, consequently its efficiency is not affected.

When the batteries are not furnishing current for lighting a two-way switch is made to insert a resistance in the field coils so that the output is reduced to a very small quantity.

Ignition Also Possible with This System—If desired, a coil may be fitted, and with the batteries as a source of current, the lighting system may easily be used for ignition of the engine. If this method of igniting the motor is adopted, it is advisable to fit another set of batteries for ignition purposes, and kept the set of lighting batteries intact for that purpose alone. This is advisable because of the different current drain on the batteries in the two cases necessitating a different form.

One of the most convincing proofs of a system like this, however well it may seem in theory, is an actual installation, and the subsequent results derived therefrom. As stated before, this is an English outfit, and the installations which are available are also English. The London General Omnibus Company has conducted a long series of experiments with it, and finding no

faults as a result of these tests, has approved it for public use in passenger-carrying vehicles. Another London bus company has gone even farther than this in its appreciation of the real merit in the system. The Metropolitan Steam Omnibus Company tried it on a few cars and after these had traveled a distance in excess of half a million miles without untoward happenings and with no undesirable developments, all of the other cars belonging to this company were similarly equipped.

Considering the supply of current from a magneto on an automobile the point of difference between lighting and igniting conditions are three in number—variable speed, enormous voltage necessary to jump the air-gap and timing arrangements for producing the jump at the desired point in the engine cycle.

Granting the elimination of the first, the other two may readily be removed so that all that is necessary for the use of an ignition magneto for lighting purposes really is constant speed. In a motor boat, for instance, this condition obtains and frequently owners of motor boats cut in back of their coil (which produces the enormous voltage) and timer (which gives the spark at the right time) for current to operate a small lamp. Thus, the ordinary magneto might be depended upon to deliver 50 watts. Now small electric light bulbs of, say, 4 candlepower, would require about 4 1-2 watts per candlepower or 18 total. Then two of these could be used and still leave a large margin of current for ignition purposes. Thus if a system were used

consisting of a storage battery and dynamo, with the latter furnishing the ignition current direct and charging the storage battery with the surplus, this system would readily adapt itself to lighting work in addition. Suppose the dynamo furnished 5 amperes and the ignition consumed but 2 amperes of this. The extra 3 amperes of current could be used to charge the storage cell, which in turn could be utilized for ignition. With the use of 6-volt, 6-candlepower lamps, the current accumulated in ten hours would operate six lamps for five hours, or if more light is required, it would operate twelve lamps for two and a half hours.

Economical Lamp Bulbs Are a Necessity—An inspection of the above shows that the current is very carefully distributed and conserved, so as to minimize the losses. With this in view it is apparent that any device that will economize on current still further is a desideratum. Many of these have existed in theory only, but to-day there is a prominent current saver which is rapidly becoming known and popular.

This includes the newer filament lamps all with filaments other than carbon. It has been ascertained by careful and painstaking experiments that these different filaments actually save current, furnishing the same amount of light with a smaller expenditure of electrical energy. In an automobile lighting system this is one of the biggest points to consider, therefore they are very well fitted to be used for this purpose, particularly now that they are constructed so as to be strong and rugged.

Particular reference is had to the tungsten lamps, which not only will give an equal amount of light with 60 per cent of the current expended in the case of carbon lamps, but in addition maintain this factor of economy for a longer time. The latter feature is as valuable as is the former, for a lamp which saved an equal amount of current, but had a very short life, would be a poor saving. In this contingency the extra cost of lamps and trouble of renewing would overbalance the saving in current.

As now made these tungsten lamps take on various forms, the filaments in particular assuming peculiar and fantastic shapes. Two of these are shown to illustrate this point, one having a number of coils or loops, while the other is made with a series of straight webs connecting an upper and lower ring.

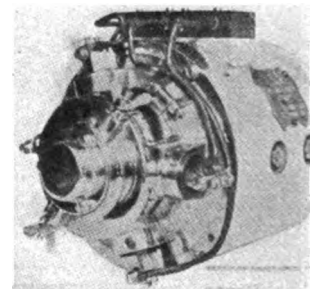

Dynamo Shows Four Brushes

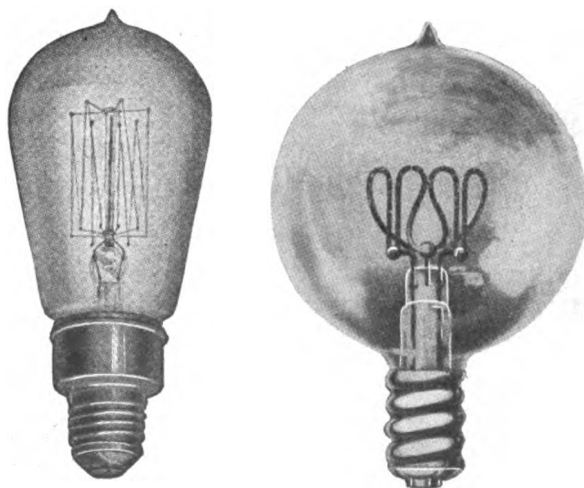

Two Ordinary Forms of Tungsten Light Bulbs

Aids in the Art of Driving of a Car -

Part 3.

By D. R. Hobart

BREAKAGES of wheels and springs are in a large measure due to the fact that comparatively few autoists know how to properly make turns. In many instances breakages are directly traceable to cutting corners too sharply, either through a desire to save time or because of miscalculation on the part of the driver. Should a collision be the final result of the careless negotiation of a corner or turn, it is often the direct result of

but for automobiles in general. There are numbers of drivers that habitually shave corners, who start to make the turn before reaching the proper point and cut diagonally across the road, obstructing traffic coming in the opposite direction, and hugging the left hand corner of the intersecting road. Their desire is evidently to travel from one point to another in the shortest possible space of time, and to save distance cut the corners without regard to the rights or safety of others. The majority of automobile drivers of this class luckily confine their operations to city streets, although they are found in some numbers on country roads. On the other hand a large majority of horse drivers are corner shavers, women being particularly given to the practice. Because of the presence of this and the reckless classes of drivers, special caution has to be exercised at all times by those in charge of vehicles of every kind.

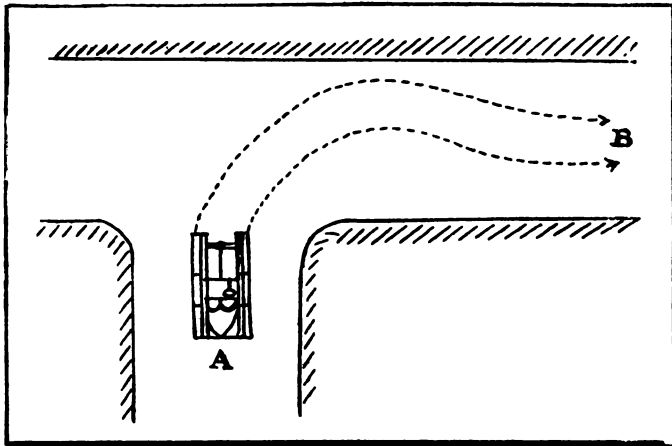

Proper Method of Making a Turn to the Right

ignorance of the proper amount of space that should be allowed for maneuvering the car, or what is even worse, utter indifference to anything that may happen to the car or to other users of the road. The negotiation of turns is a simple matter as far as the steering of the car is concerned, but experience is essential to the proper procedure under unusual circumstances, as when the road is partially obstructed by excavations, vehicles, etc. No rules can be laid down to cover all cases, but there are a number of things which should be borne in mind at all times with regard to turns.

On Approaching a Road Fork—On approaching a point where the road forks or branches off, the autoist should hold well over to the proper side of the road in order to avoid cars coming along the branches. Should he be traveling along one of the branches toward the fork, however, he should keep in the center, as when approaching an ordinary turn. On overtaking another car, it would be better to allow the latter to proceed on its course without attempting to pass, unless the driver signals the direction he is about to take. The reason for this can be readily seen by referring to the sketch where car B is about to overtake car A. If B attempts to pass A by taking the path *y*, a collision will occur if car A turns down the left fork at *a*. On the other hand, if the path *x* on the wrong side is taken, a collision will occur at *b* if the leading car takes the right fork. Hence the driver of B should allow A to take its course before proceeding on his own. If the driver of car A should signal the fork he is going to take, B can pass on the proper side if the same fork is to be taken by both, and on the wrong side if

Negotiating Turns—The procedure on approaching a turn is exactly similar to that on approaching a road crossing. The car should keep to the center of the road and its speed should be reduced somewhat until the road is seen to be clear when the turn can be made. In taking a right hand turn, the autoist should keep well away from the corner, describing as large an arc as possible and gradually gaining the center of the other road. Such maneuver is shown in the sketch, where the car A follows the dotted course until the point B is reached. By so doing a collision with another car coming in the opposite direction will be avoided as either car can swing clear. In taking a turn to the left a similar maneuver should be made, but in this case the car should keep close to the proper side, as in the sketch of the left turn. The size of the arc described in making the turn will, of course, depend on the width of the road and the length of the car, small runabouts being able to turn in an arc of 25 feet or less, while large touring cars should describe arcs of 32 feet and over on an ordinary road.

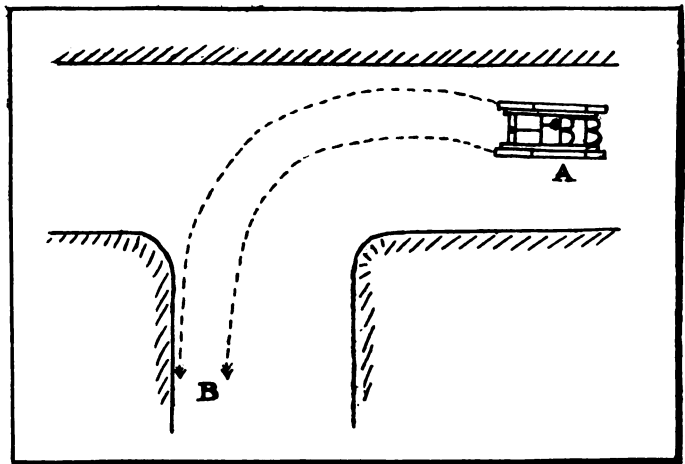

Course to Be Followed on Turning to Left

Corner Shaving to Be Avoided—Except when absolutely necessary to avoid a collision corners should never be cut closely or "shaved" as it is often called. By shaving a corner the autoist runs chances of colliding with other vehicles, and engenders a dislike in all other users of the road not only for himself

A is to take the left fork and B the right. If A is to take the right and B the left fork, B will pass in the ordinary manner.

Car Lines an Element of Danger to Autoists—Whether running in city or country, the autoist should be extremely careful regarding car—or as they are often called trolley—lines. Undoubtedly no other form of transportation on public roads con-

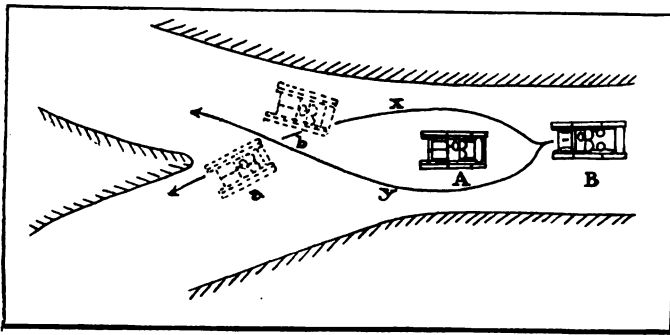

Passing a Car at a Fork of the Road

stitutes such a great source of danger to all other forms, particularly as localities in which the lines are located are those where traffic is above the average in volume. It is rare indeed that a trolley line is built on its own right of way; it usually occupies a good half of the common road and the autoist will frequently encounter the rails emerging from what seems to be a dense undergrowth or appearing suddenly from an adjoining road, its presence being only indicated beforehand by the overhead wire and its means of suspension. As a rule the line is laid on one side of the road, but there appears to be no generally recognized plan as regards location, and the autoist must keep a sharp lookout not only for surprising changes in location of the line but also for the cars themselves.

Track Should Be Carefully Watched—Regarding the track itself strict watch should be kept for rails which are elevated above the level of the road, for switch tongues and for differences in level between the bed of the line or track and the surface of the road. Any of the above may interfere with the steering of the automobile if the wheels come in contact with them, and if the road is at all greasy, side slips are likely to occur. The rails are a source of trouble when slippery and care should be taken that the tires do not get into the rail channels, as they will be badly wrenched or even torn off when a change of direction is desired. One of the commonest mistakes made is in running the car with all four tires in the channels, which undoubtedly makes smooth riding but which also renders it difficult for the autoist to steer out of them again when he wishes to do so by any movement of the steering gear. When the rails are dry, only a short time will elapse before the tire will ride over the rail-head and get clear, but with wet rails sometimes hundreds of feet are traversed before the tires are clear. Such a situation would not be rendered pleasanter if a car was seen approaching at speed along the track. Even when one tire enters a rail channel it is not easy to get it clear, especially if the tire is smooth or of small profile. The autoist should therefore keep clear of slippery rails and when crossing them do so at as great an angle as possible, dodging projecting track work and being ready to correct any action due to the catching or sliding of the tires. When there is no great difference in level between the bed of the line and the road surface the car may be driven with the right hand wheels between the rails and the left hand wheels clear, as shown in the sketch, so that the car may be swung clear if a trolley car be overtaken or if slow moving vehicles are to be passed. This method of running finds frequent employment on "trolley ridden" roads of narrow width and there is a good deal to be said in its favor.

Negotiating Trolley Cars—Owing to the fact that the trolley car runs over a fixed route and therefore cannot turn aside to avert a collision or follow a course best suited to the circumstances, the autoist must treat it as a distinctive sort of vehicle which has to be negotiated in a different manner from others. First he should remember that if there is sufficient space to pass the car there will continue to be sufficient space, but if there is not then something will get smashed. The redeeming feature lies in the fact that the rails and switches are distinct guides as to what course a trolley car will take. With other

vehicles, the intentions of the driver can be ascertained by observing the direction he is taking, the speed at which he is traveling and his position with regard to others on the road, but with the trolley car the course being taken at the moment indicates nothing and the track ahead is that which should be watched. Particular care should be taken where the tracks change from one side of the road to the other, and cars usually take such portions of the track at the same speed as when on a straightaway, regardless of other vehicles on the road. As a rule trolley cars should be overtaken and passed, as explained in Part 2, where the track ahead is straight or where it is only on one side of the road. The autoist should never attempt to pass a trolley car when a curve, turnout or crossing is in sight, but follow it at the same speed that it is traveling until the way is clear on either side.* Passing should be done on the proper side except where the car is on the wrong side of the road, when the autoist should pass carefully on the wrong side, keeping well over to the right hand side of the road in so doing.

Crossing Railroad Tracks—All railroad tracks should be treated as if trains were likely to be due at the crossing at any moment and the car should be driven across at the greatest angle and at the best speed possible. A sharp lookout should be kept in both directions and the car slowed down on approaching the crossing, taking absolutely no chances whatsoever. In case a collision is imminent, the steering wheels should be turned sharply in the direction in which the train is moving so that the car will be struck a glancing blow and the occupants will have some chance of escape.

Experience Necessary in Evading Side Slips and Skids—Nothing but actual experience can teach the autoist how to evade the ever-present bogey of side slip when the roads are in a slippery state. He may be forewarned of the various kinds of side slips and skids and the proper procedure under the circumstances, but he must actually experience each kind in order to distinguish one from the other and to acquire the instinct necessary to counterbalance every tendency in that direction immediately the first symptoms are perceptible. There are certain kinds of surface on which the tires cannot obtain a firm grip, places in which sideways strains are brought to bear on the car, and acts on the part of the driver which either reduce or increase the adherence between the tires and the road. These three things are unconsciously or consciously learned by every autoist of any road experience and those not familiar with them will do well to find out all that is possible concerning these points before venturing on slippery roads.

Skidding to Be Distinguished from Side Slip—Although both the terms skidding and side slipping are used freely as regards automobiling, their meanings are often confused and the former is used to designate both. Skidding implies a continued forward movement of the car or vehicle after the wheels have been retarded or locked by the brakes; while side slipping relates only to a lateral motion of the car due to the wheels sliding bodily sideways. Practically, the distinction between the two is not so sharply drawn, as skidding is of comparatively rare occurrence and usually develops into side slip automatically.

To the inexperienced autoist, side slips which should be skids in his opinion, are apt to prove very disconcerting.

(To be concluded.)

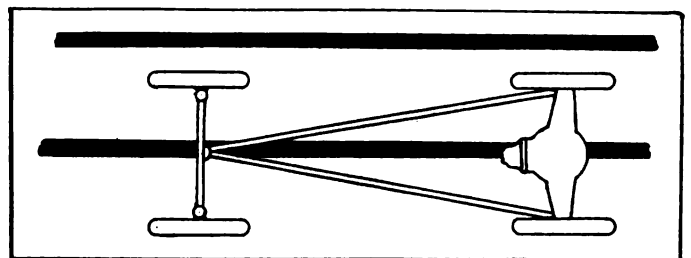

When Running Lengthwise of Street Car Tracks

Letters Interesting and Instructive

THE SUBJECT OF WEIGHTS

Editor THE AUTOMOBILE:

[1,897]—Being a subscriber to "The Automobile," I would like to have you inform me of the weight of front and rear wheels, including tires on machines carrying from four to seven passengers. That is, I wish to obtain the weight on the ordinary car as well as on the heavy touring car. Is there a list of such weights and cars?

Boston, Mass. HENRY HASTINGS.

It is hard to decide whether you mean weight of wheels or weight on wheels. In case it is the latter, you will find in the May 20 issue of THE AUTOMOBILE, page 810, the tabular weights of the cars in the one-gallon test. These represent accurately the weights of both cars and passengers in ordinary touring conditions, and you will find therein cars of all classes from the fast six-cylinder runabout with three passengers to the larger four and six-cylinder touring cars with a full complement of five or seven people.

To get more exactly the weight distribution on the front and rear wheels, it will be necessary to give you the information from cars with which we are familiar as there is no available data on this subject. Thus the Apperson car, with a four-passenger body, weighs exactly 3,100 pounds, of which 1,493 are carried on the front wheels, and 1,607 on the rear wheels, making the car 114 pounds out of an exact balance. The Simplex 30 is only 56 pounds out of balance, as the total weight of 2,914 pounds, with a tonneau, is divided 1,429 to the front wheels and 1,485 to the rear wheels. These are the only cars of which this data is immediately available.

In case you mean weight of the wheels themselves, this also is a subject on which exact data is not available, but for very general purposes you would be safe in figuring it at from 30 to 75 pounds per wheel, including tire. The former figure will be safe as the lower limit for small light wheels with corresponding tires, such as ten-spoke wheels with 28 by 3 tires. The other figures will answer for the heaviest practice, such as fourteen-spoke wheels with 36 by 5½ tires.

TROUBLE WITH AIR INTAKE

Editor THE AUTOMOBILE:

[1,898]—I have a carbureter on my runabout and the air intake is near the gasoline tank. On going up grades, the fuel runs out of the vent in the tank cap, down into the carbureter air intake. Could I put a strainer on it to take air from the side away from the tank, or would a flat strainer on top of the carbureter be better? Please advise me also where I can procure a brass strainer of the kind needed for this purpose.

Rosendale, N. Y.

The addition of fuel as you describe to the air at the air inlet will seriously disturb the running of the engine and probably give so rich a mixture as to choke the engine. It is advisable to remedy this at

once, and the best way to do this is to prolong the present air inlet upwards and outwards away from the gasoline tank which causes the trouble. To do this, have a sort of stove pipe made; it may be of galvanized iron, tin or any similar metal. Have this made long enough to take the top very near to the top of the offending tank, then a big, easy bend away from the latter. The opening or mouth of the pipe should be so formed as to take a screen, which is necessary to keep out the dust, and should preferably be made removable, so that when the screen clogs with dust it can be taken off, cleaned, and replaced. For this purpose use a very fine

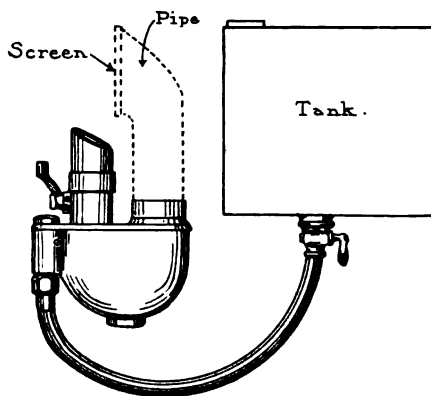

Sketch of New Air Intake

brass gauze, which you can obtain at any hardware store, and for a small cost.

In the appended sketch is shown a rough diagram as your case is understood and in dotted lines the suggested improvement.

SHORT VALVE STEMS

Editor THE AUTOMOBILE:

[1,899]—I have a Mercedes 18-22 horsepower car. The last time I had the engine overhauled some of the valves were ground in too much, which lets the exhaust valve stems come very close to the lifts when they are down. And the next time they are ground the valves will probably not seat. Is it the proper practice to file a little off the end of the valve stems? How will this affect the turning of the valves?

Rowlandville, Md. EDWARD CONNER.

The answer to your question is no, it is not proper practice to file off the ends of the valve stems. You are worrying over trouble which has not made its appearance yet, but when the next regrinding is done you will know for sure. If the case you describe comes true, take the valves to a shop noted for good work, have the temper drawn from the valve stem ends (they are usually hardened), and have about twice as much as is necessary turned off from the ends in a lathe. The extra amount is to allow for another grinding of the valves, or perhaps it would be better to have about an eighth of an inch

taken off, which will provide for a large number of regrindings.

Next, the end of the stem must be carefully hardened again, and this is no ordinary job, for when it is finished the end must be straight and square with the axis of the whole valve. If this is not true, the action of the push rod will tend to throw the valve off to one side (the side which is high) and make the work of grinding for nothing.

Providing that the clearance between the push rod and the end of the valve is kept the same, by means of the adjustment provided, it is hard to see how any alteration in the length will alter the timing of the valves. Before making the changes suggested it would be well to measure this clearance, carefully remembering that it usually is but a few thousandths of an inch.

It would also be well to measure the amount of possible adjustment provided, and shorten your valve by an amount less than this, for if you shortened more than the adjustment the clearance would be increased, and the whole timing thrown out.

ABILITY OF MAGNETO SPARK

Editor THE AUTOMOBILE:

[1,900]—Will you kindly advise me on the following points: I have a four-year-old car, which is now in need of an overhauling. The ignition is by means of two sets of dry cells, four each, working through a coil. The engine is of very high compression. Last year the dry cells required frequent renewals, and now I am considering the installation of a magneto. The question with me is, would it be possible to start on the magneto alone with such high compression? Also, I have just put on a new set of piston rings; can this be the cause of the engine overheating badly, whereas formerly it never did. The water circulation seems to be good, also the cylinder oil feed, yet it heats, therefore it has neither speed nor power.

Louisville, Ky. F. K. G.

The number of cells supplied with the car were evidently too few or they would not have required as you say "frequent renewals." If you care to try dry cells again, use either eight or twelve, connected up in series-multiple, as described in the March 4 issue of THE AUTOMOBILE, and enlarged upon in much detail in the issue of May 20, pages 817 and 818.

In case you do not want to try them again, the installation of a magneto will be a perfectly safe thing to do even in view of the high compression of which you speak, but of which you do not give the exact figure. The magneto, as now marketed, will give a spark strong enough to ignite any charge, no matter how much the compression is, at the ordinary speed of cranking. If this were not so, the racing machines, some of them with a compression of 110 pounds, which is undoubtedly much more than you have, would not be equipped with single ignition, and with a magneto as the source of power.

High compression has also something to do with the overheating of your engine, which is doubtless due to the new rings not being fitted to the cylinder. Until this condition obtains, it will continue to heat. You can, however, help matters along by flooding the cylinders with oil until the rings are well ground into place. Probably a good rule to follow would be to double your usual cylinder lubrication, that is, the number of drops per minute. If the engine was of lower compression, it would not heat so readily even with new rings, which were of a larger diameter than the old ones. In the meantime, that is, while the rings, copiously oiled, are running themselves in, let the engine run as hot as it will, up to the point of actually seizing.

TIMING AN OLD ENGINE

Editor THE AUTOMOBILE:

[1,901]—Will you please tell me how to time an old engine, that is, one which does not have the different points marked upon the flywheel for a guide? C. G. FISHER. Detroit, Mich.

On an engine old enough to date back to the period when the timing was not marked upon the surface of the flywheel take out the pet-cocks, or it will suffice to take out a single one. Then insert into that cylinder a scale or ruler, if the opening is large enough, and a piece of wire, if it happens that the hole is very small.

Turn the engine over very slowly by hand and carefully determine the upper and lower dead centers, as indicated on the rule or wire. These are indicated by the piston, and consequently, the rule, reaching the highest position and starting to go down again, in the case of the upper center, or reaching the bottom and starting up, in the case of the lower center. Mark these positions on the wire, or with the more convenient rule, note the exact point or dimension where they occur.

Now having determined the two dead centers, so that you can stop exactly at those points, you can proceed with the timing. First, it will be necessary to determine the timing which you wish to obtain, and this had better be the same as the makers of the engine intended or else you will have to have new cams made, which will be rather expensive.

Let us suppose that the cams are made to conform with the cycle which has been given in these columns several times lately, namely, inlet opens at 8 degrees past the upper center, closes at 26 past the lower center; exhaust opens at 46 before lower center, and closes at 5 past the upper. Now these angles mean little to you unless you are able to support the engine without the lower half of the crankcase, thus exposing the crankshaft, on which the angles should be measured. If you are not able to thus measure the angles directly upon the main shaft, you will have to transform them into inches of piston movement, which can be very readily measured.

To do this you must figure these points out, as you do not give the size of your en-

gine so that we could figure it out for you. In case you have a table of natural functions, this is an easy matter. Thus, let A be the length of the connecting rod, B the radius of the crank circle or half the stroke, a the angle included between the axis of the engine and the crank, which will be the angle given above at the upper center, and 180 minus the one given above for the lower center. Now then we wish from these three quantities to find the other side of a triangle formed by the crank, connecting rod, and the axis. Call this other side C. Then the first formula to use is:

$$\sin b = \frac{B \sin a}{A}$$

From this, the second angle is found by substituting for a the four angles given, remembering that for the two cases of the lower center, the angle to be used is 180 minus those given.

Now having two angles and two sides the third side is obtained using:

$$C = A \cos b + B \cos a.$$

Add the length B, and the connecting rod length A. From this total, subtract the quantity just found, or C.

The result will be the amount that the piston or the rule will be away from center, when the desired angle is reached. By measuring off these amounts on the measuring device, you have but to turn the crank over slowly until these points are reached, when the piston is in the right position for setting the cam.

To show you how easy the calculation goes, one of the distances will be worked out. Suppose a 5½ by 6 engine with a 12-inch connecting rod. Then A equals 12, and B is half of 6 or 3. Take the inlet opening, 8 degrees past center, for example. the sine of 8 degrees is .14, then in the first formula:

$$\sin b = \frac{3 \times .14}{12} = .035, \text{ then } B \text{ equals } 2 \text{ deg.}$$

Now in the second formula: C = 12 × .9994 + 3 × .9903, then C equals 14.963 inches.

Subtracting this from the radius plus the length of the rod or 15 inches, the distance obtained is .037 inch, the amount the piston will move down for an angle of 8 degrees past upper center.

WOOD FOR FRAMES

Editor THE AUTOMOBILE:

[1,902]—Will you please give me some idea of the form of construction used with wood side frames, that is, how is the wood used and put together for this purpose? Churchtown, N. J. D. DE V. WOOD.

One form of wood frame used in a popular make of car consists of three layers of selected second-growth white ash. These are so selected that the grain in each one runs in a different direction. They are sized and prepared for use, then glued together, after which they are screwed. In addition, a top and bottom piece with the grain running in a way to shed moisture are added for protection.

MORE AMPERE DIFFERENTIAL

Editor THE AUTOMOBILE:

[1,903]—Regarding the article on the Ampere car in a recent issue of your paper, will you please inform me through "Letters Interesting and Instructive" if I am right in my understanding that the rear wheels are thrown out of circuit, and thus disconnected, when the brakes are applied? New York City.

C. L. MOHR.

If you will look at the answer to R. C. Jordan in the issue of THE AUTOMOBILE for May 27 (1892), you will probably find a partial answer to your question; at least the subject of the differential action is there explained. As to the rest of your question the left foot pedal, corresponding to the clutch on an ordinary car, when pushed forward, as if to throw out the clutch, cuts off the current to the clutches in the transmission, which really take the place of the master clutch in the flywheel.

Similarly, with the right pedal operating the rear hub brakes, it is our understanding that this only applies the brakes as in the ordinary car, and has no other action upon the car or its action, nor is it interconnected with the clutch pedal, which does influence the current.

As the present understanding, it is not a fact that the current is disturbed in the rear hubs, except as brought out in the answer to Jordan, namely, when the steering gear is turned so as to turn the wheels at least 15 degrees out of a straight ahead line. That is, the answer to your question is no, the application of the brakes does not cut off the current to the rear wheels.

HARDENING COPPER

Editor THE AUTOMOBILE:

[1,904]—Is there any process by which pure copper in the form of tubing or sheets can be hardened or toughened so as to allow of its use in places where the softness would be objectionable? If there is any such process, will you kindly give me the details of it. Belleville, Kansas.

C. G. DAY.

There is no known process which can be used on the metal as turned out from the mills, without altering its condition. If you have facilities for melting and repouring into the desired shape, the following receipt will be of service to you:

For every 40 pounds of copper to be hardened, take 2 pounds of alum and 8 ounces of arsenic. Mix the alum and arsenic together, and after melting the copper in a crucible, add the mixture slowly, stirring the whole thoroughly. After the molten mixture has been stirred for at least five minutes, it is ready to pour.

Copper treated in this way may be melted and remelted many times without injury or noticeable change in the composition. In addition, it may be rolled or drawn any number of times without injury. The alum and arsenic impart great density, toughness and hardness to the otherwise soft metal.

With a proof of the everyday use of this process by the average owner of an automobile, the mechanical world as a whole will be much the gainer. Copper is a valuable metal and its price restricts its use to certain parts, but softness has restricted it even more than price.



Automobile Roads in NORTH ITALY

By FRANCIS MILTOUN

THE three most commonly used mountain gateways into Italy are those over the Simplon, by Domodossola from Switzerland; over the Saint Bernard, by Aosta from Switzerland; or over Mont Genève or Mont Cenis, from France, via Susa. The most splendidly scenic of all is that over the Simplon.

The sudden apparition of Italy as one crosses the Alps by the Simplon Pass and descends upon Domodossola has been remarked before, but the many who now make the journey by road for the first time are bound to (hundreds to-day do it by automobile where scores did it by carriage in the days gone by) appreciate the same emotions as did travelers of old. Nothing is changed in general aspect, and the magic of the transformation from the forest-grown or glacier-peopled mountain sides of Switzerland to the sweet, smiling plains of Italy is a thing not to be justly described by any pen or adequately painted by any brush. No, nor can the kodakist, even, catch the mood; he indeed comes off worst of all. It is a thing to experience by one's senses. The emotions are purely personal ones, as those who have been here can attest.

Let rushing tourists who do the thing in four hours take to heart the experiences of Dom Bourdin, the Benedictine monk of the sixteenth century, who took three days to make the crossing. Frontier and passport regulations are lenient now, but the old monk in his day was held in durance vile for three rounds of the clock by the Spanish governor, who held the pass because the good man would not admit that his native land, the Franche-Comté, might not some day become Spanish. He said simply: "God puts crowns where he pleases; it is not for me to say who shall rule my land." This was a philosophical answer, and he held to it for three days, when the bombast official seeing finally that the brother would not give in passed him over. Verily, it would be folly to sigh for "the good old days."

From Turin the shortest and quickest way into France is via the dull, ancient town of Susa and the Col du Mont Genève, descending on Briançon; or by Mont Cenis, coming down to low level at Modane. There is not much to choose between them except that the last-named pass is apt to be closed by snow and ice as late as the first of June, whereas that by Mont Genève is usually kept open through the winter.

One leaves Turin and its gracious streets and boulevards by the gently rising Strada di Francia, thirty odd



kilometers, to Susa, the ancient Segesium of the Roman empire. We anticipated nothing difficult in making our way out of Italy on this occasion, the last week in May, and we rolled along comfortably enough and with an easy mind and conscience over the best roads we had found in Italy. We expected to stay the night at Susa and free the Mont Cenis in the morning. We stayed the night at the exceedingly primitive Albergo del Sola at Susa, but learned that the snows of winter were still lingering a meter deep *en haut*, so other plans were to be made. It was a case of crossing by Mont Genève, with its less beautifully graded road (some hills, in fact, grading 17 per cent.). We recalled the fact that Dante the wayfarer crossed over into France by this road centuries ago, and surely a modern automobile could make easy work of it. The traveler by automobile, too, may well repeat Dante's words: "*Come di nive in Alpe senza vento.*"

The road over the Col du Mont Cenis, 28 kilometers above Susa, has been used since time immemorial, though the present carriage road over which automobilists crawl up or down (over the magnificent "Scala") has existed only since 1812. Its elevation, of 2,080 meters, is the lowest of any of the Alpine passes into Italy, save that of its neighbor over Mont Genève, which is slightly less, but equally productive of superb scenery.

We had intended entering France via Modane and returning north via Grenoble, but, owing to the dilatoriness of the season, we were forced to make a 300-kilometer detour through Briançon, Embrun and Gap, for even the Col du Lautret in France was still snowbound, and snow means impassability here.

On leaving Susa via Mont Genève one meets the stiffest five kilometers on the itinerary immediately on leaving the town.

For some inexplicable reason, unless it was the direct capriciousness of Beelzebub, we could do literally nothing on this five kilometers just outside of Susa, and spent a day and another night finding out that nothing was the matter; that the piston had not gripped or a bearing fired; and that it was simply a good-sized pebble that had got wedged in between the flywheel and the engine casing, preventing the motor from "spinning" or even turning over on itself. It was one of those things that ought not to have delayed us for a moment, of course, so simple

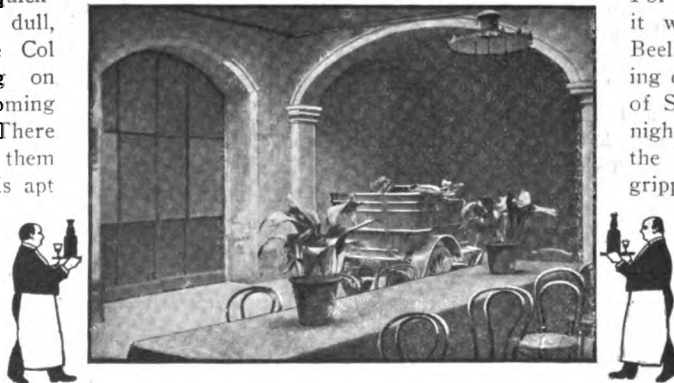

The Salle à Manger Garage at Novara

it was to solve. But it did, all the same. Have you, dear reader, and accomplished motorist, ever met exactly the same thing? No; nor the writer, either; not before this occasion, and we were accordingly puzzled. Sometimes we are not so auto-wise as we think we are, or, at least, would like to believe.

Finally, at daybreak on the second morning, we set out to cover the 55 kilometers between Susa in Italy and Briançon in France. Take it on the whole it was a hard rise all the way along, though it leveled down to between 6 and 8 per cent. after Oulx. A ruined fortress, La Brunetta, once the key to the whole valley, sits high above Susa, and is still something more than a memory. With Exilles and Fenestrelles it formed the fortified frontier between Piedmont and France. Hannibal is supposed to have crossed the Alps via this road and to have urged his jaded men to climb the Monte di Roccia, 3,000 meters above Susa, that they might be encouraged by the sight of the rich Lombard plains stretching out before them.

The Mont Genève road was built when Cottius submitted to Augustus. Beyond Susa it branches to the left, whilst that

best we had eaten in all Italy, and was priced accordingly. No garage accommodations were forthcoming, though the proprietor claimed to having room for a dozen automobiles. Well, he had—in the dining-room; that was where we put ours, and it wasn't a bad garage, either, as one may judge from the accompanying illustration. Novarra looks more like a French town than it does an Italian one, though a *salle à manger* garage is distinctly Italian, if it is anything.

Going out from Turin we fell in with a party of scouting motorcyclist soldiers of King Victor Emanuel, something of a novelty to an American who knows only the New York bicycle cop. The Italian army, like many other Italian institutions, is very modern. A series of recent maneuvers in the high Alpine valleys developed this entirely new type of soldier. Certainly the speed and economy with which the motorcycle can transport its bearer over roads entirely unsuitable for four-wheeled traffic makes its future assured for this class of soldiering. The horse is nowhere fit for this class of work. Imagine a powerful motorcycle carrying its rider up 15 per cent. mountain roads thick with

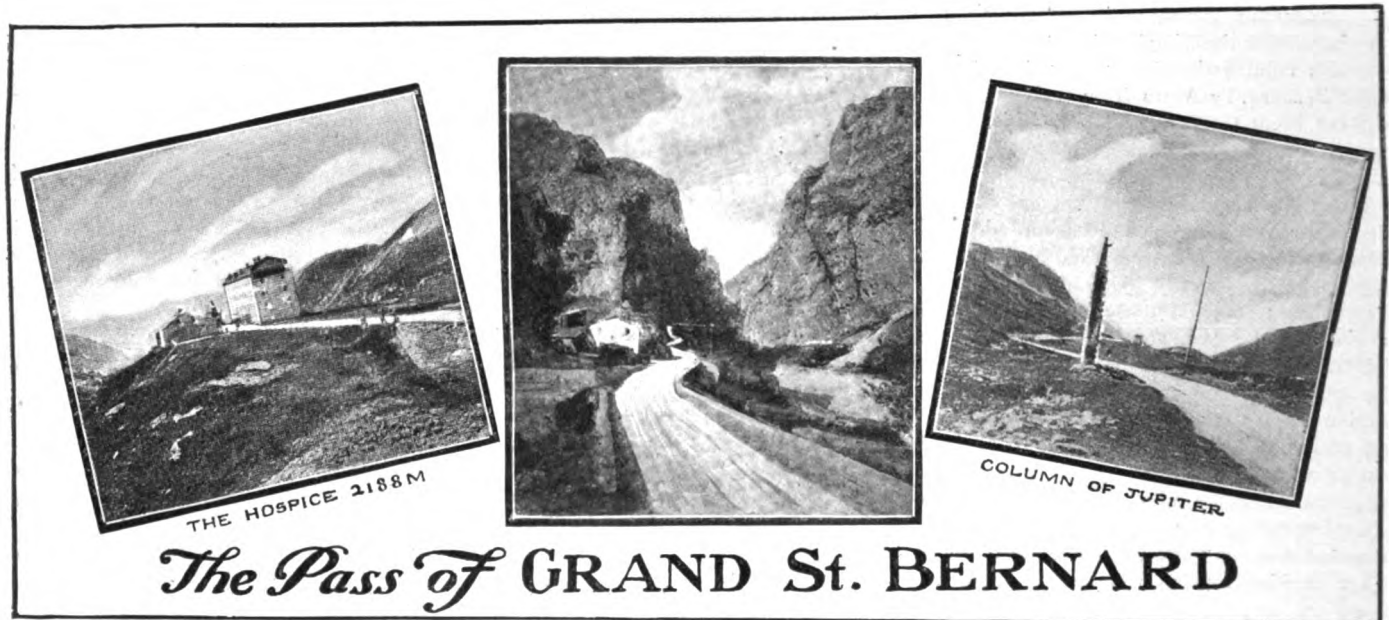

The Pass of GRAND St. BERNARD

over Mont Cenis leads to the right. That over Mont Genève was the most frequented of all Roman roads between Italy and Cisalpine Gaul. The military road of Pompey and Cæsar passed through Oulx and over the Col de Sestrières.

Via Mont Cenis the Italian *dogana* for fixing up one's papers is at Bard and the French *douane* at Lans-le-Bourg.

Via Mont Genève, Clavières and La Vachette, ten kilometers apart, perform the same functions, one on the Italian slope and the other in France, the actual crossing of the frontier being at an elevation of 1,860 meters.

From Milan westward the best sortie on France is via the Val d'Aoste and the petit Saint Bernard, say, 200 kilometers to Aosta, where the road divides, one section leading to Switzerland over the Grand Saint Bernard and the other via its little namesake into France via Moutiers and Albertville.

We had done this thing in times past, but on the present occasion it was too early in the season and it was for that reason we had turned to Turin.

Milan is monumental from every point of view, from its cathedral to its restaurants, hotels and garages, and its streets, though mostly paved with great granite blocks, are a delight to ride over by reasons of the flat flags set down in the middle. They can only be compared to the famous "iron roads" of certain sections of New Jersey a few generations ago, which, if they still exist, must be a dream to the modern automobilist.

At Novarra we put for the night at the French-named Hôtel de la Ville. It was not bad at all, but dear; the dinner was the

dust and stony at that. Where the average horse can find a foothold so, too, can a motorcycle find a wheel track, and it does not lie down on the job through fatigue as does the quadruped. It may be hid in a thicket or behind a boulder and its soldier scout may climb some neighboring vantage point and scan the horizon for miles without fear that his steed will neigh, whinney or bolt. *Avanti!* has ever been the watchword of the Italian army, and it is a good one. Another entry from North Italy into France, though by no means a usual one, though we found it most interesting on a certain occasion, and, in fact, the only one to be considered for a moment if time and distance are to be taken note of in going from the Riviera to the Italian lakes is that via Cuneo and the Col de Tende.

This itinerary surveys the road from Turin to the Mediterranean, but there are no radical changes in making it in the opposite direction save in the reversed order of things.

Twenty kilometers from Turin is Carignano, with a storied past and famous for the beauty of its places of worship and its women. The church of Santa Maria della Grazie was the annex of a monastery of Franciscan friars, and was endowed by the Duchess Bianca, the wife of Charles I., whose monument it contains. She was one of the first of Carignano's ladies of surpassing beauty, and for that and her "*gentilezza*" the Chevalier Bayard, who had been brought up in the household of the duke, did his best to win a tournament which was being held in her honor on a certain occasion. He did win; that goes without saying of so chevaleresque a man.

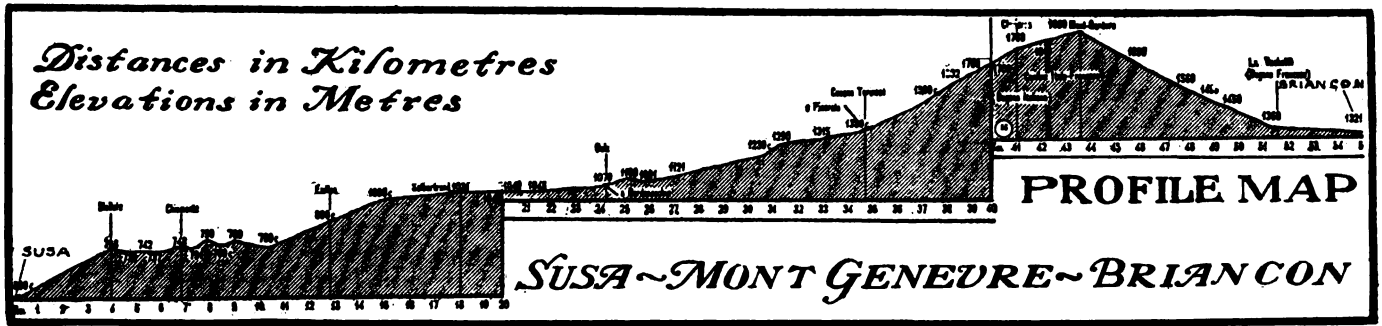

Ten kilometers to the right beyond Carignano is Carmagnola. The women of Carmagnola possess a specious grace and beauty like those of Carignano which have gone down into history. A ravishing dancer of Paris in the days of the Citizen King was a lady known as "Carmagnola," and her specialty, besides breaking beaux hearts, was the dancing of the "carmagnole," which had its origin here, although the Marseillais think it is theirs. By what right they assume this it is hard to reason out, though the Savoyards, who made up a part of the famous "Marseilles Battalion" which marched on Paris to help capture the king's castle in revolutionary days, may have come from here. The female youth and beauty of Carmagnola dresses itself up with gay headdresses and strings of glass beads on the least provocation, and dances the carmagnole with a fervor only equaled by the Spanish senorita when she works hard at reeling off that barbaric series of convulsions which go with a pair of castanets and a loosely girt waistline. The two may, indeed, be related.

Still on towards the French frontier, ten kilometers more, and another beauty show is offered one at Raconigni. Maybe all the women of these parts are beautiful, the writer had perhaps best say so and be done with it. Here, at any rate, they are different from the ladies of the glass beads and the fierce contortions at Carmagnola, only a few minutes away. Besides its beautiful women Raconigni has a remarkable country castle or palace built by Palagi, "one of the most comfortable of the country houses of Piedmont," said a traveler of two centuries ago who had been invited thither.

Two castles and a fortification wall once surrounded Cavaller Maggiore, another dozen of kilometers farther on, but nothing but a badly paved street, some indifferent stone houses with overhanging eaves of tile or brick, and two grim half-tumbled walls will recall the pompously named little town to the automobilist once he has passed through. It is the dullest, dearest town of five thousand inhabitants in all Italy.

Savigliano is printed in slightly larger letters on the maps, and is honored by being noted down as a railway junction. Formerly fortified, it has no monuments of interest to-day save a great triumphal arch erected in honor of the marriage of Victor Amadeo and Christine of France.

Thirteen kilometers to the right is Saluzzo, the capital of the Marquises, who played the game of war in northern Italy so successfully in the fifteenth century that they very nearly became lords of all the region. Saluzzo was the birthplace of Pellico,

the author of "Francesco da Rimini," who got ten years' imprisonment as a result of too great a display of his patriotism by means of his talent. He is not a prophet without honor.

Cuneo to-day, in Italian, or Coni, in French, is a live, bustling place of 30,000 souls, who live by most of the industries which occupy the modern hand and mind. In the old days it was different. Cuneo originally was a place of refuge when Boniface, Marquis of Savoy, sought to oppress the people and made the other neighboring lords of castles do the same. As a blind the people assembled one day in the year 1100, supposedly as if on a pilgrimage to the Madonna del Bosco, a celebrated shrine of the neighborhood, determined to revenge themselves on the insults which had for long been cast upon their women folk by neighboring nobles. So successful a demonstration was made that many neighboring castles were razed, and the people, retreating to the peninsula-like small piece of land between the two rivers, started to build a city—the "nuova villa di Cuneo," as it was called by the Abbot of San Dalmazzo in his chronicle.

Afterwards Cuneo was one of the most celebrated military strongholds of Piedmont, and only after the battle of Marengo, when the three consuls decided to raze the walls of Cuneo, Milan and Tortona, was it shorn of its powers.

From Cuneo to the frontier the high road climbs gradually up towards the crest at the Col de Tende, the easiest of all the mountain roads in and out of Italy. At San Dalmazzo, a decayed and almost deserted burg, nearly wiped off the earth by the Milanese in 1250, is the Italian customs house, or *dogana*, where the automobilist and all other travelers by road pay tribute on entering Italy from France, and where those going towards France had best begin to get ready for the same operation a little further on.

The great plains of Piedmont and Lombardy are now far behind, though they may be seen still spreading out into the interminable distance. Now one begins literally to climb for the mass of the Maritime Alps of France and Italy are truly noble. Mont Viso raises its crest nearly 4,000 meters, and a typical Alpine road, though perhaps not the best that ever was, turns and twists its way in lacets until near the top one passes a deserted half-attempted tunnel which was supposed to cut off the climb somewhat. The road goes on, however, for several kilometers farther before the pass is actually reached, and the three kilometer tunnel remains as nothing but a fairy-like project which never came into being.

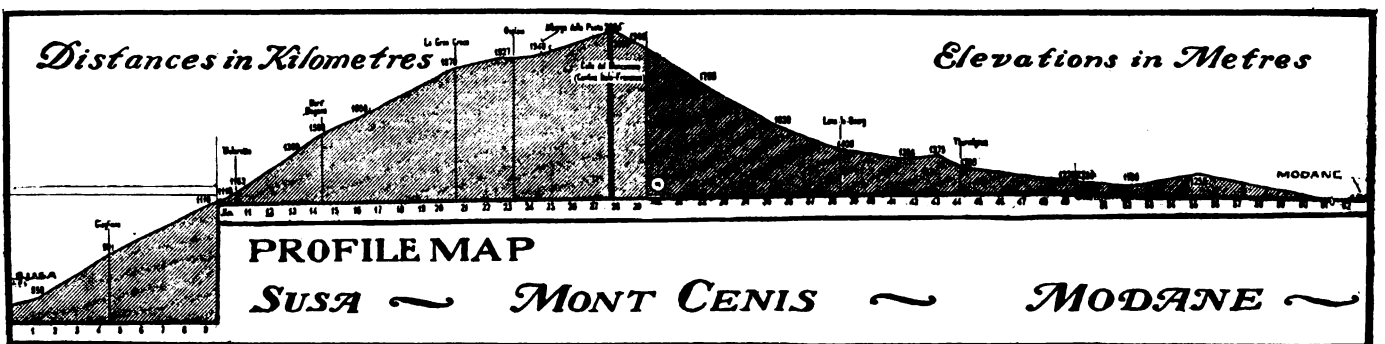

The Col di Tende, the pass where the road drops down on to French soil, is a bad enough place to pass in a gale or a snow storm, for the elements rage here with a fury which has been known to blow horses and mules and carts and men down into the ravine below. Otherwise the road is ranked as a grande route both in France and Italy, and accordingly practicable to automobile or any other wheeled traffic.

On the French side the road descends in seventy odd zigzags to Tende, at the foot of the Col. The soil is still Italian, and in feudal times Tende played no inconsiderable part. There are some remains of an old castle, and history says that Beatrice di Tenda, the wife of its old-time chatelain, was by her lord's orders tortured to death, so that's something to impress Tende on the mind.

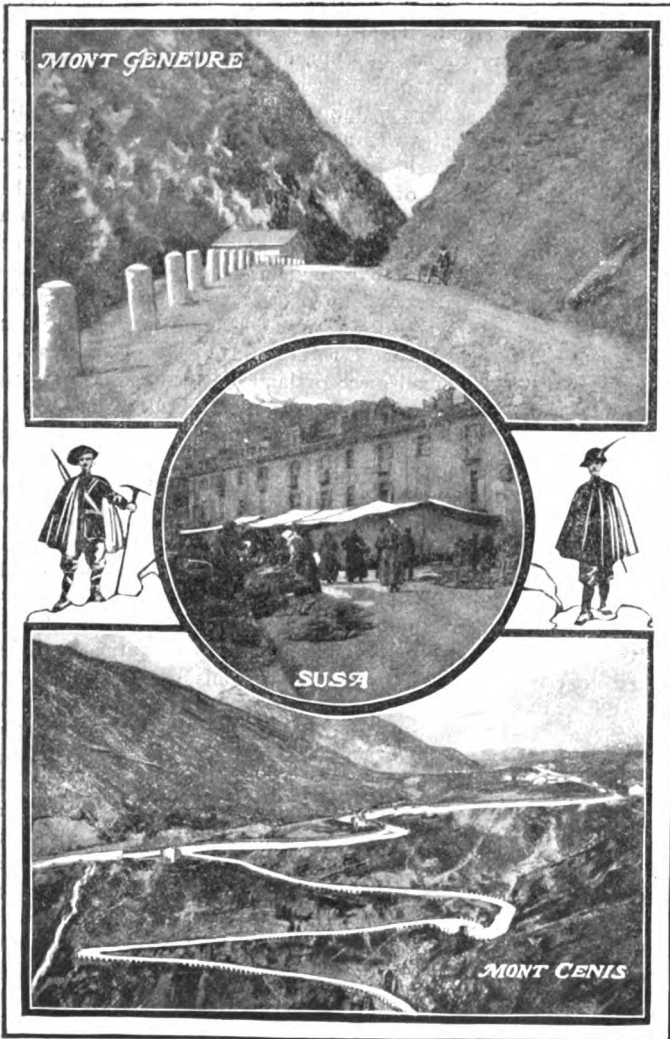

This roadway of the Col de Tende was begun by Carlo Emanuel I., in 1591, and down through successive eras it has ever been improved. It now runs in tumbling, rollicking fashion beside the torrent of the Roya, with little eagle's-nest villages clinging to the cliffs in one side and the rushing waters boiling close on the other. Through the Gorge de Borghe one passes through a defile which is a worthy rival of the Gorge de Pierre Lys in the Pyrenees.

Throughout this region there is a strong mixture of French and Italian that one can hardly tell where one begins and the other leaves off.

The first French village is struck at a level of approximately 300 meters. Giandola is its name, but that is about all one will remember of it.

Sospel is better. It sits in a panoramic site surrounded by gently rising and rounded peaks, and its immediate environs, laid out with olive groves and vineyards, after the unmistakable

Riviera background towns all the way from Toulon to Menton.

The valley now becomes very fertile and the road winds less rudely and savagely as it descends gently to sea level at Nice.

A distinctly curious and interesting industry roundabout is the making of flower essences, notably orange flower water and lavender water. It is the most productive source of income to a country maiden with industrious habits, and with its proceeds she buys to-day "Bon Marché" finery instead of sticking to the picturesque old Niçois costume of a short skirt, a bright fichu and a pancake or crêpe hat such as Fragonard painted in pictures. Fragonard, by the way, was born at Grasse, so he came by the knowledge of the type naturally.

A road branches off from Sospel to Menton by the Col de Castig lione, at a height of 800 meters, and the road is every bit as attractive as that direct into Nice.

From Sospel to Nice direct the road begins to climb immediately one leaves his hotel door, and goes on climbing until it gets eleven or twelve hundred meters above the sea, from whence it drops down as precipitately to the Promenade des Anglais.

GOOD FIELD FOR SALES IN MEXICO

Consul Lewis A. Martin submits the following report on the use of automobiles in the Mexican district of Chihuahua:

Automobiles have been much in evidence in this city during the year past. They are as yet used principally for pleasure, but it is probable that they soon may be used for the delivery of goods and for conveying passengers. A Michigan company has an agency in this city and has sold quite a number of its machines here. There are a few other machines in use, but the great majority of automobiles seen here are of one manufacture. Some months ago there were eighteen automobiles destroyed in a fire which burned the garage where many private machines were stored. A few were rescued, but most of the machines were consumed before the fire could be controlled. This disaster leaves an opening for the sale of as many more. The machines here are used by professional men and by gentlemen interested in mines who live in the city, as well as by persons with means who use them for pleasure.

There are in this city quite a number of wealthy Mexican families who are able to own the very best make of automobiles and they do not care for the price of such things. They like the best and most luxurious conveyances. The most of these people are supplied with fine carriages and beautiful spans of horses, but the keeping of horses in this city is very expensive, and it is understood that the automobile is more economical. There is no competition here in the automobile trade. All those in use are American-built machines and, with few exceptions, all were sold by the Michigan company, no other manufacturer being represented in this city. The type for which a demand could be created here is a light-weight, low-price car, requiring a small amount for upkeep, the roads in this section being hilly and rough and very hard on tires and parts liable to breakage.

APRIL IMPORTS SHOW BIG INCREASE

The monthly summary of the Department of Commerce and Labor shows that for the month of April 185 automobiles were imported of a value of \$312,159 as compared with 58 valued at \$148,603 for the corresponding period of 1908. This, added to previous imports, brings the total for the ten months up to 1,300 machines, with a value of \$2,357,129. This is far in excess of the figures for last year, which were 902 cars, valued at \$2,176,428, and exceeds the number, but not the value, of the 1907 importations—1,008 machines and \$3,505,388 value.

Of the machines imported in the month the geographical distribution is as follows:

United Kingdom	7	\$18,557
France	136	203,954
Germany	8	21,964
Italy	29	56,477
Other Countries	25	11,207

In addition there were parts brought in amounting to the sum of \$50,997. The table of distribution shows that every country except Italy doubled its importation for the month, both in number of machines and value.

The exportations for the same month tell a different story, for the exports of domestic manufacture were nil, while the exports of foreign manufacture show only four machines valued at \$12,579, and no parts.

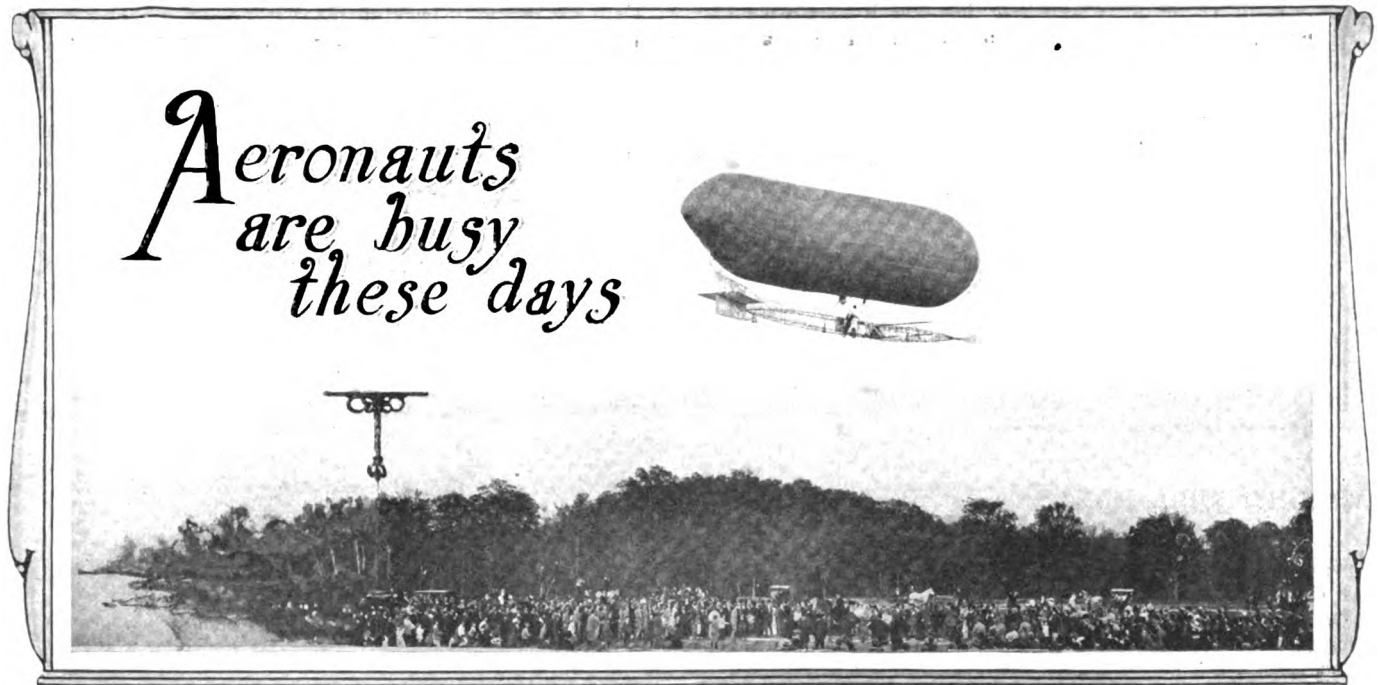

Capt. Thomas S. Baldwin in His Dirigible Airship Making a Successful Flight at North Arlington, New Jersey

PARIS, May 28—The full program has just been issued of the important aeroplane races to take place in the neighborhood of the city of Rheims from August 22 to 29, and which will undoubtedly provide excellent sport of an altogether unusual kind. The ground over which the races are to be held is a vast plain, without trees or any other obstructions, the size of which can be judged from the fact that it has been the scene of some of the largest military reviews Europe has ever known. It is over this course that a special track has been laid down, giving a round of about 6 1-2 miles, over which the aeroplanes will fly without danger of doing injury to spectators if for any reason whatever they are obliged to land during a race. The total prize list amounts to no less than \$40,000, which alone is sufficient to assure participation of the world's best aeronauts.

On the opening day, Sunday, August 22, the elimination race for the Gordon Bennett aeronautical cup will be run off, with a view to selecting the three pilots and machines to represent France. The final of the Gordon Bennett event will take place on Saturday, August 28, the winner to receive, in addition to the work of art, a cash prize of \$5,000. On the same day the first starters will be sent away for the Grand Prix de la Champagne, the prizes for which total \$20,000, of which \$10,000 goes to the first. The third item on the program for the first day is the speed test for one round of the course, the aviator making the fastest time to be the winner of the \$1,400 prize; the second prize is \$600. Both the Grand Prix and the circular race will be continued on each day of the meeting, the fastest times on any one day determining the winner. The first series of the dirigible balloon races will also be held on the opening day, the prizes for this amounting to \$2,000.

On the second day of the meet the straightaway speed test will be run for the first time, as well as the competition for the passenger carrying aeroplanes, for which the total prizes amount to \$2,000. The circular race, comprising one round of the course only, and the dirigible balloon contest will be continued on this day, while Tuesday will be occupied with the same two events.

Wednesday, August 25, will see the second day of the Grand Prix and the fourth day's competition for the dirigible balloons and the circular event. On Thursday, August 26, there will be a modification of the usual proceedings in the shape of a landing competition for spherical balloons, to be followed by the fifth day's races for the circular course and the dirigible balloons. On Friday the last races will be run for the Grand Prix

and the sixth attempts made for the circular race and the dirigible balloon contests, these two latter being continued on the Saturday, in addition to the final for the Gordon Bennett cup. The closing day of the meet, Sunday, August 29, will see the final races for the speed test, the circular test, the dirigible balloon test, and a competition for the \$2,000 offered to the pilot attaining the greatest altitude.

There are very few restrictions regarding the aeroplanes, any type of machine being admitted and any style of motor being allowed. The regulations, however, forbid the modification or changing of any part after the aeroplanes have been brought to the competition ground. Entries at the rate of \$200 per flying machine are received in Paris until the evening of July 22. This sum will be refunded to all pilots crossing the starting line once, and will give the entrants the use of a special shed. Late entries are received until August 10 on payment of double fees, of which amount \$20 will be retained by the local committee if the machine crosses the starting line. Garage accommodation is not assured to late entrants.

BALDWIN'S AIRSHIP FLIES REPEATEDLY

NORTH ARLINGTON, N. J., June 1—Captain Thomas S. Baldwin made good all of his promises for the airship which he has constructed in the aeronautical carnival here last week by repeated flights, varying from a few yards to several miles.

The machine is of the dirigible balloon type, the exterior gas bag being about eighty-six feet long. With this small machine Baldwin on Thursday flew nearly two miles at a height of 200 feet. The following day even this performance was bettered when he reached a very high altitude and covered a distance of more than twice the previous flight. The latter achievement was even more meritorious, for the aviator described several circles to prove his perfect control over the machine.

At the luncheon of the West Hudson Aero Club on Monday he was presented with the first commemorative gold medal of the Aero Club of America for these performances.

PLANS FOR THE GERMAN AIRSHIP LINES

WASHINGTON, D. C., June 1—Consul T. J. Albert, of Brunswick, in reporting that the German Aerial Navigation Company, of Frankfort-on-Main, has established the first permanent air-

ship lines in Germany, gives the following very interesting details: It is the purpose of the company at the start to connect fully 30 cities. It has already received patents for its turn halls for motor balloons, and it will erect the first halls in Berlin, Munich and Strassburg, in Alsace. The extensive plans of the company have aroused the liveliest interest on all sides, and their execution appears to be financially assured.

The first line of connection planned is Munich to Dresden by way of Nuremberg, Plauen and Chemnitz. The second line is from Munich to Cassel by way of Ulm, Stuttgart, Mannheim, Mayence, Coblenz, Cologne, Düsseldorf, Elberfeld and Paderborn. The third line is from Berlin to Lübeck by way of Bremen and Hamburg. The fourth line is from Berlin to Königsberg by way of Stettin and Danzig. The fifth line is from Strassburg to Berlin by way of Metz, Trier, Mayence, Frankfurt, Erfurt, Leipzig, Halle and Magdeburg.

WRIGHT PUPIL MAKES NEW FRENCH RECORD

PAU, FRANCE, May 26—Paul Tissandier, Wilbur Wright's first pupil, has established a new French flying record by remaining in the air 1 hour 2 minutes on a French-built Wright machine. The previous French record was held by Henry Farman, who on October 2 remained aloft at Chalons for 44 minutes 32 seconds. The record of Leon Delagrangé, with the same type of machine as used by Farman, stands at 30 minutes 27 seconds. Paul Tissandier made his first flight in full charge of the Wright aeroplane on February 18 after seven lessons lasting altogether 2 hours 20 minutes. On this occasion Wilbur Wright was by his side, but did not touch any of the controlling levers. The following day the French pilot made a second flight, lasting twenty minutes, under exactly similar conditions, and was then promoted to the stage of instructor. He is now employed by the French company holding the Wright patents to train pupils in the handling of this machine. Paul Tissandier will be a member of the French team in the Gordon Bennett aeroplane race to be run at Rheims on Saturday, August 28.

BRITISH ARMY AEROPLANE FLIES ONE MILE

LONDON, May 25—It certainly appears that the luckless S. F. Cody has come to the end of his run of failures with the aeroplane which he built last year for the army but which has never yet made a satisfactory flight. On the 14th inst. he made a straightway run of over a mile at a height of 30 feet and repeated the performance a second time. At the third trial, at which the Prince and Princess of Wales were present, the machine struck a bank after covering 200 yards, but without effecting much damage. Hope is now freely expressed that this type of machine will soon begin to display some of the advantages which it is claimed to possess.

ZEPPELIN AIRSHIP FLIES 935 MILES

BERLIN, June 2—After covering a distance of about 935 miles in thirty-seven hours, *Zeppelin II* (the famous airship of Count Zeppelin which replaced *Zeppelin I*, that was destroyed by fire last year), in descending for a fresh supply of gasoline for her engines, near Goppingen, in Wurtemberg, ran into a pear tree with such force as to rip the forward compartment of the aluminum envelope for a space of ninety feet. The accident occurred about 11 o'clock on Monday morning.

The airship left the floating shed at Lake Constance shortly after 9 o'clock Saturday night with Berlin as the objective point, where Emperor William was to witness its arrival. Owing to the strong head winds it was deemed inadvisable to proceed nearer to Berlin than Bitterfeld, some four hundred miles from the starting point. The dirigible was here turned about for the homeward course, and the distance covered, while it was in the air, including the maneuvers, prior to the accident, totaled 935 miles. Count Zeppelin, two engineers and a crew of seven men composed the party of aviation.

The trip demonstrates the wonderful possibilities of aerial navigation and the accident in descending could have been avoided by more careful steering. Temporary repairs were made to-day and the airship started on its homeward journey, making about ninety miles the first six hours of its flight.

Doubts Ability to Reach Great Heights—Professor David Todd, of Amherst, is planning a balloon trip in which he will aim to reach the greatest height ever attained by man, more than 20,000 feet. A. Holland Forbes, the aeronaut, however, expresses his doubt as to the ability of any balloon to get that high, stating that the reported altitude of 36,000 feet was accepted without proof. Four miles, he thinks is the limit, and it would be extremely difficult to even get that high. Professor Todd talks of using a steel air-tight basket with arrangements for compressing air in the chamber at high altitudes, and of carrying 10 miles of fine steel wire with which to keep in telegraphic communication with the earth. It has been reported that he has been offered the use of the new balloon of the New England Aero Club, the Massachusetts, and that the ascent will be made from Canton, Ohio.

Wilson Plans Flights at Bangor Fair—Aeroplane flights for the Eastern Maine State Fair at Bangor in the fall are planned by the management and A. V. Wilson, of Bar Harbor. Mr. Wilson has a machine which has been seen in New York and other States, called the Old Hen, and his most successful flight was one of 1,710 feet, at an altitude of 27 feet. It is equipped with an engine of 18 horsepower and will be entered in the competition for the New York *World* \$10,000 prize for the fastest time between New York and Albany.

BRITISH CONTESTS PROGRAM FOR SEASON IS LIGHT

LONDON, May 25—This is to be a quiet season as far as races and trials are concerned, for there are to be none of the former and but two of the latter, the smallest schedule the United Kingdom has known since the advent of automobilism.

The Irish A. C. leads off next week with its annual five days' reliability trial, run in two sections, for private owners and the trade respectively.

The more popular Scottish Trial follows in the third week of June and is this year extended to a distance of 1,000 miles. Nearly seventy entries have been booked, the last of all being the new 38 h.p. Minerva, with Knight engine, made by the Belgian licensees. This will be the first appearance of the slide valve engine in open competition, but matters will not rest there, for the Daimler Company are, as usual, concentrating their forces

on the hill climbs, of which the Rivington Pike, for the North of England, and Shelsey Walsh, for the Midlands, are the principal events.

There will be no road racing this year, despite the fact that the Isle of Man authorities are willing, and even anxious, that there should be a continuance of the Tourist Trophy series. The gap will be filled to some extent by the Brooklands track, which has four big meets to come off, the first being held next week-end. At this meet interest will be centered on the attempts at record by Baker White's big Fiat, the most powerful car ever turned out by the Turin firm. The rated power of the engine is over the 200-h.p. mark, so that a phenomenal speed is quite a possibility. The other events of the same meeting will be mainly handicap races for amateurs.

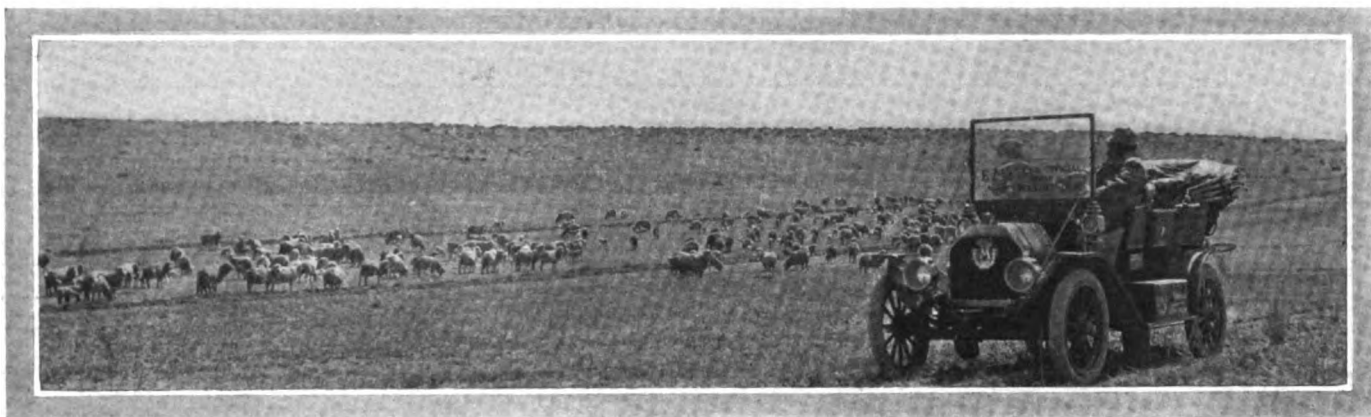

Sheep Ranch in Eastern Colorado on the Route of the Tour for the Glidden Trophy

EARLY ENTRIES FOR GLIDDEN TOUR SET NEW FIGURES

PREDICTIONS that the 1909 tour of the A. A. A. for the Glidden, Hower and Detroit trophies would be the largest entered national tour ever held have shown evidences of realization. Paid entries to the number of thirty-three have been received by Chairman Hower, and on May 24 the number was within a couple of being four times as many as were on hand for the corresponding dates of previous years.

Pierce, Premier, and E-M-F lead with four cars each; Chalmers-Detroit, Maxwell, and Moline will be represented by trios; Brush and Stoddard-Dayton will have two apiece, and American Simplex, Hupmobile, Jewel, Glide, Rapid and McIntyre will have single cars. Inasmuch as it is no longer necessary to enter complete teams in order to secure the much-coveted Glidden cup, it is possible for many concerns to list individual cars and parties. The presence of thirty-three automobiles would alone be considered as a tour of good size, but it is stated from the headquarters of the national contest board that this number will be doubled easily, and probably trebled, before the entries close on June 15, or at least before the start, when cars will be received at additional fees.

The mapping out of the route, except a certain section from Minneapolis to Omaha, has been completed, and at present the plans call for a start of the caravan from Detroit on July 12, finishing at Kansas City on July 29, an elapsed time of eighteen days, with fourteen used in running. Dai Lewis and his pathfinding party in the E-M-F touring car traveled a total of 2,832 miles in going over the route, but the figures for those who are to follow were 2,624, showing that the E-M-F had to run over 200 miles more than required. It is likely that the resurvey will lower the official figures by about 100 miles, when some of

the directions are changed between the Twin Cities and the Missouri River, taking in Mason City instead of Mankato. Several important reasons for the alteration have arisen, among them being the fact that to go by way of Mankato would necessitate the addition of an extra day to the itinerary. The only way this could be added would be to start on Sunday, or the two days planned to stay in Denver would have to be reduced to one. Both are impracticable, however; the latter because the greatest sightseeing trips of the tour are to be enjoyed there, including excursions to the Garden of the Gods, the Grand Cañon, and other Rocky Mountain points. A fund of \$18,000 has been raised by the Denver club for the entertainment of the tourists, and to shorten the stay would be a disappointment both to the hosts and to the guests.

According to the reports of Pathfinder "Dai," the interest in the Middle West over the coming event is intense, surpassing anything that has happened in many years, and throughout the States of Wisconsin, Minnesota, Iowa, Nebraska, Colorado, and Kansas every farmer who talked to the party either owned an automobile or was talking of buying one. Kansas City is the third largest automobile distributing point in the country, and one town passed through between Denver and the finish, Ellis, has a population of 1,500, and there are more than 100 automobiles owned there now. When the Mile-High city was reached the Pathfinders were escorted through the streets by 143 automobiles, bombs were shot off, and a brass band joined in the celebration. The two days scheduled to be spent in Denver are July 24 and 25. Minneapolis will have July 17 and 18, and its autoists are planning entertainment features which will long be remembered.



Convention Hall, Kansas City, the Tour's Terminus



Pathfinder Lewis Meets Veteran Pedestrian Weston

En Route to call upon Diaz

CAR. CHALMERS-DETROIT
SPOONER
PHOTOGRAPHER



Passing through
the Customs
House at
Juarez

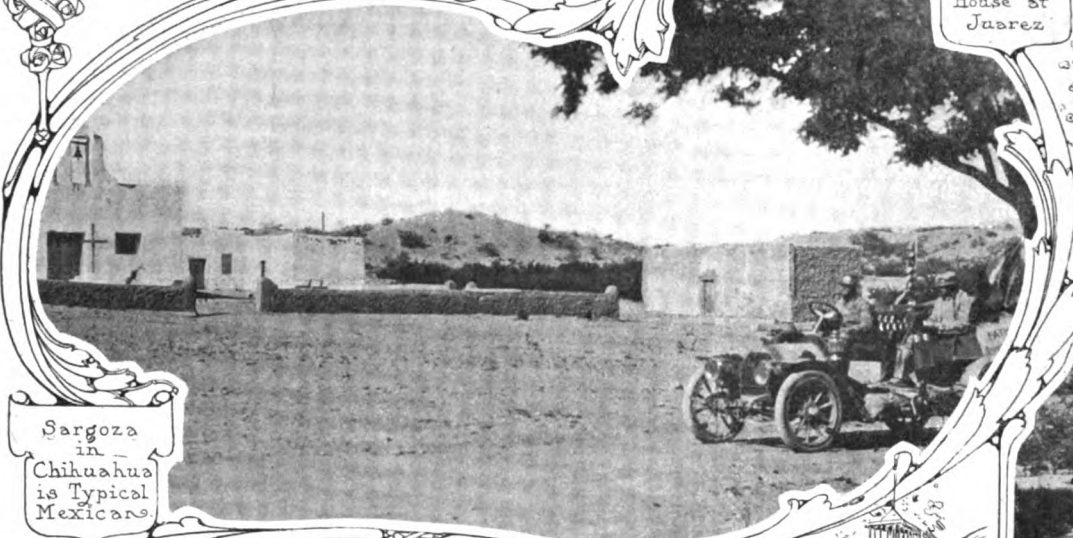

Sargoza
in
Chihuahua
is Typical
Mexicans



Before the
food gave out



Called an
average
road.



The Horse brought water.

FLAG TO FLAG CAR PROGRESSES

TURREON, MEXICO, May 27—The Chalmers-Detroit pathfinding car for the Flag to Flag race reached here to-day after making 156 miles in thirteen hours and 310 miles since Monday. To-day will be a day of rest, and will be spent in finding a new guide for the Mexican roads, which are to come on the last leg of the tour to the City of Mexico.

The car is apparently in Chihuahua province and not far from the principal city of the same name, which is but 220 miles from Ciudad Juarez, where the line was crossed. If the general direction thus far be continued, the provinces to be crossed next, with the distances, will be: Durango, 300 miles; Zacatecas, 175 miles; Agua Calientes, 75 miles; Guanajuato, 100 miles, and finally, Mexico province to Mexico City, 175 miles. This makes total from the border line of 1,045 miles, which is by map and air-line distances at that, probably the car will travel 1,500 miles to actually cover this same country. With the distance already traversed, there remain about 1,300 miles before the goal is reached.

INDIANAPOLIS TO CHICAGO AUTOWAY

INDIANAPOLIS, IND., May 31.—A boulevard connecting this city with Chicago is the plan of a number of capitalists of this and other States, according to Charles S. Hernley, of Newcastle, who is interested in the project. Because of the magnitude of the project, which will require a highway 200 miles long, there has been considerable scepticism relative to the scheme, but the promoters assert they are serious in their intentions. The boulevard, by a conservative estimate, is expected to cost from \$1,500,000 to \$2,000,000.

The plan is to obtain a private right of way between the two cities and build a model highway to be used by automobiles exclusively. The highway will be fenced, and in all probability there will be no speed restrictions.

Mr. Hernly announces that associated with him in the project are Benjamin F. Briscoe, of Tarrytown, N. Y., of the Maxwell-Briscoe Motor Company; Carl G. Fisher, president of the Prest-O-Lite Company and interested in the Indianapolis Motor Speedway, and other automobile men whose names he is not at liberty to mention at the present time.

The company will have an authorized capitalization of \$250,000 and shares will be sold at \$100 each. As the work progresses the capital stock will be increased.

ROAD TELEPHONE SYSTEM FOR TOURISTS

SANTA BARBARA, CAL., May 31—Telephone communication from almost any point while touring may be a possibility if certain plans outlined in this city are carried out. Fred Spoeri, division contract agent of the Pacific Telephone & Telegraph Company, has suggested a road 'phone for use exclusively by automobilists. By a nominal monthly rental the tourists would be supplied with telephone outfits similar to those used by linemen, and every mile a wire would be run down the pole from the main line, there installing a "jack" or connection. Thus a tourist would never be more than half a mile from a telephone wire, and the scheme would be especially adaptable in southern California, where nearly all highways are paralleled by telephone systems.

CLEVELAND AUTOISTS POSTING SIGNS

CLEVELAND, May 31—Using the old Studebaker "war car," which is also to be employed as a press car in the Glidden tour this year, the officers of the Cleveland Automobile Club are now signboarding a goodly portion of northern Ohio. Old signs are being renewed wherever necessary, while many other highways are receiving signs for the first time. When the work is completed it is expected that the northern part of the State, both east and west of Cleveland, as well as south, will be completely covered with clear road directions.

THE AUTOMOBILE CALENDAR

AMERICAN

Shows, Meetings, Etc.

- Nov. 6-13.....Atlanta, Ga., Auditorium-Armory, National Automobile Show.
- Dec. 31-Jan. 7....New York City, Grand Central Palace, Decennial International Automobile Show: American Motor Car Manufacturers' Association, with Importers Automobile Salon and Motor and Accessory Manufacturers. Alfred Reeves, General Manager, 505 Fifth Avenue, New York.
- Jan. 8-15.....New York City, Madison Square Garden, Tenth National Show, Association of Licensed Automobile Manufacturers.
- Feb. 5-12.....Chicago, Coliseum, Ninth Annual Automobile Show, National Association of Automobile Manufacturers. S. A. Miles, General Manager.

Races, Hill Climbs, Etc.

- June 5.....Cleveland, O., Hill Climb, Porter Hill, Cleveland Automobile Club.
- June 9.....Louisville, Ky., Track Race Meet, Louisville Imperial Council Committee.
- June 9.....National Orphans' Day.
- June 12.....Wilmington, Del., 106-Mile Sealed Time Run, Delaware Automobile Association.
- June 12.....Worcester, Mass. Annual Dead Horse Hill Climb, Worcester Automobile Club.
- June 12-14.....New York City, Catskill-Berkshire Endurance Contest, New York Automobile Trade Association.
- June 14-18.....Philadelphia Reliability Run to Pittsburg and Return, Quaker City Motor Club.
- June 14-21.....Annual 660-Mile Spring Tour Maxwell-Briscoe Motor Club, New York City via Waterbury, Stockbridge, Newburgh, Delaware Water Gap, Philadelphia, Atlantic City, to New York.
- June 17.....Readville, Mass., Track Race Meet, Bay State Automobile Association.
- June 18-19.....Chicago, Stock Chassis Race for Cobe Trophy and Light Car Race.
- June 21-26.....Binghamton, N. Y., Fourth Annual Endurance Run, Binghamton Automobile Club.
- June 22-28.....Albany, N. Y., Fifth Annual Tour, Bretton Woods, Portsmouth, Boston, Albany Automobile Club.
- June 24-26.....Montreal, Blue Bonnets Track, Race Meet. R. M. Jaffray, Manager.
- June 25-26.....Philadelphia, 24-Hour Track Race, Quaker City Motor Club.
- July 3 and 5....Wildwood, N. J., Straightaway Races, Motor Club of Wildwood.
- July 4.....Los Angeles, Cal., Southern California Automobile Dealers' Association. Road Races, 250 Miles for Large Cars; 150 Miles for Light Cars.
- July 12.....Detroit, Start of Sixth Annual A. A. A. Tour for Glidden Trophy.
- Aug. 5.....Chicago, Fourth Annual Algonquin Hill Climb, Chicago Motor Club.
- Sept. 6-11.....Lowell, Mass., Automobile Carnival, Lowell Automobile Club.
- Sept. 15.....Denver, Col., Start of Flag to Flag Endurance Run to Mexico City.
- Oct. 7.....Philadelphia, Second Annual Stock Chassis, 200-mile Race, Fairmount Park, Quaker City, M. C.
- Dec. 29-30.....Philadelphia, Fourth Annual Midwinter Endurance Contest, Quaker City Motor Club.

FOREIGN

Races, Hill Climbs, Etc.

- June 10-18.....Germany, Prince Henry Cup Competition.
- June 14-19.....Scotland, Annual Scottish Reliability Trials.
- June 20.....France, Bologne-sur-Mer Course, Voiturette Race, Auspices "L'Auto."
- July 13-17.....Belgium, Ostend Automobile Race Week.
- Aug. 22-29.....France, Reims, Aeroplane Races and Grand Prix, Aero Club of France.
- Sept. 5.....France, Mont Venteoux Hill Climb.
- Sept. 19.....Austria Semmering Hill Climb.

Emperor William of Germany has signed the muchly contested motor liability law which now becomes a stern reality. It remains to be seen what influence it will have on the trade.

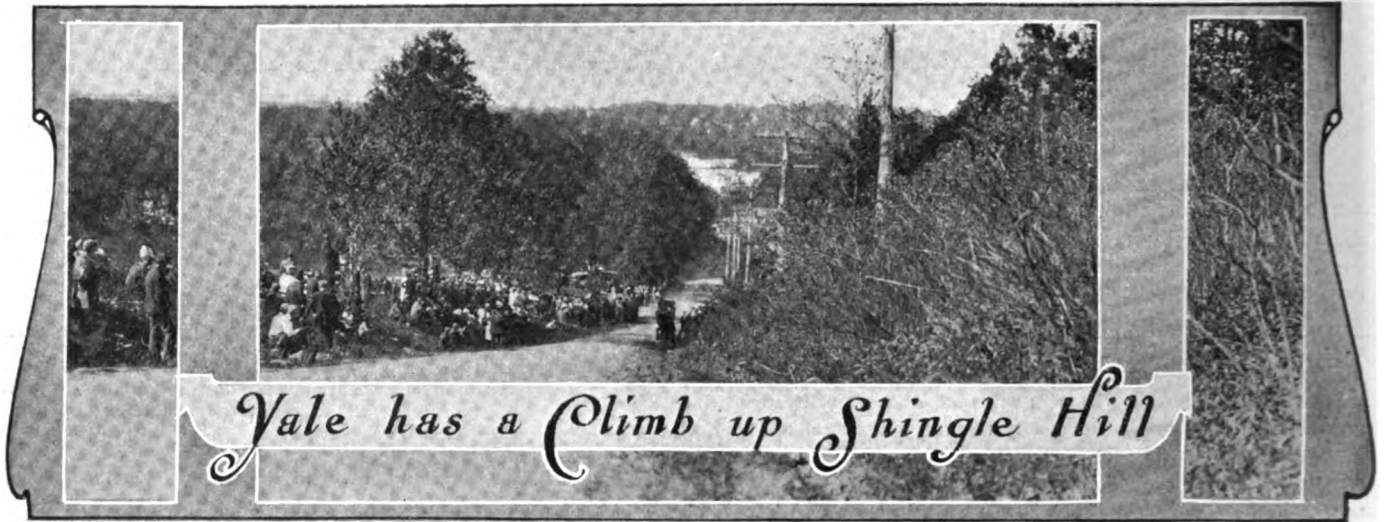

NEW HAVEN, CONN., May 31—Some tall hill-climbing took place up Shingle Hill on the afternoon of May 26, for an overflowing entry was attracted to the second ascent of the Yale Automobile Club. While the "big fellows" attracted the interest of those seeking the spectacular, the performances of the stock cars found the greatest favor, for those contests involved machines, duplicates of which are purchasable by the general public. The Simplex got the high-price class with Stoddard-Dayton the star in the next brigade and then Knox took the prize in two divisions.

A feature was the perfect regulation of the course, not by uniformed officials, but handled in a masterful manner by the students themselves. The fact that the 15,000 spectators did not crowd upon the road or embarrass the contestants is proof sufficient of the result. Shingle Hill is not in itself a great incline, and, in fact, when some of those visitors who have witnessed the climbs at Wilkes-Barre, Mount Washington and elsewhere arrived they asked the whereabouts of the "hill," not realizing that they were upon it. The distance covered was seven-eighths of a mile, with two main rises, one of about 15 per cent close to the start and the other near the finish.

It was expected that David Bruce Brown would capture the free-for-all honors with the 120-horsepower Benz, and he did so handily, flashing up the hill in 51 1-5 seconds.

The motorcycles had several sections to themselves, depending upon their piston displacement for classification, and many operated by Yale students, among whom this type of locomotion is very popular. Bill Wray, not of Yale, was the star, and his twin-cylinder Indian flew over the course in 52 2-5 seconds.

Under the direction of prominent officials the events were dispatched in quick time and to the gratification of all con-

cerned. Fred J. Wagner was the starter, and Robert Lee Morrell acted as referee. Summaries of the auto events follow:

STOCK CARS SELLING FOR \$4,001 OR OVER.

No.	Car.	H.P.	Driver.	Time.
1.	Simplex	90	Moult	1:04
2.	Simplex	60	Broesel	1:05 3-5
3.	Isotta	30	Pepperday	1:07 2-5
4.	Lozler	45	Beebe	1:13 3-5
5.	Stearns	30	Doys	1:16 1-5

STOCK CARS SELLING FROM \$3,001 TO \$4,000.

1.	Stoddard-Dayton	60	Miller	1:05 3-5
2.	A.-K.	48	Reppingill	1:19 3-5
3.	Packard	30	Bourne	1:21 3-5
4.	Thomas	70	Bran	1:23 3-5

STOCK CARS COSTING UNDER \$3,000.

1.	Knox	38	Bourque	1:00
2.	Chalmers	40	Cameron	1:02 1-5
3.	Chalmers	40	Lorimer	1:05 3-5
4.	Buick	30	Burman	1:05 4-5
5.	Stoddard-Dayton	45	Tuttle	1:07 1-5

CARS SELLING FROM \$2,001 TO \$3,000.

1.	Knox	38	Belcher	1:05 1-5
2.	Chalmers	40	Cameron	1:07 3-5
3.	Stoddard-Dayton	45	Tuttle	1:08 2-5
4.	Chalmers	40	Lorimer	1:09 4-5
5.	Knox	38	Bourque	1:10

CARS SELLING FROM \$1,251 TO \$2,000.

1.	Buick	18	Burman	1:07 3-5
2.	Buick	30	Bull	1:18 1-5
3.	Chalmers	30	Decker	1:35 4-5

CARS SELLING UNDER \$1,250.

1.	Buick	18	Burman	1:19 4-5
2.	Overland	22	Gates	1:56

FREE FOR ALL—ALL MAKES AND POWERS.

1.	Benz	120	Brown	:51 1-5
2.	Panhard	120	Webb	:57
3.	Knox	48	Dennison	:58 3-5
4.	Knox	38	Bourque	1:00 2-5
5.	Columbia	32	Coffee	1:00 4-5

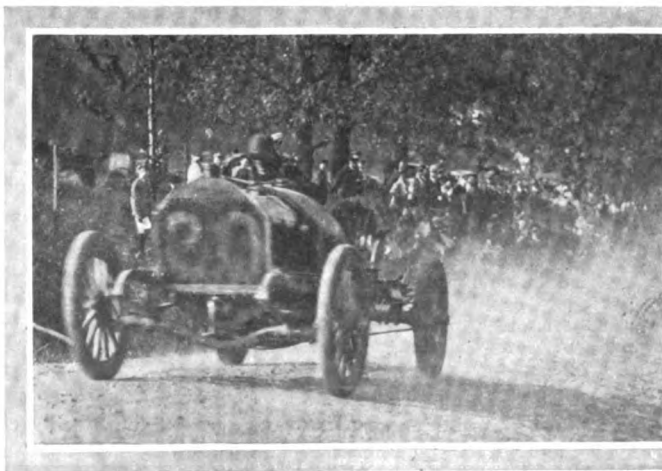

Bourque in Knox Winning His Stock Car Class

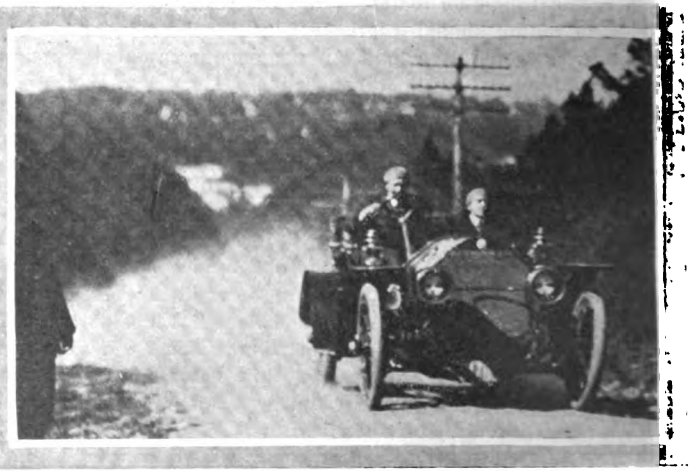

Moult Driving Simplex to Victory at New Haven

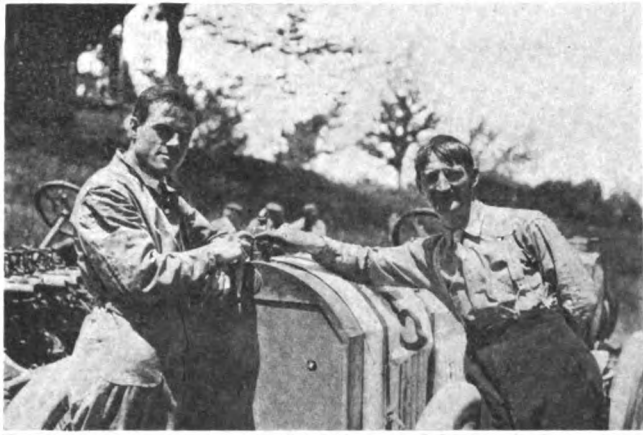

Driver David Bruce Brown, His Benz and Mechanician

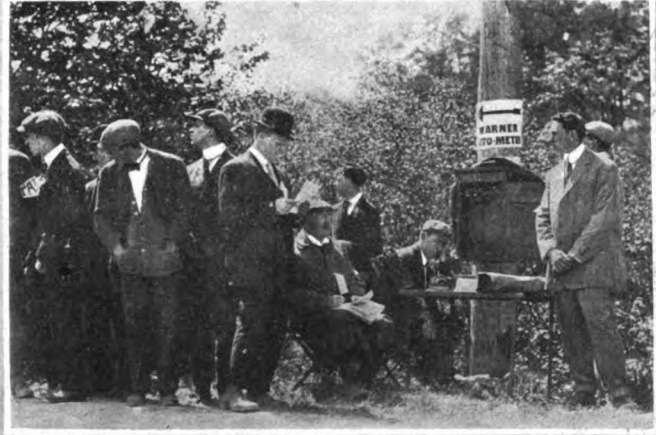

Where the Officials Figured Out the Results

PEERLESS AND MERCER WIN AT TRENTON

TRENTON, N. J., May 31—Peerless and Mercer automobiles to-day won in their respective classes in the run-off of the tie made in the Delaware Valley endurance contest on May 17. Over a circuit of 64 miles, it required six laps to produce a winner, and the Mercer took an extra round for good luck. Out of the 21 starters in the original contest there were 12 with clean records, but only eight appeared for the supplementary event this morning. They were: Peerless, Oldsmobile and Stoddard-Dayton, in the class for cars costing more than \$2,000; and Mercer, Overland, Regal, Maxwell and Crawford, in the class for cars selling for less than \$2,000. The Stoddard-Dayton made one round and was then withdrawn, for its owner did not wish to punish his own car unnecessarily; and the Oldsmobile completed the 384 miles perfectly, but inasmuch as both the Olds and the Peerless were entered by R. C. Manning, he directed that the Olds should take second place, giving the Peerless first.

The Crawford car ran smoothly until dark to-night, when it had trouble with its lights and driver Shedd then withdrew. The Maxwell withdrew in the first round, and on the second the Regal skidded into a ditch at Cookestown. It was not damaged, but did not continue in the contest. The Overland was penalized for lateness on the sixth lap because of darkness and the absence of headlights. Its driver has protested the Mercer because the driver of the Trenton-made car was handed a searchlight at Cookestown, thereby enabling him to drive faster in the dark. The Mercer Company suggests a duel contest on the fair grounds track, if the protest is upheld, to run the two cars until one stops, with a maximum allowed speed of 40 miles per hour.

WORCESTER'S DEAD HORSE CLIMB MUCH ALIVE

WORCESTER, May 31—Indications point to the most successful high climb in the history of the Worcester Automobile Club, scheduled for Saturday, June 12. The entries are coming in rapidly and are very representative. Permits for the use of the hill have been granted by the Worcester Board of Aldermen and the selectmen of the town of Leicester, the hill being in the two towns. The arrangements for the hill climb have been left with President John P. Coghlin, of the Worcester Automobile Club, and he will select his committees later, they being taken from the various clubs in Massachusetts. Under the rules of the Contest Board of the American Automobile Association, a representative of the board must be present at the climb, and it is probable that Harry W. Knights, of Boston, representative on the board from Massachusetts, will act at the climb.

DIAMOND COMPANY OFFERS CASH PRIZES

AKRON, O., May 31—Cash prizes for the drivers in the Western stock chassis races, the Cobe and light car trophy events, have been offered by the Diamond Rubber Company of this city. The aggregate is \$2,775, divided as follows: Driver with Diamond equipment who wins first place, \$1,000; second, \$750; third, \$500. For the Indian trophy, light car race: Winner on Diamond equipment, \$300; second, \$150; third, \$75. The Diamond tire camp will be established upon the course a week in advance of the dates of the races, June 18 and 19, and will be in charge of J. D. Tew.

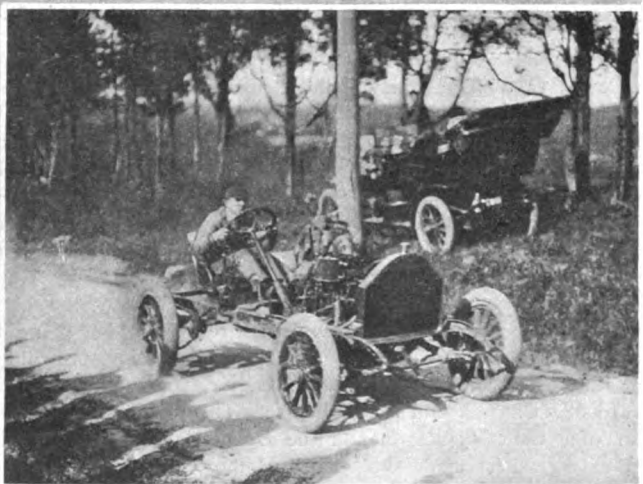

Dennison Driving His Knox in the Free-for-All

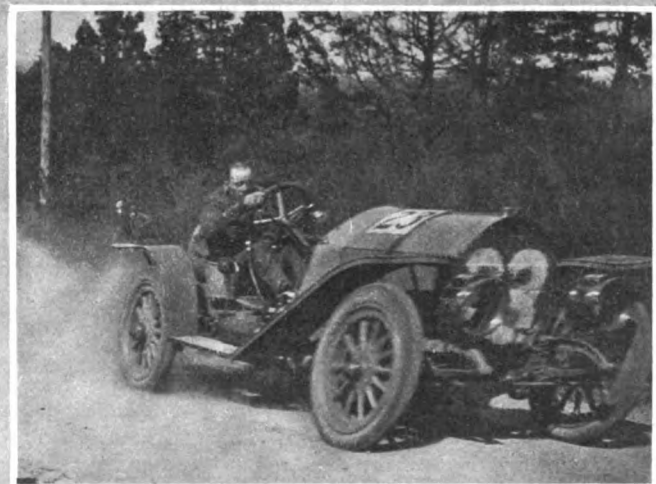

Miller, Stoddard-Dayton, Winning in His Class

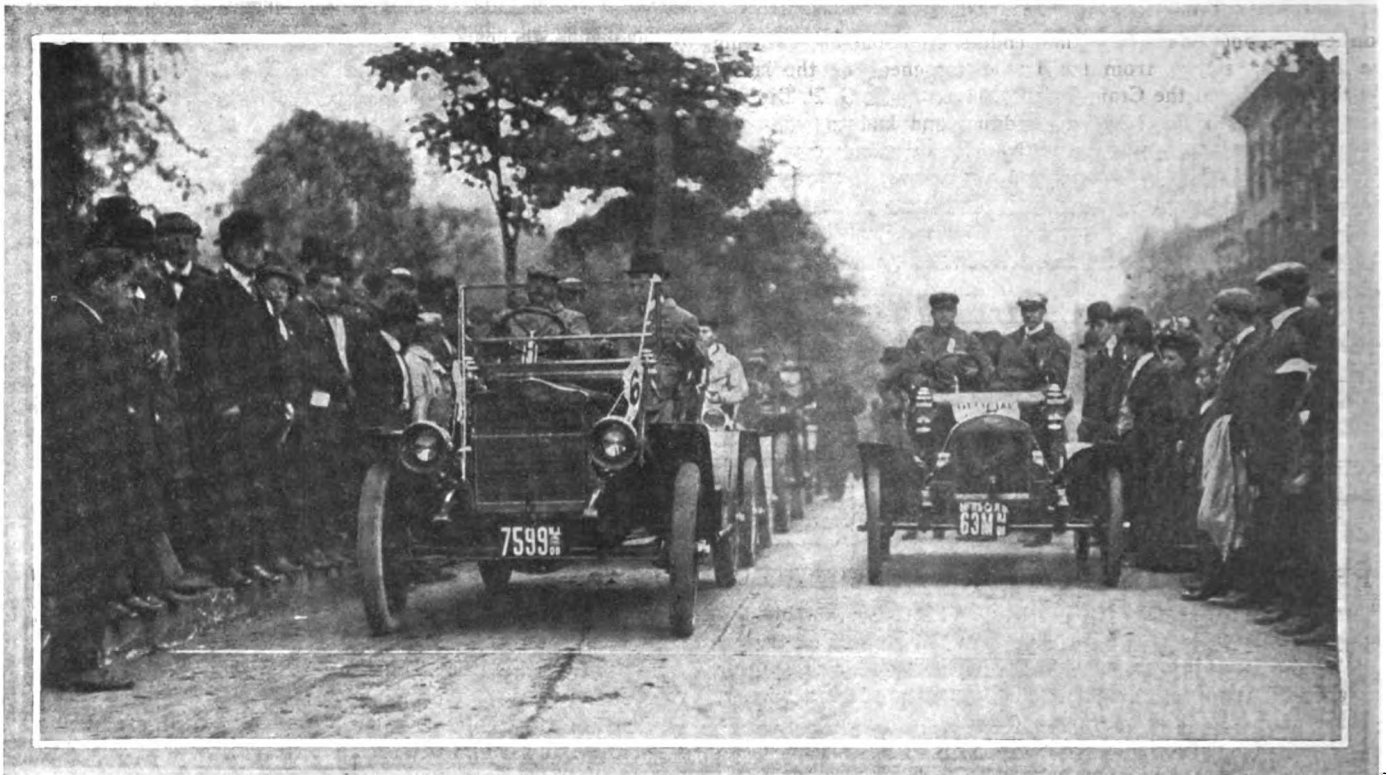

Line-Up for the Start of the New Jersey Automobile and Motor Club's Endurance Run in Front of Club House

NEW JERSEY'S BIG CLUB GIVES A RUN FOR AMATEURS

NEWARK, N. J., May 31—Weather conditions did not favor the endurance run of the New Jersey Automobile and Motor Club for its non-trade members. Originally scheduled for May 22, it was postponed, because of hard rains, to May 27 and held them in a driving rainstorm. In spite of these handicaps, however, the event was another success in the list of those held by the club, for there were twenty-one starters, of which fifteen finished and thirteen had perfect scores. Three classes divided the contestants, according to horsepower, 20 or less, 20 to 30, and over 30 being the important figures in the case; and in these definite winners were secured in the first two and a three-cornered tie in the last. The rules called for a run of 193 miles in two laps, with the circuit between Newark and Hackettstown. The schedule required an average speed of 19.3 miles an hour, and the cars had to check in at the Newark control within three minutes of their appointed times on each trip. In addition to this it was necessary to keep the wheels moving at all times from Dover to the finish, a distance of 28.1 miles.

In each class it was announced that the car which came nearest to crossing the line exactly upon the second—for seconds were watched carefully—would be declared the winner. There were four trophies: Class A, silver trophy, donated by W. S. Thomas; Class B, silver cup, donated by W. C. Crosby; Class C, silver cup, donated by the *Sunday Call*; silver trophy for the best Maxwell performer, donated by the Maxwell-Briscoe Motor Company. In addition to these, the club will present to each perfect score driver a loving cup.

H. A. Bonnell captured premier honors by carrying off three of the trophies with his Maxwell tourer, winning Class B and the Crosby cup by having the best score of the three Maxwell entries, securing the Maxwell challenge trophy, and by having a perfect score getting the regular club prize. A two-cylinder Reo, the only car in the contest not of the four-cylinder type, driven by D. J. Holmes, won class A, although penalized 17 points, three of which were for three minutes carbureter attention on the road, and the other 14 for adjusting a spark plug at a two-point-a-minute penalty. This car and the second in the

same class were the only ones to receive demerit marks. The second was a Buick driven by W. F. Hopping, and lost 18 minutes or 36 points on the second lap. Mr. Bonnell was the only one in class B who crossed the tape both times on the second, but such was not the case in class C, where three accomplished the difficult act. These were F. A. Croselmire in a 40-horsepower Locomobile, F. L. Kramer in a 35-horsepower Jackson and W. C. Crosby in a 50-horsepower Marmon. Of the others who completed the circuits within the three-minute allowance, there was in each case a slight earliness or lateness, sometimes not more than a few seconds.

Checking out at 8 o'clock the contestants ran through Springfield, Morristown, Madison, German Valley, over Schooley's Mountain to Hackettstown. Returning the route led through Allamuchy, Dover, Caldwell, Montclair and Bloomfield. The roads were excellent with the exception of a few miles between Hackettstown and Dover, and even there they were not bad, simply muddy and rough. The rain soon made the roads slippery, however, and this was responsible for an accident to a Mitchell roadster driven by D. J. Scott, in which the observer, E. R. Carter, of Tompkinsville, S. I., had his collar bone broken. The car was descending a hill at Allamuchy and skidded over to the right of the road, its right rear wheel hub hit a protruding rock and the impact threw the car over toward the other side. Scott could not regain control in time to keep from hitting a telegraph pole, cutting it in half and throwing out all the occupants. Carter was the only one hurt and a physician was summoned to attend to him. He returned to the city by train. There were but two other exciting incidents, both at the starting line, and only the presence of a fire wagon belonging to the Tea Tray Company prevented a conflagration. In filling up for the second round some gasoline was spilled around Ward's DeDietrich and it caught fire. The flames damaged the rear of Kramer's Jackson and the DeDietrich slightly, but the fire extinguishers made short work of the trouble and both cars went on their way. After checking in at the completion of the run, C. E. Callard's Marmon skidded into two Maxwells, one

an official car belonging to J. W. Mason and the other Mr. Bonnell's winner, damaging the fenders on both, and shearing the left rear spring from the frame gooseneck of the latter. On the first round the Craig-Toledo, driven by R. G. P. Dieffenbach, threw both rear tires in skidding and had to withdraw. There was a great deal of tire trouble, the Chalmers-Detroit belonging to W. L. Ferguson having five punctures, and he withdrew after finishing one lap.

The officials were: Referee, Paul E. Heller; starter, Mayor Jacob Haussling; committee, J. H. Wood, chairman; F. C. J. Wiss, H. D. Bowman, D. C. Reynolds, A. B. LeMassena, J. L. Adams, Jr.; C. A. Westervelt. The official cars were: Pathfinder, Cadillac, C. E. Fisher; press, Marmon, Rickey Machine Company; committee, two Maxwells, J. W. Mason. The observers were students from the Stevens Polytechnic Institute. The summary follows:

CLASS A CARS, TO AND INCLUDING 20-H.P.

No.	Car.	H.P.	Driver.	Score.
25.	Reo	20	D. J. Holmes	17
11.	Buick	18	W. F. Hopping	36
7.	Buick	18	J. J. C. Humbert	Withdrawn
19.	Mitchell	20	D. J. Scott	Withdrawn

CLASS B CARS, 21-H.P. TO AND INCLUDING 30-H.P.

No.	Car.	H.P.	Driver.	Score.
1.	Maxwell	28	H. A. Bonnell	Winner
6.	Maxwell	28	M. R. Sherrerd	Perfect
16.	Maxwell	28	Andrew Heuschkel	Perfect
17.	Autocar	30	M. A. Carpenter	Perfect
24.	Crawford	25	F. G. Goeken	Perfect
14.	Cadillac	30	A. B. Ward	Withdrawn

CLASS C CARS, 31-H.P. AND OVER.

No.	Car.	H.P.	Driver.	Score.
2.	Locomobile	40	F. A. Croseimire	Tied
9.	Jackon	35	F. L. Kramer	Tied
10.	Marmon	50	W. C. Crosby	Tied
3.	Oldsmobile	35	W. H. Cornwell	Perfect
4.	Marmon	50	C. E. Callard	Perfect
8.	DeDietrich	20	R. S. Ward	Perfect
12.	Haynes	50	W. E. Shuttleworth	Perfect
20.	Fiat	35	A. N. Elsele	Perfect
5.	Craig-Toledo	40	R. G. P. Dieffenbach	Withdrawn
18.	Chalmers-Detroit	30	W. L. Ferguson	Withdrawn
26.	Fiat	35	W. B. Gibson	Withdrawn

BRIGHT PROSPECTS FOR BINGHAMTON RUN

BINGHAMTON, N. Y., May 31—With three weeks still to pass before the start, there are already 21 entries for the fourth annual tour of the Binghamton Automobile Club. It is expected that there will be at least 30 cars, and likely more, to leave this city on the morning of June 21, to be gone until the evening of June 26. The tour will be essentially a pleasure one, for there will be a large number of private owners in the party, but there is enough of the competitive nature about the event to make it worth while to win. The outlook is brighter than ever before, and a number of persons have joined the club simply to be able to take a run which they have always desired to make. The rules are such that the trip will be a sight-seeing one, with a schedule so low and roads so good that easy runs may be made and short stops at particularly interesting points. A noon control will be established each day for lunch and night stops made at Albany, Boston, Hartford, Conn., and Newburgh, N. Y. One entire day will be spent in seeing Boston. The distance to be covered is 761 miles, of which more than 490 is macadam and the remainder good dirt. A pathfinding car will start over the route within a few days, making up the directions and also paying attention to features of the country through which the autoists will pass.

ALBANY HILL CLIMB ABANDONED

ALBANY, N. Y., May 31—It has been decided by the Albany Automobile Club that the climb which it proposed to hold on the Kenwood Hill on June 5 will be abandoned for the present season. According to Secretary Martin lack of entries is the cause, for it had been stipulated that there should be at least three entries to fill each of the 17 events and sufficient had not been received to warrant a carrying out of the affair.



Secretary Bonnell and Triple Prize Winning Maxwell

SEALED BONNET CUPS AWARDED AT BALTIMORE

BALTIMORE, May 31—Six cups will be awarded by the Automobile Club of Maryland to the cars that made the best records in the sealed bonnet contest and endurance run under the club's auspices on Saturday, May 15. This decision was reached at a meeting, Friday, of the Contest Committee of the club. The Winton 48-horsepower and Packard 30-horsepower were tied in Class A, each with two points penalty, so that each will receive a cup. Two cups will also be awarded in Class B, the successful cars being the 35-40 horsepower Gaeth and the 45-horsepower Stoddard-Dayton, each with twelve bad marks against them. The 40-horsepower Studebaker finished in this class with a perfect score, but was ineligible for a prize, as it was a racer and non-contestant.

The decision to give the Gaeth car a cup was made after the penalty had been reduced from 45 points to 12 points. The original heavy penalty was given on technical examination because it was claimed that the car's gasoline tank leaked and that it had a broken muffler pipe. Upon closer examination it was discovered that the car's gasoline tank did not leak, but that this apparent condition was in reality due to the slopover from the fill. Secretary Darling, of the Auto Club and a member of the Contest Committee, said that part of the points were also reduced on the Gaeth car because of a lower value to replacement of parts of the muffler pipe.

The 28-horsepower Franklin, with a perfect score, will get the cup in Class C, and the 16-horsepower Hupmobile will be the trophy bearer in Class D.

The arrangement to give separate cups will obviate the necessity of having a run-off. It is likely that the tied contestants will have a chance to get together in the next contest.

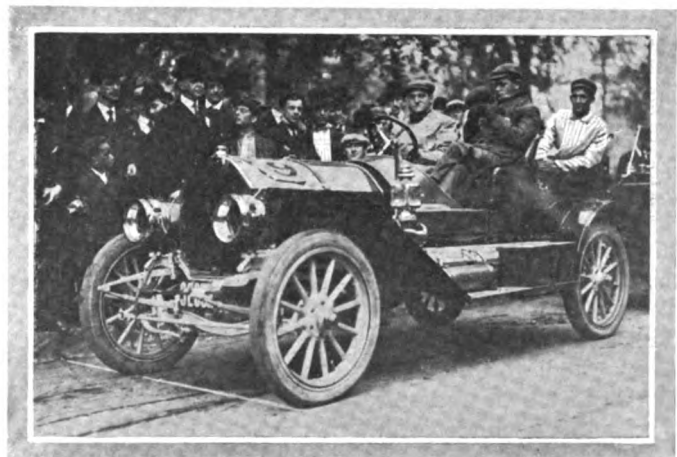

Champion Cyclist Kramer Was a Perfect Score Jacksonville



Vol. XX.

Thursday, June 3, 1909

No. 22

THE CLASS JOURNAL COMPANY

H. M. SWETLAND, President
A. B. SWETLAND, Business Manager
231-241 West 39th Street, New York City

EDITORIAL DEPARTMENT

A. G. BATCHELDER, Managing Editor
R. F. KELSEY, Associate Editor
THOS. J. FAY MORRIS A. HALL W. McK. WHITE D. R. HOBART
W. F. BRADLEY, Foreign Representative

ADVERTISING DEPARTMENT

M. C. ROBBINS, Manager LOUIS R. SMITH, New York
W. L. RALPH, 1035 Old South Bldg., Boston FRANK B. BARNETT, Cleveland
C. H. GURNETT, 1200 Michigan Ave., H. H. GILL, Detroit
F. W. VAN SICKLEN, Chicago T. B. VAN ALSTYNE, Philadelphia

Cable Address - - - - - Autoland, New York
Long Distance Telephone - - - - - 2046 Bryant, New York

SUBSCRIPTION RATES:

United States and Mexico - - - - - One Year, \$3.00
Other Countries in Postal Union, including Canada - - - - - One Year, 5.00
To Subscribers—Do not send money by ordinary mail. Remit by Draft,
Post-Office or Express Money Order, or Register your letter.

FOREIGN SUBSCRIPTION AGENTS:

ENGLAND:—W. H. Smith & Sons, Ltd., 186 Strand, London, W. C., and all book-
stalls and agencies in Great Britain; also in Paris at 248 Rue de Rivoli.
FRANCE:—L. Baudry de Saunier, offices of "Omnia," 20 Rue Duret, Avenue
de la Grande Armee, Paris.
GERMANY:—A. Seydel, Mohrenstrasse 9, Berlin.

Entered at New York, N. Y., as second-class matter.
The Automobile is a consolidation of The Automobile (monthly) and the Motor
Review (weekly), May, 1902, Dealer and Repairman (monthly), October, 1903,
and the Automobile Magazine (monthly), July, 1907.

PREPARATION OF A CAR FOR SPRING USE

In the yearly overhauling of a car, preparatory to its
use for the ensuing season, there is too much of a ten-
dency to trust implicitly those who have the work in
hand. It is a usual fact that the ordinary owner when
he has hired a garage to go over his car does not upon
its receipt in supposedly perfect shape examine it thor-
oughly to see how many nuts were left off, how many
cotter pins were omitted, and how many other little parts
were not put together absolutely right. Then, too, many
who would check up the corner garage in this fashion
would not think of overseeing the same work when done
by the manufacturer of the car. The reasoning which
prompts this is doubtless that the latter has superior
facilities for doing the work and a superior set of men
to do the putting together.

The latter is fortuitous, for the men employed in the
factory are only human, the same as those in the corner
garage. For this reason, if for no other, the car just re-
turned from the factory should be carefully and pains-
takingly gone over from one end to the other, in order
to check up all of the little details, none of which would
be too small for the owner, but some of which might
have been too microscopic for the mechanic on the job.

It is a matter of record that a number of accidents hap-
pen each Spring from this cause, and for which there
is not a particle of excuse. One case recently heard of

was that of a man who had sent his car to the factory
and paid a large sum to have the whole chassis revised
and all defects corrected. The car was returned to him
as all right, and he immediately took his family out for
a ride. After a few hours' riding he was stopped when
going at a rather high speed by a man who called his
attention to one of the front wheels. Upon close ex-
amination this was found to be very loose, so much so
that another half mile would have seen it part company
with the axle. At the speed the car was traveling this
would have been fatal to the occupants. The reason for
the wheel being loose was the omission of a cotter pin,
in conjunction with which a loose nut was a criminal
offense. As it turned out no one was hurt, and the only
result was that from now on at least one car owner will
look over and check his entire car, whether the garage
or the manufacturer does the work of putting it in shape.



ECONOMY RATHER THAN SPEED ALONE

As the automobile increased in power and reliability,
its tasks were multiplied for the various tests in which
it was asked to participate. Track racing has become
almost obsolete for the reason that in this form of com-
petition the driving of high-powered cars transgressed
beyond the limits of sanity. While an occasional meet
of this character is held, the number now is meager and
hardly worth any serious attention.

It begins to look as though a similar state of affairs
is shortly to be reached in the matter of speed hill climbs.
Usually, ascents are selected, including dangerous
stretches, the successful covering of which requires the
exercise of the greatest skill on the part of the driver.
In many instances, a victory comes only to the driver
who exhibits the greatest amount of foolhardiness and
luckily escapes without danger to car or harm to self.

Scarcely a roads grade now exists, no matter how
precipitous, throughout the country which cannot be
climbed by a good car properly geared and driven by a
capable operator. Indications are more than marked
that the hill climb is an event that will follow in the trail
of the discarded track meet, for future competition is
certain to trend toward economical operation rather than
demonstrating ability to cover a given course in the short-
est space of time.



THE VETO OF AN AUTOMOBILE BILL

Unquestionably surprised were many New York State
automobilists over the veto of the proposed automobile
law by Governor Hughes, who decided at the eleventh
hour that the proposed Allds-Hamm measure was not
justified even by the necessity of urgent funds for the
upkeep of State roads. There is much well worth the
reading in the veto of this unusual governor, who per-
haps is more of a politician than is generally surmised,
for it looks to those who were aware of the progress of
events as if this chief executive had even revised his own
opinions when he dashed to the ground the hopes of those
who expected that he would approve of the new law.

The Governor is both right and wrong in the reasons
for his veto, and the automobilist, though he dissents in
not a few particulars, will find profitable reading in study-
ing the veto.

HUGHES VETOES PROPOSED NEW YORK LAW

ALBANY, N. Y., May 31—The automobilists of New York State are still pondering over the veto of the Allds-Hamm automobile bill which Governor Hughes last week announced. In a memorandum of considerable length the Governor explained why he had decided to veto the proposed law, stating that even the need of money for the upkeep of State roads did not justify him in approving of a measure which he considered contained enough defects to cause him to withhold his signature.

The New York State Automobile Association and the Automobile Club of America used their best endeavors in securing the passage of the bill in the two branches of the Legislature, and naturally the representatives of these two bodies are inclined to express much astonishment at the unexpected veto, especially in view of the fact that the Governor concerned himself in aiding the passage of the measure by emergency messages when its death seemed imminent through a difference of opinion as to whether the Secretary of States office or the State Highway Commission should handle the registration money.

"The Governor is wrong when he says in his brief that the bill deprives the police authorities of the power to regulate traffic," said Charles Thaddeus Terry, counsel to the American Automobile Association. "It does just the reverse. By remov-

ing the restriction as to the limit of miles per hour, it places in the hands of the police the power to determine whether or not an automobile is being driven in a careless or negligent manner, no matter how fast it is going. It may be going six miles an hour on Broadway and the speed be reckless. It all depends on the surroundings.

"I think the Governor laid too much stress on the opinion of Mayor McClellan that the traffic regulations of the city would be interfered with. The Mayor's fears were groundless. They were gathered from a superficial examination of the provisions of the bill by the city authorities. Caution will become the universal test of speed. It is the law now in Connecticut, Massachusetts, Vermont and Pennsylvania, and will be so in every State."

"The veto is unfortunate," said W. W. Niles, counsel to the Automobile Association of America. "The bill, if it became a law, would have resulted in more stringent traffic regulations so far as automobiles are concerned. It would have given the police greater supervision. I think the Governor's view is wrong."

Herewith will be found the full text of the Governor's announcement of his disapproval of the measure:

STATE OF NEW YORK, EXECUTIVE CHAMBER,

Albany, May 26, 1909.

Memorandum filed with Assembly Bill No. 2,413, entitled "An act to amend the highway law, by repealing Article 11 thereof and inserting a new Article 11, in relation to motor vehicles.

NOT APPROVED.

The study of this measure has convinced me that it would be unwise to enact it into law. It is true that it provides for an increase of the State's revenues, and in view of the amounts we are expending in the improvement of our highways and of the difficulties of maintenance under new uses, the revenue provisions of the bill are important.

But the subject of paramount consideration at this time is protection to life and limb. We are passing through a period of adjustment when the natural hostility of many to new highway conditions is increased by abuse of privilege, and others are chafing under what they regard as vexatious restraints and unjust exactions. Nothing can be more certain than that the use of motor vehicles will largely increase, that the number of accidents will diminish, and that usage and common sense will largely do away with present evils. During this transition period, however, there should be the utmost care in legislation so that matters should not be made worse instead of better. There are many good provisions in this bill, and it has been strongly urged that it should have a trial. But it seems to me better to wait and to secure an improved bill, than to enact a measure as defective as this one appears to be.

The present law provides specific speed limitations of 10 miles an hour where the territory is closely built up, 15 miles an hour elsewhere in a city or village, and 20 miles an hour elsewhere outside of a city or village. In addition, the present law also provides for a reasonable rate of speed in all cases—that is, that no one shall operate a motor vehicle on a public highway "at a rate of speed greater than is reasonable and proper, having regard to the traffic and use of the highway, or so as to endanger the life or limb of any person, or the safety of any property."

This bill abolishes the specific speed limitations, and with certain changes in phraseology with regard to the duty of care, proposes as the sole requirement as to speed, the following:

"Sec. 287. Speed permitted.—Every person operating a motor vehicle on the public highways of this State shall drive the same in a careful and prudent manner and at a rate of speed so as not to endanger the property of another or the life or limb of any person; provided that a rate of speed in excess of 30 miles an hour shall be presumptive evidence of reckless driving."

There is much force in the suggestion that requirements of due care cannot be accurately reflected in arbitrary speed limits. But it must also be remembered that in this field as in others a large number of injuries must inevitably be due to mere accident where negligence cannot be satisfactorily proved. It is public policy in dealing with these matters not simply to see that negligent persons are held to account, but also by reasonable regulation, to diminish the risks of preventable injury. This is sought to be accomplished

by speed restrictions. And it is still an open question whether at this stage in our progress toward the wider use of these vehicles of pleasure and convenience, it is safe to rely simply upon a requirement of care and prudence with all the difficulties that attend actual proof of want of care.

It is certain, however, that whatever may be said as to the wisdom of such a rule with regard to the open country, or in sparsely settled towns, we should not deprive our large cities of the right to make reasonable traffic regulations to insure the safety and convenience of the public.

About one-half of the population of this State is within the City of New York, and the Mayor of that city has sent me a vigorous protest against the provisions of this bill. And whatever else may be said of it, it should not become a law if it takes away from the authorities of New York City that reasonable traffic control without which conditions in the metropolis would be intolerable.

The present motor vehicle law took effect on May 3, 1904. It is true that it prohibited, with certain exceptions, the making of local ordinances. But the next year, 1905, the Legislature amended the Greater New York charter so as to give the police department the right to "regulate, direct, control, restrict and direct the movement of all teams, horses, carts, wagons, automobiles and all other vehicles in streets, bridges, squares, parks and public places for the facilitation of traffic and the convenience of the public as well as the proper protection of human life and health," and to that end authorized the Police Commissioner to make "such rules and regulations for the conduct of vehicular traffic in the use of the public streets, squares and avenues as he may deem necessary." Any prior provisions of law inconsistent with this authority were repealed.

The present bill takes away from the local authorities the power "to pass, enforce or maintain any ordinance, rule or regulation * * * excluding any such owner or chauffeur from the free use of such public highways or in any other way respecting motor vehicles or their speed upon or use of the public highways." It expressly provides that any ordinance, rule or regulation "now in force or hereafter enacted" which is "in any wise inconsistent" with the provisions of the act shall have no effect. The only exceptions are the powers (1) to regulate vehicles offered to the public for hire, (2) to regulate processions, assemblages or parades in the streets or public places, (3) to set aside a specified public highway for speed contests or races, and (4) to exclude motor vehicles from cemeteries.

In short, it would practically abolish municipal traffic regulations as to private motor cars. Any one acquainted with conditions in New York City knows how much of the public convenience and safety is due to the maintenance of proper traffic regulations and must recognize the impropriety of making such regulations impossible in the interest of the free passage of motor cars.

It would also appear that under this bill there would be no power vested in the local authorities to exclude motor trucks or motor vehicles used for commercial purposes from the parks of the city, which are included in the "public highways" as defined in

the bill. It would deprive the local authorities of any power they now possess for this purpose.

These defects are grave enough to compel the disapproval of this bill.

But, it may be added, with regard to the general application of the bill, that the abolition of specific speed limitations and the substitution merely of the rule of due care should carry with it stringent penalties in case of negligent driving. It would seem that the penalties for actually proved negligence should be heavier than those imposed for merely exceeding an arbitrary speed limit.

The penalties provided for in this bill, with respect to violations of speed requirements, are less stringent than those of the present law.

A comparison shows the following results:

For a first offense: Under the present law, a fine not exceeding \$100; under the proposed law, a fine not exceeding \$50.

For a second offense: Under the present law, a fine not less than \$50 nor more than \$100, or imprisonment not exceeding 30 days, or both; under the proposed law, a fine not exceeding \$50, or imprisonment for not exceeding 30 days, or both.

For a third or subsequent offense: Under the present law, a fine of not less than \$100 nor more than \$250, and imprisonment not exceeding 30 days; under the proposed law, a fine of not exceeding \$50 and imprisonment not exceeding 30 days.

It is true that the provisions of the proposed law for maintaining records and distributing information of prior convictions are very useful. But these advantages are more than offset by the inadequacy of other provisions.

The deterrent feature, which is relied upon to secure obedience to the law, is the requirement of an actual imprisonment upon conviction for a third offense. And the importance of maintaining

records of prior convictions is to pave the way for this punishment of the confirmed violator of the law. But the present bill limits the amount of bail which may be taken to \$100. It provides that where the magistrate is without jurisdiction to try the offense, and the defendant "charged with the violation of any provision" of the act is held to answer, the magistrate must admit the defendant to bail upon his giving a surety company bond, or an undertaking, in the sum of \$100, or upon his deposit of a like amount in cash. If records were maintained so that imprisonment were the inevitable consequence of conviction for a third or subsequent offense, such bail in many cases might be wholly inadequate.

It is apparent that careful drivers of motor cars, who have no desire to violate the law, are now held within what they believe to be unjust restrictions and are frequently made the victims of an abuse of legal process. But the remedy for any existing injustice must carry with it appropriate safeguards, and the more that is left to the judgment of the driver, the more important it is that recklessness should be heavily penalized.

The bill contains restrictions upon the use of cars without the consent of their owners, a frequent source of accident. But such a restriction is also contained in a separate bill amending the penal law, and will not be lost by the disapproval of this bill. It would also seem advisable that better means should be provided, with respect to the issuing of licenses, for ensuring the competency of chauffeurs. One of the imperfections of this bill is that the useful provision for the suspension of licenses does not apply to violation of the requirements as to safe speed.

In view of these considerations, other objections to the bill need not be discussed. The bill is disapproved.

(Signed) CHARLES E. HUGHES.

PENNSYLVANIA NEW LAW IN EFFECT EXCEPT LICENSING!

PHILADELPHIA, May 31—That section of the recently enacted Townsend automobile law which continues the method of licensing resident automobilists prescribed by the 1905 act until December 31 next, when it will be superseded by that prescribed in the new law, has bothered all concerned not a little. A careful reading of the new law will show that Section 25 applies only to licensing, and was inserted to save automobilists from the necessity of "coming up double." The remainder of the law went into effect as soon as the Governor attached his signature to the bill.

Even the police officials seemed to be a little hazy in the matter, and a few days ago Wesley Burdett and E. A. Strong, local automobilists, were held by Magistrate Scott until he could

look into the law. They had been apprehended by Motorcycle Policeman Morley, in Chestnut Hill, a suburban section. The "cop" swore they were going at twenty-three miles an hour.

Attorney G. Douglass Bartlett, the Quaker City Motor Club's legal sharp, was put on the job, and when the case came up he asked for the immediate discharge of his clients on the ground that they had broken no law. Bartlett quoted the new law and showed where the policeman had been working under the 1905 law, which had been superseded by that of 1909. After examining the law the magistrate agreed with Mr. Bartlett and discharged the prisoners. The local "cops" are now hard at work amending their painfully acquired arithmetic to meet the demands of the new law.

MORA TALKS FOR FEDERAL LAW

"Automobile regulations may come and go," says S. H. Mora, treasurer of the American Motor Car Manufacturers' Association, "but as the touring season is renewed each year the fact is strongly thrust upon us that no automobile law will ever be satisfactory and just until a national Federal bill is enacted, making one registration number good in all States.

"It is unquestionably unfair that automobilists in the use of the interstate highways should be obliged to submit to the diverse State regulations as to registration and identification when such State requirements result in the imposition of as many different taxes as there are States to pass through.

"Under the present automobile regulations there is a necessity sometimes of procuring new numbers for the car and in some cases adding these numbers to those already in place; in other cases removing all those except the registration number of the particular State through which the tourist is passing at the time; in some States carrying one number, in others two numbers; in some States painting the number on the machine, and in others attaching it to front or rear, or both.

"There is not any question but there should be some system of identification which shall be uniform and at the same time effective. The varying requirements which are now enforced in the various States throughout the country defeat the very object of the State statutes, inasmuch as they result in increased confusion instead of clear identification."

AUTOISTS' METHOD OF WINNING JUDGES

CLEVELAND, May 31—There is a good story on a prominent Cleveland judge going the rounds in this city and its lesson may aid other clubs in winning over members of the judiciary to the side of the automobilists. This judge was recently caught by one of the automobile club members, speeding down Euclid Avenue and was duly reported at the club office. A courteous letter was sent him, stating that he was "violating the laws of Ohio" and requesting that he curb his desire for speeding. Within twenty minutes after the receipt of the communication the bench member appeared at the club rooms with profuse apologies to Secretary Forbes, thanked him for calling his attention to the matter, joined the club and carried away ten application blanks for his friends. "Pinching" judges in this manner is an effective way of bringing to their attention the fact that automobile clubs are doing much to gain respect for the laws.

IS THIS MICHIGAN ORDINANCE A JOKE?

MARSHALL, MICH., May 31—This town of 4,361 inhabitants will probably have an automobile ordinance that will make its watchful residents wealthy at the expense of automobilists. The "city" attorney is compounding a statute which will provide a fine of \$100 for automobile drivers who send their cars over the streets at a rate of more than eight miles an hour, and the informer will receive one-half of the money.

What the Clubs Are Doing These Days

QUAKER CITY'S ARE ON THE INCREASE

PHILADELPHIA, May 24—Twenty-two new members were added to the club's total at last week's meeting of the board of governors of the Quaker City Motor Club, and the officials are now realizing that before many months a waiting list will have to be started. The 200-mile stock chassis race in Fairmount Park next October came up for discussion, and it was decided to limit entries to American-built cars only. The resignation of Max R. Green from the board having left a vacancy, Joseph Keir was appointed in his place, he having polled the greatest number of votes of the candidates who failed of election at the annual meeting. Chairman Bartlett, of the law and ordinance committee, reported that the codification of the new Pennsylvania and New Jersey automobile laws was in the hands of the printer and would be ready for distribution to the members in a few days.

The report of the club's official scout, "Doc" Overpeck, was also read, and the itinerary of the five-day endurance run to Pittsburg and return, June 14-18 next, as decided upon by the pathfinding party, indorsed and ordered to be made public. It shows a total mileage of 750.5 miles for the round trip—412.2 going and 338.3 returning—with overnight stops at Williamsport, Johnstown, Pittsburg, and Lewistown. Quite a number of entries have already been received for the four classes—A, touring cars listed at over \$2,000; B, touring cars, \$2,000 or less; C, runabouts, over \$2,000; D, runabouts, \$2,000 or less.

The club is preparing, as usual, to be well represented at the Wilkes-Barre climb on May 31, fully a score of members having signified their intention of making a three-day trip of it, starting Saturday noon, and reaching home at the same hour Tuesday.

SPRINGFIELD (O.) CLUB ELECTS OFFICERS

SPRINGFIELD, O., May 24—Co-operation with the State automobile department and the good roads work were subjects of interest at the annual meeting of the Springfield Automobile Club held on Thursday evening. The election of officers resulted as follows: President, Frank R. Packham; vice-president, P. E. Montanus; secretary and treasurer, George E. Mentel. These with Benjamin P. Johnson and George R. Prout constitute the board of governors. M. M. Maxwell, secretary of the good roads commission, outlined the work to be attempted by his board with the aid of the automobile clubs and various other associations. The State automobile department was represented by its superintendent, Fred H. Caley, who gave a talk on the work of the department.

COLUMBUS WILL ENTERTAIN ORPHANS

COLUMBUS, O., May 29—The first week in June, set by the A. A. A. for National Orphan's Day, was not convenient to the Columbus Automobile Club, so the date was fixed at June 19. On this day it is expected that 1,800 children rounded up by the Salvation Army and the Volunteers of America will take advantage of the club's hospitality, this number being in excess of last year by 200. More than 200 autoists have pledged themselves or their cars so that success is assured. The start will be made from Broad and High streets early in the morning, the exact hour being set at eight.

BARTHOLOMEW NOW HEADS KENTON CLUB

COLUMBUS, O., May 17—One of the most energetic of the smaller clubs in Ohio is that of Kenton. The annual meeting has just been held and as a result W. E. Bartholomew is now at the helm as president. He is one of the most extensive onion growers in the country and is an enthusiastic automobilist.

TROY CLUB STARTS MEMBERSHIP CAMPAIGN

TROY, N. Y., May 31—It has been estimated that there are about 270 automobile owners in this city, and the Troy Automobile Club has set about to enlist every one of them. This organization, which was formed in 1904 and re-organized in 1908, has about 50 members at present and is active in its work for the improvement of conditions in this locality towards the autoists. At present a set of street regulations are being compiled and it is believed that they will be adopted by the police department. These give definite rules for all vehicles, as to turning, keeping to the right, stopping, etc., much similar to those recently put in force with success in Albany. Orphans' Day will be celebrated on June 2, taking the children to Rensselaer Park for an afternoon, after a parade through the city.

The officers of the club are: President, F. B. Twining; vice-president, E. S. Platt; secretary-treasurer, Alonzo McConihe; board of governors, LeG. C. Cramer, H. S. Ide, John McGlynn, J. J. Murphy, R. C. Reynolds, J. J. Smith, John Squires, Dr. L. R. Whitney, and the other officers.

HARTFORD CLUB IS IN A FIX

HARTFORD, CONN., May 29—Aside from awarding the Maxwell Junior and the Renault a cup each for winning in their respective classes in the recent reliability run, the Contest Committee of the Automobile Club of Hartford is rather up against it. It was proposed that the class trophies be melted up and medals made from the material; then it was suggested that the lucky ones to finish with clean scores draw lots, the winner to take the cup, but this was regarded as a rather unsatisfactory scheme. In all probability cups for classes with several perfect scores will be redeemed and the equivalent in money expended for suitable medals, all of which will be the same. It is rather a coincidence that the best drivers in the run numbered among those who stalled motors. The clean score of the Interstate car has been questioned. On the last lap Mills, the driver, claims he turned his car into the ditch to prevent a collision, thereby damaging the oiling system. This he repaired and the referee awarded him a clean score.

ITHACA CLUB MAKES A GOOD BEGINNING

ITHACA, N. Y., May 29—By holding a very successful banquet and smoker at the Dutch Kitchen, the recently organized Automobile Club showed some signs of life and made a noise like a good beginning. Toastmaster J. M. Clapp presided and brief addresses were made by President Thomas W. Mone, Daniel Rothschild, C. S. Ricker, James A. Causer and others. One fact dwelt upon was that the Ithaca club, while the youngest in the State, has already discounted many of the older organizations in point of membership. The charter officers are, besides the president: Vice-president, Daniel Rothschild; treasurer, E. N. Jackson; secretary, J. A. Causer. These officers, together with R. A. Heggie, D. E. Marsh and C. W. Fletcher, constitute the board of governors.

OGDENSBURG AUTOISTS FORM CLUB

OGDENSBURG, N. Y., May 24—Automobile owners of this city have formed a temporary organization looking to the establishing of an automobile club, and at a recent meeting the following officers were elected: President, Walter G. Kellogg; vice-president, Charles D. Randles; secretary, Thomas H. Lawrence; treasurer, Dr. A. E. Haynen; governors, George R. Malby, Edgar A. Newell, George F. Darrow. There are 51 automobiles in the city, exclusive of those owned by garages.

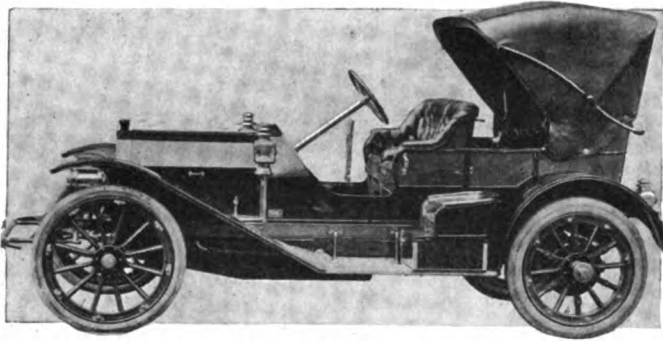

Latest Production of the Moon Motor Car Company

The above photograph just received from the St. Louis factory is of Model C, a new Moon car with baby tonneau, equipped with a Victoria top. In keeping with the others of the Moon line, it is attractive in appearance and will undoubtedly prove a ready seller.

PALACE SHOW TO OPEN NEW YEAR'S EVE

Opening the Grand Central Palace Show of the American Motor Car Manufacturers' Association on New Year's Eve proved so successful last Winter that the show committee, of which R. E. Olds is chairman, has decided definitely on that date as the time for the opening of the "Decennial Show" of 1910. There will be the usual private view in the afternoon of Friday, December 31, 1909, with the formal opening at 8 o'clock on New Year's Eve, after which the show will continue until the following Friday night.

There will be some changes in Grand Central Palace which are expected to supply additional space to care for those exhibitors who could not be provided for at the ninth affair, and it is believed that the Tenth International, or what will be known as "The Decennial Show," will surpass in attendance and sales even the record-breaking affair of last Winter.

BROOKLYN SCIENTISTS LISTEN TO EXPERTS

Automobiles considered from the standpoints of economy, technique and sport were the subject of a series of illustrated lectures before the Brooklyn Institute of Arts and Sciences, at the Academy of Music in that city, on the evening of May 27. The speakers were Herman F. Cuntz, M. E., of the A. L. A. M., who spoke of the economical progress made in the industry; Alexander Churchward, secretary of the Society of Automobile Engineers, who treated the subject from the technical standpoint, and Orel A. Parker, of the Automobile Club of America, who spoke on the subject of the sport in its various phases. The attendance was large and much interest was manifested.

POPE REDEEMS NOTES AHEAD OF TIME

HARTFORD, CONN., May 29—As an evident hallmark of prosperity, it was announced to-day that the Pope Manufacturing Company, of this city, has issued a notice to noteholders that the rest of the outstanding paper will be taken up on July 1. These are the first and second issues, the third having been redeemed on January 1 last, two years and five months before maturity. A similar policy of early redemption has been pursued with the others, and they will be paid thirteen months and one month, respectively, before due. The resumption of the immense Pope business of several years ago has made this possible.

ELECTRIC VEHICLE CO. MAY LOSE RECEIVER

HARTFORD, CONN., May 29—Business has been so good lately that it is now stated on good authority that the complete reorganization of the E. V. Company will soon take place. Nearly all of the claims have been settled and the controlling interests will be able to start with a clean slate. The local interests welcome the good news and hope to see the deal consummated early.

THE DINNER TO CARLTON R. MABLEY

One of the real veterans of the automobile trade, Carlton R. Mabley, was the guest of honor at the dinner of the Fairweather Club, held at Reisenweber's, New York City, Wednesday evening, May 26. H. L. Humphries, of the automobile department of the New York *Evening Post*, was responsible for the successful recognition of Mr. Mabley as one of the prominent early factors in blazing the auto trail in the metropolis. The firm of Smith & Mabley had an international reputation, due principally to the efforts of the guest of the occasion, who accepted the encomiums thrown at him from all directions with characteristic modesty.

Peter Fogarty, as toastmaster, contributed Milesian wit in his introductory remarks for the various speakers. The list included H. L. Bridgman, hero of Arctic explorations, and C. F. Wyckoff, who accompanied him on one occasion; Creswell McLaughlin, the well-known "Schoolmaster of Cornwall-on-the-Hudson"; Winthrop S. Scarritt, well supplied with word pyrotechnics; Herman F. Cuntz, with an interesting story on roads building; Henry M. Duncan, whose rhythmic conversation flowed easily, and A. G. Batchelder.

The notables present included W. W. Burke, president of the Fairweather Club; Alfred Reeves, Coker F. Clarkson, Harry Fosdick, Louis R. Smith, W. T. Berrien, E. S. Partridge, A. J. Pickard, J. H. Gerrie, James C. Nichols, C. L. Simmond, H. T. Adams, C. W. Wurster, J. M. Lansden, William and Harry Knipper, L. C. Van Bever, E. H. Kidder, George S. Simpson, N. E. Neswold and M. J. Sullivan. Many absentees sent regrets, and their letters and a few marconigrams were read.

NEW TRUCK COMPANY GETS GOOD START

WORCESTER, MASS., May 29—A charter has just been granted to the R. L. Morgan Company, of this city, to manufacture motor trucks. Realizing the immense field which is only beginning to open up for motor-driven trucks, this company will start right in to build a good machine and build them in large numbers. About seventy-five men will constitute the working force at the start, which will be made in the large three-story brick building formerly occupied by the Crompton-Thayer loom works. Beginning with a large number of orders on hand, the production will be rapidly increased until the yearly production reaches 500. Back of the new enterprise are such sterling men as Ralph L. Morgan, the designer of the truck; Henry E. Whitcomb, director of the Merchants' National Bank; F. B. Durfee, treasurer of a local building company, and others. Mr. Morgan will be president, Mr. Whitcomb treasurer and manager, while Mr. Durfee will act as vice-president. The shop will be under John R. Back, with the F. E. Reed Company for thirty years.

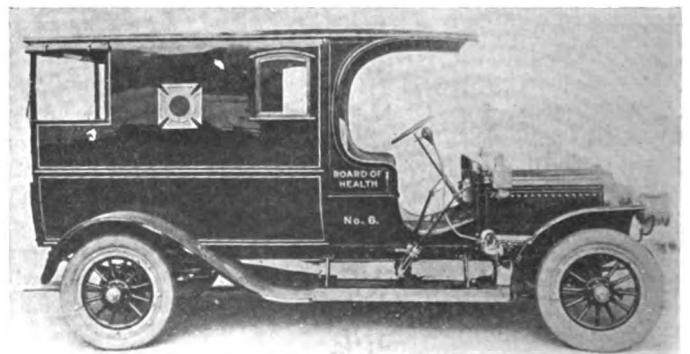

Maxwell Ambulance Built for City of Newark

The photograph shows the new ambulance delivered to the City of Newark, N. J., by the Maxwell-Briscoe Motor Company. The wheelbase is 126 inches, and the body is seven feet in length, three feet wide, and the furnishings include stretcher, medicine chest, speaking tubes, and side seats which fold up when not in use. The inside of the vehicle is padded and electric lights are arranged for the convenience of the surgeon.



Stearns Cars Carrying Crippled Orphans to Coney Island

The line-up of twenty-five Stearns machines in front of the Crescent Athletic Club House, Brooklyn, where the crippled children from the Free Industrial School of New York were taken for lunch just previous to the pleasure trip to Coney Island.

New Factory for Rutenber Engine Makers—The Western Motor Company, of Logansport, Ind., is building an additional factory at Marion, Ind., which, with the present one, will be supplied with castings from the foundries in Logansport. The new structure will be built of reinforced concrete, two stories high, 450 feet long and 66 feet wide. Machine shops will occupy the second floor, and assembling rooms, testing department and offices will be located upon the first. The 60,000 square feet of floor space thus obtained will be devoted entirely to the manufacture of gasoline motors of the Rutenber four-cylinder type and will materially increase the output of the company. It will be ready to start operations early in September.

Ferro Engines Outgrow Big Plant—Finding that an output of thirty engines a day is insufficient to fill orders, the Ferro Machine & Foundry Company has been obliged to add to its immense factory in Cleveland, claimed to be already the largest marine engine plant in the world. A three-story machine shop is now being erected, covering an area of 140 by 160 feet, and will be one of the most completely equipped in the country. Latest modern machinery and tools will be installed, including individual electric drives. A dining-room 40 by 140 feet in size is being built for the use of the employees, and a basement 80 by 140 feet will be fitted up as a store.

Velie Increases Factory—Operations have been commenced by the Velie Motor Vehicle Company, of Moline, Ill., upon addition to its factory. The new structure will measure 80 by 220 feet in size, with four stories and a basement, of reinforced concrete, and will cost about \$100,000. Another story will also be added to the present plant, so that the whole will harmonize, for the new section will form a wing of the old one. An output of ten cars a day is now that of the factory, employing over one hundred men, and it is stated that orders are being received faster than filled.

Republic Tire Output Increased—Staggard tread tires, made by the Re-

public Rubber Company, in Youngstown, O., have been in such great demand of late, according to the company officials, that the force has had to be doubled and a large night shift employed in order to supply the demand. The Staggard tread has become a feature of the Republic output, for the rubber protuberances act as skidding preventatives, while at the same time are large enough to make the tire good in dry weather also.

Bids Asked for Autos to Carry Mail—So successful has been the test of automobiles in New York mail service that Postmaster Morgan has asked that the service be increased, and the Government has asked for bids for automobiles. These will be received by the Postoffice Department in Washington, and are to cover a period from July 1, 1909, to June 30, 1913. Lines are expected to be established in the uptown districts to carry mail to stations which have pneumatic tube connection with Grand Central and the general postoffice.

Fisks on Winners at Yale Hill Climb—Fisk tires and Fisk removable rims scored in the recent hill climb of the Yale Automobile Club, on the Shingle hill at New Haven, Conn. The Knox cars, which were driven by William Bourque and Albert Dennison, carried Fisk equipment and they made the fastest time of any American cars and won in their classes.

IN AND ABOUT THE AGENCIES

Interstate, Chicago—The Interstate Motor Car Company, which has filed papers for its incorporation, will handle the product of the Interstate Automobile Company, of Muncie, Ind., in the Windy City. Temporary quarters have been engaged by E. C. Lester, who is in charge, at 1328 Michigan avenue, but a long-term lease has been closed for property at 2425 Michigan avenue, and as soon as this is cleared a three-story building will be erected. The move of the Interstate to that section of automobile row, south of Sixteenth street, will take it into the proximity of the new homes of

the Locomobile, Stearns, Premier, Packard and others. The building will be 161 feet deep and 25 wide, with the front for use as a salesroom, while the rear will be for a garage, and additional salesrooms and offices will be placed upon the second floor. The third will be used for equipment and shop departments.

Hoyt Electrical Instrument Works, New York—Additional space has been found necessary by the New York office of the Hoyt Electrical Instrument Works, of Penacook, N. H., and it will be moved on June 1 from 1931 Broadway to 136 Liberty street.

RECENT BUSINESS CHANGES

American Oil Engine Company May Move—It is believed in Poughkeepsie, N. Y., that the Adriance building on North Water street will be taken over by the American Oil Engine Company, now located in Connecticut. The negotiations are being made through the Chamber of Commerce. The concern manufactures stationary, marine and automobile engines in which kerosene is used as fuel.

Automobile Maintenance Company Changes Name—The Automobile Maintenance Company of Chicago has changed its name to the Automobile Maintenance and Manufacturing Company, with a capital of \$25,000.

Homer Auto Truck Company Changes Name—The Homer Auto Truck Company of Lansing, Mich., announces the change of its name to the Homer Gas Engine Company, with a capital stock of \$25,000.

CAMERON CO. CONSOLIDATION

BEVERLY, MASS., June 1—The Cameron Motor Company, organized last fall with New York capital to control the output of Cameron cars from the factories at Beverly, Mass., and New London, Conn., has been absorbed by the old company. The capital of the Cameron Car Co. of Beverly, Mass., has been increased to \$500,000 and the affairs of the enlarged organization will be handled by E. S. Cameron, general manager; W. T. Marsh, treasurer, and H. W. Doherty, sales manager.

All four-cylinder models will be built in the Beverly plant; the sixes in New London; and by the acquisition of W. T. Marsh, who is the controlling factor in the American Motor Co. of Brockton, Mass., manufacturers of motorcycles, Cameron gains the assistance of a third plant, where larger quantities of smaller parts will be manufactured.

Arrangements are being completed for an output of 5,000 cars between September 1, 1909, and July 1, 1910.

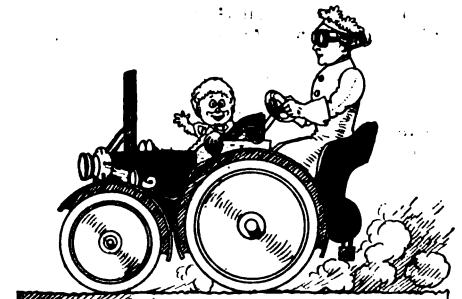

If we must have lady chauffeurs, what's the matter with this?—From "The Auto Era," published by the Winton Motor Carriage Company, Cleveland, O.

PERSONAL TRADE MENTION

E. Mack Morris has accepted a position as general manager of the Model Automobile Company, of Peru, Ind., manufacturers of Great Western cars. Mr. Morris has been connected with the sales force of the E-M-F Company until recently, and previous to the formation of that concern was assistant secretary of the Northern Motor Car Company. As



E. Mack Morris

general manager of the Model Company he contemplates the building of 1,500 cars during the coming season. Mr. Morris succeeds E. A. Myers, who is general manager of the gas engine works and who found his double duties too great to give both proper attention.

F. H. Fowler, well known in New England automobile sales circles, has joined the forces of the Siro Carbureter Manufacturing Company, of Springfield, Mass., as general salesman.

Alexander Schwalbach has joined the forces of the J. S. Bretz Company of New York, as advertising manager. Mr. Schwalbach until recently has been associated with W. J. Morgan.

W. G. Jennings has been appointed manager of the Detroit branch of the Diamond Rubber Company, located at 265 Jefferson avenue.

TAXICABS AND TRANSIT

Savannah, Ga.—The Savannah Taxicab Company has been organized and incorporated with a capital of \$50,000 to operate taxicabs in this city. The first shipment will consist of fifty cabs, and this number will later be increased by another fifty, the first being scheduled to arrive within a couple of weeks.

NEW AGENCIES ESTABLISHED

Frayer-Miller: Cleveland—Auto Truck Sales Company, distributing to 17 adjacent counties, 225-227 Williamson building.

Royal Tourist: Houston, Tex.—Palace Automobile Company, Louisiana and Rusk streets.

Autocar: Chicago—Louis Gayler Company, 1532-4 Michigan avenue, with the Stevens-Duryea.

Interstate: San Francisco, Cal.—Burkett & Crippens, 550 Golden Gate avenue.

Unito: Cleveland—Auto Sales Company, in addition to the Hupmobile.

RECENT INCORPORATIONS

Cabell-Lincoln Rapid Transit Company, Huntington, W. Va.—Capital \$10,000. To operate automobiles for transfer purposes. Incorporators: S. G. Griffith, L. H. Cammack, S. H. Bowman, H. S. Bryer, J. T. Calbert.

Automobile Wheel Company, Richmond, Va.—Capital \$500,000. To manufacture automobile wheels. President, R. McC. Bullington; vice-president, D. A. Bottom; secretary and treasurer, A. E. Holdt.

Eastern Pneumatic Tire Company, Boston.—Capital \$25,000. To deal in pneumatic tires. President, A. R. Ellis; vice-president,

H. N. Atwood; treasurer, John McLay; clerk and attorney, R. F. Wight.

Newcomb Engine Company, Harrison, N. Y.—Capital \$200,000. To manufacture motors, automobiles, engines, motor boats, etc. Incorporators: W. B. Thompson, O. A. Hack, E. C. Chamberlain.

Buckeye Machine Company, Dayton, O.—Capital \$10,000. To deal in automobiles, athletic goods, etc. Incorporators: M. C. Gath, P. D. Gath, E. L. Kincaid, W. V. Crowe, N. G. McCartney.

Atlantic Automobile Company, Atlantic City, N. J.—Capital \$25,000. General automobile and garage business. Incorporators: C. E. Schroeder, G. W. Meredith, F. A. Broadhead.

Cooke, Fitz & Dillingham Company, Portland, Me.—Capital \$25,000. To manufacture and sell automobiles. President, C. E. Eaton; treasurer, T. L. Croteau; clerk, J. E. Manter.

Auto-Tri Manufacturing Company, Buffalo.—Capital \$200,000. To manufacture, repair, rent, and sell automobiles. Incorporators: G. R. Bidwell, W. S. Bull, W. M. Bowen.

Oeson Automobile Company, New York.—Capital \$10,000. To manufacture automobiles, parts and accessories. Incorporators: H. M. Kilborn, W. E. Matterson, Richard Sutro.

Fulton-Zinke Company, Chicago—Capital, \$50,000. Manufacturers' agents for automobiles and accessories. Incorporators: A. W. McGovern, F. C. Rathje, H. C. Calhoun.

Plainfield Auto Sales Company, Plainfield, N. J.—Capital \$25,000. To deal in automobiles and supplies. Incorporators: Dr. S. A. Aldrich, C. C. Brown, C. C. Rocap.

Touring Club of America, Hackensack, N. J.—Capital \$10,000. To publish information for automobilists. Incorporators: G. L. Burlew, A. L. Westgard, R. S. Finney.

Economy Motor Buggy Company, Joliet, Ill.—Capital \$60,000. To manufacture and deal in automobiles. Incorporators: J. F. Beuret, H. L. Thompson, J. C. Flowers.

Rutherford Transit Company, Rutherford, N. J.—Capital \$20,000. To operate an auto stage line. Incorporators: William Black, C. R. Soley, J. M. Bell.

Rae Electric Vehicle Company, New York City—Capital \$150,000. To manufacture and deal in motor vehicles of all kinds. Delaware corporation.

Yonkers Auto Station, Elmsford, N. Y.—Capital \$10,000. To maintain a garage. Incorporators: A. S. Thomson, David Scotland, F. T. Lewis.

Phineas Jones & Company, Newark, N. J.—Capital \$100,000. To manufacture wheels, hubs, and tires. Incorporators: H. P. Jones, P. Jones.

Lowell Taxicab Company, Lowell, Mass.—Capital \$10,000. To do a general automobile business. Incorporators: F. E. Haines, F. B. Emerson.

Polk-McKinney Automobile Company, Little Rock, Ark.—Capital \$10,000. Incorporators: Eugene Polk, Roy McKinney, Roy W. Martin.

No-Shaming Company, Cleveland.—Capital \$10,000. To deal in automobile supplies and specialties. Incorporators: L. Daniel and others.

Terre Haute Automobile Company, Terre Haute, Ind.—Capital increased from \$10,000 to \$30,000. President, Fred B. Smith.

RECENT PUBLICATIONS

Ross Gear & Tool Company, Lafayette, Ind.—Steering gears for touring cars, trucks, roadsters, runabouts, motor boats and motor buggies, and rear axles for delivery wagons and motor buggies, made by the Ross Gear & Tool Company, Lafayette, Ind., are illustrated in the new catalogue issued by this concern. Four types of steering gears are manufactured, one for use on three and five-ton trucks, weighing 80 pounds; one for trucks of one and one and a half tons' capacity, weighing 38 pounds; practically the same one as the latter for use on heavy runabouts and touring cars; and the fourth for use on light delivery wagons, runabouts, and motor buggies. Features of the Ross gears are their large bearing surfaces, elimination of points, lines, and small surfaces of contact. They are oil tight and dust proof. The rear axle assemblies are made with spiral gears which will coast as easily as ordinary bevel gears or chains. The sets of ball bearings are used and the differential is of the bevel gear type. A specialty is made of cutting bevel gears.

S. F. Bowser & Co., Fort Wayne, Ind.—Under the interesting title of "The Law's Demand," S. F. Bowser & Company are sending out a little book of eight pages descriptive of the storage gasoline outfits made by them. Outfit No. 41 describes the long distance arrangement with tank underground and pump in the building. No. 47, on the same style, is for smaller places such as private garages. Nos. 45 and 46 are self-contained and are designed to be buried alongside of the driveway or near temporary residents. The latest product is the cabinet in which is combined the business end of both the gasoline and oil storage outfits. This is a handsome cabinet, arranged in any desired finish and gives to the garage those finishing touches which only equipment and furniture of beauty and refinement can give. The title of the book comes from the fact that nearly all of the larger cities have very rigid laws against the surface storage of gasoline on any other method than underground storage.

W. H. McIntyre Company, Auburn, Ind.—The advance sheets of this firm's 1909 catalogue show that by the addition of Model 200 express wagon, the line of high-wheeled cars is complete. It includes buggies, surreys, limousines, runabouts, one, two and three-seated pleasure vehicles, express wagons, mail wagons, open and covered delivery wagons and others. The power varies according to the nature of the car and the work to be done; two-cylinder 10-horsepower up to four-cylinder 28-horsepower, all air-cooled. The new Model 200 has a two-cylinder 4 1/2 x 4 1/2 air-cooled motor, rated at 16-18, 100-inch wheel-base, two spread planetary transmission, double chain drive, 38-inch wheels with 1 1/2 solid tires, and weighs 1,800 pounds.

Williams Foundry & Machine Company, Akron, O.—Akron clutches for factory line shafts and power transmission machinery are described in a 28-page catalog published by the Williams Foundry & Machine Company, illustrating the use of friction disc couplings. The advantages accruing from their use, such as separation of the various parts of the shafting for repairs, or when not in use, without disturbing the other departments of a plant, are explained at length. Nineteen sizes are made, with capacities of from 1/2 to 1,000-horsepower at 100 r.p.m. Compression grease cups are also made.



Grabowsky Power Wagon Delivers Lorain Hose Cart Over Roads

New uses are continually being found for commercial motor-driven vehicles, and one of the latest is the delivery of fire apparatus over the roads from the makers in one city to the users in some other. In this case a Grabowsky power wagon pulled a hose cart from Cleveland to Lorain, O., a distance of 30 miles, over very rough roads. There were no delays, and the time was but a few hours, which is slight as compared with the time it would have taken horses to do the same work.

Information for Auto Users

Michelin Plastic Cement—There may be other parts of the car which get more attention than the tires, but there is no other part which deserves as much of the autoist's attention. Thus, the owner and driver should watch his tubes and shoes, the latter for cuts caused by glass or pointed stones, the former for signs of injury due to punctures or other causes. These places in the fabric should receive immediate attention, and in this way dirt or moisture is prevented from working into the ragged openings, where it can do the maximum amount of damage. A very satisfactory preparation for effecting permanent repairs in all makes of tires is the new cement, Michelin Mastic, made by the Michelin Tire Company, with an American factory located at Milltown, N. J. This is not a liquid, but a plastic cement, and is put up in one and two-ounce cans. Its use is economical, as a very small quantity is required at any one time, nor does it deteriorate with age. Its use is simplicity itself, and with the instructions furnished by the makers the veriest novice can preserve his tires with it. It is equally serviceable for repairing punctures along the roadside.



MICHELIN CEMENT.

cup, but the positive locking device is given preference over all of the others because of the much greater demand for this very superior form.

Bosch Steering Wheel Switch—Many an automobilist has wished for an easily applied steering wheel switch of the push-button type, and now this may be had in such shape as to permit of its attachment to any steering wheel, and so plain as to allow of the work being done by any one. It may be used for opening or closing the ignition circuit for starting and stopping the motor, or for use with an electric signalling horn. It consists of a nickel-plated body and a head of hard fiber. The body is provided with one flange and a thread, upon which another flange in the form of a nut provides a variable means of fastening the device to the wheel. The internal construction is such that it may be placed with the button head either above or below the spokes of the wheel, as desired. It is made and marketed by the Bosch Magneto Company, which has its main American headquarters at 225 West Forty-sixth street, New York City.

Novel Form of Controlling Mechanism—With the view of supplanting the usual rod and rocker connections for controlling the throttle, spark or auxiliary air valve on automobiles, motorcycles and motor boats, and of saving time in the installation of control devices when assembling, the Bowden wire mechanism was first introduced, and its popularity and suitability for such purposes is shown by its widespread adoption in Europe at the present time.

The mechanism consists of but two parts, a closely coiled and practically incompressible spiral wire, constituting what is termed the "outer member," and a practically inextensible wire cable threaded through the above and termed the "inner member." The operation of the mechanism is as follows: Imagine two points, one where there is an object to be moved and the other where the necessary power is to be applied. In the sketch DDD is a length of the mechanism sufficient to extend from the one point to the other around any intervening corners or obstacles. At CC the inner member is seen emerging from the outer member and attached at one end to the actuating lever, A, and at the other to the object to be

moved, B. The outer member is anchored at GG, which anchoring points may be placed wherever convenient. If the lever, A, is now operated, the movement is at once imparted to the other end of the inner member, the outer member exhibiting a wriggling movement at the curves as the inner member attempts to straighten out and is prevented from doing so by the outer member, which cannot shorten, at is is anchored at both ends. The dotted lines show the lever A in its actuated position and the object B correspondingly raised. Adjustable stops, EE, are provided, the extension or screwing out of which is equivalent to lengthening the outer member, thus compensating for any settling or "bedding down" of the inner. These stops are held in position by lock nuts, FF. The sketch shows the form most in use, a pull being obtained in this arrangement. If a pushing motion is desired the inner member is anchored and the outer member attached to the lever, while if neither member is anchored, but both are fixed relatively to each other, when one pulls the other pushes and a relative displacement is thereby readily obtained.

The wire is made in a number of styles of finish to correspond with the plating on the car and for either external or internal use. Various controlling levers, brakes and attachments for use with the mechanism are also manufactured. The Bowden wire output is controlled by the J. S. Bretz Company, of New York City, which has the sole selling rights for America.

The Autoist's Old and Good Friend—Probably the first automobilists used in their gear cases the same lubricant that is so widely used now, Albany Grease. This is made by Adam Cook's Sons, New York City, and the distinctive trademark of the boy sliding down the plank is perhaps as well and thoroughly known as any one part or accessory entering into the construction of the whole car. This old-established lubricant is now made in no less than seven densities, for as many purposes. These are both numbered and lettered, according to advancing density, from 0 to 3 and X to XXX. The grease may be had in one, five, ten, twenty-five and fifty-pound cans, as well as kegs containing 125 pounds. As it is impossible to churn or agitate this product so as to cause it to lose its density, it is asserted that the use of it is a source of marked economy. With the increase in the already large number of places on an automobile which are lubricated, an old standby in lubrication like this is widely appreciated.

Tucker Self-Locking Grease Cup—As the use of compression grease cups increases, being now used on practically every part of the car not supplied from a lubricator lead, more thought is being given to the design and construction of these simple lubricating devices. One of the newest ideas is a profanity saver, all right, for a grease cup without a cap is worthless, and the loss of caps is a frequent happening. The cups now being marketed by the firm of W. W. & C. F. Tucker, Hartford, Conn., have a simple locking device, which prevents these losses. The lock is placed on top of the ordinary cup in the handiest possible position. To unlock it all that is necessary is to push the small additional top part downward and turn to the right, which turn locks it open. After filling the reverse operation suffices to lock it in the closed position. Tuckers make a number of other styles of grease and oil



TUCKER SELF-LOCKING GREASE CUP.

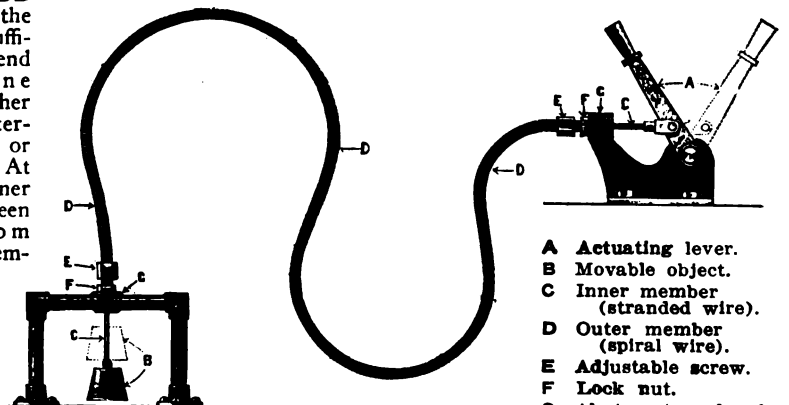

DETAILS OF THE BOWDEN WIRE MECHANISM.

INDEX TO ADVERTISERS

Table listing various companies and their page numbers, including Abendroth & Root Mfg. Co., Acetylene Gas Illuminating Co., Adams Co., Ajax-Grieb Rubber Co., Allen Auto Specialty Co., American Ball Bearing Co., American Belting & Tanning Co., American Carburetor & Imp. Co., American Motor Car Co., American Motor Truck Co., Apple Electric Co., Ashton Valve Co., Asphalt Ready Roofing Co., Atwater-Kent Mfg. Works, Audel, Theo., Austin Automobile Co., Austro-American Separator Co., Autocar Co., Automobile Trade Directory, Auto Car Mfg. Co., Auto & Supply Mfg. Co., Automobile Blue Book, Bacon & Fynney, Baker Mfg. Co., Baldwin Chain & Mfg. Co., Banker Windshied Co., Barnrd-Johnson Auto Supply Co., Barrett Mfg. Co., Bartholomew Co., Beaver Mfg. Co., Belfuss Motor Co., Berry, A. Hall, Billings & Spencer Co., Bi-Cal-Ky Auxillary Spring Co., Bi-Motor Equipment Co., Black Mfg. Co., Bongartz Co., Borbein Auto Co., Borne Scrymser Co., Boston Auto Gage Co., Boston Y. M. C. A., Bowser & Co., S. F., Boyle & Co., John., Brennan Motor Co., Bretz, J. S., Brown Co., Brown & Co., S. N., Brownell Motor Co., F. A., Brush Kunabout Co., Buckeye Jack Mfg. Co., Buckeye Mfg. Co., Buffalo Specialty Co., Buob & Scheu, Burnett-Compound-Spring Co., Burrowes & Co., E. T., Cadillac Motor Car Co., Cameron Car Co., Canton Drop Forging & Mfg. Co., Carpenter Co., W. D., Carr, F. S., Central Engraving Co., Chadwick Engineering Works, Chandlee & Chandlee, Clark Carriage Co., Cleanola Co., Cleveland-Canton Spring Co., Coates Clipper Mfg. Co., Colgan Co., J. W., Collins & Son, G. A., Columbia Lubricants Co., Conn. Tel. & Electric Co., Continental Caoutchouc Co., Continental Motor Mfg. Co., Corbin Motor Vehicle Corp., Cornish Friedberg Motor Co., Couch & Seeley Co., Covert Motor Vehicle Co., Cullman Wheel Co., Cutter, G. A., Dayton Motor Car Co., Dayton Rubber Mfg. Co., De Luxe Motor Car Co., Detroit & Cleveland Nav. Co., Diamond Chain & Mfg. Co., Diamond Rubber Co., Dietz Co., R. E., Dixon Crucible Co., Joseph, Dow Tire Co., Driggs-Seabury Ordnance Corp., Duplex Co., Duplex Coil Co., Eclipse Machine Co., Edmund & Jones Mfg. Co., Eldredge Electric Mfg. Co., Empire Tire Co., Everett-Metzger-Flanders Co., Excelsior Supply Co., Excelsior Tire Co., Fedders Mfg. Co., Firestone Tire & Rubber Co., Fish, Geo. L., Fisk Rubber Co., Flentje, Ernst, Fort Pitt Motor Car Co., Franklin Mfg. Co., H. H., Fried-Ostermann Co., Gaeth Automobile Co., Geerless Motor Car Co., General Accumulator & Battery Co., Gilbert Mfg. Co., Goodrich Co., B. F., Goodyear Tire & Rubber Co., Gordon Automobile Supply Co., Grabowsky Power Wagon Co., Gramm-Logan Motor Car Co., Grand Rapids Spring Co., Graves & Congdon Co., Gray & Davis, Grossman Co., Emil, Groul Automobile Co., Guide Motor Lamp Co., Ham Mfg. Co., C. T., Hansen Mfg. Co., O. C., Hardy Co., R. E., Harris Oil Co., Hart-Kraft Motor Co., Hartford Suspension Co., Haynes Automobile Co., Heinze Electric Co., Hemmeter Spark Plug Co., Hercules Electric Co., Herschell-Spillman Co., Hertz & Co., Hess-Bright Co., Hill Dryer Co., Hoffecker Co., Hoffman, Geo. W., Holtzer-Cabot Electric Co., Hopewell Bros., Hotel Gibson House, Hotel Woodstock, Hoyt Electrical Ins. Works, Indestructible Steel Wheel Co., Interstate Automobile Co., Jackson Automobile Co., Jacobson Machine Mfg. Co., Jeffrey & Co., Thomas B., Jewell Motor Car Co., Johnson Sporting Goods Co., I., K.-W. Ignition Co., Karl Co., Adolph, Kellogg Mfg. Co., Kellom & Co., Chas. F., Kemizite, Keystone Lubricating Co., Kimball Tire Case Co., Kinsey Mfg. Co., Kissell Motor Car Co., Knox Auto Co., Kokomo Electric Co., Konigslow, Otto, Lansing Wheelbarrow Co., Lavalette & Co., Leather Tire Goods Co., Lehman Mfg. Co., J. H., Leland Co., W. H., Levy, Manasseh, Lexington Motor Car Co., Lex Publishing Co., Lipman Mfg. Co., Lobec Pump & Machinery Co., Locomobile Co. of America, Long Arm System Co., Long Mfg. Co., Loring Auto Appliance Co., Lucas & Co., John., M. & E. Mfg. Co., Masury & Son, John W., Mathewson Automobile Co., Maxwell-Briscoe Motor Co., Mayo Radiator Co., Merrill Mfg. Co., Metz, Chas. H., Mica Core Mfg. Co., Michellin Tire Co., Midland Motor Co., Miller, Chas. E., Mitchell Motor Car Co., Model Automobile Co., Moline Automobile Co., Moon Motor Car Co., Mora Motor Car Co., Morgan & Wright, Mosler & Co., A. R., Moss Photo Engraving Co., Motor Car Equip. Co., Motz Clincher Tire & Rub. Co., Muttys Co., L. J., Myers Auto Top Co., N. Y. Sporting Goods Co., National Brake & Clutch Co., National Motor Vehicle Co., National Welding & Mfg. Co., Neustadt Auto & Supply Co., New Departure Mfg. Co., New York Auto Lamp Co., New York Gear Works, Nicola Building Co., Nightingale Whistle Mfg. Co., Nonkoroda Co., Nordyke & Marmon Co., Nuttall Co., F. D., Olds Motor Works, Omar Motor Co., Orange Machine & Mfg. Co., Overland Automobile Co., Owen & Co., R. M., Packard Electric Co., Packard Motor Car Co., Palmer & Singer Mfg. Co., Pantasote Co., Parish & Bingham, Parker Mfg. Co., Parker, Stearns & Co., Peerless Motor Car Co., Peerless Specialty Co., Pennsylvania Auto Motor Co., Perfection Non-Skid Climber Co., Perfection Spring Co., Petre Carburetor Co., Petrel Motor Car Co., Peugeot Freres, Pitzer & Stone, Pittsfield Spark Coil Co., Premier Motor Mfg. Co., Prest-O-Lite Co., Prosser & Sons, Thos., Puritan Gas Tank Co., Quincy-Manchester-Sargent Co., Raimes & Co., Rajah Auto Supply Co., Remy Electric Co., Republic Rubber Co., Rex Mfg. Co., Rex Wrench Co., Reynolds, Harry H., Robert Instrument Co., Rome-Turney Radiator Co., Royal Equipment Co., Rushmore Dynamo Works, S. M. Supplies Co., Salisbury Wheel & Mfg. Co., Safety Device Co., Schenectady Spark Plug Co., Schrader's Sons, A., Schubert Bros. Gear Co., Selden Motor Vehicle Co., Shaler Co., C. A., Sireno Co., Skinner & Skinner, Smith Co., A. O., Smith Mfg. Co., I. J., Spacke Machine Co., F. W., Spare Motor Wheel of America, Speed Changing Pulley Co., Speedwell Motor Car Co., Spicer Universal Joint Mfg. Co., Spiltdorf, C. F., Sprague Umbrella Co., Standard Co., Standard Connecting Rod Co., Standard Roller Bearing Co., Standard Sales Co., Standard Sheet Metal Co., Standard Welding Co., Stanley & Patterson, Star Speedometer Co., Stearns Co., F. B., Stein Double Cushion Tire Co., Stevens-Duryea Co., Stewart & Clark Mfg. Co., St. Louis Supplementary Spiral Spring Co., Stromberg Motor Device Co., Studebaker Automobile Co., Stuehert Clincher Tire & Rubber Co., Syracuse Alum. & Bronze Co., Syracuse Chemical Fire Extinguisher Co., Thomas Motor Co., E. R., Timken Roller Bearing Axle Co., Tiresele Mfg. Co., Tray Plate Battery Co., Trenton Rubber Mfg. Co., Trimont Mfg. Co., Tucker, C. F., U. S. Fastener Co., Uncas Specialty Co., Underwood Typewriter Co., Universal Tire Protector Co., Vacuum Oil Co., Veeder Mfg. Co., Vehicle Specialty Corporation, Velle Motor Vehicle Co., Victor Tire Traction Co., W. D. Spring Cushion Tire Co., Warner Instrument Co., Weed Chain Tire Grip, Weston Elec. Instrument Co., Wheeler & Schebler, White Co., Whitlock Coil Pipe Co., Whitney Mfg. Co., Widmer Machine Works, C. A., Willard Storage Battery Co., Willett Engine & Carburetor Co., Winship, W. W., Winton Motor Carriage Co., Witherbee Igniter Co., Wyman & Gordon Co., York Motor Car Co.

Advertisement for J. W. Colgan Co. featuring various automobile brands like Mitchell, Emore, Maxwell, ORBIN, The Glide, Cadillac, Rambler, National, Acme, Columbia, Haynes, and Pullman. The text includes 'MONOGRAMS AND NAME PLATES', 'ALL STYLES', 'ALL SIZES', and 'SUDBURY BUILDING - BOSTON, MASS.'.

THE AUTOMOBILE



A Car Named Riley

IRELAND'S RELIABILITY TRIALS

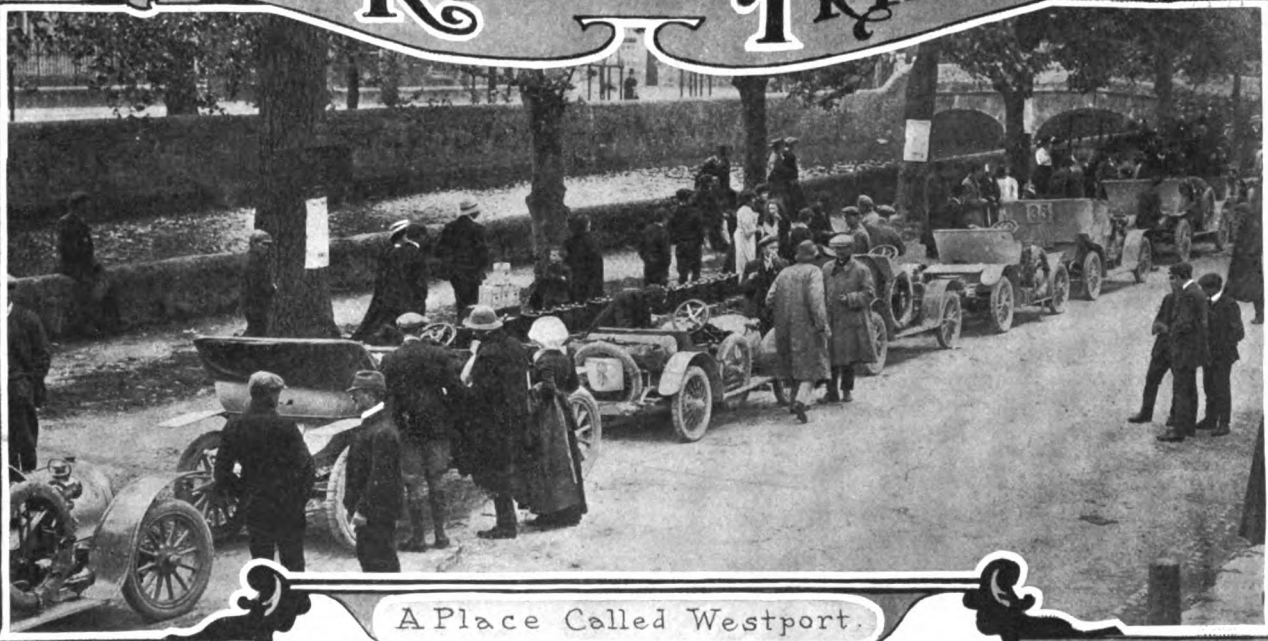

A Place Called Westport.

DUBLIN, May 23—Nigh onto a thousand miles of the hardest roads, steepest hills, and most beautiful scenery of Ireland, famous for all three, constituted the task set the fifty and odd starters in the Irish reliability trials, which started on May 26 and continued excepting Sunday, May 30, until June 1. In this week

Ernest

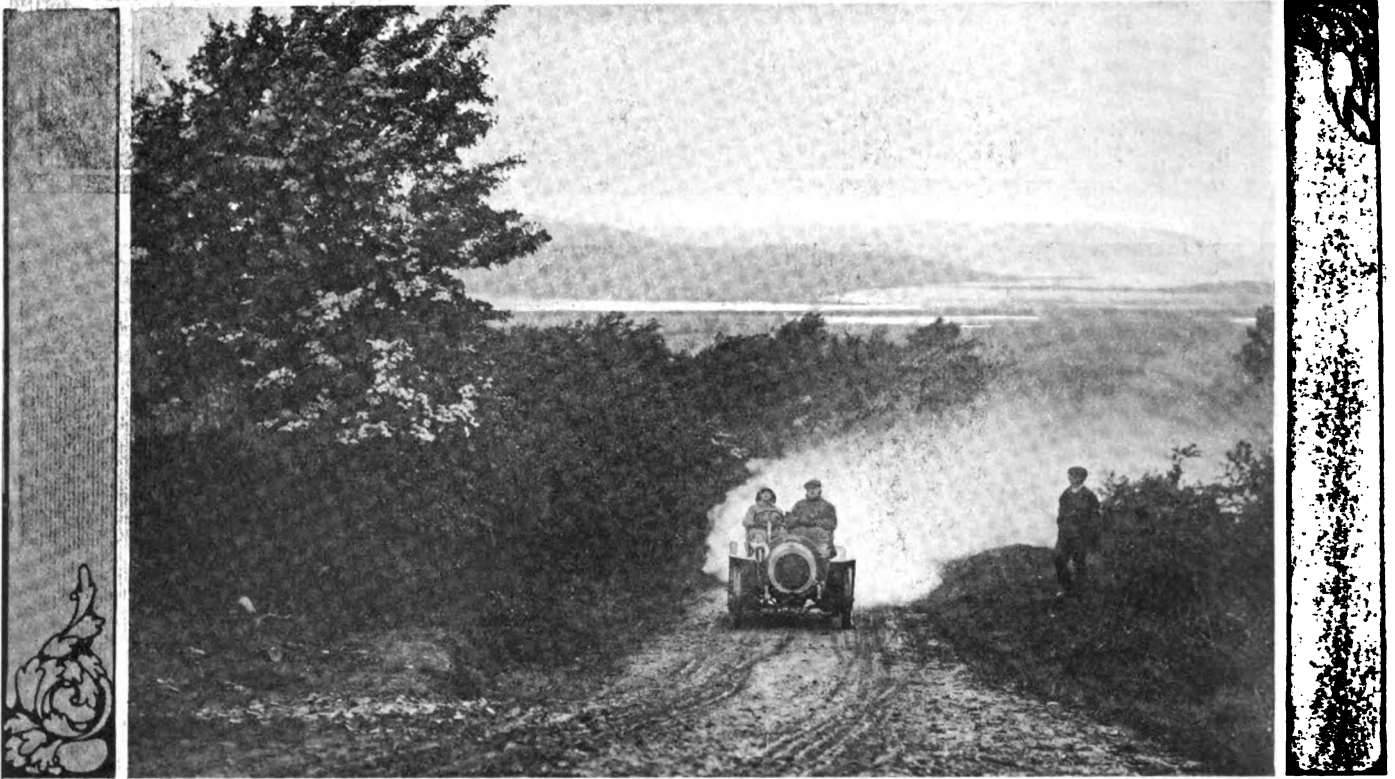

Marlborough Car Climbing Speenogue Hill, from Which a Beautiful View of Ireland's Charming Lakes is Obtained

with six days of hard work was crowded a complete circuit of the Emerald Isle, with its attendant difficulties, to say nothing of very sharp competition among the contestants, and all the discouragement possible from the very frequent rains.

The trials really started in Dublin, Tuesday, when the contesting cars were officially received, measured and weighed. The rules required certain maximum and minimum body dimensions but the weight was only restricted as to upper limit. The body sizes came near disqualifying two cars, the 15-horsepower Deasy being a quarter of an inch short at the back height of the tonneau. This was fixed to conform with the rules by removing the leather upholstery and adding a piece of wood, upon which the leather was replaced. Another prospective contestant, the Adler, was disqualified for being below official dimensions.

After measuring, the cars were emptied, and weighed. Then they were parked for the night at Ball's Bridge, under the care of the Irish A. C.

Tuesday morning, the cars began upon the first day's share of the circuit, the run being from Dublin northward to Ballycastle, then west to Portrush, following the east seacoast for the first 50 miles. The whole distance for the day was 177 $\frac{3}{4}$ miles.



On the Way to Dundalk—Deasy Car in Foreground

and this was followed by an easier day of but 160 miles to Bundoran, via Londonderry, near which a stop was made for the hill climb. This was up Greenane hill, and was preceded in the morning by the speed tests on Magilligans strand, just out of Portrush. Although shorter in miles than the day before, this was no snap, the winding roads around dangerous points, and the passage through Barnesmore Gap, before reaching Donegal, being such as to test the car's and the driver's ability.

Friday, the cars that had survived up to that point, traveled on to Galway by way of Swineford, and along the west coast with a side trip to Ballinarinch, where a beautiful view of the Atlantic Ocean was obtained. This made a run of 165 $\frac{1}{2}$ miles, and gave the survivors a total of 503 miles.

Galway-Killarney gave the tourists the easy day up to then, the length of the course run over being only a distance of 146 miles, down the west coast, with a slight detour to pass through Limerick, where the noon stop for lunch was made.

The day's rest, over Sunday, at Killarney was augmented on Whit-Monday when the itinerary included the easiest, and by far the most pleasant trip of the trial, the circular run around the lake region. This is easily the most beautiful part of the country and although in a race, the magnificent scenery was enjoyed by all, particularly by the Limited Section, which included all of the private owners and drivers.

To offset the two days' rest, if it might be called that, the concluding day put the cars through their paces, being by far the longest, 187 miles of varying degrees of severity, and all of it such as to give the driver no moment of security. This took the contestants across the southern end of the island back to the starting point at Dublin.

The cars were well distributed through eight classes in the first section, open to all comers, and the second or limited section, which was restricted to *bona fide* members of recognized clubs, besides which the cars had to be driven by the entrant or a member of his immediate family. Nor was a professional driver allowed on the cars of this class, even as a passenger. This class was well patronized, 9 of the 54 entries being included in it, of which two did not start, one of these being the 16-20-horsepower Argyll in the limited class.

There were several notable additions of newcomers and a few

prominent absentees. Among the latter were the Swift cars which for the last two years have taken such a prominent place among the high score cars. The entry in Class A of the two Bedford cars was of great interest and their successive good performances were closely followed, for these cars were of a new design, frankly and avowedly copied after American lines. The two Bedford entries had four cylinder engines of 95 mm. (3¾ inch) bore and stroke. A planetary transmission in combination with shaft drive to the live rear axle was used. The other newcomers, whose entry attracted much attention, were the two-seated 12-14-horsepower Marlborough cars entered in Class C1. These weighed but 15 cwt. and carried four-cylinder engines of 80 mm. (3¼ inch) bore and 100 mm. (4 inch) stroke.

The American cars among the starters were four in number, all products of the Cadillac factory at Detroit. They were well distributed over the list of classes, beginning with a single cylinder 10-horsepower in Class B, and including two 20-30-horsepower models in Class D, in which they competed with England's best in the small car line, most of the cars being of lower horsepower rating. Section Two, the Limited Section, also included one of America's representatives, another 20-30-horsepower Cadillac car. There were, as a whole, very few cars other than English make; either of home design and manufacture complete, or foreign design and home manufacture. Thus, aside from the Americans just mentioned, there were but three French and one German car, the former being a Chenard-Walcker in the same class with the one-lung Cadillac, and a pair of Motoblocs in Class E. The sole representative of the Germans was the 30-horsepower Adler in Class F, where Talbot, Gladiator, Vauxhall, and Sunbeam supplied worthy competition.

The complete list of entries was as follows:

Class A—Little Briton, 10-horsepower; Little Briton, 10-horsepower; Bedford, 15-18-horsepower; Bedford, 15-18-horsepower.

Class B—Briton, 12-horsepower; Chenard-Walcker, 8-9-horsepower; Riley, 10-horsepower; Adler, 12-horsepower; Cadillac, 10-horsepower; Rover, 8-horsepower; Bedford, 15-18-horsepower.

Class C—Chenard-Walcker, 12-14-horsepower; Riley, 12-horsepower; Star, 12-horsepower; Humber, 10-12-horsepower; Belsize, 14-16-horsepower.

Class C1—Star, 12-horsepower; Marlborough, 12-14-horsepower; Marlborough, 12-14-horsepower; Chambers, 12-horsepower.



Chambers Car Mid Pastoral Scenes at Ballrigan

Class D—Talbot, 12-horsepower; Cadillac, 20-30-horsepower; Gladiator, 12-14-horsepower; Cadillac, 20-30-horsepower; Star, 15-horsepower; Straker-Squire, 15-horsepower; Rover, 15-horsepower; Rover, 15-horsepower; Humber, 16-horsepower; Humber, 16-horsepower; Mass, 15-horsepower.

Class E—Talbot, 15-horsepower; Vauxhall, 20-horsepower; Vauxhall, 20-horsepower; Vauxhall, 20-horsepower; Armstrong-Whitworth, 18-24-horsepower; Motobloc, 18-22-horsepower; Deasy, 15-horsepower; Motobloc, 18-22-horsepower.

Class F—Talbot, 25-horsepower; Adler, 30-horsepower; British-Gladlator, 18-24-horsepower; Vauxhall, 24-horsepower; Sunbeam, 20-horsepower.

Class G—Gladiator, 40-50-horsepower.

Section Two (Limited)—Metallurgique, 12-horsepower; Peugeot, 10-12-horsepower; Austin, 15-horsepower; Metallurgique, 18-horsepower; Marlborough, 15-horsepower; Argyll, 16-20-horsepower; Clement-Talbot, 20-24-horsepower; Cadillac, 20-30-horsepower; Germain, 22-horsepower.

Of these, all appeared at the starting line, ready for business, excepting only one Motobloc in Class E and the 16-20 Argyll in the section for amateurs, as well as the 10-12 Peugeot and 20-24 Clement-Talbot in the same class as the Argyll, which latter were withdrawn several days before the start.



Mass Car Has Interested Spectators as It Climbs Up the Slopes of the Famous Speenogue Hill

SAVANNAH HAS DOUBLE TIE IN FIRST ENDURANCE

SAVANNAH, GA., June 7—Double ties; Chalmers-Detroit and E-M-F in the first division and Packard and Acme in the second were the results of the first endurance run of the Savannah Automobile Club Monday between this city and Augusta, a distance of 135 miles. In the nature of a good roads campaign, in connection with the tide of enthusiasm for better highways now sweeping through the State, this event was begun with 17 automobiles, and 14 of these finished as contestants, the entire party being increased in number by additions from cities and towns along the route. At all points the purpose of the contest was fulfilled, for the inhabitants turned out in force, and wherever the subject of roads was mentioned there was always a hearty response in favor of anything which would hasten their coming.

Harvey Granger's Stevens-Duryea lost its muffler at this point. At Sylvania, the county commissioners—S. B. Lewis, J. O. A. Enecks, and C. S. Zeigler—joined the club in three White Steamers, driven by W. J. Hilton, C. M. Hill, and J. J. B. Morrell. After a short stop there the club drove to Jacksonboro Bridge, five miles away, where a rest of one hour and a half was taken for dinner. Comparatively slow time was made through the sand and sharp curves of Screven county to the Burke county line, after which the route was found to be almost a boulevard.

Waynesboro was reached one hour ahead of time and the citizens crowded around the cars. With the addition of E. E. Chance, chairman of the board of commissioners, Sheriff S. G. Story and J. P. Palmer, superintendent of roads and bridges, the trip was resumed in a half an hour. Because of the good condition of

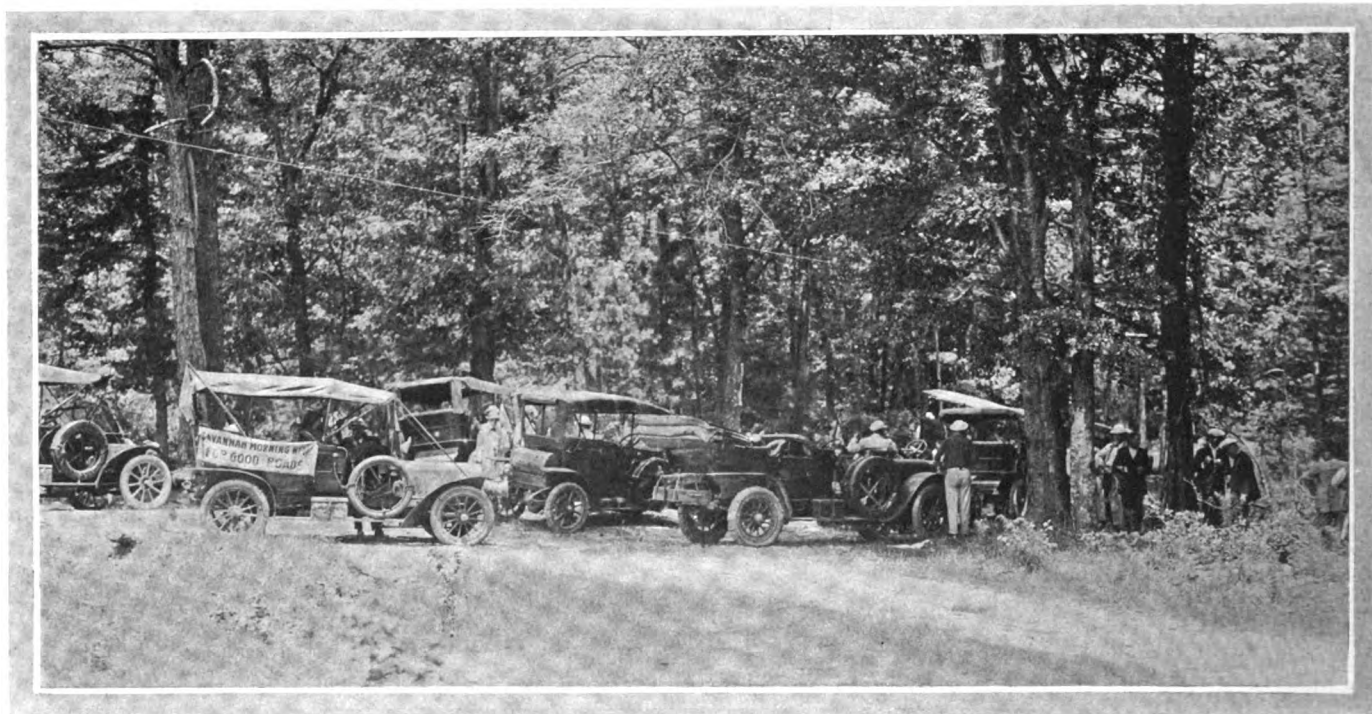

A Rest of Two Hours at Picturesque Scarboro (Where Dinner Was Taken), Five Miles from Sylvania

The South has had no endurance contests of this kind, and the run of the Savannah club was organized with a maximum and minimum time schedule, no car being allowed to reach Augusta before 7 o'clock in the evening, while those reaching the finish after 8 o'clock were penalized 25 points, and any being over five hours late were disqualified. The rate of 25 points per hour was arranged, and only one car was disqualified for being late beyond the limit, a Buick driven by W. H. Connerat.

An early start was made on the morning of May 31 from Liberty and Bull streets, with the cars at intervals of 100 yards apart, following President Frank C. Battey's Stevens-Duryea, which acted as pilot and confetti car. As far as Montieth, which was reached at 6.55 A.M., the roads were through Chatham County and were fine, but from that point to Rincon the worst of the entire run were found. In attempting to dodge one of the holes on this, the Packard of N. G. Brown went in to the hubs, and it required the assistance of several cars and four mules to draw the machine out of the bog. Rincon to Springfield, 27 miles, was made in one hour and forty minutes, and when the latter was reached the whole town had turned out to greet the autos. Mayor McLoud joined the Savannah Club for the remainder of the trip. The pilot car took the wrong course after leaving Springfield, and about 15 minutes were lost in regaining the

cars at this point, it was decided to abandon the schedule and make for Augusta in the shortest possible time. T. A. Bryson's Chalmers-Detroit 30 and C. Graham's E-M-F were the only cars in the first section which made the last stop within the scheduled time, thus winning their perfect scores.

In the second division N. G. Browne's Packard 30 and G. Mouro's Acme were the successful ones. President Battery was penalized 25 points in the first class and the others considerably more, but in the second class there were three cars which received but 25, the minimum penalty. Two Stevens-Duryeas and a Jackson, another Chalmers-Detroit, and a Franklin each received 50 points.

On Tuesday the Savannah club was taken to the Carmichael club for a real barbecue and for speeches by members of the Savannah club, as well as those from the Atlanta, Augusta, Waynesboro, and Athens, all on the subject of "good roads for Georgia." The time of the return trip to Savannah was optional to the tourists, some coming through on Tuesday night by moonlight and others on Wednesday morning. On the return trip Harvey Granger, in his Stevens-Duryea 60-horsepower, made the 135 miles in five hours and one minute, breaking the previous record of seven hours and a half. One cup was to have been given as a trophy, but now that four have come through tied

it is probable that a meeting will be called, and arrangements made to give four cups instead of one. Word has been received that the Motor Club of Augusta is now planning an endurance run to Savannah some time during the month, the date to be announced later.

Herewith is the summary of the run:

FIRST DIVISION

Name of Car	H.P.	Cyl.	Model	Entrant	Driver	Penalty
Chalmers-Detroit	30	4	30	T. A. Bryson...	Bryson	Perfect
E-M-F	30	4	30	C. Graham....	Mosher	Perfect
Stevens-Duryea	35	6	U	F. C. Battey...	Battey	25
Bulck	20	4	10	T. E. Youmans.	Youmans ..	50
Bulck	30	4	17	R. V. Connerat.	Connerat...	100
Reo	24	2	H	C. Hendersont.	Finney	100
Maxwell	10	2	Jr.	R. B. Brockett.	Brockett...	175
Bulck	30	4	17	W. H. Connerat	Connerat ..	Dis.

SECOND DIVISION

Packard	30	4	30	N. G. Browne..	Browne	Perfect
Acme	35	4	19	G. Mouro.....	Mouro	Perfect
Stevens-Duryea	60	6	Y	H. Granger....	Mahoney ...	25
Jackson	30	4	E	J. C. Manning.	Delph	25
Stevens-Duryea	24	4	X	A. W. Solomon	Solomon	25
Chalmers-Detroit	30	4	30	T. A. Bryson...	Thompson ..	50
Franklin	20	4	15	J. S. Weeks....	Weeks	50
Franklin	20	4	G	R. R. Oakman.	Oakman	D. O.

Meet at Fitzgerald, Ga., Is Postponed

SAVANNAH, GA., June 5—The three-day race meet scheduled for June 15, 16, 17 at Fitzgerald has been postponed until the middle of August. The reason is because the roads just graded are too soft for safe speeding, and with sixty more days in which to work on them the course will be in perfect condition.

SAVANNAH STILL HAS GRAND PRIZE HOPES

SAVANNAH, GA., June 5—More hope is now entertained for a grand prize race in Savannah than at any other time. A special meeting of the Savannah Automobile Club has been called, and a letter received from the Automobile Club of America will be submitted and gone into thoroughly. It is this letter that has caused the Savannah Automobile Club to feel that there will be a race, though if a race is to take place it will have to be decided upon at once, so as to give the manufacturers a chance to prepare special cars. It is probable that a committee composed of Mayor Tiedeman, President Battey, Harvey Granger, and two others will leave no later than Wednesday for New York, where they will talk over plans for the last time on the Grand Prize race.

READVILLE RACES BEING WELL ENTERED

BOSTON, June 7—Enough entries have already been secured for the races to be held at Readville track, June 17, to insure the success of the meeting. A contract has been signed by Ralph DePalma, driver of the Fiat *Cyclone*, and Charles Basle, driver of the Renault racer, for a match event of 25 miles. The other principal event will be the 25-mile contest for the Harvard trophy, with \$800 additional in cash to the winners of first, second and third places. Basle and DePalma will drive in this race. There are six other events, and among the cars that have been entered are: Stearns, Allen-Kingston, Alco, Chalmers-Detroit, Knox, Columbia and Morse.

The Morse is a new car built in Boston and will make its debut at Readville.

HARTFORD SOLVES ENDURANCE RUN TIE

HARTFORD, CONN., June 7—Copper trophies, thirteen of them, will be given by the Automobile Club of Hartford to those who made perfect scores in the recent endurance contest. There were 15 clean record cars but two of these, the Renault and the Maxwell Junior won their respective classes, leaving the bakers' dozen deadlocked. Albert M. Kohn, chairman of the contest committee in the absence of H. P. Maxim, is a manufacturing jeweler and he has arranged for the copper cups, each to be suitably engraved. In addition, a sterling silver club pin will be given to the successful drivers.



Maxwell, Lowest-Powered Car to Make the Trip

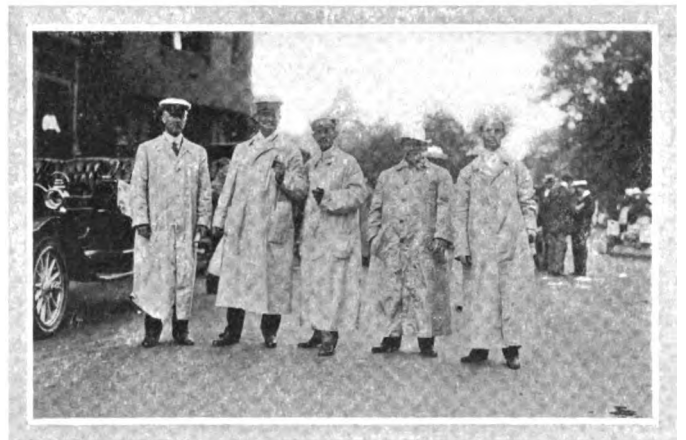

Judge Cann, Messrs. Bacon, Granger, West, and Solomon



The Acme Driven by Mouro, with a Perfect Score

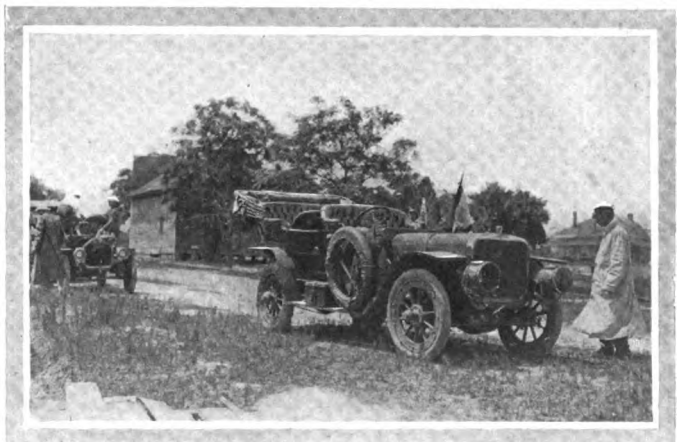

Stevens-Duryea Which Lowered the Road Record

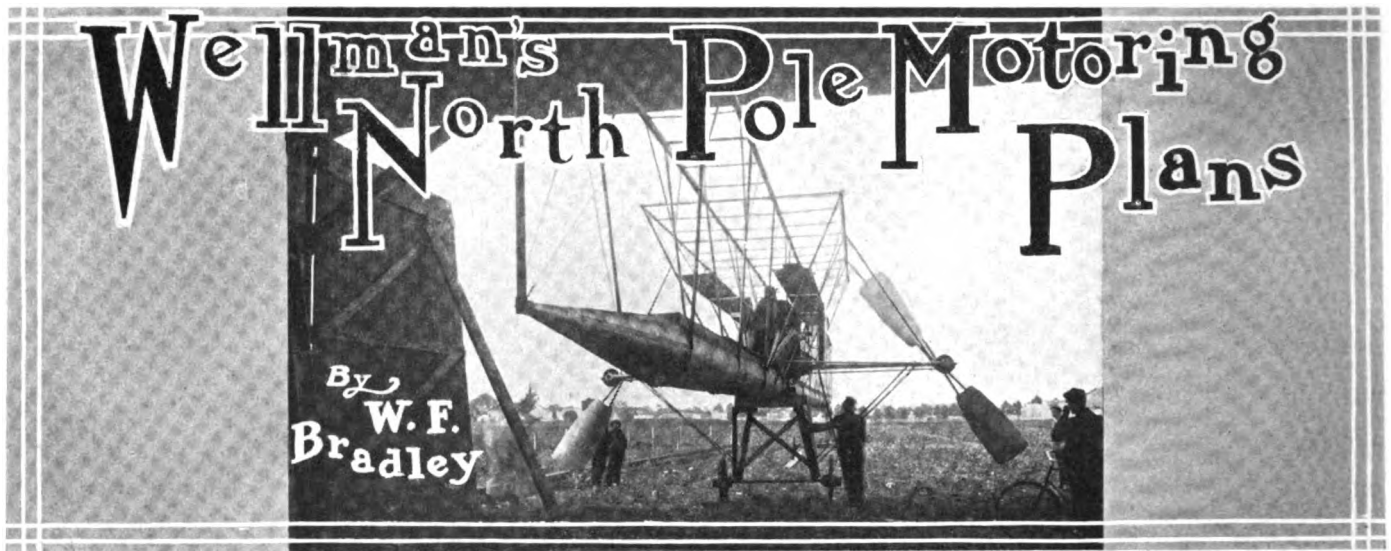

Steel Car of Wellman Airship "America" That Is Fitting Out in Paris for the Perilous Trip to the North Pole

PARIS, June 3—Walter Wellman's first action on arriving in Paris was to visit the private workshop in the suburbs where, under the direction of Chief Engineer Melvin Vaniman and a group of American mechanics, the steel car of his airship *America* is being fitted out for its journey to the North Pole. Work is so far advanced that the ship will leave Paris very early this month for Spitzbergen, via Antwerp, to be followed by Walter Wellman, Melvin Vaniman, and the third member of the crew yet to be selected.

It is the same airship, modified and improved where previous experience has shown improvements were possible, which was used for the 1907 expedition to the Arctic. The steel car has a total length of 115 feet, and carries two gasoline engines, one an 80-horsepower four-cylinder model, driving two huge steel propellers, and the other a slightly lower powered eight-cylinder model driving a pair of wooden propellers capable of being pivoted on their axis in order to drive the airship horizontally or at any required angle from the horizontal.



Walter Wellman by the Side of His Airship

Some interesting tests were made this week with hydrogen gas as fuel. Normally the engines run on gasoline, of which 1,200 gallons are carried in the fourteen tanks forming the tubular keel of the ship. As this fuel is consumed, the weight of the airship will be reduced to such an extent that there will be hydrogen gas to spare. Instead of letting it out into the air, Engineer Vaniman has devised a system of burning it in the motors, a task which no other dirigible balloon pilot has attempted on account of the danger of fire.

Two carbureters are employed, one being an ordinary type working with gasoline, and the second a special appliance intended to mix hydrogen and air. Only one set of intake pipe are employed, arranged in such a way that a single throttle will allow of running entirely on hydrogen, entirely on gasoline, or on any proportions of the two. Experiments made at Spitzbergen in 1907 showed that the engine could be started much more readily on hydrogen than on gasoline. The tests this week further proved that the engines ran faster, with less vibration, and developed more power with the pure hydrogen mixture than with the best gasoline charge. Some further adjustments were required in order to make it possible to switch over from gasoline to hydrogen, or vice-versa, without a momentarily slowing down of the engine, but the value of the two fuels working together was undeniable. It was distinctly noticeable that the hydrogen mixture fired much more readily than the gasoline one, and that for a given number of revolutions the spark needed retarded less for the former than for the latter fuel. The experiments will be continued with a view to getting very accurate data on the hydrogen consumption per horsepower hour, as well as the best proportions of air for the two fuels.

JUST LIKE EARLY DAYS OF AUTO RACING

PARIS, June 3—The official opening of the Juvisy aerodrome, intended as the triumph of the aeroplane, and the inauguration of a period when flying machine races would supersede automobile speed tests, resulted in proving quite other things than the promoters had intended. Conditions of the aerodrome and its inauguration were ideal. The ground, situated about ten miles to the south of Paris, is a vast level field, surrounded by grand stand, aeroplane sheds, workshops, etc. For the Sunday inaugural meeting nine aeroplanes were promised, weather conditions proved to be ideal, and in the hope of seeing an altogether new sport a crowd estimated from 30,000 to 50,000 people traveled out to the aerodrome, filling every available space.

After two hours cooking under a hot sun, the easy-going spectators at last lost patience in the kite demonstrations, broke down the barriers and advanced in two solid masses across the field to inquire why they were not getting their money's worth.

The twelve mounted gendarmes were worse than useless, for they only served to irritate the people by their opposition, and for over an hour the officials were kept prisoners in their offices while the people outside clamored for the return of their money and let loose their wit at the expense of the organization.

After considerable effort on the part of the police, members of the committee and self-enrolled guardians, the ground was sufficiently cleared to allow Leon Delagrangé to get away on the old Voisin biplane with which he made his records in Italy last year. The flying machine, however, was not in a flying mood, the net result being a skim over the ground with an occasional jump into the air. The De Pischof, a badly executed copy of the Wright, was still less capable of flying, and after ten minutes on the ground was wheeled back to its shed and the shutters drawn down. Later Delagrangé made further attempts, but his best performance was one round of the field, about three-quarters of which was in the air. Rougier, the ex-Dietrich race driver, who had made a flight of 25 miles the previous day, attempted to save the situation on his new Voisin flyer, but after one minute skimming the machine dived, sticking its nose in the soft ground and throwing its tail in the air. The driver was in no way injured, but his machine was too much damaged to make further flight possible.

Finally, when the spectators had gone home in disgust at the flying machines which were unable to fly in the gentle summer zephyr, Delagrangé came out again on Captain Ferber's flyer and for ten minutes made a magnificent flight, at a height of about forty feet from the ground. It was too late, however, to undo the bad impression created, and in the minds of the Parisians the word aviator is synonymous with bluffer and the managers of the Juvisy aerodrome are guilty of getting money under false pretenses.

WRIGHTS WILL GET THEIR MEDALS TO-DAY

WASHINGTON, D. C., June 10—President Taft will to-day present to Wilbur and Orville Wright the gold medals of the Aero Club of America. In the morning it is planned to have a demonstration flight by one of the Wright brothers, if conditions are



Making "Snake" to Be Used on Wellman Expedition

favorable, and at half past twelve a luncheon will be given the Wrights and the members of the Aero Club of America by the Aero Club of Washington, at the Cosmos Club. At half past two the presentation ceremonies will begin in the East Room of the White House, where President Taft will officiate. There will be present at the ceremony an array of Senators and Congressmen, the diplomatic corps, and the officials of the great scientific bodies of the country, making the assemblage one of the most brilliant and representative that has ever been seen in the national capital. The Aero Club of America, which has its headquarters at the New Willard hotel, is present in a body.

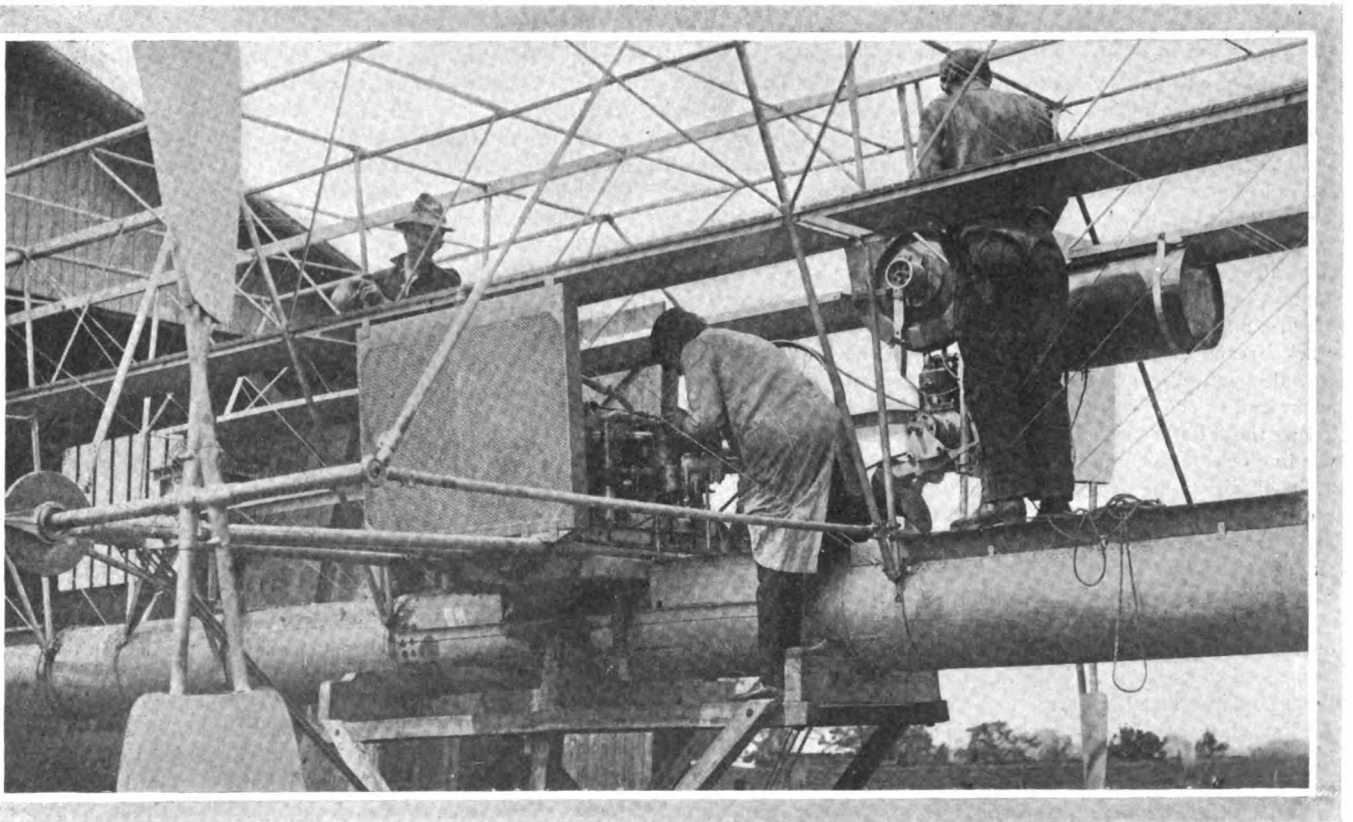

Engineer Vaniman Making Adjustments to Hydrogen Carburetor on Airship "America"

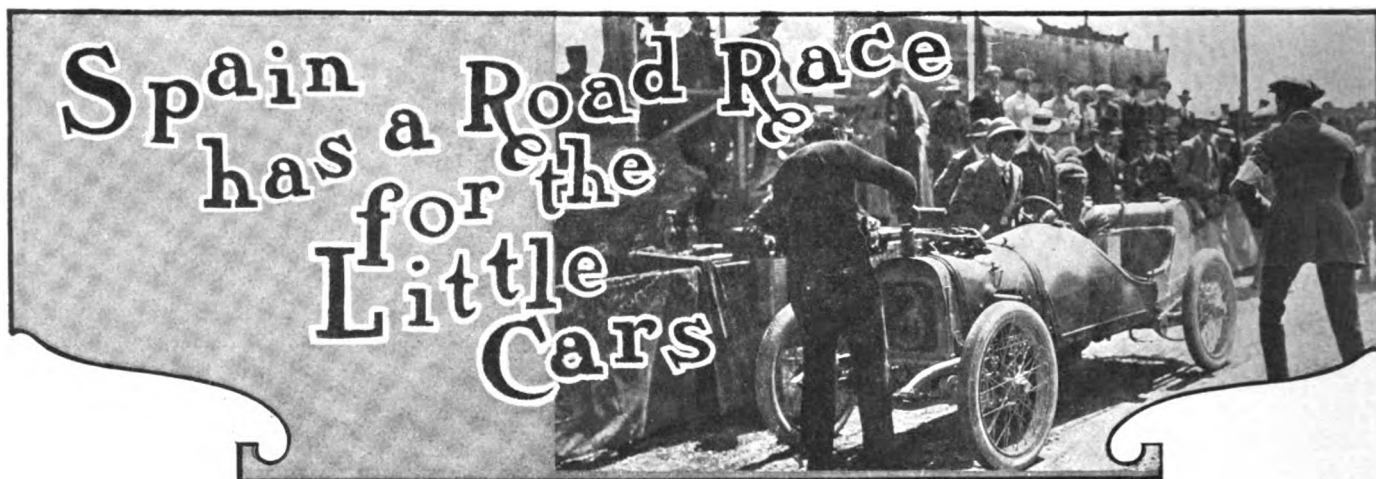

Driver Goux Taking on Supplies for His Winning Lion Peugeot, in the Copa Catalunya, at Barcelona, Spain

BARCELONA, SPAIN, June 1.—Automobile racing being dead in France, it rested with non-sporting Spain to bring it back to life with voiturette race that had all the interest and all the excitement of any of the large international events. The cars were twelve in number, with single cylinders of 3.9-10 inches bore, or the equivalent where multiple cylinders were employed, but were none the less interesting by reason of their smallness, for the French specialists have found the secret of developing 35 horsepower in this small diameter cylinder and of driving the cars at more than 50 miles an hour on level road.

Victory fell to Goux, on a two-cylinder Lion Peugeot of 3.1-10 inches bore by 7.4-5 inches stroke, with an average speed of 22.77 miles an hour for a distance of 225 miles. In considering the average it is necessary to take into account the fact that the course is less than 17½ miles round, that for a third of the distance it winds up a hillside, and that the frequent turns constantly kept the cars back.

Goux won the race with a large margin, for Georges Sizaire, who came in second, was 1 hour 19 minutes to the bad, but the race was none the less exciting for all that. On the first round Goux made the fastest time, covering the 17½ miles in 23.48, and being followed home by his team mate, Boillot, on a single cylinder car of 3.9-10 inches bore by 10 inches stroke, and a second car of exactly similar construction in fourth position, with Giuppone at the wheel. The only Spanish team in the race, small Hispano-Suiza four-cylinder cars of 2½ inches bore by 7 inches stroke, finishing third, fifth and sixth. Georges Sizaire, on a Sizaire-Naudin car of the same dimensions as the one-lunger, Lion Peugeots, broke a wheel on the first round, finishing in 1 hour 55 minutes 10 seconds, compared with 23 and 24 minutes for the first and second cars. It was a terrible handicap, and even the crack French driver appeared to look upon the task as hopeless, for, although he continued with his damaged wheel, he remained at the end of the list for the first five rounds.

But the Lion-Peugeot one-lungers were far too fast for the winding course, and after Boillot and Giuppone had both smashed their wheels on the dangerous turns and had been carried back to the grandstands on the rival but disabled Sizaire-Naudin, and after the same car had towed the damaged Demeester to the stands, Georges Sizaire came to the conclusion that something could be done. The rakish, big-bonneted blue car was jacked up, the damaged wheel replaced by a solid one, and with a handicap of 1 hour 50 minutes against him, Georges Sizaire rushed away at a speed of 55 miles an hour in an attempt to catch up with the flying and far-ahead leader.

First place at this time was being held by a four-cylinder Hispano-Suiza, with a similar car in second position and Goux's twin-cylinder Lion-Peugeot third. This latter had suffered serious damage to its radiator by a flying stone, and had to stop every eight miles to fill up with water. At half distance the Spanish

Hispano-Suiza cars began to falter, two of them going out of the race and the third one being passed by the leaking Lion-Peugeot. Sizaire was now going all out, and, being slightly faster than the Lion-Peugeot, and not having, like this latter, to stop at intervals for water, was gradually lessening the distance between himself and the first car. Thanks to the dexterity of the Lion-Peugeot mechanic, the filling of the tank was a matter of seconds only, and with the big delay at the beginning Sizaire could not regain all of the ground that he had lost.

The race finished with Goux, on the two-cylinder Lion-Peugeot, first in 6.19.6; Sizaire, on single-cylinder Sizaire-Naudin, second, in 7.37.46 3-5; Soyez, on single-cylinder Werner, third, in 7.38 2-5, and Pileverdie, on a four-cylinder Hispano-Suiza, fourth, in 7.55.29.

This is the first time in any European voiturette race that multiple cylinder cars have made a really good showing. The reason of their victory lay entirely in the excessive speed of the single-cylinder models. The two Lion-Peugeot cars, with single-cylinder engines developing 35 horsepower, were too fast for the course, their disablement being caused entirely by the breakage of road wheels on turns. The handicap to the Sizaire-Naudin was exactly the same, and but for the hour lost on the initial round he would almost certainly have secured first place. The Sizaire-Naudin was a last year's car, while the Lion-Peugeots were all special productions, the single-cylinder models being very original by reason of their excessive stroke, high compression, high engine speed and three inlet and three exhaust valves spaced in a horizontal plane around the one cylinder.

The list of official observers for the Prince Henry tour reads like an extract from an army gazette, as the majority are officers and members of the general staffs of their countries. The German general staff will be represented by six majors, twelve captains and three lieutenants, besides which a great many other officers from different regiments will take part in this capacity, among them being Prince Franz Hohenlohe. With one exception the eleven observers Hungary is entitled to send are on the general staff, and this fact rather detracts from the character of the event as an ordinary tour, especially as permission has been granted for all to wear their uniforms.

The Swiss League Council is working at a set of uniform regulations governing motor traffic for the whole of Switzerland, as urgent representations have been made to this end by the hotel and inn-keepers of the republic, who are feeling severely the losses brought by the decrease in motor traffic. It was hardly to be expected that the automobiling public would calmly stand the hundred and one pettinesses of each canton and tiny parish without some return, and this took, to a great degree, the form of boycott.

Exhaust Side of Automobile Motors

By Thos. J. Fay

Part I

CONTINUING ON, from the fuel, after it has performed its quota of work, to the maximum possible extent, in view of the limitations imposed by motors, it becomes necessary to treat with the products of combustion, rather with the expectation that the mere question of noise and its elimination will not constitute the whole theme. This story of the exhaust will have to be divided up somewhat, owing to the differences that can be noted if the air-cooled problem is separately handled.

Exhaust Manifolds Used in Water-Cooled Motors—It was pointed out in the discussion of fuel how some designers attempt to gain power by inducing a vacuum in the exhaust manifold, and the question here is, how can the design be consummated in

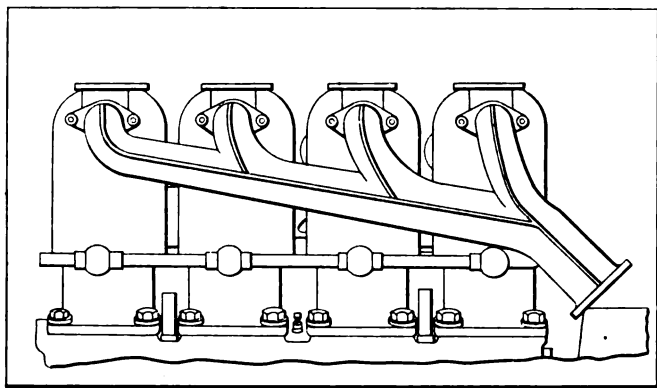

Fig. 51—Suitably proportioned exhaust manifold used on a two-cycle motor of the individual cylinder type

order not to lose power in the manifold? Certainly, it is important to avoid the loss of power due to imperfections in the exhaust manifold, even though it may not be easily possible to realize an actual gain, due to some method of creating a vacuum, in the absence of a condenser, which as yet has not been made to use in connection with the products of gasoline combustion.

It is not the purpose here to say that it will be feasible to condense the products of combustion, nor is it plain that there is much chance of gain by the introduction of an "air-pump" with the idea of exhausting the chamber to a point such as would result in a satisfactory vacuum. In the meantime, there is no good reason for using an exhaust manifold so designed that it will retard the passage of the products of combustion, nor can it be shown that any good will come from delaying the passage

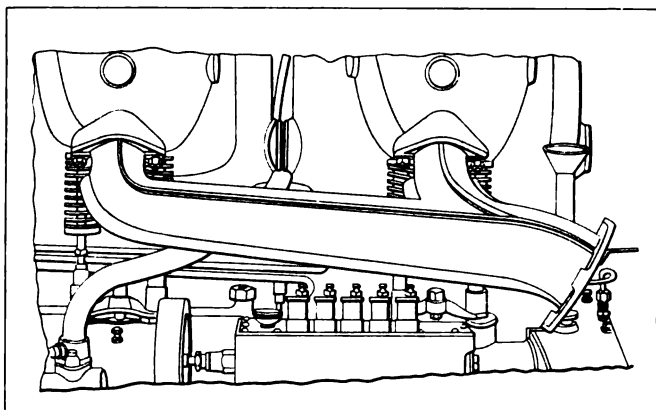

Fig. 52—Well designed exhaust manifold for a twin-cylinder motor of the four-cycle water-cooled type

of the exhaust to the atmosphere unless useful work is done.

In standard practice it is the idea to afford an easy passage for the exhaust, in a manner as shown in Fig. 51, which is an exhaust manifold as used on a two-cycle motor, with individual cylinders. As will be observed, this manifold is tapered down in such a way that the area is increasing as the needs, and it is also fashioned with easy bends at all points.

Fig. 52 is a fine example of the same general plan, only in this case the manifold is placed on a motor of the twin-cylinder type; here, again, the area of the opening is increasing, so that there is no chance of "choking" the exhaust.

In contrast with the designs already shown is the plan as depicted in Fig. 53, in conjunction with a two-cylinder motor (in this case) using flexible metallic tubing, the advantage of which lies in the perfectly uniform curves that can readily be made at the time of connecting up the exhaust; this same material is used with this motor on the intake as well. Against this material is the high first cost, which is compensated for by reduced cost of fitting, and finally there is the influence of the wrought interior

to be given a fair measure of serious consideration. Whether or not the interior surface, as wrought as it is in flexible metallic tubing, will unduly retard the flow of the exhaust, is a matter that the author has not been able to determine, although he has used some of the tubing for this purpose, and found it to be very satisfactory. From the point of noise, it is believed that flexible metallic hose, so called, is quite free from this tendency, and it probably is true of it that it is a positive step in the direction of silent performance not counting its other advantages as ease in placing.

Still another type of exhaust manifold is shown in Fig. 54, utilizing a "Y" form of branching, so contrived that the exhaust from the respective cylinders flows into the exhaust pipe proper at a point lower down than is usual in other forms, thus eliminating the bend that come in the exhaust pipe at a point near the motor. The same plan is illustrated in Fig. 55, on an air-cooled motor, and it possesses the advantage of tapping the heat away from the cylinders at the earliest possible moment.

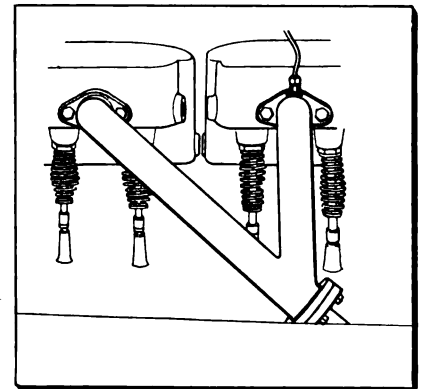

Fig. 54—Y-shaped exhaust manifold affording the advantage of saving bends in the exhaust pipe

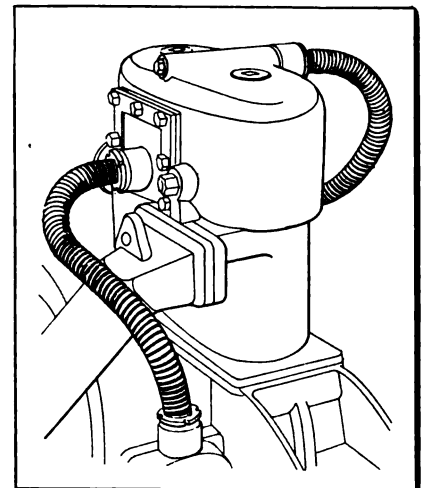

Fig. 53—Flexible metallic hose used for exhaust piping, affording a noiseless performance

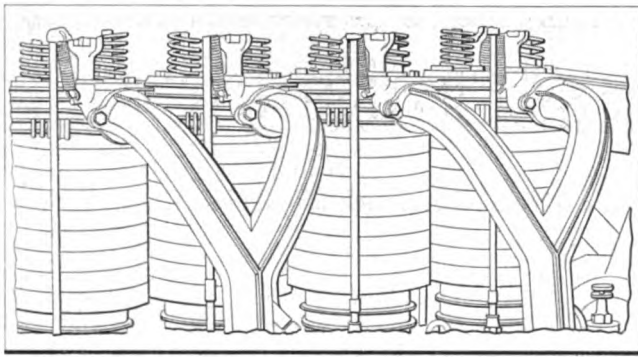

Fig. 55—Y-shaped exhaust manifold used on an air-cooled motor, employing two units and requiring abrupt ends at the pipe

Spark Plugs Should Be Well Clear of Manifolds—Frequently space is at a premium under the hood of a motor, and in the scramble to find room for everything, the parts are prone to interfere with each other. Fig. 56 shows the spark-plug rather too near the exhaust manifold, when it is placed on the exhaust side, which, in itself, is not an idea to be recommended. Even when the plugs are placed on the inlet side the same trouble is experienced betimes, and the disadvantages are by way of short-circuiting the high potential charge if the distance is infringing, and in any case it leaves but little room for the

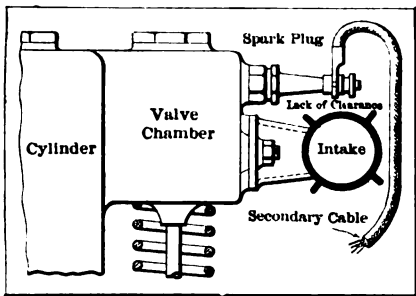

Fig. 56—Illustrating a wrong location of the spark-plug close to the manifold

autoist to get at the plug with a wrench. If it is necessary to get at the spark-plugs with a wrench it is also desirable to be able to put on and remove the manifolds. If the studs are hid away under the manifold it becomes necessary to apply a chisel to them, and while it is possible to tighten the nuts by this method, it also has the disadvantage of destroying the heads in a very short while. Fig. 57 shows a manifold so designed that the heads of the holding bolts are accessible, and there is no good reason why this condition should not hold in all cases. Then, there is the question of the use of studs or bolts big enough to enable the manifold to be drawn up to make tight joints. The use of copper-faced asbestos gaskets is also well worth taking into account. As a rule, all these matters are well looked after, and there is no reason why they should not find universal application in automobile work.

Possibilities in Air-Cooled Work—Referring to Fig. 58, it will be to note that the exhaust is used to pull the cooling air into the jacket and over the heated cylinder surfaces; whether or not this plan is one that will find a wide use in future remains

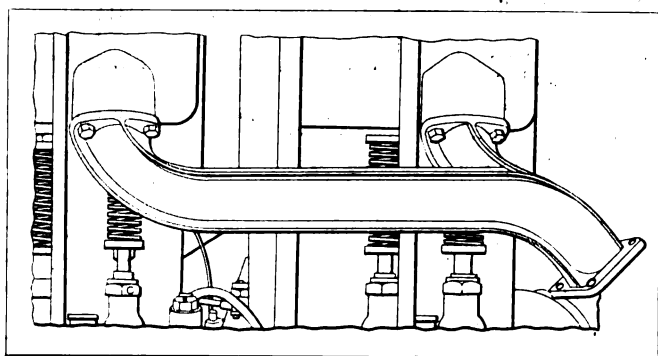

Fig. 57—Depicting a manifold in which the holding bolts are get-at-able, and of good practical size

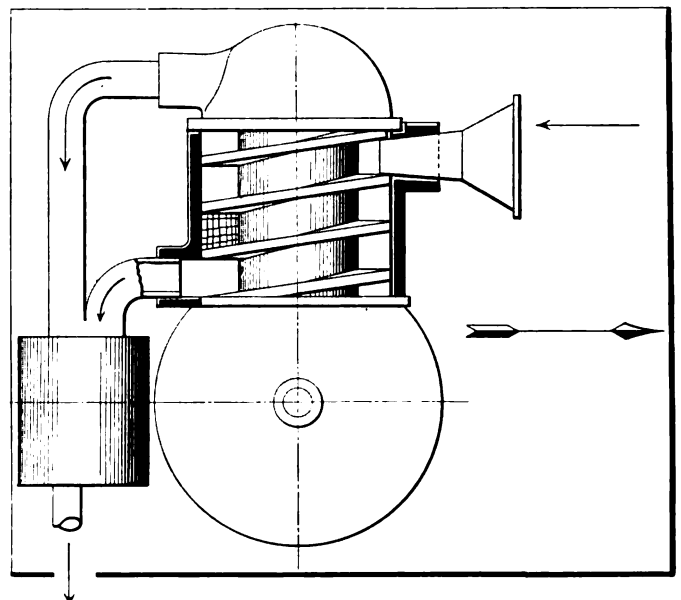

Fig. 58—The exhaust products of combustion are used to whisk the cooling air along

to be seen; yet, even so, it does look as if some use should be made of the energy that goes to waste in the exhaust. In this case the cooling air is passed around the surfaces of cylinders, and the exhaust products of combustion pass down to a point where the air and the exhaust join; the air is picked up by the exhaust and is whisked along with it and the amount of cooling

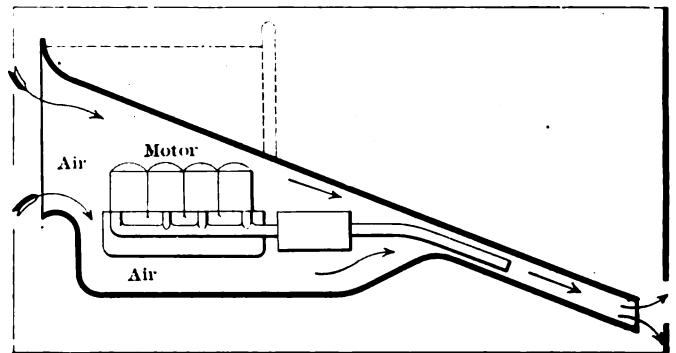

Fig. 59—Energy in the exhaust is used to sweep cooling air over all the motor surfaces

air that can be sucked in in this way should be adequate for the needs, which is in considerable contrast with Fig. 60.

Still another idea, differing from Fig. 58 more in detail than otherwise, is depicted in Fig. 59. In this case the exhaust goes to the muffler, which is located adjacent to the motor, and the cooling is drawn over the heated surfaces of the motor.

(To be continued.)

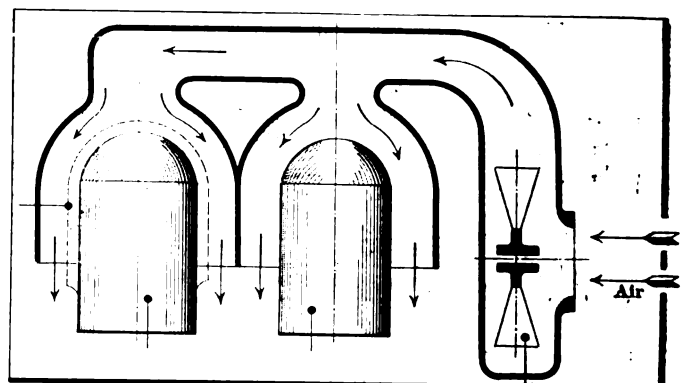
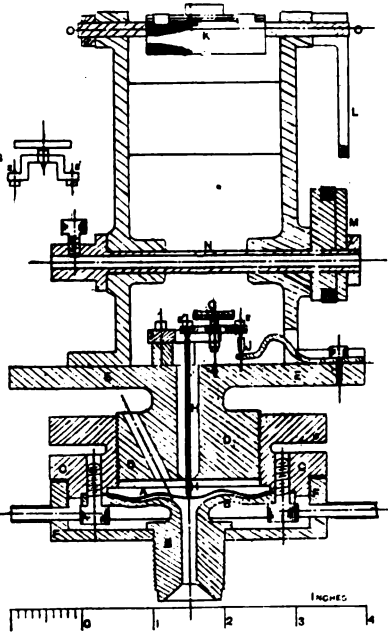

Fig. 60—Air-blast, through the use of a fan; may be adopted in conjunction with exhaust energy in the cooling process

Thermal and Combustion Efficiency of a Motor *

By Prof. W. Watson, D.Sc.F.R.S.

IN a paper read recently Professor Watson gave a large number of tables and diagrams which were the results and deduction from a very thorough test conducted by him on an automobile engine. To engineers and designers much of this matter is of more than passing interest, so that part of it is given below, space not allowing a full transcript, valuable as the matter may be, and doubtless is. The motor on which the tests have been made is a four-cylinder Clement-Talbot having a bore of 85 millimeters and a stroke of 120 millimeters. In order to vary the compression, the cylinders were raised on carefully machined packing pieces, the thickness of which was varied for the different tests. As, however, this alone would only permit of the compression being lowered below that for which the engine was designed, rounded aluminum caps were attached to the tops of the pistons. These caps were made a good fit on the pistons, and were so designed that no narrow crevices were left in which the gas of the compressed charge could remain unburnt. The caps were all of the same



Indicator Section Showing Construction

volume and weight, namely, volume 42.5 cubic centimeters (2.6 cubic inches), and weight 155 grams (5¼ ounces).

The exhaust from the motor is led through a pipe 9 feet long and 2 inches in diameter to two expansion boxes placed in series, the volume of each box being 1 cubic foot. When the engine is working at full power and at 1,000 revolutions per minute, the mean pressure in the exhaust pipe immediately after it leaves the engine is about 1.8 pounds per square inch.

The carbureter is a single jet one with a float feed, and for the tests it was altered so that the extra air inlet is closed quite air-tight, and a needle was fitted so that by means of a micrometer screw the point could be moved up from below into the orifice of the jet and hence the effective area of the jet could be altered. In this way it was possible to obtain mixtures of any desired richness. The closing of the extra air inlet, which normally is opened by a piston on which the suction of the engine acts, causes all the air supply, even at high speeds, to be drawn through the choke tube surrounding the jet. Although this may assist in thoroughly breaking up the jet of petrol and so help in producing a homogeneous mixture, yet on the whole it was at a disadvantage, and the wire-drawing obtained as the speed increased is due to this cause. The inlet manifold was altered to a straight pipe with openings to the cylinders, the carbureter being connected at midpoint. The size of manifold was increased until all cylinders received an equal charge.

Two Spark Plugs Used Simultaneously—Ignition was by high-tension magneto with two spark plugs in each cylinder, one over the exhaust and the other over the inlet. At high speeds more power was obtained by using both plugs; thus at 1,100 r.p.m. the indicated horsepower was 18.4 with a single plug, while using the two plugs it rose to 20.8, a gain of 13 per cent. At a speed of 1,600 revolutions the effect was even more marked, the indicated horsepower being raised from 26.0 to 29.2 by the additional spark. This is equal to 12.3 per cent. The effect is due to the quicker ignition obtained with the two sparks, a matter of greater and greater importance as the speed gets higher and particularly so on racing motors.

The petrol supply was so arranged that the engine could either be fed from a reservoir or from a graduated glass vessel, the change from one to the other being made by means of a three-way cock. The temperature of the petrol in the measuring vessel was noted by means of a delicate thermometer, a matter of considerable importance since the density of petrol varies so rapidly with temperature. Each test extended over the time the engine consumed 400 cubic centimeters of petrol.

The cooling water was taken from a 20-gallon tank and circulated by means of a centrifugal pump driven by the engine, being then returned to the tank. An overflow pipe was provided to the tank and cold water was supplied at such a rate that the temperature of the water as it entered the engine was between 55 degrees C. and 65 degrees C. If the temperature was allowed to rise much above 65 degrees the water started to boil and the engine to show signs of preignition.

The engine was direct coupled to a shaft mounted on ball bearings, and on this shaft were mounted three sets of fan blades. The load was varied by altering the number and size of the blades. This arrangement for taking up the load is convenient in that the speed during a test remains very constant, for the load varies as the cube of the speed. It has, however, the very great disadvantage that the load cannot be altered while the engine is running and further small adjustments in load, such as would be required to keep the speed constant when the richness of the mixture is altered, cannot in practice conveniently be made. For this reason in the test described below the speed during any one set could not be kept quite constant. This is a distinct fault and renders the interpretation of the results, particularly with very weak mixtures, a matter of a little uncertainty. In future experiments along the same lines as these, I hope to obtain a dynamo to take up the load, in which case it will be easy to so adjust the load that the speed is the same for all tests.

Speed-Indicating Devices —

The engine speed, that is, the number of revolutions, was measured by a Weston speed indicator, a well-known device, but a check on this was obtained

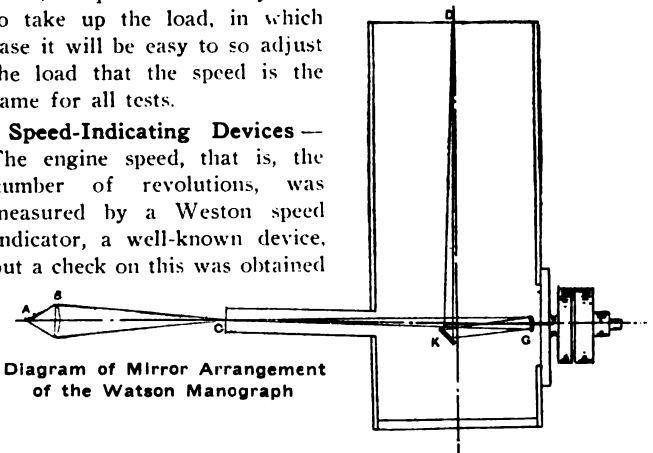
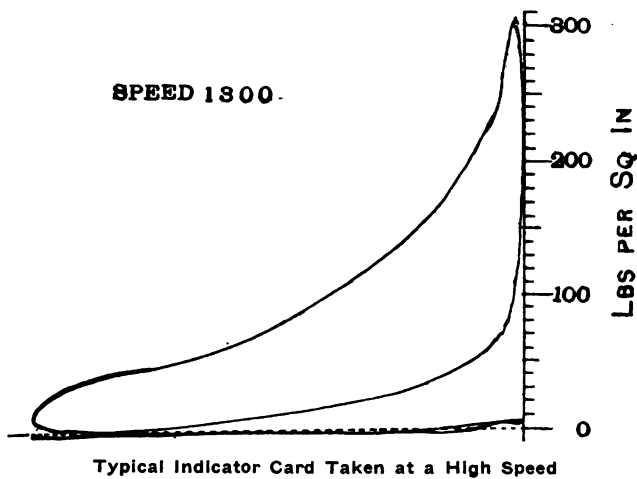

Diagram of Mirror Arrangement of the Watson Manograph

*Paper read before the Institute of Automobile Engineers, London, Eng., recently.



Typical Indicator Card Taken at a High Speed

by counting the revolutions per minute. The cards were taken by means of an indicator made by the writer and differing from both the Carpentier and Schultz instruments in the use of a corrugated diaphragm and two separate mirrors. The two mirrors are capable of rotation at right angles to one another, one being moved by the diaphragm and the other by the piston.

The internal construction is revealed by the first figure, while the second is a diagrammatic representation of the workings of the mirrors. The diaphragm A consists of a corrugated steel disc, .65 millimeter (.0256 inch) thick, the portion on which the piston acts being 44.5 millimeters (1.754 inches) diameter. As the success of the indicator depended upon these discs, they had to be made very carefully. The diaphragm is clamped between a steel cover B and a steel ring C. This ring is screwed to the gun-metal plug D, which is connected to the base plate E of the instrument by a narrow neck. In the first pattern of the instrument made, the diaphragm was clamped to the underside of the base plate E, but it was found that the readings obtained with an increasing pressure always differed slightly from those obtained with a decreasing pressure. After many weeks' work this effect was traced to a deformation of the base plate under the pressure and was entirely eliminated by the adoption of the present form. A box, F, screws on the back of the cover B and cold water is circulated in the space inclosed, serving to keep the temperature of the diaphragm at a very constant figure.

These indicators have been in use for more than a year and have been found to work satisfactorily and give a diagram 4 inches by 3.75 inches in which the pressure scale is uniform to within less than 1 per cent. This uniformity of the scale is of considerable importance when a large number of indicator diagrams have to be reduced, since owing to the shape of the diagram given by a petrol motor the author found it necessary to take at least 20 ordinates to obtain an accuracy of 1 per cent. A typical card taken at 1,300 r.p.m. is shown just as taken—that is, without retouching.

Use of Many Indicators Insures Accuracy—One indicator was used for each pair of cylinders, the connections being short steel tubes, which were water jacketed. Three series of tests were made with differing compression pressures, the change being effected by altering the thickness of the packing piece. In test A the piston occupied the high position, while in the B tests the highest position was 3 millimeters lower and in the C tests 8.6 millimeters lower than in the A tests.

The actual volume of the combustion space was measured by pouring in water, the cylinders being removed from the engine and inverted. A known volume of water was poured in and the level of the surface below the bottom flange of the cylinder was measured. Then allowing for the caps on the pistons, the volume which would have been present when the pistons were in place and in their highest position was calculated. Great difficulty was experienced in obtaining consistent results, it being

very difficult to get rid of all air bubbles, and hence the results can hardly be depended upon to more than 1 or 2 per cent. The volume of the combustion space is very nearly the same in the case of each cylinder, as is shown by the following numbers:

Number of cylinder.....	1	2	3	4
Volume of combustion space (A tests)	183 cc.	184 cc.	180 cc.	188 cc.

The equality in the volumes of the combustion spaces is also shown by the equality of the compression pressures as read off the indicator diagrams.

The average pressures for the four cylinders and in the three sets of tests are as follows:

Series.	A	B	C
Total volume at outer center.....	866 cc.	882 cc.	913 cc.
Volume at inner center.....	184 cc.	203 cc.	233 cc.
Compression ratio	4.71	4.36	3.92

Measurement of the Air Used by the Engine—The quantity of air taken by the engine at different speeds was measured by connecting the intake of the carburetor to a wooden box of 19 cubic feet capacity, the air being admitted to the box through a circular hole in a thin metal plate, and measuring the difference in pressure between the external air and the air in the box. The size of the hole was such that in every case the difference in pressure between the inside and outside was about equal to 1 inch of water. This pressure was measured by a King's gauge, the gauge being calibrated by comparisons with an oil manometer, a cathetometer microscope being used to measure the length of the oil column. This gauge allowed the pressure to be read to within 0.002 inch of water. Leakage of air into the induction pipe, without passing through the measuring box, was reduced to a minimum by fitting stuffing boxes to the inlet valve stems and by packing the holes where the rod for moving the throttle passes through the induction pipe. To reduce the effects of the irregular aspiration of the engine a sheet of thin rubber was stretched over a hole 12 inches by 18 inches in the side of the box.

As the speed increases the quantity of air taken in decreases, this being worthy of investigation, as it will determine the size and proportion of the induction pipe and inlet valves of modern motors, which show a tendency toward higher speeds. The mean pressure in the inlet manifold was accurately measured, using a mercury manometer. The results when plotted show that the weight of air at any speed, say, 1,000 r.p.m., slopes down more than does the curve of mean pressure, which suggests the thought that the pressure of the air in the cylinder when the inlet valve closes falls more rapidly than does the mean pressure in the induction pipe. On the assumption that the latter is not equal to the mean

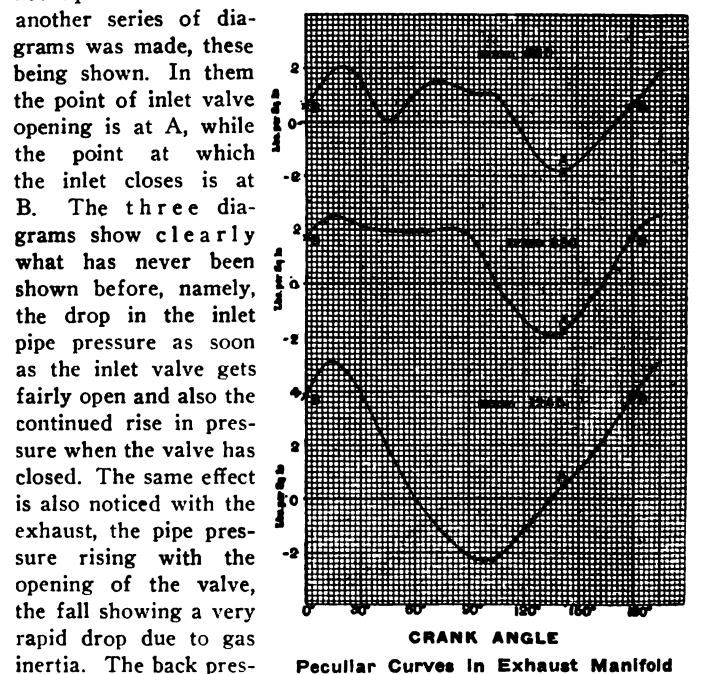

Peculiar Curves in Exhaust Manifold

sure rises with increase in speed. At high speeds the induction stroke takes less time so the gases drawn in would have less time to acquire heat from the walls. At slow speed, on the other hand, liquid is without doubt drawn in which apparently reduces the total volume of cylinder charge.

Of interest to carbureter designers is the variation of the suction in the cycle. If the orifices through which the air is admitted to the carbureter are close to the jet the rise of pressure above atmospheric will not occur. If, however, as is often the case, air is drawn from near the exhaust pipe and is conveyed to the carbureter through a pipe of some length, then the rise of pressure due to inertia will be considerable. In the same way the manner in which the pressure in the exhaust pipe varies with the speed suggests that if it is desired to have a maximum power at a certain speed a little experimenting with exhaust pipes of different lengths

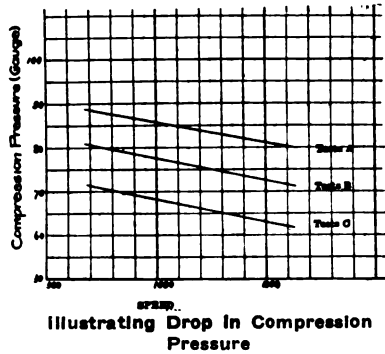

will increase the power materially or give the desired result.

If the thermal efficiency be plotted against the consumption of fuel in pounds per 1,000 r.p.m. it will be noticed that the efficiency increases as the mixture gets weaker up to very nearly the weakest mixture on which the engine will run regularly. In this connection it was observed that with mixtures containing between 17.5 and about 19 pounds of air to a pound of petrol, firing back into the carbureter was liable to occur, while with mixtures either richer or weaker this effect was not observed, the reason in one case being that the stronger mixtures burn so quickly that all flame is extinguished when the new charge enters, while in the case of the very weak mixtures the incoming charge is so weak that it will not inflame until it is compressed. The spark was in every case so adjusted that the maximum power was developed.

As a result of plotting all of these quantities it was found that at all speeds the efficiency is a maximum at an air to petrol ratio of about 17, while combustion would theoretically be complete at all ratios above 14.

High Efficiency Very Noticeable—One of the most noticeable things in the whole series of tests is the very high efficiency obtained, the maximum being .276. For one thing this establishes the fact that thermally the automobile engine is not only on a par with, but actually is superior to, all internal combustion engines excepting only the Diesel motor. The efficiencies were:

Test	Compression Ratio, Etc.	Air Standard Efficiency	Air/Petrol	Actual Efficiency	Relative Efficiency	Air/Petrol	Actual Efficiency	Relative Efficiency	Air/Petrol	Actual Efficiency	Relative Efficiency
A	4.71	.46	17	.28	.60	14	.25	.54	11	.20	.44
B	4.35	.44	17	.27	.61	14	.25	.56	11	.20	.44
C	3.92	.42	17	.26	.63	14	.24	.58	11	.19	.45

From the form of the combustion chamber in this engine the author had hardly expected to get so high an efficiency, for the surface exposed to the hot gases during the ignition (constant volume phase) is large compared to the volume. Thus a rough estimate of the surface area gives the values shown in the table below. That this ratio could be very materially reduced is shown by the numbers given for a combustion chamber having no valve pockets, a hemispherical top and a flat-topped piston. In such an engine the ratio of surface to volume of the combustion chamber would be only about half what it is in the actual engine. The reason the large surface exposed to the flame during the firing of the charge has not a more serious influence on the efficiency may be that the metal is coated with

a layer of carbon; this layer being a bad conductor of heat, the surface actually exposed to the gas may be at a much higher temperature than would be the case with a clean metal surface, the other surface of the metal being water cooled. The presence of such a hot layer of badly conducting material would reduce the rate at which the hot gases lose heat to the walls of the combustion chamber. A similar argument does not apply to the portion of the cylinder traversed by the piston, since although there is a layer of oil, yet this layer is kept cool by the passage of the piston.

	Actual Engine.			Hemispherical Combustion Chamber.		
	A	B	C	A	B	C
Volume of combustion chamber.	184 cc.	203 cc.	233 cc.	184 cc.	203 cc.	233 cc.
Surface of combustion chamber..	370 cm ²	378 cm ²	393 cm ²	181 cm ²	190 cm ²	205 cm ²
Ratio of surface to volume	2.01	1.86	1.69	.99	.94	.88

Influence of Increased Compression—The result of increasing the compression does not have the effect that is generally supposed upon the mean effective pressure. By plotting the M.E.P. for the different mixtures three curves were obtained for the three tests, these being at three different compression pressures. In these curves it was shown that above a ratio of 14 any increase in the richness of the charge was not appreciable, while at that figure the M.E.P. only rises 2 pounds for a rise of 18 pounds compression—that is, at 68 pounds compression the M.E.P. was 83, while at 86 compression pressure the M.E.P. was but 85.

As the result of a close investigation into the composition of the exhaust gases and their relation to the power and speed, together with the theoretical composition of the exhaust, the author concludes that it is not safe to deduce the composition of the mixture supplied to a petrol engine from the results of the analysis of the gases made in the ordinary manner and on the supposition that the carbon all burns to CO₂, CO and CH₄, while the hydrogen is all present as water, CH₄ and free H. By means of the curves he does, however, think that the proportion of air to petrol can be deduced with sufficient accuracy for all practical purposes, and he hopes that the results will be of service to those who have to test carbureters and engines, as in many cases it is more convenient to analyze the exhaust gases than to measure the air and petrol.

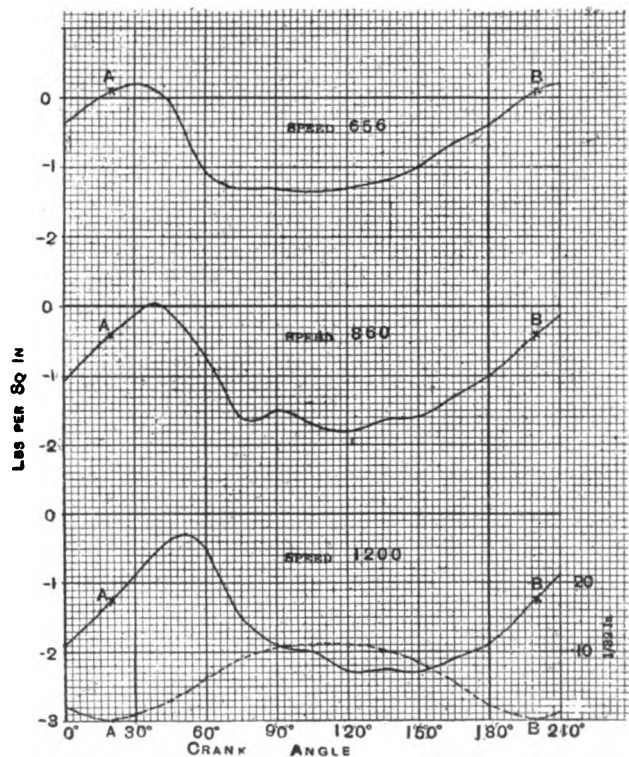

Inlet Pipe Pressure Continues to Rise After Valve Closes

EFFECT OF SPEED ON TIRE PRESSURES

By Charles B. Hayward

DESPITE S. F. Edge's carefully carried out experiments on Brooklands last year, designed to prove conclusively that the prevailing practice of inflating tires according to a schedule of pressures worked out by the tire makers wasn't of exceptional value, no one appears to have seriously accepted his findings that half inflated tires were quite the thing, either for the welfare of the pneumatic or that of the car. At least, few autoists are seen driving their cars around on half-pumped tires, except those who would be doing it anyway: the fellow who doesn't know as yet and is just buying his experience, and the lazy chauffeur, who is helping speed the boss's coin to the garagekeeper. Whether his own countrymen and fellow Britons take Selwyn F. at par value and regard him as an oracle in things motoring is a question that must be left to them to answer. He is with them, but not of them, for a more unbritish Britisher would be hard to find, at least where publicity methods are concerned. Somewhere back in his ancestry Edge must have had an American press agent, or a circus advance man, and S. F. is the result of an atavism. It seems difficult to explain his ability for keeping himself and his product so constantly in the limelight on any other ground. Whenever a "stunt" is pulled off in the autoing circles of the "Tight Little Isle," Edge is written large all over it, and the more unusual and extraordinary it is the more likely it is apt to be Edge. He crops up periodically in unexpected roles, and this tire business was one of them.

But, seriously, there is more in it than appears on the surface, and a little study of causes and effects throws considerable light on something that has been more or less puzzling to racing drivers ever since automobile speeds on the road got well above the mile a minute mark. Edge's experiments were designed to show that at high speeds and on a smooth surface it was possible to drive a car with partially deflated tires, not only without injuring the latter, but to their benefit, where the matter of endurance was concerned. Just how this worked out, or whether it actually did result that way outside of the published reports, is not the purpose of the present article to explain. As the result of his experiments Edge placed himself on record as advocating tire pressures considerably less than those recommended by the manufacturers and by automobile designers, on the ground that both easier riding and greater mileages would be obtainable. No experienced autoist has ever had any reason to doubt the former of these findings, but as already mentioned, few in this country, at least, appear to have given the latter the benefit of the doubt to the extent of trying it. Sustained high speed on a smooth and specially prepared surface, such as that of the Brooklands track, and the average touring speed over give-and-take roads present conditions that it is somewhat difficult to reconcile or draw any parallel between, so that in advocating the adoption of this expedient as a means of increasing tire mileages under everyday service conditions, Mr. Edge appears to have drawn somewhat

more liberally on the press agent's license than is usual with him.

Whether this be the case or not, is beside the question. No attempt seems to have been made to explain why it was possible to drive a car at high speed with partially deflated tires, when all authorities so urgently recommend maintaining the pneumatics at a certain pressure, proportioned to the weight they are designed to carry, for ordinary speeds. For that matter, regardless of the speed, and the natural inference would appear to be that the faster the car was to be driven the more need there would be of properly inflating the tires. In fact, the adoption of a schedule of standard sizes of tires for certain weights and the pressures to which they should be inflated to properly carry such loads was the first great step in advance made by the tire industry, and regarded in the aggregate probably did more to lessen trouble with the pneumatic than any other single factor. So much for the need for pressure. The reason, or at least what may be accepted as such, for attempting to undermine what has already ripened into the well established custom of regarding no tire as safe that is not pumped to a good pressure has been pointed out.

Racing Drivers Seldom Aware of Punctures—It is a matter of common knowledge to the racing driver that a puncture is seldom, if ever, felt at the moment it occurs when driving at high speed on the straightaway. When the writer interviewed Hemery, winner of the 1905 Vanderbilt on the Long Island course, shortly after the race, he said he was not aware of the puncture that came so near costing him first place, as was the case with Robertson driving the Locomobile in last year's event, and did not discover it until the lateral weakness of the tire mare itself apparent upon rounding a curve, although the original accident must have taken place two or three miles before reaching that point. Doubtless other racing drivers can recall similar instances. The best road course ever laid out is far from being related to the proverbial billiard table, and the speeds of considerably better than a mile a minute—close to 90 miles an hour, in fact—that were attained on the straightaway stretches, magnify an almost invisible ridge or depression across the road into a thank-you-marm of the most virulent Pennsylvania type. What prevents a punctured tire from collapsing under this terrific pounding?

Centrifugal force appears to supply an answer. It is a well established principle that a body acting under the influence of centrifugal force tends to leave the source of that force at a tangent and to progress in a straight line. The average road supplies an unending series of tangents, along which the car flying at high speed tends to travel, and would follow were it not that the superior attraction of gravity makes it adhere to the actual contour of the road surface. The wheels, turning at high speed, supply sources of centrifugal force at four points and the terrific inertia of the swiftly moving ton of metal tends to overcome the attraction of gravity, and the machine bridges gaps which at lower speed would be followed in outline. This



50 Miles



75 Miles



95 Miles

Dotted Line Shows the Tangent to Surface of the Earth Which the Cars Tend to Follow at Various Rates of Speed

is what is expressed in the vernacular by "hitting the high spots."

As the Speed Increases—It will be evident that as the speed increases these forces do likewise. Whether in direct proportion or in far greater ratio is difficult to determine offhand. In other words, when the car travels faster and faster, as in being "let out" on a straight stretch, it tends to describe what an artillerist would term a rising trajectory. The only thing that prevents this being visible to the unaided eye on an ordinary piece of road is the fact that gravity is still strong enough to keep the car on the ground, and fortunately, speeds have not yet attained a point where this universal force is overcome altogether. Otherwise, some raving drivers might have anticipated the achievements of the Wright brothers unintentionally long before they were ready to give their secret to the world. But where conditions are unusually favorable, such as those supplied by the numerous "dip-of-death" bridges spanning the roads that intersect the Long Island Motor Parkway, the effect is no longer invisible, and due to their terrific inertia the racing cars actually do describe a rising trajectory when leaving the upgrade face of the stretches leading to these bridges. This was strikingly shown by the photograph of Robertson's Locomobile, with all four wheels above the ground, that was taken during the last Vanderbilt race, and which is reproduced herewith.

It has already been pointed out that as the inertia and cen-

trifugal force developed by the moving car increase, the attraction of gravity is overcome to a constantly greater extent. This is equivalent to stating that at 70 miles an hour a racing car weighs far less than when running more slowly, or when standing idle. Actually, there has been no change to bring such a magic transformation about, otherwise entrants might be desirous of having their machines weighed as they passed over scales located in the center of smooth five-mile straightaway, where they could do their best. But in so far as the weight bearing on the tires is concerned, it is true. Therein lies the explanation of the possibility of running at high speeds on a punctured tire without the driver or his mechanic being aware of the fact that one of the rubbers has suffered. In a four-inch pneumatic, for instance, a pressure of approximately 80 pounds to the square inch is requisite to support the load represented by a car designed to carry tire equipment of that size, without permitting the walls of the shoe to bend unduly—a privilege that comes high. Taking the weight of the car at 2,200 pounds and that of the driver and his mechanic at an additional 300, it will be evident that when standing idle each wheel is bearing 625 pounds weight, distributed over a relatively small surface—that of the point of contact with the road—the external pressure per square inch is very high.

Under Ordinary and High Speed Conditions—When a tire punctures under ordinary conditions, the sum of these pressures is combined to force the air out through the opening thus made. But a similar accident at high speed is not attended by immediate results of the same nature. To a very great degree—dependent upon the rate of speed, of course—the tire is relieved of the tremendous external pressure it would otherwise have to bear, and while its internal pressure is more than sufficient to insure the hasty exit of the air, the tire does not collapse for the reason

just given. In other words, the car's speed makes it self-supporting to such an extent that on straight stretches it continues to travel upon a pressureless tire almost as if nothing had occurred, and Mr. Edge's experiments demonstrated that this was true in such measure that it was possible to drive a car at high speed on four tires inflated to far below their normal pressure. So much for that part of the theory. It is a valueless one, so far as any real benefit to be derived from it is concerned. However, an attempt has been made to show graphically just how it works out. This will be seen in the accompanying sketches. Taking the stretch of level road as representing the circumference of a circle of infinite radius, the dotted line is intended to depict the lifting effect of the combined forces generated by the speed of the car, as well as the tangent that it would tend to follow were its flight sufficiently fast to entirely nullify the attraction of gravity. Naturally, the degree to which this holds true must be assumed, though it seems quite probable that at from 75 to 95 miles per hour, the external pressure, or actual weight carried by the tires, is so far reduced as to become an almost negligible factor. No other deduction seems possible in view of the results of the experiments mentioned, when regarded in the light of the experience of racing drivers to the same effect. The rate of speed at which this assumes sufficient importance is also a matter for conjecture, though it seems quite

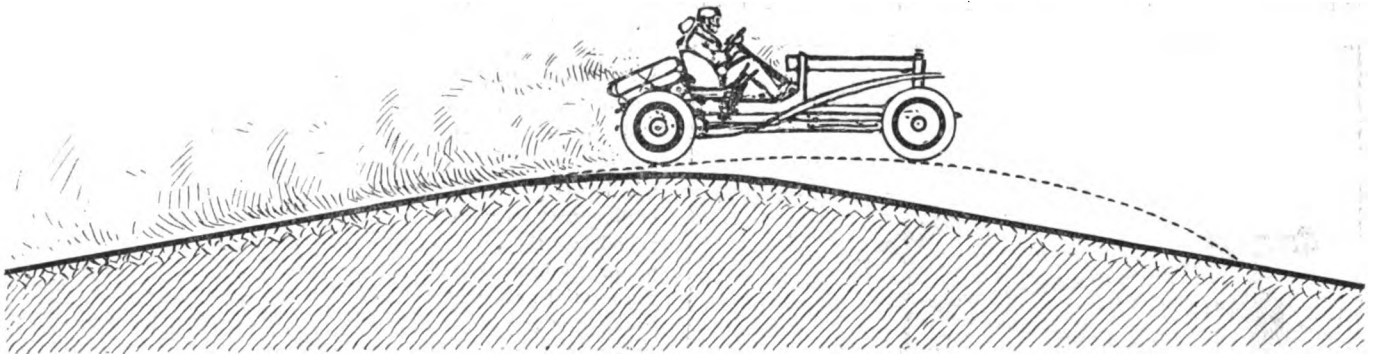

Reproduction of Trajectory Described by Robertson's Locomobile in the Last Vanderbilt Race

probable that the effect in question would be almost wholly lacking at less than 50 miles an hour. The rising trajectory has been plotted with these rates of speed as checking points.

The second sketch is intended to outline the trajectory followed by a racing machine crossing one of the Long Island Motor Parkway bridges at high speed, and is naturally exaggerated for the purposes of illustrating, though in reality it is not overdrawn to any great degree. How true this is may be judged of from the photograph depicting the actual occurrence. It will be evident from a study of the sketch that the conditions are usually favorable for obtaining this effect owing to the abrupt end of the grade and the corresponding drop on the other side, but a little study will show that this is but a reproduction of usual road conditions on a vastly enlarged scale, and the bodily departure of the machine from the ground is but a longer flight of the same nature that a car traveling at a great velocity is continually taking when it "only hits the high spots." The ease with which a car steers at high speed may also be regarded as evidence of the decreased pressure on the wheels of the weight of the car.

It may be thought at first sight that a flight such as that which the camera caught Robertson's Locomobile in the act of making in the last Vanderbilt, could only be possible under the unusually favorable conditions of road contour that there existed. But that this is the usual, rather than an extraordinary effect, to be expected under conditions at all similar, was shown by a photograph of Haupt's six-cylinder Chadwick leaving the ground at the top of Giant's Despair in the hill-climb a year ago. All four wheels of the car were in the air, but the effect was naturally not quite as striking, as a level stretch followed the brow of the hill and the speed attainable up such a grade could not be compared with that made on a cement straightaway.

Aids in the Art of Driving of a Car -

Part 4.

By D. R. Hobart

THREE things are to be remembered with regard to side slipping and skidding. First, either the front or rear wheels are liable to slip sideways if the driver attempts to alter the direction of travel suddenly on a greasy road. Second, rear or driving wheels when driving are more likely to lose their grip on the road than those which are rolling freely. Lastly, a spinning wheel or one which is locked loses its individual direction of travel and becomes simply a point of contact on the road. From this it will be seen that side slip is usually experienced with the rear wheels and depends on the application of the brakes, and the care in driving and that it need not necessarily result from taking a turn too rapidly or too sharply. This can be shown by driving a car along a greasy road and applying the brakes with sufficient force to lock the rear wheels. The car

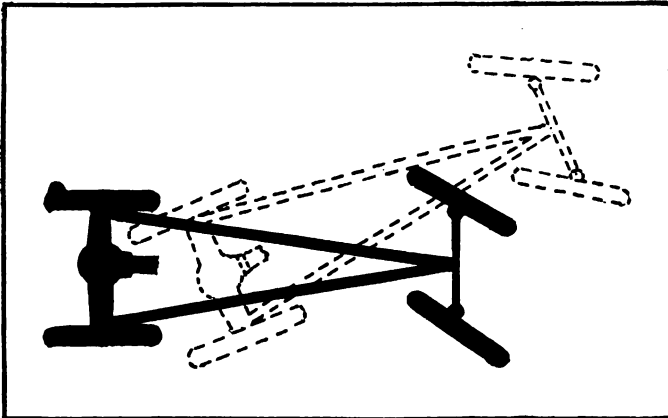

Illustrating a Front Wheel Slip

will immediately tend to turn end-for-end upon the road and even if the road is not greasy a sort of side slipping is set up, which can be corrected by the steering gear, in causing the front of the car to move sideways in unison with or to a greater extent than the rear wheels. If the rear tires cannot obtain any grip on the road, as they are being dragged over its surface the rear of the car is apt to swing around too quickly for the driver to check such a tendency in the brief time available. Side slips of this character can only be checked by either releasing the brakes and thus freeing the wheels or by causing the front wheels to keep the car parallel with the road as soon as the first signs of slip become apparent, since once the rear of the car has swung around to any extent the driver is powerless to bring it in position again by the manipulation of the steering gear. The wheels need not be actually locked in order to bring this about; all that is needed is for them to lose their grip on the road and this occurs when they revolve at a slower peripheral speed than that of the car or when driven at a higher speed than that at which the car is moving. Skidding usually occurs to cars which have front wheel brakes or to other cars when the driver is successfully continuing to counteract the accompanying tendencies to side slip.

Front-Wheel Slips Infrequently Encountered.—Front-wheel slips due to deviation of the car from a straight course or to excessive camber of the road are not often encountered even though the front wheels are usually fitted with smoother tires than the rear wheels. Such slips when they do occur are most

unpleasant, as the autoist has no control whatsoever over the car while they last. Generally speaking, a front-wheel slip occurs when a fairly sharp turn is being made on a road covered with greasy mud or when the road falls away steeply to the drains at the side. Judicious application of the brakes will often have the effect of straightening up the car as well as of retarding it, if there is sufficient room at the side of the road to which the slip is occurring, but the best way to check the slip is to bring the front wheels well around in the direction that is desired to be taken. By doing this, the front wheels tend to reduce the speed of the car and to squeeze the mud away from in front of them. The autoist must be on the alert to straighten them up immediately they obtain a hold on the road, as otherwise the car will move toward the other side of the road with startling rapidity. The sketch shows a typical front-wheel slip.

Slips Due to Acceleration or Retardation of the Wheels.—Rear-wheel slips due to acceleration or retardation of those wheels should be checked similarly to slips resulting from sudden alteration of the direction of travel. The differential gear on the car is likely to aggravate slips of this nature as the wheel which has the least adhesion to the road, by spinning forward at double speed, can relieve the whole of the drive from the other wheel and the car will slew around on the stationary wheel as a pivot. A brake on the transmission between the motor and the differential gear will cause the wheel that grips the least to spin backwards under the driving influence of the other wheel, and a similar slewing action is set up. The autoist should remember that both rear wheels must be on firm ground before the brakes or accelerator can be operated to overcome the slip. Imperfectly balanced hub brakes are a fruitful source of side slip of this nature as one wheel is called on to do the greater part of the braking and one locked wheel is pretty sure to throw the rear part of the car around sideways.

Slips on Ascending and Descending Hills.—Of frequent occurrence in general driving is the descent of steep and slippery hills. Obviously, the brakes must be used in order to keep the car under control, but the autoist often finds that their application causes the rear of the car to swing right around, particularly if one hub-brake has a better grip than the other. With smooth tires, that is, tires without studded treads or unequipped with chains, the situation is hazardous despite all anything the autoist may do, but in all cases such hills should be approached at a walking pace and the car prevented from increasing its speed by judicious use of the brakes the whole way down. A typical slip of this type is shown in the sketch, the dotted lines indicating the position often assumed by the car at the completion of the slip. Equally awkward is the ascent of a hill thickly coated with mud or ice. In such case, once the wheels commence slipping the car may tend to spin in a circle and to slip backwards while so doing to the bottom of the hill. If the hill is extraordinarily steep and greasy, several circles may be described if the car is small or has excessive clearance and the autoist will not have the slightest control over the car during the evolutions. In climbing ordinary hills that are greasy, a moderate speed should be maintained from bottom to top, avoiding any sudden acceleration of the road wheels, and momentarily easing off the drive to enable them to regain their hold at the first signs of excessive spinning. The ability to drive at a constant speed is invaluable to the autoist in cases like this. Where ascents or descents are hazardous, rope wound around the tire and felloe

is of the greatest assistance. Gunny sacking, lap robes or even newspapers laid on the road are excellent when the tires are unable to obtain any adhesion.

Typical Instance of Skidding—Skidding occasionally occurs when the autoist is endeavoring to bring the car to a stop within a limited space. On wet or slippery and even on dry roads at times it is difficult to pull up quickly if another vehicle has suddenly stopped a short distance ahead of the car. Setting the brakes introduces side slip at the rear, and while this tendency can be checked by means of the steering gear the forward skid will continue in many cases. The fault is, of course, on the part of the autoist in having approached the other vehicle at too great a speed consistent with the state of the road and with regard to the efficiency of his brakes. To obtain the maximum retarding effect under such circumstances, the brakes should be applied and released alternately with a quick vibratory motion of the foot, a powerful braking influence being thus brought to bear on the wheels, and the intermittent periods when they are free to roll enabling them to maintain their grip on the road.

Experience Teaches Suitability of Tires to Road Surfaces—As the autoist encounters various kinds of roads when driving he soon learns to know those that are slippery when wet or muddy and how any road should be negotiated with either smooth or non-skid tires. Where the road is greasy, smooth tires can obtain but little hold, whereas studded or non-skid tires are usually capable of reaching bottom through the coating or film and gripping the road. On the other hand, new non-skids will slip badly on Belgian block or other hard-surfaced roads while smooth tires will adhere nicely thereto. The same distinction may be drawn between smooth and studded or non-skid tires as between rubber-soled shoes and heavily-nailed boots in regard to certainty of locomotion.

Slow Traveling the Best Remedy—Whenever the road is inclined to be treacherous, slow traveling is the best remedy against side slips and skids. The autoist should avoid using the brakes at all if possible and this he can do only by concentrating his attention on the road at a much greater distance ahead, as regards speed, than is his usual custom. If a turn is to be made, or if the brakes have to be used he should take advantage of dry spots or any camber favorable to his purpose, as it is frequently possible to choose to some extent the exact course that is taken. For example, if a pull up or considerable reduction of speed will be necessary within the next few minutes, a lookout should be kept for less slippery spots which may be of service or at the least choose a portion of the road where the conditions are no worse than that over which the car is progressing at the time. The same thing should be done if a turn of any nature has to be made under the same circumstances. The risks of side slip can thus be reduced if not altogether eliminated. Various other methods of preventing side slips are used by autoists, depending on the circumstances, and these are the result of experience and in some cases suited only to certain cars.

Stopping for Any Cause—When stopping for any cause the autoist should bring the car over to one side of the road so that it will be out of the way of other traffic. In doing this a position should be taken up so that when the car is started again there will be no difficulty in getting under weigh. In bringing the car to the roadside, as in the sketch at A, the autoist not only allows others the use of the road but protects himself from being run into or hindered while making repairs, etc. On the other hand, autoists who are otherwise considerate sometimes remain in or near the center of the road as at B, if the stop is an involuntary one, and commence repairs, hindering others from passing and running the risk of being hit by other cars. The excuse usually given in such cases is that they did not know that the road was much traveled over, and thought that the center of the road was as good a place as any to stop.

Plenty of Space Should Be Allowed When Pulling Up—One of the mistakes committed by inexperienced, and indeed, quite a number of experienced autoists is in not allowing sufficient space on all sides when pulling up. It is a common occurrence to see the driver of a car backing and going ahead inches

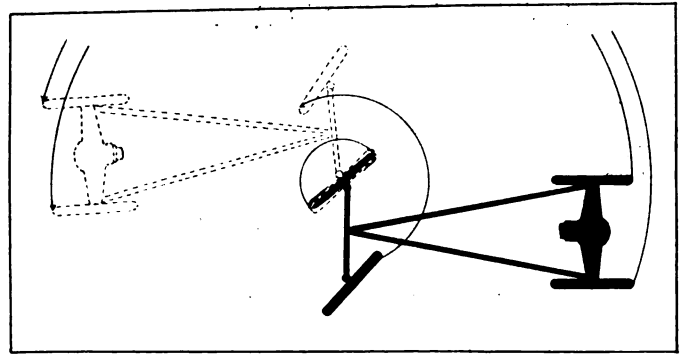

Typical Slip When Descending a Slippery Hill.

at a time in the endeavor to get clear of the curb which he has approached too closely. Occasionally also an autoist is seen who has driven up too closely to another car and left no room to get at the starting crank after the car has been pulled up and the motor stopped. The remedy is obvious; allow plenty of room in all cases. The car can be brought up to the curb and stopped with the front wheels turned slightly to the left, and the off rear wheel about a foot away from it. From this position there will be no difficulty in starting off when it is desired to do so.

Forethought When Making Repairs on the Road—It is obvious from what has been said in regard to stopping, that corners and narrow roads are not the safest places to conduct repairs in. Neither should a tonneau door be allowed to remain open nor tools be scattered over the road. A good habit to follow with regard to tools is to place those needed for the particular work on the running board, and as each has been used to return it thereto. In all cases the autoist should place the change gear lever in the neutral position and set the hand brake before leaving the seat. Accidents caused by the car running down the driver when cranking will thus be prevented. If the car is to be pulled up on a comparatively steep hill, it would be well to bring the front wheels around sharply and allow the off wheel to rest against the curb or bank at the side of the road.

Coast as Often as Possible—Coasting should be indulged in whenever the nature of the country and the amount of traffic on the road will allow it to be done with safety. Not only does coasting tend to economy in fuel but it allows the motor to rest, particularly if the latter has been working hard in climbing hills or running over heavy roads. When about to coast the motor should be declutched, the gear lever put in the neutral position and the motor slowed down to its slowest speed. If the hill is a long one, the motor may be stopped entirely, thus stopping the consumption of fuel and the wear and tear on the motor and allowing the latter to cool off. With sliding gears, the high-speed position can be used instead of the neutral whether the motor is running during the coast or not. At the top of a long hill the switch may be thrown off after declutching, but before the end of the hill is attained the ignition should be switched on and the clutch let in gently, starting the motor by the momentum of the vehicle. The autoist should always employ the highest gear when starting in this manner as the stresses imposed on the mechanism through using a lower gear would be too severe, and might result in a bad breakdown.

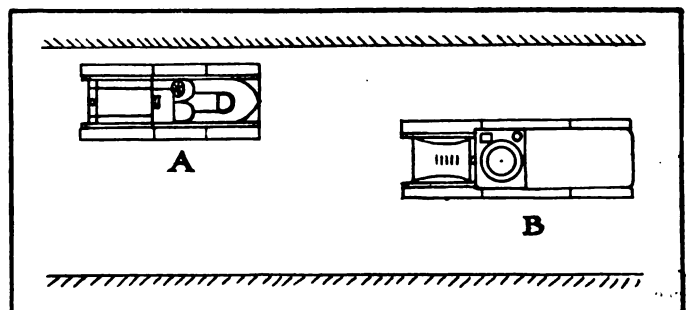

Proper and Improper Positions When Pulling Up

SOME SELECTED AUTOMOBILE PATENTS

Issue of May 18, 1909

- 921,897. Automatic Cut-Off for Gas. Ludwig Schmidt and Herbert Schmidt, Kaiserswerth, Germany. Filed March 6, 1909.
- 921,933. Engine-Starter. Daniel C. Wilgus, Los Angeles, Cal. Filed March 29, 1907.
- 921,936. Antiskidding Device for Wheels. Robert M. Winsch, Lansdale, Pa. Filed Feb. 15, 1909.
- 921,963. Automobile Vehicle. Leonard H. Dyer, Washington, D. C. Filed Feb. 3, 1900.
- 921,978. Compensating Gear. Edwin J. Gould, Boulder, Col. Filed April 13, 1908.

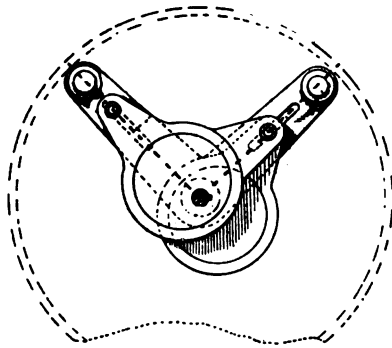

Gould Differential Substitute

The Gould substitute for a differential, shown herewith, was the subject of a spirited discussion in the technical press about a year ago, or, to be exact, as soon as Gould published an account of his device, which he did as soon as he had applied for the patent. The discussion developed the principles of the gear, which were thrashed out very thoroughly. As to its actual use, only time can show what it will do. The idea is a move in the right direction, for it replaces a complicated and expensive piece of mechanism, with a simple, cheap, and, as the inventor claims, a superior device.

921,994. Variable-Speed and Reversible Gear. George P. Innes and Thomas Con Allen, Sydney, New South Wales, Australia. Filed May 18, 1908.

922,145. Carbureter. Albert Howarth, Providence, R. I. Filed May 31, 1907.

Howarth, too, is working for simplification, his carbureter being without the usual float chamber, and the spraying nozzle being much

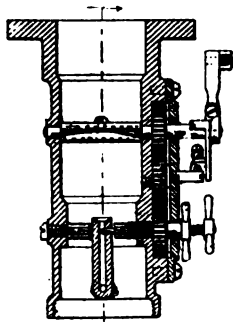

Howarth Connects Throttle and Spray

simpler than is the ordinary case. One new idea which he has worked in is the connection of the throttle with the nozzle by means of gears so that they work together.

922,009. Gasoline-Engine. Gustavus H. Marquardt, Cassville, Mo. Filed Aug. 27, 1908.

922,044. Steering Mechanism for Vehicles.

Albert F. Rockwell, Bristol, Conn. Filed Nov. 3, 1905.

922,057. Automatic Swivel-Lamp for Automobiles. Julius O. Spang, Halleybury, Ontario, Canada. Filed Dec. 17, 1908.

922,278. Automobile-Wheel. Ole A. Hamre, Arriba, Col. Filed July 26, 1907.

922,308. Rear Axle for Automobiles. Frederick C. Miller, Cincinnati, Ohio. Filed July 16, 1908.

922,402. Demountable Rim-Tire. Alexander Dow, New York, N. Y. Filed Dec. 30, 1908.

922,403. Locking Device for Demountable Tire-Rims. Alexander Dow, New York, N. Y. Filed Jan. 29, 1909.

922,404. Demountable Tire-Rim. Alexander Dow, New York, N. Y. Filed Jan. 29, 1909.

Issue of May 25, 1909

922,454. Vehicle Spring. Lewis C. Burnet, Newark, N. J. Filed Sept. 11, 1908.

Burnet's compound spring is well known to readers of this paper, particularly those who read the advertisement pages. In this, as the patent drawing shows, there are two full elliptic type springs superposed, one being directly above the other. The upper one is fastened to the automobile frame in the ordinary manner, while the lower follows usual practice in its attachment to the axle.

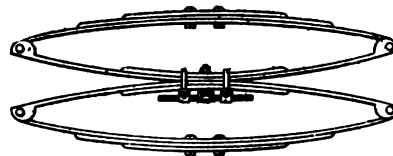

Burnet's Compound Spring

922,489. Motive Power for Automobiles.—Edward S. Lea, Trenton, N. J. Filed Nov. 9, 1907.

922,528. Cut-out Attachment for Internal-combustion Engines.—Benjamin F. Sheibley and Wilhelm Moller, Lewiston, Pa. Filed April 25, 1908.

922,563. Muffler Cut-Out Mechanism.—Lee S. Chadwick, Pottstown, Pa. Filed March 8, 1909.

922,599. Reversible Transmission-Gearing.—Moses W. Kouns, Columbus, O. Filed May 4, 1908.

922,613. Internal-Combustion Engine.—Charles D. McClintock, Oakland, Cal. Filed June 23, 1908.

922,631. Pneumatic Tire.—Frank Reddaway, Pendleton, Manchester, England. Filed Feb. 18, 1908.

922,658. Spring-Wheel.—Elias B. Anderson, Rock Falls, Ill. Filed June 25, 1908.

922,669. Spare-Tire Cover.—Hyman Cohen, Brooklyn, N. Y. Filed Dec. 21, 1908.

922,673. Ignition System for Internal-Combustion Engines.—Mark B. Crist, Pittsburg, Pa. Filed Feb. 15, 1906.

922,741. Exhaust-Dissipating Apparatus for Motor Vehicles.—George E. Whitney, Boston, Mass. Filed Dec. 1, 1899.

922,964. Antifriction-Bearing.—Joseph E. Downer, Allentown, Pa. Filed May 29, 1908.

922,916. Brake-Operating Mechanism for Motor-Vehicles.—Paul Krause, Babylon, N. Y. Filed Aug. 26, 1908.

922,939. Spindle-Joint for Automobiles and Other Vehicles.—John A. Myers, Braddock, Pa. Filed Oct. 17, 1908.

922,965. Clutch Gear for Hubs of Ve-

hicles.—Bernhard Settergren, Chicago, Ill. Filed June 6, 1906.

922,987. Electric Igniter for Explosive Engines.—Emil Westman, Minneapolis, Minn. Filed Oct. 5, 1907.

923,044. Gear-Transmission Mechanism for Automobiles.—Edward J. Gulick, Mishawaka, Ind. Filed Aug. 15, 1907.

923,045. Torsion Tube-Support for Rear Axle Housings of Automobiles.—Edward J. Gulick, Mishawaka, Ind. Filed Sept. 13, 1907.

922,509. Compound Explosive Engine. Sidney A. Reeve, Worcester, Mass. Filed June 18, 1906.

There have been a number of attempts to produce a slow burning rather than an explosive engine, along the lines of Brayton.

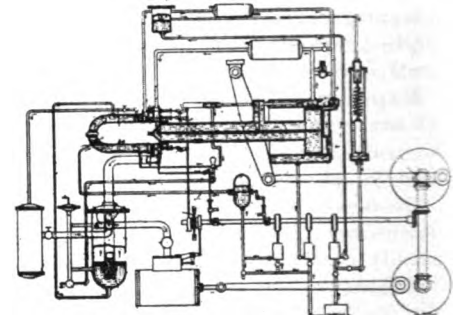

Reeve Compound Explosive Engine

the great American pioneer. Of those interested in the subject, Professor Reeve is prominent, and the patent specification and drawing show the outlines of his proposed system. In the drawing too many parts are perhaps included, so that the main idea is rather beclouded, but the idea is there, at last put into working form. The Brayton, and consequently the Reeve, come in what is called the first class. This is the type of gas engine igniting at constant volume but without previous compression, and represents, in principle at least, the simplest and most apparent method of obtaining power from gas.

922,911. Internal-Combustion Engine.—Thomas D. Kelly, Essex, England. Filed Nov. 8, 1907.

In the van of the parts which are now receiving the attention of inventors, engineers

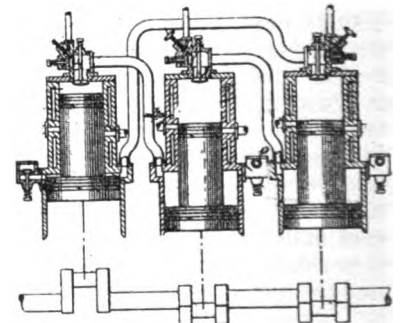

Differential Piston Two-Cycle Engine

and designers, is found the engine, and prominent in these are the attempts to improve over the two-cycle form. Kelly has used the differential piston type, and uses the three-cylinder form. The first cylinder, at the lower diameter compresses the charge for the upper or explosive part of the piston in cylinder number two, the lower part of which performs a like function for number three. The latter, in turn, compresses the gaseous mixture for the first. The most apparent objection is the extremely large compression space necessary.

Letters Interesting and Instructive

FRICTION DRIVING

Editor THE AUTOMOBILE:

[1,905]—Please inform me through the columns of your paper if a friction-driven car is considered just as strong a car going up the hills as a direct-drive rear axle. Would also ask you to furnish the names of manufacturers who can supply parts for this type car, that is, the friction drives. W. H. S. New York, N. Y.

It is generally considered that the efficiency of chains is superior to that of bevel gears, so that chain-driving presents advantages over the shaft drive. Yet the majority of cars are shaft driven. From this it is evident that other considerations than the mechanical efficiency govern the use of any device. So it is with the friction drive, good as it may be, the American people did not take to it, and as a result there are not many cars built using this form of drive. In some ways it is logical, for do not all cars ultimately drive by means of the frictional contact between the wheels and the road surface? Also, in the case in which a clutch is used, is not this a matter of frictional surface transmitting power.

Yet, in the face of all this reason, the form is not popular and the number of cars produced is small.

As to the firms making parts for such cars, at the present moment but one is recalled, the High Wheel Auto Parts Company, Muncie, Ind.

FRONT DRIVE ADVANTAGES

Editor THE AUTOMOBILE:

[1,906]—Will you please give me some idea of the reasons for the use of the front wheels for driving a car? Does not this complicate the mechanism of the car as a whole? Could you give a list of cars which are now made with this form of drive and the addresses of their makers? G. K. O'HARA. Chillihothe, O.

There are a number of reasons advanced for this construction, chief among which are: absence of side slip usually spoken of as skidding; shorter turning radius, due to increased angle of steering lock permitted by this form of construction; pulling the car rather than pushing it is more rational and is said to be more efficient; concentration of parts in one position, and that an accessible one, allows of minimizing trouble, and thus locating it more easily; the concentrated construction allows of a number of minor economies which, on a large scale, might develop the whole into a lower-priced form.

Some of these reasons for the front drive are worthy of more than passing mention, thus the entire absence of skidding, if it could be proven, would more than offset the mechanical complications incident to driving and steering through the same wheels. The exact proportion of automobile accidents due to side slipping probably will never be known, but if it

were known it would be very large. In the crowded streets of the larger cities the problem of turning around is a large one, for narrow streets will not allow of several successive backing up operations necessary in the turning of a large car. Then, too, the backing-up process requires a reverse speed, which under favorable conditions could be eliminated with a very short turning radius. This latter simplification would reduce cost, weight, make the control simpler and easier to understand, and through the medium of lesser weight would reduce operating expense.

The pull versus push proposition is one of theory, and the efficiency, or lack of it, innate in either form has never been proven, at least conclusively. As a matter of pure reasoning, however, it sounds well.

The last mentioned reason carries the most weight, for incident to the concentration of parts into a small compass is the possibility of uniting them into a single unit, which has been given the name of a "fore-carriage." This would be removable as a unit, and therefore would allow of its instant removal and the equally quick substitution of another. In any public service passenger or goods carrying business this is a reason that would outweigh any which might be brought out against the cars, for this form of construction allows keeping the vehicles in service and therefore earning money for the largest possible part of the time.

It is not possible to give a complete list of the makers of front drive cars, as this would mean too much space, and no such list has ever been compiled so is not at hand. Three makers who are known to be building front drive cars are: Christie, New York City, a description of whose car is given in this issue; Haydock Automobile Company, St. Louis, Mo., and the Four Drive Traction Company, Mankato, Minn., the latter firm's product being both front and rear driven—that is, what is called four-wheel drive.

FROM NEW YORK TO DENVER

Editor THE AUTOMOBILE:

[1,907]—I am contemplating taking a trip from Buffalo to Denver this summer. Will you please, through your "Letters Interesting and Instructive," tell me the best route. This can best be done, I think, by naming the towns and cities through which we should pass. OTTOMAR O'DONNELL. Fishkill-on-Hudson, N. Y.

Section 4 of the official A. A. A. Blue Book, which will appear early in July, will give the roads from Buffalo to Omaha, Neb., passing Cleveland, Toledo, South Bend, Chicago, Clinton, Ia., and Omaha, Neb. Beyond that point the road would take in Grand Island, Neb., Julesburg, Fort Morgan and Denver.

STARTING ON MAGNETO

Editor THE AUTOMOBILE:

[1,908]—Will you kindly state, to settle an argument, whether it is possible to start an engine on the magneto, not once nor twice, but regularly every time? BEN DAY. Hoboken, N. J.

It is not only possible, but very probable, since as a matter of fact a number of the good small French cars have no other source of ignition, and an increasing number of our best American cars are being fitted up in this manner. Nearly all of the magneto manufacturers are marketing some device to aid in spinning the armature or otherwise helping to produce a spark the first time, no matter how often it is tried. Very recently, in these columns, a device called a switchstarter was described, the function of which was to send a sudden current through the primary windings as soon as the switch was touched. This actuated a contact breaker, which sent current from a special accumulator through the primary armature circuit.

Another device was in the nature of a clutch, which was operated to free the magneto shaft when it was desired to start the engine. This being free, other forms of mechanism whirled the armature around very rapidly several times, invariably producing the desired spark. The clutch automatically slid back into place when the motor had been started and was running normally. Other and equally successful devices have been brought out for this purpose, their action being so certain that one is safe in saying as above that it is perfectly possible to start on the magneto not once or twice, but every time.

DUAL IGNITION QUERY

Editor THE AUTOMOBILE:

[1,909]—Will you please give me some advice on the subject of dual ignition? I am about to buy a car and am in doubt between two makes, one with dual ignition, and the other with magneto ignition only. Which would you advise and why? Poughkeepsie, N. Y. T. H. LLOYD.

It is a fact that the progress in igniting apparatus, in magnetos particularly, during the past year has been remarkable, and as sold to-day they are very efficient and reliable. Starting has always been the magneto "bugaboo," but the up-to-date magneto has overcome this and stands on a par with any other obtainable source of ignition in this respect.

This being the fact, why would you wish to complicate matters with an additional system which you will never use unless you have an accident to the major system? If the latter is not reliable, why put it on at all? If it is reliable, why not depend upon it and dispense with extra weight, cost, mechanical and electrical complications?

It is urged against the use of a single

system, that it is similar to putting all the eggs in one basket, so that any accident puts the car *hors de combat*. But if a second system is provided, one simply switches over to it and comes home as if nothing had happened, the major ignition being fixed up at leisure. It is reasonable to assume, however, that a minor system carried for hundreds or thousands of miles preparatory for the accident that may happen may itself get out of order, so that when called upon it cannot respond. In this case the cost, weight, and complication would go for naught.

The experience of millions of miles running with the cars of a public service corporation abroad proves that with two complete and distinct ignition systems the drivers are careless with both on the assumption that if one gets out of order the other can be used. With single ignition it is necessary to take care of the system, for it is the *only* source of current. The added care necessary in the latter case resulted in a very large saving upon the universal adoption of a single source of current, and it just happens that this was the form which has been argued for above, namely, the magneto system.

Without knowing the two cars which you have in mind, or without actually advising you which one to purchase, it would seem best for the beginner to begin on a car with single ignition, whichever form that may be, although the argument, as given above, has seemed to favor the mechanical current generator.

PERCENTAGE OF GRADES

Editor THE AUTOMOBILE:

[1,910]—Won't your figures in regard to the grades on the Pacific Coast, referred to on page 833 of the May 20 issue of "The Automobile" bear revision?
An average grade of 13 per cent. for a distance of 160 miles would certainly be "some Alps."
E. C. HILLIARD,
Hartford, Conn.

Our correspondent is correct in his statement that this would be "some Alps." The mistake made by a contributor, and not checked up by us, simply goes to prove that the oft-reiterated statement that per cent. and actual rise of grades are not generally understood contains more truth than poetry or fiction.

Yet this is very simple, the per cent. of any grade, just like any other per cent., is the number of parts in a hundred, in this case, the number of feet rise in one hundred. The easiest way to figure grades is to reduce the length of the slope to feet and divide by one hundred, or what is the same, point off two decimal places. This gives the number of hundreds of feet. Now divide the total rise by this, and the result will be the per cent. of the grade.

Figured on this correct basis, the statement on page 833 of THE AUTOMOBILE should read as follows: "This gives an average grade of .24 per cent., and good braking will be at a premium. The next day, from Oakley to Salina, there is a drop of 1,818 feet but the distance is nearly

200 miles, so the average of grade is a little less than .18 per cent."

As very appropriate right here, a table of grades taken from *The Automobile Trade Directory*, is given herewith. In this the rise is given in feet per mile, but if this misleads anyone, it is a simple matter to divide the whole last column by 52.8, which reduces the figures found there to feet per hundred as described above.

TABLE OF GRADIENTS

Grade. Per cent.	Units.	Equal to Angle of	Rise in One Mile.
20	1 in 5	11° 19'	1056 feet
17	1 " 6	9° 28'	880 "
14	1 " 7	8° 09'	754 "
12.5	1 " 8	7° 08'	635 "
11	1 " 9	6° 17'	586 "
10	1 " 10	5° 43'	528 "
9	1 " 11	5° 11'	480 "
8	1 " 12	4° 48'	440 "
7.75	1 " 13	4° 24'	406 "
7	1 " 14	4° 05'	387 "
6.5	1 " 15	3° 49'	362 "
6.25	1 " 16	3° 35'	330 "
6	1 " 17	3° 22'	310 "
5.5	1 " 18	3° 11'	293 "
5	1 " 19	3° 00'	277 "
5	1 " 20	2° 52'	264 "
4	1 " 25	2° 18'	218 "
3.3	1 " 30	1° 55'	185 "
2.8	1 " 35	1° 38'	151 "
2.5	1 " 40	1° 26'	132 "

EIGHT-CYLINDER ENGINE

Editor THE AUTOMOBILE:

[1,911]—Will you kindly give me the name and address of the firm making the eight-cylinder engine illustrated and described on pages 744 to 746, issue of "The Automobile" for May 6? Also would you explain if it will run as smoothly as an ordinary six-cylinder?
F. R. BROSIUS.
Columbus, O.

The engine is named the E. N. V., after the firm making it, the latter also being called E. N. V. Motors, Ltd. The works are located at Rue Saint-Germain 23, Courbevoie, Seine, France.

The matter of smooth running depends upon the torque, which was discussed in full in the article in question, so that there is no necessity for going into it again and in this place. As for a direct answer to your question, this would be yes.

MORE ACID IN OILS

Editor THE AUTOMOBILE:

[1,912]—In re your reply to No. 1894, is it not possible to detect the presence of acid in lubricating oils with litmus paper?
Milwaukee, Wis. CHAS. W. NOKRIS.

While litmus paper is extensively used for the detection of the presence of acid, it is believed that it is not delicate enough for this purpose, the amount of acid present in oil being usually very small. The methods given, on the other hand, are used for very delicate work, and will indicate correctly the presence of even the slightest trace of the destructive acid.

For the benefit of those who are not familiar with litmus paper, it might be described as an unsized paper saturated with a certain solution and cut into small short strips of perhaps one-quarter inch width by two inches length. One of these strips inserted in a solution containing acid, loses its natural colorless appearance and turns an angry sort of pink color. When inserted in an alkaline solution, on the other hand, it turns to a bright blue. The

color is the same in the presence of much or little acid or alkali, so that at best its use but indicates the presence and not the amount of either.

It is repeated that the very small amount of acid in ordinary oil probably would not color the paper, so that its use, while possible, would indicate nothing. The test given in answer to 1894 was an accurate test, and shows not only the presence of acid, but also the amount.

SOME ANCIENT HISTORY

Editor THE AUTOMOBILE:

[1,913]—Your recent editorial on tire sizes is correct and along right lines, but your history is slightly in error. Large-sized tires have always been obtainable and the Duryea which won the first American auto event in November, 1895, was fitted with 44-inch and 48-inch single tube tires of 2-inch section. The three Duryeas which scooped all prizes in the second event, the Cosmopolitan race, Decoration Day, 1896, were fitted with 34-inch and 38-inch tires of 2½-inch size, single tube. A few Duryeas were built in the next year or two with 30-inch and 34-inch tires, but the standard of 30-inch front and 36-inch rear, both 3-inch size, was adopted in 1898. The first few of these were single tubes, but the Dunlop tires of those days were not made in molds and so could be had in any size desired and they were adopted shortly after this and used steadily since. Duryea Buggyauts are fitted either with these sizes of pneumatics or with 38-inch and 44-inch solids of 1½-inch and 1¾-inch size. Being identical in construction, they give a chance to compare the results as your wish expresses.

No very accurate comparisons have been made, but the difference is noticeable. The small wheels drop into the holes in the road and toss the riders more than do the large wheels and solid tires. On the other hand, the air tires swallow the rocks and stop the myriad small vibrations much better than the solid rubber on the large wheels. The air tires and small wheels do not roll so easily ordinarily, for the large tire must flatten the dust, sand, mud or snow, whereas the narrow tire cuts through. At speed the favor is with the air tire, but the best time between Reading and Philadelphia is held by the car with solid tires and large wheels. My feeling is in favor of large wheels with solid tires. That if fitted with pneumatics, they would be better goes without saying.

In my experiments I have simply tried to get the size of wheels which, with solid tires, would ride practically the same as the most-superior, commonly-accepted air tire sizes.

I have also experimented with solid tires of same wheel diameter as the pneumatics, but although these were as large as 2-inch or even larger, they were noticeably objectionable. The large wheel has merits that can not be denied. Just how large the wheels can be with good results I do not know. Carriage makers, after generations of use and experiment, stick pretty close to 44-inch front and 48-inch to 50-inch rear. Roads are slowly getting better, which will allow slightly smaller sizes. Auto speeds are higher and being fitted with better rubber or air tires, the auto wheels should be somewhat smaller. Having satisfied myself that 36-inch is the low limit for wheels that carry much load, I do not look for much increase above this.

Makers generally will hold to the lowest that the public will take. That this limit is not a guess is pretty well proven by the fact that users of Duryeas seldom carry an extra tire. Extras are confessions of weakness. One user writes me in the last few days and says "Two of the tires have not been off the rims in three years and still folks complain about tire troubles."

The reason why small tires were used was because the maker wanted to save money and so supplied the smallest tire he could get the public to take. Further, the tire maker guaranteed the product, so the maker had very little care as to what size went on. Not till the makers kicked did sizes increase. Yet many of the older makers fought hard for larger sizes. Haynes, for example, stuck to large wheels from the very first. Winton did much the same. The toy steamers are largely responsible for saddling the industry with bicycle-sized tires. Certain it is that practical rigs should never have used them, and a large percentage of our auto troubles have arisen from wheels too small, with consequent discredit to the industry.

CHARLES E. DURYEA.

A MACHINE OF ABSORBING INTEREST TO FARMERS

DRUDGERY marks much of the daily routine work of the average farmer's life, and any device which promises to reduce this purely repetitive work of the farm, and is not too radical, is finding ready adoption among the up-to-date tillers of the soil. The invasion of the country districts by the automobile is an accomplished fact, so that a machine resembling an auto or having a similar source of power would not come

in the "too radical" class. For this reason as much as for its intrinsic merit a newcomer in the farming machine line, constructed by a Western man and herewith illustrated, will find instant favor with the farmers.

It is called a "hay-buck and stacker," from the work which it is intended to perform, namely, that of collecting hay from the fields, bringing it to a central point, and stacking it there. In addition, however, a number of attachments may be made to the original hay-buck, fitting it for as many other duties, and by their very large number making the whole machine

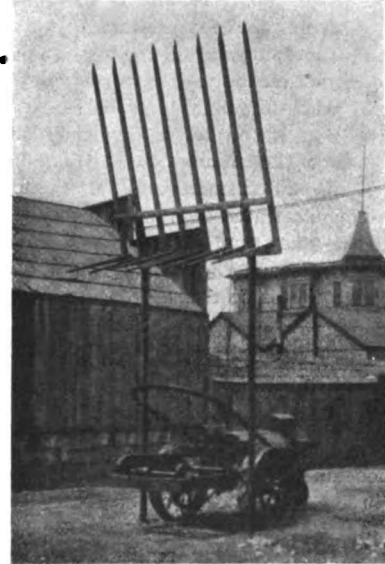

Rear View, Ready for Stacking

a farming implement applicable on every farm, by every farmer.

The "Hay-buck" is the invention of Jacob E. Liebhart, a rancher residing near Los Angeles, Cal. Mr. Liebhart's prime idea was to reduce the hardships and expense of farming by means of a mechanical device which would do the same work at the expense of a less number of horses and a largely decreased number of farm hands.

After proving out the first machine to his satisfaction, he added, without impairing the original functions, successively a plow, a cultivator, seeder, cutter bar, rake, scraper, ditcher, and grader. The additions take the whole machine out of the class of specialized machinery for a single line of work, and thus suitable only for large ranches where the expense of a machine is trifling in comparison with its annual saving, and by making it able to do grinding and cutting of feed, weeding, pumping water, harvesting beans, beets, etc., and many other kinds of work always done heretofore by horses, puts it into the class of minor economies, which every farmer must practice to compete with his natural opponents, his neighbors.

The machine is propelled by a two-cylinder vertical 20-horse-power automobile engine, and may perform all of its functions with the assistance of but two men.

A Comparison with Old Methods—With the horse-operated hay-buck and stacker, as used at present, eight horses are required, as well as three hay-bucks, a stacker, wire cable and the other parts to make up a complete outfit for moving hay from shock to stack. This outfit costs about \$1,500 and requires seven or eight men to work it at an average cost of \$20 per day. Its use is restricted to two months of the year, and during the remaining ten months must stand idle, in which situation it represents unproductive capital in a place where capital is scarce and every dollar should be at work all of the time.

In case of accident or delay the expense of both men and machine continues, and even while in use the deterioration is large unless the machine is carefully housed. When not in use

the very size of the old-fashioned machine calls for excessively large storage houses; moreover, a large space is required for operation and wide bridges for its accommodation when moving from place to place. All of these items, added to the large amount of money tied up, made it expensive to possess.

Horses Are Both Crude and Clumsy—Added to the economical reasons which militate against the older form, the sources of power—horses—are crude, hard to handle and awkward in operation. Each team averages about one and a half miles per hour. A team drives out, picks up three shocks of hay, turns and pushes back to the stack. After unloading they back off, turn again and are driven back to the starting place to begin over. At the stack the load is hoisted and dumped at a considerable loss of time, and at best in a tangled mass. This is difficult to handle, and requires the laborious efforts of three men, whose efforts are greatly hampered by the necessity for dumping all of the hay in one spot. This is required by the fact that the stacking machine remains stationary during the completion of a stack.

The single position also results in producing an uneven stack, which is solid in but one place, both of which items add to the cost of baling. Not only does the work of the horses cause trouble and the inherent difficulties of stacking add to this, but the day's "stunt" is frequently decreased by the breaking, kinking, cutting or heating of the cable.

A stack having been completed, much time is consumed in moving to a new position, during which interval the men and machine are busy, but producing no effective results.

Newer Method Saves Both Time and Money—The "Auto-Hay-buck and Stacker" combines all of the parts into a single machine, requiring but two men to attend it, horses being eliminated. The two men are placed, one on the machine and the other on the stack. Cost of operation falls in this way to less than \$7.50 per day, almost one-third of the previous cost for labor alone. On the operation of bucking and stacking hay the automatic averages from four and a half to five miles per hour, over three times what the best horses can produce. Moreover, the machine runs equally well backward or forward, so that no time is lost in turning or backing. The engine can approach the stack from any side, so a more symmetrical stack results, this being effected with less men and less labor on the part of the men. The man on the seat of the machine has a comfortable seat, and by changing off with the man on the stack both are more comfortable all of the time, and thus able to do more work, or, if necessary, to work longer hours. The resulting stack being even, is baled more readily and quickly.

There are two sizes of the machine as now built, and the smaller, which is suitable for the ordinary small farm, costs about \$1,500. With all of the various attachments it can be worked continuously in the field, in the grading camp, on the road during the

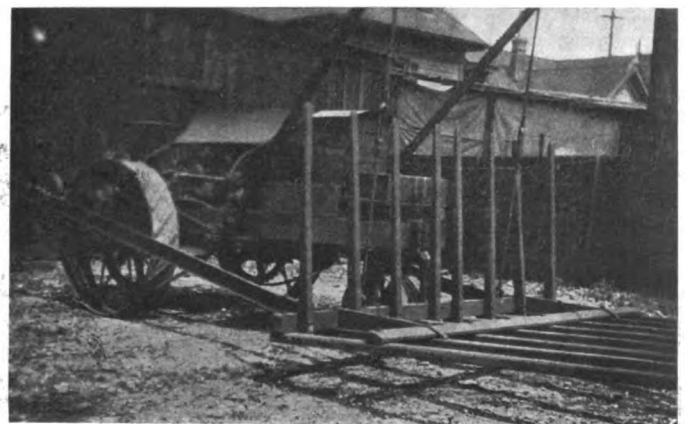

Seen at Closer Range When Starting a Stack



Six-Horse Team of the Nineteenth Century Hauling Ore on Desert Road

day and pumping water at night. It can be handled or stored in a small space, and will cross normal-sized bridges.

Easy to Understand and Operate—In case of accident or delay but two men and no horses are standing around idle. The mechanism, being simple, is readily repaired, and the same simplicity makes it easy to operate. The automobile engine used is beginning to be familiar on the farm, and the operation of the hay-buck is therefore easily understood.

From a humanitarian point of view, it is a distinct advantage as well. The process of stacking and bucking hay is a hard one, the ground around the stacker gets cut up to quite a depth and makes the work hard on the horses, while moving the stacker is equally hard on them.

OLD AND NEW ON THE DESERT

By H. H. DUNN.

Side by side on the old Dagget road, which leads from the mining camp of Ord to the old town on the Salt Lake railroad, twentieth century methods are competing with those of the nineteenth century.

Once a narrow trail, followed by creeping burros laden with sacks of ore heavy with gold, the way has been widened until it has become a broad path from camp to town. First to cause this widening were the teams of six to twenty horses driven by the men who hauled the ore down to the railroad cars. But now has come a new conqueror to the desert.

All the terrors of the waterless, sunburned road have given way to this new steel monster, which, carrying its own food and water, eats up the miles relentlessly, drawing behind its broad wheels—for it is a modern improved traction engine, built especially for the desert—wagons which carry fifty tons of ore where the old horse-drawn wagons carried ten.

Progress with the new tractors is as fast as the walk of the teams that once pulled ore wagons over this trail, and today the engineer waves his hand to the teamster as each gives half of the road to the other in going to and fro between the camps. But the horses and their drivers are fast passing from the trail; where once were dozens of these teams there are now only the few whose contracts with the mining corporations give them sufficient work. The steam tractor, which has recently

conquered the terrors of Death Valley and is now making its way into other parts of the desert, is taking their place and doing the work of several teams at less than the cost of one.

For some of these engines fuel is brought in in the shape of tanks of oil, but the roots of the greasewood bushes alongside the road furnish most of the material with which steam is kept up. Water is obtained from the same storage tanks that supplied it to horses and men on the trail in former days, with this in favor of the tractor, that less water is required than for the animals. As it is, the thread of smoke and the screaming whistle of the tractor trailing its trains of hundreds of tons of ore over the level floor of the great sand flat present a vivid contrast to the long lines of horses and the choking clouds of dust that once crept slowly over the same trails.

CLEVELAND TRADE IN INDUSTRIAL DISPLAY

CLEVELAND, June 7—Automobiles play an important part in the Cleveland Industrial Exposition which opened here this evening. The exposition is solely for the benefit of Cleveland manufacturers, and is intended to boost home industries. All kinds of manufactures are included in the exposition, provided they are located within the limits of the city of Cleveland.

Not even the originators of the movement realized how the automobile manufacturing trade had progressed of late.

All the local factories are exhibiting, including Stearns, Peerless, Royal, White, Gaeth, Winton, Baker, Rauch & Lang and Broc (electric), while all the many parts and accessories made in the Forest City are also shown. The Elwell-Parker Company, manufacturer of electric chassis, has quite a display, while the Perfection Spring Company and many others are prominent.

Farmer Thought Auto Was a Locomotive—Down in Texas it is said that there is a greater demand for automobiles than in "any other State of its size in the Union," but at least one man there was not familiar with the auto until recently. He was then forcibly introduced. In walking along the road he was struck by an auto whose driver had blown his horn loudly and expected that the pedestrian knew what was coming. After taking account of stock the farmer said that he had heard the horn, but thought that it was a locomotive on the nearby railroad.



Steam Tractor of the Twentieth Century Hauling Ore Over Same Trail

HEAT VALUES OF ORDINARY AUTOMOBILE FUELS*

By DR. FRITZ HUTH, BERLIN, GERMANY

CONSTANTLY increasing expense for fuel has brought the automobile industry to the necessity of providing a cheaper combustible for this purpose, unless the economy of the commercial motor wagon, which has given such promise for the future of the industry, should be given a setback by being placed in question solely on account of the high price of benzine (gasoline). This has led at an earlier date to the undertaking of an investigation by the industrial protective bureau into the merits of home products, such as alcohol, without, however, having reached a successful conclusion as yet.

Now that so many new fuels have been placed on the market about the same time, the field is much wider than previously. Therefore, it is necessary that the driver who is in doubt as to how far the recommendation concerning a new fuel may be accepted, or whether it is adapted for use in the carbureter of his motor, or whether its use will be detrimental to the motor itself, should know how many heat units per kilo the new combustible contains. All these various questions cannot be referred to the single test mentioned of the fuels concerned for an answer. Not alone what may be the heat value of a certain fuel, but also what is the maximum allowable price to be paid for it, are questions of considerable interest. Consequently, with one of its most important characteristics definitely determined, a relative value may be assigned to it. Likewise, its standard of specific gravity will also be known, this being ascertained with the aid of a hydrometer.

For determining the heat value of the fuel, a Junker calorimeter is employed, and as this is an instrument not generally known, except to the technical fraternity, a short description of its construction and method of working will be of interest. It consists of the peculiarly shaped oven or combustion chamber I, surrounded by a water jacket, and the lamp II, suspended from the beam of the scale III. The lamp, which is of the ordinary type used for soldering, consists of the reservoir *a*, through the opening of which, *b*, some 200 cubic centimeters of the fuel to be tested should be poured. The burner *n* consists of a spray nozzle through which the combustible must be forced before arriving at *o*. *D* is a valve, and *m* is the cap belonging thereto, while *h* is a screw on the pressure gauge by means of which the operator may regulate the amount of air pressure on the fuel in the reservoir of the lamp. The apparatus is made ready for operation by burning a little alcohol in the cup of the burner *l*, in order to heat the latter, or it may be warmed with the aid of a Bunsen burner. A small hand air pump is then connected up with the valve *d*, in order to place the fuel to be tested under pressure.

Operation of the Apparatus—The liquid combustible then rises to the height of the burner, is sprayed out of the nozzle, and burns with a lightless flame. When the opening of the spray nozzle is properly regulated, gas pressure is created, which is held in equilibrium by the pressure on the interior of the vessel *a*. The lamp, which will now continue to burn without further attendance, is so placed on the end of the arm of the scale in order that it may project into the combustion chamber as far as possible. The hot gases rise in the direction indicated by the arrows, then being deflected downward again through copper tubes and finally escaping into the open air through *S*. The butterfly valve *k* serves as a means of regulating the draught through this opening. The tubes are filled with water, which as it expands through heating overflows into *c*. In a by-pass formed by the filling tube of this water jacket, consisting of the tubing mentioned, is placed a thermometer calibrated in tenths of degrees, T_1 , while at the top of jacket just before the overflow is reached there is a second thermometer of the same type, T_2 . Thus the temperature of the water upon entering

and leaving the apparatus may be taken. The water escapes at *p*, and at this point as well as at *e*, the inlet, an overflow is provided in order to equalize the pressure of the water throughout the apparatus. The outlet *p* is provided with a rubber sleeve by means of which an extension tube is attached to it in order to conduct the overflowing heated water to the measuring vessel *e*. The hot gases give up their heat to the cold water so completely that it flows out at an almost constant temperature. The small outlet *q* permits of the escape of any water of condensation, an accurate measurement of the quantity of which is necessary to the determination of heat values.

A small weight is placed in the scale pan seen depending from the reservoir of the lamp *a*, and the investigation proceeds automatically as already described until sufficient of the combustible under test has been consumed to permit the pointer of the scale to return to the zero mark. The moment this occurs, the tube

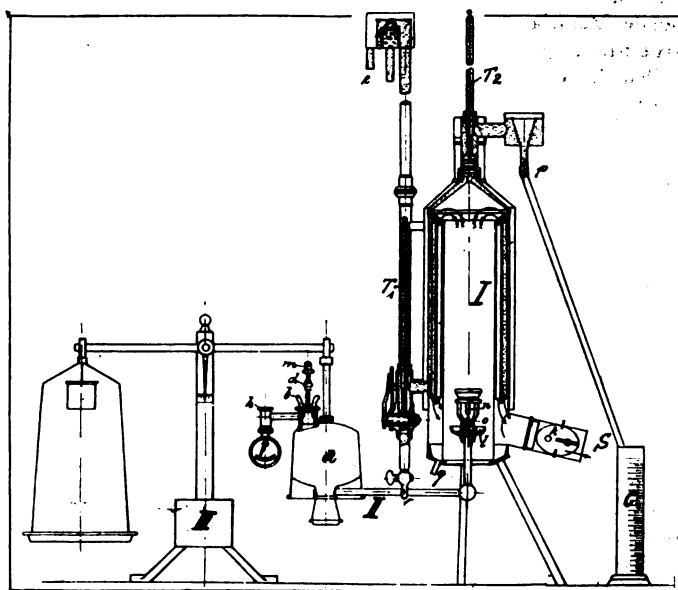

Calorimeter Arrangement Used in Determining Heat Values

extending from *p* is dropped into the graduate *c*, and another weight, say 10 gr., is placed in the scale pan. As soon as the amount of combustible represented by this weight is consumed the pointer of the scale again touches the balance point, and the tube from *p* is immediately withdrawn from the graduate and the amount of water which has overflowed into the latter is determined. In the meantime both the thermometers, T_1 and T_2 , have been read several times. The amount of water escaping at the outlet *q* has also been collected in another graduate.

Method of Figuring the Results—Results are arrived at by taking the number of liters of water *W*, overflowing from the apparatus, with relation to T_1 , the temperature difference as recorded by the thermometers, T_1 and T_2 ; *G*, the weight of the combustible consumed during the course of the experiment, and calculating the number of heat units evolved by the formula:

$$H = \frac{W.T}{G}$$

This represents the higher heat. The lower heat is found by taking the number of cubic centimeters of water of condensation for each 10 grammes of the fuel burnt and multiplying by 60, the resulting quantity then being subtracted from the result given by the calorimeter for the higher heat value of each kilogramme of liquid.

With each variety of combustible at least three or four experiments should be carried out, 10 grammes of the fluid being

*Translation from "Der Motorwagen" (German).

burnt and the temperatures read from minute to minute. The values given in the following table are the mean averages of these experiments. The figures given are the results of 50 tests. Even the heat value of lubricating oil has been ascertained, because in calculating the efficiency of a certain fuel for motor operation the high heat values of the lubricant that is burned should not be neglected.

As mentioned at the outset, the heat value alone cannot be taken as affording a certain and final indication or measure of the worth or economic value of a fuel. In order to arrive at this many other factors must be taken into consideration, such as its entire performance under varying conditions and speeds,

as well as with various types of carbureters, and this will be the object of an investigation to be given later.

HEAT VALUES AS EXPERIMENTALLY DETERMINED

Fuel.	Spec. Grav.	Higher heat Values.	Lower heat Values.	Price per 100 kg. in marks.
Naptha708	11,200	10,350	19.50
Benzine785	10,000	9,400	23.50
Benzine720	10,500	9,850	28.00
Benzine688	11,300	10,500	27.50
Benzol877	10,500	9,350	22.00
Dapollin695	11,300	10,450	24.50
Ergin908	9,900	9,400	21.00
Petroleum784	10,950	10,300	23.75
Lubricating890	10,000	9,350
Alcohol822	6,250	5,300	30.40

THE AUTOMOBILE AS A FEEDER OF CIVILIZATION

By HERMANN F. CUNTZ, A. L. A. M.

IN 1898 there were not more than 200 automobiles made and put into use in the United States. In 1909 the total number of automobiles made and sold in the United States will approximate 82,000, the members of the Association of Licensed Automobile Manufacturers, as in the last six years, playing a very large part in producing the machines.

That the automobile is a marvelous piece of mechanism is seen when it is considered that less than thirty years ago prime movers weighed as much as 800 or 1,000 pounds per horsepower developed, and that the modern automobile engine has been reduced in weight to well under ten pounds per horsepower developed, and has shown its great reliability by running for days without stopping. This perfection of engine construction has been paralleled by perfection of the other elements of the motor vehicle—all accomplished in the commercialization of the last eight years by progress in design, material and workmanship.

The advantages accruing from the use of the automobile to the human race and the industrial world are so great as to, in any fair consideration of the subject, more than counteract the occasional narrow-minded view fostered by thoughtless elaboration of unfortunate details necessarily incident to the process of the introduction of motor traffic.

In 1907 there were accidents on railroads in the United States to 110,000 people, and over 10 per cent of these accidents resulted fatally. Still, of course, the railroad is always considered an essential thing in any country.

The horsepower of which the average automobile produced

this year is capable is about twenty, the 82,000 machines making an aggregate of 1,640,000 horsepower. At the beginning of this year there were in use in the United States over 184,000 automobiles, capable of close to 4,000,000 horsepower. The harnessing of water power at Niagara Falls to the extent of a few hundred thousand horsepower was hailed as a stupendous accomplishment.

Considering the passengers carried per mile by railroads in the United States in 1908, as compared with the number of people carried per mile by automobiles, we find that in the same time and territory automobiles furnished seven-tenths of 1 per cent of the number of passenger-miles the railroads furnished. What will the relative percentage be in 1915? Taking the rate at which railroad construction and traffic and the use of the automobile are increasing, at a conservative estimate, the automobile will provide 7 per cent as much passenger traffic as the railroad.

In small freight transportation the motor will gradually supplant the horse, on account of less cost and greater convenience.

Before ten years shall have passed 10 to 15 per cent of the American farmers will own automobiles.

The railroads of this country have spent, as charged to cost of construction and equipment, over thirteen billion dollars; practically within the last forty years. It is futile to gainsay the fact that an expenditure on the common highways of this country in the next forty years of a sum equal to the private outlay on railroads in the last forty years would be anything more than warranted, reasonable and wise.

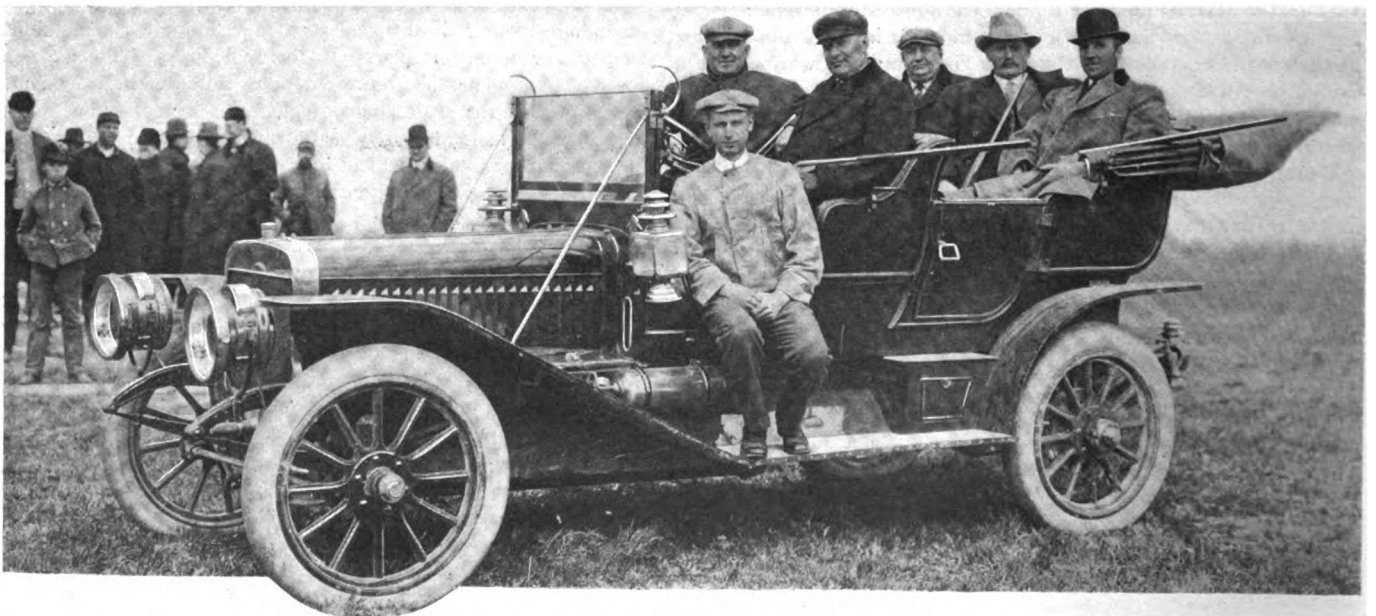

Six Best Shots in the World, in a Winton Six, at Hill Top Gun Club, Paris, Kentucky

From left to right noted "shootists" are William Crosby, O'Fallon, Ill.; Fred Gilbert, Spirit Lake, Ia.; T. A. Marshall, Keithsburg, Ill.; R. O. Hicks, Dayton, O.; William Herr, Concordia, Kan. On the running-board, C. A. Young, Enon, O.



Walter Christie's Front-Drive Autocab

SEEKING the unusual, one can find much of interest in the just-completed Christie front-drive cab, which the manufacturer and inventor, Walter Christie, of Eleventh avenue and Twenty-third street, New York City, says is the only proper solution not alone of the complicated cab situation, but of the question of ultimate drive for all automobiles.

Mr. Christie is a versatile inventor, having to his credit the revolving turret for warships, a very efficient form of packing for steam pistons of large diameter, and other innovations. But his pet is the combination front drive and front steer, to which ignorant and unthinking ones have applied the title of "freak." This really is a misnomer, for it presents nothing of the odd or whimsical, as freak is defined, but, rather, contributes ideas worthy of much thought.

Not only is the new car, which is of small power, comparatively light weight and suitable primarily for taxicab use, equipped with a front drive, but the block motor shows a number of carefully worked out details, while the transmission is a masterpiece of rugged yet small and compact work. The wheels, too, designed by Christie especially for cab work, are based upon an idea which may be generally adopted before long.

All engineers are aware that in cam and roller actions sudden movements demand that the cam surface traveled over by the cam-roller should always turn in a direction away from the point of roller-lever hanging, and that cam actions so sudden in angular variations that they will not run at all when the cam runs towards the axis, run smoothly and at high speed when the cam is turned the other way. The road surface and the vehicle wheel form an exact mechanical parallel to the cam and cam-roller, and every motor car rider is well aware that in all cases of hard work with rear wheel driven cars, the rear wheels try to go ahead of the front wheels, and often succeed in doing this, much to the agitation of the passengers.

Mechanically the Situation Is Grotesque—When it comes to driving with the rear wheels and steering with the front wheels the situation becomes mechanically grotesque, the suitability of steering with the driving instead of with the driven wheels being so wholly obvious. With rear wheel driving and front wheel steering, the front wheels can be given only a small angle, as they are pushed sidewise by the drivers, and cannot be given nearly so short a radius angle as is desirable. Where the front wheels are both drivers and steerers, the front axle can be turned square around at 90 deg. to the pulled, trailing rear axle, same as a truck driver heads his horses crosswise of the road when he wants a short turn, and the car will start with ease.

All of this has long been known, yet automobile builders put the cart before the horse, and assert their own wisdom in so doing, although in point of fact only one single valid argument

can be brought forward in favor of rear wheel driving. But this one is potent; rear wheel driving is the accustomed thing, and therefore the easy thing to sell, although it has a full list of faults and not one virtue as compared with front wheel driving.

More than one auto builder has tried front wheel driving and steering, notably in the German "fore-carriage," pushed to failure some years since, some experts claim, simply because it was not suitably designed and constructed.

The greatest advantage of front wheel driving and steering is the pull instead of the push, and the possibility of turning in a circle having a diameter equal to the wheelbase plus one-half the gauge. There is, however, a secondary advantage, which is alone and of itself amply sufficient to call for serious consideration of motor-cab front driving and steering. This is the possibility of a front motive and steering assembly of small dimensions, entirely self-contained and very readily detachable from the remainder of the chassis and car-body assembly.

This means that with one extra fore-carriage for, say, every ten cabs, the whole ten can be always kept in working condition with only the one small fore-carriage assembly in the repair shop, and all ten of the bodies and rear wheels assemblies out on the street earning money. With the rear wheel drive any failure back of the motor puts the whole car on the sick list, if, indeed, the motor is so constructed as to be readily removed from the car, which is very seldom the case.

Summation of Front Drive Advantages—Summed up, the front drive arrangement conduces toward the elimination of skidding, because it has been found by experiment that the free rotation of the rear wheels, which, by the way, is only found in the front drive, practically reduces the question of side-slip to a negligible quantity. Various attempts have been made to solve this problem by the use of front instead of rear brakes. This is on the order of a half-measure, and as such is a waste of time.

While the inventor has yet to build more than the one cab, the details of this as embodying a principle that is fundamentally correct are worthy of mention.

Engine Set Across the Car—The first radical point of difference is noticed in the position of the engine, which is set across the frame, at right angles to the ordinary practice. Moreover, it is combined with the front axle in a detachable way, a two-speed and reverse transmission being interposed and an expanding band clutch is utilized.

The four cylinders of the engine are cast in a unit with the upper half of the crankcase. The bore is $3\frac{1}{4}$ inch and the stroke 5 inch. The engine is slated to deliver at least 18 horsepower, which it does easily at 1,500 r.p.m. The top of the cylinder block, comprising an opening for the core print of perhaps 5 inches wide and 14 inches long, is normally covered by a plate,

from which the water outlet arises. The lower half of the crankcase, with the supporting feet which tie it to the front axle casing, is one of the other parts, while the cover for the gears at the front of the engine completes them. The drawing showing the construction displays the careful designing incidental to the building of the car in a number of ways. The metal between the cylinders is 1-4 inch, but at the ends, where there is less necessity for this amount of metal, it is reduced to 7-32. The water jacket thickness is right down to the limit of good foundry work, 1-8 inch.

The pistons have the pin fast in the rod, this being of 3-4 outside and 7-16 inside diameter. To care for the wear of the pin rotation, the piston bosses are bushed with phosphor bronze. The piston is of good length, 3-4 inches, and fitted with three 3-16 rings, all above the pin. These are cut diagonally. The connecting rods are of the usual I-section, the ends being 1-2 inch wide. Two bolts are used to hold the big end bearing, and these are of 3-8 diameter and special steel. The offset of the rods necessary to allow the central bearing being used is 1-2 inch.

Crankshaft Shows Excellent Design—In the mainshaft, the heart of the engine, is shown the ability of the designer. This is of as large diameter as is consistent with the power, the crankpins being 1 1-2 by 1 7-8 long. The bearings, on the other hand, are even larger than this, being 2 1-2 inches in diameter, with the end ones 2 1-8 long and the center 1 1-2 long. The bearings are plain, following usual practice. The shaft is very short, less than 18 inches over all, which short length, coupled with the three bearings, should make for great rigidity.

The engine is water cooled, the water circulation being very short. From the top cover plate there is a short pipe leading to the center of the tank forming the top of the radiator. The rest of the cooler consists of two banks of vertical copper tubes, about 280 in each, arranged at the outside of the car. The base

of the radiator is another tank, into which the copper tubes are brazed, and into which the water flows in two streams from the two sides of the cooling surface. From this lower tank another short pipe leads to the pump, of bronze and medium diameter, which pumps it into the cylinder block at the base of the water jacket between the two central cylinders.

The pump is of bronze, with stuffing boxes on each side, and is driven by a special auxiliary shaft, which also drives the magneto, placed on the same side of the engine, the inside towards the radiator. The pump is driven through a pair of couplings one on each side, which allow of its ready removal.

The air to cool the water is drawn through the banks of tubes by a fan belt driven from the flywheel, and hung on a bracket which is movable, the movement being such as to alter the tension of the belt. The usual position of the engine makes that of the fan axis, which is parallel to it, equally unusual, namely, across instead of parallel to the car.

At the right-hand end of the engine shaft is attached the flywheel, which, of 14 inches diameter, with a rim 2 3-4 wide by 1 1-4 thick, aside from balancing the engine so as to produce even and regular rotation, also carries the clutch within it and safely covered from the dirt and dust. This clutch is of the internal band type, expanded into place by the action of a toggle, which is in turn actuated by the sliding forward or back of a conical-shaped piece upon the surface of which the rollers of the clutch rest. The clutch is of 1 3-4 face and 1 1-2 inches diameter.

The disposition of the clutch shaft, which is at the same time the main or upper shaft of the transmission, is peculiar. The large diameter end of the crankshaft is turned out to receive a bushing at that end, within which bushing the forward end of the transmission shaft turns. This bushing is plain, but the one at the other end is of the radial ball type, also arranged to take thrust. Like the crankshaft, the mainshaft is very stubby, being but 13 3-4 inches long, including the starting end, by 1 5-8 average diameter. To reduce the weight to a minimum, all shafts of large diameter have been bored out internally, and this one is no exception to the rule.

Transmission Details Show More Novelty—Upon this upper shaft slides the gear which changes the speed, but two changes being fitted besides the reverse. The gears which effect these slide upon four keys, set into the shaft, and are operated in the usual way. The gears are all of 6 pitch, carefully hardened and made from a high grade of steel, but the various faces are adjusted to the work to be done. The gear reduction from the

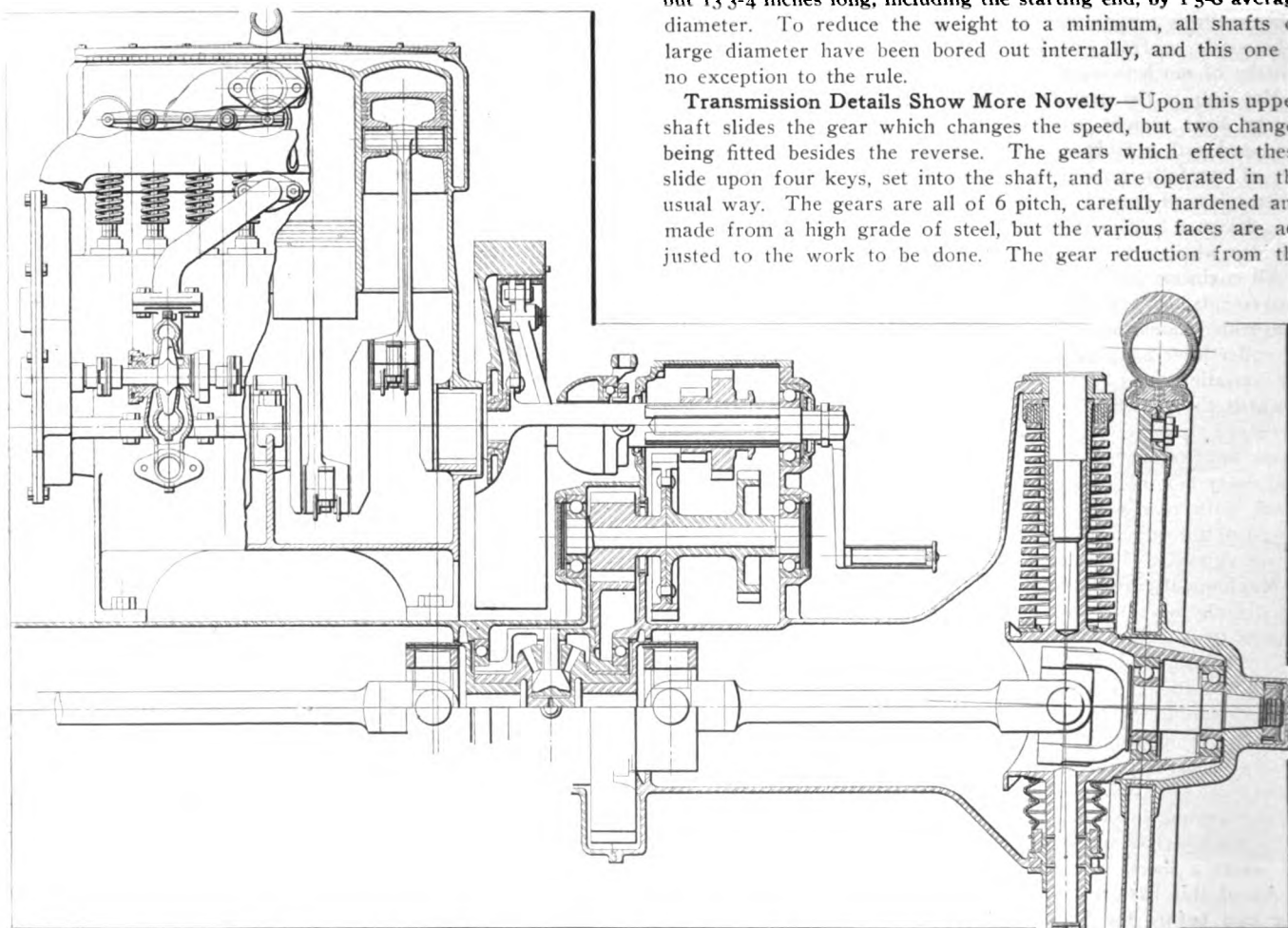

Christie Front Axle, Motor, and Transmission Assembly Looking Forward from the Driver's Seat, Partially in Section

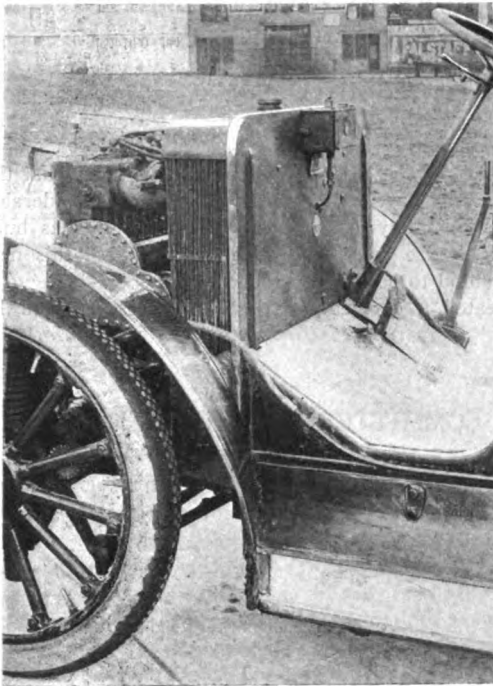

The Control Is Standard

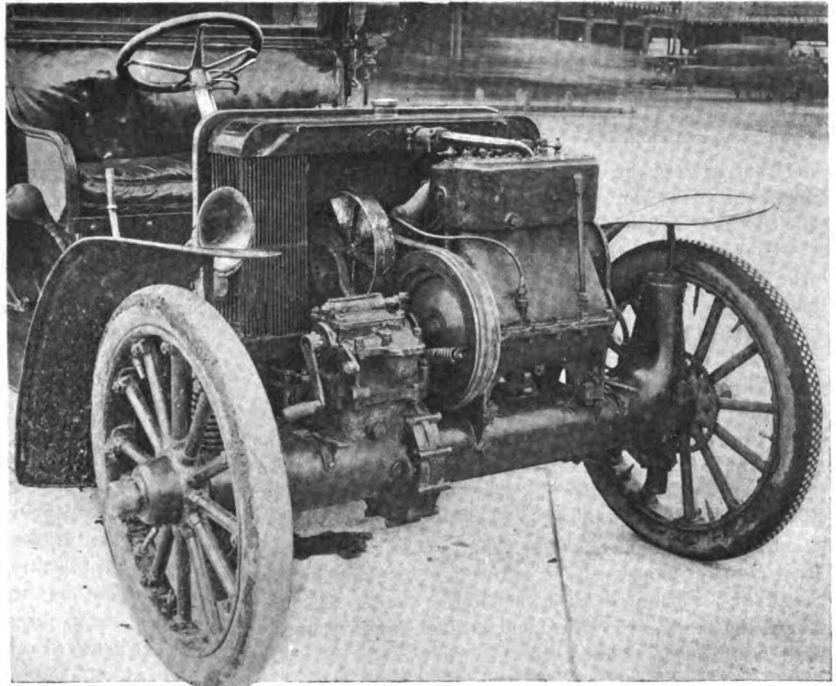

Full View of Front Axle Construction Shows Starting Handle at Left

engine to the road wheels is 4 to 1, and on the low speed just half of that, or 8 to 1. Thus, the gears for the high speed are but 7-8 face, which is increased to 1 inch on the low. This, in turn, is increased to 1 3-4 inches in the gear which carries the final drive to the axles.

This is right below the transmission, and the drive from the latter is by spur gears. The final gear, upon the axle, is attached to the housing of the differential, which is of bronze. The differential, of the bevel type, is located near the center of the axle, the casing of which is split at that point to permit the ready removal of the parts. On each side of this case are large diameter ball bearings, beyond which are the first pair of universal joints, one on each side. From this point to the ends a pair of 1 1-2 shafts transmit the power to the wheels through the medium of another pair of joints, the latter being located in the exact center of the wheels. This location makes the function of steering easy, for the wheels rotate around the same center about which they move to effect the steering. The axle is housed within a cast bronze tube of 6 3-4 inches outside diameter with 3-16 walls, which is what gives the front view of the car its bulky appearance.

This Form of Drive Calls for Different Springs—Upon the ends of the axle housing are placed the springs, which, from the very nature of the construction, are radically different. They are of the coil variety, the outer diameter of the coil varying from 3 1-8 at the top to 3 3-4 at the bottom. The steel comprising the coils is rectangular in section with the longest side in a horizontal plane. The section is 5-8 by 1-4, and each one has 18 full coils. Above the top end and under the lower extremity are placed bronze thrust washers.

What corresponds to the knuckle pin is of very large size, 1 1-2 diameter, bored out inside to 7-8 inch, and projects above the universal joint casing 6 1-2 inches, of which 3 inches has a bearing when the car is not loaded, but with heavy additions to the load this may increase up to 6 inches.

Upon the stub axle end the wheels run on a pair of ball bearings of large size. These are located very close to the line through the wheel center, the inner one being but 1-8 inside of the center of the tire and but 1-16 outside of the center line through the spokes. The axle stub at the inner bearing has the unusual dimension, for this weight of car, of 1 3-4 inches, which decreases to 1 9-16 at the outer one, but 2 5-8 farther away.

Beyond this the end tapers, and upon this taper is mounted

the heavy hub, which is held in place on the taper by a nut, cottered in position, and further retained in place by the hub cap, which would effectually prevent it from backing off, even if the cotter pin were forgotten.

The rear axle is of very simple construction, and is as plain as is consistent with the fact that it carries nothing but the springs and the large-sized brake drums. These brakes are internal expanding, and are operated by means of a cam.

The front wheels incline outward so that the tire centers are one inch farther apart on top than at the bottom, while the gauge is 52 1-2 on the road. With this small tread, a wheel-base of 100 inches, and the large angle of steering possible, the whole vehicle may be turned in a radius of 12 1-2 feet, or in a 25-foot circle. Steering is effected by the medium of a worm and sector, with a diagonal connecting rod to the left knuckle and a straight rod joining the two wheels, the latter being placed in the rear of the axle, where it is protected.

Even the Wheels Show Marked Ingenuity—The construction of the wheels is a far cry from what one would expect, for, beginning with the hubs just spoken of, the whole wheel is radically different, these having been designed especially for the cab service. The requirements may be summed up as: exceptional strength, particularly for side strains; lightness, and of a shape or form which lends itself to quick replacement. It is well known that the steel tube is, weight for weight, one of the strongest shapes made, and it is of this shape that Christie has constructed his spokes, thus obtaining at a bound both strength and light weight. These steel tubes are forced into seats machined in the hubs and then clamped to the felloes with retaining bolts, which hold on the loose flange of the rim as well. In this manner a new felloe and inflated tire may be substituted for a deflated or punctured tire in the time it takes to tell it. By using bolts, brazing is dispensed with and the quick tire change made possible. Both front and rear wheels are the same size, 32 by 3 1-2. This seems like a small size, but in view of the light weight, 2,100 pounds, is ample.

The body is the regular cab equipment of landaulette body, but the bonnet varies, being more like the style affected for so many years by Panhard. It pulls forward for removal, but for cases of ordinary trouble the top portion may be raised. The starting crank may be seen at the left side of this bonnet.

The price of the cab, complete, ready for the road, with lamps, horn, tools and spare parts, is \$2,600.

CONNECTICUT LAW NOW UP TO HOUSE

HARTFORD, CONN., June 7—Now before the House of the State Legislature is a bill, already passed by the Senate, which has been introduced as a compromise for the law proposed early in the session, and the new one bids fair to pass. One of the features, which caused so much discussion in the previous bill, was that giving the control of automobiles and the like to a supervisor of motor vehicles, but in the present form the secretary of State will have charge as heretofore. The substitute bill also makes the speed limit 25 miles an hour, provides a rather large license fee for cars of 40 horsepower and over, and states that all cars must be muffled between 9 P. M. and 6 A. M. Siren and exhaust horns are also prohibited.

The fee for motorcycles is set at \$1; for commercial vehicles regardless of power, \$5; for automobiles controlled by liverymen, \$10; for cars of manufacturers, \$100, and for those owned by or under the control of a dealer, \$20. Private owners will be subject to the following charges: For cars of less than 20 horsepower, \$6; cars above 20, but less than 30 horsepower, \$10; cars above 30, but less than 35 horsepower, \$15; cars above 35, but less than 40 horsepower, \$20; cars of 40 horsepower or above, \$40. Non-residents will be allowed to use the highways of the State for a period of 10 days without taking out a license, providing that they carry the tags of their home States.

As is the case in most of the laws which have arisen in the various commonwealths this year, the speed proposition provides that autoists shall operate their cars at a speed no greater than is reasonable, and then stipulates that anyone traveling at a rate of more than 25 miles per hour, for a distance of an eighth of a mile, may be considered as being driven recklessly. Of course, there are the familiar provisions as to passing fractious animals, and if the car is in a crowded section of a town the limit of sane driving is 10 miles per hour. Three miles per hour is allowed an automobile when it is about to pass a trolley car which has stopped to discharge or receive passengers. All money received by the Secretary of State must be turned over for highway improvement at the instance of the commissioner.

SENATORS FAVOR AMERICAN AUTOMOBILES

The recent tariff discussions have brought out some very interesting side lights. Take, for instance, the following conversation which occurred during the discussion of the tariff bill before the Senate, the subject being the status of imported automobiles, and the sentiment expressed being a boost for high-class American cars, with the Packard used as an example. The excerpt below is from the *Congressional Record* of May 21:

Mr. Aldrich—It is not correct. There are at least half a dozen leading makes of automobiles that are imported largely.

Mr. Bacon—I have no information on the subject myself.

Mr. Aldrich—Eight or ten makes would include certainly most of the importations.

Mr. Bailey—If we could have the name of the maker and the country from which they come engraved on them, we would tell which Senators are riding in imported automobiles.

Mr. Aldrich—The foreign makers look out for that.

Mr. Hale—The Senator need not be alarmed about that. The marks will be on the machine.

Mr. Bailey—According to my belief, the marks of the people ought to be on some of the Senators who ride in imported automobiles.

Mr. Aldrich—I hope no Senator would ride in an imported automobile.

Mr. Bailey—I saw the Senator from Rhode Island riding in a very costly finished one and I wondered if it was made in this country.

Mr. Aldrich—It was made in this country. It was made in Detroit, Michigan.

Mr. Smith, of Michigan—We are very proud of it.

REEVES TAKES A WESTERN TRIP

Alfred Reeves, general manager of the American Motor Car Manufacturers' Association, left New York City Wednesday night for a tour of the Western factories. Incidentally, he may have a look at the Crown Point road races of next week.

EDGE HURRIES BACK TO ENGLAND

S. F. Edge, the well-known British autoist, and one of the big factors of Napier interests, sailed for home yesterday on the *Lusitania*, apparently quite well satisfied with his short American visit. In fact, he contented himself with the statement that he may return very shortly.

This means that there is undoubted truth in the story that the Napier Company may have an American factory of considerable magnitude. For several years an American company has built Napiers under a license from the parent concern, but this new project is understood to be entirely separate.

Mr. Edge created a decidedly favorable impression, and he frankly admitted being impressed with many things which he noted.

N. A. A. M. COMMITTEEMEN MEET AND TALK

NEW YORK, June 7—At the regular monthly meeting of the executive committee of the National Association of Automobile Manufacturers, held in the association rooms June 2, John N. Willys was elected to the board to succeed Col. George Pope, representing the Toledo Motor Car Company. Routine business matters were considered. William E. Metzger presided, and others present were: Thomas Henderson, Winton; L. H. Kittredge, Peerless; C. C. Hildebrand, Stevens-Duryea; Charles Clifton, Pierce; S. T. Davis, Jr., Locomobile; Windsor T. White, White; H. O. Smith, Premier; A. L. Pope, Pope-Hartford; C. G. Stoddard, Stoddard-Dayton; J. W. Gilson, Mitchell; S. A. Miles, general manager.

A. M. C. M. A. CONSIDERS SHOW PLANS

NEW YORK, June 7—New schemes of decoration and a new arrangement to secure additional space in the tenth international automobile show, which opens in the Grand Central Palace on next New Year's Eve, were important subjects considered by the show committee of the American Motor Car Manufacturers' Association in its meeting June 3. The Importers' Automobile Salon will, as usual, occupy a portion of the main floor, and the Motor and Accessory Manufacturers will again have the 16,000 square feet of space in the first balcony. At the meeting of this committee were: R. E. Olds, Reo; H. O. Smith, Premier; Alfred Reeves, general manager.

Routine affairs were discussed at the regular monthly meeting of the committee of management, held on the same day. Those present were: H. O. Smith, chairman, Premier; C. G. Stoddard, Stoddard-Dayton; R. E. Olds, Reo; S. H. Mora, Mora; W. H. Van Der Voort, Moline; Charles Lewis, Jackson; G. V. Rogers, Mitchell, secretary, and Alfred Reeves, general manager of the A. M. C. M. A.

ELECTRIC VEHICLE CO. REORGANIZATION

HARTFORD, CONN., June 7—All doubts as to the early reorganization of the Electric Vehicle Company of this city, the manufacturer of Columbia automobiles, has been swept aside by the order of Judge Cross directing parties in interest to show why a plan made by the reorganization committee should not be accepted. This committee presented the plans before the United States Circuit Court at Elizabeth, N. J., on Thursday, outlining an offer to take over the assets of the concern, barring the cash in the hands of the receivers. Since it became insolvent on December 10, 1907, the interests have been managed by Receivers Henry W. Nuckols, of this city, and H. M. Barret, of Elizabeth. The committee is composed of Herbert Lloyd and C. W. Woodward, of Philadelphia, and K. B. Schley, of New York, and by its plan the receivers would be able to declare a 20 per cent. dividend on the unsecured claim of \$800,000. The bondholders of the \$2,250,000, secured by general mortgage, would waive their security and accept the same dividend. The business would be taken over by a new corporation, under the laws of the State of Connecticut.

WHY MAKERS HAVE BEEN SLOW IN ENTERING

ACCORDING to Chairman F. B. Hower, of the A. A. A. Contest Board, the prosperous condition of the automobile industry is strikingly exemplified by the letters he receives regarding entries in the A. A. A. tour and contests for the Glidden, Hower and Detroit trophies. There is a sameness to many of them this year that he never has found before, he says. The manufacturers write that they want to be in the tour, and feel that they can illy afford to stay out, but that they have not entered before because they are so far behind in deliveries and so short of cars that they cannot see a month ahead.

"It is notable as showing the interest of the manufacturers that they are writing to me to explain why they have not sent in entries," says Chairman Hower. "In former years they have not taken this trouble to write, so it is plain that they appreciate more than ever the importance of participating in this one big touring contest. One and all, however, complain of being short of cars, and so busy at the factory as to be unable to spare any men. This is a splendid condition for the trade and I rejoice in it, but I hope the present prosperity does not lead to shortsightedness. It is very well to be oversold this year, but there are other years to come. There may be a glut of cars next year and there will be need of something to help sales along. The Glidden tour always counts for the year to come, not for the current year. It is the testimony of every maker who ever has participated and made a good showing that the Glidden tour record is a wonderful help in selling cars the following year."

Molines to Be Known as "Dreadnaught Squadron"

"Dreadnaught Squadron" is the name given to the three Moline Glidden Tour entries which have been entered in the runabout class competing for the Hower trophy. W. H. VanDerVoort, president of the Moline Automobile Company, is paying unusual attention to the three Molines, which will carry the numbers 100, 101 and 102. The three cars will be painted London smoke color

and the crews will wear mohair uniforms of the same color.

It will be remembered that Mr. VanDerVoort entered three Molines at the close of last year's Glidden Tour after being fully convinced that the great American touring classic was by far the best automobile road event held in this country. The three Molines were entered several months before any other entries. All three cars will be the Model K, listed at \$2,500, 35-40 horsepower, equipped with Bosch magneto and having a wheelbase of 116 inches.

"It is my desire to see the largest Glidden tour this year that has ever been held," says Mr. VanDerVoort. "The entire West is very enthusiastic because it is to pass through that territory this year, and in my opinion it is this section of the country which should be developed. The Middle West is unusually prosperous this year, especially the farmers, and a very large proportion of the motor car output is being disposed of out there."

Names of Cars to Be Carried on Tour Signs

A ruling concerning the tour has just been announced which will be highly pleasing to the manufacturers who enter cars and to the people of the country traveled through. The decision has been made to have the names of the cars, as well as their numbers, on the signs they carry. Hitherto the signs on the cars had only the words "A. A. A. Tour" and the year and the entry number of the car. This has been aggravating to the spectators, as well as disappointing to the entrants. All along the route of the tour some of the residents were to be seen with clippings from newspapers that gave the numbers and names of the cars, but from those not thus provided there was a continuous cry of: "What car is that?" The fact that the make of car is the first point of interest has been deeply impressed by experience upon Chairman Hower, and therefore the signs this year will be twice as large as previously and the names of the cars will be conspicuous on them.

CALIFORNIA ENDURANCE HAS FIVE CLEAN SCORES

SAN FRANCISCO, June 7—Five of the sixteen cars which participated in the second annual endurance contest over the San Leandro course, survived the ordeal with unsmirched records. The quintette contained these cars: Velie, Autocar, Mitchell, Interstate and Acme. Another Mitchell, an E-M-F, and a Studebaker 30, were three other finishers suffering from meagre penalties.

In this contest, held under the direction of the Automobile Dealers' Association, the success of a year ago was duplicated. Of the 16 cars which started over the 54-mile circuit, with 12 laps to go in 24 hours, half were able to finish, and during the entire trip, up until the last round there were generally over a dozen competitors on the roads. Starting on Sunday afternoon, May 30, they were required to keep traveling at high speed until the same time of Monday, May 31, with but slight margins from overstepping the rigid requirements for a perfect score. The penalties of those which finished, but not with clean slates, were very low. The Mitchell had 22 points for changing a spark plug and locating a broken wire; the E-M-F 4 points for a carbureter adjustment, and the Studebaker three points for stalling the motor. The roads were such as to give the competing cars strenuous tests without breaking them to pieces, and at the conclusion of the run all competitors expressed satisfaction.

Those cars which started, with their drivers, were: Apperson, Max Rosenfeld, S. K. Crocker; Buick, C. S. Howard, W. Powers, L. Andrews; Mitchell "20," E. Martin, A. E. Hunter; E-M-F, A. Eickmeier, M. S. Harris; Winton, M. L. Owsney, G. Arbuckle; Velie, A. D. Whitehead, H. Whitehead; Studebaker "30,"

J. H. Eagal, R. Newcomb; Buick, F. Gross, F. Murray; Mitchell "40," J. Sexton, E. L. Peacock; Autocar "25," P. J. Brown, W. C. Morris; Auburn, F. Bryant; Durocar, J. B. Robinson, J. A. Houlihan; Speedwell, J. H. Gordan; Interstate, G. C. Murray; J. F. Burkhard; Acme, F. Free, W. H. Middleton; Studebaker "40," S. Marshall. All but one of the contestants made the first round in good time, the exception being the Durocar on which the oiler stopped working, but after being repaired the car continued and unofficially finished nine rounds. On the second lap two other machines retired: the Auburn breaking a fan, and the Studebaker "40" running dry so that penalties which accumulated made it hardly worth while to continue. The Speedwell stopped in the fourth circuit with carbureter trouble from dirty gasoline, and then for three rounds the cars all kept running well, 12 of them contestants, and during the same period the Durocar also took to the roads. In the eighth lap the Winton broke a spring but it was repaired and the machine continued until the repair also gave way in the twelfth, and forced a stop. For two more laps the class kept up the fast work and in the eleventh one Buick, which had been having trouble throughout the trip, retired. The final lap witnessed the withdrawal of two other cars, the Apperson, which had a broken gasoline feed pipe, and the Buick, which had a valve break and this tore a hole in a piston. The fastest lap was made in 1:25:34.

Those who handled the contest were: Starter, R. R. l'Hommedieu; chief scorer, G. E. Johnson; chief timer, C. Kirkpatrick; chief observer, S. D. Rogers; clerk of course, George Mountz; judges, H. M. Owens, G. T. Sterling, W. M. Klingler.

WORCESTER MAY FURNISH NATIONAL HILL

WORCESTER, MASS., June 7—Following the visit to this city of Lewis R. Speare, president of the American Automobile Association, it has developed that this city may be a scene of future national hill climbs, for a grade has been surveyed near here that surpasses anything in this part of the country. It is located on the west side of the city, and has been measured accurately, showing a straightaway length of over a mile, with a grade of 25 per cent. in some places, and a steep enough average. President Speare assured John P. Coghlin, president of the Worcester Automobile Club, that if a road is built on this hill, it will be selected as the location of the national contest.

This information has given added impetus to the enthusiasm for the hill climbing events which will be held on Saturday on the Dead Horse hill, and the entries are more numerous than was expected. The big Benz will be driven by David Bruce Brown, the Fiat by Ralph DePalma, the Knox Company has listed four entries, including its Vanderbilt cars; and Basle will handle the Renault.

The officials for the climb have been announced as follows: Referee, Lewis R. Speare, president, A. A. A.; starter, Fred. J. Wagner; clerk of course, Charles F. Webb; committee of arrangements, George D. Webb, Daniel F. Gay, Herbert P. Bagley, A. H. Inman; timers, A. H. Inman, F. L. Murdock, G. B. Cutting, J. Walter Flagg; judges, Frederick Tudor, president, and J. Fortescue, secretary, Bay State Automobile Association; A. E. Bliss, president Massachusetts State Automobile Association, Malden; John L. Heinze, president Lowell Automobile Club; A. E. Lerche, president, and Stanford L. Haynes, Springfield Automobile Club; E. P. Charlton, president Fall River Automobile Club; E. H. Walker, president Brockton Automobile Club; A. D. Converse, president Winchendon Automobile Club; Charles P. Smith, of Springfield, president, and W. H. Chase, of Fitchburg, Wachussetts Automobile Club.

CHALMERS-DETROIT PERFECT IN JERSEY RUN

In the endurance run of the New Jersey Automobile and Motor Club for amateur drivers, held May 27, W. L. Ferguson made a perfect score with his 30-horsepower Chalmers-Detroit touring car. In the report of this contest in *THE AUTOMOBILE* of June 3, Mr. Ferguson was erroneously stated to have withdrawn after completing one lap and to have had five punctures, when in reality he finished the first round on the dot of the minute and the second lap but five seconds ahead of time. He had no tire trouble from start to finish, and was awarded a perfect score cup by the club. Confusion of numbers resulted in crediting Mr. Ferguson's score to the Autocar, driven by M. A. Carpenter, which immediately followed the Chalmers-Detroit and which should not have been given a perfect score in the story of the event. Attention has been called to the mistake by George Paddock, president of the Paddock-Zusi Motor Car Company, the Newark agent for the Chalmers-Detroit.

CHADWICK CLIMBER WAS A STOCK CAR

Nowadays, when the public is learning to differentiate between the performances of specially constructed racing craft and the more valuable efforts of stock cars, no manufacturer can be blamed for insisting upon credit when credit is due.

This is illustrated by an objection filed by the Chadwick Engineering Works of Pottstown, Pa., which demurs against being classed at the Wilkes-Barre hill climb as having participated with other than a stock car. Its six-cylinder climber is designated positively as "stock," and considering that with only half the horsepower of the 120 Benz it required only 4.2-5 seconds more in which to make the ascent, the makers take considerable credit, especially when such a flyer as the Fiat *Cyclone* was numbered among the defeated.

In the invitation event, from which the racing Benz was barred, the Chadwick won and made the journey up Giant's Despair in one-fifth of a second better than its earlier performance.

KOKOMO CELEBRATES HAYNES ANNIVERSARY

KOKOMO, IND., June 7—In honor of the sixteenth anniversary of the completion of Elwood Haynes' first gasoline automobile, this city took a day off on Wednesday for a fitting celebration, giving the business section over to the automobilists. The streets were roped off for contests, and business men devoted their time to serving on reception and other committees, while both the Haynes and Apperson factories entered heartily into the spirit of the affair. There were visiting delegations from cities and towns within a radius of 75 miles, so that several thousand persons saw the various events, including a parade in which about 200 cars participated. A brass band on the courthouse square enlivened proceedings, and Herbert Lytle, Loring Wagoner, and other well-known drivers took part in the contests. The courthouse square was also the scene of the races and other sports, there being a slow race which was won by Murden in a Haynes in 2:55, a reverse race won by McLain in an Apperson in :40 3-4; egg race, balancing contest, potato race, and class races for autos divided by their rated horsepowers. Edgar Apperson won a race for test cars of that make, and Miss Katrina Fertig, of Indianapolis, took both contests for women, driving her Premier. Herbert Lytle in an Apperson Jack Rabbit in the speed tests made :40 1-4 seconds.

ROBERTSON, ROBERTS, HAUPT: HOUPPT TEAM

NEW YORK, June 7—Herreshoff and Houpt automobiles will be entered in many important races of the season, according to the plans made by Harry S. Houpt, and in preparation he has secured one of the strongest teams of racing drivers ever assembled in this country. George Robertson, the winner of the Vanderbilt and Fairmount Park races last fall, and of other contests, is at the head of the contest department. Montague Roberts, who has been at the wheel of Thomas cars in many big speed events, is a member of the team, but it is possible that his duties in the mechanical lines of the Houpt companies will prevent him from taking as active a part as his colleagues. Willie Haupt, who distinguished himself with Chadwick racers all last season by winning every important hill climb in the East and Middle West, and by leading the Vanderbilt race last fall for four laps, has come over from Philadelphia and is becoming familiar with Herreshoff and Houpt construction. The former cars are being produced in quantities and are now in a position to enter light car races and others in class, but the big Houpt machines will hardly be ready to make their contest debut until the Lowell carnival.

It is probable that still another well-known racer will be engaged to make up a quartette, but as yet negotiations with him have not been completed. Suffice it to say, that by many he is rated as one of the best racing drivers in America, and with the others equally as well considered the new team will be watched with great interest.



Willie Haupt, George Robertson, Montague Roberts

DAYTONA TO GRAND RAPIDS IN A REO

NEW YORK, June 7—There arrived in this city last evening a two-cylinder Reo roadster which has already covered 1,500 miles and has about 900 more to go in a trip from the auto-famous beach at Daytona, Fla., to the Furniture City—Grand Rapids, Mich. Owned and driven by Charles A. Luce, of the latter place, and accompanied only by Mrs. Luce, the little car has had a strenuous mud-plugging tour, especially after reaching the sand and clay of the lower Carolinas, and has been on the go for 22 days, not including 10 which were taken off for rest or because of the heavy rains of late. Mr. and Mrs. Luce left the Southern resort on May 4, and will leave to-morrow on their way to their home via Buffalo and Cleveland. In speaking of the trip to date, Mr. Luce said:

"We have had a hard tour on account of the weather and road conditions, and because it has been necessary often to make short runs because we had to calculate upon our night stops. Frequently if we pushed beyond one small town in the South we would not reach another for many miles. Our route has taken us through Jacksonville, Lake City, Jasper, Valdosta, Macon, Atlanta, Salisbury, Greenville, Winston-Salem, Danville, Chatham, Staunton, Hagerstown, York, and Philadelphia. We have found every imaginable kind of road, mostly bad, but they will be improved shortly, for the people of the South have been stirred up beyond the Northern comprehension by the present movement. We ran from Atlanta to Greenville with the White scout car sent out by the *Atlanta Journal*, and we met R. H. Johnston in the New York *Herald* White scout car at Roanoke. The roads of the Carolinas, and of Georgia also, are nearly bottomless in wet weather, and I have found a route between Danville, Va., and Roanoke, via Chatham, that is far superior to the usual course via Lynchburg. My car was the first automobile over it.

"From Salisbury to Philadelphia we had a continual mud-plug, with only three sunny days, and of all the roads the pikes around Staunton were the hardest to travel because of the broken stone set on edge. Our tires were nearly worn through by them. I cannot say too much of the Reo, for it has made the run in wonderful shape, especially upon the hills and on muddy roads. From Salisbury to Roanoke we had to use low gear most of the time, but that had no effect upon the working of the car. Our route to Cleveland will be that generally taken by autos and we have not decided just when we will try to reach there, as we take the trip by easy stages, the best way for any persons on a long tour."

TRAVELS 134.3 MILES ON ONE CHARGE

PHILADELPHIA, June 7—The Woods electric victoria which made such a creditable record in the recent roadability run of the Quaker City Motor Club to Atlantic City, covering the 67-mile route in 4:35:40 on one charge, eclipsed that performance last Tuesday, when it negotiated the round trip of 134.3 miles on one charge of "juice." Driver George W. Daley, who swears to the correctness of the statement, makes further affidavit to the effect that after completing the homeward journey, the car was run until the odometer showed 152 miles, before the batteries were exhausted.

The actual running time to Atlantic City was 3 hours and 45 minutes, or 16.2 miles an hour. The return trip began at 4:18 P. M. and the electric drew up at the starting point, in front of the *Record* office, at 9 o'clock exactly.

On Thursday Mr. Daley gave the electric another try-out, this time for speed. A roundabout route of 89.2 miles was selected, and the car reached Atlantic City in a trifle over five hours, the average figuring out at 17.6 miles an hour. The odometer showed 104.2 miles before recharging was begun.

Marshalltown, Iowa—The Johnston Automobile Company has let the contract for the erection of a new garage, to be built of brick and cement, on East Lincoln street.

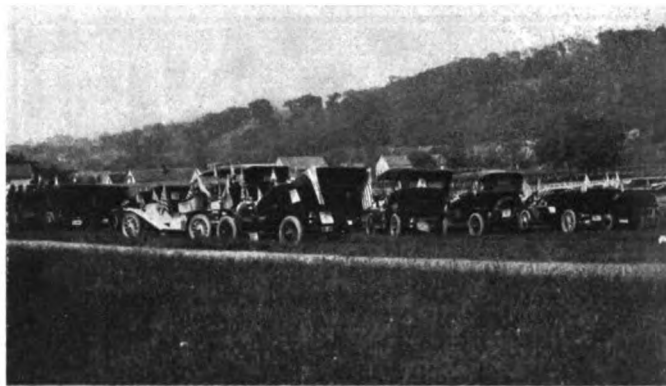

Cars That Carried Troy's Orphans at Van Rensselaer Park

TROY CLUB FETES THOUSAND CHILDREN

TROY, N. Y., June 7—Fully 1,000 orphans from the various institutions of this city were given an outing by the Troy Automobile Club on Wednesday. The members of the club contributed 130 touring cars for the purpose, and the little folk were taken to the local "Coney Island," after a ride of about 12 miles, where they were the guests of the club and management. Two hours were allowed for sight seeing and the enjoyment of the games, and then they were returned to the different homes in the autos, tired and happy. During the outward-bound parade every church bell in the city was rung and large crowds greeted the procession along the line of march.

DETROIT GAVE ORPHANS A GRAND TIME

DETROIT, June 7—Six hundred Detroit orphans were given the time of their lives last Friday as guests of the Detroit Automobile Dealers' Association and the Detroit Automobile Club. One hundred machines were furnished for the occasion. Frank Weldon, who officiated as master of ceremonies, provided each youngster with a small American flag, and as the procession sped along it resembled one grand stream of Stars and Stripes. No charitable institution in the city was overlooked. The only feature marring the festivities was the fact that one hundred children at the Home for the Friendless were unable to participate in the outing, the institution being quarantined because of diphtheria.

The orphans were given a ride about the city, over Belle Isle, with a visit to the "zoo"; out to Grosse Pointe and back—in all, about forty miles were covered.

At the conclusion of the run the older children were taken to the Pontchartrain and treated to light refreshments, bringing to a close the most successful event of its kind ever undertaken and giving to 600 orphans a day's pleasure they will long remember.

LONG AUTO RIDES FOR PITTSBURGH ORPHANS

PITTSBURGH, PA., June 7—An extended automobile ride was the important feature of the celebration of orphans' day in this city, in addition to the visit to the "Zoo" and a luncheon, under the direction of the Automobile Club of Pittsburgh. Friday was selected for the day, and almost 700 children were given a treat, beginning at 10:30 A.M., when the automobiles brought the little folk from the various institutions to Craig street, just off the Grant boulevard. A parade was formed and the cars run to Highland Park, where are located the wonders of the big zoological gardens. The cars then went over every bit of boulevard in the East End and landed their loads in Schenley Park at about 1 o'clock for a fine luncheon, which was served just beyond the Panther Hollow bridge, one of the most beautiful spots around the Smoky City. The parade began again after lunch, covering many more miles of boulevards, breaking up and leaving the children at their homes about 4:30 P.M. The committee in charge consisted of: Paul C. Wolff, secretary of the club; A. E. Neman, J. N. Hawkins, E. J. Kent and Edward Kneeland.



Vol. XX. Thursday, June 10, 1909 No. 23

THE CLASS JOURNAL COMPANY

H. M. SWETLAND, President
A. B. SWETLAND, Business Manager
231-241 West 39th Street, New York City

EDITORIAL DEPARTMENT

A. G. BATCHELDER, Managing Editor
R. F. KELSEY, Associate Editor
THOS. J. FAY MORRIS A. HALL W. McK. WHITE D. R. HOBART
W. F. BRADLEY, Foreign Representative

ADVERTISING DEPARTMENT

M. C. ROBBINS, Manager LOUIS R. SMITH, New York
W. I. RALPH, 1035 Old South Bldg., Boston FRANK B. BARNETT, Cleveland
C. H. GURNETT, 1200 Michigan Ave., H. H. GILL, Detroit
F. W. VAN SICKLEN, Chicago T. B. VAN ALSTYNE, Philadelphia

Cable Address - Autoland, New York
Long Distance Telephone - 2046 Bryant, New York

SUBSCRIPTION RATES:

United States and Mexico - One Year, \$3.00
Other Countries in Postal Union, including Canada - One Year, 5.00
To Subscribers—Do not send money by ordinary mail. Remit by Draft,
Post-Office or Express Money Order, or Register your letter.

FOREIGN SUBSCRIPTION AGENTS:

ENGLAND:—W. H. Smith & Sons, Ltd., 186 Strand, London, W. C., and all book-
stalls and agencies in Great Britain; also in Paris at 245 Rue de Rivoli.
FRANCE:—L. Baudry de Saunier, offices of "Omnia," 20 Rue Duret, Avenue
de la Grande Arme'e, Paris.
GERMANY:—A. Seydel, Mohrenstrasse 9, Berlin.

Entered at New York, N. Y., as second-class matter.
The Automobile is a consolidation of The Automobile (monthly) and the Motor
Review (weekly), May, 1902, Dealer and Repairman (monthly), October, 1903,
and the Automobile Magazine (monthly), July, 1907.

WHAT WILL NEXT COME FORTH?

With the completion of arrangements for the sale of
the whole of the product of this season, a number of the
largest manufacturers are announcing the details of their
models for the season which will follow. Many others
who have not gone to this length have given out an idea
of the principal features of the cars to which they will
devote their energies, and of a third class, rumor only
has spoken as to the product.

Thus it is that plans are made public, and among
these plans are many which will interest the people; some
for the folks able to buy luxurious cars, on which the
improvements take the form of added luxuries, others
(and these will be most numerous) will appeal to the
great class of people who up to date have been nothing
but "wishers" because of the prevailing prices.

It is to the latter class, only able to pay a very small
price as prices go, but numerous in the extreme, that a
few manufacturers will cater for the first time. These
cars will be the very personification of simplicity, both
as to number of parts and their functions, resulting in a
simple and easily mastered control system. Many, if
rumor is trustworthy, will be equipped with two-cycle
engines, several of the differential piston type. But this
seems like a case of saving at the bung-hole to waste at
the spigot, for the fuel consumption of this type of
motive power is notoriously high. Of what avail is a

poor man's automobile at \$1,000, if the fuel and upkeep
cost is equal to that of a \$4,000 machine?

Actually the increased upkeep cost would be a greater
hardship than the greater initial expense, for the latter
comes but once, while the former partakes of the nature
of a continuous performance, which must go on as long
as the machine is employed, and is only terminated when
it is disposed of and the pleasure of use ceases.

One prominent development will be the absence of
freaks in the class known as "best sellers," most of which
will continue the present types without change. In this
category come the six-cylinder motors for high powers,
all of which will doubtless be continued as at present.

In the list of mechanical features worthy of mention,
it is noticeable that the fuel question is being given in-
creasing thought, and the 1910 cars will include many
which are fitted for the use of a fuel other than gasoline,
and still more arranged for fuel injection. An observed
trend is in the ignition, single ignition with a magneto
as a source of current being on the gain at the expense
of other forms. Many of the very low priced cars will
doubtless turn to the two-speed transmission, while there
will still be many who adhere to the planetary type, with
its inherently simple control.

Equally as conspicuous as the newer features or the
changes in the product of the high class producers will
be the new faces in the industry, these being recruited
chiefly from the implement, agricultural, and buggy
manufacturers of the Middle Western States.

All told, the season of 1910 will make many remark-
able changes in the industry as a whole, and much will
be added to automobile history.



IN THE TRAIL OF THE BIG TOUR

Possessing roads that were such in reality, the more
populous East naturally adopted the automobile with
greater alacrity than the more sparsely settled West
with its widely separated cities and lack of highways
worth mentioning. Hence the annual national endur-
ance tour generally had either its beginning or its finish,
or both, in the Atlantic and Middle States.

But this year there is a plunge to the Northwest, and
thence down into the Rocky Mountains country. The
route traversed is a comprehensive one for the middle
part of the country, and furthermore, direct attention
to the automobile will be carried to thousands of people
who are yet comparatively strangers to its pleasurable
and time-saving necessities.

It would appear that those manufacturers who par-
ticipate in this year's big tour are certain to realize sub-
stantially in one form or another, even though it is a
certainty that under the rules laid down there cannot be
any considerable number of tied trophy winners. The
rules-making committee has been conscientiously at
work for the past fortnight, and the results of its labor
should prove uniformly acceptable.

Of course, the roads to be encountered will comprise
good, indifferent, and bad, but not to such an extent
as is imagined by the self-satisfied Easterner who deludes
himself in the belief that nothing West of Buffalo, or
Chicago at the extreme limit, is worth while in this big
country. Many an automobile opinion will be revised
in the trail of the 1909 Glidden tour.

DECISION IN SELDEN SUIT EXPECTED IN FALL

JUDGE HOUGH of the United States Circuit Court, Southern District of New York, has been well supplied with reading matter for his Summer vacation. Some 10,000 printed pages of testimony, including briefs filed by both sides, of some 1,700 pages, are now in his possession as a result of the hearing which closed Friday, June 4, after having continued for six days.

In view of the grasp of the situation which Judge Hough demonstrated during the hearing held in the Post Office Building, New York City, it is generally expected that a decision may be announced in the Fall.

The hearing was on a consolidation of a number of suits, in all of which the complainants were the Electric Vehicle Company and George B. Selden. The several defendants were C. A. Duerr & Company and the Ford Motor Co.; in another suit the O. J. Gude Co., and in another John Wanamaker. Coupled with these actions was the suit against Panhard & Levassor and Andre Massenet, its agent, as well as one against Henry and A. C. Newbauer, importers of automobiles.

Samuel R. Betts, of Betta, Sheffield, Bentley & Betts, opened for the complainant, and was followed by R. A. Parker, of Parker & Burton, who argued for the defendants, and particularly represented the suits directed against the Ford company and its agents. The defendants' argument was then taken up by John P. Murray, of Coudert Bros., more particularly representing the foreign manufacturers. William A. Redding, of Redding, Greely & Austin, then took up the rebuttal argument for the complainants, after which W. Benton Crisp continued the argument for the defendants, and Frederick Coudert closed for them. The closing argument for the complainants was made by Frederick P. Fish, Esq., of Boston.

When asked as to his opinion regarding the hearing, Hermann F. Cuntz stated specifically that he must refrain from expressing any views whatsoever. He explained that the case was now before the court, all the briefs had been submitted and the entire record that has been printed containing testimony taken in the past five years has been filed with the court, and hence it would be obviously improper in any way to forecast any opinion.

R. A. Parker gave his views of the matter as follows:

"It would not be proper for me to give my opinion as to which way I think that the Selden suit will be settled, as long as it is now in the hands of the court. Suffice it to say that I feel confident, as do my clients. It is probable that the decision will be rendered in the Fall, or perhaps later, because there is a mass of

testimony to be considered. Our claims are too well known to need discussion, inasmuch as in the suit and the argument last week there was little dispute as to facts. We believe that the plaintiffs cannot hold a patent such as will prevent any man from using any liquid hydro-carbon engine in any road carriage, and because of it sue anyone who does. The patent could apply only to some absolutely new way of combining a certain motor with a certain road carriage, and the independent makers have not done this, and therefore are not bound by the patent to pay the royalties which are claimed. Thus I took the position that a motor which is capable of being applied, when combined with a road carriage capable of being driven by one or more of many motors, cannot be patented. That would simply be a patent of an old use, even if the motor is new, as long as it is a motor. Another point which we brought out was that Selden changed his claims after the Benz patents were taken out in this country in 1888, for although the Selden patent had been applied for first in 1879, the claims were changed in 1889 and the patent was not issued until 1895, so that during a period of years the patentee was benefiting by the experiments of others. Therefore we claim that he has not a right to a universal patent covering the subject, according to decisions of the Supreme Court.

"As to the probable developments after the decision, it may be stated positively that if the patent is upheld, we will appeal, and if the patent is not upheld, the plaintiffs are compelled to appeal by the contract between the A. L. A. M. and the other Selden interests. The only way this could be avoided by them would be to make a new contract and let the matter drop. At any rate if an appeal is taken it would not get into the next court until probably a year from next October, and it would take perhaps six months in the Court of Appeals, so that perhaps it would be two years from the present before another argument would be held, and it can be seen that the patent will nearly have expired, in 1912, before the case would be settled. Should it become necessary it might even be carried to the Supreme Court.

"This brings up another interesting point as to what may develop if the patent expires before the final settlement. If the present defendants, the independent manufacturers and importers, should finally win, the case would be dropped; but if the licensees should win, the question of damages would be a very important matter. It is my opinion that they would have great difficulty in trying to collect. Therefore I feel very confident as to the outcome, both in the near future and that farther away."

MACALMAN PRESIDENT BOSTON TRADE

BOSTON, June 7—The annual meeting of the Boston Automobile Dealers' Association was held to-day and the following officers were elected for the ensuing year: President, J. H. MacAlman, agent for the Columbia and Stearns; vice-president, J. S. Hathaway, manager of the White Company branch; treasurer, F. A. Hinchcliffe, manager of the Winton Motor Carriage Company branch; secretary, Chester I. Campbell; directors, the officers, and J. W. Maguire, agent for the Pierce; Charles E. Fay, manager of the Ford Motor Company branch; A. P. Underhill, agent for the Knox; C. F. Whitney, agent for the Alco and Stoddard-Dayton; E. A. Gilmore, of the Whitten-Gilmore Co., agent for the Thomas, Chalmers and Hudson, and Frank E. Wing, agent for the Marm. Mr. Wink succeeds George H. Lowe, resigned, otherwise the organization is the same as previously.

RAIN POSTPONES CLEVELAND'S CLIMB

CLEVELAND, June 7—Rain coming up late Friday spoiled the roads for the annual Porter hill climb of the Cleveland Automobile Club. The climb will take place Wednesday, June 9.

S. A. E. HAS BEEN INCORPORATED

In order to carry out rather extensive plans for the future, the Society of Automobile Engineers has been incorporated, the papers having been approved in New York City Tuesday, by Supreme Court Justice Guy.

There will be twelve directors and the principal office will be in New York City. The incorporators named are as follows: Russell Huff, of the Packard Motor Company, of Detroit, Mich.; Andrew L. Riker, of the Locomobile Company, Bridgeport, Conn.; Henri C. Chatau, of the General Electric Company, Schenectady, N. Y.; B. D. Gray, of the American Locomotive Works, Providence, R. I.; R. C. Carpenter, of Sibley College, Cornell University, Ithaca, N. Y.; Henry Hess, of Philadelphia; F. J. Newman, of Chicago; Alexander Churchward, of 2 Rector street; Horace M. Swetland, and Thomas J. Fay, of 239 West Thirty-ninth street, New York City. The summer meeting of the society may take place in Chicago, probably in August.

Tungsten Lamps for Auto's Use—Miniature sizes of tungsten lamps can now be obtained for use on automobiles in the place of oil side lamps using kerosene, or for use in enclosed cars.

FROM YORK NEW YORK TO ATLANTA By "Pathfinder"

Photos. by Lazarnick.



On the Scent

Road-Making in Virginia



When New York Met Atlanta



"Pathfinder" Takes a Drink



Near High Point



A Virginian Quartette



Governor Smith and Mayor Meddow Met the Route-Makers



Loc's Headquarters at Gettysburg



Equine and Bovine Education



Near Winchester, Va.



Temporary Road Repairs

It is almost impossible to overestimate the enthusiasm for good roads which has been stirred up in the Southern States through the movement started by the *New York Herald* and *Atlanta Journal*. It was my good fortune to be selected to drive my White Steamer as the *New York Herald* "scout car" from New York to Atlanta. Never before in my touring experience have I seen such an ovation as greeted our party throughout our 1,100-mile journey, commencing from the moment when we were started on our journey from Herald Square by General Leonard Wood to the time when we were met on the outskirts of Atlanta by ex-Governor Hoke Smith, of Georgia, Mayor Maddox, of Atlanta, and several hundred of the leading citizens of the empire city of the South. During at least two-thirds of our journey, we were escorted by a convoy of from one to a dozen automobiles which came to meet us from various towns along the route. The garages where we stored our car over night refused to take payment for gasoline and other supplies and when we came to pay our hotel bills in the morning we found that we had been anticipated by the local chambers of commerce.

It would be too much to say that the sentiment for good roads was created over night by the enterprise of the two newspapers mentioned above. Undoubtedly the sentiment for good roads already existed, but it needed some concrete enterprise, such as a proposition to build a great highway between New York and Atlanta, to crystallize the good roads sentiment and to bring together in co-operation the various automobile clubs along the route, the principal civic bodies in the various cities, and the farmers' organizations in the rural districts. If one-half of the proposed bond issues which we heard about materialize, there will be more money spent on the roads between New York and Atlanta in the next six months than has been spent in the last six years. In the office of the *Atlanta Journal* I looked over several hundred newspaper clippings relating to good roads. Apparently, there is hardly a newspaper published between New York and Atlanta, either in a large city or in a rural community, which has not undertaken to agitate the good roads question in its editorial columns. It is my judgment that within two years the tourist may go from New York to Atlanta without any more fear of encountering severe road conditions than if he were to start for a tour through the New England States.

The route which we covered on our recent tour is one of two or three possible routes between New York and Atlanta. It is by no means the shortest route, but at the present time it is probably the best. The fact that we made the 1,125-mile trip in eleven days, despite the necessary stops for compiling road directions, for taking photographs, and for the receptions along the line, will indicate to every autoist that the route is a thoroughly feasible one, even in the present state of road conditions.

The route which we followed was as follows: southward to Philadelphia and then westward to Gettysburg; then southward again through the Shenandoah Valley to Roanoke, Virginia, then eastward to Danville. From that point we followed approximately the main line of the Southern Railroad through the prosperous regions of the New South all the way to Atlanta.

Considering our route from New York to Atlanta more in detail, the road from New York to Trenton is so well known as to need no comment. Going south from Trenton, most tourists go by way of Bordentown and Camden, but we took a shorter route by crossing the Delaware River by the Trenton bridge into Pennsylvania, and thus avoided the ferry at Camden and the narrow east-and-west streets of Philadelphia.

For 25 miles west of Philadelphia the road is perfect, yet it would seem that the time has come to eliminate the toll gates from the main highway leading westward from the third largest city in the country. After leaving the toll road, we found the road through Coatesville and Kinzer rather rough, but it improves again near Lancaster when we made good time through Wrightsville and York to Abbottstown. From there to Gettysburg, a distance of 15 miles, the road is very rough.

On the Battlefield of Gettysburg the roads were built and are maintained by the National Government, and, needless to say,

are in perfect condition, just as they are on Missionary Ridge and the other national reservations where the nation has undertaken road building.

On leaving Gettysburg, on the morning of the third day of our trip, we had rather rough going for ten or fifteen miles, and then we came to a good macadam road which led us through Waynesboro, Hagerstown and Shepardstown to Winchester, Virginia, where we came to the famous Shenandoah Valley pike, over which we traveled another 95 miles to Staunton. Over more than two-thirds of the distance from Gettysburg to Staunton we paid toll at the rate of from three to five cents a mile.

Our run from Staunton to Roanoke, a distance of 93 miles, was made under very severe conditions. The roads had just been ploughed and were drying up from a hard rain of two days before. The soil was of a consistency which allowed the wheels of the car to sink in nearly to their hubs, and it was just stiff enough to make very hard pulling. Added to this, the going was mainly up hill, with the result that it took much more power to negotiate these roads than was necessary on any other part of the journey.

From Roanoke to Danville we had what could be called fair dirt roads, and this stretch of 117 miles should offer no particular difficulties. The same may be said of the stretch between Danville and the State line between Virginia and North Carolina. It must be understood, however, that the roads in Virginia south of Staunton were not laid out with reference to the requirements of automobile traffic.

The North Carolina roads, almost without exception, are good. Those in Mecklenburg and Gaston counties, particularly, are all that the tourist could wish for as regards smoothness, gradients, drainage, gradual turns and proper banking at the turns.

As for the roads of South Carolina and Georgia, I would say from my observation on this tour and on previous tours through this section, that they are good in dry weather and bad in wet weather. What the tourist wants, however, and what I am convinced will be obtained through the good roads movement started by the *New York Herald* and the *Atlanta Journal*, are roads that will be good in any kind of weather.

As regards the time for the average tourist to make the trip from New York to Atlanta, here again much depends upon the weather. In good weather, on a "keep-going" schedule, eight days should be sufficient time. In rainy weather it is probable that at least two weeks would be necessary. If the tourist should plan to see thoroughly all the places of historic interest and of great natural beauty along the route and, particularly, if he should accept all the invitations which are showered upon him by the hospitable people of the South, an entire touring season would be none too much to allow for the journey.

ALL WANT TO BE ON NEW YORK-ATLANTA ROUT

In the wake of the proposal to build a national automobile highway between New York and Atlanta came the rivalries of the cities and towns on the several proposed routes.

Leonard Tufts, a Bostonian well known in the development of Pinehurst, N. C., supplied excellent reasons for the route across North Carolina which would include Pinehurst and Southern Pines. From material Mr. Tufts sent out is the following:

G. N. McMillan has been a guest at Pinehurst for several years, and through his enthusiasm and interest in the subject he with others induced the people of Southern Pines and myself to build a road between Pinehurst and Southern Pines. This was the first really good road in the southern section of Moore County. Since then four townships have voted to tax themselves for good roads, and one has recently got a bond issue for \$15,000. Mr. McMillan has been pushing and talking good roads for the past three years and has believed from the first that a highway from the North to the South would be made practical within a few years with proper organization and push. At first this seemed absurd to me and to others, but I believe his prophecy will come true during the coming winter. Captain W. I. Everett, of Rockingham, N. C., has been a great power in interesting people in Richmond County in building roads. There are a great many people, as for example, Dr. Gilbert McLeod, of Carthage, who has given his time for the maintenance of the roads; John R. McQueen, of Lakeview, who is responsible for the bond issue of McNeil Township. The result of this work is that this fall there will be a fine road across Moore and Richmond counties going by way of Vass to Lakeview, Southern Pines, Pinehurst, West End, Jackson Springs, Elba Springs and Rockingham, toward Cheraw to the South Carolina line.



Crown Point, Where the Storm Centre of the Contests Will Be

CHICAGO, June 8—Thirty entries—12 in the Cobe cup and 18 in the Indiana trophy—have been received for the road-racing carnival of the Chicago Automobile Club, set for decision June 18 and 19 over the Crown Point-Lowell course, the list officially closing Saturday at the regular fees, although it is possible for others to get in up to Thursday of this week upon payment of an extra charge of \$250 a car. In point of numbers this compares most favorably with Savannah, which has the record with 37 entries.

Thirteen different makes of cars are represented in the two races, six being in the Cobe cup. In addition the Locomobile, Stoddard-Dayton and Buick are in both contests. The entry fees total \$10,700. Drivers nominated include such stars as Robertson, Lytle, Strang, Florida, Poole, Denison and Bourque, the complete entry list reading as follows:

COBE CUP

Car	Driver
Apperson	H. Lytle
Bulck	Not named
Bulck	L. Strang
Bulck	R. Burman
Bulck	L. Chevrolet
Fiat	E. A. Hearne
Knox	A. Denison
Knox	W. Bourque
Locomobile	G. Robertson
Locomobile	J. Florida
Stoddard-Dayton	C. A. Engubeck
Stoddard-Dayton	B. Miller

INDIANA TROPHY

Bulck	L. Strang
Bulck	R. Burman
Bulck	G. DeWitt
Chalmers-Detroit	A. Poole
Chalmers-Detroit	J. Matson
Chalmers-Detroit	W. Knipper
Corbin	Not named
Fal-Car	E. M. Harrison
Fal-Car	A. H. Peirce
Ford	Not named
Locomobile	G. Robertson
Locomobile	J. W. Florida
Marlon	H. E. Stutz
Marlon	A. Monsen
Moon	P. Wells
Renault	A. W. Grelnor
Stoddard-Dayton	H. Tuttle
Stoddard-Dayton	Not named

With the entry proposition off their minds the promoters of the contests are now busily engaged in completing the arrangements at Crown Point. The course is rapidly nearing completion, and it is expected the contractors easily will finish by the stipulated

time—to-morrow. The entire circuit has been treated with taroid, and while there has been no attempt at speed, it is more than apparent that the course is lightning fast. Indeed, there is hardly a driver who has seen it who has not predicted a smashing of records in both events. Considerable difficulty has been experienced by motorists getting on the course just for the purpose of trying it. Generally the result has been that they have had their cars plastered with tar, while the ravages of their wheels have compelled the road-makers to do additional work.

The big grandstand, which is designed to hold 10,000 people, is as good as done, although the contractors still have several days more in which to put on the finishing touches. The sale of seats for this stand is up to expectations, although the demand so far has been more for boxes and parking spaces. Only 30 of the 164 boxes remain,

while the club has been forced to secure additional parking space. But from the inquiries the grandstand seat sale will open up before the end of the week, so that everything should be sold two days before the races.

General Executive Trego intends moving his effects to Crown Point on Thursday and establishing his quarters there. On that day the official drawing for numbers will take place, while practice on the course will not begin until next Monday because of the objection of the Lake county farmers, who did not wish to have their roads tied up for 10 days as was at first contemplated. The training will take place between 2 and 4 o'clock in the afternoon because of the fact that the farmers have to use the roads in the morning to make milk deliveries.

Noted Drivers Prepare for Great Contest

Already there is a gathering of the clans. Robertson and Florida, with their mechanics, Campbell and Ethridge, are here, and the Locomobile camp at Crown Point will be established to-night. week, few suspecting that the Detroiters were there. George Bill is in charge of the camp and he has with him five men and four cars. The third Chalmers entry was not made until the final moment, at which time the company announced that its drivers will be Al Poole, William Knipper and Joe Matson. Poole, everybody knows, formerly was Tracy's mechanic, and last year he drove the Isotta in several road races. Knipper has just finished the Denver-City of Mexico stunt and is hurrying home for the new venture, while Matson gained fame as the driver of the Corbin last year.

The two Fal-Cars are making their debut in competition and the Chicago concern manufacturing them has been pushed to the limit to get them out in time. This delayed the entry to the final moment, when Sales Manager Averill turned in the check.

The Chicago Automobile Club is determined to make both races stock propositions, and to insure this the members of the technical committee already have started their work visiting the various factories. F. E. Edwards went to Flint and Detroit Saturday, while Berne Nadall swung into Indiana and Ohio last night. Chairman Beecroft goes East to-night. At each factory duplicate cars are examined and measured and before any one is allowed to start there will be another examination to see if the two sets of figures agree.

TABLE SHOWING GENERAL SPECIFICATIONS OF CARS ENTERED FOR THE CONTEST FOR THE COBE TROPHY

CAR	Entrant	Driver	No. of Cyls.	Cylinder Bore	Cylinder Stroke	Wheel-base	Clutch	Trans.	Speeds	Reverse	Drive	Cooling	Oiling	Ignition
KNOX	Knox Auto Co.	Denison	4	5	4.75	106	Three-plate	Sel.	3	1	Shaft.	Gear pump	Gear pump.	Dual.
KNOX	Knox Auto Co.	Bourque	4	5.5	5.5	106	Disk.	Sel.	4	1	Chain.	Cent. pump	Gear pump.	Dual.
LOCOMOBILE	Locomobile Co. of A.	Robertson	4	5	6	123	Cone.	Sel.	4	1	Chain.	Cent. pump	Pump.	Two.
LOCOMOBILE	Locomobile Co. of A.	Florida	4	5	6	123	Cone.	Sel.	4	1	Chain.	Cent. pump	Pump.	Two.
FIAT	Ed. W. Hearne	Hearne	4	5.1	5.5	126	Disk.	Sel.	4	1	Chain.	Cent. pump	Pump.	Single.
BUICK	Buick Motor Co.	Strang	4	4.5	5	112	Cone.	Sel.	3	1	Shaft.	Gear pump	Force feed.	Single.
BUICK	Buick Motor Co.	Chevrolet	4	4.5	5	112	Cone.	Sel.	3	1	Shaft.	Gear pump	Force feed.	Single.
BUICK	Buick Motor Co.	Burman	4	4.5	5	112	Cone.	Sel.	3	1	Shaft.	Gear pump	Force feed.	Single.
APPERSON	Apperson Bros. Co.	Lytle	4	5.75	5	116	Cont. band.	Sel.	4	1	Chain.	Gear pump	Force feed.	Single.
APPERSON	Apperson Bros. Co.	Seymour	4	5.75	5	116	Cont. band.	Sel.	4	1	Chain.	Gear pump	Force feed.	Single.
STOD-DAYTON	Dayton MotorCarCo.	Miller	4	5.25	5.75	106	Cone.	Sel.	3	1	Shaft.	Gear pump	Pump.	Mag'to & bat.
STOD-DAYTON	Dayton MotorCarCo.	Englebeck	4	5.25	5.75	106	Cone.	Sel.	3	1	Shaft.	Gear pump	Pump.	Mag'to & bat.

TABLE SHOWING GENERAL SPECIFICATIONS OF CARS ENTERED FOR THE INDIANA TROPHY

CAR	Entrant	Driver	No. of Cyls.	Cylinder Bore	Cylinder Stroke	Wheel-base	Clutch	Trans.	Speeds	Reverse	Drive	Cooling	Oiling	Ignition
CORBIN	Corbin M. Veh. Corp.		4	4.5	4.25	100	Cone.	Sel.	3	1	Shaft.	Pump.	Pump.	Dual.
RENAULT	Arthur W. Greiner	Greiner	4	3.93	5.51	100	Cone.	Prog.	4	1	Shaft.	Ther.-syp'n	Pump.	Single.
LOCOMOBILE	Locomobile Co. of A.	Robertson	4	4.5	4.5	120	Cone.	Sel.	4	1	Shaft.	Cent. pump	Pump.	Dual.
LOCOMOBILE	Locomobile Co. of A.	Florida	4	4.5	4.5	120	Cone.	Sel.	4	1	Shaft.	Cent. pump	Pump.	Dual.
FORD	Ford Motor Co.	Dunnell	4	3.75	4	100	Disk.	Plan.	2	1	Shaft.	Ther.-syp'n	P'd fly'w'll.	Double.
CHALM.-DETT.	Chalm.-Dett' M. Co.	Poole	4	4	4.5	110	Disk.	Sel.	3	1	Shaft.	Cent. pump	Pump.	Double.
CHALM.-DETT.	Chalm.-Dett' M. Co.	Knipper	4	4	4.5	110	Disk.	Sel.	3	1	Shaft.	Cent. pump	Pump.	Double.
CHALM.-DETT.	Chalm.-Dett' M. Co.	Matson	4	4	4.5	110	Disk.	Sel.	3	1	Shaft.	Cent. pump	Pump.	Double.
BUICK	Buick Motor Co.	Strang	4	4.37	5	112	Cone.	Sel.	3	1	Shaft.	Gear pump	Force feed.	Single.
BUICK	Buick Motor Co.	De Witt	4	4.37	5	112	Cone.	Sel.	3	1	Shaft.	Gear pump	Force feed.	Single.
BUICK	Buick Motor Co.	Burman	4	4.37	5	112	Cone.	Sel.	3	1	Shaft.	Gear pump	Force feed.	Single.
MOON	Moon Motor Car Co.	Wells	4	4.5	4.5	112	Disk.	Sel.	4	1	Shaft.	P. p. no fan.	Pump.	Single.
STOD-DAYTON	Dayton MotorCarCo.	Wiseman	4	3.87	4.5	106	Cone.	Sel.	3	1	Shaft.	Gear pump	Pump.	Mag'to & bat.
STOD-DAYTON	Dayton MotorCarCo.	Wright	4	3.87	4.5	106	Cone.	Sel.	3	1	Shaft.	Gear pump	Pump.	Mag'to & bat.
MARION	Marion M. Car Co.	Stutz	4	4.25	4.5	112	Disk.	Prog.	3	1	Shaft.	Cent. pump	Pump.	Mag'to & bat.
MARION	Marion M. Car Co.	Monsen	4	4.25	4.5	112	Disk.	Prog.	3	1	Shaft.	Cent. pump	Pump.	Mag'to & bat.
FAL-CAR	Fal Motor Co.	Pearce	4	4.25	4.5	108	Cone.	Sel.	3	1	Shaft.	Gear pump	Pump.	Mag'to & bat.
FAL-CAR	Fal Motor Co.	Ruel	4	4.25	4.5	108	Cone.	Sel.	3	1	Shaft.	Gear pump	Pump.	Mag'to & bat.

OCEAN TO OCEAN RACERS IN THE OPEN WEST

St. Louis, June 7—Much like four spirited animals which have been held in leash and then suddenly turned loose, the quartette of autos which are racing from New York to Seattle left this city this evening, free to go as far and fast as they choose. Leaving New York on last Tuesday afternoon, they were kept well bunched by Pacemaker Gerrie until this city was reached, when the restrictions were removed, and at 8.15 o'clock this evening the two little Fords, which have been in the lead, swung out into the open country toward Kansas City, with the big Acme and the Shawmut not very long behind them.

NEW YORK ORPHANS' DAY POSTPONED

New York, June 9—Owing to rain the orphans' day celebration planned for to-day has been postponed until Friday. For the first time in five years, since the first outing given to the inmates of the city institutions, there has been enough cars offered, besides contributions of nearly \$1,000 in cash for hiring machines. Between 150 and 200 automobiles were promised, and the donors have been requested to give the use of them on Friday. The capacity of these cars would be 2,000 children. The main portion of the day will be spent at Coney Island.

Tuesday the Long Island Automobile Club gave the orphans of Brooklyn their annual treat. Some 150 autos conveyed 900 children to Luna Park at Coney Island, which event was followed by a ride around the city. President Frank G. Webb, and Dr. W. P. Richardson, chairman of the committee, directed.

FORBES WINS BALLOON CHAMPIONSHIP

Indianapolis, Ind., June 9—The balloon *New York*, with A. Holland Forbes as the pilot, is the winner of the national balloon race with a journey of 358 miles. The *University City*, Captain Berry as pilot, was second with 329 miles; the *St. Louis*, Lambert at pilot, third with 321 miles; the *Indiana*, Fisher as pilot, fourth with 264 miles, and the *Hoosier*, Captain P. S. Baldwin pilot, fifth with 234 miles. Captain Baldwin was the constructor of the winning *New York*. The handicap race was won by the *Indianapolis*, D. G. Link pilot, with 222 miles.

MANY ENTRIES FOR CATSKILL-BERKSHIRE RUN

New York, June 7—So far-famed is the touring ground of the Catskill Mountains and the Berkshire Hills, over which the New York Automobile Trade Association will hold its reliability contest next Saturday, Sunday and Monday, that there will probably be at least 35 cars in the party. They will leave Columbus Circle at 8 o'clock on Saturday morning, taking the Forty-second street ferry and reconvening on the Hudson County boulevard at Weehawken. The first night stop will be at Catskill, running via Suffern, Lake View hotel for lunch, Newburg and Kingston. The route on Sunday will be to Pittsfield, via Albany, and only the afternoon will be used in making the trip so that the participants may tour to Catskill Mountain resorts in the morning. On Monday they will return to New York via Stockbridge, Great Barrington and Poughkeepsie.

The cars which have been entered so far are: three Mitchells, three Franklins, three Stevens-Duryeas, two Stoddard-Daytons, two Oldsmobiles, two Marmons; one each of National, Lancia, White, Knox, Royal Blue cab, Packard, Autocar and Matheson.

MITCHELL AGNETS HAVE CONCLAVE

New York, June 7—To discuss the output of the Mitchell Motor Car Company for the next season, and to give the management a better idea of what the public wants, as seen through its local representatives, 25 of its agents held their annual convention in the Manhattan Hotel last week.

The following were in attendance: From the factory, William Mitchell Lewis, general manager; J. W. Bate, designer; James W. Gilson, sales manager; G. V. Rogers, secretary; George W. Osen, San Francisco; E. E. Gilmore, Jacksonville, Fla.; Fred Bennett, Portland, Ore.; J. Clarke Coit, Omaha, Neb.; E. H. Greer, Los Angeles, Cal.; C. F. Gilmore, Detroit; A. F. Chase, Minneapolis; W. W. Sears, Des Moines, Ia.; Nelson T. Hayes, Kansas City, Mo.; George Weber, St. Louis; Horatio L. Hall, Chicago; W. M. Jenkins, Boston; J. A. Cramer, Buffalo, N. Y.; John Van Benschoten, Poughkeepsie, N. Y.; J. M. Cram, Racine, Wis.; Walter M. Cram, Philadelphia; F. L. C. Martin, Plainfield, N. J.; Charles P. Skinner, Warren D. Brown, O. R. DeLamater, George A. Skinner, New York.



Packard Three-Ton Trucks as Sightseeing Buses

Several buses, each accommodating thirty-four persons have been fitted up from regular Packard three-ton truck chassis. Among the places where these will be tried are the Alaska-Yukon-Pacific Exposition in Seattle and private enterprises at Colorado Springs, Col.

Hoblitt to Start Long Trip in Alco— F. M. Hoblitt, known generally throughout the automobile trade as the first traveling man selling motor cars, is to start June 10 on a more novel trip than usual. A couple of years ago, Mr. Hoblitt and Arthur Jervis became known as the "vanadium twins" while exploiting a new six-cylinder car of the American Locomotive Company across the country. Mr. Hoblitt is the traveling representative of the Alco pleasure cars, cabs and trucks, and on his forthcoming trip he will use a 40-horsepower Alco car instead of traveling by train. He will take no chauffeur, but will drive the car himself and carry only one passenger. Mr. Hoblitt's route includes Albany, Buffalo, Cleveland, Toledo, Chicago, Milwaukee, Minneapolis, Denver, Kansas City, St. Louis, Louisville, Columbus, Pittsburg, Philadelphia and New York. This means that he will cover the full route of the Glidden tour as an incidental part of his trip, which completed, will be more than twice the mileage of the Glidden tour.

Whiskey vs. Gasoline—How whiskey, as a substitute for automobile fuel, saved a Japanese nobleman from missing a transcontinental train down in Texas, is the subject of a laughable story in the current issue of the Rambler Magazine, a publication issued in the interest of Rambler owners, by Thomas B. Jeffery & Company. A cartoon showing the progress of the automobile among the farmers of the Southwest is described in an interesting way by Mr. Jeffery, who discovered at the Kansas City automobile show that the Southwest farmer had become so prosperous that he frequently came to town to have his nails manicured. Mr. Jeffery also tells why the farmer is so prosperous, saying, "Wheat in Kansas at \$1.30 costs 30 cents to raise, and corn at 75 cents costs 25 cents to raise." This is why the farmers are buying automobiles. Even the manicure lady is pictured in a comic cartoon.

Pacific Coast Wants Enclosed Cars— Within a year or two the Pacific coast will have as many enclosed automobiles as the East, is the prediction of the Pierce-Arrow western dealers who have

been at the factory lately. One gave his reasons for this belief thus: "The people on the coast adopted the touring car quickly, and have realized that with the automobile a suburban home is possible, and as accessible as a town house. This has brought into use the enclosed car so that it is serviceable in all kinds of weather, and during the past year we have sold a number of 36-horsepower Pierce-Arrow landaulets and broughams. The use of the lower-powered cars of the enclosed type is bound to bring about a demand for high-powered cars with enclosed bodies. This has been shown conclusively by the inquiries made before I started for Buffalo concerning fall deliveries."

Lots of Business in Syracuse—Due to the rush of orders for light delivery trucks, the Chase Motor Truck Company, Syracuse, N. Y., has been obliged to operate its plant overtime. The factory comprises 62,000 square feet of floor space, to which has just been added two new buildings each 85 by 30 and two stories high. Moreover, even this is not sufficient, and arrangements are now being made for another building of equal size. The most recent addition to the Chase line is a business man's surrey, the construction of which is similar to other Chase cars.

Rambler Revives Road Sign Campaign—With a new issue of 5,000 metal signs for posting at doubtful points on roads, Thomas B. Jeffery & Company have revived a campaign which was started two years ago. At that time a large number of these guides were supplied to automobile clubs or to Rambler dealers throughout the middle West and in some parts of the East, and erected in needed places. The signs are 12 by 24 inches in size, ample to be seen readily, and with the production of the new ones a great many more roads throughout the country will be well marked.

New Departure Bearings on A-K Winner—The New Departure Manufacturing Company, of Bristol, Conn., is calling attention to the victory of the Allen-Kingston car in the Sport Hill climb at Bridgeport, in which car New Departure

bearings are used throughout. There are four on the crank shaft, and in this contest demonstrated their workings, which combine thrust with radial load bearings. The A-K covered the distance in its class in 1:18.3-5, and the thrust stresses were severe at certain points along the course.

Continental Increases Factory Space— By the addition of a third floor to its main factory in Muskegon, Mich., the Continental Motor Company will greatly increase its facilities. For several months it has been having difficulty in keeping pace with its orders, although employing 500 men. The erection of the third story will permit the use of 200 more men and will enlarge the output materially. The company claims that it has turned down more orders for the coming year than it has accepted.

Hercules Electric Company Enlarges Plant—Sales of the new magnetos made by the Hercules Electric Company, Indianapolis, Ind., have been increasing so rapidly that greater facilities for their manufacture have become necessary. An additional building has already been constructed, with machine equipment that will increase the capacity of the concern by 50 per cent. Preparations are now being made for the erection of another plant in which the magnetos will be made.

Cleveland Concern Gets New Lease of Life—A new company just incorporated has taken over the plant of the old French-American Motor Car Company, Cleveland, O. By a strange coincidence the new concern will be known as the White Motor Car Company, after the backer, W. B. White, who is, however, no relation to and has no connection with the White family in the White Company, makers of White steamers, located in the same city.

Morgan Leases Building for Worcester Factory—For the manufacturing of automobile trucks, the R. L. Morgan Company, Inc., has leased a three-story building on Cambridge street, Worcester, Mass. The structure is owned by the Crompton Associates, and formerly occupied by the Crompton-Thayer Loom Works. Between 50 and 60 men will be employed shortly, and the plant will have a capacity of 500 cars yearly.

Winton Chauffeurs' Contest Nears End—The Winton Motor Carriage Company, of Cleveland, is receiving records from all parts of the country of chauffeurs who are preparing their reports for the Winton chauffeurs' contest. The month of June is the last for the 1909 season, and already some of the outlines received have been further wonderful evidence of the satisfaction being secured from the Winton product.

Motor Car Equipment Company Leases Building—The entire building at 55 Warren street, New York, has been secured by the Motor Car Equipment Company, of 1727 Broadway, importers and manufacturers of automobile accessories. The additional space will be utilized for the large stock of materials and sundries used in filling the concern's trade saying of "Everything for the autoist but the auto."

Rapid, Too, Needs More Space—After having just completed and occupied the latest addition with a full line of automatic machinery, the Rapid Motor Vehicle Company, Pontiac, Mich., has already found the new quarters too small and has planned a concrete, steel and glass building which will be two stories high, with 76,800 square feet of floor space, the dimensions being 60 by 640.

New Company Proposed in Springfield, Ill.—Plans have been made in Springfield, Ill., for the organization of a new automobile corporation, to be called the Springfield Motor Car Company, with a capitalization of \$250,000. It is proposed to erect a modern building in Harvard park, 250 by 500 feet in size, and have it ready for occupancy by fall.

Additional Factory for Salisbury Wheel Company—The Salisbury Wheel & Manufacturing Company, of Jamestown, N. Y., has leased the factory of the Straight Manufacturing Company, and will utilize it as an auxiliary plant. The concern has been working day and night, but has been unable to catch up to its orders. By the addition its capacity will be doubled.

Carpenter Steel Company Opens Hartford Branch—The Carpenter Steel Company, of Reading, Pa., has opened a branch office and warehouse at 189 Allyn street, Hartford, Conn. The business will be under the management of George S. Cairnes, who for many years has been identified with the tool steel trade of New England.

Countryman Automobile Company Retires—The Countryman Automobile Company, Minneapolis, Minn., has sold its business to the Heany Automobile Company of Aberdeen, S. D. The latter firm will retain its location in Aberdeen and in addition handle the Halliday cars from the Motor Mart for Minneapolis.

PERSONAL TRADE MENTION

Otis R. Cook, one of the best known men in the tire trade, and since September last manager of the tire department of the Federal Rubber Co., Cudahy, Wis., has just been appointed general manager, his jurisdiction having been extended to include the mechanical rubber department in addition to the tire department. Mr. Cook will make his headquarters as before at the company's Milwaukee office, corner Oneida and Milwaukee streets.

Frank L. Kingston, of Kokomo, Ind., who is the general manager of the recently incorporated Planhard Manufacturing Company, has been until recently associated with Byrne-Kingston & Company, of that city, of which concern his brother, George Kingston, is general manager. The latter is not identified in any way with the Planhard company.

Henry Haines Hower, well known as a writer on automobile topics, was married to Miss Louise Northrop, at Cleveland, on Tuesday of this week. Mr. Hower is the automobile editor of the Cleveland *Plain Dealer*, and Cleveland correspondent of THE AUTOMOBILE.

Robert P. McCurdy, of Pittsburgh, will have the agency in that city for the Pierce-Arrow automobiles. He has resigned from his position as manager of Banker Brothers, the agents for Chalmers-Detroit and Stevens-Duryea cars.

C. F. Baker has joined the forces of the American Motor Car Company, of Indianapolis, as sales manager. Mr. Baker has been identified for several years past with the Pope Company, at Toledo, O.

OBITUARY NOTICE

F. W. Hedgeland, president of the Hedgeland Manufacturing Company, of Canton, O., died on May 30. Mr. Hedgeland was the inventor of the equalizer which bears his name.

IN AND ABOUT THE AGENCIES

Maxwell, San Francisco, Cal.—The Maxwell-Briscoe Company is preparing to move to its new building at Fulton street and Van Ness avenue, which will be a distributing point for the Pacific coast and the western territory.

Babcock, Cleveland, O.—The Babcock Electric Garage & Sales Company has opened a new establishment on Euclid avenue, opposite Sixty-sixth street, to be devoted exclusively to electric automobiles, in addition to the Babcock.

N. Y. TRADE NAMES CUTTING

General John T. Cutting was elected president of the New York Automobile Trade Association in the recent annual meeting. The choice of the Oldsmobile representative was unanimous, and to serve with him the following were named: First vice-president, C. William



General John T. Cutting

Wurster, Stearns; second vice-president, C. P. Skinner, Mitchell; treasurer, Richard Newton, Stoddard-Dayton; secretary, Walter R. Lee, re-elected. The board of directors is made up of the following: C. Andrade, Jr., counsel; Frank Eveland, Stevens-Duryea; William Haradon, Columbia; G. W. Bennett, White; Harry Fosdick, Lancia; W. W. Burke, Mora; Peter Fogarty, Marmon, American Mors, Interstate, and A. J. Inderreiden, Warner Instruments.

The financial report showed that the association is in a very flourishing condition, and a number of important movements are being carried on by it. Among these is the three-day endurance run to be held on June 12, 13 and 14.

NEW AGENCIES ESTABLISHED

Gaeth: Chicago—International Automobile Company, 1243 Michigan avenue.

Hudson: Boston—Whitten-Gilmore Company, for eastern Massachusetts.

Marion: Plaqu, O.—H. B. Greenamyre.

RECENT INCORPORATIONS

Mutual Automobile Association, New York.—Capital \$50,000. To manufacture automobile and other motor vehicles. Incorporators: F. Haasters, G. L. Clarke, O. B. Bachman.

20th Century Motor Car & Supply Company, Indianapolis.—Capital \$60,000. To manufacture automobiles. Incorporators: M. L. Williams, H. E. Keyer, H. L. Wolverton.

Auto Appliance Company, New York.—Capital \$25,000. To manufacture shock absorbers for automobiles. Incorporators: W. J. Singer, J. W. Lowell, J. L. Douglass.

Manlius Motor Company, Syracuse, N. Y.—Capital \$20,000. To manufacture gas engines and deal in automobiles. Directors: G. A. Fowler, M. J. Topp, W. H. Topp.

Custer Manufacturing Company, Marion, Ind.—Capital \$12,000. To manufacture automobiles. Directors: Angela G. Custer, Burr Custer, G. D. Custer, R. J. Custer.

Michigan Crank Shaft Company, Muskegon, Mich.—Capital \$10,000. To manufacture crankshafts for automobiles.

Elton Auto Repair Company, Youngstown, O.—Capital \$25,000. Incorporators: Fred Tod, Albert Elton, B. M. Campbell.

RECENT PUBLICATIONS

Fried-Ostermann Company, Rockford, Ill.—Price automobile gloves are well described in a beautiful little booklet issued by the Fried-Ostermann Company, of Rockford, Ill., the successor to the H. W. Price Company. The catalogue is printed in colors and with designs that are very attractive, aside from their value in an advertising sense. The cover is a pretty color plate of a man and a woman in an automobile, showing Price gloves on their hands, but not making them so exceedingly prominent to detract from the picture itself. This is true also of the frontispiece. The catalogue describes a great many kinds of gloves and gauntlets, in colors, telling of their quality, goods and price. The cuts are all so clear that a pair of the articles might be ordered without having really seen them, and yet their appearance would accurately be known.

Buckeye Jack Manufacturing Company, Louisville, O.—Automobile jacks in six sizes are manufactured by the Buckeye Jack Manufacturing Company of Louisville, O., with capacities of one ton, except one style with a lifting capacity of 1,800 pounds. This concern is well and favorably known as a maker of compound lever truck and automatic jacks, especially for use on railroads, and the automobile devices are made of the same quality of material as used in the machines which can lift 15 tons. These are all described in catalogues recently issued, giving detailed specifications, such as raise of bar, weight, price, size of base, and other particulars of interest both to the manufacturers who supply jacks with their complete automobiles or to the owner who is equipping a car.

THE ELECTRIC CARRIAGE

By the Waverley Poet

It does not shy at papers as they blow along the street,
It cuts no silly capers on the dashboard with its feet;
It does not paw the sod up all around the hitching post,
It does not scare at shadows as a man would at a ghost;
It does not gnaw the manger, it does not waste the hay,
Nor put you into danger when the band begins to play.

It makes no wild endeavor to switch away the files,
It sheds no hair whatever to get in mouth and eyes;
It speeds along the highways and never looks around,
For things that it may scare at, and spill you on the ground;
It does not mind the circus—it's not at all afraid,
And does not overwork us when the elephants parade.

It does not rear and quiver when the train goes rushing by,
It does not stand and shiver when the little snowflakes fly;
It does not mind the thunder nor the lightning's blinding flash,
It does not keep you chirping and connecting with the lash.

When you chance to pass its stable you do not have to care,
Or cluck for all you're able to keep from stopping there;
There's no one to arrest you if you do not treat it right—
It will work all through the daytime and still be fresh at night.
It's a thing of proper manners which it shows in various ways,
So that all men and women are saying nowadays:
"It may once have been the thing to 'hitch your wagon to a star,'
But now to be quite in the swim you must hitch to a Waverley Car!"

Information for Auto Users

No-Klog Gasoline Filter—While it is a well-known fact that the fuel used in automobiles is very carefully guarded against dirt and water, it is also a fact that any car with a good filter will give better results than one without. To supply this need the Standard Gasoline Filter Company, Attleboro, Mass., is putting out the No-Klog filter, which

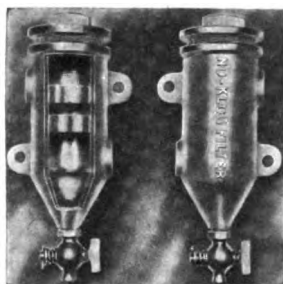

NO-KLOG GASOLINE FILTER

has a number of excellent features to commend it. The filter serves a fourfold purpose, as it extracts dirt, separates out water, by purifying the fuel increases the power, and acts as an auxiliary reservoir. In its construction the best of brass is used, the design being such as to allow the ready removal of the strainers, the withdrawal of the entrapped water, has standard pipe connections for all commercial sizes, and fine threads, twenty to the inch, which aid in keeping the elusive gasoline from leaking away, as well as keeping out objectionable dirt and other foreign matter. The device is small, compact, not expensive, attaches in any position whatever, and is readily put on or taken off. The makers state that no autoist who has ever tried one and found out the benefits to be derived from it would thereafter be without one.

Displayed a Marked Fondness for the Bottle—In the recent spectacular parade of the New York Trade Carnival, the float representing the Thermos bottle



THERMOS BOTTLE FLOAT IN PARADE

was enthusiastically received, the applause all along the route, and the awarding of the second prize seeming to indicate the marked fondness for "the bottle" in general and the Thermos bottle in particular. The float was a gigantic representation of a Thermos bottle laid

on its side, enthroned upon which was a beautiful young woman driving a flock of white doves with ribbons. The wheels were hidden by stationary shields so that no motion could be seen, and the effect of the flying dove providing the motive power for the vehicle was complete. The bottle is made by the American Thermos Bottle Company.

Quick-Detachable Pump Connection—Speed is the cry to-day, and in the interest of obtaining this much-desired quality, even the little accessories are receiving their share of attention. A very new one, right up to the minute, so to speak, is the pump connection, a very minor accessory. Yet a new pump connection is now being marketed, which has the desired quality incorporated in its construction. This is the "Grab" connection, the name having been selected as indicative of the method of

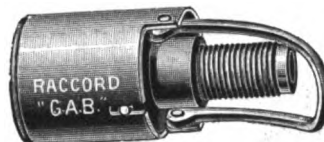

GRAB PUMP CONNECTION

working. It differs from the usual connection in that the fastening is a clamp and not a screw or push connection. This allows of the rapid attachment or removal, and as it will fit any valve, with no chance of getting out of order, is doubtless in line for popular adoption. The makers' claim of simplicity and fool-proof construction is seen to be well founded. It is sold by the Motor Car Equipment Company, 1727 Broadway, New York City.

A Ball-Bearing Turntable—Many automobile accidents are caused by cars backing out of garages and other places, through inability to turn in the limited space within. To overcome this, a turntable provides a means of turning a car in its own space, and every garage should have one. The Lansing Wheelbarrow Company, Lansing, Mich., is the manufacturer of an efficient device of this sort. This light, but strong, turntable, is built right into the floor of the garage and, being mounted upon ball bearings, turns very readily even with the heaviest machine upon it. The turntable not only avoids the chances of accidents due to the backing out process but removes the

possibilities of damage to the machine itself on the curbstone or otherwise, and represents less heavy labor and therefore better work on the part of the employee.

In the illustration of the turntable in practical use in a garage, a car is shown in place with a man working upon it, the whole showing how readily one man may handle even a very heavy car when placed upon the turntable, the latter operation requiring possibly three or four men. In this way the saving due to the use of one of these devices is pictured in a striking manner.

Let the Auto Do the Work—In the inflation of tires by the old back-breaking way, with a hand, or, as it is sometimes called, a foot pump, much good energy was wasted which might have been put to an otherwise good use. The modern way of inflating tires takes care of this and now there are on the market a number of mechanical means of doing

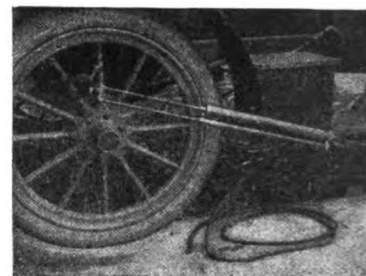

E-Z TIRE PUMP READY FOR USE

this work. One of the best of these is the E-Z Auto Pump Attachment, made by Wheaton & Cummings, Sunbury, O. This works on the eccentric principle, that is, the free end of the pump is fastened to the spokes of the wheel, which, of course, would place it off center or eccentric. The amount of this eccentricity determines the stroke of the pump. The other or delivery end may be fastened to the running board, or it may be placed on the ground or floor and held with the foot. The revolution of the wheel, which had previously been jacked off the floor so as to be free to rotate, operates the compression and delivery of air to the desired place. The whole outfit is very simple, consisting of a pump barrel with a hinged foot plate, and the clamps to fasten the driving end to the wheel. Being so simple or composed of so few parts, it is readily attached to or detached from the wheel.

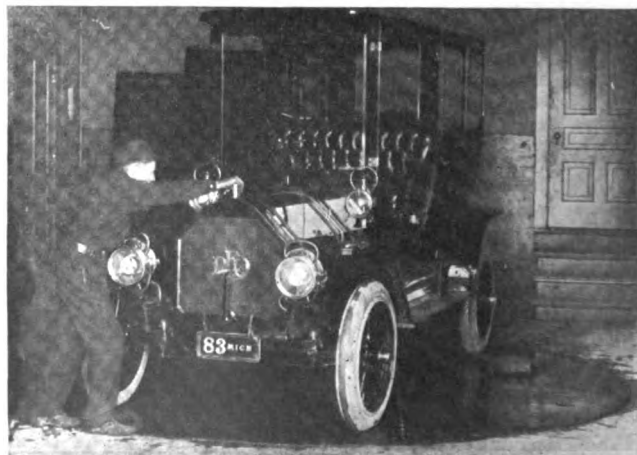

CAR ON LANSING WHEELBARROW COMPANY'S TURNTABLE

THE AUTOMOBILE

A CONTEST TOUR WHICH EMBRACED FOUR STATES

IDEAL touring conditions—fascinating scenery, magnificent roads, nearly perfect weather—and an endurance contest in which a dozen of seventeen starters finished with perfect scores were experienced by those who participated in the “week-end” tour of the New York Automobile Trade Association. Leaving the busy city on Saturday morning for Catskill, thence to the Berkshire Hills on Sunday, and a run from Pittsfield to the metropolis on Monday, gave a route replete with scenic grandeur, and on such splendid highways as to mark this 350-mile trip as one of coming wide popularity. Ramapo Hills, Catskill Mountains and the far-famed Berkshires, interspersed with glimpses of the Hudson and other rivers, can furnish more beautiful vistas than will be found within a short radius of any other large city. The contesting nature of the tour introduced a spiciness which lent particular interest, and the rules were not so rigorous as to detract from the pleasures of leisurely traveling—a really delightful combination.

White, Franklin, National, Knox, Franklin again, Oldsmobile,

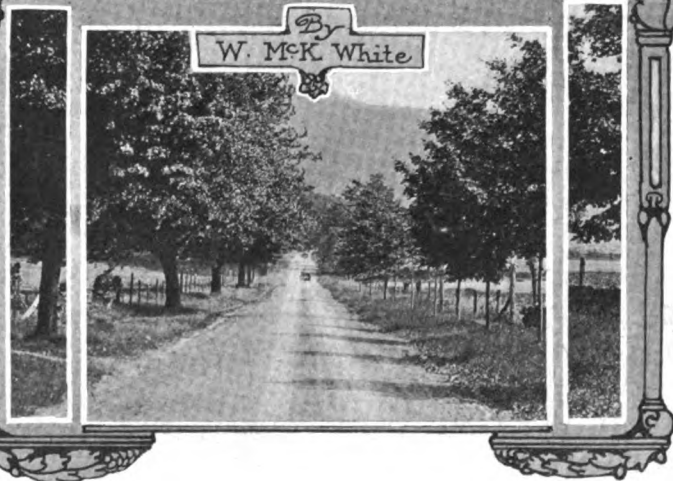

Columbia, Mitchell three times, Interstate and Thomas taxicab were the makes which traveled the 351.2 miles on a time schedule with checking stations at frequent intervals, without being late or having to make adjustments on the roads. Stevens-Duryea, Stoddard - Dayton, and Mitchell were penalized, and Stoddard-Dayton and Standard withdrew, but continued as non-contestants. The one free-lance of the party was a Lancia. The automobiles which were penalized or withdrew were the victims of slight derangements,

which would be overlooked in ordinary touring, or perhaps prevented, but which in a contest caused a disturbance. Only one serious mishap occurred, and that was to a touring car making its debut in the metropolitan trade circles, the Standard, a production of the Standard Roller Bearing Company in Philadelphia. In rounding a corner in Kingston, N. Y., the car skidded and broke a wheel against a curb. A new one was sent all the way from the Quaker City and the car joined the contestants at Catskill on Sunday morning, and ran on schedule to the finish.

Fuel Is Always Necessary

The big six-cylinder Stevens-Duryea ran out of gasoline just as it was about to cross the line at Catskill, and after it stood at the checking station for twenty minutes with its motor running. It took some time to procure gasoline and 14 points were thereby rung up on the finish judge's register. A. H. Whiting's Stoddard-Dayton broke a gasoline feed pipe, and after fixing this and securing a fresh supply of the valuable liquid, the car was so late that its entrant decided to withdraw and run as a non-contestant on the last day. The Stoddard-Dayton entered and driven by R. T. Newton had to break a seal for a carbureter adjustment, at a cost

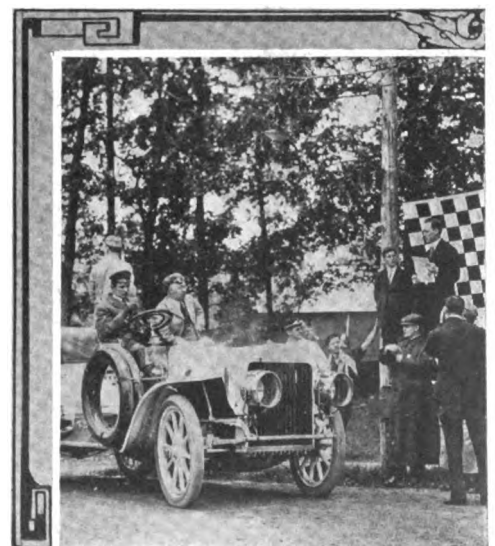

of 6 points, and O. R. DeLamater on the second and third days stopped to renew his supply of gasoline and water outside of the controls. His penalty on the second day was 23 points, and on the last was 20 points, a total of 43. The rules allowed renewal of fuel only at checking stations.

As was forecasted by those who had been over the route, the tourists were greatly pleased and impressed by the wonderful scenery. The party formed at Columbus Circle on Saturday morning under a blue sky and a bright sun predicting fine weather, and with police escort, proceeded down Broadway to Forty-second street, thence to the Weehawken ferry. On the heights above the Hudson the cars drew up in line, and a few minutes after 9 o'clock the Stevens-Duryea, driven alternately by Frank Eveland, of New York, and his son, F. W. Eveland, of Philadelphia, was sent away, acting as a contesting pacemaker. The Columbia touring car, which carried checkers, was also a contestant, and as a rule checked out of the controls some time earlier than the body of the tour, and finished in the same relation.

Hardly more than a few miles out of Weehawken the beautiful views came into evidence. Suffern was the first checking sta-

son, and with the afternoon sun shining upon the eastern shores there were many places where the beauties of nature and of the mansions across the river caused the drivers to run very slowly. From Kingston the cars ran through Esopus, wound for seven miles to go one mile into Kingston, and stopped for the night at the Grant House on the outskirts of Catskill. The run of the day had been 125.2 miles in length, and the running time was seven and a quarter hours.

An innovation in a tour of the kind was introduced by giving over Sunday morning to the tourists, for runs back into the mountains or for a quiet rest. Each day as soon as the cars were checked into the night control and a count of the seals upon the bonnets was made, the drivers were free to use them as they liked. At Catskill several of the cars made short runs, and one fishing party was organized by Senator W. J. Morgan. The party was a success, although the fish were not. After dinner the comparatively short run to the Berkshires was commenced. The distance was 74.4 miles to the Hotel Wendell at Pittsfield, and the time schedule was four and three-quarter hours, with one intermediate stop at Albany. The first had



Peekskill Was a Typical Stopping Place on the Tour

tion, 28.3 miles from the start, with a schedule of 1 hour 50 minutes, and the roads as fine as the best in the world. Hard and smooth highways, in many places oiled, were conducive to enhancing the pleasure of the run through the Ramapo hills, considered by some as more beautiful than the Berkshires. A second control furnished equally grand roads and views to Highland Mills, and then a detour was made to the Lake View Hotel for lunch. There occurred something here which reminded those of the tourists who have been in Gliddens and other long trips of the rush when a route has to be altered. R. H. Johnston had laid out the directions, but since his trip part of the State road into the hotel had been torn up, and three-eighths of a mile in the route book lengthened into three miles of roads that turned and twisted every hundred yards. Consequently, many drivers discovered that they had but a few minutes, and the way they came rushing into the control was far different from the quiet pace held throughout the remainder of the trip. None was late, for a wonder, but it was a close shave for many.

After a stop of an hour and a quarter the party proceeded toward the next checking station, at Highland, regretting that they did not have more of the beauties of the country around Suffern, Tuxedo Park and Arden, but looking forward to the Catskills. Newburgh was on the route, but no stop was made, although the reception accorded the travelers was as hearty there as at all places. From that city the road lay along the bank of the Hud-

roads of the trip were found between Athens and Ravena, 17 miles, and they were very rough, but only caused the contestants to go slowly. Soon after leaving the State capital the Berkshire hills came into view and the splendid roads wound up and down through the verdure-clad valleys right to the city. A light rain commenced before reaching Albany so that at that city tops were raised and rain garments donned. It was well that the opportunity was taken there, for the farther the cars went the harder the rain seemed to come down, and by the time Pittsfield was sighted it was very heavy. A number of the contestants had taken their wives upon the run, and a dinner party was formed on Sunday evening in the Wendell.

Monday's route was the longest, 151.6 miles, and the interest was just as great as on the previous days, for the route led through places which are known all over the country for their beauty: Lenox, Stockbridge, Great Barrington, Sharon and the Hudson river shores from Poughkeepsie to Yonkers. The rain clouds had cleared away and the day was the clearest of the trio, a fact that was greatly appreciated in going through the hills of western Massachusetts and Connecticut. As was expressed, the country appeared in the morning as if it had been carefully combed and groomed, the flowers were in full bloom, and the dampness of the previous day had given full grandeur to the entire scene. A run of 46.6 miles to Sharon was the first of the programme, and so well did the tourists like



Committee Which Successfully Carried Out the Run



Fair Ones Who Gave Committee Needed Assistance

the views on the route that they took it very slowly, the highways being wonderfully smooth and hard, only a few stretches around road-building operations giving slight roughness. From the quaint town of Sharon, with its clock tower, wide and shady lawns and hospitable inn, to Poughkeepsie, was a little over 30 miles, and in the city on the Hudson a stop was taken for lunch. At Cold Spring the first views of the river were seen, and the roads from Poughkeepsie to Peekskill were none too good, in fact the poorest of the trip; but the views around the Storm King mountains were worth the roughness. The drivers, however, had to do some fast running at the finish of the control, for many of them had taken matters too leisurely at the beginning, not expecting to be held down near the finish, and the result was that when the worst of the roads were met with the time did not allow of taking them slowly. All reported on schedule time.

From Peekskill to Yonkers was a quiet parade along the banks of the river, with wide views often seen from the heights, while underneath the roads were as fine as could be desired. From Yonkers into this city was of necessity an easy run, and all were so far ahead of time that no speeding was apparent, and the bicycle police rode alongside asking their acquaintances in the trade as to the pleasures of the route. As the contestants arrived at the Automobile Club of America they were immediately checked out, their seals examined and the cars and drivers released without waiting for the time schedule.

This circuit has been known to many autoists, but perhaps to not as many as might conveniently make the trip, and it is due to become equally as popular as the more generally used tours into New England. The fact that there were nine women passengers shows that it is easy, and they all expressed themselves as greatly pleased, and not at all tired. They were: Mrs. Harry Fosdick, Mrs. R. T. Newton, Mrs. A. J. Interreiden, Mrs. W. C.

Poertner, Mrs. C. H. Larson, Mrs. W. R. Lee, Mrs. W. A. Krohn, Mrs. Marcus Allen, Mrs. L. C. Van Bever.

The cars themselves made the run in splendid order; there was very little tire trouble, perhaps not more than three or four changes; almost no stops for adjustments as the score shows; few cases of overheating, and the fact that eighteen cars, including Harry Fosdick's free-lance Lancia, can go through a 351-mile run without stopping, and the motors had to be kept running at all times except at the noon control, speaks well for the reliability of them. The little Thomas taxicab kept plugging along consistently and steadily, a remarkable performance for such a small car with a large body, and the crowd was frequently interested in seeing how much charges were rung up on its taximeter. Jones Speedometer and Warner Autometer Companies had sent out cars ahead of the tourists, and they marked the route with arrows, and on several detours the Warner signs were used instead of the route book. The big Oldsmobile with its 42-inch wheels, the same car which has taken part in many other contests around Philadelphia and won the run of the Norristown club, was driven by Fred Folberth of the Olds factory, and attracted considerable attention. Hal K. Sheridan had a White close-coupled tourabout, and as is the practice of the White drivers in contests, kept well to the rear, out of the dust, and drove to see the country rather than to have long waits in hot controls. The White showed its speed, however, when it was necessary to go three miles in 10 minutes over crooked roads into the Lake View hotel on Saturday. Two Franklin cars, a four and a six, represented the air-coolers, and as usual had no trouble from that or any other score, both carrying heavy loads. The big Stevens-Duryea took the palm, however, for the number of passengers, as it had its seven seats occupied at all times. The National car was a low, rakish, yellow roadster and it

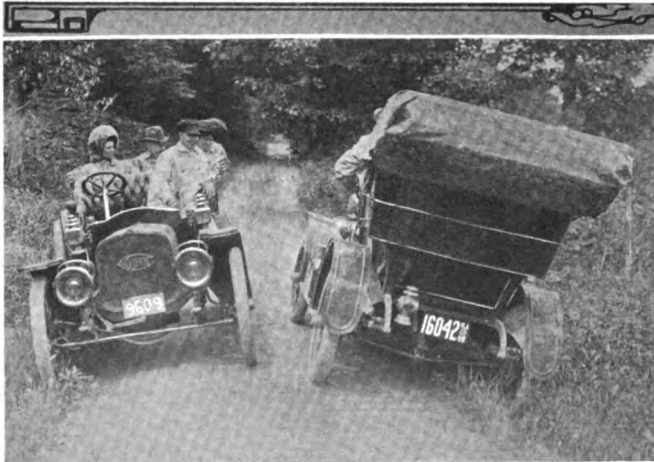

Where the Road Was Picturesquely Narrow



Right In the Heart of the Catskill Country

SUMMARY OF THE NEW YORK AUTOMOBILE TRADE ASSOCIATION TOUR

CLASS F—CARS SELLING FOR \$4,001 AND OVER										
No.	Car	H.P.	Cyl.	Bore	Stroke	Entrant	Driver	Penalties Time Road	Total	Tires
21	Oldsmobile	60	6	4 3/4	4 3/4	Oldsmobile Co. of New York	F. G. Folberth	0 0	Perfect	Goodrich
CLASS E—CARS SELLING FOR \$3,001 TO \$4,000										
14	White	40	The White Co.	H. K. Sheridan	0 0	Perfect	Diamond
15	Franklin	42	6	4 1/2	4	Franklin Auto Co.	Chas. Fox	0 0	Perfect	Goodrich
18	Stevens-Duryea	40	6	4 3/4	4 1/2	Frank Eveland	Frank Eveland	14 0	14	Diamond
CLASS D—CARS SELLING FOR \$2,001 TO \$3,000										
3	National	35	4	4 3/4	4 3/4	Poertner Motor Car Co.	W. C. Poertner	0 0	Perfect	Diamond
7	Columbia	29	4	4 1/2	4 1/2	Victor Auto Storage Co.	J. R. Kirkpatrick	0 0	Perfect	Empire
9	Franklin	28	4	4 1/2	4	Franklin Auto Co.	J. L. Burns	0 0	Perfect	Goodrich
10	Knox	38	4	4 3/4	4 3/4	Fisk Rubber Co. of New York	J. R. Ripley	0 0	Perfect	Fisk
2	Stoddard-Dayton	40-45	4	4 3/4	5	Atlantic Motor Car Co.	R. T. Newton	0 6	6	Firestone
1	Mitchell	40	4	4 3/4	5	Mitchell Motor Co.	O. R. DeLamater	0 43	43	Hartford
8	Stoddard-Dayton	40-45	4	4 3/4	5	Atlantic Motor Car Co.	A. H. Whiting	Withdrew	Withdrew	Firestone
CLASS C—CARS SELLING FOR \$1,251 TO \$2,000										
5	Mitchell	30	4	4 1/2	4 1/2	Mitchell Motor Co.	D. M. Hasbrouck	0 0	Perfect	Goodyear
6	Mitchell	30	4	4 1/2	4 1/2	Mitchell Motor Co.	M. E. Parrott	0 0	Perfect	Hartford
11	Mitchell	30	4	4 1/2	4 1/2	Mitchell Motor Co.	W. D. Brown	0 0	Perfect	Hartford
12	Interstate	35	4	4 1/2	5	Doolittle Rim Co.	H. H. Knepper	0 0	Perfect	Diamond
22	Standard	30	4	4 1/2	4 1/2	Standard Roller Bearing Co.	C. R. Short	Withdrew	Withdrew	Diamond
CLASS G—TAXICABS CARRYING TWO PASSENGERS AND DRIVER										
20	Thomas	18	4	3 3/8	4 1/8	Parkway Garage Co.	Oscar Hausen	0 0	Perfect	Empire

created a favorable comment all along, not only because of its lines and novel color scheme, but also because of its steady running and quiet motor. The Mitchell was best represented in number, for there were four of this make and the three of 30-horsepower size all made perfect scores. The two Stoddard-Dayton suffered rather severely for the nature of their troubles, and, aside from the momentary adjustments necessary, ran

splendidly. At one time the crowd around the checking station through that Mr. Newton had stopped his motor, when in reality it was only throttled down and running very quietly. A rock struck the gasoline feed pipe on Mr. Whiting's car, causing it to break. The Knox car entered by the New York Fisk branch was one of the perfect score contenders, as was also the Interstate driven by Harry Knepper.

FIVE BATTLING IN QUAKER ENDURANCE RUN

WILLIAMSPORT, PA., June 14—With a beggarly array of five starters, the Quaker City Motor Club this morning launched its five-day endurance run to Pittsburg and return. Various reasons have been given for the paucity of entries—lack of cars, preparations for 1910, etc.—but the fact remains that this territory has had a surfeit of endurance and reliability runs for this season, and the Quakers made the mistake of scheduling their run too late in the season; or, failing to secure an earlier date, of not calling the run off altogether. It is going to cost them something like \$1,200 to see the affair through, and, like true sports, they are going to do it.

To-day's story is soon told. Shuttleworth, with a 40-horsepower Haynes, the only class C entry, snapped a front axle at Lavelle, 75 miles short of the overnight stop, and under ordinary conditions would have retired. But Shuttleworth is after the cup, and wired to New York for a new axle.

The Palmer & Singer covered the last 25 miles of to-day's run with two broken front springs, but by means of a first-aid repair got into the control on time.

The Franklin and the Elmore—the latter driven by Frank Hardart, Jr., the only amateur driver in the run—finished clean for the day in their class, as did Walter Cram's Mitchell 20 in class D. The going was horrible through the mountains, as a result of the incessant rains of last week, and the reduction of the running time to 18 miles an hour was much appreciated by the drivers. Seventy-five of the 191.2 miles of to-day's run was over and through the successive ranges of the Blue mountains which form the backbone of the Keystone State between the Delaware and the Susquehanna.

Pilot "Doc" Overpeck, who is acting as referee in the absence of Chairman Ross of the contest committee (who was called out of town), was compelled to transfer his flag to the Palmer & Singer, a troublesome clutch delaying the official Chalmers-Detroit, and it was overtaken by the former at Sunbury.

JOHNSTOWN, PA., June 15—The 18-mile-an-hour schedule obtained again to-day, and with the large proportion of low-gear

work due to the mountains and the heavy going in many places the reduction came in quite handy. Although four of the five cars finished clean, none of them had much time to spare.

The surprise of the day was the appearance in Williamsport at 6 a. m. of the Haynes, which suffered a broken axle 75 miles shy of that place. Driver Shuttleworth and his assistant, with the aid of a fence rail and a little ingenuity, managed to get their car to Ashland, where a new axle, wired for to New York, reached them at 11 o'clock at night. They were back on the course again at 1 o'clock this morning, and reached Williamsport in time to get a bite of breakfast before checking out.

There were some delay in the arrival of new springs for the Palmer & Singer, which limped into Williamsport yesterday with both front springs gone, and the car did not check out from that place till 8.45 this morning. By taking all sorts of chances and pushing through with but one three-minute stop for fuel, the car arrived here 6 minutes ahead of its schedule, and the performance is the talk of all Johnstown, where the character of the going along the route is well known.

The only car to suffer a penalty to-day was the Haynes. Yesterday's experience made Driver Shuttleworth a trifle too careful, and he failed to allow sufficient time for the mountain work between Altoona and this place; he checked in 15 minutes late. He is determined to land the class C cup, and as the Haynes is the only car in that class, he says he will not mind the addition of a few extra points to the large total accumulated yesterday.

Following is a list of the participants:

CLASS A										
No.	Car	H.P.	Cyl.	Driver	Penalties Time Work Total					
5	Elmore	35	4	Hardart, Jr.	0 0 0					
13	Franklin	42	6	Carris	0 0 0					
1	Palmer & Singer	60	6	Wallace, Jr.	0 Incom. Incom.					
CLASS C										
4	Haynes	40		Shuttleworth	Broken front axle Incom.					
CLASS D										
6	Mitchell	20	4	Cram	0 0 0					



NEW YORK, June 14—Twenty-five automobiles—all of them of one make, Maxwells—started from this city this morning on an eight-day tour, the first of such length and with but one kind of auto ever arranged. It is the annual tour of the Maxwell-Briscoe Motor Club and it includes on its route some of the most picturesque scenery in five States, New York, Connecticut, Massachusetts, New Jersey, and Pennsylvania. The party left the city in time to visit the Maxwell factory at Tarrytown and lunch was served there by the factory officials. Nearly all of the cars are privately owned ones and only the official machines are supplied by the makers. From Tarrytown the course leads to Waterbury, Conn., where the first night stop will be made. To-morrow there will be a leisurely tour through the Berkshires, stopping at Stockbridge. The third stage will carry the Maxwellites over into Pennsylvania, via Port Jervis, thence to the Delaware Water Gap, Philadelphia, Atlantic City, and back to New York. Next Sunday will be spent at Atlantic City, returning via Lakewood. A handsome trophy has been offered and it is for this that there will be competition.

WOMEN'S TOUR FROM COAST TO COAST

Transcontinental automobile touring is receiving another good impetus through the trip of Mrs. Alice R. Ramsey and three other women, who are en route in a Maxwell touring car. Fully equipped for a long journey, with camping outfit, shovels, and even firearms, the notable quartette left New York on the morning of June 9, during a drizzling rain, which neither dampened their spirits nor the intention of trying to reach Albany on that day. With Mrs. Ramsey, who is president of the Women's Motoring Club, of New York, are Miss H. Jahns, Mrs. W. Atwood, and Mrs. N. R. Powell, all of Hackensack, N. J., and it is their intention to do all of their own work on the way, thus being the first women to make the trip from ocean to ocean unassisted by mere man. Mrs. Ramsey intends to do the driving, although her companions are capable of taking the wheel if necessary. The route selected is that most generally used between the coasts: Albany, Buffalo, Cleveland, Chicago, Omaha, Cheyenne, Ogden and Reno. No speed will be attempted, but the party expressed the hope of reaching the Pacific Coast by the middle of July, and perhaps a few days earlier.

Plans have been made to stop in cities and towns at night, but if that is not possible at any point, the camping outfit will be called into use, including its cooking utensils, for a supply of food and water will be carried while crossing the plains. The firearms, Mrs. Ramsey explained, "are to scare away any over-curious wild animals," and the shovels and axes for emergency use. After reaching San Francisco the women expect to tour in the southern part of the State.

SHAWMUT LEADS IN OCEAN-TO-OCEAN RACE

RAWLINS, WYO., June 15—In the heart of the Rocky mountains the automobiles participating in the endurance contest from New York to Seattle are experiencing great difficulties. The roads have been very bad ever since the cars entered Kansas and the fortunes of the race have caused each car at times to be the leader, and at times the last. The Shawmut is leading at present, having left this place at noon, and the two Fords left together at 4.45 p. m. The Acme has not as yet reached Cheyenne. On last Thursday the contestants were at Ellis, Kan., where the Acme led, with the two Fords together, and then the Shawmut, all close together, but the Shawmut took second place by leaving ahead of the small cars. At Limon, Col., on Saturday the Shawmut was leading, with Ford No. 2, and Ford No. 1, in the order named. The Acme had to stop at Oakley, Kan., but followed the others after several hours delay. Cheyenne on Sunday reported that the Ford No. 2 was the first to arrive, followed in a few minutes by the Shawmut, with the Ford No. 1 in Denver, and on the same day the Itala was struck by a freight train on a bridge at Marshall, Mo., but was not badly damaged.

Yesterday the Shawmut took the lead by reaching Laramie first, and the two Fords joined forces at Cheyenne and proceeded. The Acme reached Denver. Last night the Shawmut was held up at the Union Pacific bridge over the Platte river at Fort Steele because it did not have a permit to cross, and it had to spend the night there. The Ford drivers, however, had secured the passes in Cheyenne and No. 2 crossed, thus taking the lead and stopping here for the night. No. 1 reached here at 10 o'clock this morning, just as the Shawmut received permission to cross the bridge. The Ford No. 2 started from Rawlins early to-day, but something broke about six miles out and it was brought back. When the Ford No. 1 arrived it had a badly crippled wheel, having broken it on the bridge. The Shawmut thus caught up and passed, and was reported at Wamsutter, 40 miles west, just as the Fords left here. The last reported of the Acme was that it was in a mud hole south of Cheyenne.

MERIDEN WILL HAVE A HILL CLIMB

MERIDEN, CONN., June 14—A hill climbing contest which will be open for amateurs only will be held by the Meriden Automobile Association on June 26. Considerable rivalry has arisen as to the abilities of the cars owned by some of the members and the entry list has been filling rapidly. The machines will be classed by piston displacement instead of price, and there will be seven events, as follows: Displacement of 160 cubic inches or under; 161 to 230 cubic inches; 231 to 300; 301 to 450; free-for-all; single-cylinder motorcycles; and two-cylinder motorcycles. Mayor Reilly and other city officials will preside.



Thousands came early and climbed

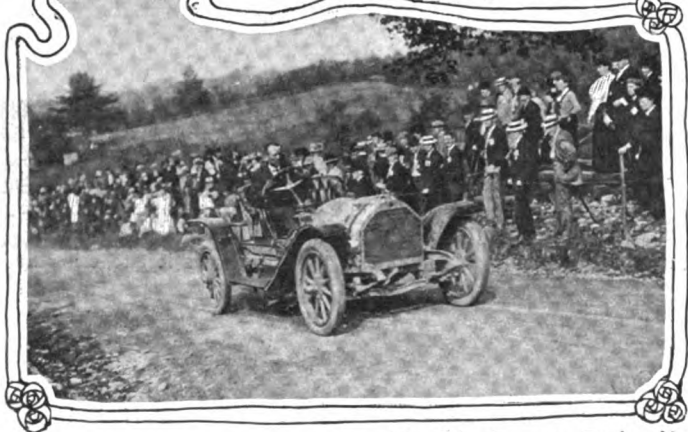

Cameron, twice winner with Chalmers-Detroit.

WORCESTER, MASS., June 12—"Dead Horse" Hill is the name of an incline that is known throughout the country because of its unusual cognomen. Many a horse was "dead" by the time he reached its highest part, though there are other grades in the "Old Bay" State which call for more endurance and persistence. "Dead Horse" has had its surface improved in recent years, along with many other miles of good highway in Massachusetts, and consequently its climbing no longer presents any terrors even for the harnessed animal.

Steam had its innings to-day, for the craft piloted by L. F. N. Baldwin made the ascent in 54 seconds flat, which was an im-

CLIMBING A HILL CALLED "DEAD HORSE"

provement of 13-5 seconds over his time of a year ago. Again, in the "record-of-the-hill" event, the steamer scored in .553-5, and Baldwin might have done even better had he so desired.

Baldwin to-night made the public statement that he would never drive again, due to the wishes of his wife, who has convinced him that the risk is too great for the honors to be gained.

The best time made by a gasoline car was in the "record-of-the-hill" event, when H. F. Grant, in the Alco, formerly the Berliet, made the ascent in 1.034-5.

The Benz car, with David Bruce Brown driving, came to grief the night before the climb in trying out the hill. Brown was making the hill at a 50-second clip when he met a lightweight Stanley coming in the opposite direction.

This morning William Bourke, in his racing Knox, went into the gutter on the same section of the hill where Brown and the Benz went to the bad, and the Knox was smashed beyond repair and Bourke had to be taken to a physician.

It is to the credit of the Worcester Automobile Club, particularly of John P. Coughlin, its president, that the climb was run off in less than two hours. The time of running the events was 1 hour and 47 minutes, and this was due to Fred J. Wagner, the starter, who insisted that a car be off every two minutes.

Prominent autoists from all over New England were present, the honorary referee being President L. R. Speare, of the American Automobile Association. The acting referee was Samuel B. Stevens, who was recently appointed a member of the A. A. board.

A contingent from Lowell included Mayor Brown, Secretary McKenna of the board of trade, Senator Hibbard, and Thomas Lee, all being guests of President J. O. Heinze, of the Lowell Automobile Club. The following is the summary:

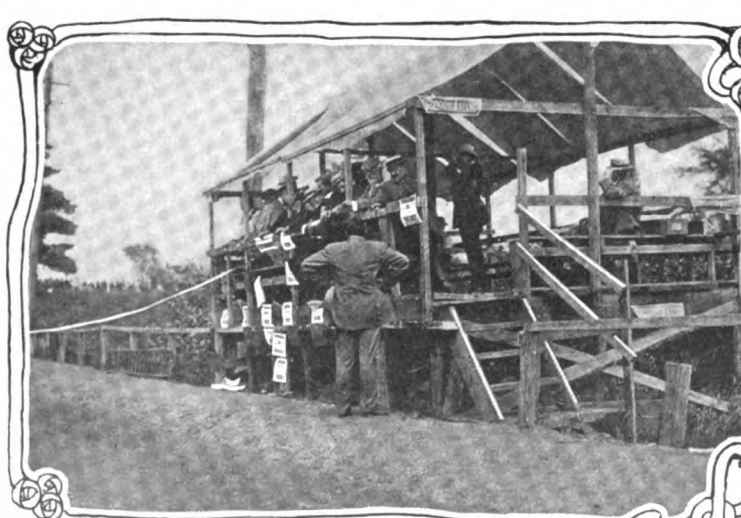

Where the Timers were "Cooped"



Burnham scored with Simplex.

LOCATED IN THE "OLD BAY STATE"



And the "Cops" marched up hill.

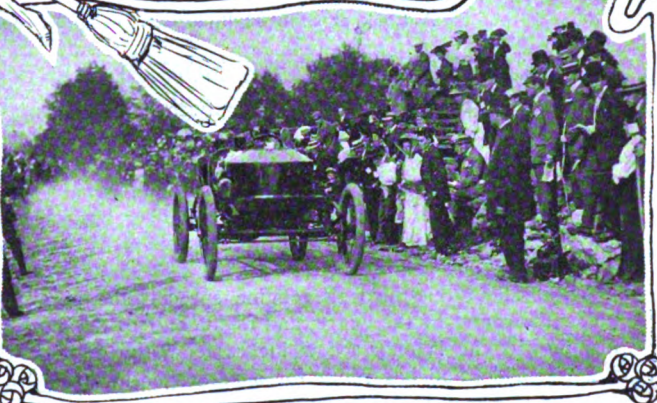

Baldwin who "steamed" to victory.

FREE-FOR-ALL, GASOLINE CARS WITH DISPLACEMENT OF 451 TO 600 CUBIC INCHES

Pos.	Car	H.P.	Driver	Time
1	Alco	54.1	Harry F. Grant	1:03 4-5
2	Allen Kingston	48.4	H. Hughes	1:07 4-5
3	Allen Kingston	48	C. A. Glenworth	1:14

FREE-FOR-ALL, GASOLINE CARS WITH PISTON DISPLACEMENT NOT TO EXCEED 350 CUBIC INCHES

1	Columbia	32.4	J. J. Coffery	1:08 4-5
2	Buick	32.4	J. B. Ryall	1:22 1-5

FREE-FOR-ALL, CARS OF ALL TYPES AND MOTIVE POWERS

1	Stanley		L. F. N. Baldwin	0:54
2	Alco	54.1	Harry F. Grant	1:06
3	Chalmers-Detroit	40	L. B. Lorimer	1:11

AMATEUR, CARS OF ALL TYPES AND MOTIVE POWER

1	Buick	32.4	J. B. Ryall	1:25 4-5
2	Chalmers-Detroit	40	C. S. Hall	1:44

GASOLINE CARS WITH PISTON DISPLACEMENT OF 451 TO 600 CUBIC INCHES; MINIMUM WEIGHT, 2,400 POUNDS

1	Allen Kingston	48.4	Hugh Hughes	1:09 2-5
2	Allen Kingston	48	C. A. Glenworth	1:16

GASOLINE CARS WITH PISTON DISPLACEMENT OF 301 TO 450 CUBIC INCHES; MINIMUM WEIGHT, 2,100 POUNDS

1	Chalmers-Detroit	40	L. F. Cameron	1:19
2	Chalmers-Detroit	40	L. B. Lorimer	1:20
3	Buick	32.4	J. B. Ryall	1:22 2-5

GASOLINE CARS WITH PISTON DISPLACEMENT OF 160 CUBIC INCHES AND UNDER; MINIMUM WEIGHT, 1,200 POUNDS

1	Buick	19.64	J. B. Ryall	2:05 1-5
---	-------	-------	-------------	----------

GASOLINE STOCK CARS SELLING FOR \$4,001 AND OVER

1	Simplex	60	F. K. Burnham	1:08 1-5
---	---------	----	---------------	----------

GASOLINE STOCK CARS SELLING FROM \$3,001 TO \$4,000

1	Allen Kingston	48.4	H. Hughes	1:10
2	Allen Kingston	48	C. A. Glenworth	1:16 2-5

GASOLINE STOCK CARS SELLING FROM \$2,001 TO \$3,000

1	Chalmers-Detroit	40	F. F. Cameron	1:14 4-5
2	Atlas	43.5	Elmore Knox	1:23 4-5
3	Chalmers-Detroit	40	L. B. Lorimer	1:26

GASOLINE STOCK CARS SELLING FROM \$1,251 TO \$2,000

1	Buick	32.4	J. B. Ryall	1:23 4-5
2	Jackson	36.1	H. M. Bates	1:27 2-3
3	Cameron	36.3	A. Cameron	1:36 3-5

GASOLINE STOCK CARS SELLING FROM \$851 TO \$1,250

1	Buick	22.5	C. M. Stanley	1:49
2	Buick	22.5	J. B. Ryall	1:54 1-5
3	Cameron	24.2	A. Cameron	2:06 2-5

WORCESTER COUNTY CHAMPIONSHIP

1	Stanley		J. C. Clark, Jr.	1:13 4-5
2	Chalmers-Detroit		J. F. Harrington	1:18

RECORD TRIALS OPEN TO ALL CARS

1	Stanley		L. F. N. Baldwin	0:55 1-5
2	Alco		Harry F. Grant	1:01 3-5
3	Chalmers-Detroit		L. B. Lorimer	1:12



President Coughlin more than busy.



Atlas which took a first.



A Look at Eight-Cylinder Engine and Propeller on Bleriot's Twelfth Monoplane, Just Produced

BLERIOT'S TWELFTH MONOPLANE

PARIS, June 10—Louis Bleriot, the French monoplane enthusiast, has just produced his No. 12, an improved type of monoplane flying machine driven by a 50-horsepower, eight-cylinder E. N. V. engine, the features of which were set forth in a recent number of this paper. The new flyer has its engine full forward and attached to the lower members of the frame, the drive being by chain to a two-bladed wooden propeller revolving at about one-third the engine speed. The pilot's seat is under the center of the wings, and to the rear of the engine, in which position he is only a few inches from the ground when a start is made, and has room for a passenger by his side. A pleasing feature of the aeroplane is the very neat arrangement of plain radiating tubes in the framework of the machine connecting the wings to the tail. In this position the tubes offer no resistance whatever to the advance of the aeroplane and yet profit by the current of air set up when flying. The tail of the aeroplane has been considerably improved on the previous models in order to give increased stability. It is composed of three vertical rudders, operating together and allowing of lateral movement, and a couple of horizontal pivoting planes regulating the height of the machine in the air.

The first important journey of the new aeroplane was intended to be a repetition of Bleriot's first cross-country trip from Toury to Artenay, undertaken last October. This could not be covered in its entirety, for after traveling nine miles across country the gasoline supply became exhausted and it was necessary to seek external aid for the return portion of the trip. The attempted round trip was made on the occasion of the inauguration of the monument in honor of last year's exploit.

FRANCE HAS BUILT RUSSIA'S AIR CRAFT

PARIS, June 10—France is about to deliver to Russia her first aerial cruiser, the *Russie*, constructed in the Lebaudy shops at Moisson, near Paris, on practically the same lines as the successful *Republique* for the French army. Trial trips have taken place this week around Paris in the presence of a group of Russian officers sent here to inspect the airship. The overall length of the *Russie* is 170 feet, and her cubic capacity 12,000 feet. Her envelope is made of rubbered cloth supplied by the Continental Company. Her power plant consists of one four-cylinder Panhard-Levassor engine of 80 horsepower, driving two pairs of propellers, and capable of giving to the aerial vessel a speed of 40 miles an hour in still air. The *Russie* will shortly leave for her home station, and will be housed in a special dismountable shed built for her by the American engineer, Melvin Vaniman.

HERRING GETS EXTENSION OF TIME

WASHINGTON, D. C., June 14—The War Department, it is understood, has not only granted A. M. Herring an extension of the time for the completion of the tests of his aeroplane, but has waived the date of delivery. The only requirement now is that the aeronaut complete his trials by July 1.

CURTISS AEROPLANE AT MORRIS PARK

NEW YORK, June 14—Interest in aeronautical circles is centered in the assembling and testing of the new Curtiss light biplane which has arrived at the Morris Park grounds. The entire machine weighs but 550 pounds with the operator, and will be tried before the public exhibition on June 19 or 26.

St. Louis Will Get a Wright Flyer—A special committee has been appointed by the Aero Club of St. Louis to confer with the Wright Brothers relative to giving an exhibition in connection with aerial events scheduled for October. If neither of the brothers can attend the club will purchase a machine and have it operated by one of the Wright students.

Boston "Tech." Will Give Aeronautic Course—Prof. R. C. MacLaurin, the new president of the Massachusetts Institute of Technology, is planning a course in aeronautics for the opening of the institute next year. It will include practical work in designing, building, and operating various types of machines.

From Brownsville, Texas, comes a story of the successful trial trip of the first aeroplane constructed in the Lone Star State: "Prentice A. Newman, in an aeroplane designed along new lines, made a successful flight of about half a mile, towed by a 45-horsepower Pierce-Arrow automobile. The aeroplane had not been equipped with its own propelling mechanism but its inventor desired a trial, and a three-quarter-inch rope, about 182 feet long, was attached. The day was clear with a head wind of from 12 to 15 miles an hour velocity. At eight miles an hour the aeroplane cleared the ground; at 10 to 12 it rose fairly in the air, carrying the inventor, of course, and at this low rate the towing became very easy; at a speed of 25 miles an hour the towing line was at an angle of approximately 45 degrees, giving the machine an altitude of from 90 to 130. The aeroplane then balanced perfectly in all positions of the wind, and when the car slowed up the aeroplane coasted on its own momentum for two or three hundred feet. Mr. Newman then swung it to one side by the steering gear, to avoid some trees, and it landed easily."

CLEVELAND CLUB'S CLIMB UP PORTER HILL

CLEVELAND, June 14—Unfortunate is the proper word to apply to the Cleveland Automobile Club's choice of a day on which to hold the annual hill-climbing contest. As first scheduled, the races were to come off on June 5, but the weather man being contrary at that time, the first postponement to June 9 was made. On that day things did not look much brighter, but several days of continuous downpour had so scared the committee that they decided to hold it anyhow. The rains had put the scene of the day's activities in the worst possible condition, so that it was necessary to put scrapers on the job for more than a few hours before the surface of Porter Hill was fit to use.

Owing to the postponements and the bad day the entrants were reduced in numbers, so that it was necessary to eliminate several of the carded events. Those remaining were well contested, and the enthusiasts from the city, as well as the farmers from nearby, enjoyed a good day's sport.

Next to Knox, which cleaned up no less than four events and made the fastest time of the day, Mrs. Otis and the little Hupmobile shared the honors. The former sent her big Stearns roadster up the half mile grade from a standing start in the fast time of 51.2 seconds. This was not a contest, but an exhibition, and the time made was the fifth best of the day.

The Hupmobile created a sensation by winning two events, the only ones in which it was entered. The striking feature of the car was its size, being so small as to be dubbed "The baby of the meet." The original program made no provision for the motorcyclists, but on the spur of the moment a contest for them was organized and run off. This was very successful and the time made by the winner, A. W. Strople, on an Indian, was beaten only by the flying Knox. Strople made the steep ascent in 42.5 seconds.

All of the contestants seemed to be familiar with the hill, showing that much preliminary work had been done in anticipation. The officials ran the events off in good shape, notwithstanding the weather conditions. The final event, number eleven, was a piston displacement handicap, in which, some insist, the final results still seem to be in doubt.

The White gasoline car, winner in the \$2,000 to \$3,000 touring class, was the product of the newly formed White Motor Car Company, and is not to be confounded with the newer venture of The White Company, the well-known builders of steam-driven automobiles, which has recently added a small gasoline model to its line. The results follow:

GASOLINE STOCK CARS, \$2,001 TO \$3,000, TOURING CARS							
Car	H.P.	Bore	Stroke	Driver	Time		
White (Gasoline).....	45	5	5	Camra	1:11	1-10	
Chalmers	45	4 1-5	5	Davis	1:36	5-10	
GASOLINE STOCK CARS, \$2,001 TO \$3,000, RUNABOUTS							
Knox	40	5	4 3-4	Belcher	:48	9-10	
Pullman	40	5	4 3-4	Hardesty	1:08	7-10	
GASOLINE STOCK TOURING CARS, \$1,251 TO \$2,000							
Oakland	40	4 1-2	5	Dennison	:59		
Pullman	40	5	4 3-4	Hardesty	1:21	1-10	
GASOLINE STOCK RUNABOUTS, \$1,251 TO \$2,000							
Oakland	40	4 1-2	5	Bauer	:55	8-10	
Oakland	40	4 1-2	5	Dennison	:59	2-10	
Jackson	40	4 3-4	4 3-4	Paxon	1:33	7-10	
STOCK RUNABOUTS, \$851 TO \$1,250							
Regal	30	4	4	Schmidt	1:19	6-10	
STOCK CARS, \$851 TO \$1,250							
Hupmobile	20	3 1-4	3 3-8	Rauch	2:16	6-10	
SIX-CYLINDER STOCK CARS							
Mora	30	4	5 1-8	Adams	1:15	3-10	
STOCK CARS WEIGHING 2,204 POUNDS OR LESS							
Knox	40	5	4 3-4	Belcher	:50	3-10	
STOCK CARS WEIGHING 881 TO 1,432 POUNDS							
Hupmobile	20	3 1-4	3 3-8	Rauch	1:51		
OPEN TO ALL MAKES OF MOTOR VEHICLES							
Knox	60	5 1-2	5 1-2	Dennison	:39	2-10	
Jackson	40	4 3-4	4 3-4	Paxon	:57	7-10	
Mora	30	4	5 1-8	Adams	1:30	5-10	
PISTON DISPLACEMENT HANDICAP							
Knox						89	per cent. efficiency
Jackson						76	" "
Oakland						71	" "
White (Gasoline)						55	" "
Mora						50	" "
Hupmobile						22	" "

LOWELL GETS NATIONAL STOCK CAR RACES

LOWELL, June 14—Detailed arrangements for the national large and small stock car races that are to be held over the Merrimac valley course in this city during Labor Day week, will now be perfected, the final agreement with the Contest Board of the A.A.A. having been concluded last week. It appears that there was a misunderstanding concerning the attitude of the contest board toward the races and the Lowell club.

It had been stated that in addition to the sanction fee the board had demanded an absolute guarantee of a large sum of money, as a condition of the national events being held in Lowell. Concerning this matter President John O. Heinze this week met Chairman Hower and found that the report of the A.A.A.'s attitude was incorrect. What the A.A.A. asked was that it be given a preferred claim on a part of the net profits to cover the expenses to which it will be put on account of the race. Net profits are understood to mean any sum remaining after all the bills, including money advanced by citizens, are paid, and which would go into the treasury of the Lowell club. This arrangement is satisfactory to the club.

It has been decided to recover the same ten-mile circuit that was used last fall, the club officials being confident that all the cars that are entered can be started on this circuit, and that a

much more interesting event will result than if the circuit is extended to fifteen miles or more as is possible. The city of Lowell and the club are prepared to spend about \$12,000 to put the course in shape and with this expenditure the circuit ought to be the best in the country, for about half of it is State highway already in excellent shape. In place of the hairpin turn at the Tyngsboro end of the circuit, a new macadamized road, scientifically banked, will be constructed, so that the cars can whirl around from the boulevard into the back-stretch without skidding and at full speed. All parts of the back stretch and of the lower cross road will be put in first class condition.

The grand stand is to be constructed on the boulevard where the spectators will have a fine view of the racing cars, and it will be built to seat 10,000 people. Its back will be to the Merrimac river and across the river at that point a pontoon bridge with a twelve foot walk will be built. On the opposite side are the tracks of the Boston & Maine railroad and of the trolley line. This plan will make access to the course much easier than was the case last year. The entry blanks will be prepared by the contest board of the A.A.A. and will be issued very soon. Trophies will be offered in both races, but the names of their donors have not yet been announced.

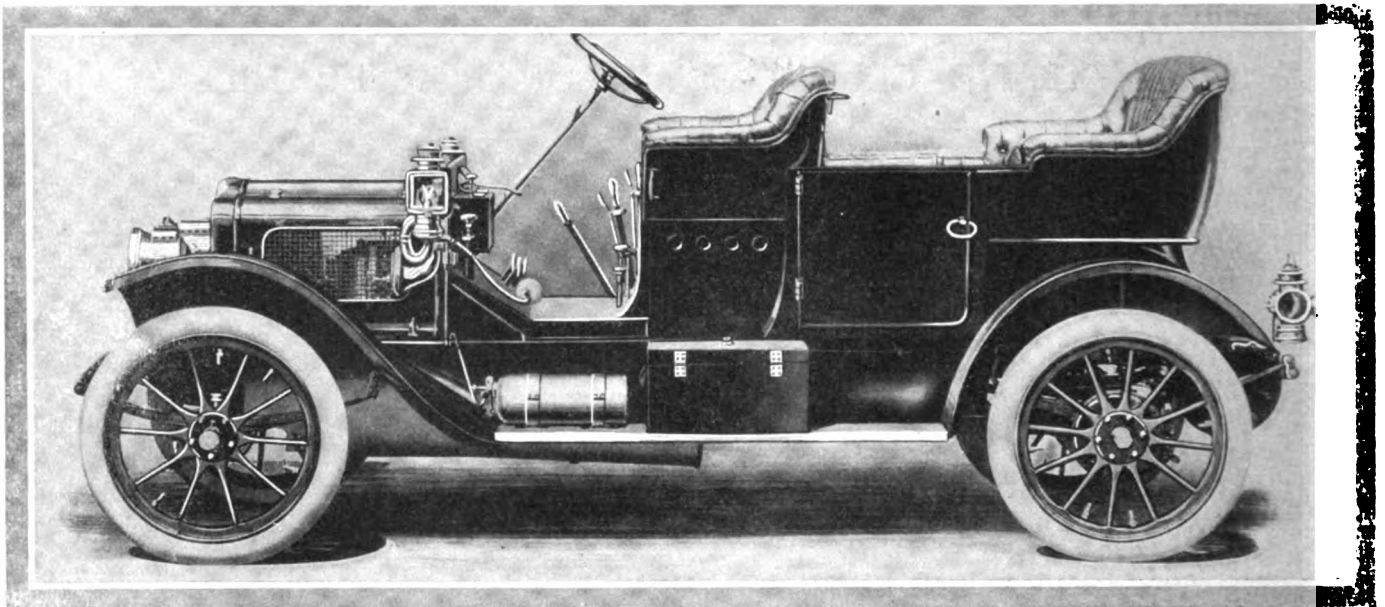

Model "O" Twenty-Horsepower White Steamer Presents Unusually Attractive Lines

WHITE CARS FOR 1910 INCLUDE A GASOLINE

THE 1910 models to be made by the White Company comprise a 20-horsepower steam car selling at \$2,000; a 40-horsepower steam car selling at \$4,000, and a 20-horsepower gasoline car which will be made in two types, differing in details of running gear and body construction, but with identical power plants. These two types will sell at \$2,000 and \$2,500 respectively. All of the above prices are f. o. b. Cleveland and are for cars with touring, toy tonneau or runabout bodies.

The most important new feature in the 1910 White Steamers will be, as already announced, the modifications whereby either kerosene or gasoline may be used as fuel. Plans have been made for building a greater number of steam cars than have been turned out in any previous year, and shipments from the factory will commence before July 1. The design of the gasoline car and the materials used in its construction are in accordance with the most advanced and modern foreign practice.

The 20-Horsepower White Steam Car—Considering, first of all, the 20-horsepower steam car; this will be known as the Model "O-O," and will be the successor of the Model "O" of the present season. The most noticeable change in the external appearance of the new model is a lengthening of the wheelbase to 110 inches. The frame has been lengthened and the power plant moved back so that the front axle is immediately under the condenser. The shape of the mud guards has been somewhat changed, as will be seen in Fig. 1. The engine is compound, vertical, and of the same compact construction as in the 1909 model, with a high-pressure cylinder of $2\frac{1}{2}$ -inch bore, a low-pressure cylinder of $4\frac{1}{4}$ -inch bore and a stroke of 3 inches. The crankshaft is a short, one-piece forging of tool steel with but two main bearings. Both the high-pressure valve and the low-pressure valve are piston valves and are

driven direct from the connecting rods by what is known as the Joy valve mechanism. The two main bearings and the two connecting rod bearings are fitted with ball bearings of unusually large size.

A change has been made in the method of driving the two pumps which supply water to the generator. Instead of being driven from the valve gearing, as in the 1909 engine, they are driven from an eccentric. This eccentric is located outside of the crankcase at the rear of the engine and is forged integrally with that part of the universal joint which is attached to the crankshaft, as clearly shown in the accompanying picture.

As in the 1909 engine, the pump which returns water from the condenser to the tank and the air pump which supplies pressure for the fuel tank and for inflating tires are driven directly from the valve mechanism.

The frame of the Model "O-O" is of pressed steel; the tires, both front and rear, are 32 x 3 1-2; the front axle is of I-beam section and all the bearings in the car are annular ball bearings.

The 40-Horsepower White Steam Car—The 1910 40-horsepower White Steamer will be known as the Model "M-M," to indicate its close relationship to the Model "M" of the past season. The most marked change in the external appearance of the new car is that the steering post is tilted considerably more than in the previous model and the shape of the mudguards has been changed. The wheelbase remains unaltered at 122 inches. The frame is of steel, replacing the armored-wood construction formerly used. The "M-M" engine has all the characteristics of the Model "O-O" engine, described briefly above, including the feature of driving the water pumps by means of an eccentric located outside of the crankcase. The dimensions of the Model "M-M" engine are: High-pressure cylinder, 3-

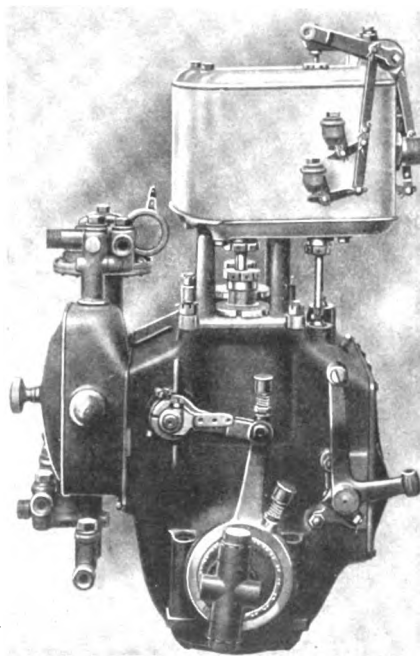

Rear View of 1910 White Engine

Showing the eccentric for driving the water pumps. The 40-horsepower engine and 20-horsepower engine are identical, except as regards dimensions.

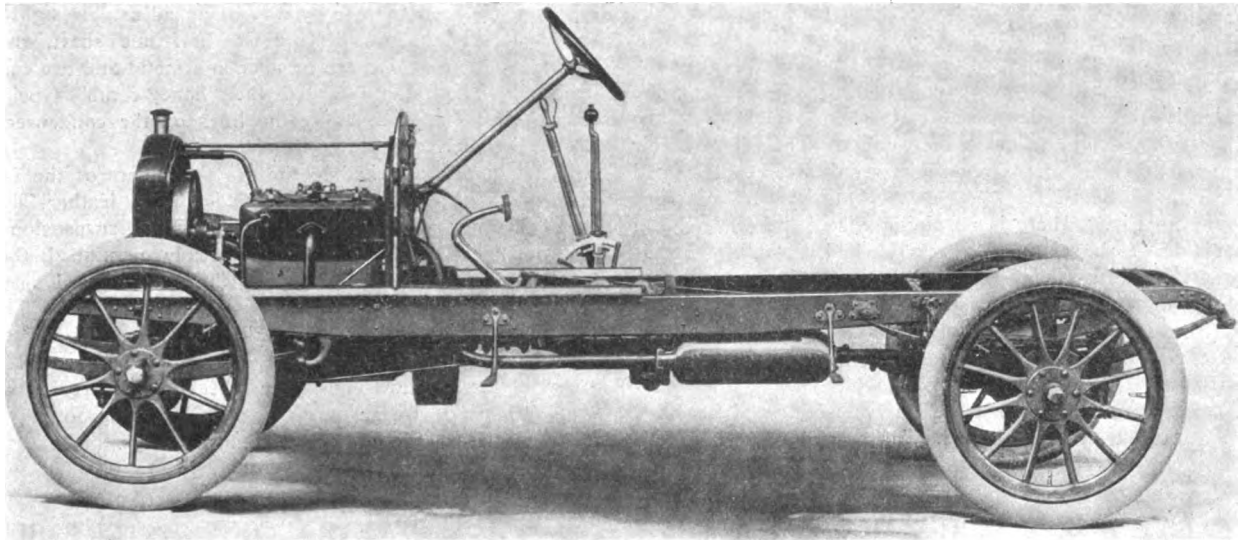

The New White Gasoline Chassis Shows Classy Design and Up-to-Date Constructive Features

inch bore; low-pressure cylinder, 5-inch bore, and stroke, 4 1-2 inches, the same as in previous models.

The Model "M-M" is equipped with 36 x 4 tires on the front wheels and 36 x 5 tires on the rear wheels.

Features of Both Steam Models—In order to use kerosene as fuel no change has been made in the burner proper. The only modifications are in the vaporizer and in the shutter controlling the amount of air admitted to the burner. As in the case of many other great mechanical advances the desired end—in this case to use kerosene as fuel—is obtained by means which are surprisingly simple. As for the degree of success obtained by the designers of the White in adapting the car for the use of kerosene, it is only necessary to say that when the car is in operation it is practically impossible for any one to tell whether kerosene or gasoline is being used as fuel. When starting the car "cold" it takes about five minutes longer to heat the vaporizer sufficiently so that the main fuel supply may be turned on, but thereafter the action and operation of the car are the same as when gasoline is used as fuel. Only a few minutes are required to make the necessary adjustments to the vaporizer and to the shutter so that the fuel may be changed from kerosene to gasoline or vice versa.

The generator in both the Model "M-M" and Model "O-O" is of the usual White construction, consisting simply of nine coils of steel tubing so joined together that in operation water is supplied to the upper coil and steam issues from the lower coil. No change has been made in the regulating system, as this part of the car may be said to have been developed to a

state of perfection; that is, the temperature and pressure of the steam remain practically constant without in any way engaging or requiring the attention of the driver, no matter what the running conditions may be.

The White Gasoline Car—With the addition of a gasoline car to the White products the extensive selling organization of the company is in a position to meet the demands for all classes of cars. In adding a gasoline car to its line at this time the White Company, with its factory facilities, long experience in automobile building and trained organization, unencumbered by any preconceived notions for or against any particular construction, is in a position to furnish the best in gasoline-car design, workmanship and material.

The White gasoline car is fitted with a four-cylinder, four-cycle engine of extremely simple and neat design. The car has a four-speed selective type transmission and a shaft drive. The four cylinders are cast in one piece. The cylinder dimensions are 3 3-4-inch bore and 5 1-8-inch stroke. The stroke is longer in proportion to the bore than in any other American car, the White construction being in accordance with the 1909-1910 practice of the leading foreign designers. The advantages claimed for the long stroke are much greater efficiency and higher fuel economy.

A feature of the car is the unusually small amount of piping and fittings under the bonnet. The valves are all on one side and are actuated by a single half-time shaft. The valve springs are not exposed to view, but may be inspected or replaced by removing a side plate.

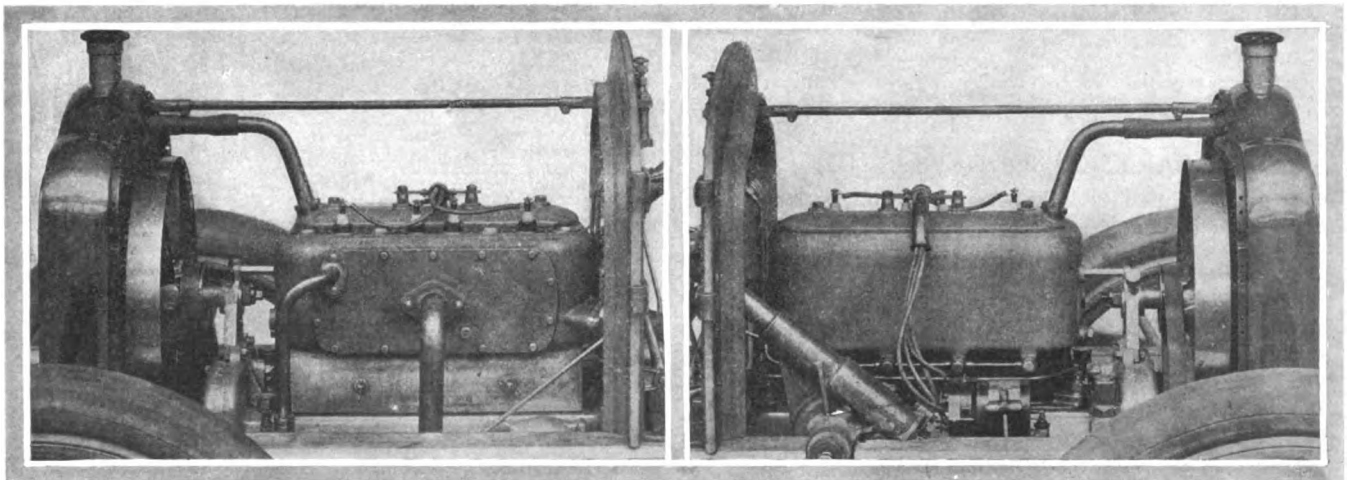

The inlet side of motor shows simple piping

And the magneto side, too, looks clean cut

Left and Right Hand Views of the White Gasoline Block Type Long Stroke Motor

There is neither an inlet manifold, an exhaust manifold or a water manifold in sight. Fig. 4 shows the left-hand side of the engine on which side are located the valves and the spark plugs. At the front of the engine on this side is a centrifugal pump, from which a pipe leads to the water jacket. In the center is the intake pipe leading from the carbureter. From the rear of the engine the exhaust pipe leads to the muffler. The oil reservoir forms an integral part of the aluminum crankcase, being located at the rear on the left side.

As shown in Fig. 5, there is no piping except the oil leads on the right side of the engine. The only device on this side is the gear-driven Bosch magneto, to which the timer is attached. The only wiring on the car consists of the four short wires leading from the timer to the spark plugs, as shown in Fig. 5, and also the two wires leading to the switch on the dash. The crankshaft has but two main bearings which are annular ball bearings of generous dimensions. The connecting-rod bearings are of Parsons' white metal. The oil pump is driven from

the half-time shaft and supplies oil to the connecting-rod bearings and to the crankcase by way of an adjustable sight-feed on the dash. The gears driving the half-time shaft, the water pump and the magneto are of fiber and metal and are completely inclosed. The radiator is of the "honey-comb" type and its shape follows approximately the lines of the condenser of the White Steamer.

The engine is attached to the cross-members of the frame by three-point suspension. The clutch is of the leather-faced cone type. The gear-case is hung by three-point suspension on the cross-members of the frame. As already mentioned, the transmission is of the selective type with four forward speeds and one reverse. The direct drive is on the third speed. The drive from the gear case to the rear axle is by means of a shaft fitted with two universal joints. The frame is of pressed steel, narrowed at the forward end. The wheel-base is 110 inches. The front axle is of I-beam section and all bearings on the wheels and in the rear axle are annular ball bearings.

INTENDS TO HAVE PERFECT COMMUTATORS

To repeat an old expression, there's many a slip betwixt the cup and the lip. This does not apply to automobile parts, but a perverted form of it might be made to do duty as a means of expressing the fact that the finished machine may lack something intended to be put on or in some way attended to. So, any device which has for its object the proving of correctness of a minor part of the machine is worthy of attention.

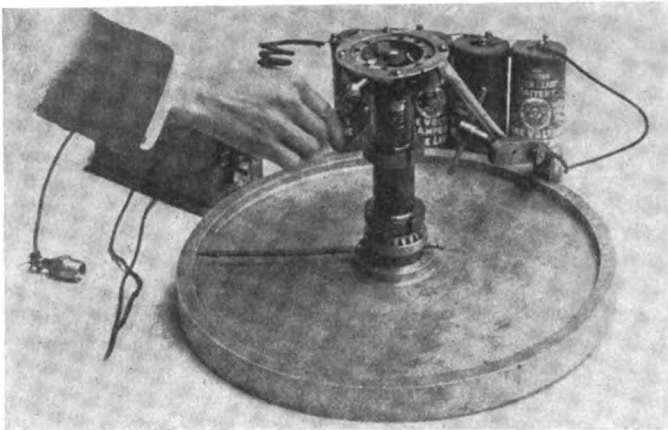

Device for Testing the Accuracy of Rambler Commutators

In the work of producing a vast number of machines as in the factory of Thomas B. Jeffery & Company, a little machine just perfected will save the future owner many a long search for the source of trouble. This is a commutator testing device, and is intended to prove up, previous to use, the condition of the timer. A gear with a contact arm and roller, corresponding to these parts on the commutator, is attached in the center of an indicator, upon which an arrow shows whether the timer is set to fire early, late, or correctly. By this means it is asserted absolute accuracy of timing is obtained.

71 ALARMS IN 136 DAYS; \$24.81

GRAND RAPIDS, MICH., June 14—The value of the automobile fire engine was one of the principal subjects of discussion at the Michigan State Firemen's Convention, which has just been held in this city. Chief Charles Fishbeck of Alma read a paper favoring self-propelling machines, and in the discussion the advantage of the auto over the ordinary horse-drawn engine in climbing hills, on clay roads and unpaved streets was pointed out, and the saving of the expense of an extra hose cart for carrying hose. Chief Delfs, of Lansing, who has recently been furnished with an auto engine, reported that his engine had responded to 71 alarms in 136 days, a total of 16 hours at a total cost of \$24.81.

A HANDY METRIC CONVERSION TABLE

The table here given is one circulated among engineers by the C. W. Hunt Company, of West New Brighton, N. Y., and in view of the manner in which it is compiled, it should be of good advantage to automobile engineers and others who are required to treat with metric measurements in conjunction with the English system. It is given below:

Millimetres × .03937 = inches.
Millimetres ÷ 25.4 = inches.
Centimetres × .3937 = inches.
Centimetres ÷ 2.54 = inches.
Metres × 39.37 = inches. (Act Congress.)
Metres × 3.281 = feet.
Metres × 1.094 = yards.
Kilometres × .621 = miles.
Kilometres ÷ 1.6093 = miles.
Kilometres × 3280.8693 = feet.
Square Millimetres × .00155 = square inches.
Square Millimetres ÷ 645.1 = square inches.
Square Centimetres × .155 = square inches.
Square Centimetres ÷ 6.451 = square inches.
Square Metres × 10.764 = square feet.
Square Kilometres × 247.1 = acres.
Hectare × 2.471 = acres.
Cubic Centimetres ÷ 16.383 = cubic inches.
Cubic Centimetres ÷ 3.69 = fl. drams (U.S.P.)
Cubic Centimetres ÷ 29.57 = fluid ounces (U.S.P.)
Cubic Metres × 35.315 = cubic feet.
Cubic Metres × 1.308 = cubic yards.
Cubic Metres × 264.2 = gallons (231. cubic inches).
Litres × 61.022 = cubic inches. (Act Congress.)
Litres × 33.84 = fluid ounces. (U. S. Phar.)
Litres × 264.2 = gallons (231. cubic inches).
Litres ÷ 3.78 = gallons (231. cubic inches).
Litres ÷ 28.316 = cubic feet.
Hectolitres × 3.531 = cubic feet.
Hectolitres × 2.84 = bushels (2150.42 cubic inches).
Hectolitres × .131 = cubic yards.
Hectolitres ÷ 26.42 = gallons (231. cubic inches).
Grammes × 15.432 = grains. (Act Congress.)
Grammes ÷ 981. = dynes.
Grammes (water) ÷ 29.57 = fluid ounces.
Grammes ÷ 28.35 = ounces avoirdupois.
Grammes per cubic centimetre ÷ 27.7 = lbs. per cu. in.
Joule ÷ .7373 = foot pounds.
Kilo-grammes × 2.2046 = pounds.
Kilo-grammes × 35.3 = ounces avoirdupois.
Kilo-grammes ÷ 907.2 = tons (2,000 pounds).
Kilo-grammes per sq. cent. × 14.223 = lbs. per sq. in.
Kilo-gram-metres × 7.233 = foot pounds.
Kilo-gramme per Metre × .672 pounds = lbs. per foot.
Kilo-gramme per Cubic Metre × .062 = lbs. per cu. ft.
Tonneau × 1.1023 = tons (2,000 pounds).
Kilo-Watts × 1.34 = Horsepower.
Watts ÷ 746. = Horsepower.
Watts × .7373 = foot pounds per second.
Calorie × 3.968 = B. T. U.
Cheval vapeur ÷ .9863 = Horsepower.
(Centigrade × 1.8) + 32 = degree Fahrenheit.
Franc × .193 = Dollars.
Gravity Paris = 980.94 centimetres per second.

CANADIAN PACIFIC RAILWAY ADOPTS AUTOS

MONTREAL, CAN., June 14—One of the latest innovations in modern railway work, the automobile hand car, has been adopted by the Canadian Pacific Railway. A number of these have been purchased and put into active service, one on each division, to be used for inspection work. The little cars, for they are so small and light that a few men can lift them onto or off of the track in time of necessity, will be useful for close inspecting work which the ordinary locomotive and car can not do.

Exhaust Side of Automobile Motors

By Thos. J. Fay

Part II

NOISE is the bane of the automobile, particularly the character of noise that emanates from the exhaust of a motor, and it is the function of a muffler to stifle the same. The efficiency of such a device cannot well be regarded as an abstract quantity on the ground that all motors do not perform in like manner as respects noise made. This is proven when a given muffler, which may be satisfactory on a given motor, fails to do good work on another motor of the same size.

It is even true that a given motor will act differently under changing conditions, and in a general way it may be said:

- (A) Noise will swell in volume as the compression is increased.
- (B) The combustion pressure will cause noise, increasing with the same.
- (C) A belated spark will induce noise, due to the combustion continuing into the muffler.
- (D) Noise will be present, increasing as the terminal pressure.
- (E) Increasing speed will have the effect of increasing noise also.
- (F) Noise increases as the volume or weight of the exhaust gas increases.
- (G) Ill-devised parts, in which vibrations are at a rapid rate, will have a marked effect on the volume and character of the noise emitted.

To better understand the reasons why noise is made it will be profitable to go into the details of the phenomenon, rather with the expectation of being the more able to thwart the process and eliminate the noise.

Sound Is Not Produced In a Vacuum—Sound implies the vibration of air or some other medium; obviously, a vacuum, in which there is nothing to vibrate, will not support sound. Since sound implies vibrations, some of which may be classed as harmony and the balance as discordant (noise), the problem of the exhaust may be approached along lines taking into account the natural laws, in so far as they are applicable.

When a sound is perceived it is certain that some body, in one of its states of aggregation, is being vibrated; moreover, when a body is vibrated the air surrounding the same vibrates in uni-

son, and the effect of the vibrating body on the surrounding air must be taken into account in any attempt to stifle the sound. The drum-skin of the ear, together with the bone members, vibrates in response to surrounding vibrations, and in this way we are rendered conscious of the vibrations which we call noise if they are out of harmony, and musical notes if they impress us favorably. Were all men deaf, it would be a matter of no moment at all as to the character of the vibrations made by the exhaust from motors, and no attention would be paid to this phase of the problem, excepting as the vibrations would affect the life of the parts or the amount of power available.

Acoustics, which is the branch of Natural Philosophy dealing with the vibrations that cause sound, must be regarded as the cause of the manifestations, while sound is a sensation peculiar to the ear; since deafness is not universal it becomes necessary to treat with the acoustics of the automobile in order to afford agreeable, if any sound, as it is emitted from the bowels of a car, and as experience dictates, the exhaust is a prolific source of the class of sound that is placed in the catalogue of noise.

The best results will follow if all vibrations are eliminated, and next to this, it is desirable to so control the vibrations, that the sound emitted will be feeble at best, and of a character such as can be borne with equanimity. The absolutely sure way to abort sound is to place the car in a hermetically sealed chamber and exhaust the air from the same; even then the car, at any part, must not contact with the chamber; this is not a practical way to proceed, but it does afford a fulcrum, as it were, on which to rest the lever of reasoning, rather with the expectation that the lever will multiply advantage and lift the reasoner to a higher and more satisfactory plane.

Since it is the ear that is affected by sound, and in view of the ease with which the same ear becomes unconscious of sounds that in the beginning are perfectly audible, it is easy enough to reason out how builders of cars persuade themselves into the belief that their products are as noiseless as the very depths of Nature in the still of the night, whereas others may be much impressed by the very noise emitted. In the delineation of noise (sound) then, there are phases of the problem that cannot well

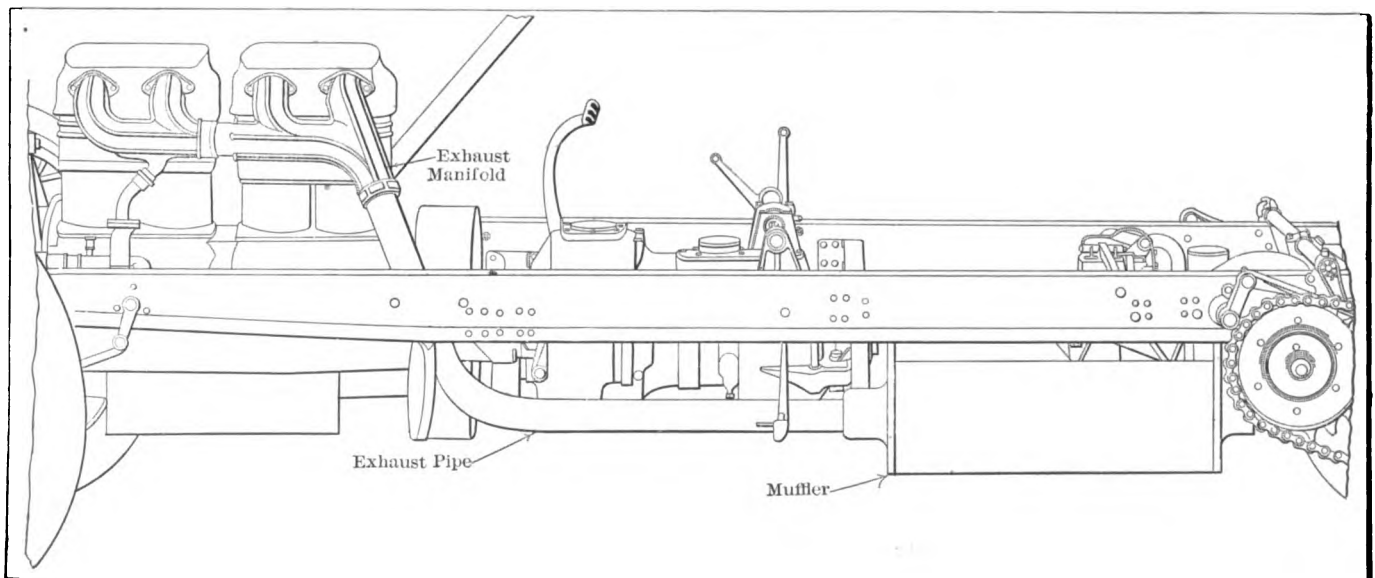

Fig. 61—Showing position of muffler, how the exhaust pipe passes along to the manifold, and easy bends at all points

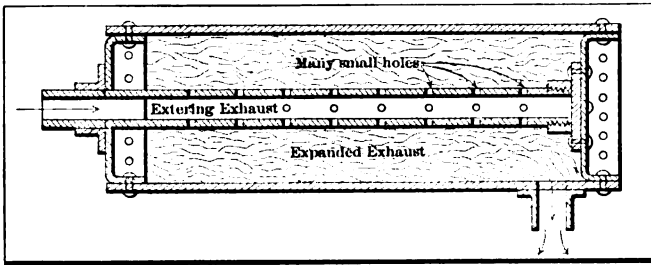

Fig. 62—Depicting a simple form of muffer, used on many cars, and delivering good satisfaction

be disposed of on the ground that what one person calls noise another would fail to notice.

Noiseless performance, then, is not always what it is presumed to be and in the discussion here it will be to the purpose to designate the same as "performance in the absence of any noise at all," such as would be audible from a prospect in the vicinity of the performing car to one who is not under the influence of the chloroforming influence due to long familiarity.

Sound travels at a constant velocity, no matter what may be the pitch, intensity and timber, which are the three prime qualities by which it is interpreted. By pitch, sound is located on a scale; thus we speak of sounds higher, or lower on the scale, and the higher the pitch the greater is the number of vibrations that produce it. The ordinary ear is sensitive to sounds that are produced by 40 vibrations per second, which low rate of vibration induces a sensation that resembles the beats of two base organ pipes if they are considerably out of tune. In the higher range of vibrations the average ear is unconscious of sound produced by 12,000 to 20,000 vibrations per second, and many are so "sound blind" that they are incapable of noticing the result of less than the minimum number (12,000) stated.

In America, Great Britain, and Germany, a vibration is taken to be a movement to, and fro, of the vibrating body. In France, a vibration is regarded as a motion to, or fro. This difference must be taken into account when the matter is under consideration.

Pitch rises with the number of vibrations, and may be determined in divers ways, as when a disc (of cardboard), perforated (in a suitable way), is rotated, and a glass tube, in juxtaposition, is blown through, and the disc is rotated at a uniform rate, simultaneously. The puffs of air resulting will emit a sound of increasing pitch, as the tube is moved out on the disc, under the influence of the rows of holes placed with an increasing radial relation, equi-distant from each other. Pitch then is under the influence of the physical shape of the member vibrated and the rate of vibration is the matter to be given consideration.

Intensity, as the word implies, relates to the energy of the air vibration which strikes the ear; hence the "amplitude" (extent of transverse vibration of the sounding body) may be measured, and in so doing it is possible to predict intensity, as it is affected by distance, in view of the law, which may be stated as follows:

The intensity of sound (like that of light) varies inversely as the square of the distance.

This question of intensity is of the greatest importance from the point of view of the muffer, which is the thing to be kept uppermost in the mind's eye during the course of this discussion. It was said that, in a vacuum, sounds cannot be propagated, for

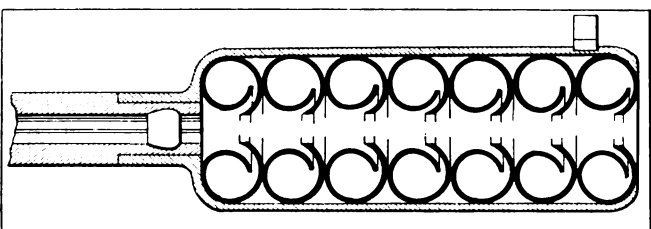

Fig. 63—Maxim's silencer, used on guns, but suitable for use in muffling work, in connection with automobiles

the reason that there is no matter to set into vibration; let us reason backwards, and to illustrate a point, go down into a caisson, in which the air pressure is as much as two atmospheres; under such conditions, even a whisper becomes a noise, and conversation at the ordinary (normal) intensity becomes painfully loud. Increasing the pressure of the atmosphere then has the effect of increasing the intensity of sound due to vibration, and in a muffer the pressure is increased over that of the atmosphere (by a considerable amount; to at least two atmospheres), so that the intensity of sound is the normal expectation. Then, account must be taken of pressure variations, and the differences in intensity that must follow in view of the increase in intensity for increasing pressure, which assures that the intensity will change with the pressure changes. In this way the intensity of sound becomes compound, as it were, and a classification becomes very difficult, excepting that it is a noise that will result, rather than a musical note; of that we have exact knowledge and not a few examples.

"A simple sound is one in which the ear can distinguish only one sound of one pitch." A tuning-fork, for illustration, emits a simple sound; composite sounds are the product of several simple sounds intermingled, as exemplified when a piano wire is struck, causing it to vibrate. In the instance of the piano wire, it is the practice to so locate the venters and nodes that

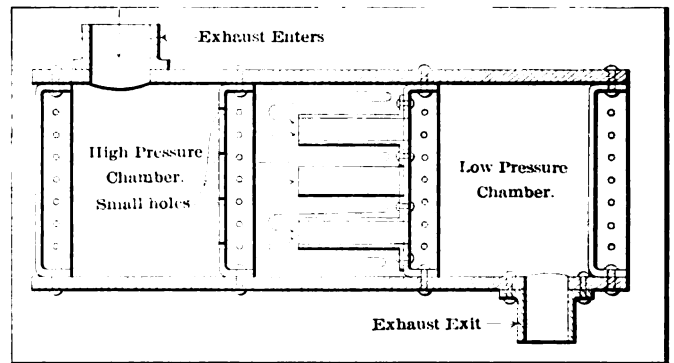

Fig. 64—Simplex type of muffer, showing three chambers, so contrived that the pressure is reduced almost to zero before the exhaust makes its exit to the atmosphere

sounds are as overtones in the harmonic relation; as when treble C (middle) is to 1:2:3:4:5:6:7:8 C, etc. The intermingling of the overtones, in such a case, will have for the lowest pitch, the treble C superimposing the higher harmonics.

"All simple sounds have the same timber." This property, referring to sound, is analogous to color in light; in sound, it is possible to change the timber by the simple expedient of mingling a different set of simple sounds, in a manner not unlike the changes that can be wrought in color, by altering the proportions of the pigments used. A chorus of components, however, may be in harmony, or it may not. In the case of the muffer, the chorus of sounds emitted is, as a rule, discordant.

The difference between harmony and discord is not so readily explained, although, as a musical proposition, we owe much to the work of Helmholtz, and for the rest, perhaps in a practical way, to Prof. Mayer. As Helmholtz pointed out, if light is taken as an illustration, and the number of flashes per second are at a low rate, the sensation is disagreeable; upon increasing the number per second the sensation changes, and when a certain rate is attained the eye then fails to perceive the spaces between flashes (the dark periods), and the disagreeable sensation is lost. In the same way, as it was pointed out, beats of sound show the same effect. When Prof. Mayer undertook to demonstrate the point to be made, he used disks perforated with various sizes of holes, which admitted and shut off the sound alternately, with the result that flashes of sound followed.

In this way Prof. Mayer was able to determine that the duration of sensation of sound depended upon the pitch of the same, and he also found that the higher the pitch the less the in-

terval of time. It has been determined that when resultant beats of sound from two sets of vibrations are intermingled the number of beats per second corresponding must be at a certain high rate or the sound will be of the character classed as noise. When a plurality of separate vibrating members are in sound relation, as in a muffler, it is difficult to see how, by deliberate design, the resultant can be sufficiently controlled to assure a musical sound; nor is it to be supposed that a muffler should be an imitation of a steam caliope.

What Practice Would Seem to Dictate—From what has been said involving the laws of sound, it would seem as if the one best way to fashion a muffler should take into account the intensity, pitch and timber of such sounds as are produced at the atmospheric pressure. So much for the functions of the muffler, which does not afford the right to design the same in such a way that the materials used will act as sounding-boards, bells, pipes, etc. Fig. 61 is offered as illustrating a system so contrived that the bends are easy, the materials so disposed that sounds emanating from them will be but feeble at best, and the parts are so supported to the chassis that they are not prone to go adrift, hence chattering will be avoided.

A simple exhaust silencer (muffler) is shown in Fig. 62, consisting of a cylinder and a pipe so contrived that the pipe, which is drilled full of small holes, will admit the exhaust at high pres-

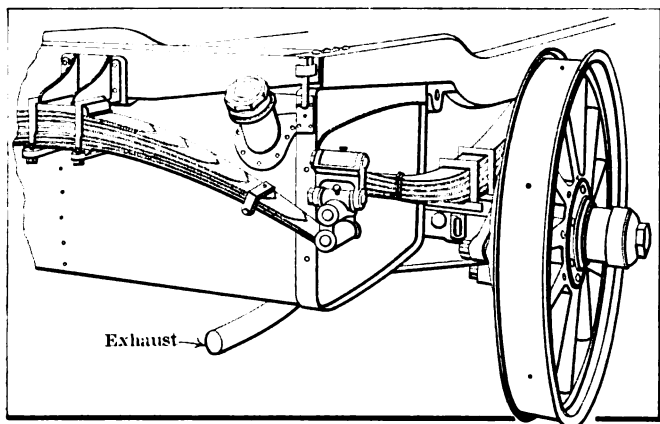

Fig. 65—Exhaust pipe passes under gasoline tank in rear, demanding that it be well secured to prevent whip-sawing

sure, and as it is required to pass through a large number of small holes, it is split up and then expanded. The gas passes to the atmosphere in an even flow, at a pressure slightly above that of the atmosphere. This type of muffler is fairly efficient when well designed, but as a more advanced type it is very likely that the Maxim silencer will do better work. This silencer is depicted in Fig. 63, which is a cross-section, and, as will be seen at a glance, the gas as it enters the silencer is swirled around the spiral-like cells and is minutely subdivided and fully expanded in the process, so that it emits from the silencer (when it is used on a gun, at any rate) with little or no noise or sound of any kind.

One of the most satisfactory types of muffler that the author has been able to experiment with is that as shown in Fig. 64, showing a cross-section of the "Simplex," from cars of the same name. In this type of muffler the exhaust enters a high-pressure chamber, and then passes through a separating wall filled with holes, 3-16 inch in diameter, of a combined area equal to that of a piston of the motor. The high-pressure chamber is designed with a cubical space equal to the displacement of one of the cylinders of the motor. The middle chamber of the muffler represents double the volume of one of the cylinders of the motor, and the tubes in the second dividing wall, of which there are five, have a combined area equal to that of an exhaust valve of the motor. The arrows show how the gases rush from the high-pressure chamber into the middle chamber, dash against the second wall, and, after bounding back, make their exit into

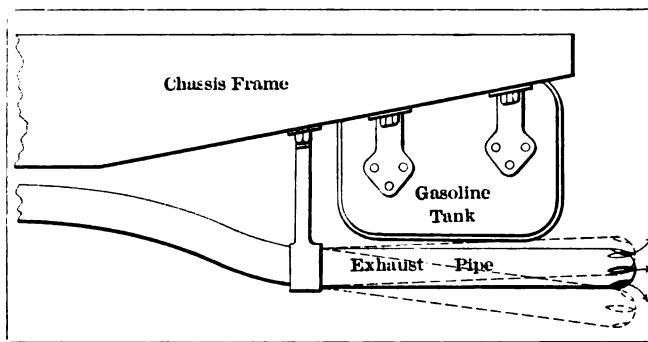

Fig. 66—Side view of constructions shown in preceding figure, and what happens if pipe is not well secured

the low-pressure chamber by way of the five relatively small tubes. The low-pressure chamber has a volume equal to that of the other two chambers combined, and that it should be more is probably true. The exhaust from the low-pressure chamber is in a little less than the period of four cycles, so that the space is available for the next inrush of gas after the completion of each four cycles. The illustration shows the cylinder with walls considerably thicker than practice dictates, although it is true that it is by way of noise reduction if the walls are thick.

Certain Design Features to be Considered—Besides the design of the muffler there is the question of the placing of the same. Fig. 61 shows the muffler in the fore-and-aft plans, in front of the rear axle; this is a very good location, and is the only one left when the gasoline tank is in the lateral plane to the back of the hind axle. Fig. 65 shows the gasoline tank to the rear, and the exhaust pipe passing under the same. Fig. 66 tells the balance of the story, provided the pipe is insecurely fastened, as it is in some cases; the end of the pipe whipsaws against the bottom of the gasoline tank, and it is but a matter of time when a hole will be the natural result in such a case.

Sometimes the muffler is placed to the rear of the chassis frame, in place of the gasoline tank, in the manner as depicted in Fig. 67, and a muffler cutout is located in the exhaust pipe just before it enters the muffler. That the muffler cutout should be well to the rear is assured, in view of the smell that is so prone to emanate from the exhaust, and locating the cutout at this point assures that the smell will be wafted away, with the hope that it will be of small inconvenience to the hindmost; the smell should be abandoned at the first way-station.

Sometimes the muffler is placed at the back in such a way that the exhaust pipe hangs from it and sags down, as shown in Fig. 68, so that there is an interference with the hind axle; this is a very serious matter, and it is only to be mended by suitably securing the exhaust pipe; incidentally, the muffler should be so fastened that it will stay in place and not rattle. The exhaust outlet may serve as a dust raiser, particularly if it is placed as shown in Fig. 69, with the end close to the road-bed and pointing at it. A better plan is offered in Fig. 67, and that the exit for the exhaust should be at the rear of the car is one of the points to be taken for granted.

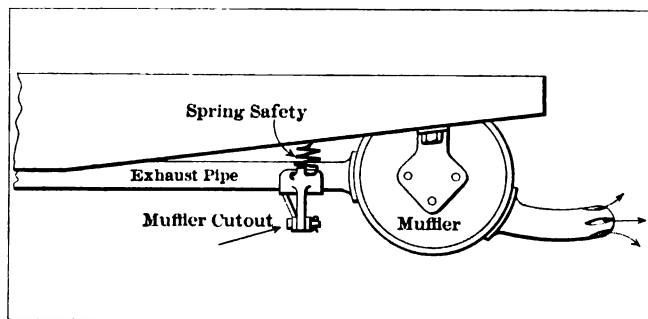

Fig. 67—Side view, showing muffler to rear of chassis, and muffler cut-out located so far back that exhaust will not float up into the car

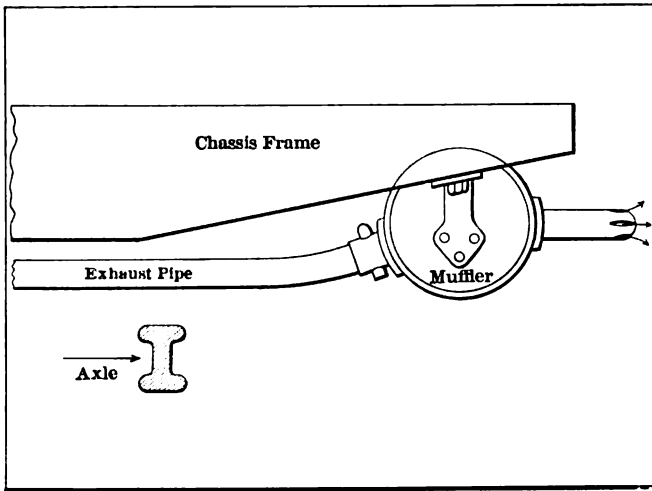

Fig. 68—Muffler located in rear and so weighed down by pipe that axle interference is imminent

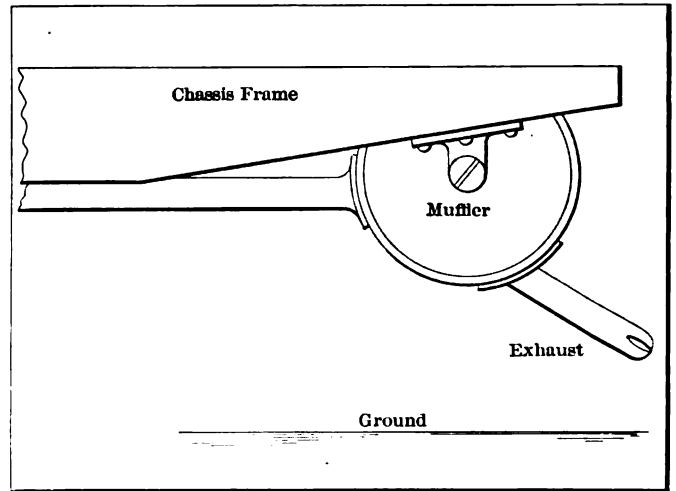

Fig. 69—Muffler in rear, and end of exhaust pipe pointed at the roadway, so near as to raise dust

In certain classes of work it is the custom to avoid the use of a muffler, on account of the back pressure that is likely to attend the use of any device provided for the purpose of aborting noise due to the exhaust. Fig. 70 shows a racing design in which no muffler is provided, and the exhaust is allowed to escape through direct openings on the side, not shown in the figure. In this connection it is well to point out that the design as shown in Fig. 64 is almost devoid of back pressure, and there are many examples of mufflers that do not offend to a serious extent in this direction. Before departing from the subject, especially as it relates to Fig. 70, it may not be out of place to emphasize the location of the gasoline tank, and the manner in which it is nested inside of the spare tires. In racing work, in particular, it is extremely difficult to keep the tank in place, and it is also a vain search betimes to find room for the spare tires; in this case the dual problem is neatly attended to. In conclusion, it will be enough to say that a little back pressure is better than much noise, and a muffler cutout will afford temporary relief, if it is found that the muffler does reduce the ability of the motor below the requirement on a hill.

Drop-Forged Steel Hangers Are Used—The time was when hangers of case gray iron were used to support mufflers and even the gasoline tank; experience has adequately proved that cast iron is of little or no value in this service, and the forgings of steel have to be of good quality if the work is to be regarded as of a permanent character. Nor can it be claimed that bronze castings are good enough to use, although it does seem as if steel

forgings would have preference on the ground that they cost less, which is besides the question of their greater life in this class of work, not to mention the greater uniformity of material, absence of "wasters," and assurance of prompt delivery in quantity.

The work the hangers have to do does not look arduous when a car is standing on the floor of a garage, but on the road when cars are doing turns at some speed the side strains are well worth taking into account, and if they are not it is a fair inference that a repair bill will render itself manifest at an early date. The idea that castings are cheaper and that more material can be used is not a good one to follow up, for the increased weight placed on a chassis will make itself the basis of additional cost of springs, etc. The appearance is against such construction and that autoists would prefer to have cars in which castings are not used to support important parts is one of the matters that can be taken for granted.

If drop forgings are used they should have an adequate bearing against the sheet-metal ends of the muffler very much in the manner as shown in Fig. 68 rather than as depicted in Fig. 69 with good and secure riveting, so that the muffler will stay in place. The forgings should be of acid open-hearth steel, the composition of which may be as follows:

Carbon	Silicon	Sulphur	Phosphorus	Manganese
0.20	0.10	0.04	0.04	0.40

If there is any difference the carbon might well be a little lower, say, 16 points, rather than to have it higher. The manganese might also be held a little lower than the value given.

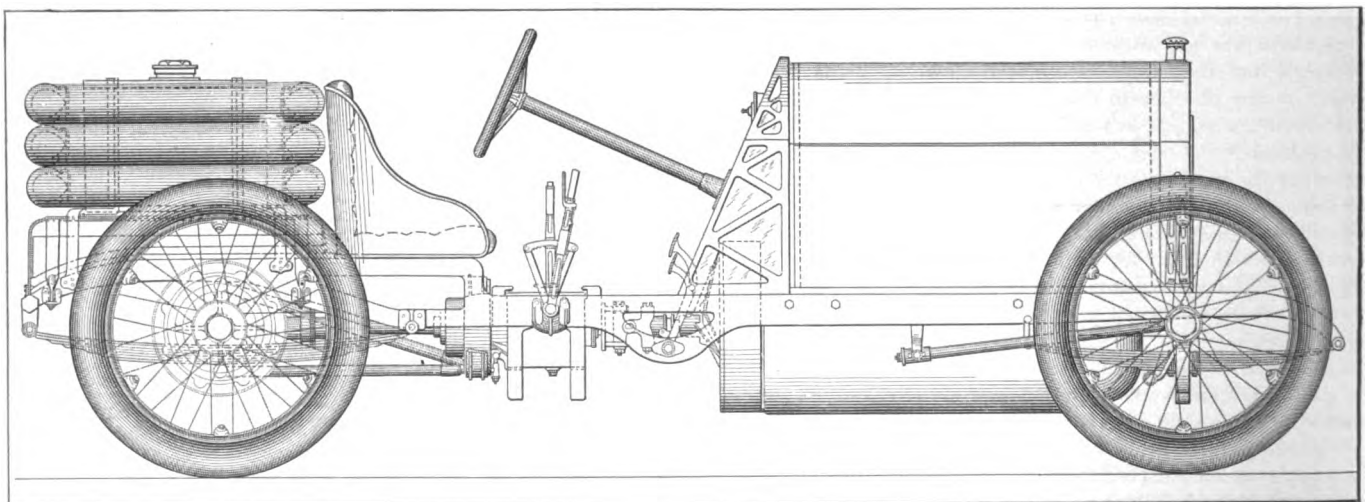

Fig. 70—Racing car design in which, to avoid back-pressure, no muffler is used; the same design shows a novel gasoline tank, and means for carrying spare tires

How New Drivers Can Reduce Tire Wear

By James S. Madison

AT this season of the year, many men and women are the proud possessors of their first automobiles. The car looks beautiful, the brass glitters, the varnish has a mirror-like surface, and the tires, in their attractive symmetry, seem indestructible and give no suggestion of the rapidity with which they will wear out, and no hint as to their capacity for trouble. Let the novice be assured that the time he will spend on keeping brass bright and the paint clean is out of all proportion to their value. He should realize in the beginning that it is far more important—in fact, most important—that he should give his tires his first, last and most intelligent attention. If he is a man of limited time and means, it would be more sensible and economical to neglect his brass until it resembles brass only remotely, than to neglect his tires.

The owner who does the latter, who fails to obtain all the information possible about the care of his tires, is inviting trouble, and will sooner or later pay a large price for his carelessness and ignorance. This information is not difficult to acquire; it is accessible to every one who will write to the tire manufacturer, asking for it. All the important manufacturers publish instruction booklets which they are glad to send to the user in the hope of enlisting his co-operation securing the best results.

The new owner should realize at the outset that the most expensive and the least permanent part of his entire equipment is the tires. He should make a simple calculation something like this: assuming that the tires will last for 3,500 miles and the cost of the new tires is \$150, what is the tire-cost per mile? The answer is 4.3 cents. But this isn't all of it. With the most intelligent care, there will be punctures, gashes, sand blisters, with perhaps an occasional blow-out, rim cut, leaking valve, etc. These must be repaired; each repair will cost 35 cents or more at the garage, which will run his tire expense up to 6 or 8 cents per mile or even beyond that.

Of course, there are many tires that will give a mileage far in excess of this, but if the owner gets a greater amount of service, he should regard it as exceptional and be correspondingly thankful. He will be wise if he makes his calculation on the basis of the figure given. On the other hand, there are many tires that do not last as great a distance as this, due to improper care and driving on the new owner's part, rather than to defects in material or workmanship.

While it is true that the manufacturer will make an adjustment and supply new tires, in most instances at the consumer's price less the fixed and stated allowance for the mileage obtained from the old tires, yet this is usually a matter of great inconvenience, often resulting in the car being out of commission from several days to a week or more, depending upon the distance the owner lives from the factory.

There are a number of causes which induce the rapid deterioration of pneumatic tires. Of these, the two most important are: overloading and under-inflation.

How to Avoid Overloading—The novice asks "How am I to know whether my tires are overloaded?" There is only one way. Run the car on an accurate platform scale, and weigh it. Do not trust other people's statements as to the weight. They are sometimes false. The writer is familiar with a car that was described in the catalogue as weighing "approximately 1,650 pounds." The scales showed 2,000 pounds. The owner, in ignorance of the effect on his tires, added to his car a speedometer, an odometer, a clock, a heavy top with front, side and storm curtains, a complete line of tools, a heavy jack, a pump, extra parts, extra tubes, a tire repair kit, etc., so that with two passengers of average weight his tires were supporting 2,400 pounds! The size of the tire with which the car was equipped was

designed to carry 1,800 pounds. The result was inevitable. His tires began to be troublesome when he had ridden 1,500 miles. By constant attention and spending much time in repairing, he worried along with them until the total mileage was 2,400, when the entire set was done for, and was sold as junk. Had he weighed the car at first, he would probably have been more cautious in making additions to it, and would have been saved continued annoyance and expense.

The following table, compiled from tire manufacturers' data, is intended as a guide to the novice. It gives the maximum weight each tire is intended to carry without being overloaded. These figures do *not* include the weight of the passengers:

Size of Tire	Weight per Wheel
2 1/2 inch	225 lbs.
3 "	350 "
28 x 3 1/2 "	400 "
30 x 3 1/2 "	450 "
32 x 3 1/2 "	550 "
34 x 3 1/2 "	600 "
36 x 3 1/2 "	600 "
30 x 4 "	550 "
31 x 4 "	600 "
32 x 4 "	650 "
34 x 4 "	700 "
36 x 4 "	750 "
32 x 4 1/2 "	700 "
34 x 4 1/2 "	800 "
36 x 4 1/2 "	900 "
5 "	1,000 "

These figures are given only as suggestions; the owner should not rely upon them wholly, but should get the data direct from the manufacturer. Should he find that his tires are overloaded and that he is unable to reduce the weight of his car sufficiently by removing superfluous articles, he must make up his mind to get the greatest mileage from the tires, and then replace them by a larger size. This may be accomplished easily without going to larger wheels.

Many of the tire manufacturers are now offering for sale the so-called "odd sizes." They are made so that a 30x4" tire will fit perfectly a 30x3 1-2" wheel, or if a larger size is desired, a 31x4" tire may be placed on a 30x3 1-2" wheel. Other "odd sizes" may be obtained.

Under-Inflation Is Equally Dangerous—It is difficult, if not impossible, for the beginner to know just what is the proper amount of inflation for the tires, until he has gained a certain amount of experience that is necessary. One may easily make the mistake of not giving the tires sufficient inflation. By far the greater portion of tire injuries is due to this cause. On the other hand, it is easy to go beyond the proper point and give them excessive inflation. The result of the latter error is generally not long in coming, producing, in many cases, an explosion of the inner tube and casing simultaneously, which means complete destruction of both.

All books of instruction advise that the tires be kept pumped up until they will stand up round under a full load, but the difficulty often comes in knowing just when to stop pumping. One motorist, in inflating, keeps pumping until the tires, when struck with a hammer, give out a certain characteristic sound. Another one kicks them until they show a certain resistance. These are crude and dangerous methods.

The evils of under-inflation are much more numerous than those of over-inflation, although, as a rule, they do not show themselves so soon after an injury has been done. When the tire is soft from insufficient air pressure, the rubber is much more liable to be cut or gashed by every stone or other sharp-edged obstacle it meets. Even if there be no actual cuts or punctures, the fabric will be injured by being subjected to the great pressure momentarily brought upon a certain portion of it by striking an obstacle. Although no obstacles may be struck, the fabric will be injured, nevertheless, by the constant bending to

which it is subjected. This tends to break the fabric and separate the rubber from it. It is inevitable that such injuries, while not apparent at the time they are received, will result later in a blow-out. The beads of the tires will be cut, if the tire is soft, and punctures will be more frequent.

The Beginner's Safest Way—One safe method for the beginner to adopt is to have the agent or some experienced friend look at his tires every day until he himself can tell by the appearance and feel that he has the right inflation. The best way is the use of a pressure gauge.

Since different makes of tires of the same size require different pressures, the figures below are intended only as suggestive:

Tires	Pressure
2½ inch	45-50 pounds
3 "	50-60 "
3½ "	60-70 "
4 "	70-80 "
4½ "	80-90 "
5 "	90-100 "
5½ "	100-110 "
6 "	110-120 "

To learn the pressure in the tire at any time it is only necessary to unscrew the dust cap and the inner cap of the valve stem of the tire and attach the register, when the pressure is at once indicated by a pointer moving over a gradual dial. One of the popular forms of gauges can be attached to the pump and valve stem at the same time; the air that is pumped in passes through the gauge which shows the pressure at the end of each pump stroke. Another form can be attached to the valve stem only. If the reading shows under-inflation, the gauge must be unscrewed before the pump can be attached. It may be necessary to repeat this manipulation several times before the tire is properly inflated.

Whatever the type of gauge employed, it should never be used until it has been compared with the reading of a standard gauge. A similar comparison should be made at frequent intervals. In this way only can one be certain that if he wishes 70 pounds pressure he does not get 80 or more, due to incorrect registering. It is not uncommon to find that the small gauges read from 10 pounds under to 15 pounds over the correct amount.

A Sad Experience with an Incorrect Gauge—Recently, a friend of the writer pumped up his old tires to 70 pounds, as recommended, determining the pressure with a new gauge. During the night, when the car was standing idle in the garage, one of the rear tires exploded, ruining the casing. On comparing the gauge next day with a standard, he discovered that it read 15 pounds too low. This bit of information cost him \$25.

New tires should be examined every day for a week or more to see that the proper pressure is maintained, because the casing stretches slightly for about that length of time before it finally reaches the normal size under actual running conditions.

After the novice has provided means to guard against over- and under-inflation, he must always bear in mind that there are a number of other causes that may injure his tires. He will find it an advantage after every trip to run his hand over the entire surface of each tire for the detection of any possible nails, tacks, and wire ends, which may have been picked up and imbedded in the rubber. This precaution will save him many punctures.

He should at frequent intervals examine the entire surface of each casing for small cuts or gashes; if they penetrate the rubber through to the canvas (fabric) they should be vulcanized at once. Every particle of dust, sand or water that forces its way into an opening of this kind will damage the tire and shorten its life. If by accident grease or oil should get on the tires, it should be removed with a rag or waste moistened with a little gasoline. The owner should be sure, especially when the car is being washed, that none of the water gets into the inside of the casings. Moisture weakens the canvas which will finally rot, with the inevitable result—a blow-out. It will also cause the rims and side rings (in detachable tires) to rust.

Method of Procedure in Hot Weather—During the hot days of summer, the car should never be left standing in the direct sunlight. Whether the car is to stand for a short or a

long period, a shady spot should be selected. In addition to the destructive action of sunlight on the rubber, the heat causes the air to expand, producing a greater internal pressure, and increasing the tendency to rupture.

On a hot day, the tires should not be pumped up as hard as they are during cooler weather. The rear tires are subjected to greater strains than the front ones, and begin to show the wear first. When this happens, it is advisable to interchange them with the front ones, and thus equalize the wear. Should a tire become deflated while in motion, the effects on the car are of such a character as to be clearly distinguished. If it is one of the front tires, the driver will at once experience difficulty in steering; if it is one of the rear's, the car acts as if it were being held back, or going over a soft or "greasy" piece of road. The sooner the car is stopped under these conditions, the better.

The car should never be run on a deflated tire even for a short distance, for, in a great majority of cases, the shoe will be ruined. Less damage will be done by removing the tire and running cautiously on the rim of the wheel. This, however, should be resorted to only in great emergencies. It is a better plan to wrap a piece of rope around the rim and felloe until the former is well covered.

Much damage to the tires is often unconsciously occasioned by the method of starting and stopping the car. Every time the car is started too suddenly, every time the gear change is made with a jerk, and every time the brake is applied too rapidly, the life of the tire is shortened a definite amount. Many drivers wishing to make a stop do not decrease the speed until within a short distance of the stopping-place, when they throw out the clutch and jam on the brake, making a very pretty stop in a few feet. This is a mild variety of grand stand play, but the driver who does it is taking life out of his tires every time.

Easy on the Corners Means Easy on the Tires—The period at which the very greatest strain is put on any tire is when it is rounding a corner at high speed, which is another excellent way to cut the life of a tire in half. The prudent driver will always turn a corner cautiously and slowly.

Tires frequently become very much heated during a long run. In many cases the heating is due not only to the natural friction between the rubber and the inequalities of the road bed, but also between the inner tube and casing. This may be largely eliminated by rubbing a good quality of finely pulverized talc on the canvas of the casing and over the inner tube before it is inflated. Should the tires become very warm, it is advisable to stop and allow them to cool.

Avoid running in street car tracks—they were intended for wheels made of iron, not rubber. Every owner should purchase as part of his regular equipment a vulcanizer, as he will thus be able to make his own repairs and save the expense, delay and annoyance of taking his car to the garage every time he finds a cut or puncture. The method of procedure is so simple that anyone may learn it in a few minutes. In the course of a year, the owner will save the cost of the vulcanizer several times over.

When on the road for a short trip, one should carry an extra shoe and two extra tubes; or if he does not wish to go to the expense of the shoe, one or two blow-out sleeves will usually see him through. In addition, he should always carry a jack, pump, some tire-tape, rubber cement, rubber patches, talcum, extra valves for the valve stem, and washers.

A Smoking Tip—Automobilists planning tours into France will do well to note a new rule laid down by the Director of the French Customs Office, applicable to those who smoke. After May 1 tourists will be allowed to take with them only half the amount of tobacco formerly permitted for personal consumption. Ten cigars, twenty cigarettes, an ounce and a half of tobacco, is the limit, and the tourist must choose one of the three, and not all three. Moreover, the Director refuses to recognize the right of a woman to smoke, and they will be unable to aid their male companions by carrying extra supplies.



LETTERS INTERESTING AND INSTRUCTIVE

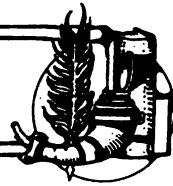

GAS ENGINE IGNITION

Editor THE AUTOMOBILE:

[1,914]—Will you kindly tell me in "Letters Interesting and Instructive" if the current from a small dynamo could be used for ignition on a large gas engine, and if so, how should it be arranged?
H. Y. Z.
Joplin, Mo.

You give so little information about the dynamo that the question is a hard one to answer. The ordinary current generator gives too low a voltage and at too high an amperage. If your voltage and amperage were correct, the addition of a spark coil or Rhumkorff coil, as it used to be called, and a timing device, would give a spark that would run the engine in a satisfactory manner. The ordinary magneto producing a true low tension current, which is intensified by means of a spark coil, gives about 35 volts at less than one ampere. If this be taken at exactly one to allow of some figures on the subject, the coil output will be, disregarding losses, say 20,000 volts at .15 ampere. This is upon two assumptions, namely, that the dynamo is a direct current machine, and that the field is separately excited, at least for starting. The latter statement is plain, if you consider that for starting purposes with a self-excited machine, a spark sufficient to ignite a charge is practically impossible, because of the very slow speed (comparatively) at which the operator can turn the engine over, with the consequent slow speed at which the current would begin to build up.

Next, as to the exact time of the spark produced by the outfit, if the engine does not already include such an apparatus, you will have to construct one yourself. To be exact, the current supply must be interrupted just before the point in the stroke at which the spark is desired in the cylinder. This might be done by purchasing an ordinary timer on the market, and rigging it up on the machine so that the speed is correct for the engine in question. This will differ with the number of cylinders, whether one, two, or more, and also, upon the cycle of action, that is, whether two or four cycle.

UNIVERSAL JOINT TROUBLE

Editor THE AUTOMOBILE:

[1,915]—Does a universal joint give uniform rotation at the rear axle? My car has double universal joints, and recently when the rear axle was removed and replaced, the slip joint was given a quarter turn in relation to the forward joint. Now with it in use, I fancy that I detect a surging effect in climbing hills on the second gear. Was not this matter discussed in one of the recent numbers of "The Automobile," and if so, in which one?
B. S. H.
New York City.

The surging which you mention would not be caused by the quarter turn which the rear joint was given, as this ought not to affect the relative rotation at all.

If there was a noticeable surging effect, that is, if you are sure that you detected one, it must be due to wear in some of the universal joint pins, this resulting in a lag and then a consequent surging forward to take up the lag.

A paper on the Limitations of the Universal Joint was read by H. Vanderbeek at the September, 1908, meeting of the Society of Automobile Engineers, and reprinted in the October 8, 1908, issue of THE AUTOMOBILE, beginning on page 501. The point is made herein that the proper

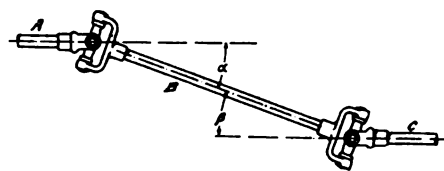

Correct Arrangement of Joints

placing of two universal joints at the two extremities of a sloping shaft mutually correct the inequalities of each of the joints used singly. This proper placing amounts only to making the angle of the two shafts at the upper end exactly equal to the angle between the two shafts at the lower end, which is shown in the figure reproduced herewith. In this figure, the two angles which must be made equal are marked α and β respectively. As ordinarily applied to an automobile, this takes the form shown in the second figure, which, on close inspection, is seen to be exactly like

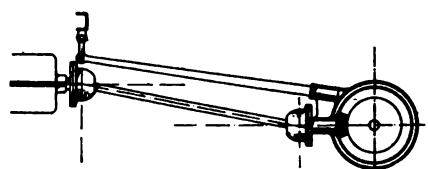

Same Form as Applied to a Car

the first one. The point not brought out above, but assumed, is that the three shafts are in the same vertical plane. If this is not true, none of the above holds good.

You will also find something of interest on this same subject contained in the paper Transmission of Power from Engine to Road Wheels, by L. A. Legros, in the May 13 issue of THE AUTOMOBILE. In this paper, on page 782, under the heading of Propeller Shafts and Bevel Gears, the author discusses the subject of universal joints, or, as he calls them, Hooke's joints, very thoroughly. The writer brings out the excellent point that the combination of two joints, one at each end of the propeller shaft, necessitates the use of torque rods, which is not the case with one joint.

POWER WITH TWO SPARKS

Editor THE AUTOMOBILE:

[1,916]—Will you please advise me on the following point? I have a four-cylinder car with double ignition. Now, would I gain anything by wiring the two plugs in the cylinders together, that is, would a spark at two points in the combustion chamber give more power than at present, or would it tend to make trouble in some other way?
H. S. B.
New York City.

If you mean, would two sparks occurring simultaneously, increase the power, there is no question about it, the power would be increased. If you are able to so time the two sparking devices that the sparks occur at exactly the same instant, the power will be increased by an amount equal to about 15 per cent.

The reason for this is that the speed of propagation of the flame is much greater with two sparks advancing from two different sources toward a common center than would be the case with a single source from which the flame advanced to the center, and then beyond to the other side of the combustion chamber, and finally back to the center again. This, of course, is dealing in infinitesimals, but the effect is very marked. In last week's issue of THE AUTOMOBILE an article was given in which this subject was discussed very thoroughly, the result being, in that case, namely, on a four-cylinder Clement-Talbot engine of 85 mm. bore by 120 mm. stroke running at 1,100 revolutions per minute, the indicated horsepower was 18.4 using but one spark plug, and 20.8 using two plugs, a gain of 13 per cent. At a higher speed of 1,600 revolutions, the increase due to the use of the extra plug was practically the same in percentage, although in actual amount added it was more, the figures being 26.0 with one and 29.3 with two plugs.

The increase in power required to furnish two sparks is negligible, so that the only source of trouble is the exact timing necessary in order to get the beneficial effect. This being a mere matter of mechanical detail and requiring but patience to correct, may be dismissed with a word. If the increase in power with two spark plugs does not materialize, look to the timing and keep on looking until the latter is perfected, when the desired result will be forthcoming.

MAKE AND BREAK ACTS FUNNY

Editor THE AUTOMOBILE:

[1,917]—Will you please explain the following trouble which I have had lately with my make and break igniters. I took them all out, and after cleaning, put them back as per instructions with a 3-16 space between the hammers and the plugs. When the engine was started, it would run, but missed badly on a retarded spark. The throttle had no effect upon the missing, whether advanced or retarded. One-half or more advance of the spark and the engine would run fine. The most puzzling thing about it was the

fact that with three cylinders cut out, the engine which had previously refused to fire, would fire and run in the best of shape on the one cylinder remaining, even with the spark retarded. G. S. H. Buffalo, N. Y.

The two statements are rather conflicting, that the engine missed badly on a retarded spark with all four cylinders, and ran fine with spark retarded on but one cylinder, so lay that aside.

Your source of trouble evidently lies in the igniters themselves, as nothing is said about the source of current beyond the statement that under certain conditions the engine runs fine, which presupposes a good source of current. Now, it would appear that the igniters were badly worn so that the distance advocated by the manufacturers and correct when the car was new, no longer held good. Therefore, you should set the points closer to the hammer than the directions call for, but your last statement would seem to indicate that all of them had not worn alike, one being still in good condition.

The proper method of procedure in a

the use of empirical formulæ, particularly in such places as the crankshaft. However, the two requested are here repeated.

For a five-bearing shaft:

$$\text{the crank pin diameter} = \sqrt[4]{\frac{P^2}{43.4 S}}$$

and for a three-bearing shaft:

$$\text{the crank pin diameter} = \sqrt[4]{\frac{P^2}{37.5 S}}$$

in which:

P = the maximum total pressure, which will always be the explosion pressure.

S = the tensile strength of the material used, in pounds per square inch.

CAUSE OF A BAD KNOCK

Editor THE AUTOMOBILE:

[1,919]—Will you please help me to solve a very puzzling case of knocking? My engine is a four-cylinder water-cooled machine of 15-horsepower. When put away last fall it was working well. After six months' idleness, it now develops a bad knock up hill which can only be eliminated by retarding the spark, but when that is done, the engine dies. The effect is the same on level ground if the throttle is opened more than one-third.

much at once, as the effect then is just as bad, the carbureter flooding at the slightest provocation. The better way would be to lower the nozzle a very slight amount, say one-quarter of a millimeter, or perhaps one sixty-fourth inch would not be too much. Try this level out very thoroughly, and when you are satisfied that it is not right, alter the level once more. The experience that you will get during the process will be worth all the time taken up in the series of successive adjustments, instead of trying to arrive at the result in a single or possibly two adjustments.

MANUFACTURER'S OPPORTUNITY

Editor THE AUTOMOBILE:

[1,920]—Kindly give me the addresses of all the manufacturing concerns engaged in the manufacture and sale of gasoline motor cars to operate on railroads, tramways, and industrial steel tracks for every purpose whatever. G. POWERS. Queretaro, Estado de Queretaro, Mexico.

It will be necessary to make two lists in answer to this request, as many makers

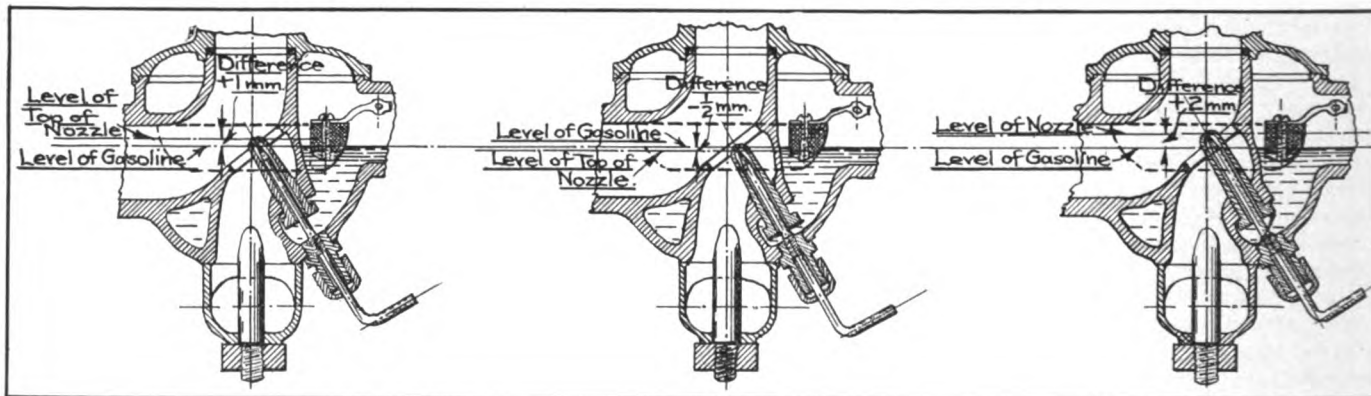

Correct nozzle position

Low location causes flooding

High position starves engine

Section of Typical Carbureter Showing Variations in Nozzle Level

case of this sort, in which you have a good current supply, and apparently no other trouble than bad timing, as your statement indicates, is to put one cylinder on the firing point in the stroke, and then adjust your spaces until that cylinder fires. Having fixed one cylinder, adjust the other spaces to the same distance as was correct for the first case. If the igniters have worn equally, as is usually the case, this will allow all cylinders to fire correctly. If not, the wear has varied and each cylinder will have a separate adjustment.

Another source of trouble in a low-tension ignition system using make and break is the spring tension, and although this did not bother you this time, it is well to remember in future cases.

CRANKSHAFT SIZES AGAIN

Editor THE AUTOMOBILE:

[1,918]—Being a designer of automobiles and greatly interested in the letter (1881) in the May 13 issue of "The Automobile," I will ask you to repeat the formula given there and explain what the letters used therein represent. S. L. HEILMAN. Boyertown, Pa.

The formula given in the issue mentioned was given under protest, as we deprecate

Would the level of the gasoline in the carbureter have this effect, as I may have disarranged it while cleaning the machine. I have tried more air, less air, more gasoline, and less gasoline, but all without avail. Somerville, Mass. SPARK GAP.

The effect of change of jet elevation, that is, change in the height of the spray nozzle, was fully discussed in letter No. 1,876 of the May 13 issue of THE AUTOMOBILE. The point there brought out seems to apply to your case, and thus indicate a cure for your trouble, so it is quoted here: "By raising the spray nozzle, you lower the level of the gasoline relatively. Therefore, the liquid will be less sensitive to the suction, which would reduce the amount of gasoline used. At low speeds, there would be a tendency to starve the engine, which would also be noticeable on hills."

The italics bring out the point, and we think show you what the trouble is, namely, that you have inadvertently lowered the spray nozzle so that the engine does not get enough fuel at slow speeds and on hills. By raising this a small amount, the engine will be able to suck up more fuel and you will find that the trouble ceases with the change. In making this, be careful not to lower the nozzle too

of cars for tramways and industrial tracks do not make railroad cars.

- Manufacturers of gasoline railroad cars:
 - Union Pacific Railroad Company, Omaha, Neb.
 - McKeen Motor Car Company, Omaha, Neb.
 - Sheffield Car Company, Three Rivers, Mich.
 - Buda Foundry & Machine Company, Chicago, Ill.
 - Milwaukee Gasoline Locomotive Company, Milwaukee, Wis.
 - Termatt & Monahan Company, Oshkosh, Wis.
 - Stover Carriage Company, Rockford, Ill.
 - Strang Gas Electric Car Company, Hoboken, N. J.

- Makers of other gasoline-driven cars:
 - Sheffield Car Company, Three Rivers, Mich.
 - Empire Manufacturing Company, Quincy, Ill.
 - Jeffrey Manufacturing Company, Columbus, O.
 - Buda Foundry & Machine Company, Chicago, Ill.
 - Avery Company, Peoria, Ill.
 - Youngstown Car Manufacturing Company, Youngstown, O.
 - Arthur Koppel Company, Pittsburg, Pa.

There may be many other firms in this line which we have missed, but for their benefit the inquirer's address is given in full, and they are at liberty to write to this party direct. Similarly, if any firms have been included by mistake, this was done with the best of intentions, the inquiry as a whole being somewhat out of our line.

WHAT TO DO WHEN THE FUEL PIPE BREAKS

By D. R. HOBART.

BREAKS in the fuel pipe are responsible for a large proportion of fires that occur on automobiles, by reason of the escaping gasoline being ignited by contact with a hot exhaust pipe or by means of an electric spark due to a short circuit of the ignition current. If the autoist is not provided with a soldering kit and a garage or plumber is not within reach, ordinarily he must submit to the ignominy of being towed. On the other hand, there are a number of ways of temporarily repairing the broken pipe

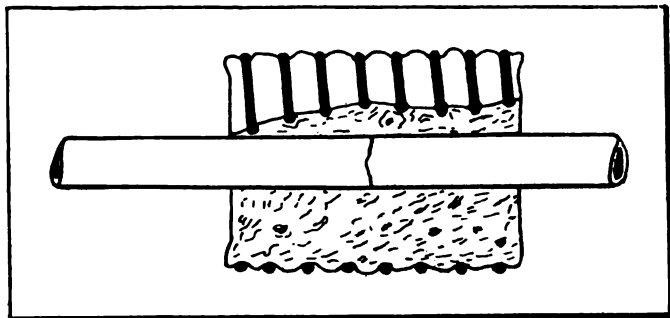

Fuel Pipe Effectively Repaired with Cork

which involve common objects in connection with the spares ordinarily carried, and by employing one of these the delay inevitable to the breaking of the pipe will be shortened and the car can proceed to where a permanent repair may be made.

While the stopping of the leakage in a broken pipe is important, the main object of the repair is to continue the supply of fuel to the carbureter. The broken ends must be held together in order to accomplish this, and short of brazing the pipe, there are three methods which can be used to hold it temporarily. These are: the splint, in which the ends are held by splints in the same manner as in surgery; the jacket, in which a wooden or other jacket is employed; and the "wrapping" method, where the ends are retained in place by tire tape or metal. In effecting any of the following repairs, the fuel should be shut off, and if any heating is to be done, the pipe should be removed.

Repairing by the Splint Method—Where the break in the pipe occurs in a straight portion of its length, the broken ends may be retained in their proper relation to each other by means of splints cut from a lead pencil or some other convenient source, the operation being conducted as follows: The broken ends are well soaped and placed together and the splints put on, steel or copper wire being wrapped around the splints as tightly as possible with the pliers. A wrapping of tire tape should be put over the whole as a further precaution. This repair will be effective for cars using either gravity or low-pressure fuel feed, but in the latter case, care will have to be taken in driving.

While a splint repair will hold for a considerable length of time, it is not so permanent as one made by the "jacket" method, in which the broken ends of the pipe are held in place by a wooden or rubber jacket, either shrunk on or fastened by means of wire or cord. A repair by this method, which employs inexpensive and readily obtainable materials—an ordinary cork and some copper wire—will be practically permanent, and is effected as follows: Having obtained a cork of sufficiently large size, a hole the size of the pipe is cut in it. The broken ends of the pipe are well soaped and the cork pushed over them so that the ends are supported as in the sketch. Wire is next wound tightly around the cork, and the latter is then thoroughly impregnated with water. As a result, the cork swells and grips the pipe tightly. In preparing the cork, the cutting will be rendered easier if the knife or chisel is kept moistened with water from time to time. Outside of excessive heat, the cork will stand any kind of treatment to which the pipe may be subjected.

Shrinking On a Tube Over the Break—Another means of repairing the broken pipe is to shrink a piece of tubing over it. On the majority of automobiles, the fuel pipe is standard one-quarter inch pipe size, but plumbers and hardware dealers have copper tubing which is designated by the outside diameter instead of the nominal inside diameter, as is the case with standard sizes. The standard one-quarter inch pipe measures .405 inch on its outside diameter, while the one-half inch outside diameter pipe measures .402 inch on its internal diameter. By properly heating the latter pipe, it can be expanded until it is sufficiently large to be placed over the former, and when cool will contract and firmly grip it, the two pipes forming practically one piece. The procedure in shrinking on the pipe is as follows: the broken pipe is first cleaned and kept free from dirt by wrapping in a cloth. The half-inch pipe should be annealed by heating to a red color and then suddenly cooling in water. In this respect copper is different from iron and steel, as these latter are annealed by heating and allowing them to cool slowly. When the tube has been annealed it is heated to about 700 degrees, when it will expand sufficiently to be slipped on over the pipe. The wrappings are now removed from the pipe and the tube slipped over it and allowed to cool slowly, when it will grip the pipe. The autoist can replace the pipe and go on his way confident that the break will not occur again at that point.

When the Break Occurs Near a Bend—When the break occurs near a bend in the pipe, the repair is best made by a splint or block grooved to fit the pipe and fastened in place by wire. In the sketch, the break is shown at C and the grooved block D is shown in position attached to the pipe. The groove E is easily cut with a knife and should approximate the shape of the bend. If the pipe does not fit exactly, bits of tire tape should be put around it to assist in holding. After the wire has been applied, a final wrapping of tire tape should be put on around the portion AA-BB. The back of the block should be concaved, so that the wire will not work off the ends. A similar arrangement can be made when the break occurs in the bend.

Temporary Repairs to Breaks in Unions—Ordinarily a break in a union occurs close to the male connection, with the result that the released pipe springs away from the joint and cannot be retained in its proper position again with reference to the connection without soldering. For a temporary repair, the

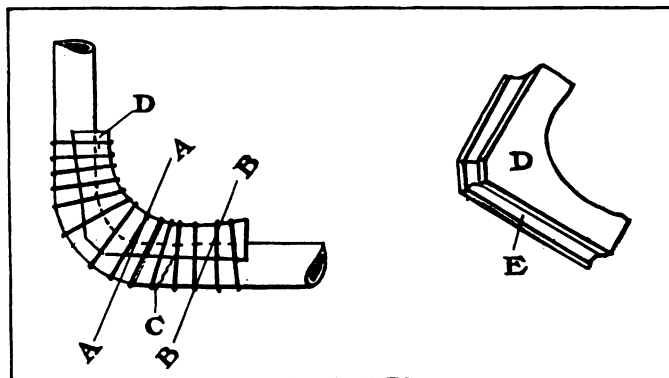

Repairing Break Near Bend with Wood Splint

male connection should be removed from the union and the pipe wrapped with twine or tire tape close to the break. The broken end should then be thrust into the female connection as far as it will go and the union nut screwed up tight, expanding the tape or twine which will grip the pipe and prevent it from coming away for a short time. Copper wire can be used when neither tape nor twine are available, but the latter are to be preferred as giving better grip than the wire.

Two Repairs by the Wrapping Method—Occasionally the broken ends of the pipe will stay in their proper relation to one another when a wrapping of tire tape is applied, without the use of splints, etc. When tape is put on it should be wound as tightly as possible and reversed at intervals like a surgical bandage, so that the pull of both ends of the pipe will come on all portions of the tape. A more permanent repair by the wrapping method consists in tinning the pipe for some distance in both directions from the break and wrapping a ribbon of copper or brass spirally over the tinned portions, reversing the ribbon at intervals as when using tire tape. This necessitates the employment of a soldering iron or some substitute therefor.

An Easily Constructed Roadside Forge—When soldering is to be done and a blow torch is not at hand, the autoist can construct a "forge" from the dirt on the road, making a circular mound, say about eight inches high and a foot in diameter, saturating this with gasoline and setting it on fire. The soldering iron can be heated in this dirt "forge" just as well as in an ordi-

nary shop forge, and the fire will continue to burn for a surprisingly long time. In making up a fire such as the above, care should be taken to locate it at the side of the road in a sheltered position so that a gust of wind will not scatter the flaming dirt over the car and cause a conflagration. As soon as the operation is finished, the flames should be smothered with dirt and the "forge" broken up and scattered over the road.

Wrench Handle Can be Used as Soldering Iron—An excellent substitute for a soldering iron is the steel handle of a wrench or the blade of a screw-driver, the handle or blade being cleaned and tinned in the same manner as the regular iron. By keeping a wrench with the handle ready tinned, the soldering iron can be dispensed with, and its place in the tool-roll given over to another tool or to tire tape, twine, etc. As regards solder, ordinary electric fuse wire will serve the purpose equally well, and can often be obtained from electricians and hardware dealers, who carry only the large bar solder. Solder in any form is, of course, equally efficient, but the strip form is to be preferred.

CONCERNING THE OFFSETTING GAS ENGINE CYLINDERS

By COKER F. CLARKSON, A. L. A. M.

THE invention and development of the gasoline automobile has brought about the evolution of an engine which differs from the gas engine of the stationary type in as marked degree as the latter differs from the steam engine. Though a dozen years ago the stationary gas engine designer would have ridiculed the idea of successfully producing a gas engine weighing less than ten pounds per horsepower developed, this, and more, has now been accomplished. It is futile to expect that automobile engineers will ever be thoroughly in accord on a subject involving so many opportunities for detail differences as automobile motor design; though, of course, years of experience have resulted in a type of construction followed so closely in such a larger number of instances as to warrant being termed standard practice in this respect. Whether taken singly or collectively the cars produced by the members of the Association of Licensed Automobile Manufacturers reveal more accord than difference in design.

The ordinary way of placing automobile engine cylinders with relation to the crankshaft (whence, of course, the power is taken off) is medially over the axis of the crankshaft. But for years, several years in some instances, some cars have had cylinders offset with relation to their crankshaft, that is, in a position wherein the center line of the cylinders is not opposite but to one side of the axis of the crankshaft. This difference in practice raises a very interesting and much discussed subject. It has been said that inasmuch as a gasoline motor crankshaft revolves in only one direction, it is mere common sense to place the cylinders in such a position that the pistons will transmit the power impulses to the crankshaft most effectively, that is, offset so that the maximum force of explosion is delivered on the piston when the crank is past the top vertical center line and therefore in the best position to receive it, and the pressure on the cylinder wall during fifteen to thirty degrees of the firing

stroke is, owing to the reduction of side-thrust, diminished. While this statement may be true, it is apt to be misleading, and in any event is not the only consideration. There are very positive advocates both for and against offset cylinders. Among the advantages claimed for offsetting are: Shorter connecting-rods, reduced wear, lighter construction, reduced friction between the pistons and cylinders on the power stroke, more direct turning effect on the crankshaft, less likelihood of a knocking motor, less shock on the engine bearings, less overall motor height necessary, greater motor flexibility and appreciable increase in power.

On the other hand it is said by those who prefer the construction wherein the cylinders are placed medially opposite the crankshaft that the claimed advantages of reduced side-thrust on the power stroke and more direct turning effect on the crankshaft have not much more than a theoretical value; that in T-head motors, with their two camshafts, offset cylinders involve complication desirable to avoid; and per contra statement above, that knocks are more common and wear is greater than in the usual type of engine. Further it is said that the offset becomes less advantageous at high engine speeds. Perhaps the most commonly advanced argument against offset cylinders is that the engine is thrown out of balance when they are used.

The controversy comes down to these two general positions, namely, on the one hand that in properly proportioned design it is unnecessary to offset cylinders in order to take care of the alleged counterbalancing advantage of doing so, less side-thrust on cylinder walls on the power stroke, etc.; and on the other hand that if an engine with offset cylinders is made as it should be, certain distinct advantages which have been suggested above are gained and clearly counterbalance any consequent disadvantages there may be.

A RATING FORMULA WHICH CONSIDERS STROKE

IN conjunction with the constant stirring up of the subject of empirical formulas for rating automobile and similar engines, one advanced by the well-known English manufacturers, Rolls-Royce, Limited, seems to possess some merit. This includes the use of the stroke, a point, the omission of which in the now standard formula has puzzled many.

The English makers propose that engines be rated at the power deduced by the use of the formula:

$$\text{Horsepower} = .25 (d - 1.2)^2 N V s$$

in which d denoted the diameter of the cylinder in inches, s , the

length of the stroke, and N , the number of cylinders employed. As most of the engines in use in this country are of the four-cylinder variety, the figure for N is nearly always four. Then multiplying by .25, which is equivalent to dividing by four, and then later multiplying by four again, is needless work. So for four-cylinder purposes, the formula reduces to:

$$\text{Horsepower} = (d - 1.2)^2 V s$$

Using this, the power rating from 4 by 4, 4 by 4 1-2 and 4 by 5 engines, all of which would otherwise be rated at 25.6, would be respectively 24.5, 27.2 and 30.



A Stop at Mt. Washington Hotel, Bretton Woods, N. H.

IMPROVING WHITE MOUNTAIN ROADS

BRETTON WOODS, N. H., June 14—Good news for automobile tourists is coming through the Crawford Notch and over other roads leading to this place, for gangs of men are now at work repairing them for the season. John Anderson, of the Mount Washington and Mount Pleasant hotels, says:

"The State of New Hampshire has taken a great interest in the highways leading to Bretton Woods, especially through Crawford Notch, where an enormous rock fill is being made to ease the grade at the foot of the last steep climb approaching the 'Gateway.' The walls at the top of the pass, at the crown of the hill, are being blasted out to widen the gap, and the rock thus obtained is being used in making the fill. The road will be nearly 20 feet wide, double its former size, and yet so carefully is the blasting being done that not one out of a dozen of those coming up will notice any change in the rugged grandeur of the pass. The sheer wall at the very gate of the Notch will not be touched. 'Tug-of-war Hill,' which formerly was a terror to autoists, was made easy by order of the State last year, and the work this year will remove the last serious difficulty in the passage of the Notch.

"From the Wiley House to Bemis the road is being widened and the curves straightened, under the supervision of H. S. Mudgett, of the Intervale House, and considerable progress has been made. It is planned to make the road 15 feet wide at the narrowest places and 18 feet wherever it is possible. So much stone has been moved back in widening that the appearance now is of a stone wall on each side of the highway. All of the roads in this section wintered extremely well and are in good condition now. Three automobile parties have been at the Bretton Arms already, and we expect the Albany Automobile Club to be here on June 23 on its annual tour. In riding through the Notch a few days ago we saw a deer standing in the road only a short distance ahead of us."

FROM A TOWN IN NOVA SCOTIA

ANNAPOLIS, N. S., CANADA, June 7—Automobile drivers in this town have agreed to keep their cars off the public highways on Saturdays and Sundays between the hours of 9 A. M. and 5 P. M. This peculiar condition has been brought about through proposed legal action on the part of the municipal council to prohibit the use of automobiles in Yarmouth County on these days between 8 A. M. and midnight, thus giving the autos the right to be used only during the early hours of the morning. Something side-tracked the measure, and to prevent the necessity of an extra session to take up the outstanding measures, the autoists themselves made the agreement. Notices will be posted in the hotels of the county.

AMERICANS TOURING EUROPE IN PLENTY

PARIS, June 3—The rush of American automobile tourists to Europe this year commenced much earlier than usual, and to judge from present indications will be a record one. The tendency of the last two years for automobilists to bring over their own cars is more pronounced than ever, and there will doubtless be few leading American firms that will not be represented by touring parties this summer. The Packard still holds the lead as the American car most generally employed for foreign touring. H. D. Wilson, the European representative of the company, declares that at the end of May he had been in touch with 57 different parties touring Europe in Packard cars, this being a remarkable number when it is considered that the touring season is not supposed to begin until the middle of June. The number, of course, does not include all Packard cars running through Europe, for many of the tourists having no need of either spares or touring information do not report at headquarters. Among those having reported during the past month are two directors of the company—Russell Alger, who has just purchased a Wright aeroplane, and Phillip McMillan; Truman H. Newbury, ex-secretary to the navy; Charles M. Schwab, Thomas Nelson Page, the author; A. S. Carhart, of Tuxedo, and Edgerton Winthrop.

The Pierce agent, N. F. Goodsell, also reports an increased number of visitors to the company's touring bureau in the Avenue de la Grande Armée, Paris. A third American firm to establish an American depot for spare parts and touring information is the Peerless Motor Car Company, whose Paris depot is located at the new American garage in the Rue du Mont Thabor, in the center of the hotel district, in charge of Manager Bousquet. Among the other firms not possessing European touring offices, but whose cars have been reported in the city garages during the past few weeks are White, Locomobile, Thomas and Rambler.

ST. JOHN AUTOISTS ASK CARE IN TOURING

ST. JOHN, N. B., CAN., June 7—Legislation against automobiles has been threatened for some time in New Brunswick, and the New Brunswick Automobile Association has taken steps to prevent the necessity and to quiet any demand for it. The club has issued a circular to be distributed at all ports of entry, so that visiting autoists will have their attention called to the law regarding speed, and especially to the use of caution in passing teams. Trouble has occurred too frequently in the latter case, and is the principal cause for complaint. Furthermore, some advertising will be done in the press, asking that all offenders be reported to the association, and this body will make prompt inquiries, and if necessary prosecute. It is considered that the delays in stopping for teams will not greatly affect tourists, for there are many roads in this province where a car can be driven for 15 or 20 minutes at a time without meeting horses.

At the recent annual meeting of the automobile association it was decided to offer prizes to the three road commissioners effecting the greatest improvements in their respective sections.

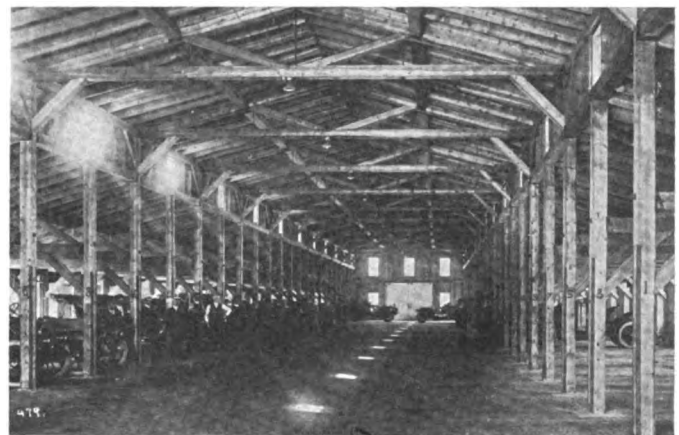

The Commodious Garage of the Mt. Washington Hotel



Manufacturer Crespelle, a Newcomer in the Racing Game, at Wheel of One of His Voiturette Racers

PARIS, June 10—Twenty-three small cars will start in the voiturette race at Boulogne-sur-Mer on Sunday June 20, the only pure speed contest to be held in France this year. For a long time it looked as if the solitary race was doomed to failure, for the entries stood at six for several weeks, and it was only during the three days preceding the final closing that the number was run up to 23. France, England, Belgium and Spain are the countries represented, the first-named having the majority of entries, the others being content with one team each.

Unlike the previous voiturette races in France, one-lunger racers will not be in the majority this year. Lion-Peugeot, whose recent successes at Barcelona and in Sicily have made them the favorites for the Boulogne race, will present two single-cylinder cars and one twin-cylinder. The one-lungers are special productions with a bore of 3.9 inches and a stroke of 10 inches; as on all the special racing cars, they will have enormous valve area, but instead of a single inlet and exhaust, which is apt to give trouble by reason of warping, there will be three of each, operated by an original type of rocker arm. The two-cylinder car has a bore of 3.1 inches and a stroke of 7.8 inches. Although this car has won the two previous races of the year, it is slightly inferior in speed to the one-lungers from the same factory, its victory in Sicily having been due to its companion running out of gasoline, and at Barcelona to the breaking of the road wheels of both its team mates. All three cars develop about 35 horsepower, and can easily maintain a speed of 60 miles an hour on the straight away.

Thomas, the ex-motorcyclist, will handle a Le Gui voiturette with a single-cylinder De Dion motor of 3.9 by 10 inches bore and stroke. Maurice Fournier, younger brother of the better known Henry Fournier, will take the wheel of a Werner fitted with an engine similar to that of the Le Gui. Three Crespelle cars, newcomers to the racing game, will have practically the same power plant. The French firm Alcyon will this year put its faith in four-cylinder cars, having the minimum bore of 2.1-2 inches and the maximum stroke of 5.1-2 inches. The chief driver is Barriaux, an old voiturette hand, with a couple of team mates yet to be chosen. Renault-Schneider, a St. Etienne firm, is an

entirely newcomer to the automobile world, and intends to make its debut on the race track with commercial models of 2.7 and 4 inches bore, which have little chance of winning first prize.

England is represented for the first time in a French voiturette race with three Calthorpe four-cylinder cars of 2.1-2 inches bore by 5.1-10 inches stroke. The engine has its cylinders in a single casting, Hele-Shaw clutch, sliding gear transmission, and final drive by cardan shaft. One of the interesting features is the use of Rudge Whitworth dismountable wheels, very largely employed on the other side of the Channel, but not previously demonstrated on the Continent. Spain sends a full team of four-cylinder cars with engine dimensions 2.1-2 by 5.1-2 bore and stroke. The drivers are Zuccarelli, for a long time Lancia's mechanic; Deryn, an ex-Clement champion, who figured in Paris-Madrid and Paris-Vienna, and Pilliverdie, a newcomer to the game. Belgium has forwarded the engagement of three cars known as the Rif. The firm is recently established, and nothing has yet been made known regarding the car.

The race will be run on a very varied course having grades up to 13 per cent., and measuring 23.3-10 miles round. Ten rounds will be covered without controls.

BRITISH GRAND PRIX VOITURETTES

COVENTRY, ENGLAND, June 8—The three Calthorpe cars which are to be Great Britain's sole representatives in the Grand Prix des Voiturettes have been completed, and road tests have shown that these little vehicles are well able to make a good showing. The engine has four cylinders cast en bloc, the bore being 66 millimeters, with a stroke of 130 millimeters, and no less than 22 B.H.P. was recorded during the bench tests. The Hele-Shaw disc clutch, three-speed gearbox and aluminum rear axle casing follow the lines of the standard Calthorpe voiturette. Rudge-Whitworth detachable wire wheels are fitted and these have proved of special value in enabling the effective gearing of the car to be modified to best advantage by fitting a smaller size. The body is of sheet aluminum and the total weight has been kept below 800 pounds. Until but a few days ago the race

seemed likely to be confined to the Lion-Pugeot and these Calthorpe cars, but it has just been announced that definite entries have been made for teams of Alcyon and Hispano-Suiza cars, both having four-cylinder engines. The contest between the English and Spanish entries will be followed with much interest, as the power plants are practically identical.

AMATEUR RACE AT BROOKLANDS.

LONDON, June 1—The racing of Saturday and yesterday proved to be most interesting and the big fields and close finishes more than compensated for the absence of the high-speed record attempts that had been promised. The 15-horsepower Lancia commenced its successes with the first race, the Regent Cup for cars of under 20-horsepower, R. A. C. rating. For the whole of the nine and one-half miles the Lancia and its rival, the Vauxhall, kept side by side, and the latter was finally beaten by but a couple of yards. The speed average was 62 miles an hour. The Vauxhall regained top place in the next event, the Whitsun Handicap for members of the Brooklands Club. The Lancia was not running, and the Vauxhall had an easy win, an exciting tussle for second taking place between a 20-horsepower Mercedes and a 12-horsepower Sizaire, to the benefit of the latter. Several private matches were followed by a race for Jackson 6-horsepower cars, nine of which faced the starter. The winner averaged 39 miles an hour for the three miles, and the others all finished in a bunch. The invariable closeness of the finishes makes these standard car races very popular.

The May Senior Handicap brought out a curious medley of cars, ranging from a 16-horsepower Argyll to a Mercedes of 120 horsepower and an Itala of equal power—both Grand Prix cars. The first two laps provided ample excitement, albeit the Itala and the 90-horsepower Napier were both out of the race. When the leaders were entering the finishing straight the big Mercedes kept on round the outer course and so lost the race. The Lancia got in first at a speed of 68 miles an hour, while for second place the Iris barely defeated the Vauxhall. The first of the motorcycle races had 27 starters, and the winner, Cook, on a 7-horsepower N. L. G., averaged 68 miles an hour for the six miles. In the other event for these machines a 5-horsepower Indian gave a good race for first place, but was just beaten by a length. An obstacle race for cars, ending with a run up the test hill, completed the day's programme.

On Monday the Vauxhall led off with a win in the May Junior Handicap, the Lancia just 10 yards behind. Next came the Four-Inch race, when the only racing De Dion ever turned out from the Puteaux factory ran in first at 71 miles per hour, the Hutton, which won the Isle of Man race, being second, followed by a Humber and a Darracq. But the event of the day was the

Whitsun Senior Handicap, for which 16 cars turned out. Excitement was aroused at the start and culminated at the finish when the Vauxhall won, not a length ahead of a "Knight" Daimler and a 40-horsepower Napier. The 120 Mercedes did well, averaging nearly 105 miles an hour for the 11 miles, but its handicap was too heavy to be made up.

A novelty was provided in the team race, open to pairs of cars with a total rating of under 60 horsepower. One car of each team ran a circuit, and as soon as the driver had handed a voucher to his team mate, the latter covered a circuit to the finishing post. The winners proved to be a 20-horsepower Nagant and a 40-horsepower Napier.

Finally came the Winners' Handicap, in which all the winners of both days competed, motorcycles and cars together. The smaller machines greatly added to the excitement and a 5-horsepower Indian was just beaten for first place by a 12-horsepower Sizaire car. The next meet will be held on Wednesday, June 30.

AUTOMATIC SPEED ALARMS COMPULSORY

LONDON, June 8—The advent of the legions of motor buses and cabs—there are now over 3,000 of the latter vehicles in London—has greatly increased the dangers of traffic on account of the excessive speeds continually maintained by the drivers. To check this evil the Commissioner of the Metropolitan Police has taken the decisive step of requiring that all public-service motor vehicles be fitted with an automatic device which will give audible warning whenever the speed limit is exceeded. The exact form of the device is left to the judgment of the operating companies, but it must be sealed up out of control of the driver and the warning must be loud and continuous so long as the statutory speed is being exceeded. Unless the combined opposition of the companies causes the withdrawal of this regulation it will come into force on July 1 next.

ENGLAND'S MOTORCYCLE RELIABILITY RUN

LONDON, June 3—The reliability of the modern automobile is fast becoming proverbial, but occasionally the fact is brought home in a special manner. For the sixth annual 24 hours run from London to Edinburgh, which was held last Friday by the Motor Cycling Club, 112 motorcycles and 28 cars were entered. Of the 124 starters no fewer than 113 completed the journey of 400 miles within the 24 hours, while 106 finished in the minimum time of 22 1-2 hours. Thirty-two of the more venturesome, including the only lady competitor, Miss Muriel Hind, started on the return journey after a day's rest. All but one of these finished inside schedule time, so that the task of choosing the winner presents some difficulty to the club officials.

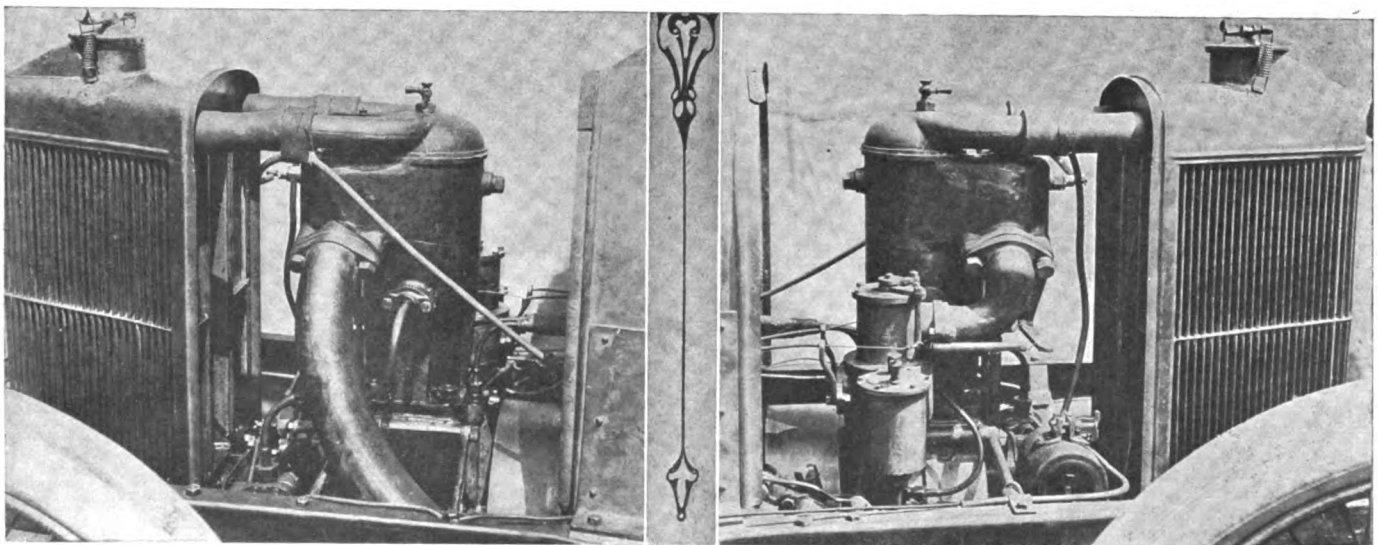

Crespelle Volturette Motor, Seen from Exhaust Side

Intake Side of Crespelle Motor, Showing Magneto



When New York's Orphans Arrived via Automobile at Dreamland, Coney Island—The Fairyland of Young America

NEW YORK'S orphans, nearly 2,400 of them, were on Friday treated to one of those outings which are year-marks in their lives, a real automobile parade, a long ride, and the freedom of the wonders of Dreamland, Coney Island. This fifth annual celebration of the orphans' day, now under the management of a corporation, was the most successful of the quintette of excursions given to the inmates of the charitable institutions of the city, and there were about 150 automobiles in which to entertain them. Rain had caused a postponement of the event from last Wednesday to Friday, but there was no diminution in the interest, either on the part of the small folk or of the donors of the cars, and long before 9 o'clock in the morning the autos were reporting to the headquarters of the committee for orders. The various institutions were then visited



Grand Marshal Owen Leading Procession Down Broadway



The Omnibus Division Was Extremely Popular with Boys

and the loads of happy children brought to the streets near Columbus Circle, where they were marshaled into divisions, and the parade began. After a run through the city streets, the cavalcade wound around the approach to, and then over the new Queensboro Bridge, and on to Coney Island.

Dreamland was thrown open to the two-score hundred orphans and full advantage was taken of the hospitality. Those who were getting their first trip were fully informed by those who have been on hand in previous years, of the delights before them, and they who had taken the trouble to get up the affair were fully repaid by the evident pleasure of their guests. The big dining hall served 2,400 meals, and thereby once more experienced the capacity of the small boy and girl. Three items illustrate that: there were 4,000 oranges supplied, 20 cans of milk were not sufficient, and 3,700 large rolls—really small loaves of bread—were distributed. A substantial meal was served and great amusement was afforded the watchers at the antics of the youngsters. One table was not supplied with tumblers, but there was a decanter of water, and the boys decided that glasses were really not necessary; they stuffed their pockets whenever a chance permitted—that is when another youth was not watching; they vied with each other to see how many bricks of ice cream they could procure, and some little codgers were so anxious to satisfy a healthy appetite that they tried to eat with knives and forks at the same time, thus using both hands.

After lunch the shows were visited, the animals, the shoot-the-shoots, the scenic railway, the Philipinos, and all the other attractions held their attention, and 4 o'clock came all too soon for them. At that hour the autos were again lined up, the confusion settled, and the parade proceeded again to the big city. The police officials were especially efficient, keeping the roads and crossings clear during the passage of the autos, and in many cases facilitating their movement.

The corporation in charge of the orphans' day celebration, known as the Orphans' Day Committee, has as officers: President, Col. K. C. Pardee; vice-president and general manager, W. J. Morgan; treasurer, Richard Newton; secretary, Alex. Schwalbach; grand marshal, Percy Owen. The auxiliary committee, which raised a large amount of money and secured many private cars, is composed of: Mrs. Norwood T. Smith, chairman; Mrs. Thomas Nash, Miss Nash, Mrs. W. A. Alston, Miss A. McIntyre, Mrs. H. Badgley, Miss Howell, Miss Knox and Mrs. E. H. Barrows.

The following cars were represented: Packard, 4; Pierce-Arrow, 4; Stoddard-Dayton, 2; Stearns; Knox, 2; White, 7; De Dion, 2; Plymouth trucks, 3; Frayer-Miller truck; Kissel Kar, 3; Thomas; Manhattan Sight-Seeing cars, 3; Yellow Taxi-

cabs, Wycoff, Church & Partridge, 6; New York Taxicab opera buses, 6; Pullman, 2; Brush; Palmer & Singer; Studebaker, 2; Mercedes, 3; Royal Tourist; Autocar; Berliet; Pope-Hartford; Mora; Cadillac; Maxwell, 7; Rambler, 3; Winton; Alco, 3; Ranier, 3; Matheson; Hotchkiss; Oldsmobile, 6; Selden; Regal; Overland; Lozier; Reo, 2; Atlas; Renault, Stevens-Duryea; National, 2; Franklin, 4; Bianchi; Locomobile; Mitchell; Fifth Avenue Coach Company, 6 busses; Twentieth Century Touring Company, 6 busses; Taxi-Service Company, 5 taxicabs, 3 touring cars; there were other cars which reported at the last minute and were not listed.

QUAKERS TAKE ORPHANS TO WILLOW GROVE

PHILADELPHIA, June 14—Threatening weather came within an ace of spoiling the annual orphans' day run of the Quaker City Motor Club, which had been postponed on account of rain from Wednesday last to the following Friday. At the starting hour, 9 o'clock, there was every indication of rain and another postponement; but Chairman E. H. Lewis decided to take a chance, and won out, as before noon old Sol was doing business in his best midsummer fashion. The lowering clouds, however, reduced the number of cars from the 100 promised to 92. These accommodated upward of 600 little ones, representing 21 institutions, who were given the time of their lives.

Upon arrival at Willow Grove, the children were met by a reception committee of club members and ladies connected with the Quaker City Ladies' Motor Club, who distributed tickets admitting the "kids" to the delights of the park—mountain trip, roller coaster, airship flight, trip to Venice, moving pictures, etc. At one o'clock the little guests were summoned to grove No. 1, where they made partially successful efforts to put away the lunch provided for an even thousand and supplemented by a thousand boxes of candy donated by Mrs. E. D. Kruse.

At three o'clock, Chairman Lewis and his committee began to round up the little ones, who were engaged in "repeating" on the attractions, with the overplus of tickets which had been distributed. Despite the lure of the Midway, the "kiddies" were corraled by four o'clock and all reached their respective institutions an hour later without a single mishap.

The committee had endeavored to induce the turnpike company, owning the road to Willow Grove, to suspend toll collections on all cars carrying orphans, but upon their refusal the *Evening Times* stepped forward with an offer to foot the toll bill, which was gratefully accepted. All told, the day's outing was a happy one, long to be remembered by entertainers and guests.

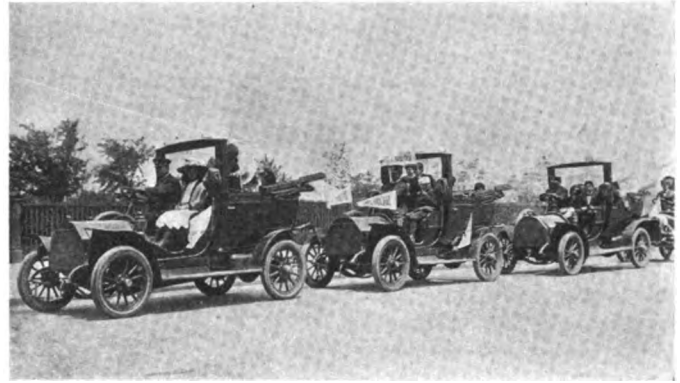

Fleet of Yellow Taxicabs Laden with Youngsters

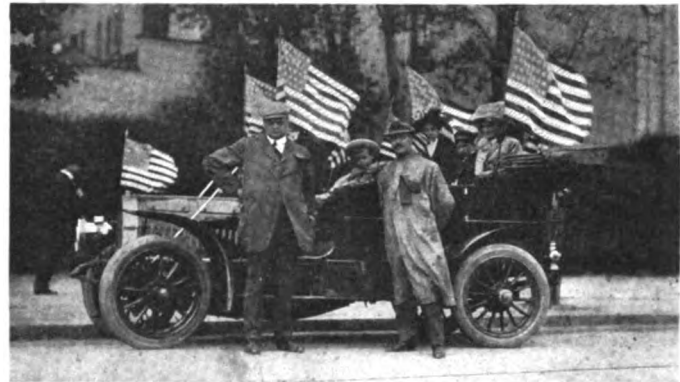

President Webb and Dr. Richardson, L. I. Club Committee

ORPHANS INTEREST WEALTHY BROOKLYNITES

When the Long Island Automobile Club officials in charge of the Orphans' Day celebration interested the wealthy folks of Brooklyn, they did a wise store of business. The result was that instead of a lack of cars and money to further the plans, President Frank G. Webb and Chairman of Outings Dr. William P. Richardson, were put to more trouble in getting the "kids" to forsake Coney Island with its new and wonderful delights, when it came time to go home. The outing was voted a great success by all of the children, so the committee should be well satisfied with the results of their labors. The picture above shows the two officials before the car in which they led the parade.



Crossing the New Queensboro Bridge, That Spans the East River to Long Island City, En Route to Coney Island

BLIND CHILDREN HAVE OUTING IN BOSTON

BOSTON, June 12—The annual outing for blind children given by the Boston Automobile Dealers' Association took place Wednesday and 125 little ones deprived of their sight and pupils at the Perkins Institution for the Blind, in South Boston, and of the Kindergarten for the Blind, in Jamaica Plain, were taken to the Lakeside Home on the shore of Lake Massapoag in Sharon in cars supplied by the local dealers. The Lakeside Home is a charitable institution for children, of which Rev. M. R. Deming is superintendent, and there the children were entertained during the day.

The cars assembled in Copley Square between 9:30 and 9 o'clock, and after picking up the blind children and their teachers and leaders, were driven the ten miles or more through the parkways and boulevards and over excellent country roads to Sharon. After a day spent in out-of-door amusements, the children were returned to their abiding places. Those who supplied cars were: W. H. Jenkins Company, Mitchell; Buick Motor Company, Dodge Motor Vehicle Company, Pope-Hartford Franklin Automobile Company, Winton Motor Carriage Company, J. M. Linscott Company, National; J. W. Bownian Company, Stevens-Duryea; Premier depot, L. B. Butler, Whitten-Gilmore Company, Thomas; Ford Motor Company, F. E. Wing, Marmon; Park Square Auto Station, Stoddard-Dayton; J. H. MacAlman, Stearns; Thomas B. Jeffery & Company, Rambler; Henry H. Pierce, Alvan T. Fuller, Packard truck; the White Company, J. W. Maguire, Pierce; V. A. Charles, Inter-State; K. M. Blake, Locomobile; George H. Lowe, Pennsylvania; Leonard A. Day, W. J. Cooper, William F. Mayo, Frank C. Snyder and Kenneth A. Skinner.

KANSAS CITY'S ORPHANS' DAY PARADE

KANSAS CITY, Mo., June 14—The Automobile Club of Kansas City held its third annual Orphans' Day on June 9. At three o'clock in the afternoon 60 cars laden with 300 orphan children started from Armour boulevard and Broadway for a 30-mile ride out to Swope Park. Following a new departure this year the committee decided to form the parade entirely of cars owned by club members, and was very successful in obtaining the use of enough cars to comfortably seat every one. At the start each one was given a souvenir flag and all of the cars carried pennants. Waving their flags and constantly shouting at every one passing by, the children certainly made the most of their holiday.

This custom of giving the orphan children an outing has become a fixed annual affair here, and will undoubtedly remain so because of its popularity. In addition to its charitable nature, which is in itself sufficient reason, the club derives a certain benefit from it in good will of the community and increase in membership applications.

RAIN INTERFERED AT BALTIMORE

BALTIMORE, June 14—The continual rain of the past week made it necessary for the members of the Automobile Club of Maryland to postpone the orphans' day outing from last Wednesday. In consequence of this enforced action on the part of the club members more than 800 little ones who had looked forward to a pleasant trip through the prettiest sections of the city and suburbs were disappointed. The owners of cars in this city entered into the spirit of the occasion so that nearly two hundred cars were offered for the entertainment of the children at Electric Park. These are still at the disposal of the club when a clear day comes along for the outing.

COLUMBUS ORPHANS WILL BE HAPPY

COLUMBUS, O., June 14—Arrangements have not been completed for the annual orphan's day to be given by the Columbus Ohio Automobile Club, June 19. It will require at least 200 cars to carry the children. Requests have also been made for "goodies" such as candies, peanuts and ice cream.

CONDITIONS IN FRENCH AUTO INDUSTRY

Overproduction, much price cutting, high taxation, liability of arrest, and reduced taxicab charges, are greatly harming the automobile business in France, according to A. E. Schwartz of Paris, foreign representative of the American Motor Car Manufacturers' Association, who is now in this country on a business trip. Mr. Schwartz was impressed with the immensity of the American industry when he arrived a few days ago, and in comparing it with the conditions in France, said:

"There is an enormous difference, for every one here seems busy, whereas in Paris the dealers have to sell sporting goods, bicycles, and other things to pay expenses. There has been a large overproduction of automobiles, and if a European manufacturer were told of the status of the American industry he would be incredulous, and call it a 'bluff.' In France the private purchaser can get the same discount from a maker as the dealer, and therefore the buyers do not deal with agents but go direct to the factory. Another difficulty is with the taxation which requires the payment of five francs (one dollar) for each seat, and five francs for each horsepower, so that if one buys a 30-horsepower car with four seats, the tax is 170 francs; and this must be paid to the State and then to the city, making the charge 340 francs (\$68).

"Coupled with this is the practice of arresting automobilists on the least provocation, such as for smoking when the exhaust is no thicker than that emitted by a pipe or cigar smoker. Then the police try their best to fine for something else at the same time, the result generally being a charge of about 50 francs. These things have hurt the industry. Another matter which has contributed is the reduction of taxicab rates, so that now a cab can be rented for 50 cents an hour, for four people, and many have sold their machines, which they used only in the city, and thereby rid themselves of the bother caused by the police, garages, chauffeurs, and the expense, preferring to use the taxicabs.

"A very interesting fact is the great number of people that have taken up the aeroplane and aerial navigation in general. There is many a man who is and was famously known at the steering wheel of an automobile, who has his little idea up his sleeve for a new device for aeroplanes, and I know of one big accessory store that claims to do more business in supplies for aeroplanes than for automobiles, in the last few years."

N. H. VAN SICKLEN, SR., JOINS BLUE BOOK

The rapidly increasing demand for touring information in all sections of the country has necessitated a larger organization to carry on the work of "The Official Automobile Blue Book," and a new corporation, with largely increased facilities, has been formed under the incorporated name of The Automobile Blue Book Publishing Company.

N. H. Van Sicklen, Sr., former owner of *Motor Age*, and recently Chicago branch manager for the Knox Automobile Company, and one of the most widely known men in the automobile industry, is president of the new corporation, and he, with the former owners of the "Blue Book," will constitute the board of directors. Mr. Van Sicklen will immediately inaugurate a strong campaign for the extension of the "Blue Book's" scope and influence, so as to practically cover the entire United States, Canada, and Mexico. Headquarters will be in New York and Chicago.

"The Official Automobile Blue Book" is now recognized as the standard route book for this country, and under Mr. Van Sicklen's management the new corporation will extend its work to cover every requirement of the automobile tourist.

EX-CHAIRMAN J. D. THOMPSON GOES ABROAD

Jefferson DeMont Thompson, ex-chairman of the A. A. A. racing board and Vanderbilt Cup commission, recently sailed for the other side for a summer vacation in Europe, where he will tour in France, Germany, and Austria.

MODERN FIRE DEPARTMENTS NOW USE AUTOMOBILES

EVEN if the Senate of this great country does not approve of the automobile, it is a fact that its use is not only increasing daily with leaps and bounds, but is fast extending into other fields of endeavor. The strange part of this is that it always makes good, no matter what the use may be.

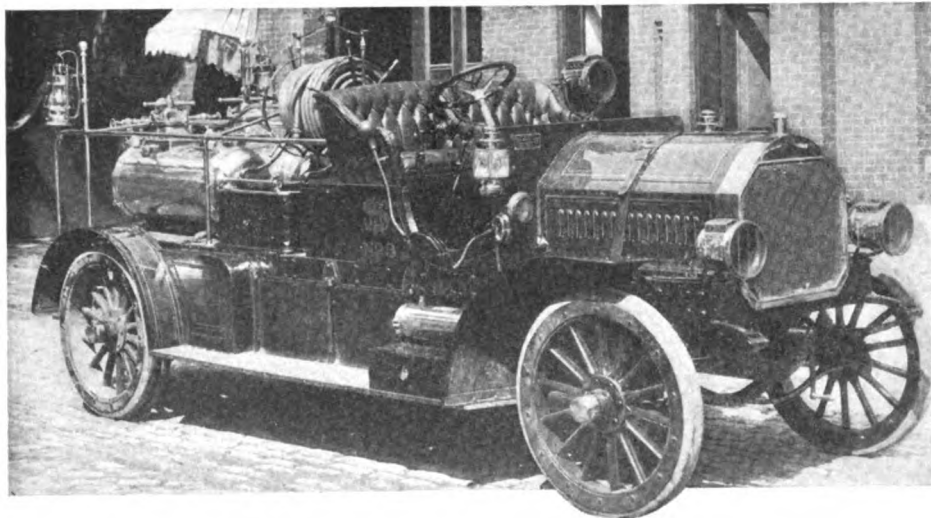

Auto-Car Chemical Truck for Fire Department, Ocean Grove, N. J.

Thus most of the progressive fire companies have tried the self-propelled car, the trial resulting in its adoption. The latest to fall into line is the H. E. Stokes Fire Company No. 3, of Ocean Grove, N. J. This company has just purchased and put into use

a truck of the high-speed type, as manufactured by the Auto-Car Manufacturing Company, of Buffalo, N. Y. The Auto-Car company has been in the commercial car business for many years and its product shows this in the little details. This particular car is powered with a 40-50-horsepower engine, so geared as to allow a speed of 50 miles per hour on the high gear. It is equipped with two 35-gallon tanks, 150 feet of hose and has ample room for 12 to 16 men. The truck was adopted by the hose company after a very severe test, which took the form of a trial run over country roads with a heavy load. The distance was 45 miles, which was covered with a load of 14 firemen, in the excellent time of 53 minutes, or at the rate of 51 miles an hour, thus proving the maker's claim of a speed of 50 miles in the best possible manner. The main object in making the run was to show the great advantage of motor chemical trucks in case help is called for by near-by towns. This truck is one of the first products of the Auto-Car company's new factory, located on Elmwood avenue, Buffalo, which is a very modern commercial car factory, with improved facilities.

The annual output of the company is now about one thousand cars per year, chief among which are numerous machines of the type illustrated and described, the demand for these fire wagons having increased to a wonderful extent in the past few years.

RAMBLER CHASSIS FOR WESTERN FIRE DEPARTMENTS

NOT to be outdone by any of their Eastern rivals, the city authorities of Pomona, Cal., have recently put into commission a chemical fire engine, and so great has been its success in the short time it has seen practical use, that the city of San Diego, not very far from Pomona, is about to construct and put into service a similar outfit. The Pomona car is built upon a Model 45 Rambler chassis, of 45 horsepower. The wheel-base is that of the standard touring car of this model, namely, 124 inches, as the Thomas B. Jeffery Company has never attempted to build commercial cars, although the chassis are finding much favor for this strenuous work. The chemical apparatus, consisting of three large tanks, numerous small tanks for hand use, hose and hose-carrying mechanism were fitted to the chassis in California, upon its arrival there. One of the tanks is located alongside of the driver, in the unoccupied front space, while the others are placed in the back. The hose reel, with a capacity of 150 feet of hose, is placed across the car right back of the driver's seat. The running boards and the remaining space at the back allow standing room for about ten or a dozen

firemen. On the trial trip of the completed car, a fire was reached within two minutes of the sounding of the alarm, thus showing plainly the large improvement in the speed of the service over the previous horse-drawn wagons.

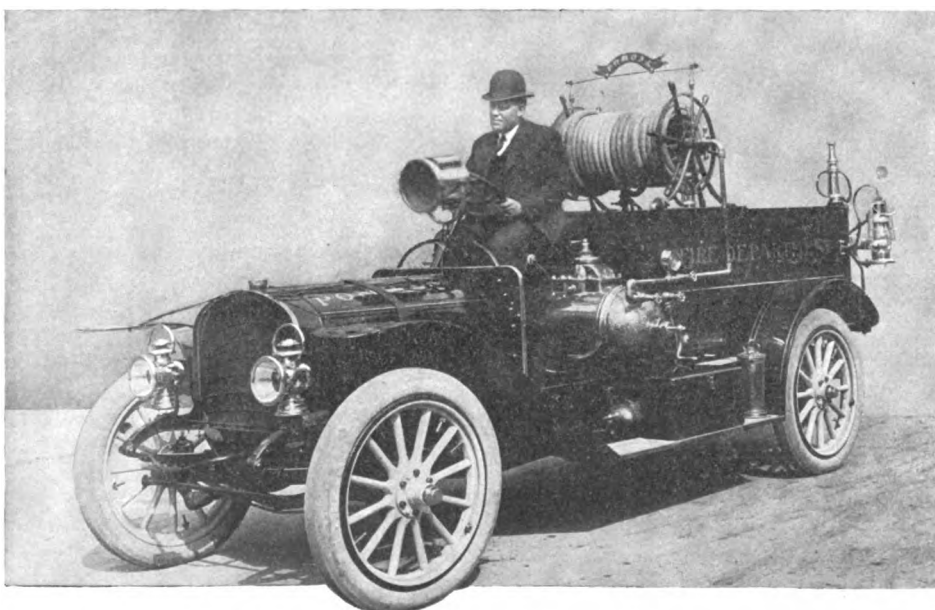

Rambler Chassis with Home-built Body in Service of Pomona, Cal., Fire Department

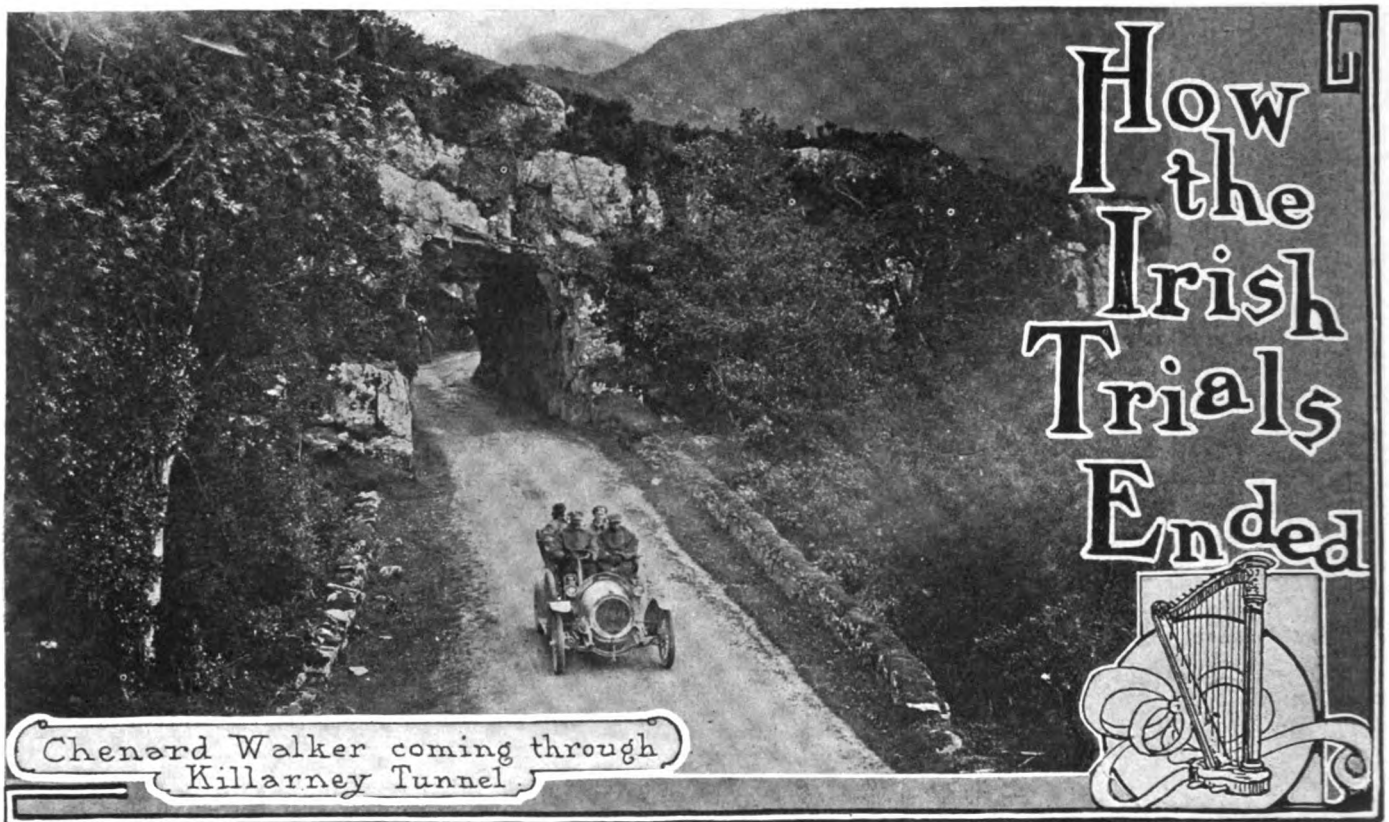

Chenard Walker coming through Killarney Tunnel.

DUBLIN, June 2—When the contesting cars in the Irish Reliability Trials reached Dublin, at the finish of the week's work, for it was real work, there were but twenty of the fifty-two starters left with perfect scores. Among these, distributed over eight classes, with but three exceptions the winning cars in the hill climbing contests were noticeably absent. Of the three classes one of them had but a single car, so there was no competition. There remained, then, but two cars, which won all three of the hill climbing contests and scored perfect for the six days of running over the miserable Irish roads, thus bringing out the lesson of the tour, namely, that hill climbers are seldom reliability winners, and vice versa, reliability winners do not usually take the prize for hill climbing.

These two exceptions were the 12-horsepower Riley in class C, for cars from £150 to £250 (\$750-\$1,250), and the 16-horsepower Humber in class D for cars costing under £350 (\$1,750). Notable among this list of absentees from the perfect score survivors were the 25 Talbot and the 24 Vauxhall in class F. The former had clutch trouble from the start, but made the fastest time up Greenan's Hill and Farmer's Bridge Hill, while the latter outdid the other fifty cars on Magilligan Strand. Of the remaining seventeen perfect score cars but two did anything worthy of mention in the speed tests and hill climbing.

Beginning on the first day and continuing throughout the trial, there were cars in trouble at all times. The miserable Irish roads tested the frames and running gear to the limit, and those contestants who had not made adequate provision for the worst test that the car would ever experience, were soon to be found strung along the roadside, working on some sprung or broken parts. The springs, propeller shaft, fuel systems, and lubrication troubles caused the greatest number of victims.

Thus, the 15-horsepower Mass had spring trouble continuously, proving that the springing of this car was not adapted to this kind of country. On the first day a broken spring held the car and crew for 19 minutes, which penalty was increased by 55 minutes more on Saturday, when another spring failed. Later the crew of this car received and placed on it another full set of springs.

This and the large amount of shaft trouble showed more than

words the roads. On the third day out, just beyond Westport, the 15-18 Bedford broke its propeller shaft and withdrew from the contest. Next day, within four miles of each other, the two Chenard-Walckers broke their propeller shafts crossing culverts, with which this day's trip was replete. This was very unfortunate, for at the time of the accident both cars were running very regularly and both had perfect scores.

Taking the tour as it went, from day to day, there were an average of five cars per day put out of the non-stop division, up to the last day, when the only cars to have trouble were the 12-horsepower Star and the 14-16 Motobloc. The former had a leaking gasoline cock, which allowed the fuel to waste away, necessitating a renewal from an unsealed can, this day's run being made a fuel consumption test with measured quantities of gasoline. The Motobloc had the same kind of a loss, breaking its gasoline pipe, which accident cost 19 points penalty.

Arriving at Dublin each car's tank was emptied and the amount of spirit remaining carefully measured, this amount being entered upon the official records. As this gasoline consumption has not yet been announced, and will not be for some time, it is impossible to state finally which car or cars have won the contest, if there be any winner, or which stands highest in the classes.

The following list, however, subject to official verification, gives the list of perfect scores made. It now appears as if the Dunlop Cup for the best performance of a team of cars will have been gained by the Humber cars, with the American-made Cadillacs or the Stars in second place.

Class A (price not exceeding £150 or \$750), 15-horsepower Bedford.

Class B (price £150 to £200 or \$750 to \$1,000), 8-horsepower Riley and 10-horsepower Riley.

Class C (price £150 to £250 or \$750 to \$1,250), 10-horsepower Humber, 12-horsepower Riley and 12-horsepower Star.

Class C 1 (£200 to £260, two-seated bodies), 12-horsepower Marlborough.

Class D (under £350), 15-horsepower Marlborough, 16-horsepower Humber, 30-horsepower Cadillac, 30-horsepower Cadillac, 15-horsepower Rover, 15-horsepower Straker-Squire and 16-horsepower Humber.

Class E (£350 to £450), 15-horsepower Deasy, 20-horsepower Vauxhall and 20-horsepower Vauxhall.

Class F (£450 to £550), 18-horsepower British Gladiator, 20-horsepower Sunbeam.

Class G (£550 to £700), 40-horsepower Gladiator.

In many senses the Trial was the most severe held so far, and as will be seen from what has been said, although the casualties have not been done in detail, it has been somewhat remarkable for the number of entries (and starters) among the higher grade cars. Not all of these came through the trial well, as many had very noticeable hard luck. Then, too, the lesser known cars came out in force, and many of them did surprisingly well, as witness the smaller Marlboroughs, the little Rileys, and the Little Britons. It is to be regretted that the final and official results of the fuel consumption tests of the last day are not known, so that the contest as a whole would be settled and consequent deductions drawn from the results.

One of the biggest surprises of the week, which has occasioned comment ever since as well, was the excellent performance of the 40-50 Gladiator, the highest powered and heaviest car in the list. The weight was well over two tons and the car stood right up in the van every day despite this. The double distinction of weight and power, coupled with the fact that it was alone in the highest priced class drew attention to the car at the outset, which was sustained later by its daily performances.

DIRIGIBLE AIRSHIPS OF FRANCE

PARIS, June 10—Orders have been given for the French dirigible balloon *Lebaudy* to be put to a series of gruelling tests. The airship, which was built in 1904, is to be put on active service and tested to its utmost limit, moving about with the troops and camping in the open air each night, its crew camping out with it.

M. Gustave Clement, the owner of the Bayard-Clement airship, has had a dirigible balloon shed built on a corner of the Issy-les-Moulineaux aeroplane ground in the neighborhood of Paris. This will give him a spot in which to house his airship after a journey from his country residence to Paris.

RACING AUTOISTS TAKE TO AERONAUTICS

PARIS, June 10—The automobile race movement, as it was known in Europe three or four years ago, having now become a thing of the past, crack race drivers are turning their attention to the aeroplane and seeking to qualify for positions as aerial racers. Although Henry Farman, the chief of the French aeroplane pilots, has not taken part in any important automobile race, he figured nevertheless somewhat prominently in the early automobile movement. His brother, Maurice, drove in big automobile races as late as last year, and is now experimenting with aeroplanes. Henry Fournier, a veteran of the automobile movement, and who has taken part in more international pure speed events than probably any other man, is already devoting his attention to the selling of aeroplanes, and has contracted for a large portion of the Voisin output this year. Further, he has had a machine built for his own use and, driven by a four-cylinder Itala motor, intends soon to make his first flights.

Baron de Caters, a distinguished figure during the race period from 1899 to 1905, when gentlemen race drivers were more prominent than professional chauffeurs, is a qualified aeroplane pilot, having made a number of very successful flights on a Voisin machine. Rougier, for many years a Dietrich race driver, and now interested in the sale of this car, has purchased an aeroplane and intends to take part in all open contests with it. His teammate, Arthur Duray, who, though a Belgian, first saw light in New York City, is also interested in the construction of an aeroplane, and may be expected to be heard of in the air very shortly. Victor Demogeot, the genial busy Frenchman, who has some fine records to his credit on Ormond-Daytona beach, is about to graduate from the automobile to the aeroplane, and will doubtless very shortly be announced as the pilot and demonstrator for a French company having a license to build Wright flyers. There are a score of others, who have been more or less prominent in the automobile racing movement, who are merely waiting the opportunity to take the wheel of an aerial racer.

Captain Hugh L. Willoughby, well-known in yachting circles, states that he is building an aeroplane in Florida.



Where Luncheon was served at
Abbeyleix.



Vol. XX. Thursday, June 17, 1909 No. 24

THE CLASS JOURNAL COMPANY

H. M. SWETLAND, President
A. B. SWETLAND, Business Manager
231-241 West 39th Street, New York City

EDITORIAL DEPARTMENT

A. G. BATCHELDER, Managing Editor
R. F. KELSEY, Associate Editor
THOS. J. FAY MORRIS A. HALL W. McK. WHITE D. R. HOBART
W. F. BRADLEY, Foreign Representative

ADVERTISING DEPARTMENT

M. C. ROBBINS, Manager LOUIS R. SMITH, New York
W. I. RALPH, 1035 Old South Bldg., Boston FRANK B. BARNETT, Cleveland
C. H. GURNETT, 1200 Michigan Ave., H. H. GILL, Detroit
F. W. VAN SICKLEN, Chicago T. B. VAN ALSTYNE, Philadelphia

Cable Address - - - - - Autoland, New York
Long Distance Telephone - - - - - 2046 Bryant, New York

SUBSCRIPTION RATES:

United States and Mexico - - - - - One Year, \$3.00
Other Countries in Postal Union, including Canada - - - - - One Year, 5.00
To Subscribers—Do not send money by ordinary mail. Remit by Draft,
Post-Office or Express Money Order, or Register your letter.

FOREIGN SUBSCRIPTION AGENTS:

ENGLAND:—W. H. Smith & Sons, Ltd., 186 Strand, London, W. C., and all book-
stalls and agencies in Great Britain; also in Paris at 248 Rue de Rivoli.
FRANCE:—L. Baudry de Saunier, offices of "Omnia," 20 Rue Duret, Avenue
de la Grande Armee, Paris.
GERMANY:—A. Seydel, Mohrenstrasse 9, Berlin.

Entered at New York, N. Y., as second-class matter.
The Automobile is a consolidation of The Automobile (monthly) and the Motor
Review (weekly), May, 1902, Dealer and Repairman (monthly), October, 1903,
and the Automobile Magazine (monthly), July, 1907.

WHY NOT AMERICAN WIRE WHEELS?

The unusual and continued success of the wire wheel on the other side, particularly in England, where they are much in vogue, draws attention to the fact that practically none is used in this country, the only maker having "stuck" to them in the past having now changed so as to offer wood as an option.

What is the reason for this apparent apathy on the part of the American public, always so attentive to foreign successes, toward the wire wheels? It is urged in their favor that they possess extreme light weight and much strength; in fact, weight for weight, it is possible to carry a much greater weight upon wheels of this type. Now the modern tendency is substantially toward the smaller car, with less carrying capacity, and, of course, light weight. Fuel consumption is becoming of much more importance each season, and increased useless weight means higher fuel consumption, without a doubt. Why, then, do not many of us arrive ultimately at the two-cylinder car with vertical motor of about 12-horsepower, selling below \$1,000, and fitted with wire wheels?

Surely, if a car weighing perhaps 5,000 pounds and equipped with a motor of 75-horsepower, like the Napier, can go through season after season, on wire spoked wheels, without serious trouble, the efficiency and durability of this form cannot be questioned.

It is urged against the wire wheels that they have no

strength to resist side strains, yet the little Cameron racer at the Savannah races last Fall stood practically upon two wheels with the other two in the air, while going along at the rate of sixty miles per hour, without any damage whatever, which does not sound very weak.

In England, where they attain their greatest popularity, a new detachable wire wheel has just been brought out, which seems to make that form even more popular than at present, if that is possible. Yet England is a great country for little and economical cars of 10 to 15-horsepower. If this form of wheel wears out as quickly as claimed, why is it that so many of the economically inclined Englishmen use that form?

Wood wheels have been the subject of study for perhaps one hundred years, and by a gradual process of elimination the faults have been reduced to a minimum. The so-called bicycle wheels, on the other hand, have been in existence not over one-fourth of that time. Who shall attempt to say, then, that with equal attention to materials, design, and construction, the wire form may not retrieve all of the faults laid at its door and become as efficient and as popular as its competitor, the older form?

One large item even now worthy of consideration is the great and growing trouble of obtaining suitable materials for the spokes and felloes of the usual artillery wheel. With wire, on the other hand, there probably never will be a scarcity of proper materials.



IN ORDER TO OBTAIN WINNERS

Never before have motor-driven vehicles been subjected to such vigorous and searching examinations as are now taking place throughout the entire country. Contests are scheduled in all sections, and rules have been originated for the sole purpose of reducing the field to a single winner in a class. Frequently even this fails to bring about an almost solitary survivor, and ties are not unknown in events calling for microscopic technical requirements. Mayhaps the officials are too insistent.

Coincident with the difficulty encountered in securing an elimination process that shall insure winners is the furtherance of knowledge on the part of the general public, which is rapidly learning to discriminate between demerit marks indicating faulty construction and those so minor in character as not to be entitled to any consideration in passing upon the reliability of an automobile. It is becoming generally recognized that the most minute attention in the compilation of rules is a necessity in encouraging competition, for the reason that tied scores bring about much dissatisfaction, and are naturally embarrassing to the promoting bodies in disposing of the prizes.

Hence, those concerns which in the past may have refrained from competition need not worry themselves in the least through fear of demerit marks which might interfere with sales. The average buyer now understands, and whether a car wins or loses the mere participation in the contest itself is an excellent recommendation as an indication of perfect willingness to try reliability with rival makes.

Judging from the generous entry lists, the agents are of the belief that contests aid in making a car known, besides assisting in accentuating and arousing widespread interest. Events indicate progress and prosperity.

HOW THEY WILL START IN CHICAGO RACES

CHICAGO, June 14—What was really the first official action following all the preliminary work leading up to the big road races took place on Friday last in front of the press stand of the Crown Point course. It had been proposed that the drawing should be by entrants rather than individuals, which meant that a concern with three cars should draw three numbers at one time, and the three cars be spread automatically down the list, and thus separated.

But Robertson and Strang objected. They pointed out that Savannah was the only one that had done it that way; that the Vanderbilt left it to individual drawing and that they preferred the Vanderbilt method. Willing to oblige, General Executive Trego left it to a vote and the vote favored Robertson and Strang. It was decided that the order of drawing should be by order of entering, which gave the Moon first draw in the Indiana trophy and the Buick first in the Cobe cup. Herewith is the result of the drawing:

COBE CUP		
No.	Car	Driver
1	Stoddard-Dayton	B. Miller.
2	Knox	W. Bourque.
3	Apperson	J. Seymour.
4	Bulck	L. Strang.
5	Stoddard-Dayton	C. Englebeck.
6	Locomobile	J. Florida.
7	Knox	A. Denison.
8	Apperson	H. Lytle.
9	Locomobile	G. Robertson.
10	Bulck	L. Chevrolet.
11	Flat	E. Hearne.
12	Bulck	R. Burman.

INDIANA TROPHY		
No.	Car	Driver
1	Corbin	A. Maisonville.
2	Bulck	R. Burman.
3	Marlon	H. Stutz.
4	Ford	G. Dunnell.
5	Chalmers-Detroit	W. Knipper.
6	Marlon	A. Monson.
7	Locomobile	J. Florida.
8	Bulck	G. DeWitt.
9	Fal-car	W. H. Pearce.
10	Locomobile	G. Robertson.
11	Moon	Phil Wells.
12	Renault	A. Greiner.
14	Bulck	L. Strang.
15	Fal-car	J. Ruehl.
16	Stoddard-Dayton	F. Wiseman.
17	Chalmers-Detroit	Al Poole.
18	Stoddard-Dayton	C. Wright.
19	Chalmers-Detroit	J. Matson.

General Executive Trego moved his headquarters to Crown Point on the same day as the drawing, the Sheriff having given up his office in the county building to the road race official. Trego took possession and at once started to tackle the mass of details that confronted him. He heard the report of the surveyor who chained the course for the purpose of knowing exactly the distance around the circuit. It had been odometered at 23.6, and that distance had been used in talking of the race. But the steel tape told another story and reduced the distance materially. It showed the course to be exactly 23.27424 around, which, therefore, will make the little race 232.74 miles in length instead of 236, and reduces the Cobe cup from 402 to 395.66.

Plans for the ambulance service have been completed, two ambulances having been proffered for the work. One of them is a White steamer ambulance belonging to F. F. Roberts, a north side undertaker, who has agreed to equip it with a doctor and nurse. The other car also is a White steamer and is a combination touring car and ambulance, the idea of James E. Plew, of the White Company's Chicago branch. Ordinarily a touring car, the backs of the front seat fold backward, which makes either one or two comfortable cots in the tonneau.

A camp for the officials has been established, a unique idea that has been brought about by the skimpy hotel accommodations. The camp is located on the big 80-acre lot where the soldiers will pitch their encampment. Oliver G. Temme, bearing the high-sounding title of commissary general, is in charge of the officials' camp, and he has prepared accommodations for eighty, which will include forty of the flagmen who are working under

the direction of Frank B. Wood. Tents galore have been erected, cooks and other servants hired and for the rest of the week the officials will live in comparative luxury while others are scouting around for sleeping and eating accommodations.

Eighty flagmen are being used for guarding the roads during the practice, which began Monday afternoon, forty of whom are students from the Chicago School of Motoring. It was found necessary to do the practicing in the afternoon because of the fact that the farmers of Lake County do a big milk business and they objected to closing the roads in the early morning, as is done in the Vanderbilt. They also objected to permitting the practicing to begin on Thursday as originally scheduled, so the general executive issued the edict that not until Monday would the flagging service be instituted. This, however, did not prevent the drivers from becoming busy in the early morning hours, although they were somewhat handicapped by having to go slowly through both Crown Point and Lowell. Also the road was not completed all the way around, so this practice was generally unsatisfactory, although it did permit the drivers to study the road and be in a position to take advantage of this knowledge when they were turned loose and permitted to burn it. Arthur Greiner, the one amateur entrant, was denied this by a turn of hard luck. Just as he was preparing to move to his camp he was stricken with a touch of malaria, which forced him to go to the hospital instead of Crown Point, and for several days he chafed and worried while his rivals were stealing a march on him. Greiner was further handicapped by his unfamiliarity with the Renault which he is to drive. He got it only for this race and up to the time he went to the hospital he had not had a chance to drive it.

Officials chosen for the race show that the Chicagoans have endeavored to get the best talent possible. They selected Asa Paine, of Minneapolis, for referee, and Fred J. Wagner, of New York, for starter. Then they picked a home man for clerk of the course, Charles P. Root; Boston was called upon to furnish the chief timer, sending Harry Knights, whose reputation at this sort of work is national. The judges include John Farson, John C. Eastman and Fred D. Countiss, of Chicago; H. O. Smith, of Indianapolis; Judge W. C. McMahon, of Crown Point, Ind., and Judge V. S. Reiter, of Hammond, Ind. Frank B. Wood, of Elgin, Ill., is chief flagman, and "Bick" Edwards, of Chicago, has been given charge of the electric timing apparatus. The commissary general is Oliver G. Temme, of Chicago, who will have a competent staff of assistants.

WHITE IN GLIDDEN TO USE KEROSENE

The 40-horsepower White steamer which has been entered for the Glidden tour will make the 2,500-mile trip using kerosene as fuel instead of gasoline. This will be the first extensive public performance, either in this country or abroad, by a car using any fuel other than gasoline, and for that reason the progress of the car from day to day will be watched with unusual interest. The fact that this will be the only car entered by the White Company makes it evident that the company has the most complete confidence in the new kerosene burner and do not anticipate that any penalizations will result through the use of this new fuel. It might even happen that the supplies of gasoline shipped ahead for the use of the contestants on the tour will prove inadequate, in which case the White would have a decided advantage, as it could procure a supply of kerosene at any cross-roads store or at almost any farm house. It is also evident that the cost of the fuel for the White throughout the trip will be considerably less than for any other machine. The car will be driven by H. N. Searles, who for two years was enrolled in the United States Secret Service and had charge of President Roosevelt's White cars at Oyster Bay.

CLEVELAND GETS A. A. A. GOOD ROADS CONVENTION

TWENTY-FIVE directors of the A. A. A. were in New York City last week attending the quarterly meeting of the association, held Thursday at the national headquarters, 437 Fifth avenue.

President Lewis R. Speare, of Boston, and several other directors remained until Friday morning to perfect some details in connection with the work of the various national boards. In speaking of the work accomplished President Speare laid especial emphasis upon the new racing and contest rules, presented by Chairman Hower of the contest board, which were unanimously approved, and the action taken to discourage the formation of purely promoters' automobile clubs, organized chiefly to hold race meets. It was resolved that hereafter the half rate price for sanctions to conduct meets allowed to clubs in the A. A. A. should not be granted to clubs which have not held A. A. A. membership for at least ninety days. The sentiment of the association's executive officers was very forcibly expressed to forestall race meets by "short-term" clubs in the future.

The new racing and contest rules drafted by the contest board and its advisory committee, composed of representatives of the manufacturers, will be printed and issued at once from Chairman Hower's office at Buffalo. Mr. Hower stated that thirty-two entries had been received for the Glidden Tour, and he told of the widespread interest that has been aroused in this year's event.

The Arkansas State Automobile Association was elected to membership, giving the national association its thirtieth affiliated State body. This association comprises clubs in Little Rock, Hot Springs and Fort Smith.

J. O. Heinze of the Lowell (Mass.) Automobile Club, T. Ed. Bryan of the Tampa (Fla.) Automobile Club, and A. J. Yeager of the Juniata Valley Motor Club, Lewistown, Pa., were elected directors.

A report was filed by Chairman Terry of the Legislative board regarding the work accomplished in many States, and interesting reports were also made by Chairman Diehl of the good roads board and Chairman Evans of the touring information board. Chairman Evans indicated that the activities of the touring information board had outgrown its present headquarters, and at his suggestion the president was authorized to appoint a committee to formulate plans for conducting the work of the board on a broader scale, and arranging for larger headquarters.

Chairman Terry of the committee on resolutions presented the resolutions indicative of the association's appreciation of the long continued interest and splendid service rendered by its former

president, William H. Hotchkiss. The appointment by Chairman Hower, of T. A. Wright of Wilkes-Barre, Pa., and S. B. Stevens of Rome, N. Y., as members of the contest board was approved.

The members present at the meeting were:

President Lewis R. Speare, Boston; Frank B. Hower, Buffalo, chairman contest board; Powell Evans, Philadelphia, chairman touring information board; George C. Diehl, Buffalo, chairman good roads board; Charles Thaddeus Terry, New York, chairman Legislative board; E. P. Chalfant, representing A. L. A. M.; Treasurer H. A. Bormell of New Jersey; Frank G. Webb, president Long Island Automobile Club; Robert P. Hooper, president Pennsylvania Motor Federation; O. A. Quayle, Albany; W. L. Brown, Syracuse; John O. Heinze, Lowell, Mass.; Dr. J. N. Faulkner, Paterson, N. J.; L. J. Powers, Jr., Springfield, Mass.; H. L. Hammersly, Wildwood, N. J.; S. Boyer Davis, secretary Automobile Club of Philadelphia; George A. Post, Paterson, N. J.; George H. Waters, Richmond County Automobile Club; Harlan W. Whipple, of New York; J. I. Wakelee, Englewood, N. J.; B. W. Nostrand, Peekskill, N. Y.; A. G. Batchelder, New York; W. O. Griffith, secretary touring information board; C. H. Gillette of Hartford, and Secretary Frederick H. Elliott.

A. A. A. Good Roads Convention in Cleveland

A meeting of the national convention committee followed the directors' meeting, and it was unanimously decided to hold the "Second Annual Good Roads Convention" in the city of Cleveland during the last week of September. It was announced that George C. Diehl of Buffalo, chairman of this committee, and Secretary F. H. Elliott will shortly visit Cleveland, and while there confer with the officers of the Ohio State Automobile Association and the Cleveland Automobile Club relative to the naming of committees to take charge of the local work and make other arrangements for the holding of the convention.

Next Meeting of Directors in Detroit

It was decided to hold the next meeting of the A. A. A. executive committee in Detroit, Saturday, July 10, and upon the motion of President Speare the directors will be invited to attend the meeting. The association's officers will be guests at the banquet to be given on that evening by the automobile manufacturers of Detroit and will be guests at the Automobile Club of Detroit on Sunday and witness the start of the Glidden Tour on the 12th.

WISCONSIN GETS BETTER LAW

MILWAUKEE, June 14—The Wisconsin legislature has passed the Page bill, but amendments adopted at the last minute ruined the intent of the bill as desired by the combined clubs and associations of Wisconsin in eliminating the speed limit and making reckless driving under the circumstances a misdemeanor. The assembly amendment places a speed limit of 18 miles in cities and 25 miles in the country districts into the bill. The senate passed the bill as drawn, but in the assembly the rural members expressed the opinion that there was a "joker" somewhere in the elimination of the speed limit. The new speed limits are an improvement over the old provisions, which were: In cities, 12 miles, and country districts, 18 miles. The clubs are taking the compromise with good grace, as the opposition developing in the assembly was not unexpected. The Page bill also provides that no person under 16 years of age may operate a machine unless accompanied by a parent or guardian, and makes parties who fail to stop and offer assistance to any person injured guilty of a misdemeanor. It also raises the license of registration fee from \$1 to \$2 and abolishes transfers.

A HUSTLING SOUTH CAROLINA CITY

SPARTANBURG, S. C., June 14—In view of the proposed New York *Herald-Atlanta Journal* tour this fall from New York to Atlanta, a joint committee from the Greenville and Spartanburg Automobile Clubs, consisting of Thomas F. Parker, chairman, and W. J. Thackston, of Greenville; V. M. Montgomery and Fred L. Bryant, secretary, of Spartanburg, and Frank Burgess, of Greers, was appointed to aid in the selection of the route through this section. The appointment of this committee was the result of a joint meeting, held recently in Greenville, which was attended by members of the Greenville Automobile Club, the Greenville Board of Trade, the Greenville county commissioners, committees from the Spartanburg Automobile Club, the Spartanburg Chamber of Commerce, the Spartanburg county commissioners, and a delegation of citizens from Greers. At this meeting there was much enthusiasm for the proposed tour, the county commissioners of both counties expressing their determination to put the roads in excellent condition before the time scheduled for the tour. While the routes are not definitely settled, each county will endeavor to have its best road used.

FAIRMOUNT PARK'S STOCK CAR RACE IN OCTOBER

PHILADELPHIA, June 14—At a meeting of the contest committee of the Quaker City Motor Club last week, it was voted, on the suggestion of Secretary Harbach, to devote the net proceeds from next October's 200-mile stock chassis race in Fairmount Park, to charity. To what particular purpose the funds so raised shall be devoted, will be decided upon at a subsequent meeting. Secretary Harbach has figured it out that if the sale of grand stand seats and parking spaces be placed in the hands of a committee of prominent society people, such as manage the annual charity ball, for instance, the proceeds of the race would reach \$15,000 or \$20,000. It was suggested that if the beneficiary selected should be the anti-tuberculosis league, the spectators, who would flock to the course by hundreds of thousands, as they did last year, would help along the fund by voluntary contribu-

tions, which, though small in themselves, would aggregate a substantial total. Collectors' booths, placed at each of the many entrances to the park, would attract the nickles, dimes, quarers and dollars of the public. Such is Secretary Harbach's idea.

The grand stand, which could be made as large as circumstances warranted, could be made to bring in at least half the large total mentioned, while the parking spaces would also sell for a substantial total, and the entrance fee could be placed at a figure which would insure handsome returns.

Given clear weather and a course patrolled and protected in the admirable manner which set a national standard for such affairs last year, and Quaker City society would put the seal of its approval on the affair, which would insure the race becoming an annual fixture.

NEWARK CLUB PLANS 1,000-MILE RACE

NEWARK, N. J., June 14—It is just barely possible that rivalry growing out of a tie in an endurance contest, and followed by a friendly challenge, may grow into a great big race of perhaps a thousand miles in length and appropriately staged by the New Jersey Automobile and Motor Club.

In the recent endurance run of the Mercer County Automobile Club at Trenton, both the Mercer, which is made in Trenton, and the Overland cars tied with perfect scores. The result of this was an extra run to determine the real winner. Not only was this not satisfactory to the car entrants and drivers, but it resulted in a challenge being sent and accepted.

The matter was laid before the board of trustees of the New Jersey Club at a monthly meeting, the upshot of which was that the contest committee was given power to act. Their first act was an application for a sanction from the A. A. A., and the second the selection and reservation of the mile race track at Long Beach. The date for the big event has not been settled definitely, but will be some time late in July or early in August, beginning on a Friday and continuing through to Saturday. On Saturday another track event, probably at ten or twenty-five miles or both, will be sandwiched in.

If the race is held at Long Branch, which now seems likely, the club will schedule a club run to the shore resort at that time, which will doubtless insure the success of the track race.

A 24-HOUR RACE AT BENNING

BALTIMORE, June 14—A 24-hour race meet will be conducted under the auspices of the Maryland Motor Car Racing Association July 16 and 17 on the mile circular track at Benning, D. C. The event will be a twin city affair for the automobilists of this city and Washington.

The opening events will consist of two 5-mile, two 10-mile and two 25-mile races for stock cars. The 24-hour grind will start at half past eight o'clock, Friday night, and will be for stock cars of every description, both American and foreign make. This will be the first event of the kind held in this section of the country and the promoters believe that it is just the style of test that the people here are anxious for.

VICE-PRESIDENT SHERMAN WILL SET TIME

WASHINGTON, D. C., June 14—A sociability run to be given by the *Washington Times* on June 19 bids fair to be one of the most successful automobile affairs ever held in the national capital. The run will be to Great Falls, a picturesque spot on the upper Potomac River, which is reached via the famous conduit road. Secret time for making the trip will be set by Vice-President Sherman, who has frequently made the trip in his Peerless.

WHERE TRACK SPORT ATTRACTS

MONTREAL, June 14—Official announcement is made of the second annual automobile races under the auspices of the Automobile Club of Canada. The races will take place at Blue Bonnets race course, July 9 and 10, and the committee in charge of the races will at once complete arrangements to bring on the greatest auto racers the world has yet produced, including Christie, De Palma, Burman, Strang, Robertson, and others. A feature of this year's races will be the new car of Walter Christie, which he claims will smash all records. The car is 160-horsepower and has attained a speed of one mile in 27 seconds. Negotiations are being carried on to have F. J. Wagner, the starter of all the famous meets in America, including the Vanderbilt Cup races, to start the races here. The club is also endeavoring to secure an aeroplane, which will give demonstrations during each day of the races.

The committee appointed in charge of the races is: Clarence F. Smith, chairman; F. H. Anson, William Carruthers, and George A. McNamee, secretary-treasurer.

ATLANTA A MECCA NEXT NOVEMBER

SAVANNAH, GA., June 15—Having been obliged to postpone its three-day automobile race meet, Fitzgerald is now getting ready to have an endurance run to Atlanta, which will probably be held just before the opening of the automobile show in that city in November. The city has put up the sum of \$1,000, to be awarded in the following manner to "best cars" and the "best roads": Five hundred dollars for the county offering the best roads between Fitzgerald and Atlanta, via Macon; \$300 for the automobile making the best time during the run, and \$200 to the second best.

Other cities that will have runs to Atlanta in November are: Albany, McRea, Dublin, and Savannah. Savannah has already offered \$1,000 in cash prizes, and it is possible that each of the other cities will offer the same amount.

109 CONTESTANTS IN PRINCE HENRY TOUR

BERLIN, June 10—The contestants in the Prince Henry of Prussia automobile competition, which is being conducted under touring conditions, got away at five o'clock this morning from the Tempelhof road. One hundred and nine machines started at intervals of one minute.

Prince Henry came to the starting place in an automobile from Kiel. He did not remain, but went on to Gueben to observe the speed of the contestants on the way to Krossen. The entire course is 1,132 miles and will be covered in six stages. The stopping places are Breslau, Tatra, Budapest, Vienna, Salsburg and Munich.

NEW AUTOMOBILE CONCERN STARTS IN YORK

YORK, PA., June 14—Under the trade name of the Kline Kar, a new automobile will be produced in this city, manufactured by the B. C. K. Motor Car Company, the initials standing for Bailey, Carroll, and Kline. Application has been made for incorporation papers, naming the following as incorporators: S. E. Bailey, president, of Philadelphia, and of the York Carriage Company; vice-president, Joseph D. Carroll, of Fiss, Doerr & Carroll, of New York; secretary, J. C. Shutte, of S. E. Bailey & Company, Lancaster, Pa.; treasurer, George W. Ryan, York Carriage Company; designer and general manager, James A. Kline, formerly general manager of the York Motor Car Company. This concern has been formed as a result of the withdrawal of the interests held by Messrs. Bailey, Kline, and Shutte in the York Motor Car Company, the maker of Pullman automobiles.

A new factory has been built in the city, 300 by 50 feet in size, and to-day ground was broken for another building which will be 150 by 80 feet in size. About 300 men will be employed here, and the same number in the factory in Bath, N. Y., which has been purchased from the Kirkman Motor & Parts Company. The latter plant will be used by the new concern to make its engines, transmissions, rear construction, and other parts; leaving much of the machine work, the body building, finishing and shipping of complete cars to the York factory. Contracts are now being placed for materials with which to construct 500 automobiles, and Mr. Kline is completing designs for the cars.

STODDARD'S NEW CONCERN—THE COURIER

DAYTON, O., June 14—Inasmuch as the Dayton Motor Car Company of this city is working to the limit of its capacity to produce the Stoddard-Dayton automobiles, the officials of this concern have formed another one which will build a small car to sell for \$1,000. The new organization will be called the Courier Car Company of Dayton, and its officials include C. G. Stoddard, president; H. J. Edwards, vice-president and designer of both cars; J. W. Stoddard, and a number of those connected with the Dayton Motor Car Company. The plant of the Kinsey Manufacturing Company, offering about 100,000 square feet of floor space, has been taken and machinery is now being installed. Work will commence about August 1, and inasmuch as both plants are near together, the official duties will be facilitated. The capital is \$200,000.

The Courier will have a four-cylinder motor, of 3¼-inch bore and 4¼-inch stroke. It will be rated at 20-horsepower and will have a magneto. The transmission will be of the selective sliding gear type on the rear axle, the body will be a roadster or baby tonneau, and as stated the price will be \$1,000. This will include full lamp equipment, and 3½-inch tires on 30-inch wheels. The plans and contracts for material call for an output of 1,000 cars.

AUTO ENGINEERS WILL MEET IN CHICAGO

NEW YORK, June 14—Chicago has been chosen as the meeting place for the midsummer session of the Society of Automobile Engineers, and the dates will be August 5, 6, and 7. This was decided upon at a recent meeting of the society council, and the dates selected so that they include that of the Algonquin hill climb, which the members may thus attend. From what Prof. Carpenter, chairman of the committee on papers, reported it appears that the discussions at the coming conclave will be of more value and general interest than those at any of the previous meetings. Those members of the council present were: Henry Hess, president; A. L. Riker and Thos. J. Fay, past presidents; Alexander Churchwood, secretary; A. H. Whiting, treasurer; H. M. Swetland, chairman entertainment committee; Prof. Rolla C. Carpenter, chairman committee on papers; B. D. Gray, and Henry G. Chatain, directors. Additional details of the meeting will be furnished at an early date.

WILLYS TO HEAD MILLION DOLLAR COMBINE

TOLEDO, O., June 14—Announcement has just been made that a million dollar company is shortly to be organized to bring about a consolidation of the various motor manufacturing concerns in which J. M. Willys, president of the Overland Automobile Company, is the chief figure. The company will form a holding company, which, it is stated, will be known as the Toledo Motor Car Company, and it will consist of a consolidation of the Pope Motor Car Company (recently purchased), the American Motor Car Sales Company, the Overland Automobile Company, and the Marion Motor Car Company, in all of which concerns Mr. Willys holds a controlling interest.

Bissell Company Will Make Electric Runabout

A jobbing company with F. E. Bissell of this city as president has just been formed for the purpose of handling a new electric runabout which is to be manufactured by the Bissell Electric Company of this city. The Bissell company at present handles only electric equipment of various kinds, but it has recently acquired patterns for a light electric which is to be placed on the market as both a low and medium priced machine.

CLAIM SERVICE IS NOT ECONOMICAL

WASHINGTON, D. C., June 14—The local post office authorities recently invited sealed bids for furnishing an automobile mail collection service. Seven hundred and seventy bids were received, and the announcement is now made that unless the Brush-Nichols Company, the present contractor for this service, makes a substantial reduction in the amount now paid for the service, its contract will not be renewed on June 30.

The Brush-Nichols Company is receiving \$13,400 per year for furnishing three Brush cars with drivers, sixteen hours a day, in addition to which it is given, rental free, a garage estimated at \$900 yearly. This service replaced ten foot collectors, whose combined salaries amounted to \$10,000 per annum, and the postal authorities believe that the automobile service is not a sufficiently great improvement over that of the foot collectors to warrant paying the increased cost.

WARNER GEAR ABSORBS WARNER ELECTRIC

MUNCIE, IND., June 14—The Warner Gear Company, of this city, has just absorbed the Warner Electric Company, also of this place. The latter concern made control levers and emergency brakes which were marketed by the former, and as T. W. Warner was manager of both concerns, the transaction is in the nature of a consolidation. The Warner Gear Company will again increase its facilities, this time by 100 per cent, by new buildings and equipment. Building operations will begin within a few weeks. The concern employs 600 men.

THIS AUTO CALLED THE "SKIDDOODLER"

COLUMBUS, O., June 7—Because the application for licenses to operate automobiles in this State requires the name of the car to be given, J. Shrum, of this city, has designated his car as the "Skiddoodler." Inasmuch as he had constructed it himself of materials gathered or made by him, he could not name it by any of those applied by the manufacturers of autos. Therefore Mr. Shrum had to invent a name, and its number is "I."

APPERSON BROTHERS ENLARGING FACTORY

KOKOMO, IND., June 14—Additions of two three-story buildings are being made to the factory of Apperson Brothers in this city, and will be finished by the middle of August. These buildings will more than double the present size of the plant, and will give a capacity for 1910 of three times as many automobiles as have ever been made in any previous year.

SCHOOL TURNS OUT REAL CHAUFFEURS

Allurements of the profession of the chauffeur on the one hand, and of the desire for intimate knowledge of a newly purchased automobile on the other, have contributed primarily to the formation of automobile schools. Like the proverbial toadstools, a great many so-called places of learning arose in the earlier days of the auto interest, but these have disappeared on account of their laxity of management and curriculum, leaving several well established institutions of reliability.



Stewart Automobile Academy Building

A school of the latter class has been recently organized in New York City by William H. Stewart, Jr., known as the Stewart Automobile Academy, and in general equipment and surroundings compares favorably with any of the best semi-technical schools of the country. With a corps of instructors who understand the automobile thoroughly from its practical side, as well as the theoretical, the students of this academy are given a course in practical operation of touring cars and roadsters. It is not the

aim of any of the large institutions to give engineering courses or a deep technical knowledge of the cars, confining themselves to give a well-grounded insight into the whys and wherefores.

The demand for reliable chauffeurs continues, and from all over the country men are constantly coming to New York to be taught how to operate the increasing supply of autos. But the activities of the Stewart Academy are not confined to prospective chauffeurs, for a large number of owners have been enrolled, both men and women, who have recently purchased cars and have not cared to gain their knowledge through the hard lines of experience. The classes extend over a period of four or six weeks, according to the number of lessons taken during the week, and there are three sets of classes during the day: 9.30 a. m. to 12.30; 3 p. m. to 6; and 7.30 to 10.30 p. m. Special instruction is given for the women as best suits.

In the heart of the automobile district, on Fifty-fourth street, practically adjoining the Automobile Club of America, a building was secured last winter and thoroughly renovated, so that it became new to all purposes of the school. This structure is

one of the largest occupied solely by an automobile school, having four floors and a basement, 25 by 100 feet in dimensions, giving 10,000 square feet of floor space, with an electric elevator large enough to lift the heaviest autos, wash stands, electric light and power, retiring rooms, offices, and of course, the laboratories. The windows are large and the result is that the entire building is bright and airy, and altogether suitable for use during the course of shop work or lectures.

Equipment of a modern nature is a prime requisite, and this important matter received ample consideration in fitting up the instruction rooms. Motors, transmissions, self-starting devices, ignition systems, carbureters, axles, springs, tires, and complete cars are included in the stock with which the embryonic autoist is made to understand. Blackboard lectures are also given, and the use of wall diagrams facilitate matters greatly, especially in regard to ignition requirements. When the student masters the intricate details of construction in the laboratories, road work is given and is not confined to running a machine through the parks or open streets, but right through the business and most congested parts of the city. For example, the last of the 12 driving lessons is to drive successfully a modern auto from the school to the Cortland street ferry and back, thus subjecting the operator to every conceivable test of city driving. The work on country roads is of minor consideration as compared to this. For this road work there are two machines used, a 30-horsepower Haynes and a 20-horsepower Locomobile. The former is a roadster, giving practice in the use of a car with jump spark ignition and shaft drive; and the latter is a touring car with make and break ignition and double side chain drive. On both of these cars there has been installed a double set of control pedals, brake and clutch pedals as usual for the driver, and a similar set for the instructor, so that in case of an emergency the car can be controlled by the latter.

In the laboratory there are several motors and other devices: a six-cylinder 1908 Winton motor; a 1908 Winton transmission; a 20-horsepower Locomobile motor in cross section for valve and igniter timing practice; a 1909 Oldsmobile four-cylinder motor; a 1908 Haynes chassis for practice upon chassis details, such as driving mechanism with the shaft drive, showing cardan joints, etc.; and a Locomobile chassis for similar work with a chain driven machine. The Winton and Oldsmobile motors are for actual running on stands, with the exhaust piped out of the room, and so arranged that various carbureters or ignition systems can be tried out. These integral parts of an automobile are of such nature as to be thoroughly representative, and a person who becomes familiar with them can be relied upon to understand any make. Each student is supplied with locker space, instruction books, and a kit of tools, so that there is no aspect of securing students for one fee and then subjecting them to other costs for supplies. In connection with the work in the laboratory, the lectures are carried on, with excellent ignition equipments for illustration. Carbureters are illustrated by popular types, and the same is the case with mechanical oilers. A



Corner of Stewart Laboratory, Displaying Wealth of Equipment

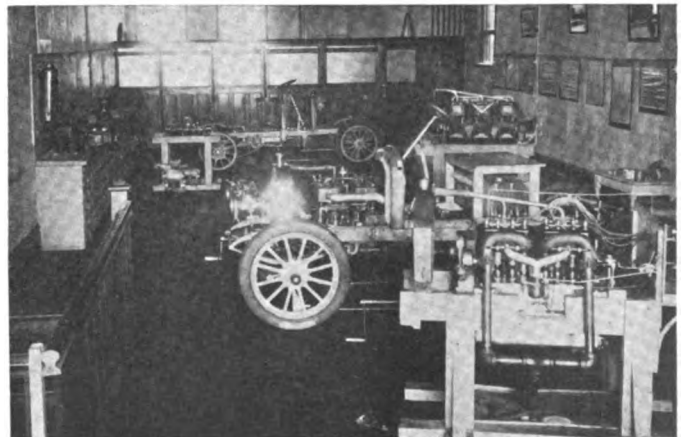

Another View, Showing Complete Chassis and a Few Motors

complete supply of various tires and rims is on hand to show the methods of the use of quick detachable, demountable, or regular clincher rims, repairing of inner tubes, etc.

When evident knowledge is instilled into the students a new tack is taken, that of trouble hunting, especially in regard to the finished motors. With an engine running regularly, a number of the class will be sent from the room, and some thing done to the engine which is likely to happen upon the road, and might puzzle the most expert. Water may be introduced into the carbureter, a valve or two may be fixed to stay open, the ignition wires may be mixed, the magneto timing deranged, or any one of a hundred different things done to confuse the autoist. The student must find this, and if he cannot do so alone, the instructor will aid him in following up certain lines of reasoning. Repair work is obtained on the upper floors of the Stewart building where outside trade is taken in, and the usual repair work done.

The officers of the Stewart Academy are: President, Richard E. Sause; vice-president and manager, William H. Stewart, Jr.; treasurer, Peter Cleary; secretary and assistant treasurer, Arthur V. Lyall; chairman of directors, F. S. Ferguson, Jr.; advertising manager, Harry S. Hall. The instructors are: Technical director, William H. Stewart, Jr., A.B., Rutgers College; internal combustion motors, C. T. Swart, M. E., Columbia; ignition, Stanley F. Bond, E.E., Columbia; motors and chassis, J. L. Del Rio, M.E., Columbia.

WHAT ONE OHIO CLUB IS DOING

COLUMBUS, O., June 14—The Columbus Automobile Club has started a department to furnish information to those who tour Ohio, with reference to the condition of the roads. The touring committee is receiving almost a dozen letters daily asking for information. The last consignment of road signs to cover Central Ohio has been received and will be erected as soon as possible.

CORBIN "TURTLE" DOES VERY WELL

At the recent Giant's Despair hill climb, the winner of the previous year and two-time holder of the Hollenback trophy, the Corbin car, was unable to compete because in practice the night before it turned turtle. As is well known to students of history, the turtle sometimes wins out, and this case was no exception to that rule, the Corbin making faster time in its only appearance of the day, in the last event, than did the winner of the Hollenback trophy race. Thus it was shown that had the car been able to compete therein, it would have repeated its victory of previous years, and finally won permanent possession of the cup.

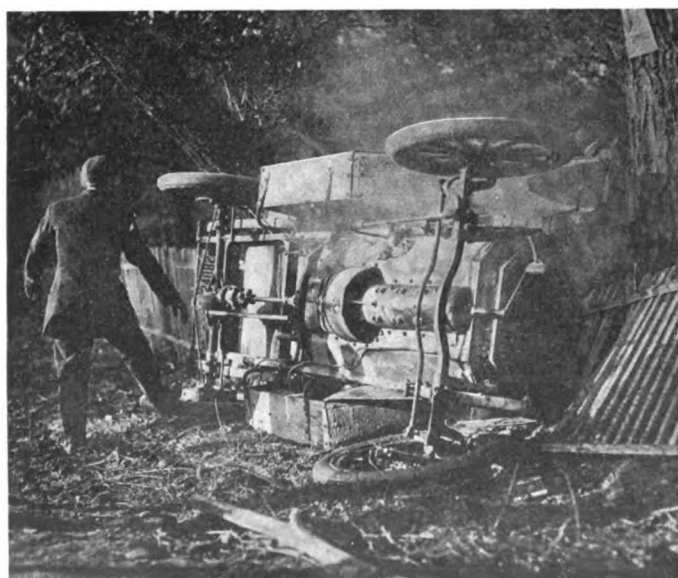

Corbin Car Which Turned Over Without Breakage

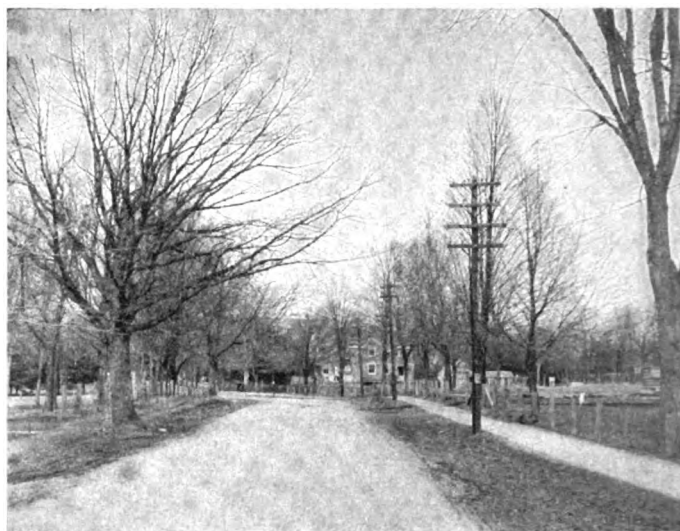

A Modern Road Surface that Has Been Treated with Tarvia

ALLEVIATING THE DUST NUISANCE

Solutions of the dust problem in connection with automobile traffic, according to the report of Nelson P. Lewis, of the New York Board of Estimate and Apportionment, upon the recent International Road Congress in Paris may be divided into three classes. Of these the practicable one is to so construct and reconstruct the roads gradually, with binding materials which will make them proof against the disintegrating forces of high speed. The other two divisions considered are both impracticable, one being to require reduced speed and the other to build special roads all over the country. Mr. Lewis's report says in part: "It must be conceded that grit or stone dust of the same kind as that of which the road is built, or sand and mixtures of sandy loam and clay, are not suitable for roads as binding material, when freely used by automobiles. Only a perfectly homogeneous roadway, of which all the fine surface materials are protected against being scattered, is able to stand the passage of the extra rapid vehicles in use to-day. Either the roadbed must be so dense as to be unaffected, or a more vicious and elastic binding material must be used. It is quite generally believed that some form of bitumen is best adapted to this purpose."

Of the methods for reinforcing the binder of macadam roads, the French, English and American practice is frequently to select a prepared tar, no mention being made in the report of oils, soapy waters or other materials to suppress dust after it has been formed. It is recognized that the dust should be prevented from forming, if possible. In the United States a substance under the name of tarvia is available in three forms, suitable for various road conditions. One is very dense, sufficiently viscid to act as a binder, in the large voids of the 1-2-inch stone of a new highway; while for the top course, where the holes are smaller, a lighter article is manufactured; and for the minute pores of an old road, where there is to be no resurfacing, still lighter a fluid is supplied. In these cases the tarvia acts as a soft cement between the particles of stone, but, unlike cement in concrete, it does not become brittle, remaining resilient and waterproof.

Practice has seemed to indicate that under traffic a tarviated surface does not break up, but is rolled down and smoothed out, and consequently does not grind off any dust. At the same time dust which is blown upon the road adheres to it, is rolled into it and does not rise again. It is claimed that a single application of tarvia, in many instances, has produced dustless conditions for at least a season. Under light traffic a road so treated has remained dustless for upward of two years. In reporting upon the effect of tarvia on certain roads in the Borough of Richmond, Mr. Lewis says: "It has been demonstrated that at an increased cost, within the reach of any community, it is possible to secure a dustless road, incomparably better adapted than is ordinary macadam to automobile traffic."

GOODRICH TIRE EUROPEAN PLANT

PARIS, June 10—After France has sent her tiremakers across the Atlantic, the United States has replied by sending her experts to the old country. The first American tire factory in Europe is about to be opened near Paris by the B. F. Goodrich Company, of Akron, O. The firm has had a sales department in London for several years, and for the last two years has had a branch house in Paris, where French sizes were sold for French machines and American sizes kept in stock for the convenience of tourists. The president of the company, B. C. Work, is at present in Paris in connection with the projected factory, and expects to make a definite announcement regarding future plans within a few days. At the present time all tires are imported direct from Akron, the firm only maintaining a repair shop in addition to its selling branch near the Avenue de la Grande Armée. The Goodrich Company was the first American firm to sell tires in Europe, and will be the only one manufacturing on this side.

Havoline Oil European Plans for European Trade

It is more than probable that within a few weeks the Havoline Oil Company will enter on a business campaign with their products in France and other European countries. The agency for the company has recently been taken up by the American Auto Supply Company, and this week the manager of the company, A. E. Schwartz, sailed for New York with the object of arranging for a European business campaign on a large scale. The "Packard" brand of oil, now only offered at the Packard agency in Paris, will doubtless be on sale at all garages throughout Europe within a few weeks.

WELCH TO HAVE SMALLER CAR ALSO

DETROIT, June 14—The Welch Motor Car Company, long identified with the automobile industry as a producer of high-grade, high-priced cars, is about to enter a new field. Incidentally, Detroit's prominence in the automobile world is to be strengthened by the addition of another great factory.

W. C. Durant, of Flint, has purchased from the Olds Motor Works the property on Jefferson avenue it occupied when maintaining a Detroit factory. The purchase is understood to have been made for the Welch Motor Car Company, of Pontiac, which will next season put on the market a four-cylinder car of 24 or 30 horsepower, and selling around \$3,000. An official of the Welch Company is authority for the statement that 1,500 of these cars will be made the first season, and that employment will be given to 1,000 men. Operations will begin about August 1.

It was at first rumored that the purchase had been made for the General Motors Company, which had also absorbed the Welch Motor Car Company. This is denied by officials of the latter corporation, who declare their concern will retain its identity, although the General Motors Company will market the lower-priced car. The new deal does not in any way affect the present Welch factory in Pontiac, which will continue to manufacture high-priced cars.

TO BUILD ELECTRICS IN WASHINGTON, D. C.

WASHINGTON, D. C., June 14—Electric delivery automobiles will shortly be manufactured in this city by the Pittsburgh Motor Vehicle Company. At a final meeting of the stockholders of this concern held recently, all the money necessary for the opening of a factory was subscribed, and the machinery is being purchased. It is expected that the plant will be in operation by the middle of July, although its site has not been announced. It is understood, however, that a location has been secured in the northwest part of city, within one block of Pennsylvania Avenue. The officers of the concern are: President, Arthur C. Moses; vice-president and general manager, W. H. Conant; treasurer, H. E. Leary; secretary, Stanton C. Peelle; directors, Byron S. Adams, R. P. Andrews, F. W. Bolgiano, Jules Demonet, A. F. Jorss and John J. Knox.

COLUMBIA MOTOR CAR COMPANY NEXT

HARTFORD, CONN., June 14—One more page has been turned in the affairs of the Electric Vehicle Company of this city, which has been in the hands of a receiver since December 10, 1907. The bondholders of the company through their legal representatives—Lucius F. Robinson, Albion B. Wilson, and Francis W. Cole, all of Hartford—to-day filed with the secretary of state a certificate of incorporation of a new concern to be known as the Columbia Motor Car Company of Hartford. The new company will take over and acquire all and any assets and property, real and personal, of every kind and description of the old concern, that is, the Electric Vehicle Company. The authorized capital stock of the Columbia Motor Car Company of Hartford is \$48,000, divided into 480 shares at a par value of \$100 each. Of the capital stock, \$32,000 represents preferred stock or two-thirds of the capitalization, while the remaining one-third represents common stock.

Before the property of the Electric Vehicle Company can be acquired by the Columbia Motor Company the necessary power to sell must be granted the receivers by the courts of New Jersey. As already mentioned in last week's issue, the receivers have applied for the right to sell to a committee of reorganization, and the court order is returnable on Tuesday.

Just what the policy of the new company will be is not known and nothing is said or can be learned of it at this time. However, it is the accepted belief that the manufacture of Columbia gasoline and electric models will be continued as heretofore by the receivers. At present the 29 hp. four-cylinder car is the only gasoline model built by the company. It is stated on good authority that next season the company will bring out a six-cylinder motor with the same stroke and bore as the present, but having a dual system of ignition.

The May report of H. W. Nuckols and H. M. Barrett, receivers of the company, shows sales during the month of \$78,411.53. Of the cash receipts, \$3,630.48 was realized from the Selden patent, and of the disbursements George B. Selden is credited with \$37,729.55 and the Licensed Association with \$3,395.20. The balance on hand June 1 was \$169,599.50.

NEW WIRELESS SYSTEM OF UTILITY

AKRON, O., June 14—Ever since the incident of "Jack" Binns and the ill-fated *Republic*, the people have been greatly interested in any sort of "wireless." The latest, which has just been announced here will interest automobile owners, and particularly truck owners, more than the general public. This is a new form of tire just brought out by the B. F. Goodrich Company.

The new "wireless" tire is meeting with such favor among manufacturers of motor trucks, that the demand for them is already exceeding the ability of the huge Goodrich factory to supply them. The immediate reasons for its success, as set forth by the manufacturing company, are certain advantages which are enumerated as follows: First, increased mileage, because the tire will stand a maximum external abrasion without affecting its fastening to the wheel; second, freedom from repairs, because there is no hinging action of the rubber over internal metal fastenings; third, decreased cost per mile, as a result of the first two advantages. No complicated machinery is needed to apply these tires, and they may be readily put on to any wheel which has been equipped with a "wireless" rim.

The "wireless" dual type offers perhaps the most unique advantages. The improved construction makes it possible to set the twin tires on the rim in direct contact with each other. This reduces the space between the tires to the minimum necessary to prevent skidding and displacement of the rubber under stress. The narrower tread also reduces the necessity for offsetting the felloes on the drive side, and enables the load to be distributed centrally over the hub and spokes.

Marshalltown, Iowa.—Ingval & Rhodes have let contracts for the erection of a new garage which will cost \$6,200, to be built of brick and cement, on East Lincoln street.



Hopewell Cutting Room, Cutting Machine In Action

TIRE CASES REQUIRE ACCURATE WORK

To manufacture cases for tires is no longer a hit-or-miss trade, but requires mathematical accuracy in the measurement of the goods, in the assembly, and finishing, in order that the protectors fit the tires perfectly. The Hopewell Brothers, of Cambridge, Mass., are among the largest makers of tire and lamp covers in the country, and they have shown the realization of the need for care in the producing of their output. The concern is a partnership between Frank B. Hopewell and Charles F. Hopewell, the former having invented the Hopewell tire case, and the latter having taken charge of its development. These men have patterned their cases from the rim dimensions entirely, for they claim that the measurements of tires vary as much as half an inch in outside diameter, thereby preventing a good fit.

In the factory the accuracy of cutting is obtained by electric machines which run at 3,500 revolutions per minute, are capable of cutting 50 thicknesses of goods at one time, and they must do this within one-eighth of an inch of the exact measurement or the cuttings are not accepted by examiners. With two tables of electric cutters, 300 tire cases can be turned out at a time. After this operation the goods are taken to a machine room, which is equipped with 32 machines able to stitch very heavy material, and when the sewing is completed, the cases are given a rigid inspection. They are examined for workmanship, material, dimensions, and the circumferential measurement must be accurate to within one-quarter inch, or the case is rejected. Between 1,500 and 2,000 cases are carried in stock, all neatly packed in boxes. The springs which are used to make the cases fit snugly around the tires are all tested for elasticity and strength of joint, and are japanned before being used. Nearly a ton of these steel springs are used weekly, and several miles of goods are required. Lamp covers and other lines of goods are given the same care in material and workmanship as the Hopewell tire cases.



In the Machine Room Where Numberless Girls Sew Cases

The office system has been given great consideration by the company, so that at present by cross-indexing, and the use of card catalogues, the orders may be found instantly, and are thereby assured of more prompt and careful attention than when no definite rules are followed.

LATEST IN FRENCH SHOCK ABSORBERS

PARIS, June 10—An exceedingly simple and efficient type of shock absorber has just been placed on the French market under the title of The Sphinx, and adopted as a standard equipment for all cars of one of the leading French makes. The apparatus consists of two cylindrical boxes, one of which is bolted to the side member of the frame, and the other, with lever integral

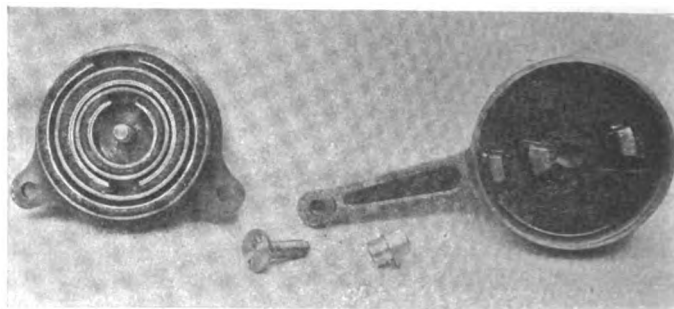

Sphinx Shock Absorber Dismounted to Show Parts

with it, forming a cover free to pivot round the fixed member; the two are attached by means of a simple type of bolt and nut forming the axis of the pivoting member. The fixed box contains three concentric rings, each one lined with felt and a steel spring forming eccentric. On the pivoting member are three

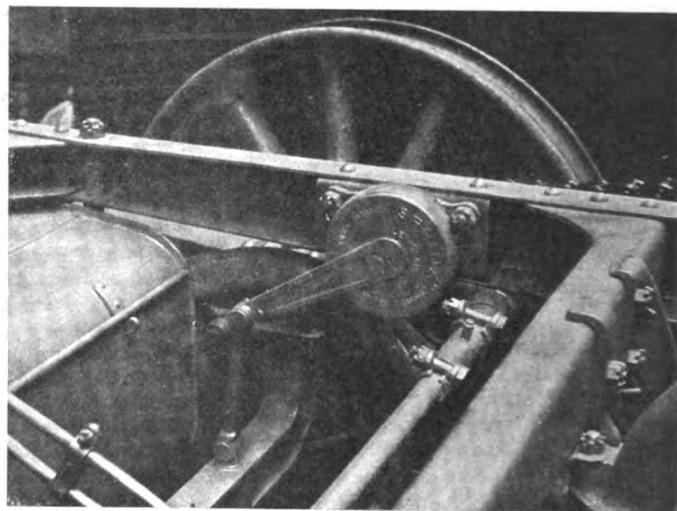

Fitted to the Rear Axle and Frame of a Car

wedge-shaped studs fitting into the grooves formed by the rings. When the car is at rest the studs are lodged in cut-away portions of the spring and felt lining with just sufficient play to prevent them coming into operation for slight oscillations of the chassis. An increased movement of the frame in relation to the axle causes the studs to be forced into the grooves formed by the rings, and the further they travel round the greater is the resistance, thus, of course, tending to eliminate violent oscillations of the chassis.

How to destroy battleships from airships is to be shown by the Wright Brothers when they finish the Government tests with their aeroplanes at Fort Myer next June. The outlines of a battleship will be made on the ground with chalk and projectiles will be dropped from the airship.



A Mission Type that Prevails in Southern California

GARAGE THAT HAS A NOTED CLIENTELE

SANTA BARBARA, CAL., June 11—The Higgins Machine Works Company, which conducts the principal garage in this city, lays claim to having housed the cars of more American notables during the past four months than any other garage in the country. To substantiate the claim, a list has been prepared of notables who have been at the garage with their cars since the first of the year, viz.:

E. H. Harriman, New York, president Southern Pacific Railway; E. P. Ripley, Chicago, president Santa Fe Railway; Louis F. Hill, St. Paul, Minn., president Great Northern Railway; James Hobart Moore, Chicago, president Rock Island system; John Hays Hammond, world famous mining engineer; W. F. Dreer, Philadelphia, leading seed merchant; George J. Haime, St. Louis, capitalist; D. D. Walker, St. Louis, capitalist; General Henry Strong, Chicago, former attorney general of Illinois; Pentecost Mitchell, St. Paul, United States Steel Company; J. V. Silverton, New Uim, Minn., president Eagle Rolling Mills; R. B. Merrill, Seattle lumberman; P. B. Stewart, Colorado Springs, capitalist, cousin of ex-President Roosevelt; Mrs. Nelson Morris, widow of the Chicago packer; A. Chester Beatty, New York capitalist and mining engineer; former United States Senator Baird; Judge W. G. Henshaw, Oakland; A. P. Knight, Denver, painter and personal friend of King Edward; Thaddeus Welch, one of America's greatest landscape painters; Stewart Edward White, author; Lloyd Osborn, author; Mrs. Robert Louis Stevenson, widow of the poet; William Miller Graham, oil king; C. B. Hale, New York capitalist; A. G. Spalding, Chicago capitalist; W. H. Cowles, Spokane capitalist, related to Mrs. Theodore Roosevelt; R. T. Crane, Chicago, president of Crane Company, steel and iron; W. E. Sloan, New York capitalist; Captain Huron Rock, Canadian capitalist; Louis F. Jones, New York capitalist; S. P. Cafef, New York capitalist.

This list does not show all who have come here during the past months, but just such as have had their own cars at this garage.

A GARAGE OF ELIZABETHAN ARCHITECTURE

CINCINNATI, June 14—Different from the general run of garage buildings, the new garage of the Robert C. Crowthers Automobile Company, at the junction of Mitchell and Clinton Springs avenues, Rose Hill, Avondale, will be in keeping with the residential surroundings of that popular suburb. The property was leased by the Crowthers Company for a term of years and it is suitable for housing 25 to 30 automobiles. Mr. Crowthers will occupy one end as a residence and will reserve a fine large room separate from the garage proper for a salesroom. Royal Tourist and Elmore cars are handled in addition to doing a general garage business. The opening of this new place in the midst of Cincinnati's residence district has proven very popular with automobile owners, who were compelled previously to keep their cars at inconvenient distances.

ABOUT GARAGES THE COUNTRY OVER

Atlanta, Ga.—One of the largest vacant tracts of land in the business part of the city, on Auburn avenue between Courtland and Piedmont, has been sold to John M. Smith, a carriage manufacturer, upon which one and perhaps two garages will be erected. The lot has a front of 86 feet and it is 375 feet deep. There has been a tendency of late to make Auburn avenue the Automobile row, and already the Maxwell and Oldsmobile interests have located there.

Columbia, S. C.—At a total investment of about \$18,000, E. A. Jenkins will within a short time begin the erection of a building for the Jenkins Automobile Company. A lot at the corner of Main and Richland streets has been purchased for \$9,500 and upon it will be constructed a garage, sales room, and office structure, 40 feet wide and 120 feet deep, from which will be sold the White, Stoddard-Dayton, and Reo cars.

Los Angeles, Cal.—A one-story brick garage, 150 by 140 feet in size, is being built at the corner of Tenth and Olive streets. It has been leased to the Stoddard-Dayton Motor Company for a term of years. The interior finishings of the salesrooms, offices and other quarters will make the building one of the handsomest of its kind in this part of the country. It will cost about \$15,000.

Portland, Me.—Excavations have been commenced for the building of a large garage and salesroom on Forest avenue. The building will be 80 by 133 feet, two stories in height, and will be completely equipped for a modern garage, with salesroom in front, and elevators permitting of the use of the basement for storage of cars. The second floor will be used as a skating rink.

Baltimore, Md.—At an expense of about \$25,000, Michael Griffin will erect a three-story fireproof garage at Howard street and Park avenue. Plans have been drawn and the contract already awarded. The building will have a 98-foot front and a depth of 75, constructed entirely of brown stone, granite and concrete. The floors will be of tile work with fancy designs.

Blacksmith Shop Now a Garage—The trend of the country blacksmith toward being an automobile repair man is a recognizable one, and the town smithy has followed suit. In Fulton, N. Y., W. T. Fuller has sold the building which he has used for a blacksmith shop for many years and it will be converted into a garage.

Lexington, Ky.—The Phoenix Garage has amended its articles of incorporation to change its name to the Phoenix Motor Car Company, with an increase of stock from \$10,000 to \$15,000. The articles are signed by A. L. Hamilton, V. K. Dodge and N. W. Dodge, directors.

Denver, Col.—The Denver Omnibus and Cab Company will have a new stable and garage, to be immediately erected at a cost of about \$150,000. It will occupy half a block on East Eighteenth street, between Pearl and Washington streets.

Wilmington, Del.—The Wilmington Automobile Company has arranged to have an \$8,500 addition made to its garage on Tenth street. The new part will be at the rear, extending back to Hamilton street.

Princeton, Ky.—A garage has been opened in this city by Raymond Frazier, who was formerly in the automobile business in Evansville, Ind.

Plainfield, N. J.—The Morris Auto Company has arranged for an addition, 50 by 100 feet in size, to its garage.



Rose Hill Garage, Cincinnati, a Southern Ohio Masterpiece



Winnipeggers Buy Many American Automobiles

Above is shown a single shipment of Franklin air-cooled cars recently received by the Winnipeg Garage, Ltd., which represents the Syracuse manufacturers throughout Manitoba and Saskatchewan. This is the second shipment of these cars in the year and shows plainly the growing use made of the automobile in this faraway and unfamiliar country.

Electric Welding Products Company Enlarges—Growing demand for the parts manufactured by the Electric Welding Products Company, of Cleveland, has necessitated an increase in its facilities. The factory was worked overtime all last winter, but was unable to catch up, so a large addition was built and has just been completed. This is a three-story structure, which will nearly double the capacity of the plant, and it will handle the gas engine and automobile parts, such as combination valves, solid and tubular propeller shafts, gear blanks, truss rods, grip control and brake levers, and special steel screws. About 20,000 square feet extra space were secured and it is stated that some new products will appear this year.

You Can't Steal That Car—It would make anybody peevish to have his car stolen; yet that is such a very easy thing to do with the ordinary automobile that the manufacturers of the Rambler have devised a lock, which from now on will be applied to their entire output. This is in the nature of a key in the gasoline pipe, without turning which the fuel may not flow to the engine, and, like the gasoline gauge, which Thomas B. Jeffery & Company are fitting to all cars, it is not in sight until wanted, and then is immediately useful.

In Truth, These Were Jewels—After completing the strenuous tour from Denver to Mexico City, in the Chalmers-Detroit "Flag to Flag" pathfinding car, reports William Knipper, two of the Diamond tires still contained the original air, one had suffered but one puncture, and the remaining tire but two. The weight carried on the 34 by 4-inch tires was 3,850 pounds, in view of which their performance was remarkable.

Quick Change Made with Doolittle Rim—In the three-day tour of the New York Auto Trade Association, the Interstate car was equipped with Doolittle demountable and quick detachable rims, and near the finish this equipment proved its worth. The car had a puncture at 136th street, just as another contestant passed it. The tire was changed in about two minutes, and at 103d street it caught and passed the other contestant.

New Auto Factory for Millville, N. J.—It is likely that an automobile manufacturing concern will shortly locate in Millville, N. J., according to statements of the local board of trade. The name of the concern is not announced, but it is said to have stated that should it be able to purchase three acres of ground at a reasonable figure it will locate there. Three property owners have offered to donate the land.

Carbureter Business Looking Up—The general improvement in business has extended to the automobile accessory manufacturers to such an extent as to require additional factory facilities. The latest to build an addition is the Kokomo, Ind., firm of Byrne, Kingston & Co., which has just contracted for the erection of a two-story brick building, 60 by 132 feet in size, to be devoted exclusively to Kingston carbureters.

Another Victory for New Departure Bearings—The recent victory of the Allen-Kingston car in its class events in the Dead Horse hill climb is recorded by the makers of New Departure ball bearings as another victory for those bearings, which are used in the A-K automobiles. This car made the fastest time of all gasoline stock cars in the meet, 1:07 4-5.

Belmont Car from Castleton, N. Y.—Automobiles to be sold under the trade name of Belmont are to be built by a company in Castleton, N. Y., of which H. H. Ingalls is president, and A. C. Cheeny, secretary and treasurer. The factory will be located upon the grounds of the A. C. Cheeny Piano Company.

Gearless Creditors File Bankruptcy Petition—The creditors of the Gearless Motor Car Company, of Rochester, N. Y., have filed a petition in bankruptcy against the concern in the United States

Court at Buffalo. According to the petitioners the company has admitted its condition.

McCord Begins Factory Addition—Ground has been broken in Detroit by the McCord Manufacturing Company for a factory addition that will enlarge the present plant by 40,000 square feet. It will be ready for occupancy in 40 days and will nearly double the output of radiators, lubricators and gaskets.

TAXICABS AND TRANSIT

Automobile Transportation for the Igorrotes—Over a distance which formerly necessitated a trip of ten in the Philippines, from Manila to Baguio, automobiles now have a route which is covered in eleven hours. The government has expended \$2,500,000 on the road and the postal department has placed in operation five cars, each carrying seven persons, mail and light baggage, between Baguio and Camp I. The former place has become a resort and many Manila residents have built houses there, the season lasting from March 1 to about June 15.

Montreal Hack Drivers Protest—Because horse-drawn, see-going hacks are much more comfortable than the atrocious taxicabs, the drivers of the city of Montreal have petitioned the police committee to prohibit the importation of the dangerous machines. A goodly number of signatures of the handlers of the reins have been affixed to the document, setting forth their objections, claiming, among other reasons, that the taxicabs make money only when running fast and that the streets are too narrow for speed.

Big Taxicab Concern to Start in New York—The Gotham Taxicab Company is preparing to start a large business in New York City, beginning with 50 cabs, on August 1, and gradually increasing that number. The plans have been made for a new style of cabs and the rates will be 30 cents for the first half mile and 10 cents for each quarter of a mile thereafter. The officials are: President, Edward J. Dowling; vice-president, John V. Levy; secretary-treasurer, S. L. Root.

Auto Line to Complete Texas Gap—A gap of 53 miles between two railroad

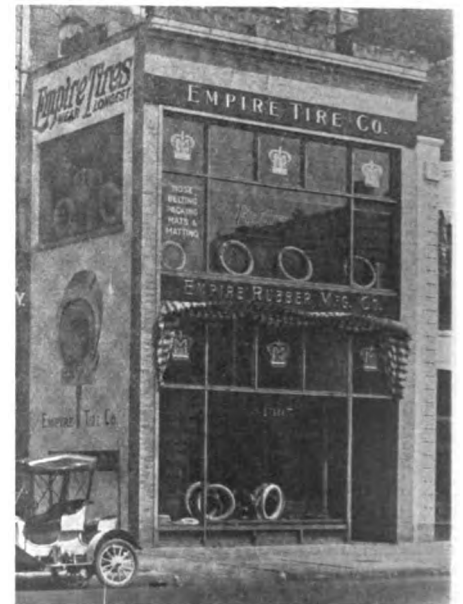

New Home of Empire Tires in Chicago

connections will probably be instituted between the towns of Mary Neal and Tennyson. The Orient railroad, it is reported, will start a train service between San Angelo and Tennyson, 20 miles out, and at the same time start a train between Sweetwater and Mary Neal, leaving a gap between Mary Neal and Tennyson which, during the month of June, will likely be covered by autos.

Autos Meet Trans-Atlantic Steamers—Combining the pleasures of a sea voyage with those of an overland trip in an automobile, reserved by means of the wireless telegraph, is a plan recently put into effect by the Compagnie Generale Transatlantique (French Line). Its fastest mail steamers may be met at Havre by De Dietrich automobiles for the run to Paris, a five-hour journey with a stop for luncheon at Rouen.

To Operate Cabs in Asbury Park—S. A. M. Thompson, who is the vice-president of a taxicab company, is looking for a suitable location in Asbury Park, N. J., for the erection of a taxicab garage or for securing one already built. The concern proposes to operate a large number of machines from the Jersey coast resort to neighboring towns.

Ironton, O.—An automobile line between Ironton and Proctorville will probably be established as soon as the authorities at Coal Grove repair a stretch of bad road. A fourteen-passenger 'bus will be used, owned by S. G. Griffith, of Huntington, and will make two round trips a day.

IN AND ABOUT THE AGENCIES

Chalmers-Detroit—The sales department of the Chalmers-Detroit Company announces the following agents, with whom contracts have been made to handle the 1910 Chalmers-Detroit: Los Angeles, Cal., Western Motor Car Company; Hutchinson, Kan., Taylor Motor Company; Sioux City, Ia., Wetmore & Rogers Auto Company; Baltimore, Md., Zell Motor Car Company; Cincinnati, O., J. H. Ratliff Auto Company; Chicago, Levy & Hipple Motor Company; Zanesville, O., C. A. Fritz; Savannah, Ga., T. A. Bryson; Hastings, Neb., Stitt-Dillon Motor Company; Catlettsburg, Ky., O. C. Magann.

Firestone Tire and Rubber Company—The new Cleveland Firestone branch, located at 1918-1922 Euclid avenue, is one of the handsomest establishments along that city's famous Automobile Row. A unique characteristic of the new store is

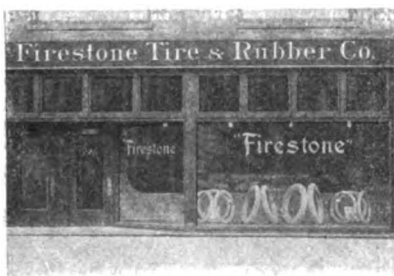

Handsome Firestone Store in Cleveland

the private garage in the rear that will accommodate three cars, where motor truck or pneumatic automobile tires may be changed under shelter.

Empire Tire Company—The Chicago branch, of which E. B. McKay is manager, has been moved to 1305 Michigan avenue, from 20 LaSalle street, in order

to facilitate the demands of the company's rapidly growing business. As will be seen by the illustration on the opposite page, the building is commodious and well adapted to the needs of a live and up-to-date concern.

PERSONAL TRADE MENTION

Arthur L. Banker, a pioneer automobile agent of Pittsburgh, Pa., has returned to the selling business as sales manager of the Banker Brothers Company, handling the Chalmers-Detroit and Hudson cars. About six months ago he left this concern to organize a wind shield company to use his patents, known as the Banker wind shields. A number of the large manufacturers have ordered this equipment for the coming season, and the Pierce-Arrow Company will manufacture 1,200 under the Banker patents for 1910.

Puller Harper, of Pittsburgh, will shortly enter the automobile business on his own account in New York City. He has been in the same business in this city lately and was formerly connected with the Westinghouse Company at East Pittsburgh.

T. W. Warner, general manager Warner Gear Company, Muncie, Ind., sails for a two months' trip in Europe June 24, on the Hamburg-American liner Graf Waldersee. During his absence Ray P. Johnson, treasurer, will have the active management of the plants.

David Bruce Brown, the amateur autoist who has broken many records this season at the wheel of the 120-horsepower Benz, will sail on Saturday for Europe. His trip is a pleasure one, and he will visit a number of the large automobile factories.

Orlando F. Weber has been appointed manager of the Chicago branch of the Palmer & Singer Company. Mr. Weber was a former cycling champion and has been connected with the Pope interests.

Frederic Thomas Bailey, familiarly known as "Harris Oil Bailey," has issued cards announcing the birth of Frederic Thomas Bailey, III, at Lake Forest, Ill., on June 2.

RECENT BUSINESS CHANGES

Kokomo Rubber Sale Off—Grafton Johnson, the Greenwood, Ind., capitalist who put up \$25,000 as an option on the plant of the Kokomo Rubber Company, Kokomo, Ind., failed to pay the required \$725,000 additional before his option expired, and as a consequence the rubber company paid its stockholders an extra dividend.

Kirkham Changes—Control of the Kirkham Motor Manufacturing Company, Bath, N. Y., was recently changed, when S. E. Bailey, of Philadelphia; James A. Kline, of York, and Joseph D. Carroll, of New York City, obtained a majority of the stock.

NEW AGENCIES ESTABLISHED

Interstate: Harrisburg, Pa.—Motor Vehicle Company, for central Pennsylvania, in addition to the Jackson.

Regal: Atlanta, Ga.—A. S. Allen, 102 North Pryor street.

Regal: Springfield, O.—E. D. Valentine, King Garage.

Studebaker: East Orange, N. J.—Herbert F. Listman.

RECENT INCORPORATIONS

Capital City Auto Company, Austin, Tex.—Capital \$7,500. To operate taxicabs, main-

tain garage, and deal in automobiles and accessories. President, Pierre Bremond; vice-president, E. H. Perry; secretary and treasurer, R. M. Thomson, Jr., agent for the Pierce-Arrow, Oldsmobile, and Oakland.

Couple-Gear Company of New York, New York—Capital \$50,000. To manufacture motor vehicles, electric and other motors, cars, carriages, and vehicles. Incorporators: W. H. Kennard, F. B. King, Howard Greene.

Cleveland, Beck & Layman Motor Corporation, New York—Capital \$8,600. To manufacture motor boats, vehicles, motors, cycles, etc. Incorporators: Chauncey Cleveland, A. L. Beck, H. B. Layman.

Tobin Whichway Signal Company, New York—Capital \$300,000. To manufacture automobile supplies, lamps, signals, etc. Incorporators: W. M. Wherry, Jr., C. A. Brooks, Frances Murphy.

Walden W. Shaw Auto Livery Company, Chicago—Capital \$300,000. To manufacture and deal in automobiles and other motor vehicles. Incorporators: E. N. D'Ancona, N. E. Dugan, A. J. Pfau.

Newcomb Engine Company, Harrison, N. Y.—Capital \$200,000. To manufacture motors, engines, automobiles, boats, launches, etc. Incorporators: W. B. Thompson, O. A. Hack, E. C. Chamberlain.

Mercer Automobile Company, Trenton, N. J.—Capital \$500,000. To manufacture automobiles, wagons, etc. Incorporators: F. W. Roebing, A. R. Kuser, J. L. Kuser.

STEWART TREBLES PLANT

About ninety days ago a large addition to the factory of the Stewart & Clark Mfg. Co., Chicago, was completed, and now work has been started on an addition that will treble the present size of



How the Enlarged Stewart Plant Will Look

the plant, with a corresponding increase in capacity. Demands for the Stewart Multipolar speedometer have been so pressing that, although the present capacity of the plant has been taxed to its utmost, it has been almost an impossible task to fill orders. The company will be in excellent shape to handle the volume of 1910 business expeditiously, and the illustration shows how the factory will look when the new addition is completed.

RECENT PUBLICATIONS

Harry S. Houtp Company, New York—Illustrative of Herreshoff automobiles, "the smart, light cob of motor cars," the Harry S. Houtp Company, of New York City, has recently issued one of the most attractive catalogues seen this year. The frontispiece is water color reproduction, which sets off the front of a Herreshoff car to advantage in an outdoor picture, and the two photographs of the cars, touring and roadster, are examples in their line. The wording of the matter in the booklet is altogether pleasing and apt to be read because of interest, even by a casual observer. The reasons for the manufacturing of a small car to take the place of large expensive ones in city or suburban service is well brought out, as are also the claims which can be made for Herreshoff construction as represented in automobile engine and motor boat design. The byword of the early announcements, "correct interrelation of parts," is amplified, detailing the theories used in the design of the small auto. The specifications are placed in an easily read tabulated form, and the motor, transmission, axles, brakes, steering gear, and other important particulars illustrated with wash drawings.

Information for Auto Users

which retains the asbestos together. By putting this rubber on the asbestos under an hydraulic vulcanizing pressure of close to 2,000 pounds per square inch, a very thin coating is insured. In this manner the percentage of useful material to total is made very large and the buyer gets the most for his money. The maker's confidence in the product is shown best in the test which is given. This is to select two or more samples of equal width and thickness, weigh, burn, and weigh the residue. The difference in weight shows the useless material, as asbestos will not burn.

Combination Plug and Relief Cock— Many an autoist has "cussed" his engine because the construction was such as to require the removal of the spark plugs, when priming was in order. This necessity is obviated by a new plug, which carries on one side of the stone a large opening leading to a regular relief cock.

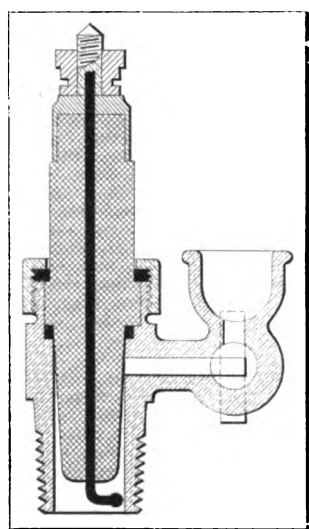

ALL-IN-ONE SPARK PLUG.

The cylinder must pass over the points. As these gases are always under high pressure, the points are effectually cleaned off. The use of this plug also adds to the ease with which misfiring cylinders may be detected. It is made by the Comet Electrical Mfg. Co., Detroit, Mich., and is aptly named the All-In-One spark plug. Up to date it has been used on a number of racing motor boats on the Great Lakes with the best of success.

A Decidedly Different Carbureter— Since the birth of the automobile there have been attempts without number to solve the problem of carburetion, and it is not solved yet. A recently brought-out device introduces some new features

which are of great interest, as being very practical, as well as novel. In the Bennett carbureter, made by the Wilcox-Bennett Carbureter Company, Minneapolis, Minn., the variation from the standard lies in the substitution of a standpipe for the ordinary spray nozzle. This standpipe has a large number of holes drilled along the sides, which, as set in the actual device, are vertical. Thus, when the running speed is very low, and the engine suction correspondingly weak, fuel is drawn but from one of the holes, the bottom one. As the speed increases and with it the suction, gasoline is drawn from more holes than the first, the number depending upon the pull of the motor. This effect increases until the greatest possible suction may be drawing from every one of the numerous holes, and in this way the engine is getting the maximum amount of fuel needed at that speed. The air control is through an auxiliary air valve, its action being controlled by a spring, the tension of which may be regulated from the outside without disturbing any other part. The number of holes which will be contributing fuel at the highest speed is, of course, controlled by the amount of gasoline allowed to enter the standpipe, and this may be changed or regulated at will by means of the needle valve head. This is milled and projects above the central part of the carbureter body, so as to be very accessible.

New Asbestos Brake Lining— Now that automobile brakes are receiving the attention which they deserve at the hands of designers, there is more demand for suitable brake lining material. One of these, possessing much of worth, is the product of the Empire Tire Company, Trenton, N. J. This material is composed of a central or major portion of asbestos, covered with an envelope of rubber. The fiber used is long, staple asbestos, closely woven, this having the high wear-resisting qualities which the short and coarse staple cannot have. The rubber coating, having no wear-resisting qualities, is made as thin as possible, its function being simply that of a holder

Simple and Strong Universal Joint— Simplicity is always desirable, and more than usually so in a part which is subject to varying and severe strains. Thus the new universal joint put out by the Mutual Machine Company, Hartford,

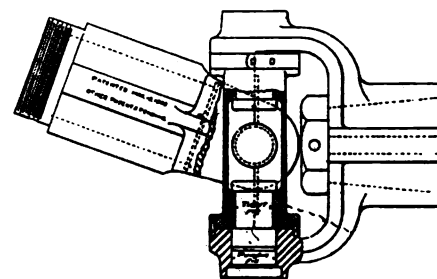

MUTUAL SIMPLE UNIVERSAL JOINT.

Conn., is particularly meritorious because of its unusual simplicity. The parts of this joint are all drop-forgings from a high grade of steel. The design is such that no cotter pins, nuts, bolts, screws, or other sources of trouble are used in the construction. In this way not only does simplicity make for natural superiority and increased strength, but the owner and driver is assured more peace of mind, in that he does not have to think of the parts which might come loose and rattle off. The interior of the main block is filled with grease, the opening being large enough to carry a season's supply, another point for the driver. These joints are made in all sizes for shaft diameters from 3-8 inch up to 1-2 inch, advancing by eighths, and on up to 4 inches and more, all sizes above 2 inches, however, being made to order only. The cut, part of which is in section, shows the interior construction of the joint. The space for the grease packing is particularly noticeable, as is also the method of fitting the joint together, and the retaining ring which holds it.

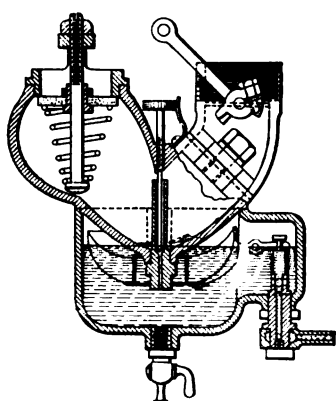

AT SLOW SPEEDS.

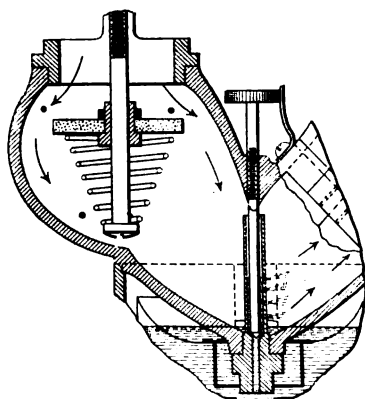

ACTION AT MEDIUM SPEED.

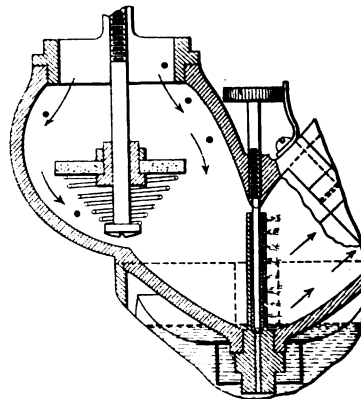

AT HIGH SPEED.

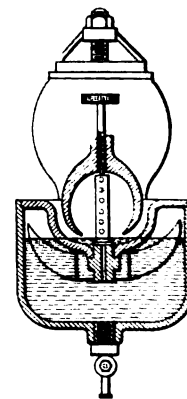

END VIEW.

BENNETT CARBURETER IN SECTION, SHOWING ACTION AT DIFFERENT SPEEDS.

THE AUTOMOBILE

LITTLE CARS SHOW
MORE SPEED THAN
BIG ONES



IN
WESTERN
STOCK CHASSIS RACES

COBE CUP: LOUIS CHEVROLET, 30.4 H.P. BUICK, 49.3 M.P.H.

INDIANA TROPHY: MATSON, 25.6 H.P. CHALMERS-DETROIT, 51.5 M.P.H.

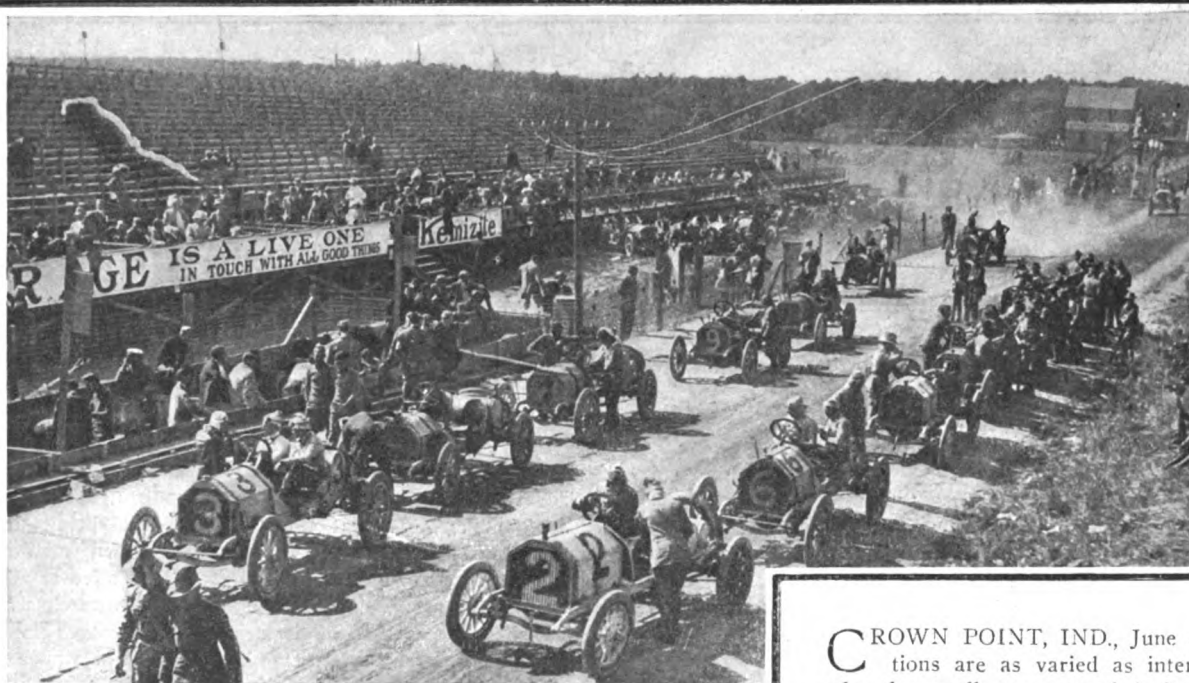

Eleventh Hour of Small Car Race

CROWN POINT, IND., June 19—Explanations are as varied as interesting as to why the small cars exceeded the big cars in speed ability in the "Western Stock Chassis Races." Friday, Matson with a 25.6-horsepower Chalmers-Detroit scored best among the small car contingent, which was asked to make ten

circuits of the 23.27-mile course, a total of 232.74 miles. The winner's average was 51.5 miles per hour.

To-day, Chevrolet successfully piloted a 30.4-horsepower Buick, with rare skill and perseverance, in the big car event wherein the contestants were required to travel 17 circuits, which gave a mileage of 395.65. But the greater distance killed off many, and the victor's sustained flight of speed only footed up 49.3 miles per hour. In the small car race, two besides the winner—Locomobile and Marion—exceeded the speed of the big car performer.

True, it was a bruising distance and the course had a serious handicap in a stretch of over a mile which couldn't be considered other than very bad. A dose of this in every circuit didn't help the cars, especially in the Cobe Cup race, and one after another suffered from disablements which sent them to the side of the road temporarily or permanently.

Mayhap in the effort to give the onlookers a plenteous run for their money, the distance was increased beyond the capacity of the cars for such a course. In like manner, the capacious grand stand offered accommodations for thousands who came not. 'Tis a weakness of Chicago folk to make things bigger than anyone else, and this was their first experience with a great automobile road race.

But let it be said right here, that the job was done prodigiously, and withal most excellently. No expense restrictions interfered with the work of the indefatigable committee, and its members labored from early until late, in order to have everything right up to the mark.

That poor stretch in the course had to be accepted as one of the regrettable handicaps, and if the enormous stand didn't hold the expected throng, it meant that the interest in automobile racing had been overestimated in the West. Even if the events had been "National" instead of "Western," it is a safe assertion that the crowds would not have been any larger, for it must be remembered that the West is always loyal to anything which is branded as of the West.

Credit in huge hunks belongs to that committee which contains the names of Trego, Beecroft, Van Sicklen, Edwards, Sinsabaugh, Ayers, Root and Wheeler. And here, too, should be mentioned the many who helped the grand scheme in minor capacities. The Chicago Automobile Club has good cause to feel proud of its "Western Stock Chassis Races," and to Ira M. Cobe, president, a special vote of thanks is forthcoming.

One of the hitherto unaccomplished things in connection with the racing on the Crown Point circuit was the presence of Illinois State troops guarding an event in Indiana. In the East anything of this sort would have been denounced as "unconstitutional" and impossible. The fact that the races supplied the greater competitive spectacle of modern times free of charge to thousands, wouldn't have had the slightest bearing in the premises. The matter in which the West brushes aside precedent and takes the initiative is invariably most refreshing. It frequently is made to appear that the laws are for the people who have the red blood to insist that their interpretation shall mean the greatest good to the greatest number.

PRESIDENT COBE ON FUTURE RACES

Before the big race for the Cobe cup had concluded there was some talk of next year, and in the course of an interview President Cobe said:

"We do not know whether we want to attempt another race on this scale next year. Perhaps the West does not care enough for such an exhibition. Possibly it is new and we must first show them that the show is worth while.

"I do not think the club will lose \$25,000 by the two races. We will not know the cost for two weeks at least. It will be a considerable loss.

"I am inclined to believe that those most benefited by such an event as a big road race should assist appreciably in paying the cost of running it."

MATSON TELLS HOW HE WON

"The only man I was afraid of was Strang," said Matson. "I made up my mind to catch up with him if I could and cling to him all the way around. I did not know that he was disabled on the third lap, but thought he was ahead of me all the time. I knew I had the speed in my car and that my principal task was to hold the light machine together by conservative driving. The race was the fairest that I ever saw.

"None sought unfair advantage of another. During the race I passed every car but the Marion, driven by Monson, and entered as No. 6. Robertson in his Locomobile and I passed each other repeatedly, and he tried to out-manuever me.

"On the long west stretch of the course I blew out a tire, but Vaughan and I replaced it in one minute and fifty seconds.

"My car responded instantly to the levers, and the way it gripped the road made it hard on the rear tires. In addition to the one I wore out, the one on the other rear wheel wore clear through to the fabric. I knew it was in danger of going and that a stop to put on a new one might lose me the race. As we pulled into Lowell on each lap we knew exactly how far we were ahead. The Chalmers-Detroit camp had a big bulletin board there and gave us the time on each lap. In addition to the time lost changing the tire, we lost one minute and fifty-eight seconds shipping gasoline and water.

"On the last lap I knew that we were more than eight minutes ahead and had plenty of time. So I kept a steady pace and took no chances. It was on this lap that Robertson tried to jockey me out of the race. He knew my tire was bad and he passed me and fell back to tease me into sprinting ahead of him. This I would not do, but let him have third place, not to risk unnecessarily the race I already had won."

CHEVROLET'S OPINION OF THE BIG RACE

After the race was over, and the excitement had subsided enough to permit of actual thought, Louis Chevrolet had the following to say about his victory: "I drove the last eight laps of the race on nerve—nothing else. When I lost the use of one cylinder as the result of the hard jumping over the rocks I almost wanted to give up. But something told me to stay in. It must have been the training I received while a mechanic for Hemery, the greatest motor racing driver the world has ever known. He never has been known to give up. He taught me to drive that way in all my contests.

"It was a hard drive, though. I weighed myself Friday when the officials were inspecting the cars, and honestly, I'm twelve pounds lighter to-night than I was before the start. Two such contests in rapid succession will tell on any man. I wanted to hang up a road record, but the course was in dangerous shape. I can only say I am indeed happy, for hard luck followed my partners, Strang and Burman, all through the two races here."

Ante-Race Stories Scared Away the Crowds—Accounts of the great crowd that was expected, the high prices that would be charged for food and shelter, and the probability that visitors might go hungry, are thought to have kept many from the scene of action. There were vivid tales of how automobile-race goers might have to fight for something to eat and how they would be jostled about, so that officials have concluded that many stayed at home for that very reason. After it was all over, it was realized that the prices were no higher than might be expected, perhaps double, the charge for a 25 cent meal being 50 cents. There was no great dearth of food, and the crowd was not in an "ugly" mood, as some perhaps had feared. Coffee retailed for five or 10 cents a cup, depending upon how the purchaser asked for it and the appearance of the asker. Under cover the charge was a dime, but on the streets the same liquid was a nickel. Sleeping quarters were seldom, if ever, sold at more than \$3 a room, and those at \$10 were the unfortunate dreams of over-zealous press agents.



Chevrolet, the Winner, and Nelson, the Mechanic Who Helped

CROWN POINT, IND., June 19—Chevrolet in his contest for the Cobe trophy had to contend against four successive adversaries who confronted him at one time or another during the seventeen laps of the big race. Of these four (Burman, Denison, Robertson and Bourque) two (Burman and Denison) fell by the wayside before the race was one-third over, but the other two (Bourque and Robertson) contended to the finish. In the first two laps his team-mate Burman was his rival, Burman leading Chevrolet five seconds in the first lap, and fifteen seconds in the second. At this juncture, Denison with his Knox came to the fore, and not only took the lead away from Burman but placed himself also 42 seconds in advance of Chevrolet. In lap three Denison piloted the Knox around the circuit in 22:34, establishing the time record for the course. Lap four found Chevrolet to the front for the first time, having the advantage of but 12 seconds over Denison and 57 seconds over Burman. But his lead was short lived, as Denison, who had tire troubles, was destined to put the Knox to the front on the fifth lap in what proved to be the second fastest of the day, 23:08. Denison relinquished his hold, however, in lap six, due to tire troubles, he having to stop 2 minutes 10 seconds at the end of this lap to take on a tire and oil, and having lost more time during the lap changing a tire. This permitted Chevrolet to lead at the end of lap six with a margin of 2 minutes 22 seconds. Burman retired during this lap owing to gasoline troubles and went out of the race. No sooner had he ceased as a factor than both Robertson in his No. 9 Locomobile and Bourque in the No. 2 Knox entered into the first place conflict. Chevrolet had a lead of almost four minutes on Robertson and five minutes on Bourque, in the seventh lap, at which time Denison had gone out of the race owing to a breaking of a connecting rod. Denison stated previous to the start of the contest that his engine had been run for almost two years without the cylinders being taken off, and he had asked for a new engine before the start of the race.

With the fight in lap eight a three-cornered one involving Chevrolet, Robertson, and Bourque, the Frenchman gained an advantage on the seventh lap and finished 6 minutes 30 seconds to the good in the eighth. He was now leading Bourque's Knox by over 18 minutes, Bourque having stopped 7½ minutes in this lap at the grand stand to change tires and take on gasoline, oil, and water. But Chevrolet's pace was being rapidly eaten into by Bourque and Robertson. In lap nine Robertson cut the lead practically 2 minutes and Bourque lost but 6 seconds to Chevrolet.

It remained for lap ten to be Chevrolet's Waterloo, he requiring 44 minutes 1 second to make the circuit, while Robertson romped around in 24:57 and Knox in 27:17. This was the lap when Chevrolet had valve troubles. At the grand stand at the completion of the lap he changed two rear tires, took on gasoline, and some extra valves. The delay allowed Robertson to take the lead at the end of lap ten by a clear margin of 12 minutes 32 seconds.

Bourque at this time was only 1 minute 15 seconds behind Chevrolet. Lap eleven saw Robertson leading Chevrolet by 27 minutes 7 seconds, and Bourque leading him by the narrow margin of an even 10 minutes.

In lap twelve this order of Robertson-Bourque-Chevrolet remained, Robertson having dropped his lead to 19 minutes 14 seconds owing to a stop at Lowell. At the end of this lap he stopped at the grand stand for 4 minutes 40 seconds to take on supplies and change rear tires. This delay accounts for his losing 6 minutes to the Frenchman.

If lap ten was Chevrolet's hoodoo, lap thirteen proved the undoing of both Robertson and Bourque. Robertson had a 6 minutes stop during the lap at Lowell because of ignition troubles, and when he reached the grand stand at the completion of this lap 13 minutes were needed to change the magneto and do some other adjusting. Part of this proved fruitless, as a test of the magneto immediately after it was off showed it was in perfect working condition. While Robertson was working over his difficulties, Bourque was aware of his. During this lap Bourque had filled with water and failed to close the petcock at the base of the radiator, so that when he reached the grandstand not a drop of water remained in the radiator or jackets. It was taking too great a chance to pour cold water into the jackets, and by

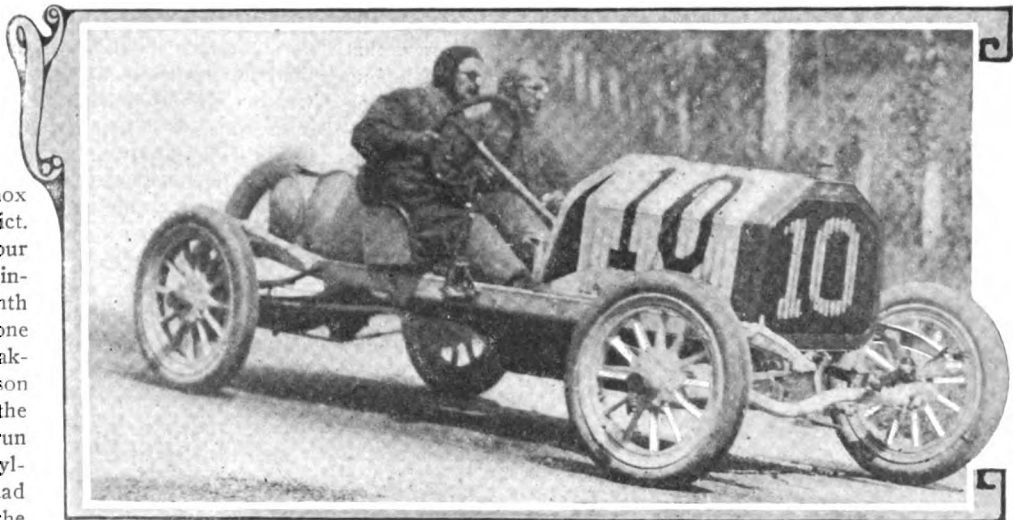

Chevrolet (Buick) Took Corners Skillfully But Cautiously

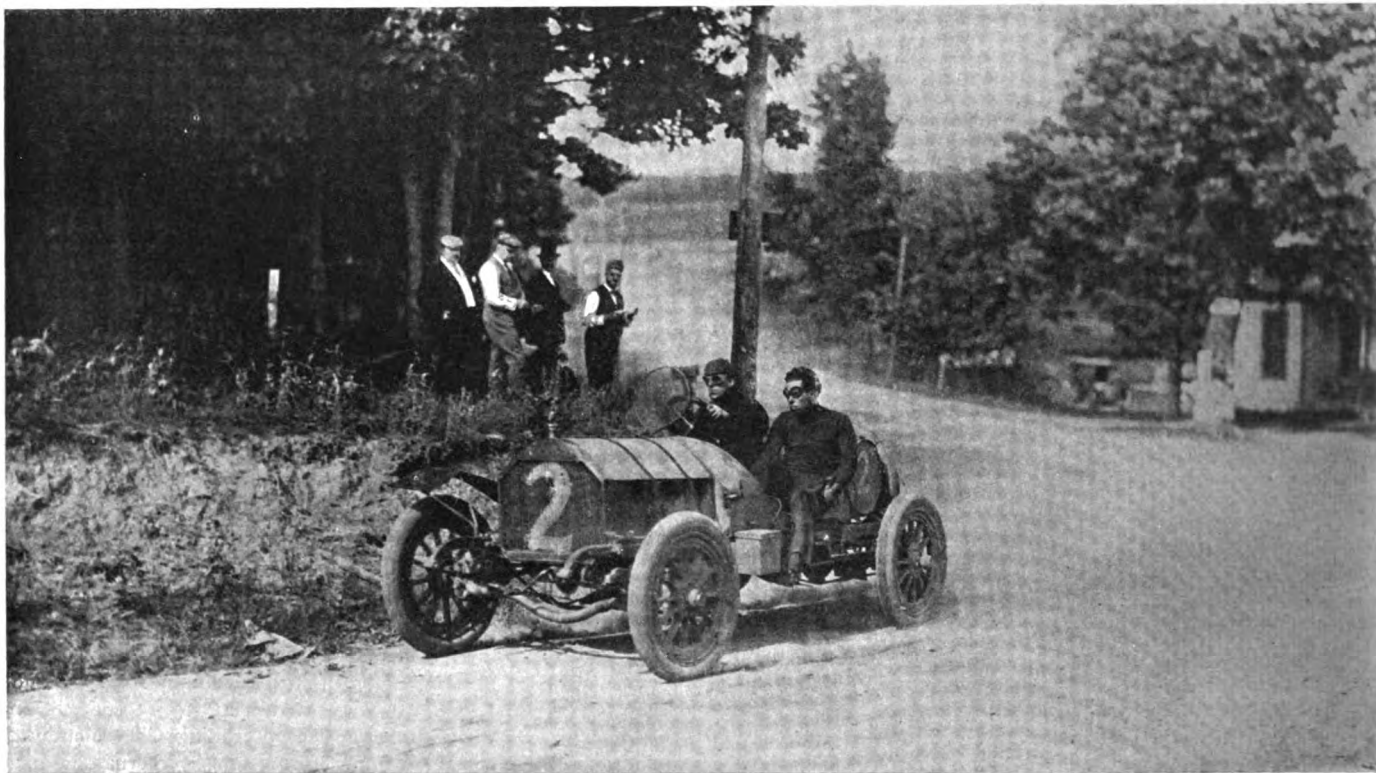

Bourque (Knox) Once Appeared a Certain Winner, and Supplied the Gamest Kind of Flight to Finish

actual stopwatch he consumed 12 minutes 40 seconds for gasoline, water, and oil and getting started. These extraordinary delays proved the undoing of Robertson, who dropped from first place to third, and Bourque took the lead by slightly over a 6 minute margin from Chevrolet.

Chevrolet, starting with lap fourteen, had settled down in the run for the finish, having enough tires and sufficient gasoline and oil to carry him over the finishing line. He held the lead throughout the remaining four laps, although Bourque was gradually reducing it. In lap fourteen he led Bourque's Knox by 2 minutes 54 seconds. In the fifteenth lap Bourque cut 40 seconds off of this. In the sixteenth lap he reduced it 53 seconds more, and in the seventeenth lap he cut 16 seconds off. But it was not sufficient to win, as it left the Frenchman a final margin of 1 minute 5 seconds, with Robertson 12 minutes in the rear.

While Chevrolet, Bourque, and Robertson were fighting out the first positions, an interesting struggle was taking place between Hearne in No. 11 Fiat and Englebeck in No. 5 Stoddard-Dayton, the former finally winning out.

Although the real struggle was among the five cars that actually finished the contest, there were other factors in the race that kept matters at fever heat until they dropped out. Chief among these was Miller's No. 1 Stoddard-Dayton, which was a strong factor up to the fourteenth lap, when it was eliminated by shearing four pins in the universal joint in the propeller shaft. The report was circulated that the car was in a ditch with two rear wheels off, which proved false, as Miller brought the car to the grandstand before the finish of the race, having taken two pins out of the other universal joint to repair the broken one. His third lap was one of the fast laps of the day, being made in 24:11.

Strang, who was looked to as a possibility, never proved dangerous. In lap one he stopped to take on a supply of valve pins which had been giving trouble, and in lap five was stopped for 1 hour 10 minutes in front of the grandstand while the mechanic effected some valve repairs. After this he made attempts at the lap record, but failing to get closer than 1:23 seconds of the mark set by Denison's Knox in lap three.

First Lap—Following their tactics in the Indiana trophy race, the Buickers again started to burn up the road in the Cobe cup and the result again showed that the Buicks had made the best

time for the initial lap, Burman, last to start, having negotiated the circuit in 24:15, which was 34 seconds slower than Burman himself had done in the curtain-raiser. The first one past the grand stand in this lap was Bourque in the Knox, who had caught and passed Miller in the Stoddard on the west leg. Chevrolet, even thus early showed he was not to be overlooked, for in point of time he was second to his team mate. Bourque was in third place, while Denison was just warming up in fourth. Seymour was the first to experience trouble on this lap. At the very first turn he slapped on his brakes, which, however, were covered with oil. So terrific was the pace at which Seymour was going that he skidded completely around on the road and tore off two tires. Finishing this lap, Strang was the first to go to the pits, a pin on a rocker arm having been lost. Burman's pace may well be imagined when it is known that he was timed over the special mile stretch at 87.6 miles per hour.

Second Lap—Bourque still continued to hold his place at the head of the procession, finishing the second lap, although he was not the actual leader. Burman still had that honor, his second lap being even faster than his first. Chevrolet, too, was putting up a good battle against Father Time and was runner-up. While the racers were going on this lap the report came that Florida was out of the race without even finishing one round, a sleeve on a camshaft breaking and ending his career just after turning into the home stretch. Denison was becoming a factor even thus early, and the running of the Knox made it a favorite.

Third Lap—This round furnished a big sensation and made Denison and the Knox even greater favorites, for the time showed a record had been broken, Denison having negotiated the circuit in 22:34, the fastest time ever recorded for the circuit and equal to 62 miles an hour. This terrific pace carried him to the front. Burman had slipped back to third and his team mate, Chevrolet, still hung to second place, being 42 seconds back of Denison. Bourque in the other Knox hung onto the lead and was in fourth place, while Robertson was "jogging along" fifth. There was only 3 minutes 21 seconds between first and fourth, so it was becoming a real race.

Fourth Lap—Denison slowed a bit the fourth round, while Chevrolet, continuing his even pace, went to the front, having the lead by 12 seconds. Burman was holding third, while

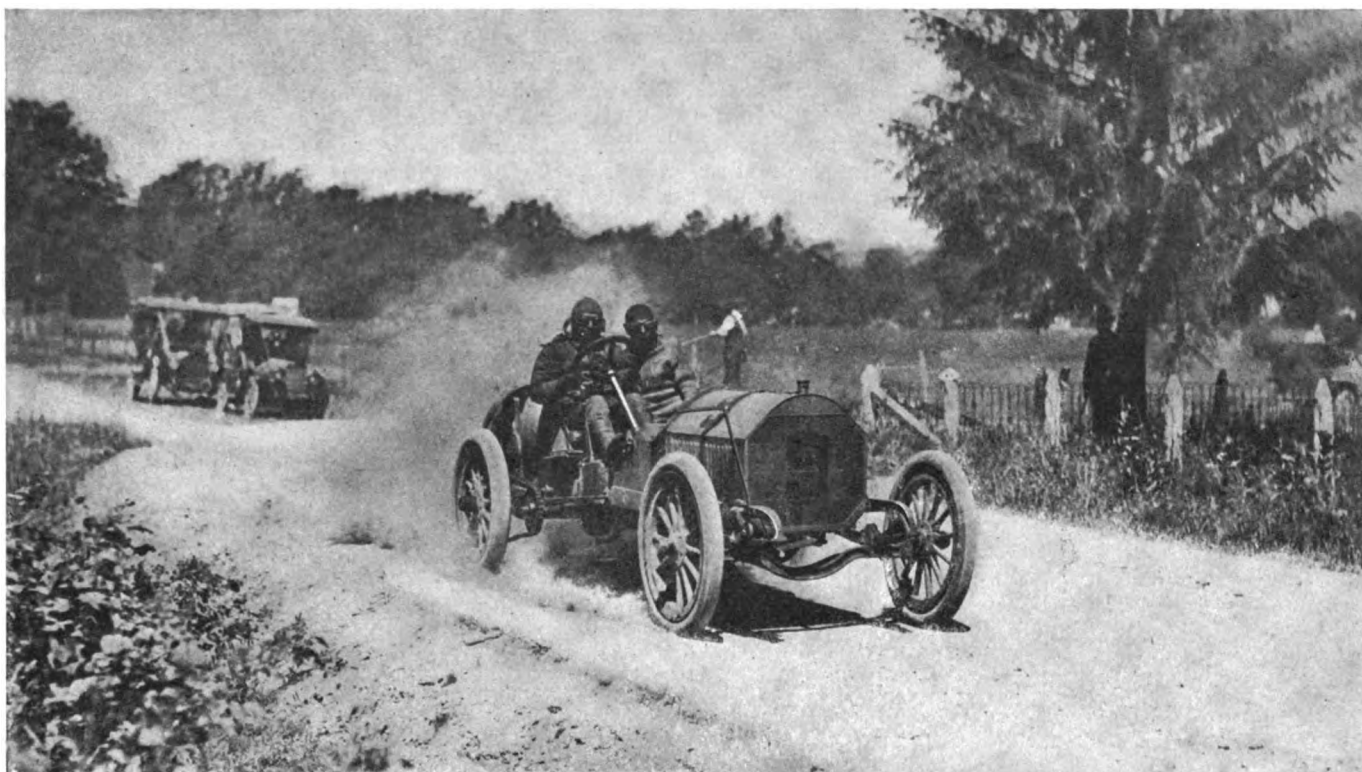

Robertson (Locomobile) Rounding Cemetery Turn Without Any Apparent Thought of the Hereafter

Bourque was fourth. Seymour had enough on this round, a broken connecting rod stopping him near Cedar Lake. It seemed at this stage as if the contestants had settled down to a steady grind, realizing that a 400-mile race was far from being a sprint.

Fifth Lap—Denison got his second wind in this round. He went out after Chevrolet and got him, his round in 23:08 being the second fastest on record. Chevrolet was only 5 seconds slower than on his fourth round, but Denison picked up enough to make him the leader of the race by 1 minute and 19 seconds. The way he was going it looked as if he would maintain the lead to the end. Still, the first five were remarkably close, there being only some 3 minutes separating first and fifth. Hearne in the Fiat was plugging along consistently, evidently having laid out a schedule and being determined to hold to it.

Sixth Lap—Chevrolet came into his own on this lap, closing up on Denison and being better than 2 minutes to the good of the Easterner who had again slowed after a fast round. Chevrolet had done his lap in 25:47, his slowest so far, while Denison had dropped back to 29:28. Burman had engine trouble and quit after having been in third place; this, of course, moved Bourque up a peg. Robertson in the Loco was holding his own, while Hearne was showing regularity and precision of running.

Seventh Lap—Denison went down and out on this round, a connecting rod breaking and the front end of his car catching fire. This removed a most formidable rival from Chevrolet's path and he was glad of it, for his pace was slowing as was that of the others. Robertson profited and climbed to second, becoming at once a favorite with the people, who declared the Vanderbilt winner was just about to make his run to the front. It looked that way at least, although on this round Chevrolet had the fastest time. Robertson was more than 4 minutes back of the flying French leader.

Eighth Lap—The Frenchman again clipped off the fastest lap in this round, doing 25:50, while Robertson slowed, although holding second place. Bourque was still third, while Miller was fourth. Englebeck was holding fifth, with Hearne sixth. Lytle, in seventh place, was having trouble with his magneto and a broken spring, but still was on the move.

Ninth Lap—Again it was Chevrolet who held the time honors when this round was completed and it was with Robertson

grimly hanging on. At this stage the Locomobile driver gave evidence that he was not to be overlooked and that he was far from being beaten. His was the fastest round, the watches giving him 25:38. Chevrolet had dropped to 27:14, his slowest of the race, and there was a difference of but 5 minutes between the two. Bourque hung to third and in fourth place was Miller in the No. 1 Stoddard, who was just ahead of his running mate, Englebeck. Hearne was sixth and the last man with a chance to win.

Tenth Lap—This round nearly saw the end of Chevrolet, for it was on this lap that he had his engine trouble, a valve breaking and getting into a cylinder and punching a hole in the piston. But the Frenchman was not discouraged. He patched it up as best he could and continued on three cylinders. This gave Robertson his chance and the Locomobile shot to the front by virtue of a lap in 26:35 to 44:01 for Chevrolet, and led by 13 minutes and better. Bourque was still third and Miller fourth.

Eleventh Lap—Lytle withdrew at this stage of the race, leaving only seven cars, of which number the Strang-Buick was practically out. Robertson continued making his fight for the cup and it began to look very dubious for Chevrolet. Robertson cut out 24:57, it being the third consecutive time he had made the fastest round, and he had Chevrolet by 16 minutes. It seemed all over but the shouting, but Chevrolet limped along grimly on those three cylinders, determined to finish at any rate. His trouble had relegated him to third and Bourque found himself in the position of runner-up. Miller was fourth and Hearne fifth.

Twelfth Lap—Robertson began to have trouble at this stage of the race. He was held up 6 minutes at Lowell and while he was first when the tape was crossed his lap was a slow one—36:20. Still, he was 20 minutes ahead of Chevrolet, who had dropped to third place, while Bourque had gone to second. All the cars were slow on this lap, the 26:13 of Bourque being easily the fastest.

Thirteenth Lap—A new leader developed this time around, Bourque going to the front for the first time in the race. He had an advantage of 7 minutes over Chevrolet, both of them having caught and passed Robertson. The Locomobile man thought his magneto was giving trouble and he released his grip on the

lead when he stopped in front of the stand to change for a new one. It is said, however, that it simply was a case of a loose igniter and that Robertson could have stuck in front if he had tightened that instead of using up his lead changing magnetos.

Fourteenth Lap—Bourque did not hold the lead long. He had to stop at the pits in this round and while he was working on his car, Chevrolet again came into his own with 3 minutes' lead over the Knox. Robertson was again running good and in third position, while Englebeck was fourth and Hearne fifth.

Fifteenth Lap—It was getting interesting at this stage of the proceedings. Bourque was fighting to again catch Chevrolet and the Buicker was struggling to keep in front. Hearne made

would have had to beat Chevrolet more than 13 minutes on the lap, and that looked impossible. So Bourque was the only one with a chance and the crowd got up on its toes to watch the fight which only ended at the finish.

Seventeenth and Final Lap—Bourque was the first to finish the race, dashing across the tape at a good clip. Then came a wait for Chevrolet and as the watches ticked off the seconds it looked like a Knox victory. Finally, however, the trumpets sounded and at the top of the second hill there appeared a car. It was coming fast and as it shot under the bridge at the south end of the stand, and across the finish line, the people recognized Chevrolet. Even then they were not sure he was the victor and



Scene in Crown Point's Courthouse Square, Which Was a Storm Center, with Fakira in Abundance

the best time on the lap and was getting up nearer to the leaders, but Chevrolet was still in front. Bourque picked up nearly a minute on his rival and it looked like a close finish.

Sixteenth Lap—Chevrolet, Bourque, Robertson and Englebeck was the order beginning the last lap. Chevrolet had 1 minute 21 seconds advantage over Bourque, while Robertson was so far back that he was not regarded as a factor. To win he

few cheers were heard as he crossed the tape. The people waited breathlessly for the verdict of the timers. Finally it came, showing that the Buick had won the Cobe Cup by the narrow margin of 1 minute 5 seconds, having averaged 49.3 miles per hour to the 49.2 of Bourque in the Knox. Robertson came third at 48, Hearne in the Fiat fourth in 47.2 and Englebeck fifth in 46.9. The unlucky Strang still was running when the race was called off.

HOW THE LEAD SHIFTED DURING THE LONG RACE FOR THE COBE CUP

No.	Car	Driver	Mechanic	H.P.	Tires	1st Lap	2nd Lap	3rd Lap	4th Lap	5th Lap	6th Lap	7th Lap	8th Lap	9th Lap	10th Lap	11th Lap	12th Lap	13th Lap	14th Lap	15th Lap	16th Lap	Fin- ish
10	Buick	Chevrolet	Nelson	32.4	Michelin	2	2	2	1	2	1	1	1	1	2	3	3	2	1	1	1	1
2	Knox	Bourque	Holcomb	40	Fisk	3	3	4	4	4	3	3	3	3	3	2	2	1	2	2	2	2
9	Locomobile	Robertson	Etheridge	40	Michelin	5	5	5	5	5	4	2	2	2	1	1	1	3	3	3	3	3
11	Fiat	Hearne	Tower	42	Michelin	9	8	8	8	8	7	7	6	6	5	5	4	5	5	5	5	4
5	Stoddard-Dayton	Englebeck	Tarkington	44.1	Michelin	8	7	6	7	7	6	4	5	5	6	6	6	5	4	4	4	5
1	Stoddard-Dayton	Miller	Harcombe	44.1	Michelin	7	9	7	6	6	5	5	4	4	4	4	4	6				
4	Buick	Strang	Kuntz	32.4	Michelin	10	10	11	10	10	9	8	8	8	8	8	7	7				
8	Apperson	Lytle	Bates	53	Michelin	6	6	9	9	9	8	6	7	7	7	7						
7	Knox	Denison	Belcher	48.4	Fisk	4	3	1	2	1	2											
12	Buick	Burman	Grinnon	32.4	Michelin	1	1	3	3	3												
3	Apperson	Seymour	Hanschue	53	Diamond	11	11	10														
6	Locomobile	Florida	Campbell	40	Michelin																	

COBE CUP RACE, THE WEST'S FIRST VANDERBILT, JUNE 19, 1909—DISTANCE, 396.65 MILES; CIRCUIT, 23.27 MILES

No.	Car	Driver	1	2	3	4	5	6	7	8	9	10	11	12	13	14	15	16	17
10	Buick	Chevrolet	23:27 M	46:54 M	69:82 M	93:09 M	116:37 M	139:64 M	162:91 M	186:19 M	209:46 M	232:74 M	256:14 M	279:28 M	302:56 M	325:83 M	349:11 M	372:38 M	395:65 M
			0:48:32	1:12:43	1:42:43	2:01:39	2:27:26	2:53:05	3:18:55	3:46:09	4:10:10	4:30:10	4:58:42	5:38:09	6:07:36	6:36:12	7:04:50	7:33:38	8:01:39
			24:20	24:11	24:17	24:30	25:37	25:59	25:59	27:14	28:32	29:27	28:56	29:27	28:56	28:58	29:48	29:48	28:01
2	Knox	Bourque	0:49:27	1:14:39	1:44:39	2:05:45	2:31:32	2:58:49	3:37:10	4:04:30	4:31:25	4:58:42	5:26:55	5:56:06	6:00:57	6:39:06	7:07:04	7:34:59	8:02:44
			24:46	25:12	25:30	25:36	25:37	27:17	28:21	29:30	26:35	26:35	24:37	26:20	34:02	38:09	27:58	27:55	27:25
9	Locomobile	Robertson	0:50:03	1:15:24	1:41:15	2:06:26	2:31:40	2:57:50	3:23:25	3:51:03	4:17:38	4:43:35	5:18:55	5:48:55	6:11:53	6:51:10	7:18:45	7:46:17	8:14:30
			25:44	25:21	25:51	25:11	25:14	26:10	26:10	26:38	26:38	24:37	26:20	36:20	52:58	39:17	27:55	27:32	28:13
11	Fiat	Hearne	0:54:56	1:22:08	1:52:08	2:18:28	2:52:19	3:20:24	3:51:00	4:24:38	4:53:31	5:22:21	5:50:58	6:22:23	6:59:45	7:26:49	7:54:11	8:22:04	
			27:03	27:12	28:18	28:02	28:52	33:51	30:36	33:58	28:33	28:30	28:50	31:23	37:22	27:04	27:22	27:53	
5	Stoddard-Dayton	Englebeck	0:51:45	1:18:25	1:47:25	2:15:48	2:44:24	3:10:15	3:44:51	4:16:05	4:56:05	5:25:14	5:54:44	6:23:45	6:52:25	7:23:56	7:53:53	8:26:05	
			24:19	26:40	31:32	25:51	28:36	25:51	34:36	31:14	40:00	29:30	29:30	28:01	28:40	31:31	29:57	32:12	
1	Stoddard-Dayton	Miller	0:57:11	1:21:22	1:47:14	2:12:33	2:43:37	3:13:26	3:42:19	4:11:50	4:49:40	5:15:15	5:46:34	6:13:15	6:43:15	7:13:15	7:43:15	8:13:15	
			26:25	30:46	24:11	25:52	25:19	31:04	29:49	28:53	37:41	31:19	31:19	28:11	28:11	28:11	28:11	28:11	
4	Buick	Strang	1:01:46	1:35:36	2:10:09	2:42:42	3:15:04	3:47:04	4:20:01	4:54:39	5:28:57	6:02:57	6:46:57	7:17:44	7:45:04	8:13:15	8:41:15	9:09:15	
			30:51	30:55	33:50	34:33	33:50	34:33	33:57	38:57	38:57	27:06	30:47	27:20	28:11	28:11	28:11	28:11	
8	Apperson	Lytle	0:51:15	1:25:37	1:57:43	2:24:42	2:52:39	3:19:49	3:48:17	4:16:45	4:45:14	5:13:43	5:42:12	6:10:41	6:39:10	7:07:39	7:36:08	8:04:37	
			25:33	25:42	34:22	34:22	32:06	26:41	28:17	27:10	44:46	33:42	29:59	1:29:20					
7	Knox	Denison	0:49:27	1:12:01	1:37:12	2:00:20	2:29:48	2:59:28	3:28:57	3:58:26	4:27:55	4:57:24	5:26:53	5:56:22	6:25:51	6:55:20	7:24:49	7:54:18	
			25:13	24:14	22:34	23:08	23:08	29:28	29:28	29:28	29:28	29:28	29:28	29:28	29:28	29:28	29:28	29:28	
12	Buick	Burman	0:48:17	1:13:07	1:37:57	2:02:51	2:27:45	2:52:39	3:17:33	3:42:27	4:07:21	4:32:15	4:57:09	5:22:03	5:46:57	6:11:51	6:36:45	7:01:39	
			24:15	24:02	24:50	24:50	24:54	24:54	24:54	24:54	24:54	24:54	24:54	24:54	24:54	24:54	24:54	24:54	
3	Apperson	Seymour	1:03:28	1:28:13	1:52:58	2:17:43	2:42:28	3:07:13	3:31:58	3:56:43	4:21:28	4:46:13	5:10:58	5:35:43	6:00:28	6:25:13	6:49:58	7:14:43	
			36:03	27:25	24:35	24:35	24:35	24:35	24:35	24:35	24:35	24:35	24:35	24:35	24:35	24:35	24:35	24:35	
6	Locomobile	Florida																	

Out. Sheared pins-universal joint.
Race called off on Strang's thirteenth lap.
Out. Broken spring and magneto trouble.

Out. Broke connecting rod.
Out. Burst gasoline tank in ditch.
Out. Broken connecting rod.
Out. Ditched on first lap; out.



Englebeck (Stoddard-Dayton) Takes on Supplies
SPEED OF LEADERS IN COBE CUP RACE

Car	Driver	Miles	Time	M.P.H
Buick	Chevrolet	395.65	8:01:39	49.3
Knox	Bourque	395.65	8:02:44	49.2
Locomobile	Robertson	395.65	8:14:30	48.0
Fiat	Hearne	395.65	8:22:04	47.2
Stoddard-Dayton	Englebeck	395.65	8:26:05	46.9

REGULARITY OF RUNNING IN COBE CUP RACE

Car	Driver	Fastest	Slowest	Variation
Fiat	Hearne	27:03	37:22	10:19
Knox	Bourque	24:41	38:21	13:20
Stoddard-Dayton	Englebeck	24:19	40:00	15:41
Buick	Chevrolet	24:11	44:01	19:50
Locomobile	Robertson	24:57	52:58	28:01

FASTEST LAPS OF CARS IN COBE CUP RACE

Car	Driver	Lap	Time	M.P.H
Knox	Denison	3rd	22:34	61.9
Buick	Strang	6th	23:57	58.3
Buick	Burman	2nd	24:02	58.1
Stoddard-Dayton	Miller	3rd	24:11	57.9
Buick	Chevrolet	3rd	24:11	57.9
Stoddard-Dayton	Englebeck	2nd	24:19	57.45
Knox	Bourque	1st	24:41	56.7
Apperson	Seymour	3rd	24:45	56.6
Locomobile	Robertson	11th	24:57	56.0
Apperson	Lytle	1st	25:33	54.7
Fiat	Hearne	2nd	27:03	51.7

Note—A number of facts not brought out by the four tables given on this page and the one on the opposite page are of interest. Thus, Denison, who had such hard luck, after making a determined bid for the lead, not only heads the list of fast laps, but made the second best also. This was on the fifth lap, when rising from second to first position, he did 23:08. Following this a slow one in 29:28 put him back into second place. The remarkable regularity of running of the two Locomobiles in the Indiana did not have any counterpart in the Cobe. In the former race, no one of Robertson's first five laps varied more than ten seconds from 28 minutes for the circuit. At the same time, Florida was reeling them off close to 29:30, no one of his first seven being farther away from that mark than 30 seconds.

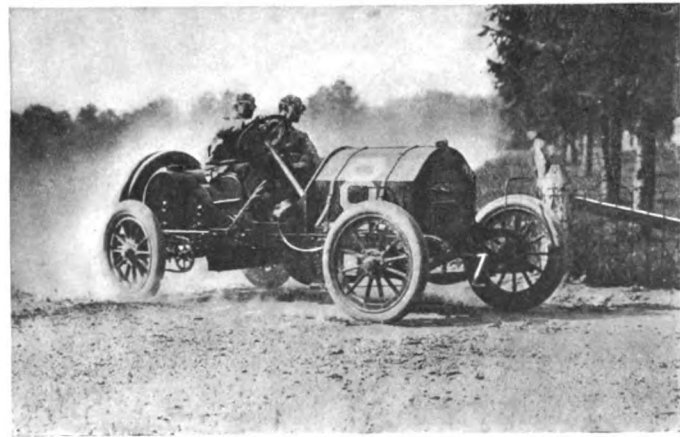

Lytle Taking His Apperson Around Graveyard Turn

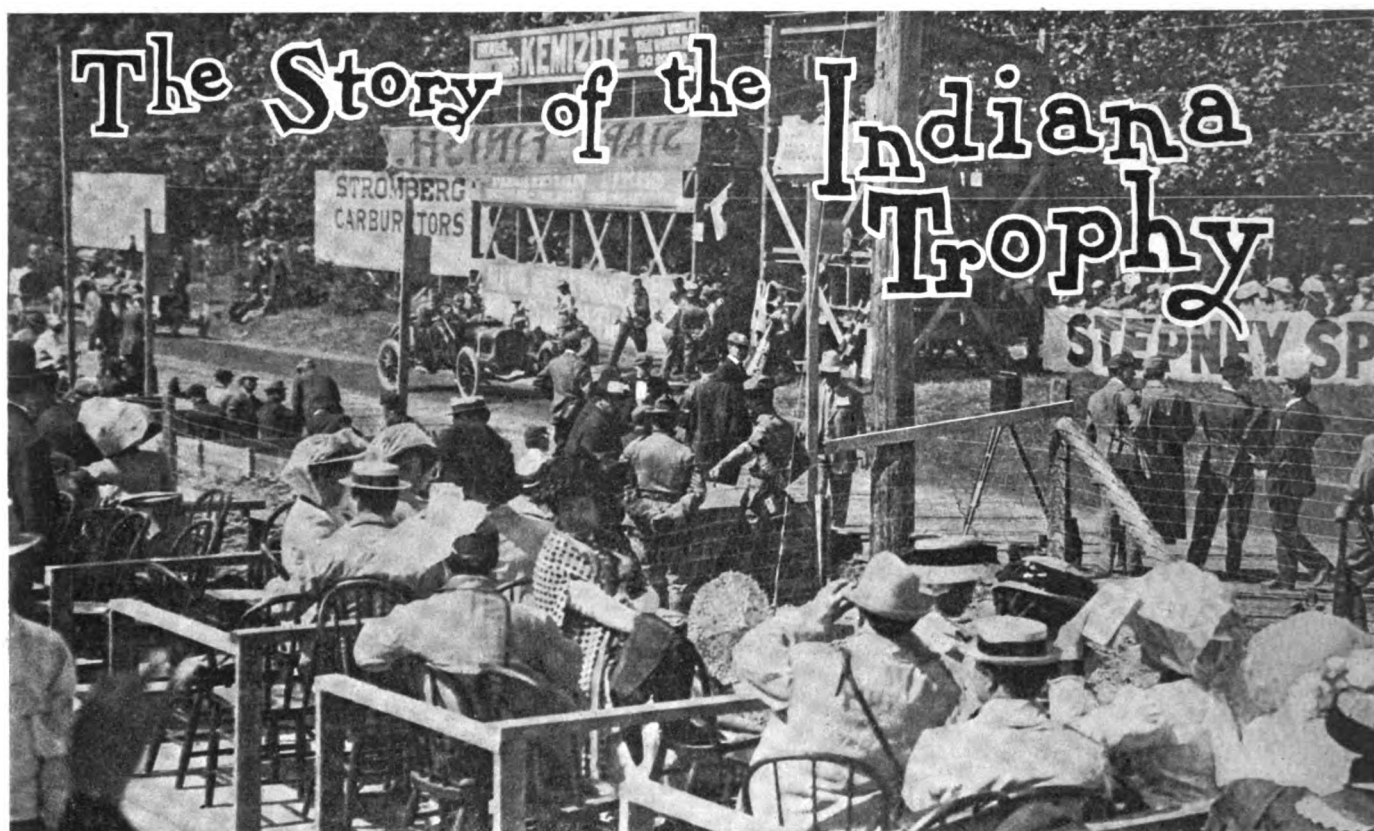

Small Cars Lining Up for the Indiana Trophy Event on the First Day

CROWN POINT, IND., June 18—That the 232.74-mile road race held to-day for the Indiana trophy will go down in history as one of the greatest small-car races in America is beyond doubt. Of the sixteen starters, nine were running at the finish, and six completed the ten laps, thereby setting the record for the greatest number of finishers in any American road race. The cars were all tuned to the minute, which is borne out by the consistent running of many of them. The winning Chalmers team had been on the course early, and the little cars had been doing consistent work in the daily practicing. A surprising feature of the race was the speed the little cars made and the reliability they showed. After the first two or three laps, many predicted they would soon stop, but these "Doubting Thomases" were more surprised to find them running with the same regularity at the end of the 232 miles. The speed of Matson's winning Chalmers was greater than had been anticipated, and, as after events proved, it maintained a higher average for its ten laps than did the winner of the Cobe trophy for the seventeen laps of the following day.

According to his own words, Joseph Matson, driver of No. 19, winning Chalmers-Detroit, was not certain as to his status in the race until the fifth lap, when he had sufficient lead to give reasonable assurance of winning with consistent running. Matson started out slowly, requiring 29 seconds for the first lap, which put him in eleventh place, Strang and Burman, in Buicks, setting the fastest times. Strang was eliminated in lap two by breaking an axle, and Matson, by driving the lap in 25:43, was able to climb from eleventh to third place, leaving Burman in first place with 5 minutes' margin, and Poole, his running mate, in another Chalmers, 67 seconds ahead of him.

Lap three was the one that gave first evidence of Matson's work, and when he finished this lap and had landed in first place, overtaking ten competitors in two laps, it was good evidence of what might be expected at the finish. As it was, he got the lead and held it tenaciously to the end with the exception of lap four, when Knipper, his running mate, wrested it from him by 2 seconds. Unfortunately Knipper cracked a cylinder in the fifth lap and the promised fight between Matson and himself vanished.

Laps three and four were essentially Chalmers-Detroit laps in that Matson, Poole, and Knipper, driving the Chalmers team, were the three leaders. In lap three the times were: Matson, 1:20:24; Poole, 1:20:28; Knipper, 1:20:47. But 25 seconds separated the three, and in lap four this triangular home fight continued, with Knipper, 1:46:27; Matson, 1:46:29, and Poole, 1:46:54.

In lap three Chevrolet, Robertson, Wells in a Moon, and Wiseman in a Stoddard-Dayton, were trailing the Chalmers trio closely, but in lap four, Chevrolet was out because of valve troubles, leaving Mosen in the Marion, Robertson in the Locomobile, and Wells in the Moon, close rivals. Lap five saw Matson back in first position, his running mate, Poole, two minutes later, a five-minute margin separating Mosen in third place, and a seven-minute safety gap between him and the Locomobile. This was the first period in the race when the leader had a minute or more leeway, and gave him an opportunity to plan a complete run. This order of Matson leading with Mosen-Marion and Robertson's Locomobile in close pursuit continued through laps seven, eight and nine, and in the final lap Robertson moved up into second place, leaving Mosen in third.

While the struggle among these three for three first positions was engrossing attention, an interesting contest was taking place among Florida's Locomobile, Wells in the Moon, and Wiseman driving a Stoddard-Dayton. In lap seven Wiseman's time was 204 minutes 3 seconds, Wells' time 204 minutes 26 seconds, and Florida's 205 minutes 22 seconds. Lap eight saw Wells take the lead of the trio with Florida next, and Wiseman third. In lap nine Florida had taken what proved to be fourth honors away from the Moon, which was running but 43 seconds behind it, and the Stoddard was nearly a minute later. This order changed in the final lap, Florida still holding to fourth position, but Wiseman moving the Stoddard up into fifth, and the Moon finishing in sixth scarcely 3 minutes later.

Viewed from the grand stand, the race was entirely bereft of pit incidents, not a single car having to change tires at the pit during the run. Wiseman in the Stoddard-Dayton stopped in the third lap to take on oil, requiring exactly 1 minute and 25 seconds. Robertson halted his Locomobile exactly 50 seconds in the

fifth lap to replenish with oil and gasoline, and in this lap the Moon, No. 11, took on oil. A bad leak in the oil tank was discovered and 3 minutes and 45 seconds consumed in filling the tank and trying to repair the leak. Matson made four stops during the run. In lap one, he changed a tire due to a blow-out about 5 miles from the start. In lap four another blow-out occurred, and in lap seven he stopped at the grand stand for gasoline and oil.

First Lap—Evidently the Buick team had received instructions to "beat it" from the start, for both Burman and Strang wasted no time in getting under way, Burman, in particular, clipping out a pace for the first lap that was faster than anything that had been shown in practice by the little cars. He soon caught Maisonville in the Corbin, who had started first. This left Burman out in front and the Buicker improved the opportunity afforded by the clear course to whiz around the circuit in 23:41. Strang, his team mate, showed 24:32 2-5, having caught Robertson and crossing the tape with Pearce in the Fal-car. Even at this early stage, though, the Chalmers-Detroit got into the running and it was Knipper in No. 5 who was third in point of time, his lap figures being 25:55. Maisonville was in fourth place and Pearce in the Fal-car fifth. The only absentee on this circuit was Ruehl in the Fal-car, who, however, managed to make the lap several hours later, crossing the tape for the first and only time after seven laps of the race had been run. It was apparent that the ones who later became the most important factors in the fight for the trophy were in no hurry at the start, for Matson was tenth in point of time, his first lap being his slowest. Robertson, too, "jogged" around the first time, being eighth, while Mosen was just ahead of him.

Second Lap—This terrific pace began to tell in the second round. Strang and Burman continued their helter-skelter clip and the former got his quietus at the cemetery turn at Lowell, where he stripped a pinion on his rear axle and took the count. Burman, however, managed to hold the lead he had gained in the first lap, but his time for the second circuit was considerably slower by nearly 3 minutes. With Strang eliminated, Wiseman in the Stoddard became second. His two laps were remarkably consistent, the first being 27:58 and the second 27:36.

Poole, running evenly and going within 6 seconds of his first lap time, climbed to third place, while Matson, the ultimate winner, quickening his pace by some 4 minutes, went to fourth place from tenth. The round closed with three cars out of the running—the two Fal-cars and the Strang Buick.

Third Lap—Burman began experiencing trouble in this round and relinquished the lead he had gained the first two laps. He sifted back in the rapidly moving field and was ninth when he crossed the tape. At this stage the Chalmers colors came to the front and the finish of the lap saw all three Bluebirds flying out in front, Matson leading, with Poole second, and Knipper third. Chevrolet showed his first and only flash on this lap when he worked up into fourth place, nearly a minute back of Knipper. The race had settled down to a grind and the sprinters evidently had given up all idea of running the

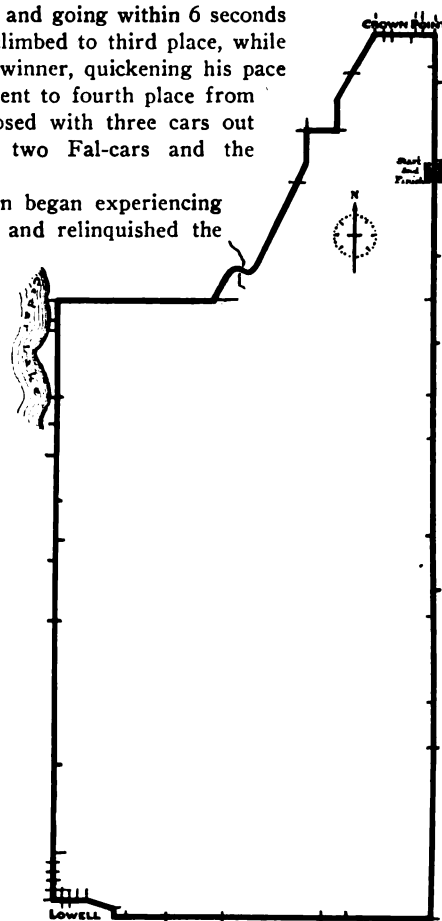

Map of the Course

legs off the others. The Chalmers drivers were running on a well-arranged schedule and it looked even at this stage as if they

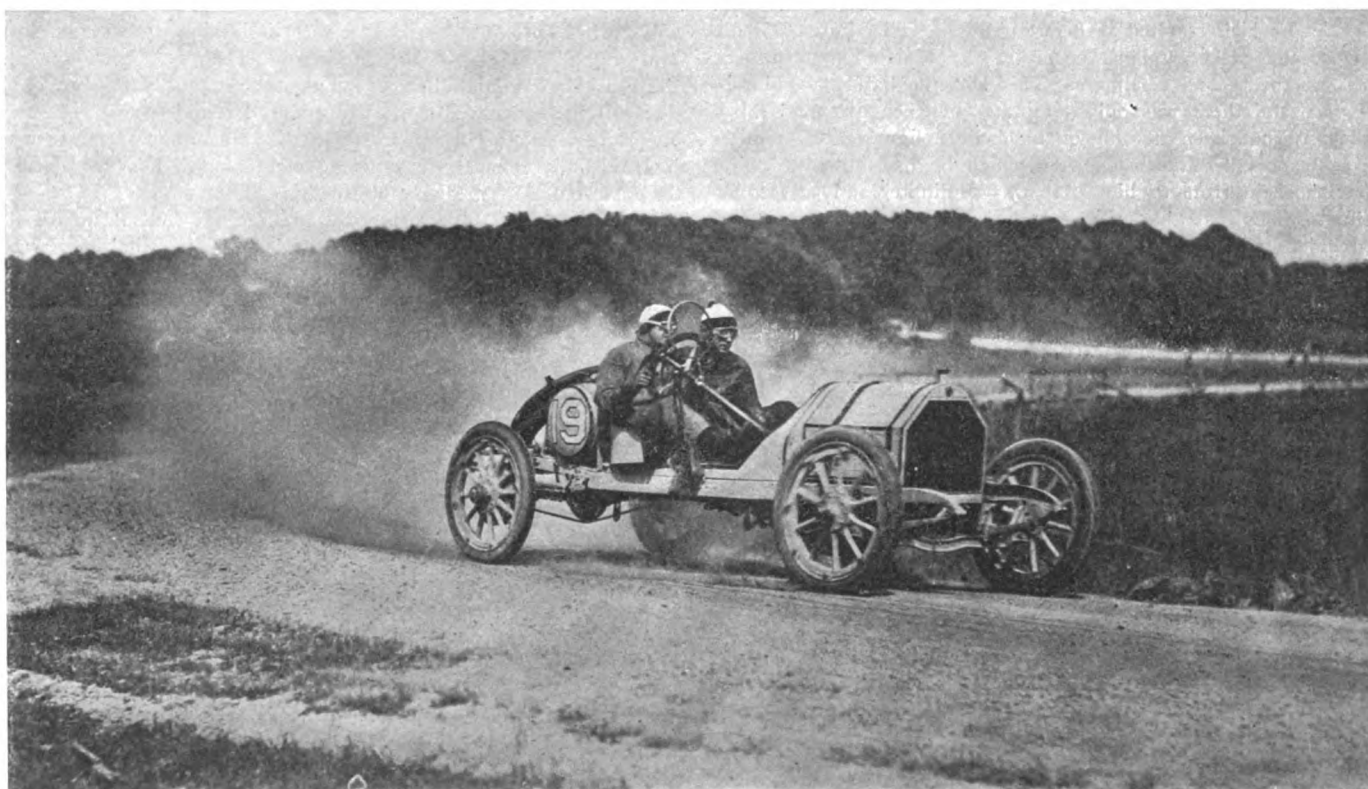

Matson and His Chalmers-Detroit "Bluebird" Rounding the Much-Talked-of "8" Turn

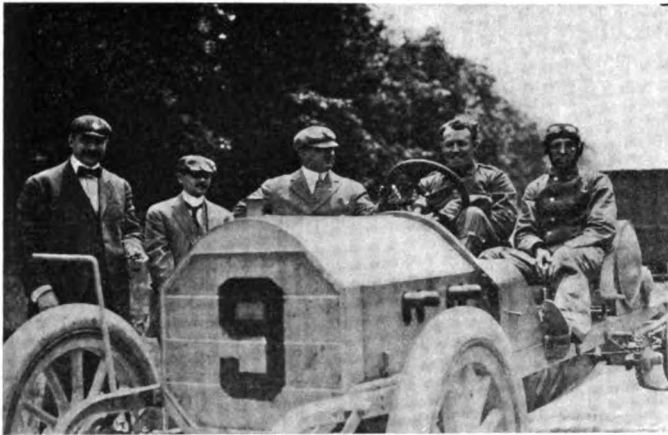

Designer Riker, Driver Robertson, and the Big Locomobile

were going to have a lot to say at the end of the race. The three Bluebirds were identical in appearance, and judging by the manner in which they were running, predictions were made that two of them would be in the first three.

Fourth Lap—Billy Knipper showed his nose in front in the fourth lap when he came up from third place and assumed the lead. His mates, Matson and Poole, were right with him, though, there being only 27 seconds separating the first and third Chalmers, showing remarkable consistency of running and a well-arranged schedule. On this lap Chevrolet had enough and retired from the contest, leaving an even dozen cars still running. It was engine trouble in his case. Monsen in the Marion had crept up a place through the retirement of Chevrolet, while Robertson in the Locomobile and Wells in the Moon were traveling well. The whole field was well bunched at this stage of the proceedings, all of the first six cars being inside a 6-minute blanket.

Fifth Lap—It was only a temporary eclipse for Matson when Knipper passed him in the fourth lap, for at the finish of the fifth Matson again was clipping out the pace and he never was ousted from the lead from this point on. The Chalmers suffered the loss of one man in this lap when Knipper broke an oiler lead which resulted in his retirement. This jumped Poole into second place, while Monsen in the Marion stuck to the heels of the second Chalmers. This was the half-way point in the race and there was only 5 minutes between first and third. Robertson had been running on a schedule, figuring on 51 miles an hour for the first half, after which he had intended going after those in front of him. He was 7 minutes and 30 seconds behind Matson at the half-way mark and those in the stand concluded that Robertson had his work cut out for him, so well was the Chalmers running. Ten cars were left in the fight at this point, but of these ten, only eight had any kind of a



Monsen and the Consistent Marion, Which Finished Third

chance. Maisonville in the Corbin and Wright in the Stoddard being so far back they were not given any kind of consideration. Burman dropped in this round, disqualifying himself when he borrowed a valve from Strang's car which he found deserted on the cemetery turn at Lowell. Burman made the change, picked up Strang and drove to the finish, where he ran his car off the course and retired from the race.

Sixth Lap—Poole was sifted back into the rear in this round, dropping from second to eighth. Matson still kept his lead, being closely pursued by Monsen, who was the dark horse of the race. Monsen, however, was 7 minutes back of the leader and was in danger of being caught by Robertson, who at this time began to show an inclination to get to the front. Wells in the Moon had been sticking to Robertson like glue and at this stage it looked to be a fight for second place in which Monsen, Robertson and Wells were the interested parties.

Seventh Lap—Matson still had the speed of the party and his seventh lap was the fastest of the lot; Monsen picked up a bit on those who were chasing him, while Wells closed 15 seconds on Robertson, whose slowest lap of the ten was this one. No one of the drivers quit in this round, there still being ten cars which were in the running.

Eighth Lap—This round saw the elimination of Stutz in the Marion and Wright in the Stoddard. They had been far in the rear anyway and their dropping out did not alter the positions of the leaders. Matson had a slow lap and so did Monsen, but Robertson picked up a couple of valuable minutes, which improved his chances of getting second place. His 27:41 was the fastest of any of those battling for the cup.

Ninth Lap—At this stage of the proceedings Matson appeared like the winner, having an excellent lead. The Chalmers was running very sweetly and holding its own in point of speed with the others. Robertson was getting desperate at this point

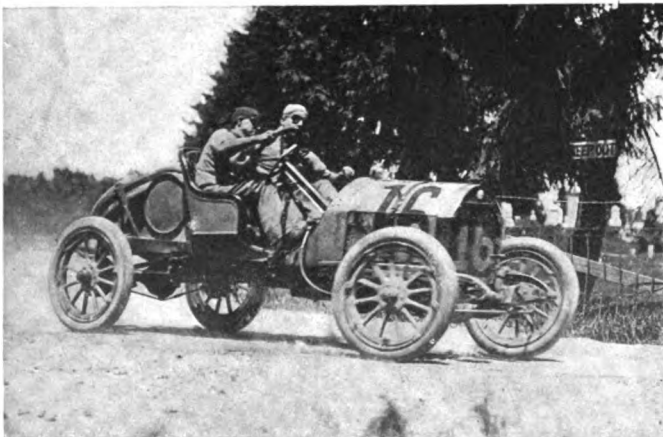

Wiseman's Stoddard-Dayton Was One of the Finishers



Wells and the Moon, Which Finished in Sixth Place

HOW THE LEAD SHIFTED DURING THE RACE FOR THE INDIANA TROPHY, JUNE 18, 1909

No.	Car	H.P.	Driver	Mechanic	Tires	1st Lap	2nd Lap	3rd Lap	4th Lap	5th Lap	6th Lap	7th Lap	8th Lap	9th Lap	10th Lap
19	Chalmers-Detroit	25.6	Matson	Schnor	Michelin	11	3	1	1	1	1	1	1	1	1
10	Locomobile	32.4	Robertson	Ethridge	Michelin	8	8	7	5	4	3	3	3	3	2
6	Marion	28.9	Monsen	Robinson	Michelin	7	5	4	3	2	2	2	2	2	3
7	Locomobile	32.4	Florida	Campbell	Michelin	13	11	10	8	7	6	6	5	4	4
16	Stoddard-Dayton	24	Wiseman	Martin	Michelin	8	7	6	7	6	5	4	6	6	5
11	Moon	32.4	Wells	Goetz	Diamond	10	9	8	6	5	4	5	4	5	6
17	Chalmers-Detroit	25.6	Poole	Gereau	Michelin	6	2	2	2	2	8	8	7		
1	Corbin	32.4	Maisonville	Aude	Diamond	4	13	13	12	10	9	9	8		
3	Marion	28.9	Stutz	Tinkler	Michelin	12	10	11	10	8	7	7			
18	Stoddard-Dayton	24	Wright	Bell	Michelin	15	12	12	11	9	10	10			
5	Chalmers-Detroit	25.6	Knipper	Richards	Michelin	3	4	3	3						
2	Buick	30.4	Burman	Grinnon	Michelin	1	1	9	9						
8	Buick	30.4	Chevrolet	Poirier	Michelin	14	6	4							
14	Buick	30.4	Strang	Hart	Michelin	2									
9	Fal-Car	28.9	Pearce	Stanfer	Diamond	5									
15	Fal-Car	28.9	Ruehl	Kutz	Diamond	16									

and he got his signal to "beat it" to the end. He was only 38 seconds behind Monsen and it seemed as if he would be able to overhaul the Marion before the final flag. Florida, too, was in good position, being fourth to his team mate's third, but 10 minutes behind him. He passed Wells, who had had to change spark plugs and dropped back a place.

Tenth and Final Lap—To win the race Robertson had to make up 8 minutes on Matson in one round, which was manifestly impossible the way the Chalmers was running. The only chance Robertson had was to have Matson meet with some mishap and that hardly seemed likely. Therefore Robertson was out to climb to second place and he set out to pass Monsen, who was putting up the gamest kind of a fight for the honor of being runner-up. But Robertson did not spare his car and he clipped off 27:40 4-5. Matson made a strong finish and did 26:59. On the other hand, Monsen ran his slowest lap of the ten, it requiring 30:49 for him to make the circuit just when even seconds were precious. This slow lap sent him to third. Florida held fourth place, into which he had climbed in the previous round, and the only shift in position of the others was the passing of Wells in the Moon by Wiseman in the Stoddard. This left the final positions: Matson, Chalmers, average 51.4 miles per hour; Robertson, Locomobile, average 50 miles per hour; Monsen, Marion, 49.5 miles per hour; Florida, Locomobile, and Wiseman, Stoddard, 47.4 miles per hour, only 14 seconds separating them, and Wells, Moon, 46.9 miles per hour. At the end Poole in the Chalmers and Maisonville in the Corbin still were running, although hopelessly out of the fight.

AVERAGE SPEED OF LEADERS IN INDIANA TROPHY

Car	Driver	Miles	Time	M.P.H
Chalmers-Detroit	Matson	232.74	4:31:21	51.5
Locomobile	Robertson	232.74	4:39:03	50.0
Marion	Monsen	232.74	4:42:03	49.5
Locomobile	Florida	232.74	4:54:02	47.5
Stoddard-Dayton	Wiseman	232.74	4:54:16	47.4
Moon	Wells	232.74	4:57:27	46.9

REGULARITY OF RUNNING FOR INDIANA TROPHY

Car	Driver	Fastest	Slowest	Variation
Locomobile	Florida	28:42	30:49	2:07
Locomobile	Robertson	26:40:4-5	29:00	2:19 1-5
Marion	Monsen	27:27	30:19	2:52
Chalmers-Detroit	Matson	25:41	30:31	4:50
Stoddard-Dayton	Wiseman	27:33	33:56	6:23
Moon	Wells	27:52:3-5	34:31	6:38 2-5

FASTEST LAPS OF THE INDIANA TROPHY RACE

Car	Driver	Lap	Time	M.P.H
Buick	Burman	1	23:41	58.9
Buick	Chevrolet	2	24:13	57.6
Buick	Strang	1	24:32 2-5	56.9
Chalmers-Detroit	Matson	3	25:41	54.4
Chalmers-Detroit	Knipper	4	25:40	54.4
Chalmers-Detroit	Poole	4	26:26	52.7
Corbin	Maisonville	1	26:28	52.7
Fal-Car	Pearce	1	26:32 1-5	52.6
Locomobile	Robertson	10	26:40 4-5	52.3
Marion	Monsen	2	27:27	50.8
Stoddard-Dayton	Wiseman	3	27:33	50.6
Moon	Wells	2 & 3	27:52 3-5	50.0
Locomobile	Florida	2	28:42	48.6
Marion	Stutz	9	28:55	48.3
Stoddard-Dayton	Wright	2	32:04	43.5

STOCK CHASSIS RACE FOR THE INDIANA TROPHY, JUNE 18, 1909—DISTANCE, 232.74 MILES; CIRCUIT, 23.27 MILES

No.	Entrant	Driver	1	2	3	4	5	6	7	8	9	10
19	Chalmers-Detroit	Matson	23.27 M	46.54 M	69.82 M	93.09 M	116.37 M	139.64 M	162.91 M	186.19 M	209.46 M	232.74 M
			29:00	0:54:43 25:43	1:23:43 25:41	1:46:29 26:05	2:12:19 25:50	2:38:45 26:26	3:05:50 27:05	3:33:21 30:21	4:04:22 28:01	4:31:21 26:59
10	Locomobile	Robertson	27:58	0:55:52 27:54	1:23:43 27:51	1:51:38 27:55	2:19:49 28:11	2:48:21 28:32	3:17:21 29:00	3:45:02 27:41	4:12:22 27:20	4:39:03 26:40.8
6	Marion	Monsen	27:29	0:54:56 27:27	1:22:27 27:31	1:50:01 27:34	2:17:30 27:29	2:45:26 27:56	3:13:15 27:49	3:43:29 30:14	4:11:44 28:15	4:42:03 30:19
7	Locomobile	Florida	29:55	0:59:53 29:58	1:28:57 29:04	1:57:56 28:59	2:27:10 29:14	2:56:16 29:06	3:25:22 29:06	3:54:31 29:09	4:23:13 28:42	4:54:02 30:49
16	Stoddard-Dayton	Wiseman	27:58	0:55:34 27:36	1:23:07 27:33	1:57:03 33:56	2:26:58 29:55	2:56:06 29:08	3:24:03 27:57	3:55:08 31:05	4:24:36 29:28	4:54:16 29:40
11	Moon	Wells	28:00	0:55:52.6 27:52.6	1:23:45 27:52.6	1:52:02 28:17	2:23:11 31:09	2:55:41 32:30	3:24:26 28:45	3:53:51 29:25	4:23:56 30:05	4:57:27 34:31
17	Chalmers-Detroit	Poole	26:44	0:53:36 26:52	1:20:28 26:52	1:46:54 26:26	2:14:17 27:23	3:04:18 50:01	3:47:18 43:00	4:19:46 32:28	4:50:07 30:34	
1	Corbin	Maisonville	26:28	2:04:27 1:37:59	2:36:15 31:48	3:05:15 29:00	3:34:35 29:20	4:03:16 28:41	4:32:09 38:53	5:01:12 29:03		
3	Marion	Stutz	29:34	0:58:29 28:55	1:30:26 31:57	2:02:55 32:29	2:32:07 29:12	3:01:44 29:37	3:35:36 33:52		Ditched.	
18	Stoddard-Dayton	Wright	1 14:46	1:46:50 32:04	2:26:26 39:36	2:58:48 32:22	3:33:06 34:18	4:08:10 35:04	4:44:53 36:43			
5	Chalmers-Detroit	Knipper	25:55	0:54:53 28:58	1:20:47 25:54	1:46:27 25:40	Out.					
2	Buick	Burman	23:41	0:49:46 26:05	1:25:58 36:12	1:58:30 32:32	Disqualified for replacing valve.					
8	Buick	Chevrolet	31:15	0:55:28 24:13	1:21:31 26:03	Out.						
14	Buick	Strang	24:32.4	Out.	Broken axle.							
9	Fal-Car	Pearce	26:32.2	Out.								
15	Fal-Car	Ruehl	3 49:48	Out.								



Mm. Hauvette-Michelin, Matlack, and Robertson

A Group of Crown Pointers



Along the Pits

The Hospital Tent

HARRIS WILS WIN AGAIN
WATCH THE WINNERS

Bill Bailey, Lubricator



Beecroft and Edwards at Work

Notables: Ryan, Ade, Reeves, Wagner Stevens.



Winner Matson



Paine, Wagner and Trego



A Gentleman from Indiana



Everybody was Happy

THE GOSSIP OF THE STOCK CHASSIS RACES

Hard Luck of the Corbin—First of the cars to start in the Indiana Trophy race was the Corbin, driven by Maisonville, who had good reason to bemoan the fate that put him out of the running on the first day. There was considerable difficulty in getting the soldiers placed around the course, so much so that the start of the race was delayed for an hour. Supposedly by that time the truckloads of militia had been entirely distributed, but despite the red-flag signal which greeted the Corbin as it came up a rise in the second lap a heavy truck occupied the center of the road on the down grade following. It was a case of slap on the brakes, which burned out very quickly and settled all chances of the Corbin participating in the real battle, although Maisonville got going again and was running lap after lap well under 30 minutes when the race terminated.

Some Grand Stands Were Out of Sight and Empty—Nearly a hundred grand stands of varying sizes and pretensions had been built by farmers and others around the course in order to secure some of the fabulous wealth supposed to be expended at automobile races, if reports from the East were to be believed.

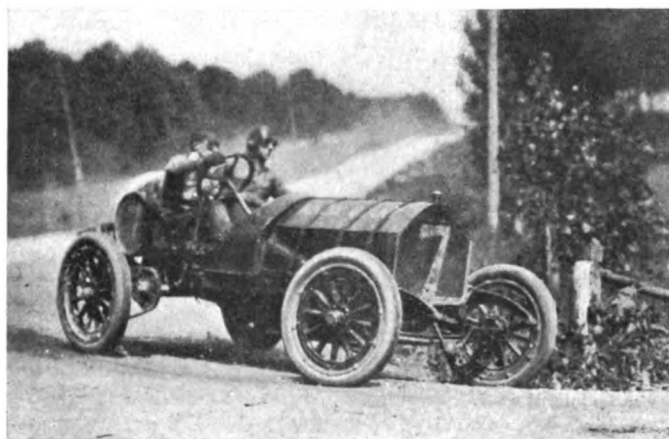

Denniscn (Knox) Who Made Record Lap of Course

The inhabitants of the district who had built soon began to figure losses, for most of the seats went begging and those who did pay for a "stand-seat" had plenty of room. Even the big stand erected to hold 10,000 persons, at \$5 each for the two days, right at the finish, was not half filled on either day, and the parking spaces across the way had two banks of cars—in a few spots. The idea of those in charge that \$15 and \$10 spaces would be in demand was sadly blasted. Lumber was cheap on the day after the tourney.

Lytle Said Course Was Worse Than Briarcliff—After he had given up the struggle because of rear springs broken in the stretch of soft gravel road and backed his Apperson in behind the press stand, "Herb" Lytle said:

"The course is in awful shape for a short stretch. If I could have saved the machine in any sort of shape I would have kept running on three springs. The Briarcliff course was bad, but the one spot in this is worse. All the cars are slowing up over it as they strike their running gear, so badly is the road cut up. Other parts of the road are fine. This bad spot must be built over if the race is to be run again."

The bad spot was a mile long in the stretch leading to the finish, about five miles from the tape.

"Wag" Delighted the Westerners—Fred J. Wagner, the starter of the really big races, was once an inhabitant of the Windy City, but the races on the Crown Point course were the first of their kind in that section of the country, and consequently the first which he started there. So all the papers and many in

the crowd were awed and pleased with his "Ten, nine, eight, . . . three two GO." It sounded realistic, and gave the crowds the feeling of hearing something of which they had previously read. So "Wag" was an extraordinarily noted personage, and all the youngsters in Crown Point are making raids on the clothing stores for checked short pants, leather puttees, and German caps with leather visors.

Michelinites Were Happy—Among the naturally interested onlookers were: M. Hauvette-Michelin, who is the executive head of the American factory of the Michelin Tire Company at Milltown, N. J.; Manager "Jack" Matlack and Advertising Manager Bramwell. With such a preponderance of cars equipped with Michelins the Milltowners were inclined to feel quite confident, though they could not resist the enthusiasm which naturally followed in the wake of the victory. M. Hauvette-Michelin has seen all of the principal European races, but his first American experience was at Savannah and the second at Chicago.

Indiana Trophy Presented to Matson—Clothed and in their right minds, Joe Matson and Mechanic Dan Vaughn were re-



Maisonville (Corbin) Who Failed Through No Fault of Car

ipients of the Indiana trophy and a great ovation just before the start of the big car event. The winner of the light car race came to the stand in the victorious Chalmers-Detroit, President Ira M. Cobe of the Chicago Automobile Club presenting the handsome silver cup to Matson. The appearance of the crew was far different from their looks when they completed their work on the previous day, for straw hats and light spring suits had replaced the oily sweaters and jerseys of the racing togs.

The Commercial Hotel at Crown Point, Ind.—With race headquarters at Crown Point, the Commercial Hotel, of which Mrs. Beers is the hustling manager, assumed some importance in the matter of providing food and lodging for the thousands. One inconsiderate boarder found fault with a towel which had done much service in the public washroom and registered a kick with Mrs. Beers, who came back with the emphatic remark that "Over forty men have used that towel and you are the first one to kick." There was no clean towel forthcoming!

Harry Knight the Dean of the Timers—From Boston came the man who took charge of the timing of the cars in their fights. Harry Knight is a well-known figure in New England automobiling, and he has extended his timing operations to various parts of the country. With his trusty chronometer and array of stop-watches, Knight saw that the timing of the autos was made accurately and without friction. "Demountable" Nadall lent a good hand in the job.

Arrangements Were Wonderfully Good—Perfection in management and preparations were everywhere evident, sub-



The Cobe-Myers Grandstand Box



Includes the Locomobile Box Party

stantiating the fact that what the people of the West do is generally done well. Miles of woven wire fencing had been erected to keep back the crowds, 23 miles of asphalt road had been laid, the press stand was a joy to the busy newspaper men, the telegraph wires, telephone lines, and viaducts were well placed, and the soldiers were real.

Matson a Former Cyclist with "Dutch" Waller—There were those at the race who did not recognize in Matson, the winner, an old-time bicycle rider, an honor which carries a bond of unity with it, among those who graduated from bicycles to automobiles, and are now looking forward to aeroplanes. Matson was once the racing partner of "Dutch" Waller, who was well known in the six-day events, and later as the engineer of a motorcycle.

How a Broadwayite Got Stung—"Sid" Bowman was among the "Broadwayites" who fell victims to the wiles of the local Hoosiers, who naturally were after money when such easy picking abounded. "Sid" boarded a 'bus bound for the grandstand, paid his way upon demand after only a small fraction of the distance had been traversed and then was dumped out a mile from the destination point.

The Locomobile Party—One of the grand-stand boxes was occupied by a Locomobile contingent which consisted of President S. T. Davis, Jr., and Mrs. Davis, Mr. and Mrs. A. L. Riker and Mr. and Mrs. R. A. Greene. Before Robertson had his magneto troubles the Locomobile adherents were inclined to be fairly confident, though when the hard luck came, the situation was accepted heroically.

Equipment on the Winners—Tires, magnetos and carbureters receive their share of honors in victories such as those of the Buick and Chalmers-Detroit cars. Chevrolet's Buick used a Schebler carbureter, Remy magneto, and Michelin tires. The Chalmers-Detroit, driven by Matson, in the Indiana cup race,

used a Kingston carbureter, Bosch magneto, and Michelin tires.

Of Course, John Farson Was on Hand—Resplendent in a suit of immaculate white, with red hatband and tie, John Farson, ex-president of the Chicago Automobile Club, was cre of the shining lights. L. E. Myers, president of the Illinois State Association, and Sidney S. Gorham, who was secretary of the A.A.A. during Mr. Farson's administration, were also to be seen.

Ford and Firestone—Henry Ford, in company with Tire-maker H. S. Firestone, was a keen-eyed though quiet observer of the racing, which he admitted that he enjoyed thoroughly, even though his small car entrant was unable to be a starter. Seattle was Mr. Ford's destination in the evening after the finish of the Cobe race.

Happy Chalmerites—The Chalmers-Detroit camp was located at Lowell and here, after the small-car race, came Hugh Chalmers, Mr. and Mrs. Howard Coffin, Roy D. Chapin, Harry Ford, "Jim" Levy (of Levy & Whipple, the Chicago agents) and many others who believe in the car from Detroit.

Among Those Present—Of course, the list of real notables included such well-known figures as H. O. Smith, chairman of the A.M.C.M.A. executive committee; Alfred Reeves, the general manager; Samuel B. Stevens, now of the A.A.A. contest board, and Dr. J. B. Parks, of Boston.

Referee Paine Represented the Northwest—From one of the "Twin Cities" came the highest official of the day, Referee Asa Paine, a man well acquainted with the intricacies of automobile race management and once president of the Florida East Coast Automobile Association.

Chairman Hower Was an Onlooker—Chairman F. B. Hower, of the contest board of the A.A.A., was an unobtrusive observer of the sport, being in the company of F. C. Donald, president of the Chicago Motor Club.



Chalmers at Wheel with Designer Coffin in Tonneau



President Cobe Presents the Indiana Trophy

FORDS AND SHAWMUT NEAR SEATTLE

SEATTLE, WASH., June 23—Ford cars and the Shawmut, in the race from New York to this city, are expected to reach here this evening or early to-morrow morning, and they are all within 125 miles of the finish. Ford No. 2 is leading, with the Shawmut second and the Ford No. 1 third. All three are out of the realm of telegraphic communication, but it is estimated that Ford No. 2 would have been ferried across Lake Kitchell late yesterday afternoon, would have run all night, and is now approaching the city. At 2:30 yesterday afternoon it was reported well along towards Snoqualmie pass; and at Ellensburg, 128 miles east of here, the Shawmut was reported yesterday morning as eight hours and 15 minutes behind the leader, but with its crew in better condition, and expecting to make up much time. The Shawmut passed Ford No. 1 out from Walla Walla, running well. The last report on the Acme was when it left Rawlins on Monday afternoon in good condition; and the Itala reached Denver on the same day, and prepared to continue northward.

The roads since leaving Rawlins have been very rough, often very bad, and once in a while good enough for fast work. The positions of the cars have not shifted as much as they did last week, when every car held the lead at some time en route, for the principal change has been in the overtaking of the Shawmut by Ford No. 2. The former left Rawlins four hours in the lead, but at Montpelier, Id., on Friday, Ford No. 1 arrived first, the other two cars having trouble 30 miles east of that place. They were quickly repaired, however, and the Shawmut secured a few minutes lead of No. 2. Ford No. 1 replaced a front wheel and a spring at Montpelier. On Sunday morning the Ford No. 2 reached Boise, and thereby won the \$100 offered by the Commercial Club to the first arrival, for the other Ford had lost its way in the desert and its team-mate went into first place, the latter reaching Boise on Sunday afternoon at 2.30, and the Shawmut an hour later. In the race the matter of minutes became important as the contestants neared this State. Baker City, Ore., the only checking station in that State, was reached at 3.45 P. M. on Sunday by the No. 2 Ford, having covered the 160 miles from Boise in seven and three-quarter hours, and the crew pushed right on towards Walla Walla, 130 miles further. The Acme on that day was reported as leaving Boster, Wyo., where it had been held up by a broken jack-shaft.

That the cars were always on the go, is seen from the fact that the leading Ford reached Walla Walla at 6.45 A. M. on Monday, and after a rest of two hours pushed on towards this city, 291 miles further. The other Ford and the Shawmut were then en route from Baker City, the Acme had passed Rawlins, and the Itala had reached Denver. The roads from the position of the leader are good and local automobilists are awaiting a report of the cars to locate them, and then go out to meet them.

RUN TO WILDWOOD NEXT IN JERSEY

NEWARK, N. J., June 21—Members of the New Jersey Automobile and Motor Club still have two weeks in which to enter for the club run to Wildwood on July 3, but already enough have signified their intention of participating in this roadability affair to insure its success. The announcement of some very prominent entries in the straightaway races to be held at the shore has increased the interest in the week-end tour. Joseph H. Wood, chairman of the contest committee in charge of the recent amateur run, has announced that the club will conduct an open endurance contest under more rigorous conditions late in August or early in September, which will include a technical examination of the contestants at the completion of the event. At a meeting of the board of trustees, resolutions were adopted against the proposed "Jersey jubilee run" of some New York autoists, scheduled for July 1, 2 and 3. The promoters of this event plan to conduct it as a celebration of the passage of the amendments to the automobile law permitting out-of-the-State tourists to use Jersey roads for a nominal sum, and this method of expressing joy does not meet with favor in this city.

SAVANNAH NOW INTERESTED IN AUTO RUNS

SAVANNAH, GA., June 21—Endurance runs and tours are of greater interest to automobilists of this city at present than has any one thing been since the Grand Prize race. With the successful conclusion of the contest to Augusta comes offers of other termini, in the hopes that the Savannah Automobile Club will use its organized methods of management in conducting future events. Hon. Clark Howell, editor of the *Atlanta Constitution*, has offered to give over the management of the run to Atlanta to the local body, and a meeting of the executive committee has been called to consider it. This run is in line with the many proposed for the good roads movement, and would be an additional contest along the same campaign as that of the *Savannah News*. On Friday it is expected that about 150 automobiles will go to Atlanta for the inauguration of Governor-elect Brown, which occurs on Saturday, not only to give their owners and passengers the view of the ceremony, but also to get the new Governor well interested in the automobile and good road enthusiasm. The plans call for the start of fifteen cars from Fitzgerald, picking up others at Macon, Waycross, Thomasville, Perry, Jonesboro, and other places en route, while from every part of the State other cars will make the journey.

So far no word has been received from the Automobile Club of America as to a suitable time for a meeting between its contest committee and that of the local club. Savannah desires to prepare for another grand prize meeting, and awaits the cooperation of the New York body.

STODDARD-DAYTON WINS DELAWARE RUN

WILMINGTON, DEL., June 21—Thomas M. Brown, in a Stoddard-Dayton touring car, won the fourth annual roadability run of the Delaware Automobile Association, which was held on Saturday. The event was of the sealed-time variety, in which the cars were checked at certain points and the one which came nearest to reaching controls on time was declared the winner. Mr. Brown was penalized 24 points; second was W. L. Hammond, Mitchell, 28; third, A. B. Hazzard, Mitchell, 29. There were 23 starters for Dover in the morning, and of these 18 finished. The route took the contestants to Dover and back. Those others who finished were: W. H. Jones, Rambler; G. S. Woodward, E-M-F; Dr. J. C. Fahey, Stoddard-Dayton; Mrs. J. C. Moore, Cadillac; T. C. Bradford, E-M-F; H. F. Dougherty, Ford; C. M. Beadenkoph, Cadillac; C. B. Harris, Cadillac; W. J. Gibbons, Franklin; J. B. Bird, Franklin; R. S. Baird, Stoddard-Dayton; W. E. Anger, Autocar; E. E. duPont, Stoddard-Dayton; Mrs. E. E. duPont, Buick; R. T. Elliott, Buick.

LONDON'S OMNIBUS TRAFFIC STILL DECLINING

In the last available figures on the subject of the omnibus traffic in greater London, it is apparent that the traffic is still low and does not rise as it was expected to do. For the week ending May 29, while the traffic increased but £5,164 (\$25,820), the total for the year up to that date showed a loss of £32,051 (\$160,255), this amounting to 4.4 per cent decrease. In the same time for the Tubes showed an increase of £14,528, and the figures for Tramways revealed a gain of £60,488. Added to this the increase on the part of the Shallow Railways of £33,465, make the omnibus situation particularly noticeable. Against the handsome gains on the part of all other methods of transportation this is sufficient to bring the total gain for the year for all systems down to £76,430, equivalent to but 2.9 per cent.

NINE CONTESTANTS IN BINGHAMTON RUN

BINGHAMTON, N. Y., June 21—Nine contesting and one official pilot car left this city this morning on the fourth annual tour of the Binghamton Automobile Club. The route includes night stops at Albany, Boston, Hartford, and Newburg, returning to the starting point on next Saturday.

MAKING OF AN EPOCH IN GOOD ROAD CONSTRUCTION

By COKER F. CLARKSON, A. L. A. M.

THERE is under way a movement going to the foundation of things in the good roads matter. To many good roads are an uninteresting and hackneyed subject. But of their vital necessity and of the advisability of constantly urging their construction, there should be no debate. No other improvement will pay to the people such dividends as modern highways. A nation's reputation for enterprise, progress and all that goes to make it worth living in, is determined very largely by the character of its roads, the great arteries through which flow the business and pleasure of the nation.

down large flat stones. Then in France rough stones were set on edge, a layer of broken stone being superposed. A similar theory was later followed in England. Early in the nineteenth century McAdam announced the principle that small pieces of broken stone placed in a layer are, by the action of water and travel, transformed into a homogeneous road surface. Years afterward the road-covering effect of crude oil became known.

It is now pretty generally recognized by highway engineers that the macadam road is, for modern conditions, obsolete, and that from now on first-class roads must, by the admixture of

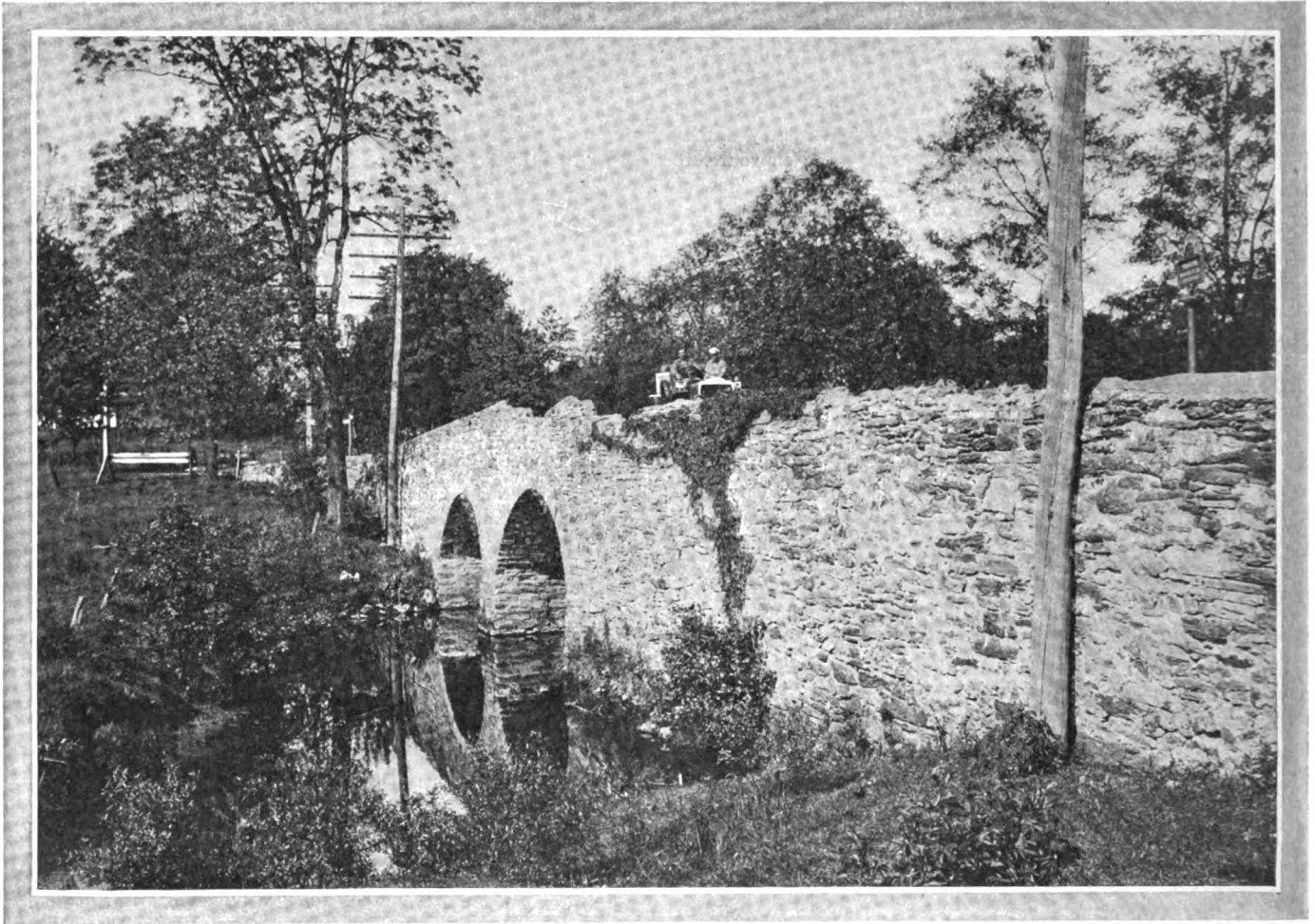

Where the Highway That Leads from Trenton to Philadelphia Crosses a Picturesque Bridge at Langhorne, Pa.

The public road is a principal feeder of our civilization. We take pride in our crops and products, often forgetting public roads must bear them to market. We lead the world in railroad building, but for every mile of railroad we have ten miles of highway, such as it is. Perhaps this in a way indicates the relative importance of improved highways.

The benefits to be derived from a reasonably good common road system would be shared by all classes: the farmer reaping a better profit through easier transportation to commercial centers; the inhabitants of towns and cities by the product of their labor reaching the rural districts more economically. This is a fair analogous deduction from the history of the reduction of freight rates by the improvement of roadbeds and rolling stock, to which much of what science, experience and invention have developed has been applied.

The history of good road construction all over the world reveals only a few fundamental methods. The Romans laid

proper ingredients, have a mastic property, by virtue of which dustless roads will become a reality, and undue depreciation from disintegration of the road be avoided.

The good roads problem, although precipitated by the automobile, has been left alone for generations, and extends in its far-reaching importance and effect much further than the consideration of its relation to the automobile; in fact, as far as any economic question can reach. The automobile is broadly a medium of communication and traffic, upon which the very life of the nation depends. Roads are simply media for facilitating traffic, incidental to animate and mechanical road traction, and not an end in themselves. This last should be obvious, but some seem to think the preservation of roads out of date for modern purposes is the great desideratum. But progress in fundamental matters cannot wisely be impeded by incidental considerations. It is clear that the automobile is an improved method of accomplishing a fundamental function.

Indicator Cards and what they Delineate

BY THOS. J. FAY

INDICATED HORSEPOWER, referring to a motor, differs from the actual delivered power by the mechanical losses. Just what the mechanical losses are is largely dependent upon the design of the motor in any given case and because of this fact the indicator becomes of the greatest value for, by its use in conjunction with a dynamometer, it is possible to ascertain not only the power that a motor will deliver, but the losses mechanically, so that the best speed at which to gear the motor with a view to the highest fuel efficiency will be arrived at.

The indicated horsepower of a motor will depend upon the factors as follows:

- Let
- P = mean effective pressure in pounds per square inch.
 - L = length of power stroke in feet.
 - A = area of piston in square inches.
 - N = number of power strokes per minute.

When

$$\text{I.H.P.} = \frac{P L A N}{33,000} = \text{indicated horsepower.}$$

The length of stroke and the area of the piston, since they are dimensions of a motor that do not change, can be ascertained with good accuracy at will, while the mean effective pressure, as well as the speed, are the two factors that cannot be fixed offhand. It is common practice to assume that the speed will be, say, 1,000 revolutions per minute, but this practice is without any good foundation at all, on the ground that the speed depends upon several considerations that cannot be arrived at excepting as the result of an actual test after a motor is built, although it is possible to approximate the speed performance in the process of design if the problem is approached in due form.

At all events, when a motor is finished and it is desired to ascertain just what it will do it is the indicator in some form or other that is adopted with the view of procuring what amounts to a photograph of the curve of pressure of the gas in the cylinder during the several cycles, and since the curve can be measured, it is possible to determine the mean effective pressure throughout the strokes. The same photograph (card) will tell if the suction pressure is excessive; if the valves open early or late and if the ignition is adequate and properly timed. There is also the back pressure to be disposed of if it is sufficient to reduce the power of a motor beyond a slight amount and if the muffler is not good for the purpose; by means of the indicator it is possible to ascertain the fact by the simple expedient of taking off a card with and without the muffler.

Indicators as they are used in steam work are not so well adapted to such high speeds as when automobile motors of the internal combustion genera are to be investigated, and the modern method involves the use of a "manograph," diagrams from which show exactly the same information as that obtained from indicators of the conventional

sort, excepting that the accuracy of the manograph is its best recommendation notwithstanding high speeds of the motor to be tested. Since the cards in each case are of the same general character it will be unnecessary to describe either of the forms of equipment at this time, rather with the expectation that these matters will ultimately be afforded a measure of space for their proper elucidation.

Typical Indicator Card Showing Characteristic Points— Before technically discussing manographs used to bring out the points to be made a typical card will be exposed for the purpose of rendering the text clear. The card, Fig. 1, is therefore offered, and as will be observed, the stroke of the piston is depicted by the line A B at the atmospheric pressure, which is 14.7 pounds per square inch (closely); the distance A C is equal to the clearance between the top of the stroke and the dome of the combustion chamber. The compression line is shown from the point B to the point of convergence into the explosion line, terminating at E, and the expansion line, extends from E to B. On the suction stroke the line of pressure shows below the atmospheric line, difference in pressure being but slight in the better types of motors. The exhaust on the scavenging stroke is a maximum at the point B and should fall away to the pressure of the atmosphere at the point A; this is rarely true in practice, especially when a muffler is used, provided the same silences the noise of the exhaust as perfectly as is the wont of the average autoist. The power that can be taken from one cylinder of a motor is equal to the area of the enclosure of the compression, explosion and expansion lines, from which must be subtracted the area of the enclosure of the atmospheric and the admission line together with the area of the enclosure of the atmospheric and the exhaust line. The power so found will be indicated, from which must be subtracted the mechanical losses of the motor, including the power required to drive the accessories, as pumps for oil and water, also the magneto used for ignition purposes. A planometer may be used for the purpose of ascertaining the area of the surfaces enclosed by the respective boundaries and the strength of the spring used in the indicator must be considered in the process of determining the power of the motor in a manner as will be shown in the discussion relating to instruments and measurements. The power above alluded to does not take into account the losses in the transmission system, as clutch, gears, differential, bearings and from vibrations.

Practical Results as Depicted on Cards— These diagrams, as shown in Fig. 2, were originally taken for the purpose of determining the efficiency of sparking equipment in some experiments conducted by W. Watson, and a paper by him was discussed before the Automobile Club of Great Britain bearing upon the ignition phase of the situation. The cards, however, portray much more than was brought out at the time and they are unusually good for the purpose. The motor was of the 2-cylinder type, 3 1-2 by 4 inches bore and stroke, respectively, and the speed of the motor was

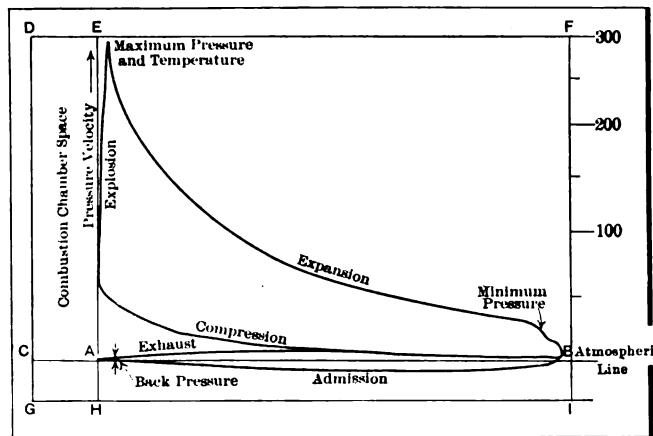

Fig. 1—Characteristic indicator card for use as a key to the cards as shown in Fig. 2

held between 950 and 1,000 revolutions per minute while the cards were taken off.

Two diagrams are shown on each plate, marked a and b, respectively; effect of energy in the spark is shown at a glance, for the second diagram on each plate was taken with a weakened spark in each instance. The cards designated as (a) were taken with the strongest primary current that would afford results on an increasing basis and the diagrams marked (b) were taken with the weakest current in the primary of the coil used that could be employed and not have missing explosions during the period of operation.

In this experiment the sparking distance was tried out at .25, .5 and 1 millimeter with little or no difference in result, so that the final work was conducted with the sparking distance held at .5 millimeters separation. This is one of the matters that would naturally show up on an indicator card, and it is well worth noticing that the spark-gap may vary over broad ranges without affecting the efficiency of performance of the motor. In the case of the card B it will be observed that the diagram (b) is imprinted twice, one of which is with a higher explosion pressure than the other by a considerable margin; this was due to the scavenging effect of a "miss," the explosion that followed the "miss" was relatively violent, due to the better conditions of scavenging, and this is one of the best points to be determined in an investigation of this sort.

The card C shows the result of excess air dilution, in which it will be observed that the highly inflammable charge was fired quite as well with the weak spark as with the spark that emanated from a strong current. In this case, however, the explosion pressure was below that which would be produced were the mixture normal in view of the compression pressure shown, which was relatively high, thus indicating that the ratio of

explosion to compression pressure is neither constant nor to be relied upon if the ratio of gasoline to air is altered sufficiently to lower the rate of flame propagation very much. On the other hand, this card shows that the best fuel efficiency will fall somewhere in the vicinity of the mixture that will propagate a rapid flame, and sparking troubles will so be much reduced in such cases; this card shows that the spark does quite as well when weak as when strong if only the mixture holds enough excess oxygen to render it quick burning. On the other hand, excess oxygen can be overdone, in which event the mixture will not be quick burning and the weak spark will fail to perform in a satisfactory manner.

What the several cards show, from the point of view of suction pressure, is a certain uniformity, rather than any very definite results; as an example of an appreciable area of the suction portion of the diagram, it is possible that the examples B and I are the most conspicuous; the depression, below the atmospheric line in these cases, is sufficient to warrant the belief that the motor was contrived with quite small valves, and that the intake was somewhat restricted in area, or the carbureter was of the class to afford easy starting of the motor, rather than efficient power service. That there is a vast opportunity to engender losses in a motor by having a considerable depression in the intake is one of the matters that will be fully illustrated if the exponent "N" is calculated for the several depressions. It has been shown in another place that the compression is affected by the numerical value of the exponent named, which exponent is not far from 1.3 when the depression during the suction is 1.7 pounds per square inch, making the absolute pressure 13 pounds per square inch. In a general way, when the suction pressure is pronounced, it is desirable to ascertain if there is some way to free the suction, sufficiently to lower the suction pressure, with-

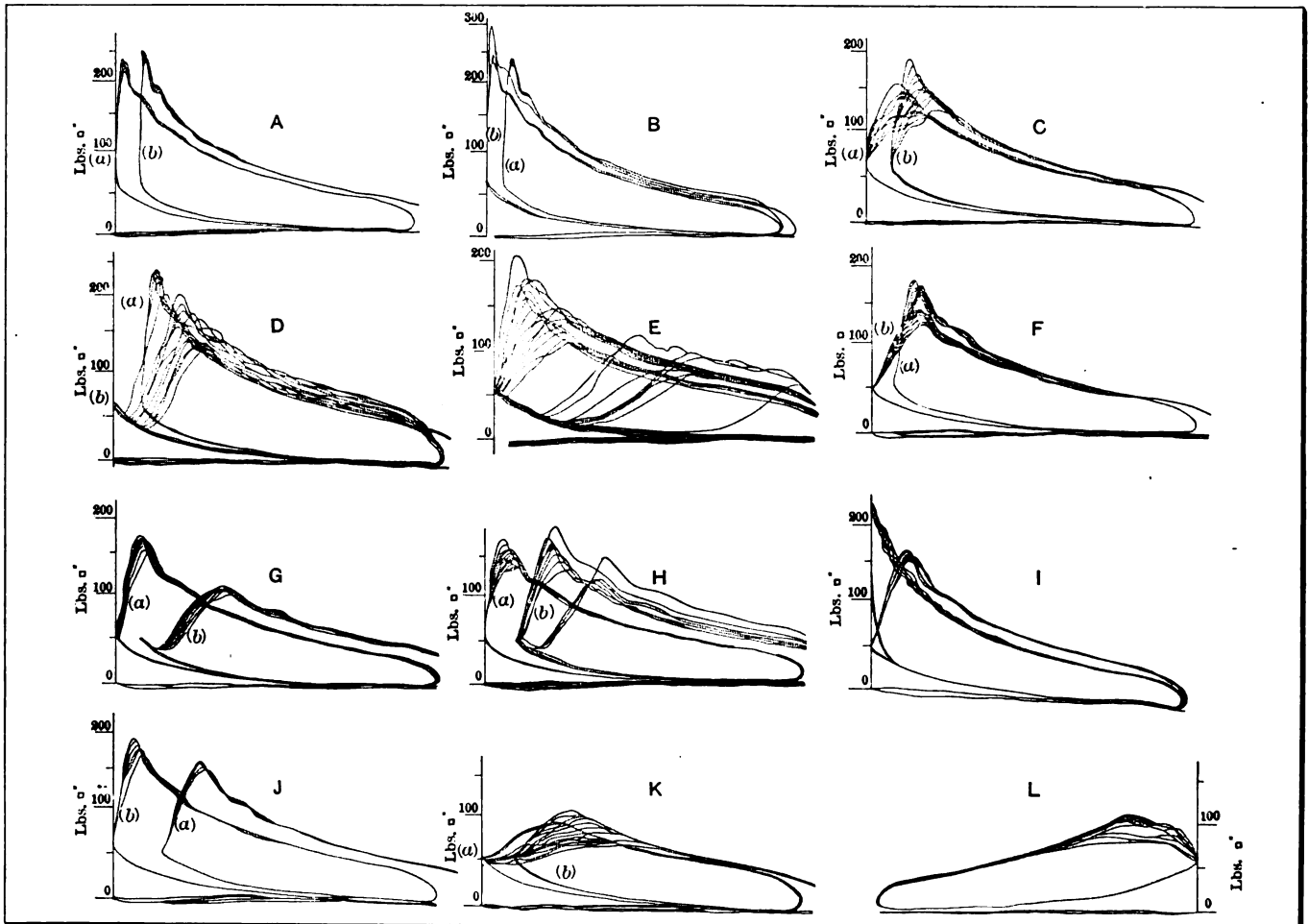

Fig. 2—Indicator cards showing the effect of early, late, weak, and strong ignition; also the usual variations that influence power

out, at the same time, reducing ability to start the motor, or undue cranking. Of course, there are two sides to this question; if the suction pressure is insufficient to afford a full measure of mixture, the power of the motor will fall off in response to the diminished weight of the same; on the other hand, if the pressure is excessive, it will show in any attempt to balance the cyclic losses, the one against the other. If the suction pressure is, say, two pounds per square inch, this negative pressure must be compared with the mean effective pressure on the power stroke. To compare the suction pressure with the maximum pressure on the power stroke, is to overlook the fact that the suction pressure is nearly constant over the whole stroke, while the maximum pressure, during the power stroke, is very much in excess of the mean effective pressure. If the mean effective pressure is, say, 70 pounds per square inch, which is not far from the truth in many cases, then:

$$\text{as } 70 : 2 :: 100 : 2.85$$

This is a rather large proportion, which, in the absence of other losses, would be a small matter; the back pressure, however, must be considered on the same basis. The diagram D is the only one that indicates the presence of any considerable back pressure, although, in motors in general, and especially when mufflers of an inferior character are used, the back pressure is material. If the losses of this character are indicated by the presence of, say, 5 pounds per square inch, back pressure, the proportion will look as follows:

$$\text{as } 70 : 5 :: 100 : 7.14$$

This, too, is on the basis of 70 pounds per square inch, mean effective pressure. What the cards do not show, is the differences in compression pressure that would follow changes in speed; since the speed was held almost constant during the "indications," and in view of the constant conditions, in other directions, the compression pressure was nearly the same in every case. The card I shows a lowered compression pressure brought about by pre-ignition. This is just what one would expect under such conditions, and it is but a step to the conclusion that very early, functional, ignition will bring about the same result in some measure.

One of the safe conclusions then, must involve a certain precision of ignition, such as can only follow if the ignition equipment is capable; free from a variable time constant; with an adjustable means for advancing and retarding, as the speed of the motor changes. It is on this account that electrical ignition systems are found to be of greater superiority than other means thus far tried; the difference in the several electrical contrivances, for that matter, are sufficiently noticeable to require consideration to obtain superior results.

Influences That Affect the Maximum Pressure—It will be observed that the maximum pressure is not the same in all cases; the variations are not even in a constant ratio to the variations in compression pressure; it is usual to assume that the maximum pressure is equal to about four times the compression pressure, in motors in general, under normal conditions of operation; this is an assumption that is not always borne out by the facts, excepting, perhaps, in a given motor, at some one speed. The diagram I shows that the compression pressure is about 50 pounds per square inch, and in this case the maximum pressure is about four times, or, 200 pounds per square inch. This compression pressure is low, due, as before stated, to pre-ignition. The card B shows a compression pressure of 60 pounds per square inch, and four times this value would equal 240; instead of this value of the maximum pressure, an observation will show that it was slightly under 300 pounds per square inch. The higher value, as above given, was after a "miss," thus indicating that the conditions of scavenging were superior to the average in this motor, and as a matter of fact, for this motor, it is very likely that the maximum pressure would be equal to about 4.5 times the compression pressure.

In this motor, the compression pressure was low, as shown by every card taken, due, in a large measure, to the constricted intake, and to some extent to the speed at which the cards were

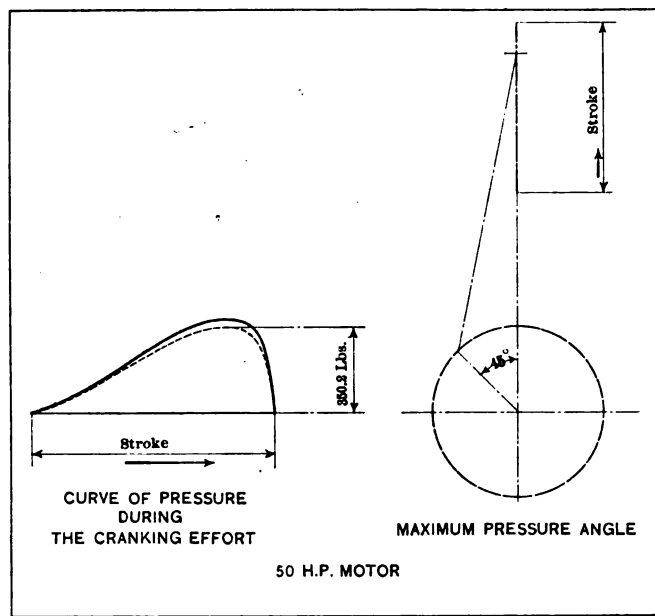

Fig. 3—Diagram showing the point at which maximum compression will show on the starting crank by inducing maximum pull

taken off. The card K indicated a very inferior condition of performance, the maximum pressure being about double the compression; this card was taken with a weak mixture. Against this, a glance at the card J will show the performance when the mixture was nearly normal, and it will be observed that the performance, as shown by J, was below the maximum expectation, due in this case to inferior conditions of ignition. In general, the ratio of maximum to compression pressure will be a maximum, under the conditions, as follows:

- (A) The ratio will increase as the compression pressure is increased, up to a certain point, which point is at or near pre-ignition.
- (B) The maximum pressure will obtain when the surface to the water (cooling) jacket is minimum, all other conditions constant.
- (C) If the cooling provision is highly active, the compression pressure will be increased accordingly, and the maximum pressure ratio will fall off, but the mean effective pressure will be maximum.
- (D) Bettering the conditions of scavenging will increase to maximum compression, as well, the mean effective pressure, without diminishing the compression pressure.
- (E) Increasing the speed of the motor (the piston speed), beyond a certain point, will lower the compression; the maximum pressure out of proportion, and the mean effective pressure accordingly.
- (F) Increasing compression, while it will have the effect of increasing the maximum pressure, will not produce a proportional increase in the mean effective pressure; the power of a motor, then, is not proportional to the compression pressure, nor is it proportional to the maximum pressure; the power is proportional to the mean effective pressure, however.

It was said, early in this discussion, that the speed at which a motor will do its best work is not to be assumed; it is no more possible to assume the speed than it is guess at the mean effective pressure. No two motors will perform in precisely the same way, in this connection, unless the features of design, and the conditions of operation, are in exact accord; it is even difficult to arrive at the same results when two motors of the same make, size, and even "shop order number," are tried out; it is on this account that one owner, of a given model of car, will realize good results, and another owner will receive but indifferent service.

The best speed of a motor is that which will afford the greatest measure of power, under conditions that will render the

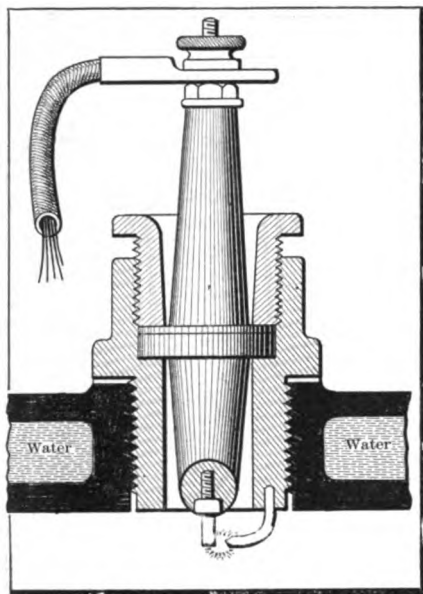

Fig. 4.—Section of a sparkplug showing defective construction and loss of compression following the absence of packing

power available. In this will be found two points to be satisfied, i.e., the motor must be strong enough to enable the power to be taken off continuously, without damaging the mechanism; the gear ratio to the road wheels of the car must be such that the power available will be used up, and the demand must be no more. Indicator cards would be of the greatest value were it possible to rig up so that they could be taken with the car on the road doing

its regular work, observing the speed at the same time. In this way, it would be possible to ascertain if the gear ratio accords with the requirements, remembering that a motor that is held down to a low speed, may not be delivering its best power.

Effect of Leaky Valves and Pistons—Since the amount of gas that will leak by, in a given time, depends upon the pressure, it is a simple inference that the leak is not at a constant rate, due to the fact that the pressure is not constant. If the mechanism is in a leaky condition, the compression will be lowered, but the most marked effect will be in connection with the explosion pressure; in taking off cards, it is possible to ascertain if the system is leaky, provided the ignition is cut off (from the cylinder to which the indicator is connected) and note is taken of the point at which the compression line crosses the atmospheric line. If the junction is far out on the stroke, it is a sign of a leaky condition, although, as before stated, the compression pressure will be diminished, due to the loss of mixture. With the ignition cut off, if a leak is present, the expansion line will fall below the compression line, due, of course, to lost mixture in the process of compression, at an increasing rate during compression, and in the process of expansion.

Effect of Over-heating May Be Noted—If the cooling system becomes inefficient, due to a faulty water circulation, as when the water pump becomes leaky, or if the jacket surfaces become encrusted, excess heat will rarefy the incoming mixture, and the actual weight of gas will reduce accordingly. The card will show a lower mean effective pressure than will follow if the motor is allowed to cool off, or if the water circulation is corrected; two cards, one with the system heated, and the other with the motor cooled off, will tell the tale, and the loss will be found to be considerable.

The torque of a motor is readily obtained by a dynamometer, and the fuel efficiency will be found to increase with the torque, just as does the power, at a given speed.

Torque will decrease:

- (A) If the valves or the pistons leak;
- (B) In case the cooling is inadequate;
- (C) Provided the valves are not properly timed;
- (F) When the intake is restricted;
- (G) If the carbureter is too small;
- (H) Due to back-pressure, as when the muffler is stopped up;
- (I) If the ignition is not properly timed;
- (J) In any case, when the speed increases enough to reduce the weight of mixture, due to friction of the same against the walls, and in a molecular sense as well.

If the system is leaky, the torque will be lowered at reducing

speeds of the motor, due to increasing time, thus augmenting the loss of mixture; the torque curve will also slant in a downward direction as the speed increases, so that, in the average motor, after it has been in service for some time, it is to be expected that the curve of torque will slant downward at low as well as at high speeds, and indicator cards, at the several speeds, would show just such results, especially if the system becomes leaky, which is a normal expectation due to long service.

In actual practice it is possible for the average motorist to note the performance of his motor, from time to time, without having to resort to the use of an indicator, for the very simple reason that the cold compression will, in itself, serve to indicate the condition. From the point of view of leakage Fig. 3 represents the situation, in that it shows the maximum pressure angle, considering a certain motor, which should not differ much from motors in general, of the same power, and in this case, it was found that the maximum pressure (cold) came at 45 degrees, on the compression stroke, as shown by cranking the motor, as well as calculating for the curve of compression. A pair of scales, used to pull the starting crank up against the compression, is all that is necessary to show the value of the same at any time; hence, if the compression is reduced for any cause, it is possible to detect the difference. A gauge, attached to the cylinder, if it is provided with a stop, will serve as an indicator to go by, and a motorist, so equipped, will be in a position to check the performance of his motor, and if he finds that the cold compression is reducing, it is equal to saying that the power of the motor is diminishing.

Sometimes it is a small matter that causes a loss of compression, as a leak around a spark plug. Fig. 4 shows just such a plug, in which the packing is left out from under the seat where it presses down against the "boss" on the cylinder. The porcelain packing is indicated as above the enlargement, and the leak may also be up around the porcelain, and again, the packing is out from around the enlargement of the central electrode, thus allowing mixture to ooze by, and up along, the electrode. It takes but a very little leak to lower the power of a motor very much indeed, and the motorist who looks after this phase of the problem will rarely have to resort to the use of an indicator to ascertain why his motor fails to deliver the accustomed power.

One of the most mysterious leaks with which the motorist has to deal is due to sparkplugs, when they are new. Even if they are tight when they are first placed into service, it is highly improbable that they will stay so, and the proper measure is to tighten them up, after they get heated, allowing time enough for the packing to adjust itself to the heat that is normal to the performance. In this case reference is had to the packing in the entrails of the sparkplug, rather than to the packing ring that presses against the cylinder boss in consequence.

The indicator should be of the greatest advantage in affording more nearly exact information as to the right speed of a motor, or better yet, the timing of valves, and the spark that will give the best results at a given motor speed; certainly, it is not proper to time valves in precisely the same way, irrespective of the speed at which a motor is to run, when it is coupled into a car. The curve of torque of a motor is susceptible of manipulation, if the speed is adjusted, provided the valve timing is adjusted also, assuming that the camshaft is so suspended between bearings that it will not spring so as to destroy the setting of the valves, and if lost motion is eliminated.

A given car, of a certain weight, and of characteristics that are fixed independently of the motor, will take a certain amount of power to impel it, no matter what may be the character of the motor used. If the motor is not big enough to do the work, the car will not run, because if the motor is incapable of exerting enough twisting force, it will shut down. In setting a motor then, it is necessary to consider the power required; gear ratio, in view of the road conditions that have to be tolerated, and the service that the car is expected to perform, and if great flexibility is one of the prime requirements, the curve of torque must be examined.

KINKS AND WRINKLES FOR THE AUTOIST

By D. R. HOBART

UNFORTUNATELY for those who tour any great distance from home, repair shops are few and far between in many sections, and too often the local Vulcan is ready to attempt repairs but lacks the necessary ingenuity to cope with unusual cases of trouble. If the autoist does not possess skill in inventing remedies for such cases, and is minus the necessary spare parts, he is reduced to the ignominy of leaving his car in the care of the repairer and making a journey to the nearest agency for that particular make of car to replace the broken parts. Again, he may encounter the trouble on a comparatively deserted road and will have to wait for a tow from some passing team.

Efficient Spares and Tools to Be Carried—Occasions necessitating repairs are by no means of such uncommon occurrence as might be supposed considering the refinement and care in construction given to automobiles of the present day, but these facts in no way justify any autoist, whether novice or "old hand," from taking precautions in the shape of spare parts and tools against trouble of any nature. Before starting out on an extended tour at any time the box or bag devoted to spares should be examined and if any are defective, others should be substituted for them. The writer suggests the carrying of the following spares and tools in addition to the regular outfit as sufficient to cope with a large majority of roadside troubles: twine, tire tape, copper wire, spare springs for valves, rubber bands, hand vise, medium Stillson wrench, small blow torch, soldering iron and solder, brace and several drills, drift, cotton waste and a pair of gloves for working. Some of these are included in first-class kits but the autoist would do well to obtain them all as there is no telling when they will be needed to enable progress of any nature to be made.

With regard to the tools carried, there is no economy in cheap wrenches, files, etc., and sad to say, many tool-kits supplied with automobiles contain puny hammers, lead files and chisels whose edges are destroyed at the first stroke of the hammer. Such tools should be gotten rid of as soon as possible and others of well-known and tried makes put in their places. If the autoist is in doubt as to what make of file or wrench to purchase, any machine shop can give him satisfactory answers.

Interchangeable Valves Handy in Case of Breakage—An exhaust valve breakage was formerly a serious affair, as unless the autoist had a spare valve along, he was obliged to limp home on one cylinder when he had a two-cylinder motor, or be towed if the motor had but the one cylinder. Until recently, inlet and exhaust valves were of different sizes and could not be interchanged, but there have been comparatively few motors turned out in the last two years in which the valves are not of the same size. With motors having valves thus interchangeable, when an exhaust valve breaks and no spare valve is at hand, the inlet valve can be removed and put in place of the exhaust and the broken exhaust valve made to operate as an automatic inlet valve. In making all such interchanges, the valves must be ground in on their new seats.

When the Break Occurs Below the Guide—In many cases when the break occurs below the guide, the stem parts through the slot. To enable the valve to operate automatically a hole is bored in the stem or a slot filed in it in a radial direction. The slot and hole are for the attachment of retracting springs, two of which are shown in Figs. 1 and 2. In the first figure, A is a flat spring which works caliper-fashion in seating the valve, its upper end being fitted into a slot B filed or cut in the valve stem while the lower end is pierced to accommodate the lifter casing set-screw C. The "spring" in Fig. 2 is an elastic band A fastened to the screw at one end and to the valve at the other by means of a cord B passing through a hole drilled in the stem.

Weight of Valves Militates Against Easy Operation—In repairs such as the above, it must not be expected that the

valves will operate as well automatically as when mechanically operated. Valves intended for mechanical operation are made heavier than those designed to work automatically, and the increased weight militates against their easy operation. Retracting springs have to be sufficiently light to allow the valve to lift under the action of the suction, but not so powerful as to slam it back on the seat when suction ceases. With the arrangement in Fig. 2 other bands can be added in case the tension is not strong enough but in Fig. 1 tension can only be regulated to a certain degree by increasing or diminishing the "cup" of spring A. The shorter the valve stem, the lighter will be the valve and the more readily will it lift, it should be remembered. The time needed in effecting either of these repairs is about 15 minutes, not including the grinding in of the valve. With a single cylinder motor, the valve will work sufficiently well for the autoist to proceed to some place where a new valve can be obtained. With a two-cylinder motor, much time and annoyance will be saved as limping along on one cylinder is slow and by no means sure. In multi-cylinder motors difficulty will be experienced in having

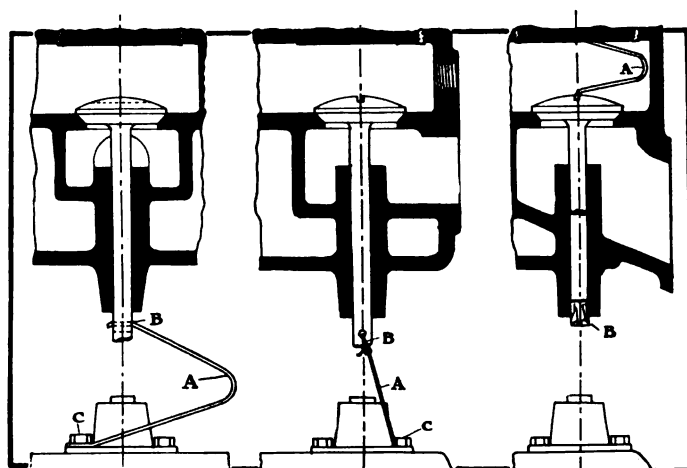

Fig. 1—Flat spring repair Fig. 2—Elastic band repair Fig. 3—Spring in the valve chamber
Utilizing Broken Mechanical Valve as an Automatic Valve

the "automatic" valve synchronize with the other mechanical valves but good progress is possible, nevertheless.

When the Break Is Within the Guide—In Fig. 3 is shown a repair when the stem is broken off in the guide. A spring A is placed within the valve chamber, one end in the slot in the valve head and the other bearing against the valve cap. The guide is plugged as at B to prevent air being sucked into the cylinder and weakening the mixture. Only in case of extremity should this repair be employed, as the spring will lose its temper or break and fall into the cylinder. It will, however, last a few miles, in some cases long enough for the car to reach a repair shop. In putting spring A in place, its upper end should bear off-center so that it will not be shot into the cylinder at the first suction stroke. If the requisite appliances are at hand, a hole can be tapped in the end of the stem and an arrangement of elastic bands like that in Fig. 2 attached to a screw set in the tapped hole. The plug in this case is to be left out.

A Practically Permanent Repair—Better and to all intent more permanent than the preceding when the break is at or above the slot, is the repair shown in Fig. 4. Provided there is sufficient space between the water-jacket and the broken end for the action of at least three spirals of a spring, this repair can be made to any mechanically-operated valve. A thread is formed on the stem at its lower end and two lock-nuts DD are screwed thereon, a flat washer E being put above the nuts to take the thrust of the spring. Spring C is cut off sufficiently to operate

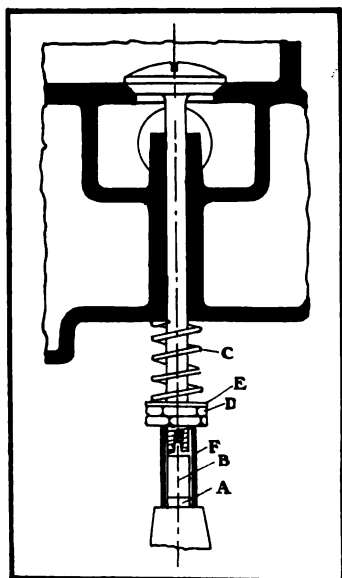

Fig. 4—Repair by insertion of filler piece

the valve without excessive strain on the cam as would be the case where the full sized spring was used in the restricted space. A piece B whose length is equal to the distance from the lifter A to the end of the stem minus the clearance when the valve is closed, is put in place on top of A and a short piece of tubing F put around both B and A to prevent the former from hopping out of place when the car is running. Clearance should be left between F and the lower lock-nut to prevent deformation and possible binding of the filler-piece B within the tubing. The advantage in such a repair is that there need be no grinding in as the broken valve is used in its proper place. The appliances neces-

sary to effect this repair, die, lock-nuts, tubing and filler-piece are not often found in an autoist's tool-kit, so that the operation has usually to be performed in a repair shop. With steady attention to the work and the material at hand, thirty minutes should be all the time needed to complete the repair. In a similar way a broken mechanically-operated inlet valve can be adapted to automatic operation, the tubing F and the filler-piece B not being needed in this case.

Break Close to Head Impossible of Reliable Repair—There is little use trying to repair a valve broken off close to the head. A spring put in the valve-chamber as in Fig. 3 will be of very doubtful service and while it may return the valve to its seat the danger of having the head sucked into the cylinder is too great to warrant the use of such a make-shift. With a single cylinder motor therefore, the autoist will be obliged to lay up the car until a new valve is to be had. With a multi-cylinder motor the inlet manifold should be removed, the port of that particular blocked by means of a piece of cardboard, heavy paper or sheet gasketing, and the manifold replaced, care being taken in replacing that there will be no leak at the joints due to the extra thickness of gasket on the blocked cylinder. The spark plug should be taken out of the "dead" cylinder to allow the air compressed by the piston to escape freely. In motors where the inlet manifold is integral with the cylinder casting such as is the case with certain forms of "block" motors, the broken valve should be placed on the inlet side and prevented from lifting by a block of wood of sufficient length to keep it seated when the valve cap is screwed down.

When the Starting Crank Is Inoperative—On all cars with the motor in front the starting crank is permanently attached to the car, so that it is only necessary to push it inward against the action of a spring to engage the dogs with the pin on the extension of the crankshaft. This pin is subjected to considerable strain and sometimes breaks off, leaving the autoist to start the motor in some other manner. A method of starting which requires no extra appliances consists in jacking up one rear wheel of the car, and after engaging the high gear and letting in the clutch to turn the wheel strongly and rapidly in the forward direction. When the motor starts, which it will do with surprising ease, the clutch should be drawn, gear shifted to neutral and the wheel lowered to the ground. The car will then be ready to proceed. In some cases it will be necessary to set the hub brakes after the clutch is drawn, in order to stop the spinning of the jacked-up wheel.

Removing Broken Screws and Studs—Occasionally a screw or stud breaks off close due to too strenuous application of the

wrench or in a futile endeavor to start the refractory piece with a hammer. There is not enough of the broken end projecting in most cases on which a grip with the jaws of a pair of pliers can be obtained, so that one of the following methods must be employed to withdraw the stump of the screw. If possible, a slot may be cut in it for a screw driver, but the break is so often below the level of the part into which the screw is set that this cannot be done. This being the case, a hole should be drilled in the stump and the tang of a file inserted so that it bears against both the side and bottom of the hole. On rotating the file the stump will usually come out, especially if the threads have been treated with kerosene. If the stump refuses to move, the hole should be tapped with a left-hand thread and on screwing in a left-hand screw the broken piece will be drawn out. The employment of a left-hand flat drill in drilling the hole will often bring out the stump without the necessity of tapping. As a last resort, a hole of as large diameter as possible without injuring the threads should be bored through and the shell remaining chipped or cut out. It would be well to go over the threads of the part from which the screw was removed in this manner with a tap to correct any deformation caused by the chipping or cutting.

Substitutes for the Funnel—Autoists when starting on a tour should make sure that a funnel is included in the list of accessories accompanying the car. There are some autoists who never carry such useful articles on the ground that wherever gasoline is purchased a funnel will be supplied, so why carry anything that is not necessary? Anyone that has toured extensively in sections considerably removed from the larger cities, where garages are few and far between, knows the habits of country store-keepers, how one funnel is made to do duty in delivering molasses, water and oil as well as gasoline and is often given no better care than an occasional rinsing. The effect of foreign substances in the gasoline is well known and their effect on the action of the motor soon after their introduction into the fuel system will indicate their presence, so that an autoist who relies on gasoline delivered through unclean vessels is running chances of being laid up on the road and having to go through the tedious operation of cleansing the carbureter and perhaps the entire fuel system. One funnel at least should be carried, therefore, for use with gasoline and to insure cleanliness, this should be fitted with a strainer. A second funnel could be advantageously carried for filling the radiator, but the occasions when water is needed in the circulating system are so infrequent that this funnel is not absolutely necessary. However, if a funnel is not at hand when needed, the autoist can use an old envelope from which one corner has been torn, the envelope being held as in Fig. 4, where C is the opening made by the torn off corner. A handkerchief placed in the filling aperture will act as an efficient strainer, or still better a piece of chamois can be used. An excellent guide for pouring in liquid of any kind can be formed from a tire gaiter, squeezing one end so that the two sides form a channel sufficiently small to prevent slopping over the filling aperture. It is of course understood that the gaiter is to be cleaned before being used for this purpose. Wrapping paper rolled into a cone, or a portion of an inner tube will also serve to conduct liquids in the absence of a funnel or a rubber hood formed into a trough can be used in emergencies.

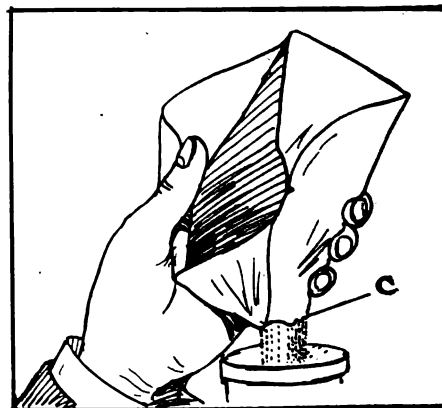
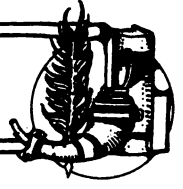

Fig. 5—Envelope used as a funnel



LETTERS INTERESTING AND INSTRUCTIVE



WHAT MAKES IT JUMP?

Editor THE AUTOMOBILE:

[1,921]—Will you please tell me through "Letters Interesting and Instructive" what makes my runabout, of a popular model, jump at times when running on the high gear, especially when the car is being run very slow. I have tried several things, such as valves, carbureter and commutator, but have not corrected it yet. I would like to have instructions as to how to time valves so as to get the best power results, also carbureter and commutator. Why does the engine get hot at times more than at others?
Clio, S. C. A. B. WELCH.

The make of car which you are driving and having trouble with is equipped with a planetary transmission, which has a high-speed clutch. The jumping of which you speak might be due to some foreign substance on the surface of this, which prevented the clutch from engaging fully, yet allowed it to take hold sufficiently to drive the car. Then, after having driven the car for some distance, the obstruction was shaken out and the clutch took hold with a jerk, resulting in the jumping action of the car. This would explain the jumping of the car upon one or possibly two occasions, but not regularly, as it would be impossible to get obstructions into the clutch every day, as this would necessitate. You give so little information that it is hard to make out just what is the trouble.

As to the matter of instructions for timing valves, commutator, and remedying carbureter troubles, that is a rather large contract. You will find much to interest you and collect a great many pointers on the subjects spoken of if you read the following articles in the back numbers of THE AUTOMOBILE.

On Carbureters and Carbureter Troubles, Letter 1919, June 17 issue; Letter 1876, issue of May 13; Letter 1870, May 6 issue.

On Valve Timing, pages 897 to 899, June 3 issue; Letter 1901, June 3 issue; Letter 1883, May 20 issue (Offset crankshaft); Letter 1846, issue of April 22.

On Care of Valves, Letter 1889, May 27 issue; Letter 1869, May 6 issue.

On What to Do When the Carbureter Won't Work, pages 649 to 651, issue of April 22.

The engine may heat from a variety of reasons. The piston rings may be tight, the cylinder bore may be out of true, the water passages may be obstructed so that as much water does not reach the jackets as was intended, or faulty ignition or wrong carburetion may cause heating. A dirty cylinder oil may leave particles of dirt on the cylinder walls, which may cut and score the cylinder walls, thus causing heating. Then, too, the excessively high temperatures of the part of the country in which you are located may have something to do with the heating. If you

could be sure that the latter was the source of trouble, substituting a light oil for water in the jackets would remove any possibility of this heating ever doing any harm to your engine. This would not remove the source of trouble, but would restore your peace of mind, for you would then know that no harm could come from overheating, whereas at present this may result in your pistons seizing, with much consequent expense.

If you should ever have this happen, that is, the pistons seize, the best thing to do is to immediately squirt a lot of kerosene into the top of the cylinder in question. This is very thin bodied as compared to lubricating oil, and will work its way down between the cylinder and piston, thus releasing the latter. In so doing, it will also lubricate the walls, so that the piston will not seize again immediately.

If this does not release the pistons it will be necessary to take the engine out of the car and by a liberal use of more kerosene and much brute strength, extract the piston from the cylinder. It will then be necessary to dress the piston, rings and cylinder walls up before they may be used again with safety.

GAS TURBINE PROSPECTS

Editor THE AUTOMOBILE:

[1,922]—Will you please tell me something more about the power of a gas turbine? I have a steam turbine, which can be so arranged as to cool both the moving and stationary blades with water. Now, what I want to know is, does this kind of engine develop the power? The cut shown in the May 27 issue of "The Automobile" is of a turbine, the blades of which cannot be water-cooled as mine can. My engine is not patented, but I have a small model which runs very well with steam. Do you think that it would pay to experiment further with this kind of an engine?
Gastonla, N. C. C. V. FITE.

If your device has an arrangement which allows of cooling both the moving and stationary blades, you have made a big step in advance, as this is one of the most vexing problems which inventors in the past have tried unsuccessfully to solve.

Considering that the power is in the fuel, latent so to speak, it is only necessary to devise an efficient machine to transform this latent power into rotary motion, to make the turbine form a very powerful source or energy in a rotary form. Of the three great gas turbine problems, namely, speed, heating of blades resulting in their dissolution, and gas tightness without friction losses, you appear to have solved one, and it would be advisable to continue your work along the same line. This, too, in preference to following the line of steam turbines, already well supplied with efficient and very successful prime movers of the rotary type.

VALVES AND DEAD CENTER

Editor THE AUTOMOBILE:

[1,923]—I have read Mr. Fay's articles on setting motor valves, particularly the June 3 issue, with great interest, but it seems to me that one very important point has been omitted, viz: setting the crank on the center.

Also, I do not consider the method in answer No. 1,897, in the same issue, a perfect one, as when the crank is nearly on the center the movement of the piston is so very slight that the periphery of the balance wheel can be moved several degrees without an appreciable movement of the piston.

A much better method is to make a tram from a piece of stiff wire with about half an inch of one end bent at a right angle and sharpened. Let the wire be long enough to reach some part of the frame so that it can butt against it, but always in the same place, having the point approximately at the center of the upper surface of the balance wheel. Now put one crank about 45° before the center and mark on the balance wheel with tram point. Measure how far bottom of piston is from bottom of cylinder, then turn motor forward until piston comes back to same point in reference to cylinder bottom and make another mark on balance wheel with tram. Find the center between these two marks and this center point, when brought to tram point, will put the crank on the absolute center. The other center will be half way around the balance wheel. Preserve the wire tram and the motor can be put on its center at any time.

An easy way to find the opposite center is to take a strip of paper that will reach around the balance wheel and double, using one-half for a measure. W. W. TREVOR.
Lockport, N. Y.

Your criticisms are interesting, even though not just. The Fay article is not finished, and the matter of which you speak was not within the scope of that section. Later chapters may take up practical methods, such as setting the engine on the exact dead center, adjusting clearances, etc.

As to the letter, in which we presume that you have reference to No. 1,901, headed "Timing an Old Engine," rather than the one given by you, No. 1,897, which deals with, as the caption indicates, "The Subject of Weights."

In the former letter the subject of setting the engine on center was not discussed at any great length, because it was considered that nearly every one who could drive a car could also set the engine on center properly. Your answer raises the question that perhaps we were wrong in this assumption. It seems, however, as if the statement given in the answer to the letter in question, "carefully determine the upper and lower dead centers," covers the use and practice of any known method of doing this work in a manner which would come under the head of "carefully."

It might be well to call attention to one part of your remarks which would not come under this same head, and that is the last suggestion to find the opposite center by using a strip of paper which reaches clear around, folded in the center to measure half-way around. This would be far from an accurate method, and after determining the upper center by the careful and painstaking method given, it would be a

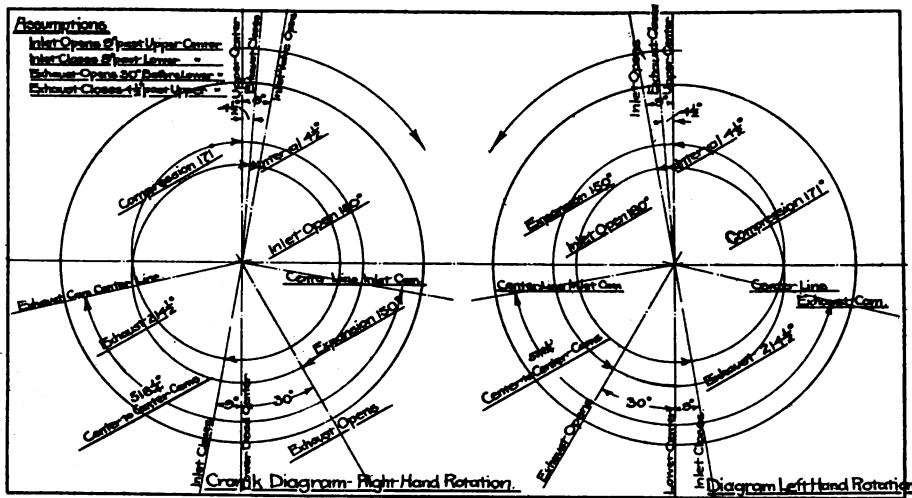

In Reversing an Engine, the Valve Diagram Must Be Completely Reversed

shame to spoil it by measuring around to the other center in the way mentioned. The circumference of an 18-inch flywheel is 56 1-2 inches. If a piece of paper as long as this will not stretch enough to throw away all of the accuracy of your former work we are very much mistaken. The proper way would be to take a steel tape, graduated into fine divisions, such as tenths and hundredths, measure the circumference, and then lay off half of that distance around in, say, a left-hand direction. Having done this, start around in a right-hand direction and lay it off again as a check. The measurements should agree exactly.

DETERMINING VALVE LIFT

Editor THE AUTOMOBILE:

[1,924]—Will you please give me a short empirical formula for figuring the lift of valves for automobile engines?
 Cos Cob, Conn. SAM HEILMAN.

Having previously determined the valve diameter, bore, stroke, speed and valve seat angle, the area of the valve passages should be equal to the bore area times the stroke times the revolutions per minute, divided by the permissible speed, say 6,000 to 10,000 feet per minute. Then the valve lift should be equal to this passage area divided by the sine of the seat angle times the valve seat circumference.

HOW TO REVERSE AN ENGINE

Editor THE AUTOMOBILE:

[1,925]—Kindly inform me in the next issue of "The Automobile" if the following can be done: I have a two-cylinder, four-cycle automobile engine installed in a motor boat. This engine has the cams made integral with the camshaft. Now, I would like to run the engine in the opposite direction. Could it be done by changing the gears without having a new propeller wheel? The latter is a single casting, with right-hand blades cast integral. PIERRE LARIVIERE, Champlain, N. Y.

Even if you could run the engine in the reverse direction it would be necessary to get a new propeller wheel to run left handed. Granting that you wish to go to this expense, the next thing to do will be to secure the reversal of the engine.

This is a big job and one that should be approached with due caution. First, you will need a new camshaft. This you may obtain from the manufacturer, or if that is impossible, you can have all of the cams for either the inlet or exhaust turned off and new separate cams made. The latter can then be attached to the old shaft in the proper place longitudinally and circumferentially, the latter being by far the more important.

It will be necessary to determine the present angle between the inlet and exhaust cams and on the new shaft; set the cams at that same angle, but in the reverse direction. To assist you in this a

set of angles have been assumed, the two diagrams plotted, and the angles resolved into camshaft angles.

Two figures are given to help you. In the first, the valve diagrams are given for a supposed case, with the ordinary right-hand rotation, and also for the same case with left-hand rotation. Then in the second figure this latter diagram is resolved onto the cam diagram and the camshaft is shown as changed. To do this it was necessary to assume that the two cranks of your engine were set at 180 degrees apart and that you followed the suggestion made, to machine the inlet cams off from the present camshaft and make new ones to key on in their place, but properly located for left-hand rotation.

When all this has been done your work will be about half through, for it will be necessary to alter the timing of your ignition, whether that be battery, coil and timer or magneto. The former system is easier to change and this may be done by altering the setting and then changing the wires. With the magneto, however, it will be necessary to have an entirely new machine, these being built to run either right or left hand.

Then there will still be the pump. If this is a centrifugal pump it will be necessary to move it and insert another gear in the driving train so as to drive it in the same direction as at present, but with the engine running in the opposite direction.

If it is of the gear type no alterations will be necessary as these pumps are usually constructed so as to be reversible—that is, they work equally well both ways.

So, too, with the fan, lubricator and all other accessories they will have to be considered and such of them as are not reversible will have to be driven in a different manner. All told it seems as if the work and cost of this change more than offset any possible advantage to be gained from the rotation in the opposite direction.

Editor's Note—Will W. H. S., New York City, whose letter was published in the June 10 issue of THE AUTOMOBILE, kindly send his address to this office?

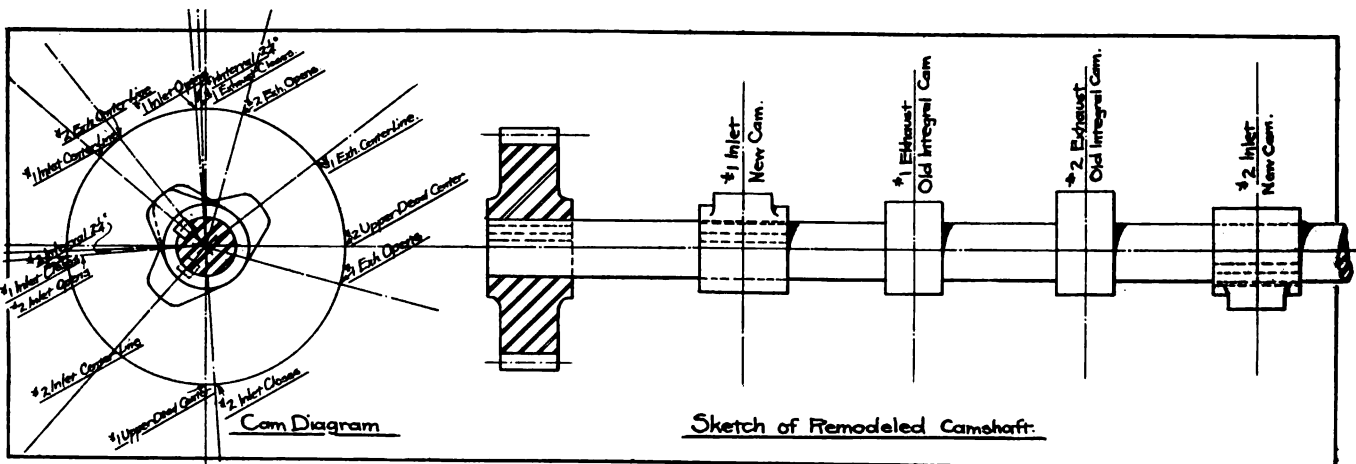

The Reversed Valve Diagram Applied to the Camshaft, and the Remodeled Shaft When Completed, with Two New Cams in Place

DESIGN OF KNUCKLE JOINT FOR TRANSMISSION*

BY RUDOLF THUROW, M.E., CHARLOTTENBURG

THE absolute freedom of relative motion necessary between the motor and the gearbox of an automobile, where these two essentials are separate units, is usually accomplished by means of the interposition of the effective but costly universal joint. A more economical form of coupling is to be found in a knuckle type of joint or link, each end of which is inserted in a recess in the shafts, as shown in Figs. 1 and 2. The chief question about the design of such a joint is the determination of the size of the surfaces in contact and the

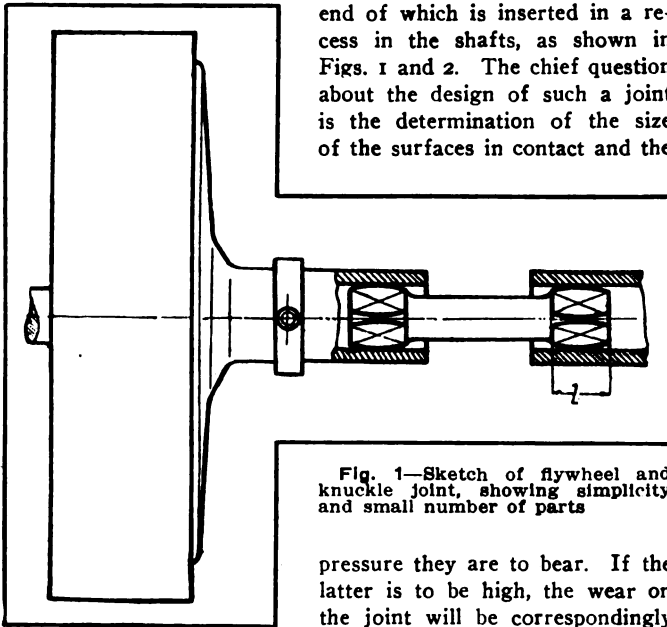

Fig. 1—Sketch of flywheel and knuckle joint, showing simplicity and small number of parts

pressure they are to bear. If the latter is to be high, the wear on the joint will be correspondingly rapid, while the stronger it is

made in this respect, the more sudden and jerky will be the coupling in action. The entire turning moment of the motor will then be transmitted directly through the parts of the knuckle, which means that the parts will have to be proportioned with this idea in view.

This gives the relation:

$$N_e = \frac{Pv}{75} \eta \tag{1}$$

The efficiency of the motor:

The speed v in meters per second = $\frac{2r\pi n}{60}$ and $\pi = 0.8$ of the $Pr2\pi n$

$$N_e = \frac{Pr2\pi n}{60 \times 75} \eta \tag{2}$$

Therefore it follows:

$$Md = \frac{N_e 60 \times 75}{2\pi n \eta} \tag{4}$$

In the knuckle joint, shown in Fig. 3, with a rectangular cross-section, the turning moment must be carried on four faces:

Consequently:

$$Md = 4P'r' \tag{5}$$

or:

$$P' = \frac{Md}{4r'} \tag{6}$$

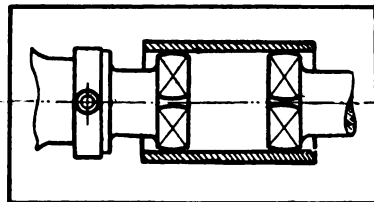

Fig. 2—Enlarged view of joint

In actual practice, however, these stresses must be carried on about one-third of the surface in question, so that this reduces to:

$$r' = -\frac{l}{3}b \tag{7}$$

l is the length of the bearing surface, so it must be:

$$P' = -\frac{b}{3} \times -\frac{l}{2}k \tag{8}$$

k represents the permissible deflection in kg/cm^2 .

With a special automobile steel of good quality, it may be given a value of $k = kg/cm^2$.

For the knuckle link in question it may reach:

$$NC4Iod \frac{C46O}{z} \text{---} odKS72 \tag{9}$$

But owing to the excessive stresses that will frequently occur and the resultant destructive effects upon the surfaces, it may often be considered expedient to employ more than four surfaces to transmit a certain amount of power. This brings us to the hexagonal cross-section illustrated by Fig. 4.

The equation is then:

$$P' = \frac{Md}{4r'} \tag{10}$$

and it may reach:

$$P' = \frac{Md}{6r'} \tag{11}$$

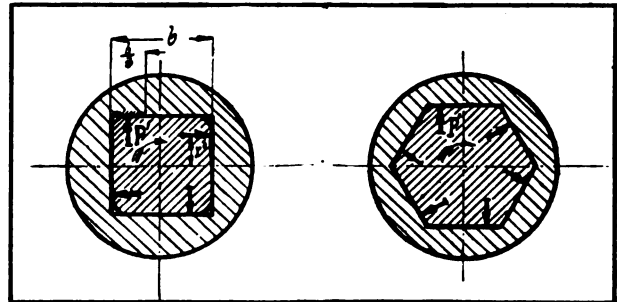

Fig. 3—Square type

Fig. 4—Hexagonal type

Knuckle Joints Shown in Sectional Form

It will then follow that the pressure on the surfaces k will amount to but two-thirds of the value previously given, and it will hold that:

$$k : k' = \frac{1}{4} : \frac{1}{6} \tag{12}$$

and consequently:

$$k' = -\frac{2}{3}k \tag{13}$$

The relation of the bearing surfaces in the hexagonal section is also much more favorable, but the six-sided construction naturally costs more. Practice alone can be looked to to determine the relative values of the square and hexagonal types.

Additional types are created by the extension of the number of faces to octagonal and higher forms, all of which present new problems to be solved. In the extreme this reaches the form of a gear meshing into another gear of the internal type. In practice this form is used with 12, 14 or 16 teeth, the number used depending upon local conditions, such as the allowable external diameter. So, also, with the width of the face.

*Translated from the German, by C. B. Hayward.

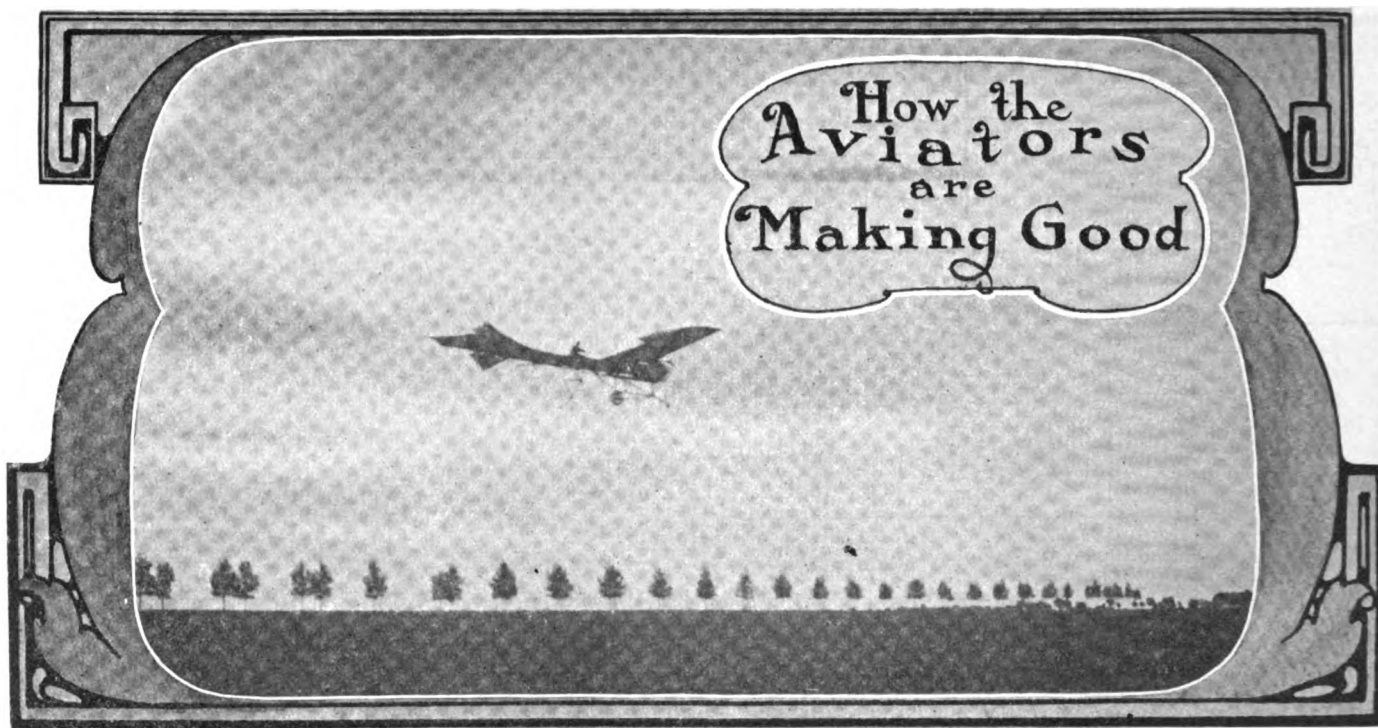

Hubert Latham, the English Aeronaut, with Antoinette Aeroplane, Breaking Monoplane Flight Record, at Chalons, France

PARIS, June 16—The present French aeroplane champion is an Englishman, who has succeeded, on an Antoinette aeroplane, in beating the record held by a Frenchman on an American flyer. Hubert Latham climbed into his Antoinette monoplane at Chalons a little before seven o'clock in the evening and did not settle down again until 1 hour 7 minutes 37 seconds later, having broken all records made in France with the exception of those of Wilbur Wright. First place in the flying world—excluding Wright, who is looked upon as unbeatable—had been occupied by Paul Tissandier, who remained in the air 1 hour 3 minutes on Wilbur Wright's old flyer.

Hubert Latham is a newcomer who purchased an Antoinette monoplane and took his first flying lessons about two months ago. Less than a fortnight ago he won the Aero Club prize for a flight of 500 yards, this being his first really important performance. This has been followed up by a flight of 37 minutes accomplished with such ease that on several occasions the pilot raised his hands from the steering wheels to take his cigarette from his lips. A steady breeze was blowing at the rate of 8 miles an hour when the start was made for the long distance record. After running 100 yards on the ground the

machine rose into the air at a speed of 55 miles an hour, and at an altitude of 50 feet described huge circles over the vast plain. Later the height was increased to 130 feet, the flying machine passing over the tall poplar trees lining the military ground with a respectable margin of safety. When a descent was finally decided upon dusk had settled down and a drizzling rain had made it almost impossible for the pilot to pick out his course.

The long distance flight was followed by the winning of the Goupy prize for a flight of not less than five kilometers away from a specially prepared aerodrome or operating ground. Members of the Aero Club measured a straightaway course across country, planted a flag five kilometers out and sent the aeroplane away. There were telegraph wires, a village and poplar trees rising to a height of nearly two hundred feet, with the result that it was necessary for Latham to soar to a great altitude in order to be free from collision. Running at nearly 50 miles an hour, the aeroplane soared over the village of Cuperly, the inhabitants of which greeted him with shouts of delight, rounded the flag in 4 minutes 13 seconds, and after a very wide detour settled down at his starting point, having been in the air altogether no less than 14 minutes.

Captain Burgeat, also an Antoinette pilot, was next taken up as a passenger and carried for a distance of 800 yards; three others followed, the longest flight with a passenger lasting 11 minutes 56 seconds.

RHEIMS AERO COURSE PREPARATIONS

PARIS, June 10—The Gordon Bennett and other aeronautical races to be run during the Rheims week, August 22 to 29, will take place round a specially prepared course marked out by four posts, each 60 feet in height, and painted bright red and blue in order to be clearly visible. Two sides of the course each measure 2.1 miles, while the two short lengths are just a fraction under a mile. The flying ground on which this special course is laid off will be entirely enclosed by a stout barricade having a circumference of over six miles, the spectators being massed behind the barricade, in which position they will be able to see perfectly, but will be unable to invade the ground reserved to the flyers.

It is expected that King Alphonso of Spain will be a spectator at the flights, a large house in the neighborhood of Rheims having been rented for his use during the month of August.

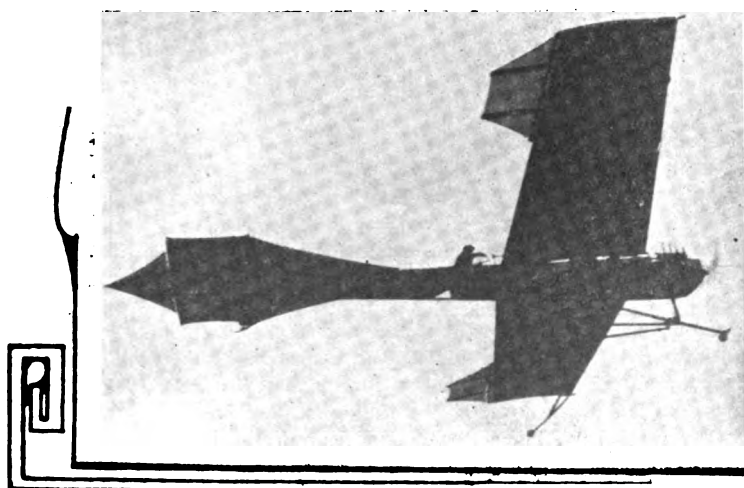

A Closer View of Latham's Bird of Flight

DAYTON HAS BIG WRIGHT CELEBRATION

Dayton, O., last week lionized the Wright Brothers, if such a term can be applied to those who imitate birds, and the nation and State had a very significant part in the celebration. But in interesting contrast to the wide enthusiasm exhibited by their home city, was the modesty of the two men whom it delighted Dayton to honor. Speeches have never been in the line of flying, but the whole world was startled by the fact that only four words were spoken by each on the first day of Dayton's jubilee, and on the next day when valuable medals were presented, Orville Wright said one sentence of seventeen words, and Wilbur spoke probably two minutes. Yet none the less were the honors heaped upon them. Thursday and Friday were set apart for the commemoration holidays for the city, and there were parades, dinners, a reception and a fireworks display to show the heartiness of the feeling, but at the same time the "Wright Aeroplane Factory" was working at nearly full force, perhaps the only one in the city doing so, and the two famous aviators spent several hours in it.

Triumphal arches spanned the main streets, American flags and bunting were everywhere in evidence, a martial air was instilled by the presence of national and State troops, and brass bands could be heard throughout the two days. On Thursday, at 9 o'clock every bell and whistle in the city blew for ten minutes, attracting the attention of the Wright Brothers, who were in their shops, so that they went out on the street in their shirt-sleeves to learn the cause of the commotion, and at 10 o'clock they were taken to the opening ceremony of the "Homecoming celebration." There was an item on the program from which something of interest was expected. It read "Responses by the Wrights," and there was something of wide interest therein, for each brother arose and said, "I thank you, gentlemen."

Nation, State and city paid tribute to the inventors on Friday when they were given the gold medals authorized by Congress from the United States, a diamond-studded medal bearing the official seal of the State of Ohio, and another from Dayton. Governor Harmon addressed the multitude for the Commonwealth; Gen. James Allen, Chief Signal Officer of the Army, for

the Government, and Mayor E. E. Burkhardt for the city. An international flavor was lent by the presence of Japanese Ambassador Baron Kogoro Takahira and Cuban Minister Carlos G. Velez. In answer to the speeches, Orville Wright said: "I wish our work was commensurate with the honors that have been heaped upon us. Thank you." Wilbur Wright found a happy topic and made a short, very short, speech. When the medals were given to the brothers they turned them over to Miss Katherine, the sister, who helped the boys in the earlier days of their work. Bishop Wright, the father, participated in the ceremonies.

The Wright aeroplane which will be used by Orville in the Government tests at Fort Meyer is already upon the scene. By June 28 it must pass the two tests in order to secure the \$25,000 offered, one to fly five miles straightaway and return with a passenger, and the other to fly at least one hour with a passenger at a minimum rate of 36 miles per hour.

KIMBALL'S BIG AEROPLANE WRECKED

NEW YORK, June 21—So badly was the big eight-propeller aeroplane of Wilbur R. Kimball injured at the old Morris Park grounds by striking a bank near the south turn that it may not be repaired. Mr. Kimball was making a trial with the machine, and after running the biplane up and down the track to tune up the motor, he started to see if it would rise, but he was evidently so intent upon operating the engine that he did not notice a swerving of the aeroplane. At the beginning of the turn the end of the big plane struck the bank and crumpled like an egg shell, forcing the machine violently around, and overflowing gasoline caught fire but was extinguished. Both frames were badly cracked, and some of the propellers broken, the front and side wheels smashed, and the controlling system deranged.

Glenn H. Curtiss made two flights on last Friday, in one of which it is claimed that he attained a speed of 46.7 miles per hour in a distance of about of about a hundred yards. In another his speed was 26 miles an hour over a distance of 99 yards, in which he tried to go as slowly as permissible with maintaining equilibrium. The tests will be continued for some days.



How Dayton, Ohio, Was Bedecked During the Ceremonies of June 17-18, in Honor of the Homecoming of the Wright Brothers



Vol. XX.

Thursday, June 24, 1909

No. 25

THE CLASS JOURNAL COMPANY

H. M. SWETLAND, President
A. B. SWETLAND, Business Manager
231-241 West 39th Street, New York City

EDITORIAL DEPARTMENT

A. G. BATCHELDER, Managing Editor
R. F. KELSEY, Associate Editor
THOS. J. FAY MORRIS A. HALL W. McK. WHITE D. R. HOBART
W. F. BRADLEY, Foreign Representative

ADVERTISING DEPARTMENT

M. C. ROBBINS, Manager LOUIS R. SMITH, New York
W. L. RALPH, 1035 Old South Bldg., Boston FRANK B. BARNETT, Cleveland
C. H. GURNETT, 1200 Michigan Ave., H. H. GILL, Detroit
F. W. VAN SICKLEN, Chicago T. B. VAN ALSTYNE, Philadelphia

Cable Address - Autoland, New York
Long Distance Telephone - 2048 Bryant, New York

SUBSCRIPTION RATES:

United States and Mexico - One Year, \$3.00
Other Countries in Postal Union, including Canada - One Year, 5.00
To Subscribers—Do not send money by ordinary mail. Remit by Draft,
Post-Office or Express Money Order, or Register your letter.

FOREIGN SUBSCRIPTION AGENTS:

ENGLAND:—W. H. Smith & Sons, Ltd., 186 Strand, London, W. C., and all book-
stalls and agencies in Great Britain; also in Paris at 248 Rue de Rivoli.
FRANCE:—L. Baudry de Saunier, offices of "Omnia," 30 Rue Duret, Avenue
de la Grande Armee, Paris.
GERMANY:—A. Seydel, Mohrenstrasse 9, Berlin.

Entered at New York, N. Y., as second-class matter.
The Automobile is a consolidation of The Automobile (monthly) and the Motor
Review (weekly), May, 1902, Dealer and Repairman (monthly), October, 1903,
and the Automobile Magazine (monthly), July, 1907.

IF WE ONLY HAD THE TIME

What is the matter with the American manufacturer? Five and more years ago an American invented, built, and partly perfected a slide valve engine. Laughed at and repulsed, he went abroad. There he received support and the new motor was still farther perfected, and later put on the market. With the latter step came the necessary publicity to bring it before the public, which resulted in some doubts as to its real ability. This having been proven beyond the hopes of the most sanguine friends, all of Europe devoted to automobiles has taken up the sliding valve idea. Many manufacturers are building under license to the American inventor, and as many more are at work on similar devices beyond the scope of the patent. While this has stirred up the subject of valves, much work is also being done on rotary valves and much investigation is being conducted to shed light on the complex subject of the introduction of the gaseous charge into the cylinder, and after combustion, its removal therefrom. In the meantime, the American manufacturers appear to plod contentedly along in the same old way, using the same old valves, and never giving a thought to finding anything different.

So, too, with spring wheels; in England and in France much experimentation is in progress, with the object of solving the combination problem of wheels and tires. These experiments may not have produced a perfect resilient wheel, the use of which would send all air-filled

tires into oblivion, but at any rate they will result in some progress in this direction, and a more intelligent grasp of the subject.

In England, at present, there is going on a spirited discussion of the merits and demerits of front wheel brakes. This follows their adoption and use on a number of first-class cars. As this adoption and use is but the result of many months of construction and tests, it follows logically that the English manufacturers must have started work along these lines upwards of half a year ago, and possibly as long as a year ago. When we then admit that nothing is being done with the matter of front brakes on this side—whether these are good, bad, or indifferent—is it not equivalent to the admission that we are from a half year to a year behind the times? In so far as the goodness or badness of this particular device has never been publicly proven nor disproven, so that it is still but a matter of conjecture, we can in this case save ourselves and our self-respect by condemning it.

But in the long run that way will not always answer, for it is not possible to gain the front rank by crying down new devices as bad simply because their goodness has not yet been proven conclusively.



TWO SIDES TO EVERY QUESTION

In the course of a well-written editorial headed "Rules of the Road," the Buffalo Express sums up the situation with the following paragraph:

Let's keep the automobile in its place, but don't forget that there are other offenders, that there are other unenforced laws, besides those which apply to motor vehicles. Perhaps the world would be happier if it did not rush about so in devil wagons, but common sense can be applied even to this proposition. A class gets its reputation from its worst members, but the fact remains that there are good automobilists and bad and that the good far outnumber the bad. Let's have reasonable laws, applying to all classes, and let's have them enforced. Make an example of the fellow who blinds you with his car or causes it to emit unnecessary noises and smells, and look to the quiet, decent user of the automobile to applaud and sustain the effort.

Previous to its summation of the matter, the Express refers to the fact that it is undeniable that speed laws are violated; that some chauffeurs drive "as if the devil were after them—or sitting at their elbows;" that dripping-pans are emptied too often; that poor drivers use the "cut-out" too much, and that the use of acetylene lamps in city streets is abusive.

A great many automobilists do not so offend, states the Express, which then proceeds to tell of the unfair treatment to which the driver of the motor-driven vehicle is subjected in one way or another. Reference is made to the suburban trolley with its blazing headlights; the unilluminated wagon and carriage of the horse-drawn variety, and the necessitated dodging of the careless cyclist, though the absorbed pedestrian who walks across the road in a trance is forgotten.

Certainly it is gratifying these days to note the common-sense attitude of the enlightened daily press. Time was when the automobile came in for a more or less general denunciation in a majority of daily and weekly newspapers. Gradually, and now very perceptibly, with increase in numbers automobilists comprise all classes, where once they consisted principally of a select few of discerning enthusiasts who simply took to the motor-driven vehicle in advance of the others, and at the same time thus financially helped the makers through the period of experimentation.

WHY THE PARIS SALON HAS BEEN ABANDONED

PARIS, June 16—There will be no Automobile Salon in Paris this year, and for the first time since it was built the magnificent Grand Palais, in the Champs-Élysées, will remain empty and deserted during the months of November and December. For eleven successive years the Paris automobile show has been a feature, growing in size and influence until it was by far the most important industrial and social event that the city possessed. The Artists' Salon, the Horse Show and a few others occupied the same hall during a portion of each year, and succeeded in attracting no small amount of attention; but not one of them had the same amount of éclat as the automobile exhibition, and all combined did not arouse the same interest in all classes of the French public as the display of mechanically-driven vehicles.

In their desire to make it the most world-stunning exhibition of the year, the organizers of the Paris Salon have overshot the mark. Changes in automobile design having become less and less during the past four years, there was lessened necessity for an automobile exhibition. Added to this that the country had no longer any need to be converted to a mode of locomotion towards which it had been favorably inclined from the beginning; that the display was a most costly affair for the manufacturers; that the profits went to a body of men not directly engaged in the industry—all this considered, and it is not surprising that the annual Paris Salon has had to go by the board. It should be added that there will be another one in 1910, but it would be too much to say that it will be on the same lines as those of the past.

When the first purely automobile show—an offshoot of a cycle exhibition—was held in Paris in 1897 the Automobile Club of France undertook the lion's share of the responsibility and the labor. As the industry grew, three trade associations joined the club, and of recent years the annual exhibition has been organized by a special joint committee formed by the Automobile Club of France, which appointed its delegate, Gustave Rives, as general manager, and took 50 per cent. of the profits; the Chambre Syndicale de l'Automobile, allowed 20 per cent. of the profits; the Chambre Syndicale du Cycle et l'Automobile, also entitled to 20 per cent., and the Union of Cycle Manufacturers taking 10 per cent. of the profits. The tire manufacturers, some of whom had individually greater trading interests than the whole of the cycle makers combined, had no share in the show; while the important section of body builders—more important here than

in other countries, owing to the separation of the industries—was also unrepresented on the organizing committee. The Automobile Club of France, more closely connected with the sporting than the business section of the automobile, was given an importance equal to that of the whole of the manufacturers, while the actual exhibitors had to pay in to them thousands of dollars in entrance fees and an equal sum in general expenses to maintain the high standard of the show. Naturally the club sought to continue this state of affairs, for the show allowed it to net the respectable sum of about \$10,000 per annum.

The first to break away was the Chambre Syndicale du Cycle et de l'Automobile, which drove out its pro-Salon committee, put M. Darracq at its head and voted unanimously against a show next year. The Automobile Club of France and the Cycle Manufacturers took up the opposite position, while the Chambre Syndicale de l'Automobile, which is very closely connected with the club, having its offices in the same building, appeared to hesitate. The Marquis de Dion, president of the Chambre, was strongly in favor of a show, and although his committee a few weeks ago voted for abandonment, the vote had to be ratified by a full meeting of the members. The battle took place this week, and after several hours' fierce fighting the anti-show group got the upper hand, the vote being 79 against the holding of a show, 28 in its favor, and 3 blank papers. In face of such a vote it is, of course, impossible for the club to think of throwing open the doors of the Grand Palais this year. The manufacturers voted on principle in favor of a show in 1910, but nothing was decided as to the bases on which it will be held. There is every possibility that the old conditions will be changed and that the manufacturers' share in the profits will be very much larger than it has been in the past. The system, too, of allotting the best positions to the oldest established French firms, or those having been most successful in speed tests will also be swept away, the result of such a system being to give to the early firms an importance in the eyes of the public which they have, industrially speaking, in many cases long ceased to occupy. The manufacturers are, for the most part, in favor of drawing of lots for the whole of the show spaces, or in lieu of that of admitting all firms producing a certain number of cars per annum to draw for positions in the center of the hall, irrespective of nationality or date of origin. Either one of these propositions seems equally fair to all concerned.

ONE-LUNGER WINS FRENCH VOITURETTE RACE AT BOULOGNE

BOULOGNE SUR MER, June 20—Giuppone, driving a single-cylinder Lion-Peugeot, to-day won the fifth annual race of the Coupe des Voiturettes, held on the Boulogne circuit, covering the 282.5 miles in five hours and 56 minutes, averaging a speed of 47.5 miles per hour. Goux, in a car of the same make with two cylinders, finished second, while Thomas, in a single-cylinder Le Gui, was third. Boillot, in another one-cylinder Lion-Peugeot, was fourth, this firm thereby making the best team performance. Pilliverde, Zuccarelli, and Derny, each driving four-cylinder Hispano-Suiza cars, took fifth, sixth, and seventh positions, a remarkably good display. Two English Calthorpe machines, of four cylinders, driven by Porter and Burgess, respectively, finished eighth and ninth. There were twenty-one starters and eleven were eliminated through mechanical defects during the course of the event.

A heavy fog necessitated an hour delay in the morning at the start, and even when the machines were sent away, in France's only speed contest of the year, the drivers could see but about 500 yards. Later the mist lifted and magnificent weather pre-

vailed. The only mishap of the day was the overturning of Farcy's single-cylinder Crespelle machine, which took fire and was almost entirely destroyed. There were twelve rounds to be covered and after the first three were completed the interest centered in the competition between the Lion-Peugeot and the Hispano-Suiza, the former of which was the faster make, and after half the race was completed, there was no doubt of the finish, barring accidents.

A method of treating the course with calcium chloride, instead of oil, was the greatest success, there being no dust, and none of the participants stopped to have their eyes treated.

OPEL WINS PRINCE HENRY TOUR

BERLIN, June 17—Germany's premier touring contest, the Prince Henry competition, was won by Wilhelm Opel in an Opel car, with Willie Poegge second in a Mercedes. Of these two makes in the event there were 16 Opels and 8 Mercedes. The course was 1,132 miles in length.



The Crowd That Lined Readville's Historic Course, on Bunker Hill Day, to Witness the Auto Races

BOSTON, June 21—Bay State Automobile Association and Readville track have long had reputations as the sponsor and site of some of the best automobile track race meetings in the country, but all previous successes were eclipsed on Thursday. A new world's record of 23:35 for twenty-five miles by DePalma; a new record for the track of 54 seconds by the same driver; almost total absence of tedious delays and accidents, races won by a wheel, and keen competition all the way through, were some of the features that entertained the large crowd for four hours and sent them home well satisfied. Even tire trouble did not interfere materially with the races, the absence of punctures being remarkable, considering the high speed that was made in almost every one of the eight events on the program. The weather was ideal and the number of automobiles along the home-stretch and within the track was very large. The races were under the able management of Chester I. Campbell, manager of Boston's automobile shows, and his associates on the committee were V. A. Charles, C. J. Bailey, Frank E. Wing, W. C. Schmunk and James Fortescue.

DePalma was easily the star of the meet. Next to DePalma the honors went to Lorimer with the Chalmers-Detroit, who gave the former a long and hard tussle in the Harvard trophy race, making him push his car to the limit, and he captured the second most important event, the contest at ten miles for the Automobile Trade trophy.

The Harvard trophy event was a free-for-all, the winner taking the magnificent trophy and \$500 in cash, second car winning \$200, and third car \$100. It was run in two preliminary heats at five miles and a final at twenty-five miles. In the final the cars were the Fiat, Chalmers, Detroit, Alco, Renault, and Allen-Kingston. DePalma got the lead at the start and was never headed. The first mile the Alco was second and then it was passed by the Chalmers. At the end of five miles it had developed into two contests, the Fiat and Chalmers-Detroit fighting for first place and the Alco and Renault having it out for third position. At ten miles the first two cars, racing close together, were a quarter mile ahead of the second two, with the Allen-Kingston nearly a lap behind. At fifteen miles the Fiat led by an eighth of a mile over the Chalmers and by a half mile over the Alco, three-quarters over the Renault and more than a lap over the Allen-Kingston. The positions remained about the same until the twentieth mile, when the Alco had tire trouble and dropped into fourth place, the Renault going up into second. Then began some of the finest driving ever seen at Readville. Closely pursued by Lorimer, DePalma let out to the last notch and whirled around the track

scarcely raising the dust, so neatly did he take the corners. In the twentieth mile he lapped the Alco and in the twenty-fourth the Chalmers. His time was 23:25 and he was given a rousing reception by the crowd when he came back to the stand and it had been announced that a new world's record had just been made.

In the Automobile Trade trophy race at ten miles for stripped stock cars chassis over 36-horsepower there were seven entries and all came to the tape. They were two Allen-Kingstons driven by Glenworth and Hughes, Knox driven by Basle, Welch driven by S. L. Rogers, Alco driven by Grant, Stoddard-Dayton driven by B. W. Shaw and Chalmers-Detroit driven by Lorimer. The first eight miles were a duel between the Chalmers-Detroit and the Alco, the Alco leading for the first mile and then the Chalmers going to the fore. In the ninth mile, however, the Alco had trouble and the Stoddard-Dayton went up to contest with the Chalmers-Detroit for supremacy. Lorimer, however, had the race well in hand and won in 9:46 1-5, by about five-eighths of a mile over the Stoddard-Dayton. The Allen-Kingston driven by Hughes was third, the other Allen-Kingston fourth, and the Welch fifth.

By all odds the most exciting finish of the day was in the five mile-race for roadsters and runabouts of 31-horsepower and over, for the Knowles cup. There were two preliminary heats and a final. The Allen-Kingston, driven by Glenworth, won the first heat in 5:17, with the American Roadster, driven by A. J. Andrews, second; and the Chalmers-Detroit, driven by F. F. Cameron, third. In the second heat Hughes's Allen-Kingston dropped out, and the other two cars were stopped at the end of the third mile, both qualifying for the final. In the final were the Stoddard-Dayton, Allen-Kingston, Chalmers-Detroit and Welch. The Stoddard-Dayton cut out the pace for four miles, having a good lead with the other three bunched. Then it had trouble and the others closed up and the final mile was as pretty a contest as is often seen at an automobile meet. Coming into the head of the stretch to the tape all the cars were bunched like a lot of running horses. Here Rogers showed the reserve power in his Welch and letting it out a notch shot to the front and went under the wire a matter of a few feet ahead of the Allen-Kingston, with the Chalmers a close third and the Stoddard-Dayton fourth. The time was 5:16.

The races opened with the amateur event of five miles with four starters, the Welch driven by A. W. Merriam, Chalmers-Detroit driven by C. S. Hall, Buick driven by Ryall, and Stoddard-Dayton driven by Shaw. The Stoddard-Dayton won in 5:21, with about a quarter mile to the good over the Welch.

DePalma's mile trials and his match with Basle followed, and then Harry Grant with the Alco, and Hugh Hughes with the Allen-Kingston were sent five miles in a match, Grant winning in 5:6 1-5. It was a close race all the way. A five-mile race for touring cars was awarded to the Midland, which was the only touring car that started, the Jackson which made the distance in 6.04 3-5 being declared a runabout and the Buick dropping out. The three-mile race for roadsters and runabouts up to 30-horsepower had three starters, a Columbia driven by J. J. Coffey, a Chalmers-Detroit Thirty, driven by F. F. Cameron, and a Buick driven by James B. Ryall. The Buick was early out of the going and the Columbia had little trouble in winning over the Chalmers-Detroit in 3:38 with a quarter mile to the good. The only accidents of the day were minor in character, two racing cars catching fire apparently from back-firing. These incidents caused some excitement but little damage. The summary:

5 MILES FOR BAILEY TROPHY, AMATEUR DRIVERS

Car	H.P.	Driver	Time
1 Stoddard-Dayton ...	60	B. W. Shaw.....	5:21
2 Welch	70	A. W. Merriam.....	
3 Buick	80	J. B. Ryall.....	

SPECIAL TRIALS TO BEAT TRACK RECORD OF :54 2-5

1 Flat	R. DePalma	:54 1-5 & :54
--------------	------------------	---------------

25 MILES FOR HARVARD TROPHY, OPEN TO ALL

First Prize Trophy, and \$500; Second Prize, \$200; Third Prize, \$100
 First Heat at 5 Miles:

1 Flat	60	R. DePalma	4:54 4-5
2 Chalmers-Detroit ...	40	L. B. Lorimer.....	
3 Alco	60	H. F. Grant.....	

Second Heat at 5 Miles:

1 Stoddard-Dayton ...	60	B. W. Shaw.....	5:6 3-5
2 Allen Kingston.....	48	C. A. Glenworth...	
3 Renault	60	C. Basle	

Final Heat, 25 Miles:

1 Flat	60	R. DePalma.....	*23:35
2 Chalmers-Detroit ...	40	L. B. Lorimer.....	
3 Renault	60	C. Basle	

*New world's record.

5 MILES SPECIAL MATCH RACE

1 Alco	60	H. F. Grant.....	5:6 1-5
2 Allen Kingston ...	48	H. Hughes	

5 MILES FOR TOURING CARS UP TO AND INCLUDING 36-H.P.

1 Midland	Jackson	6:4 3-5
-----------------	---------------	---------

(Disqualified for not having equipment according to specifications; protested).

10 MILES FOR AUTOMOBILE TRADE TROPHY FOR STRIPPED STOCK CAR CHASSIS OVER 36-HORSEPOWER

1 Chalmers-Detroit ...	40	L. B. Lorimer.....	9:46 1-5
2 Stoddard-Dayton ...	60	B. W. Shaw.....	
3 Allen-Kingston	48	C. A. Glenworth...	

3 MILES FOR STOCK ROADSTERS UP TO 30-HORSEPOWER FOR THOMAS TAXICAB TROPHY

1 Columbia	24-30	J. J. Coffey.....	3:38
2 Chalmers-Detroit ...	24-30	F. F. Cameron.....	

5 MILES FOR ROADSTERS AND RUNABOUTS, 31-HORSE-POWER AND OVER, KNOWLES CUP

First Heat:

1 Allen-Kingston	48	C. A. Glenworth...	5:17
2 American	50	A. J. Andrews.....	
3 Chalmers-Detroit ...	40	F. F. Cameron.....	

Second Heat:

1 Stoddard-Dayton ...	60	B. W. Shaw.....	None taken.
2 Welch	70	S. L. Rogers.....	

Final Heat:

1 Welsh	70	S. L. Rogers.....	5:16
2 Allen-Kingston	48	C. A. Glenworth...	
3 Chalmers-Detroit ...	40	F. F. Cameron.....	

25 MILES SPECIAL MATCH

1 Flat	60	R. DePalma	24:39 2-5
2 Renault	60	C. Basle	

SHERMAN SETS TIME FOR CAPITAL RUN

WASHINGTON, D. C., June 21—With the Vice-President of the United States to set the secret official time, the automobilists of this city yesterday participated in a sociability run to Great Falls, a distance of 16.3 miles. The affair was promoted by the Washington Times, and was designed to show that automobiles could be driven over the conduit road (one of the most tempting stretches of road in this country) without the drivers becoming imbued with the racing mania. In this respect, as in all others, the run was a pronounced success, and proved to be the greatest automobile event ever given here. In setting the time, which remained sealed until after the contestants returned to the starting point, Vice-President Sherman said he was well aware that the run could be made in very much less time than he fixed. He went on to say that he fixed the time on the theory of encouraging, rather than discouraging compliance with the law. Upon this theory he thought the run ought to be made in 54:07.

There were 74 contestants in the run. Curiously enough it remained for a Thomas taxicab, driven by H. M. Miller, a public chauffeur, to nearest approach the secret time. He covered the 16.3 miles in 54:13 4-5, just 66 4-5 behind the official time. A Baker electric, driven by John Bartrem, won second place, his time being 54:24 2-5. R. P. Andrews, in a Chalmers-Detroit, was third, the time being 53:48, while another Baker, piloted by G. A. Weaver, won fourth prize. His time was 54:28. Miss Lillian Miller, a sixteen-year-old girl, captured the fifth prize in a Ford, her time being 54:38 3-5. There were twenty-one prizes in all.

The weather conditions were ideal, and the run attracted much attention, thousands of people being at the starting point. They returned five hours later to hear the returns read, and kept a big detail of police busy holding them in check.

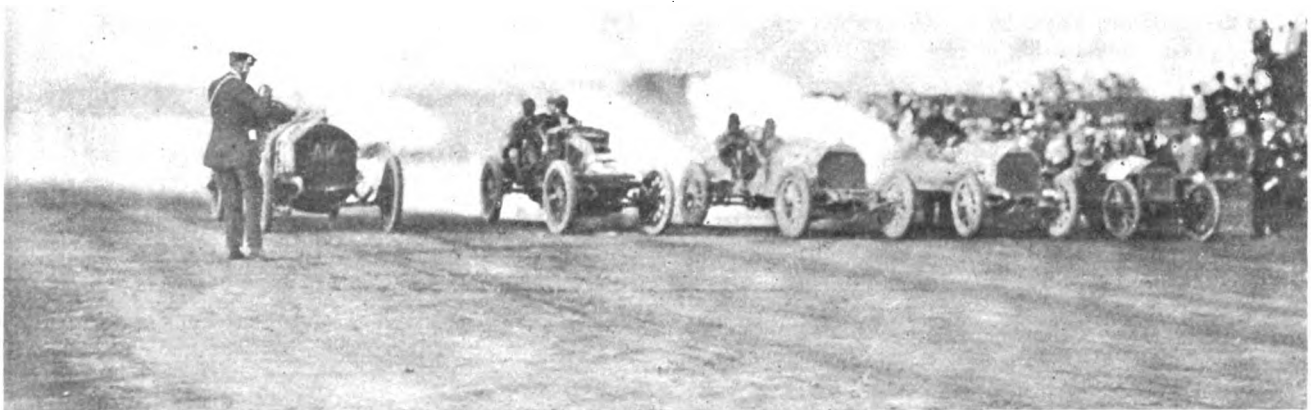

Start of the 25-Mile Free-for-All, at Readville Track, in Which DePalma Drove a Record Victory

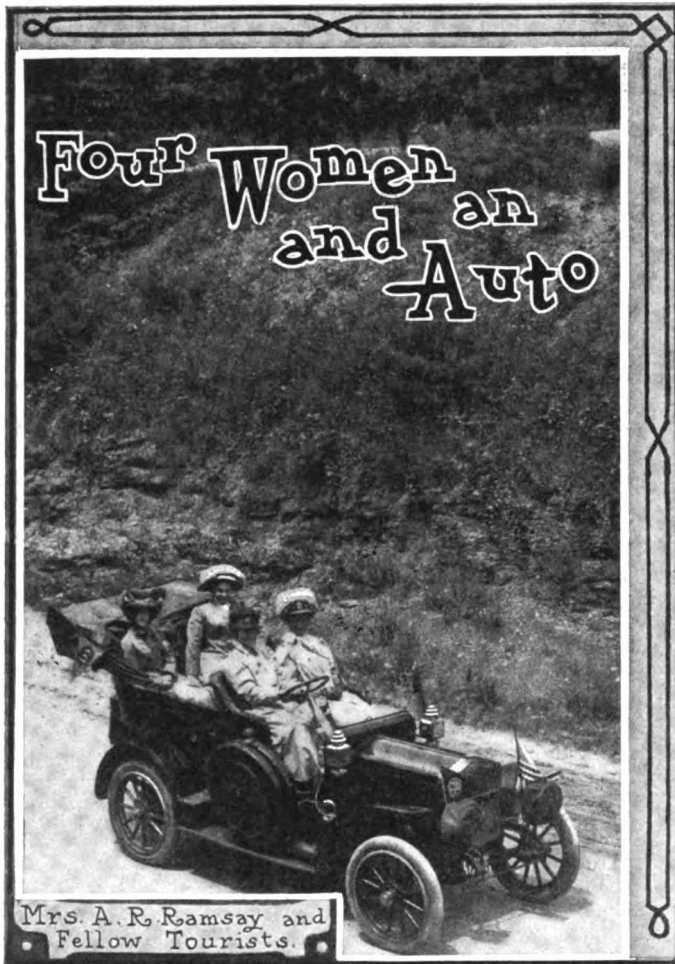

CHICAGO, June 21—"We have had a most enjoyable time so far," said Mrs. Alice R. Ramsey, when she and her party arrived in Chicago en route for San Francisco in a Maxwell car. "So far it has been perfectly lovely and we feel certain that the remainder of the trip will be equally so. Excepting for the first two days of the trip, when it rained hard and the roads were muddy, the trip has been almost without incident, and we have simply sailed along as fast or as slow as we pleased, enjoying the beautiful scenery which, by the way, we expect will be even more beautiful as we go west."

When Mrs. Ramsey left New York, June 9, on the first transcontinental trip ever attempted by four women, in her Maxwell touring car, she was given a right royal sendoff, and this has been continued in each city where a night stop was made. Buffalo was reached on Saturday, and the tourists remained there until Tuesday on account of the reception accorded them and the many requests to do so. On that day they traveled to Erie, reached Cleveland on Wednesday, Toledo Thursday, South Bend Friday, and Chicago on Saturday.

Many have been asked why the women are taking this long trip. This can best be answered by the fact that Mrs. Ramsey is an ardent automobile enthusiast, who believes in the driving of cars by women just as much as by men. As proof of the ease with which women can handle a car, make all necessary road repairs and such, Mrs. Ramsey decided to spend a vacation on a long tour, and in a way blaze the way across the American continent for other fair motorists. This is the real reason for the trip, which no woman has ever before attempted without a man at the wheel. And, too, there is other reason for it; her desire to see properly the beautiful Western country in the proper way. On the trip she is driving the same Maxwell car in which she has competed with great success in a number of endurance runs in New York and Philadelphia. Her knowledge of the car is most thorough and capable.

LOGICAL PLEA FOR AUTOMOBILE SANITY

By CHARLES CLIFTON, PRESIDENT, A. L. A. M.

Automobile owners, as a rule, in discussing their costs generally name the great item of expense as being tires, and in that connection they are quite inclined to arraign the makers of pneumatic tires as being responsible for this condition. These statements are an individual expression of opinion based on more or less experience, and doubtless justified in part by the records of bills paid.

These remarks in the same sense are an individual expression of opinion based upon the same facts and are contributed in the hope that they may suggest a way of reducing the sum total of tire bills, as well as leading in the direction of safer and saner methods in driving, and, in the last analysis, greater pleasure from motor cars.

There are three prime factors responsible for short tire life. First, excessive speed, especially during the warm months. Second, changes of direction at a high rate of speed; and third, excessive and unnecessary use of mechanical brakes. My experience has gone to prove that—punctures excepted—the life of tires is enormously prolonged by avoiding the above three cardinal enemies of the pneumatic tire.

So much for the direct money cost, but if these three cardinal principles are insisted upon by owners, the liability of accident will be reduced to a minimum, and all the high costs incident to property and personal damage. Accidents will also be reduced, as well as wear and tear mentally on an owner in connection therewith. In other words, sanity in the use of the motor car is an incalculable money value which no owner should ignore; and the reverse of the proposition is an unnecessary extravagance, which if indulged in should not carry with it an investive against the tire manufacturer or the manufacturer of the motor car. In other words, the responsibility for high costs in running expenses is absolutely in the hands of the owner, or perhaps more directly in the hands of the driver. Excessive speed under all conditions is done at high cost which can only be reduced by the adoption of sane methods.

To go a step further in this line of reasoning, I wish to plead for saneness in the use of highways. Not only in the matter of excessive speed, but also in the relation which should subsist between those who ride in cars and those who use it in other and older ways. The antagonism of the farmer against the automobile is mainly the result of a series of circumstances which to "the other fellow" seems like a succession of outrages. It is well for the driver of a motor car to realize that the other fellow used the highway, more or less unmolested, ever since there were highways. That while he may feel he has pre-emption, that pre-emption goes no further than the joint use. For the driver of a motor car to assume to use more than his share of the road, to make of his vehicle a menace, or at the very least a nuisance to other users, is a very natural cause for antagonism. The users and drivers of motor cars can, by sane driving, do the larger part in accomplishing a reversal of this sentiment, and in any event only fair play will eliminate the present friction.

NO RACE TO BE HELD AT DIEPPE

PARIS, June 16—The project to hold an open speed test on the Dieppe course, with Victor Breyer as manager, has been abandoned in view of the disinclination of the authorities to grant permission. Although the proposed race was in no way connected with the Automobile Club of France, and was intended more for private owners of racing cars than for manufacturers, the promoters were made to understand that a petition to hold the race would not be favorably received unless it came through the club. Naturally the racing board of the club did not look with any favor on the intruder and the project had to be abandoned. It is declared that the club promised to hold an international race itself next year on the Dieppe course, but no official confirmation of this is available. If a race is held at Dieppe the Angers district will have just cause for protest.

CARRIS BEST IN PENNSYLVANIA ENDURANCE RUN

By GEORGE M. SCHELL.

PHILADELPHIA, June 19—After one of the most grueling contests of the year, the State Highway Endurance contest of the Quaker City Motor Club, from this city to Pittsburg and return—750.5 miles—came to a conclusion last evening with the veteran Franklin-Carris combination a long-margin winner in Class A (touring cars over \$2,000); the 45 horsepower Haynes, driven by Walter E. Shuttleworth, annexing the Class C trophy for runabouts over \$2,000, and Walter Cram, in his Mitchell "20," capturing the Class D cup for runabouts listed at \$2,000 or less.

A series of rains during the preceding fortnight had rendered all but the comparatively few-and-far-between stretches of State highway met with on the route nearly untravelable in many places, especially through the mountains, and fully 40 per cent. of the route may be included in this category. The road conditions were frightful. Soft, adhesive mud and ruts—the latter in some places 15 inches deep—formed the roadbed in these sections, and the strain put upon the cars by the continual grind, and the subsequent speeding in an effort to make up lost time, told heavily in the penalty column. That the small, but select entry list should have stood the continued pounding as long as they did is little short of wonderful. As it was, the two cars that fell by the wayside—the Elmore and the Palmer & Singer, both in Class A—had finished four-fifths of the journey, and that the hardest part before they succumbed. In the case of the Elmore, which had been clean score all along, it took an accident to eliminate it—a contrary countryman refusing to give young Hardart, its driver, sufficient room to get past, the taking of a long chance resulting in the tearing loose of the car's rear construction by a skid into a roadside culvert heading. Broken springs in a section far removed from a repair shop so delayed the Palmer & Singer on the last day that it was withdrawn. Nearly all troubles were caused by terrible roads.

The strenuous experiences of the Haynes crew began on the first day and continued through to the end. As related in last week's issue, a broken axle 75 miles out from Williamsport, the night stop, cost the car over 12 hours time penalty, and the second days' start was made with but an hour's interval for breakfast and supplies. Shuttleworth, although nearly exhausted, managed to get into Johnstown with but 15 minutes' time penalty registered against him, due almost entirely to his unwillingness to take chances with the light axle that had been sent him from New York to replace the broken part.

Coming out of Johnstown, Wednesday morning, Shuttleworth took to the sidewalk to avoid collision with a trolley car at the entrance to the bridge over the Conemaugh, and was not only dragged before a magistrate and fined (the fine was later remitted) but so weakened his right front wheel that it collapsed at Armagh, ten miles farther on. It looked so much like a "down-and-out" proposition that Observer Skinner abandoned

the outfit and went to Pittsburg in a Pullman (P. R. R.). But Shuttleworth and Rose, his mechanic, were not to be denied; they found a blacksmith, who, under their instructions, fashioned spokes out of rough hardwood with a saw, hatchet and shave-knife, and in eight hours had put a new wheel together. At 1 o'clock they were en route, and ran into the Smoky City while the rest were eating breakfast. They snatched three hours' sleep and started after the others, reaching Lewistown in a downpour at midnight, having lost the road several times because all of the confetti had been washed away. Even the last day was not without its mishap. Getting away from Lewistown about half an hour behind the bunch, the narrows below that town took an hour and a half to negotiate, so bad was the road. The rough going developed a six-inch wobble in the front wheel, and Shuttleworth and Rose spent nearly an hour filing the axle in order to take up the play. Everything then went well until Downingtown was reached, when, in attempting to change seats with Observer Schell, Shuttleworth fell from the car and was knocked senseless, suffering besides several cuts and bruises. He was fixed up at the country home of Mr. Hardart (entrant of the Elmore which had gone out the previous day), a few miles farther on, and reached Philadelphia about two hours late. The Haynes crew were the happiest in the bunch, and were congratulated on all sides for their plucky performance. They consider the Class C cup, which they won by virtue of being the only entrant, a sufficient recompense.

The Palmer & Singer troubles were almost entirely due to spring trouble, which began the first day and persisted to the end, finally causing the withdrawal of the car at Harrisburg. This is the same car and driver—William Wallace, Jr.—that made such a good showing in the Fairmount Park 200-mile stock chassis race last October. Ten miles outside of Pittsburg, Wallace discovered that the steering post was broken. They were just approaching a hairpin turn leading down the steep hill into Wilmerding, but Wallace discovered the defect in time to jam on the emergency and stop the car just at the turn. An instant's hesitation on his part and the whole outfit would have shot over the fifty-foot declivity. The car was finally worked down to the foot of the hill, where, after a wait of three hours for help from the Smoky City, Wallace and Ralph, his mechanic, became tired of the delay and rigged up a "first aid" substitute steering device, which got them into town at about 4 o'clock, nearly five hours late. Sitting astride the hood, Ralph pushed on the reach rod, and Wallace, by means of a piece of clothesline attached to the front axle and with a screw driver for a handle, guided the car the remaining ten miles to the Banker Brothers garage. Next morning they put in a new steering-post, and were delayed so long that the heavy rain, which began about midday, took out a small bridge over a run,



Carris and Franklin Six.

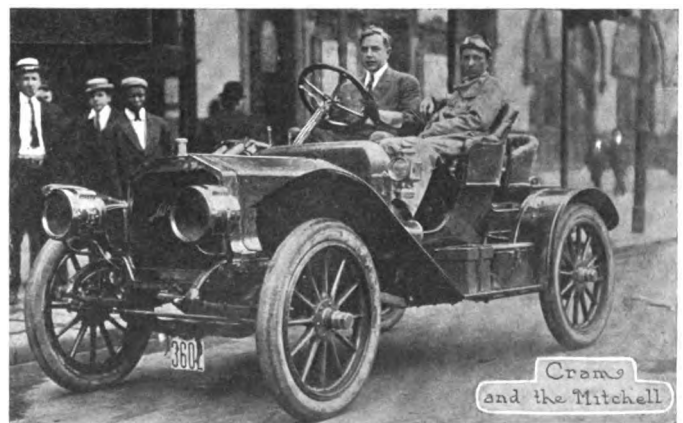

Cram and the Mitchell.

which had been passed by the others hours before. In half an hour, with the aid of lumber from a nearby farmyard, they built a substitute bridge, and reported at Lewistown about 8 o'clock, only to be finally eliminated on the last day by inability to replace their broken springs. They finally limped into Harrisburg about sundown, too late to push on to the finish.

Young Frank Hardart, Jr., the only amateur driver in the run, had the sympathy of all hands when his car was rendered hors de combat only eight miles from the fourth day's control by an accident. The Elmore, which had an absolutely clean road score up to the point where the accident occurred, was well ahead of its schedule and was bowling along the good State road, which extended all the way to Lewistown, when, in attempting to pass a team whose driver refused to give him half the road, the rear of the car swung into one of the concrete culvert headings which line the road and tore the rear springs loose from the axle and damaged the right rear wheel. It was beyond the ability of Hardart and his younger brother, who acted as his mechanic, to fix up the car in order to reach Lewistown, and it was dragged into a nearby barn. A passing auto carried the party into night control, and they left for home on the 8 o'clock train, a sadly disappointed party.

Carris, as usual, failed to get into the limelight. He is so careful and conservative, and withal so speedy when the conditions favor, that he had not a particle of trouble on the road. The Franklin came into Philadelphia without a mark on the observer's cards for the whole five days, and although the technical committee's examination developed 21.2 points penalties against the Franklin, that total is decidedly small when the conditions of the strenuous 750-mile journey are taken into consideration. On the fourth day, in the midst of a driving downpour, Carris ran past a turn, it being absolutely impossible for his younger brother, who was keeping tabs on the "dope book" to see the print. Four miles farther on he discovered his mistake and ran back. It was then that the usually conservative Carris took a chance and "beat it" to such purpose that he made up his lost time and pulled into Lewistown a few minutes ahead of schedule. Even this racking had no deleterious effect.

Cram's experience with his Mitchell was almost identical with that of Carris, and apart from a 3.2 penalty for replacing a defective spark-plug, his road work was faultless. Naturally, the heavy going told more heavily against his little Mitchell than against the big Franklin, but he had to punish his car to reach the night control on almost every leg of the journey.

There was no press car on the run, THE AUTOMOBILE representative securing an observer's appointment in order to keep

tabs on the doings. It was a coincidence that on the only days that the Haynes reached a night control before sundown, THE AUTOMOBILE man occupied the observer's seat.

Pilot and acting referee "Doc" Overpeck did the bulk of the driving on the pilot car, Norman Stadiger's Chalmers-Detroit, and with the exception of the first day, when a troublesome clutch delayed the "spaghetti" car so persistently that Overpeck had to transfer his flag to one of the contesting machines, the Chalmers-Detroit performed splendidly throughout the run.

The Quaker City Motor Club carried out the run with the same attention to detail as if there had been thirty instead of five cars on the road, and the loss of upward of \$1,000 was borne without a murmur. Lack of cars was the only trouble.

The following schedule shows the distances, times and running schedule for each of the five days of the run. On only one day, Wednesday, was it found advisable to adhere to the previously decided upon 20 miles an hour running time. On all of the other days the 18-mile schedule prevailed.

Day	Route	M. P. H.	Dist.	Total Running Dist.	Time
Monday	Philadelphia to Williamsport	18	191.2 1-2	191.2 1-2	10:39
Tuesday	Williamsport to Johnstown	18	146.2 1-2	337.5	8:08
Wednesday	Johnstown to Pittsburg	20	74.7	412.2	3:45
Thursday	Pittsburg to Lewistown	18	170.9	583.1	9:30
Friday	Lewistown to Philadelphia	18	167.4	750.5	9:20

CLASS A, TOURING CARS OVER \$2,000

No.	Car	H.P.	Driver	Time	Penalties Work	Tech.	Total
13	Franklin	42	C. S. Carris	0	0	21.2	21.2
5	Elmore	35	F. Hardart, Jr.	out	4th day	—	1000.
1	Palmer & Singer	60	W. Wallace, Jr.	out	5th day	—	1021.6

CLASS C, RUNABOUTS OVER \$2,000

4	Haynes	45	Shuttleworth	2543	115.2	67.	2725.2
---	--------	----	--------------	------	-------	-----	--------

CLASS D, RUNABOUTS, \$2,000 OR LESS

6	Mitchell	20	Cram	0	3.2	342.9	346.1
---	----------	----	------	---	-----	-------	-------

DETAILS OF TECHNICAL PENALTIES

- Franklin**—Loose grease cup, 2; loose muffler, 5; 2 lost body bolts, 1.2; loose body bolt, 1; 6 loose chassis bolts, 1.2; 5 loose push rod bearings, 2.5; loose boot on driving shaft, .2; broken brake support, 3; loose steering connection, 15—total 21.2.
- Haynes**—Leaky radiator, 3; 2 broken spring leaves, 6; loose spring clip, .2; 2 broken chassis bolts, 2; 2 loose chassis bolts, .4; bent axle, 25; 2 missing screws from commutator shaft, .4; 2 loose steering connections, 30—total, 67.
- Mitchell**—Broken oil lead, 5.2; loose radiator, 3; 3 leaky water connections, 3; broken spring leaf, 3; broken spring clip, 2; loose muffler, .5; lost body bolt, .6; 9 broken chassis bolts, 9; 6 loose chassis bolts, 1.2; 2 leaky gasoline pet cock connections, .2; leak in gasoline tank, 10; 4 broken and worn-out bearings on front wheels, 200; loose cross member frame, 50; loose dash steering housing and broken bracket, 25; loose ignition connection, .3; 2 loose steering connections, 30—total, 342.9.

Elmore and Palmer & Singer not examined by technical committee.

THE AUTOMOBILE CALENDAR

Shows, Meetings, Etc.

- Aug. 5-7.....Chicago, Midsummer Meeting Society of Automobile Engineers.
- Nov. 6-13.....Atlanta, Ga., Auditorium-Armory, National Automobile Show.
- Dec. 31-Jan. 7....New York City, Grand Central Palace, Decennial International Automobile Show: American Motor Car Manufacturers' Association, with Importers Automobile Salon and Motor and Accessory Manufacturers. Alfred Reeves, General Manager, 505 Fifth Avenue, New York.
- Jan. 8-15.....New York City, Madison Square Garden, Tenth National Show, Association of Licensed Automobile Manufacturers.
- Feb. 5-12.....Chicago, Coliseum, Ninth Annual Automobile Show, National Association of Automobile Manufacturers. S. A. Miles, General Manager.

Races, Hill Climbs, Etc.

- June 21-26.....Binghamton, N. Y., Fourth Annual Endurance Run, Binghamton Automobile Club.
- June 22-28.....Albany, N. Y., Fifth Annual Tour, Bretton Woods, Portsmouth, Boston, Albany Automobile Club.

- June 24-26.....Montreal, Blue Bonnets Track, Race Meet. R. M. Jaffray, Manager.
- June 25-26.....Philadelphia, 24-Hour Track Race, Quaker City Motor Club.
- June 26.....Cincinnati, O., Hill Climb, Cincinnati Automobile Club.
- July 3 and 5.....Wildwood, N. J., Straightaway Races, Motor Club of Wildwood.
- July 4.....Los Angeles, Cal., Southern California Automobile Dealers' Association. Road races, 250 Miles for Large Cars; 150 Miles for Light Cars.
- July 12.....Detroit, Start of Sixth Annual A. A. A. Tour for Glidden Trophy.
- Aug. 5.....Chicago, Fourth Annual Algonquin Hill Climb, Chicago Motor Club.
- Sept. 6-11.....Lowell, Mass., Automobile Carnival, Lowell Automobile Club.
- Sept. 15.....Denver, Col., Start of Flag to Flag Endurance Run to Mexico City.
- Oct. 7.....Philadelphia, Second Annual Stock Chassis, 200-mile Race, Fairmount Park, Quaker City, M. C.
- Dec. 29-30.....Philadelphia, Fourth Annual Midwinter Endurance Contest, Quaker City Motor Club.

LONG ISLAND HAS A MOTOR HUNT

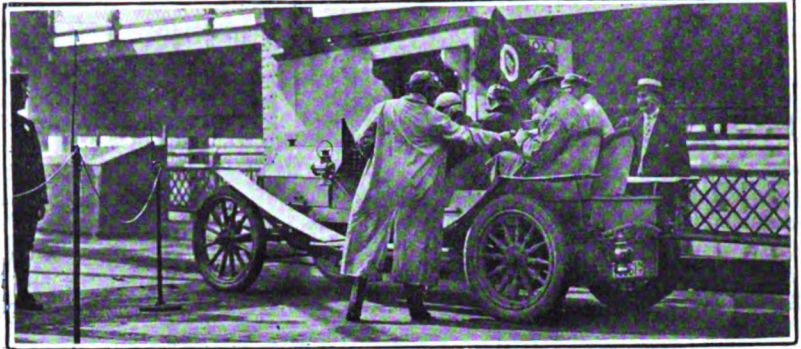

Manager Pardington Instructs a Contestant.

NEW YORK, June 21—Most unique in its idea and more or less aimless in its procedure was the "motor hunt" held on Thursday in connection with the celebration of the opening of the Queensboro bridge. For an entire day, twelve hours, about twenty-five automobiles scurried around the western end of Long Island in a search for blind controls where they might secure marks entitling them to some really valuable prizes. The plan of the event called for a hunt for these stations and for a "quarry" car, and the autoist whose card was punched the greatest number of times at the former, or who met the latter most often, was to be declared the winner. There was a tie. Charles W. Landers, in a Chalmers-Detroit Thirty, and William Allen Kissam, in a six-cylinder Ford, were deadlocked when the cars were examined in the evening, and in addition Mr. Landers won quarry prize by meeting the elusive auto the largest number of times. Mrs. J. N. Cuneo was one of the contestants and will probably get third or fourth place. Some method will be arranged by which the tie for the two trophies, both bronze statues, one valued at \$250 and the other at \$100, will be decided.

The interest among the participants was such that the machines were kept at work throughout the dozen hours, hunting up real estate offices, hotels, and other certain places, such as garages, where it had been announced the controls would be found, and indicated by a flag. Secrecy had been maintained successfully as to the location of the stations so that little or no hold could be secured by the contestants, and the quarry car kept so well away from the others that the score of the winner, even, was low.



At an "Automobile Blue Book" Station in Jamaica.

THAT BRIARCLIFF RACE ROAD DEPOSIT

NEW YORK, June 21—An interesting echo of the Briarcliff race has been heard in the decision of Justice Truax, of the Supreme Court, in regard to the money paid to State Engineer Skene, for possible damage to the roads in Westchester county over which the contest was held. Two days before the race, which was run on April 24, 1908, the State official demanded \$4,600, as a guarantee against possible injury to the highways and expense to the State of repairing them, threatening to stop the race unless the money was paid. According to the Court, Skene had no legal right to make this demand and therefore must return the full amount, instead of but \$582.14, thus bringing up the case. Robert Lee Morrell, the plaintiff, had paid the money to Skene.

The decision is based upon the State laws which allow any locality to give over its road for a special race, imposing such conditions as are necessary, but in the case of the Briarcliff there were no conditions made by the officials who gave the permission. There is nothing in the automobile law which makes it necessary to obtain the consent of the State engineer, and the only law under which the latter could have acted is that providing for the improvement and protection of highways, for the disobedience of which a fine of not less than \$10, nor more than \$100 may be imposed. Therefore it was decided that Engineer Skene might have sued for the penalty, but not the damages. Inasmuch as he had no power to recover the amount of the damages, he had no authority to exact a deposit.



Krug's Corner, Famed in Vanderbilt Race Lore.



One of the Blind Checking Stations.

COMPLETING PLANS FOR GLIDDEN TOUR

DETROIT, June 21—There will be "something doing" every minute, from the time the first of the Glidden entrants reaches Detroit until the last car has started out Michigan Avenue on the journey which will end at Kansas City some three weeks later. Local committees having the entertainment of tourists and visitors in charge are planning doings that will leave pleasant memories in the minds of all, for all time, and nothing will be left undone to make those who visit Detroit realize that the hub of the automobile world fully appreciates what such an event as the Glidden tour means. Quick to grasp the import of the occasion, the city, at the suggestion of Mayor Breitmeyer, donated a beautiful trophy, to be awarded the successful contestant in the baby tonneau class, thereby adding to the interest of the event. It has also been officially decreed that motorists will own Detroit from the moment the first of the tourists arrive until it is all over. "Glidden Tour Days" is the title bestowed on

run up the river across Lake St. Clair, through the St. Clair Flats, the "Venice of America," and back to Detroit, reaching the city early in the evening.

Monday morning, July 12, at 9 o'clock, the Glidden tour will start from in front of the city hall with due éclat. The Maxwell band of the Maxwell-Briscoe Company will be on hand to provide music, and local motorists will be out in force to give the tourists a fitting send-off. Business will be intermingled with pleasure, although neither will be allowed to conflict with the other. The A. L. A. M., the A. M. C. M. A., and the A. A. A. officials will sandwich their annual meetings in between the festivities, which will make it a moderately busy season for all concerned. These gatherings will bring to Detroit practically every prominent automobile manufacturer in the country, and the local committee is bending every energy toward showing the visitors that Detroit is not only the center of a great and growing industry, but that it appreciates what their presence stands for.

Headquarters have been opened by the local committee at the Hotel Fuller, and from now on the pot will be boiling.

The 1909 Hower trophy for runabouts is now being exhibited in the window of an automobile dealer on Broadway, New York. As this trophy is a permanent possession, an entirely new one is put up every season. Last year the trophy was a plaque, handsomely mounted. This year it is a silver loving cup, having three handles and an inscription on each panel between the handles.

Numbers Assigned to Tour Entrants

BUFFALO, N. Y., June 21—Numbers have been allotted to the cars which have entered for the sixth annual tour of the American Automobile Association, and the cars have been sorted into groups according to the trophy for which they will compete. They are as follows:

FOR THE GLIDDEN TROPHY

No. 1 Premier	No. 12 Pierce-Arrow
No. 2 Premier	No. 14 Pierce-Arrow
No. 3 Chalmers-Detroit	No. 15 Glide
No. 4 Marmon	No. 16 Thomas
No. 5 Marmon	No. 17 Midland
No. 6 E-M-F	No. 18 Lexington
No. 7 E-M-F	No. 19 Stoddard-Dayton
No. 8 Maxwell	No. 20 Stoddard-Dayton
No. 9 Maxwell	No. 21 Stoddard-Dayton
No. 10 Maxwell	No. 22 White
No. 11 Jewel	

FOR THE HOWER TROPHY

No. 100 Moline	No. 107 Maxwell
No. 101 Moline	No. 108 Pierce-Arrow
No. 102 Moline	No. 109 Pierce-Arrow
No. 103 Brush	No. 110 McIntyre
No. 104 Brush	No. 111 Stoddard-Dayton
No. 105 Chalmers-Detroit	No. 112 Jewel
No. 106 Hupmobile	No. 114 Mason

FOR THE DETROIT TROPHY

No. 51 American Simplex	No. 53 Premier
No. 52 Chalmers-Detroit	

NON-CONTESTANTS

No. 75 Rapid Truck	No. 77 Diamond Rubber Company
No. 76 "The Automobile" and "Motor Age"	

OFFICIAL CARS

No. 98 Pilot, E-M-F	No. 99 Chairman, Premier
---------------------	--------------------------



Trophy for Runabouts Offered by Chairman Hower

July 9 to 12 by the local committee appointed by the Detroit Automobile Dealers' Association to arrange for the entertainment of A. A. A. officials, entrants, automobile manufacturers, and others who will be here during that period, and "rare old Glidden tour days" they will be.

Friday evening, July 9, will witness the formal opening of festivities with a banquet for A. A. A. officials and newspapermen, at which Mayor Breitmeyer will turn the keys of the city over to Chairman T. B. Hower, of the committee. Saturday morning the visitors will inspect the local auto plants, starting from the Hotel Pontchartrain. Automobiles will be provided for all and a new understanding of Detroit's position in the industry is bound to follow. Saturday afternoon comes the automobile parade, the big feature of the three days' celebration, which promises to be one of the greatest ever. Not only Detroit motorists, but those from surrounding towns will participate, and prizes will be awarded for the best decorated machines in four divisions—gasoline, electric, commercial, and motorcycle. The parade will start downtown and end at Belle Isle, where there will be an athletic carnival participated in by employes of local automobile factories, with a long list of prizes.

Sunday morning the visitors will board the City of Cleveland, the finest sidewheel passenger steamer in the world, chartered for the occasion by the D. A. D. A., and will be afforded a glimpse of Detroit's water facilities. The boat will proceed down the river, past the world-famous Limekiln Crossing, Bois Blanc, Sugar Island, and other down-river resorts, to Lake Erie; then

Indians Now Buying Autos—"Lo! the poor Indian" is a forgotten phrase on the Cheyenne River Indian reservation, for the redskins, just to show that they are not poor, as well as to enjoy the pleasures of touring, are investing in automobiles, according to reports from Pierre, South Dakota. The camera and the typewriter are also gaining general use among the redskins.

What the Clubs Are Doing These Days

BALTIMORE HAS ITS "BIGGEST" SUCCESS

BALTIMORE, June 21—Orphans' Day in this city, last Wednesday—a week later than scheduled time—proved a "biggest" success. It required 180 cars, donated by members of the Automobile Club of Maryland and other owners, to take the more than 900 little ones on their annual tour over the best streets of the city, and then to Electric Park, where they were the guests of honor on the shoot-the-chutes, carousel and other attractions until supper time. A substantial meal was then served. The committee of the club in charge, under Chairman E. A. Dolle, had made splendid arrangements, and the result was the most enjoyable of the several outings.

At noon the cars gathered in front of the clubhouse on Mount Royal avenue, and were divided into 16 divisions, each with a marshal, and dispatched to 15 different institutions, to get their happy guests. They returned and at two o'clock started in single file on a parade, amid the yells and whistles of the boys and girls. After covering several blocks of city streets they entered Druid Hill Park, and were reviewed at the Wallace Monument by Mayor Mahool, who was in a six-cylinder Oldsmobile driven by E. L. Leinbach, manager of the Olds branch. Chairman Dolle's committee was composed of: Frank W. Darling, C. Howard Milliken, Joseph M. Zamoiski and Emmanuel Daniel. Mr. Milliken was also chief marshal.

WHEELING ORPHANS HAVE RIDE AND PICNIC

WHEELING, W. VA., June 21—An automobile ride and a picnic featured the local observance of the national orphans' outing on Wednesday. Under the auspices of the Ohio Valley Automobile Club a great many automobiles were secured and gathered on that morning at 10 o'clock. The children were then brought from the various institutions and led by Mayor Schmidt in his car, were taken on a parade over the city streets. After this the cars were driven to Blayney's Grove for a picnic through the afternoon, and the return was made in the evening.

GRAND RAPIDS ORPHANS OPEN CLUB HOUSE

GRAND RAPIDS, MICH., June 21—The third annual Orphans' Day celebration of the local automobile club was combined with the formal opening of the new club house at Cascade Springs on Wednesday. It was the most successful from the point of numbers and enjoyment to the waifs of the city that has yet been held. Although a dearth of cars was expected 70 cars, 20 more than were needed, reported in the morning ready to carry the 200 homeless youngsters to Cascade Springs for their holiday, where they were cared for and feasted by their nurses and members of the club.

A NEW CLUB IN JERSEY—AT PLAINFIELD

PLAINFIELD, N. J., June 21—With nineteen charter members the Plainfield Automobile Club has been formed, and steps will be taken to include in the membership all automobilists in this city and neighborhood. The following officers were selected: President, Dr. F. C. Ard; vice-president, Harry W. Marshall; treasurer, F. O. Ball; secretary, J. H. Rankin.

ALTOONA AUTOISTS FORM AN ORGANIZATION

ALTOONA, PA., June 21—To promote better streets and county roads, owners of automobiles in this city have formed the Altoona Motor Club with the following officers: President, W. L. Hicks; secretary, E. J. Lomnitz; treasurer, W. W. Blake. An active campaign is being outlined and it is planned to join the A. A. A.

JOY FOR THOUSAND ST. LOUIS ORPHANS

St. LOUIS, June 21—Fourth annual Orphans' Day was celebrated by the Automobile Club of St. Louis by giving 1,000 children a six-hours entertainment. Twelve institutions furnished the quota, of which a careful estimate was made, and in spite of an over-cast sky, and forebodings of a rain that did not occur, the youngsters had a merry time. Each one was provided with an American flag and the privilege of using the voice as loud and long as desired. Members of the club donated cars which were used from 9 a. m. to 3 p. m. and the occupants taken for a long ride. Alden H. Little was grand marshal and he provided each chauffeur with a printed form which may be of value to some other club next year. It read: "Do not exceed the speed limit. Mr. ———'s car. Go at once to ———, located at ———. Take as many children as you safely can and be sure a responsible



Delegation of St. Louis Orphans Ready to Start

attendant accompanies you. Give the children a ride of not more than ——— hours, and report back to the same place for the next load. In case of trouble which cannot be fixed in 30 minutes, telephone A. H. Little at once, number ———. Please drive with greatest care as the children are not accustomed to automobiles." About fifty machines were used, and some took several loads of youngsters out during the course of the day.

GALVESTON ENTERTAINS ORPHANS WITH A RIDE

GALVESTON, TEX., June 18—Orphans of the various charitable institutions were given their second annual outing by the Galveston Automobile Club on June 8, nearly 200 children being given a long ride by the 50 automobiles donated, and as much ice cream as they could eat furnished by a club member. The run started from the library on Tremont street, in the heart of the city, after the cars had collected the inmates from the homes, and a line formed in which electric autos took the lead. For an hour and a half the ride was around the city, with flags and horns supplied to the little travelers. Lunch and enough ice cream to satisfy the most ravenous youngster were given by one of the members of the club who is an ice cream manufacturer, after which the ride was resumed and the course laid to the seawall boulevard, up and down which the cars sped to the hearts' content of the occupants, and then returned to the institutions from which they had started. Pleasant features of the event to the club were found in the interest shown throughout the city, and by the fact that with 60 members nearly 50 cars were available, in addition, of course, to the enjoyment furnished.

BOSTON AUTOISTS MAY UNITE IN NEW CLUB

BOSTON, June 21—Another attempt to consolidate the Bay State Automobile Association and the Boston Motor Club is being made, and at a recent meeting of the directors of the two organizations terms for a merger were drafted. These have been submitted to the members for action, and it is expected that it will be favorable, thus uniting the bulk of the local autoists. The Boston Motor Club was organized about six months ago by some members of the Bay State Association and others, who secured a charter and elected officers but never had permanent quarters. In its membership are several prominent members of the trade, while others equally prominent remained in the Bay State. Several attempts to bring about a merger have been made but none of them has had any result.

The terms now proposed include the merging of the Bay State Association and the Motor Club in a third organization to be called the Bay State Motor Club; that members of both organizations who have passed their respective membership committees be admitted to the new club; that joint committees from the two organizations prepare a list of officers and a new set of by-laws, and that the assets of both organizations be placed in the treasury of the new club. The Bay State Association has called a special meeting to act on the matter on Wednesday, June 30. It is thought that the members favor the move.

QUAKERTOWN, PA., AUTOISTS ORGANIZE CLUB

QUAKERTOWN, PA., June 21—So many of the residents of this place and of the surrounding country have purchased automobiles that the owners decided to join hands in order to push good roads and other work in this vicinity. Accordingly the Quakertown Motor Club has been formed with the following officers: President, Fred L. Harley, Quakertown; first vice-president, M. L. Cope, Perkaspie; second vice-president, Dr. W. H. Brown, Richlandtown; third vice-president, C. F. Newcomer, Coopersburg; secretary, Howard R. Moyer, Quakertown; treasurer, Charles Stoneback, Coopersburg; solicitor, Harry E. Grim. A committee on by-laws is composed of: John Freed, Richlandtown; J. Howard Ozias and M. T. Free, Quakertown. The membership committee is: Dr. W. H. Brown, Richlandtown; W. O. Haney, Milford Square; Ralph Stauffer, Coopersburg; Mr. Kulp, Perkaspie. One of the first acts of the club will be to request a re-pairing of the pike leading through Richland and Springfield townships to Coopersburg.

CHATTANOOGA AUTOMOBILE CLUB ORGANIZES

CHATTANOOGA, TENN., June 21—The Chattanooga Automobile Club has taken a new lease on life through reorganization, and a vigorous campaign for good roads and other matters of interest to autoists mapped out will be entered upon at once. The membership in the body will be limited to 150, and these must be private owners living within 50 miles of this city. At the recent meeting it was reported that 60 autoists have joined, and that there are 34 more applicants. The following officers have been elected: President, H. S. Probasco; vice-president, C. F. Milburn; secretary, C. E. Kirkpatrick; treasurer, L. W. Llewellyn; directors, B. F. Thomas, H. W. McCallie, Carl Painter, C. A. Raht, R. L. Williams.

KENTON, O., AUTOISTS WOULD BUILD PIKE

KENTON, O., June 21—The Kenton Automobile Club, which has a membership of more than 50 of the leading business men of this city, has made a unique offer to the county commissioners. The club asks permission to select a pike in Hardin county and improve it under the direction and at the expense of the club members, who wish to take a stretch of four miles of pike and entirely reconstruct it, making it a model highway. The club also asks the commissioners to place guide posts at every road crossing in the county, and has sent to Toledo and Columbus for copies of the traffic ordinance with a view of enacting a similar one here.

WARREN COUNTY, N. J., GETS A CLUB

WASHINGTON, N. J., June 21—Automobilists of this city and the surrounding country, more than 90 of them and all owners of cars, on last Wednesday evening met here and organized the Warren County Automobile Club. The members were addressed by F. H. Elliott, of New York, secretary of the American Automobile Association, with which the new body will be affiliated; and by W. C. Crosby, president of the New Jersey Automobile and Motor Club and also president of the Associated Automobile Clubs of New Jersey. The following officers were elected: President, D. M. Perry, Washington; vice-president, R. D. Huff, Hackettstown; secretary, W. H. Rhodes, Phillipsburg; treasurer, J. R. Bryant, Washington. Five directors were chosen, as follows: W. D. Gulick, Washington; J. R. Stires, Penwell; A. Blair Kelsey, Belvidere; Matthew Suttle, Phillipsburg; Dr. L. C. Osmun, Hackettstown. Dr. C. B. Smith, Washington, was elected as a director to the A. A. A., and Dr. W. C. Albertson, to a similar office in the Associated Clubs.

SAVANNAH CLUB TO MARK ROADS

SAVANNAH, GA., June 21—All good roads will lead to Savannah in a few months; at least this is what the Southern traveler will think after the Savannah Automobile Club has carried out plans which have been formulated by Secretary A. W. Solomon. Mr. Solomon has ordered a large number of steel signs, in shape and color like the Savannah automobile pennant. The red-and-white sign telling the mileage to Savannah will soon be a familiar landmark on every road leading to that city, accessible to motorists. The indicators will be distributed through a territory within a radius of forty or fifty miles, with Savannah as the starting point. Autoists from the North, traversing these roads, will be given a taste of Savannah enterprise long before their arrival here.

BOULDER, COL., NOW HAS A CLUB

BOULDER, COL., June 21—Boulder Motor Club has been organized by the enthusiastic automobilists of this place, about 25 in number, and the following officers have been chosen: President, O. J. Watrous; secretary, C. L. Bennett. The committee on by-laws is composed of Dr. W. Scott, L. B. Overfelt and Louis Herman; and the committee on membership includes O. N. Gilbert, G. W. Blackburn and Ernest Grill. An invitation has been extended to the officers of the Denver Motor Club to meet with the local body to arrange a plan to secure better roads between this city and Denver. Similar work will be undertaken with other automobile organizations in the vicinity in order to have improved highways leading in all directions, especially into the mountains and to the North, toward Cheyenne and other Wyoming points.

HAMILTON, O., AUTOMOBILE CLUB IS FORMED

HAMILTON, O., June 21—With a charter membership of 50 owners of autos, the Hamilton Automobile Club was formed recently in this city. The officers of the old automobile club were adopted as the temporary organization of the new one, as follows: President, C. E. Hemp; secretary, Mark Sohngen; treasurer, Dr. F. M. Barden. It was decided to begin an active campaign for increased membership, and committees were appointed on constitution and by-laws, and on membership.

VICKSBURG, MISS., AUTOISTS ORGANIZE

VICKSBURG, MISS., June 21—Enthusiastic autoists of this city, in order to work together to obtain improved roads and other conditions, have formed the Vicksburg Automobile Club, and have chosen the following officers: President, Dr. R. A. Quin; vice-president, W. L. Nicholson; secretary, Lee Richardson; treasurer, J. J. Lum; directors, Dr. W. H. Penn, J. H. Hempen, P. S. Craig, A. A. Kuhn, G. L. Ryan, W. N. Dupree, J. W. Hayes, Jr., M. Kaufman, T. J. Hays, F. J. Fisher.

GOVERNOR VETOES NEW WISCONSIN LAW

MILWAUKEE, WIS., June 21—Governor Davidson has vetoed the Page bill, a statute to regulate automobiles, which had been passed by the Senate without a speed clause and amended by the House to have eighteen miles an hour in cities and twenty-five in the open country. The veto says in part: "My objection is based upon two propositions, the first of which is that it permits automobiles to be run at a rate of speed not to exceed eighteen miles per hour within the corporate limits of any city or village. . . . The laws of Wisconsin limit the speed of railroad trains running on a defined track, on schedule time, to twelve miles per hour in entering or passing through cities or villages. . . . A speed of eighteen miles per hour means that the vehicle may pass along populous streets twenty-six feet at every tick of the watch. This . . . is highly improper and dangerous." The other objection is that the section relating to penalty refers to sections of a statute previously passed instead of to the entire law, which would make convictions impossible, he says.

This action came as a surprise to those interested in the affair, for it was known that the Legislature was favorable by its actions and the clubs and State association were satisfied, but the Governor threw it out by his veto and sent it back to the Legislature a few minutes before the time set for final adjournment, obviating any chance of passage over the veto. The Owen-Chinnock bill, increasing the registration to \$2 and requiring motorcyclists to pay, was signed, and all owners must re-register before October 1. When a car is sold the certificate and license tags have to be returned to the Secretary of State.

MARYLAND LAW RESTS IN DEADLOCK

BALTIMORE, June 21—At a recent conference of a committee from the Automobile Club of Maryland, with Osborne I. Yellott as spokesman, and the State automobile commission, it was impossible for the two sides to get together on the tax and license feature of the bill prepared by Colonel Sherlock Swann, a member of the commission, so that it will be necessary for the next Legislature to settle the differences. The commission held out in favor of the rates fixed some time ago, as follows: Under 20-horsepower, \$6; over 20 and including 30-horsepower, \$9; over 30 and including 40-horsepower, \$18; over 40-horsepower, \$24. The commission would have manufacturers and dealers' licenses arranged on a basis of annual business to \$10,000, \$25; between \$10,000 and \$25,000, \$50; between \$25,000 and \$50,000, \$100.

The autoists, according to Secretary Darling, of the Automobile Club, want the license arranged in this manner: Up to and including 20-horsepower, \$6; over 20 and including 30-horsepower, \$9; over 30 and including 40-horsepower, \$12; over 40-horsepower, \$15, provided that a wheel tax is imposed on all other vehicles within the State at the rate of 25 cents per wheel for one-horse pleasure vehicles; 50 cents a wheel for two-horse vehicles, and \$1 per wheel for four or more-horse teams; with the further provision that such vehicles shall be required to have lights at night. This wheel-tax feature does not meet with the approval of the auto commission.

FOR ONE YEAR'S AUTO WASHING, \$1.20

DETROIT, June 21—Hereafter owners of automobiles will have to pay \$1.20 yearly for the water used in washing them. The reason is that the water board needs more money. The horse has been taxed for what it drank. Every truckman has had to pay for the privilege of bathing his vehicle. But to date the automobile has been immune. Now the buzz buggy has been promoted to the same rank as other vehicles. Whether it will appreciate the honor conferred is a question. At all events, it is anticipated that the man able to maintain a machine will manage somehow to scrape up the \$1.20 levy imposed by the water commissioners.

Present indications are that ultimately some sort of a compromise may be effected, but the outlook just now is quite indefinite.

SOME OHIO REGISTRATION STATISTICS

COLUMBUS, O., June 21—The report of the State register of automobiles for the year ending June 10 is interesting as indicating the trend of the industry and the number of automobiles registered in the first fiscal year of the present law. During the twelvemonth there was 17,192 autos registered in Ohio, which produced a revenue of \$82,406; manufacturers and dealers numbered 366, and the income from them was \$3,660; there were 784 certified copies issued, totaling \$1,568; altogether 2,741 chauffeurs took out licenses, valued at \$5,482, and duplicate tags were issued to the number of 154. Owners' renewals numbered 226, producing \$1,534, and the total revenue to the department was \$94,835.

Amendments have slightly changed the law, for by the enactments of the last session of the general assembly, all licenses expire on December 31, instead of one year from the date of issuance. Renewal blanks are now being sent 10 days before the expiration of the license, and the renewals, as well as all new licenses, are for the remainder of the calendar year.

CONNECTICUT LAW LARGELY AMENDED

HARTFORD, CONN., June 21—If ever a proposed law was riddled to a record-breaking degree, it was the statute to regulate automobiles in this State, which received thirty-three amendments on Wednesday in the House, not all of which were carried, but a goodly number left their imprint upon the Senate measure. Matters of speed, licensing, and age of the operators were given most serious consideration. It was decided that no one under 18 years of age should be allowed to drive, changing the text from 16, and it was advised that an operator who has his license revoked could not secure another one for two years, instead of six months. The speed maximum stands at 25 miles per hour, with that in congested quarters amended to 10, and in passing trolley cars which are receiving or discharging passengers 3 miles per hour. The clause requiring that an auto be timed over an eighth of a mile to show its speed remains, and a fine of from \$100 to \$500 or a sentence of from six months to one year in jail, or both, be applicable when a car injures someone and the driver tries to run away.

OHIO LAW GRATIFIES SECRETARY OF STATE

COLUMBUS, O., June 21—Secretary of State Carmi H. Thompson of Ohio has issued a statement in which he shows the benefits of the Ohio automobile law, which, he claims, has been good for the people and motorists generally. The statement follows: "I believe that the Ohio automobile law, which is comparatively new, having been in force only one year, is as well observed and as well enforced as in any other State, and that the records will show a far less percentage of arrests for non-compliance than in any other State. A great amount of the credit for the rigid enforcement of the statute is due the Columbus, Cleveland, and Cincinnati automobile clubs, all of which are affiliated with the American Automobile Association, and whose work has been in cooperation with the work of this department."

PRO-RATE FEES ACCORDING TO AUTOISTS

COLUMBUS, O., June 19—The bill of Representative Ritter increasing the registration fees for all automobiles in Ohio will not be the only auto bills before the next session of the General Assembly. Senator Cretone of Dayton will again introduce the bill under consideration last session which provides that the fees received from the registration of autos should be pro-rated among the counties of the state in proportion to the number of owners of automobiles in each county. He believes that counties which have none or few automobiles should not receive the same amount of money for their road funds as counties having thousands of cars. While many are of the same belief, they predict impossible difficulties in enforcing such a law.



Why Night Driving Lost Its Terrors for Autolists

NIGHT PHOTOGRAPH FROM THE EARLY DAY

THAT taking photographs of roadside scenes by night is not a recent practice is shown by the accompanying picture taken some years ago, and contributed by Gray & Davis, of Amesbury, Mass. This was taken by Louis Derr, of the Massachusetts Institute of Technology, using two Gray & Davis Bullet lamps, on a Locomobile steam car, and in describing the photograph, Mr. Derr then wrote: "The two bright spots and the smaller one between them, surrounded by circles, are the images of distant Welsbach street lights, the nearest being about 125 feet away, and the two brightest ones being on opposite sides of the street. The very faint spots near the middle of the picture are lights in a house."

"You will notice that the path of light from the car lamps extends up to the street lights, which themselves are not bright enough to light up the roadway sufficiently to show on the print. This gives a basis of comparison of brightness. The picture is not faked in any way."

REGAL 1910 CAR TO CROSS COUNTRY

BUFFALO, June 21—A pleasant little reunion took place in Buffalo on Saturday as an echo of the trip made by the Regal "Snowball Limited" early this spring. Those attending were Mr. and Mrs. Bert Lambert and Mr. and Mrs. Fred. W. Haines, of the Regal Motor Car Co., of Detroit; Mr. and Mrs. Pickard, Mr. and Mrs. Penfield and Mr. Sherman, of the Salisbury Wheel & Manufacturing Company, of Jamestown, N. Y.; Mr. and Mrs. Covert, of the Covert Motor Vehicle Company, of Lockport, N. Y.; R. Harry Croninger, of the Pennsylvania Auto Motor Works, and George D. Wilcox, of the Regal Sales Company, of Syracuse. Mr. Wilcox was the pilot of the "Snowball" on its mid-winter run.

A banquet was served at the Lafayette Hotel, after which the entire party were entertained at the theatre. Announcement was made at this gathering of the proposed trip of the Regal 1910 model, from New York to San Francisco, to leave on July 4. Mr. Wilcox will pilot the car and it will be driven by "Snowball Bill" Smith of the Regal factory. The gathering broke up with the best wishes from all for the success of the proposed trip. The car will be equipped with Empire tires and will carry four passengers.

MAXWELL-BRISCOE BUYS ANOTHER FACTORY

PAWTUCKET, R. I., June 21—The Maxwell-Briscoe Motor Car Company will shortly move from the plant which it has occupied in this place for four years to Auburn, R. I., where it has purchased the works of the Auburn Rubber Boot and Shoe Company. This factory was secured for \$200,000 and is being remodeled so that the capacity will be twice as many automobiles as the present situation affords. The output at present is 2,000, employing about three hundred men, but at Auburn it is estimated by the factory officials, fully 4,000 four-cylinder cars will be built annually. The Maxwell output for 1910 will exceed 22,000 cars.

PREDICTS 1910 WILL BE MAGNETO YEAR

"Nineteen hundred and ten will be noted as a magneto year in the motor car calendar," says J. S. Bretz, president of the J. S. Bretz Company, importers of the Unterberg & Helme high tension magnetos. "Not but what magnetos have been largely used heretofore, but because the magneto will come into its own next year, and by this I mean the undisputed possession of the ignition field."

"Next year magnetos will be furnished as the integral part of a complete car, and not offered as an extra, or an option at an additional price, which sometimes means, in the hands of dealers, an increase of price way beyond the original cost of the magneto."

"Abroad nearly all the popular and well-known makes of motor cars are sold with the magneto as the sole source of ignition, up to at least 30-horsepower and hence it is expected that we will not much longer continue, excepting in big motors, which are hard to start, the idea of having a double set of ignition, which means two complete sets of plugs, wiring, etc., or the dual system of ignition, which really means a set and one-half."

"The sole advantage that both the double and dual systems have over the magneto system alone is the added ease of starting on the spark. On the U. & H. magneto, for large and small four and six-cylinder motors, and which we have been building for some years, we have added three important, well tried out improvements, which easily rank them first among high-tension magnetos which use batteries for starting purposes."

"The first of these improvements is the U. & H. interrupter, which is so designed that wear is really abolished, and as it permits of no adjustment, it is permanently set at the factory, hence after that there is no possibility of false adjustment. The second improvement is the locating of the high class battery timer in the magneto, at the end of the distributor shaft, the timer being advanced and retarded with the interrupter. The third, and not least of these improvements, is the construction of the distributor, which is designed with the idea of preventing the insulation being burned by the high tension spark when the engine is started on the battery switch. The distributor segments are set in a floating ring, which follows the spark advance and retard, but when retarded for starting the brush always touches the right segment."

WHAT IS GOING ON AMONG THE GARAGES

Pittsburg, Pa.—The Standard Automobile Company, through its president, W. N. Murray, has secured property in the East End, on which it will construct automobile salesrooms and garages. One lot is at Baum and Beatty streets, 100 feet on the former, 142 feet on the latter, and was purchased for \$30,000. It is said that another lot has been bought by the same concern for about the same price on Baum street, with a frontage of 89 feet and a depth of 119 feet on its longest line, being fan-shaped. These are near several other garages.

Wellington, Kan.—Joe Fetters and Charles Lovingfoss will erect a garage at Eight and Washington streets, 50 by 140 feet in size, with two floors, the lower one to be used as a space for the automobiles, and the upper will be for an auditorium. The building will be constructed of stone.

Anniston, Ala.—Erection of a brick garage on Benson street, between Peoples and Tolly streets, has been commenced by J. S. Fowler. The building will be constructed of brick with a concrete floor and tin roof, 35 by 80 feet in size, and will cost about \$1,000.

Kansas City, Mo.—Permits have been granted for the erection of a garage and warehouse at 1521 and 1523 Grand avenue. The building will have a frontage of 50 feet and a depth of 117 feet, two stories high. The estimated cost is \$22,000.

Clarinda, Ia.—J. B. Eastman has just taken possession of his new automobile garage, which is one of the largest and best equipped in southwestern Iowa. It is 40 by 140 feet in size, with two stories and a basement.



Factory of the Nordyke & Marmon Company, at Indianapolis, Ind.

ENLARGING HOME OF MARMON

INDIANAPOLIS, IND., June 21—Extensive enlargements are now being made in the factory of Nordyke & Marmon Company, Indianapolis, the home of the Marmon car. The Marmon plant is already a very large factory, occupying eleven acres of ground, with a total floor space of 280,000 square feet, and employing 800 to 900 men. Several new buildings have been added in the last few years—two of these are not shown in the accompanying picture. Another building is now to be erected at the extreme rear of the plant, with floor space of 7,500 square feet. This latest addition will house the testing and repair departments, and the space formerly occupied by these departments will be used for enlarging the machine shops and final assembly floors.

In addition to the motor car product, Nordyke & Marmon Co. is also the world's largest manufacturers of flour and cereal mill machinery, the business having been established in 1851. Many parts of the big factory's equipment—such as forge shops, foundries, sheet metal and woodworking departments—are used for all the company's products.

Tires, lamps, gas tanks, Bosch magnetos, Hess-Bright ball bearings and similar equipment for Marmon cars are, of course, purchased outright by the company, but nearly everything else about the car is manufactured in this factory. Aluminum, bronze, brass and iron castings, sheet metal work, bodies, engines, transmissions, axles, steering gears—in short, about everything is manufactured from the raw material. One department is devoted exclusively to the preparation of tools, jigs, patterns, etc., so that the interchangeable parts for almost any piece of machinery ever produced by the company can be duplicated accurately and with promptness.

All the buildings are well ventilated and lighted and contain an elaborate system of overhead and surface tracks. Shipping facilities are unexcelled.

The enlargements now being made and additional equipment being installed will permit a greatly increased output of Marmon "thirty-twos" for 1910.

The 1910 output will be confined exclusively to the "thirty-two" in five-passenger touring car, four-passenger short-coupled car and roadster. Since no changes of consequence over the 1909 will be made, the company will be able to complete the 1910 production early. Deliveries will begin in August.

GENERAL ITEMS OF INTEREST

Few Changes in New Banker Wind Shield—To keep the pace with the automobile manufacturers, the Banker Wind Shield Company has arranged to place its 1910 models upon the market very shortly, and will make early deliveries. George A. Banker has taken up the management, in the place occupied by Arthur L. Banker until recently, and states that the new types will present few changes in design or appearance, the principal one being in a new and improved telescoping rod which is constructed to permit of raising or lowering the glass without the driver's leaving the seat. This feature is obtained by means of an expanding and contracting cone, placed inside the telescoping tube and fitted at the end with a small knurled wheel that tightens or releases the tension as desired. This improvement does away with the nut used heretofore and obviates the necessity of getting out of the car and using the wrench.

Firestone's Record in Trans-Continental—With three cars in the endurance contest from New York to Seattle equipped with the Firestone tires, the Firestone Tire & Rubber Company is keeping close tabs upon their behavior. When the cars started it was noticed that neither of the Fords carried spare shoes, and when this was remarked upon Mr. Ford said: "The car is light enough, and the tires good enough to go through without the use of extra tires." At Denver, H. B. Harper, advertising manager of the Ford company, telegraphed that Ford No. 1 had two and Ford No. 2 had three of the Firestone tires filled with original air. Salzman, in the Acme, reported from Denver with three of the original Firestones in perfect condition, although six pairs of chains had been worn out. From Rawlins, Wyo., he telegraphed that his mileage was 2,674 and the tires still looked like new.

Niagara Power for Franklin Factory—The falls of Niagara, over 150 miles away, are furnishing electric power with which to run the plant in Syracuse, N. Y., in which the Franklin automobiles are made. Niagara power has run the trolley cars and lighted the streets of Syracuse for a year or two, and the H. H. Franklin Mfg. Co. has for some time had available a partial use of cataract power for emergency service. This it has now doubled, making provision sufficiently for its entire factory. This does not mean that the factory will be de-

pendent upon or always use the Niagara electric current. Its own power plant will be used through the winter and most of the year, but in the summer, when power alone, without heating is wanted, the electricity generated at the falls will turn the factory's machinery.

Morgan Truck Waters Dead Horse Hill—In the recent hill climbing contest at Worcester on the Dead Horse Hill it was planned to sprinkle the course between every two events with a 40-horsepower Morgan Trade Motocar, carrying a temporary tank and sprinkling device. The rain, however, had laid the dust so well that it was not needed. Just to show that it was able to do so, if necessary, the big machine covered the entire distance in less than 15 minutes, including stops, the day before the contest. The contest committee of the Worcester Automobile Club decided that the use of one automobile would be better and quicker than eight horses, with one or more tank wagons. In making the climb the Morgan truck had no extra weight on board, but it had no difficulty in keeping traction.

Remarkable Empire Tire Record—The Empire Tire Company, of Trenton, N. J., has found considerable satisfaction in the record of its tires upon cars in recent endurance contests. The latest perfect performance was in the Catskill-Berkshire tour of 350 miles, in which a Thomas taxicab and a Columbia touring car each finished with perfect scores, mechanical and tire. In six different contests, therefore, Empire tires have been used without a single puncture, as follows: Motor Club of Harrisburg, 600 miles, two cars; Norristown Automobile Club, 374 miles, two cars; New Jersey Automobile and Motor Club, 193 miles, one car; Delaware Valley endurance run, 158 miles, nine cars; run-off of Delaware Valley tie, three cars; Catskill-Berkshire tour, two cars.

Locomobile Wins Hill Climb Abroad—It is always gratifying to Americans to learn of instances where American cars beat foreign made machines in competition on the latter's own soil. At the Call d'Aspin Mountain climb in the Pyrenees, France, on June 3, a distance of 93 kilometers, nearly 60 miles, Z. K. Graham of Los Angeles, Cal., who is touring Europe in his Locomobile "40," won a signal victory, beating his nearest competitor by more than 20 minutes. Among the contenders were a Mercedes, two Panhards, a Wolseley, Hotchkiss, Renault and Gladiator. Mr. Graham's car was the only American contender.

"The Q M S Company" a Simplified Name—In order to simplify details in connection with correspondence, telephoning, etc., the Quincy, Manchester, Sargent Company, Plainfield, N. J., has changed its name, and hereafter will operate under the corporate name of the "The Q M S Co." This change has been under consideration for some time, many friends and customers practically demanding it, one great objection to the old name being the inconvenience and time consumed in pronouncing the full name over the telephone, according to factory officials.

KisselKars in Demand—This season's sales of KisselKars, according to the Kissel Motor Car Company, have been so far ahead of the best expectations that additional manufacturing space has become necessary, and some increases have already been made. The selling territory has been greatly expanded, new agencies arranged, and the factory has

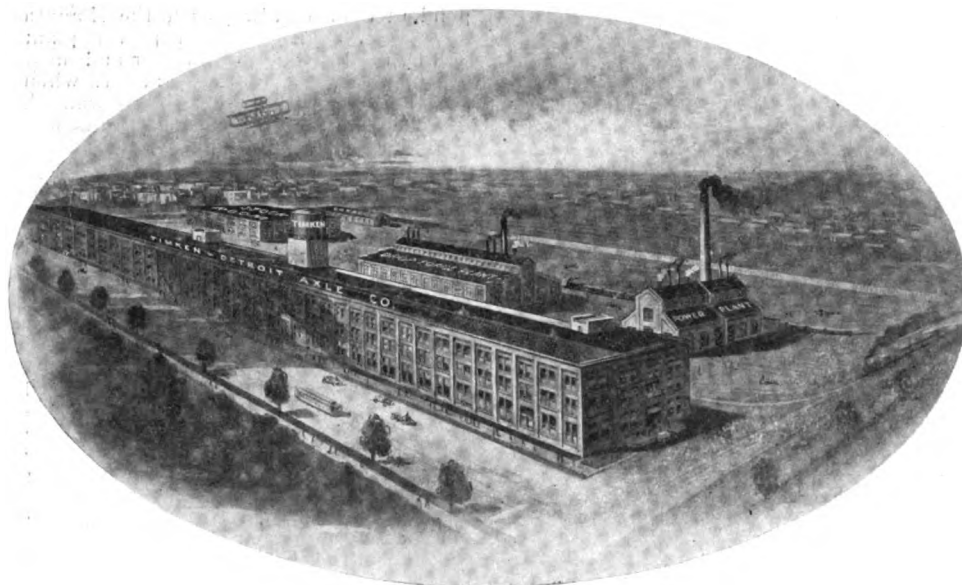

How the Timken-Detroit Plant will Look When Doubled in Size

been rushed to supply the demand. One telegram is given as coming from a California agent, as follows: "Ship by carloads as fast as possible until told to stop." The company engineers are busy planning the 1910 models and predict some interesting announcements.

Atwater-Kent Again Enlarges—The Atwater-Kent Manufacturing Works, Philadelphia, maker of the well-known Atwater-Kent Spark Generator and Unisparker, is again doubling its capacity, this being the second expansion which this concern has undergone in eight months. The change was made necessary by the fact that the Atwater-Kent Manufacturing Works will supply twelve new concerns this year with ignition goods as standard equipment, and it became imperative to secure quarters for more workmen and more machinery.

Standard Sales Company Introduces New Plug—To introduce its new spark plug, which is suitable for either magneto or battery, the Standard Sales Company, Broadway and Fifty-seventh street, New York, has arranged to send a sample plug to any address for 25 cents. The concern takes this method in order to get the plugs into the hands of the owners, and it is necessary for the sender to give the name of his supply house and also to state the thread desired.

Regal Company Erects Addition—The Regal Motor Car Company, of Detroit, is constructing a large increase to its plant at Beaubien and Trombly streets, so that its capacity for 1910 will be 3,000 cars. The concern has recently been incorporated.

Georgia Buggy Company to Build Autos—The Dublin Buggy Company, Dublin, Ga., has increased its stock by \$50,000, and will add the manufacture of automobiles. A one-story brick building, 80 by 200 feet in size, will be erected.

Will Manufacture Automobile Wheels—The West Chester Wheel Works, of Chester, Pa., is to add another department to its plant and will manufacture automobile wheels in it, beginning in about a month.

TIMKEN-DETROIT AXLE CO.

CANTON, O., June 21—For the fifth time in seven years the business of the Timken Roller Bearing Axle Company

has doubled, and this time the greatest move in the history of the concern has been made. By dividing the manufacturing of roller bearings from that of making automobile and other axles, an enlarged output in both branches has been secured. The Timken-Detroit Axle Company has been formed and capitalized at \$1,000,000 to manufacture the axles in Detroit, while the plant in this city will hereafter be known as the Timken Roller Bearing Company, and will produce roller bearings exclusively. Machinery is now being installed in the local factory which will just double its present capacity.

In Detroit, large and modern buildings on Clark avenue and the Pere Marquette Railroad were secured some months ago and prepared for occupancy. The drop-forge plant was increased and other improvements made so that the output of axles will be one of the largest in the country. Ample facilities and capital are at hand, and a great deal of business has been booked for 1910. The officers of the Detroit company are: President, W. R. Timken; first vice-president, H. H. Timken; second vice-president and factory manager, A. R. Demory; secretary and treasurer, E. W. Lewis; chief engineer, H. W. Alden; assistant secretary, F. C. Gilbert; purchasing agent, W. H. H. Hutton, Jr. The active management will be in the hands of Messrs. Demory, Lewis and Alden. Operations have already commenced, and in July the full product of the concern will be coming through.

SHANKS A REAL ESTATER

Considerable surprise has been expressed in automobile circles by the announcement of Charles B. Shanks, one of the most successful men in the advertising and sales ends of the industry, of his intention of entering the real estate business in Spokane, Wash., in connection with Fred A. Jacobs, the largest operator in that section of the country, the firm to be called the Jacobs-Shanks Company. Mr. Shanks is at present sales and advertising manager of the F. B. Stearns Company, Cleveland, and he will leave that concern about August 1. He entered the automobile business ten years ago as publicity and advertising manager of the Winton Motor Car-

riage Company, later being advanced to the sales managership, and one year ago resigned to organize a company to retail automobiles in Cleveland. When that was well under way he transferred the management and took up his present position with the Stearns Company.

PERSONAL TRADE MENTION

Charles Stein, of the Stein Double Cushion Tire Company, Akron, O., is now taking full charge of the pneumatic tire department of his company, and will hereafter spend the greater portion of his time in placing agencies throughout the country. Mr. Stein is the inventor of the Stein tires as well as a number of improvements in the construction of solid tires, and is known as an expert in the rubber business.

E. LeRoy Pelletier, one of the most prolific producers of live copy in the automobile world, and whose energies of late have been directed toward exploiting the E-M-F car has, under the new arrangement whereby the Studebaker Company takes over the E-M-F product, been made assistant to the general manager of the Studebaker Company and also director of sales and advertising manager.

B. E. Brown, of Pittsburgh, has been appointed district manager of the Helios Manufacturing Company branch in that city. The Helios company, of Philadelphia, is the manufacturer of storage batteries for ignition and electrical vehicle purposes, and in a Woods car made a run of 152 miles on one charge to Atlantic City and back.

J. J. Evans has resigned the general sales agency of the automobile department of Abendroth & Root Manufacturing Company, of Newburgh, N. Y., the makers of Frontenac cars.

TAXICAB AND TRANSIT

Another Auto Line to Gettysburg, Pa.—With which to establish an automobile line between Thurmont, Md. and Gettysburg, Pa., two large autos have been received at the former town, each of 30 horsepower and with seats for 12 passengers. One car will be run between Thurmont, where it will connect with the Washington, Frederick and Gettysburg railroad, and Emmitsburg. The other car will run between Emmitsburg and Gettysburg, the two machines meeting in the former town.

Baton Rouge, La.—It is likely that a line of automobiles will be put on by the Baton Rouge & Hammond Railroad, connecting Covington, Hammond and Baton Rouge. At present the only train is a mixed freight and passenger, which is slow and unsatisfactory, but the company claims that the cost would prohibit running another train for passengers only and is considering the establishment of a motor-driven train, or automobiles mounted upon railroad wheels.

Pittsburgh, Pa.—The Wells Fargo Express Company is about to try automobile truck service in this city, and if its success is proved, will extend it to every city in which the concern has an office. The American Express Company, which has been using trucks in some places, has not tried them here because of the heavy grades. It admits, however, that the horse must soon go because of the increasing business.

Boston—The Malden Auto Express Company has bought the business of the Benjamin & Vaughn Express, which has been running an express business between Boston and Malden. Five trips a day will be made by the machines and wagons of the new company, and a local car will be used in Malden. J. Frank Vaughn, of the older concern, is senior member of the new one.

Great Western Taxicabs in Chicago—The Model Automobile Company has entered into an agreement with its Chicago dealers to place Great Western cars in taxicab service in that city.

IN AND ABOUT THE AGENCIES

Firestone, Seattle, Wash.—The Firestone Tire & Rubber Company will open a direct Seattle factory branch on July 1, to care for a greatly increasing trade in the Northwest. The establishment will be at 918 East Pike street, and is the tenth branch to be opened. The Firestone company also has 25 general distributing agencies for Firestone tires and demountable rims.

Packard, Philadelphia—Plans have been prepared for the Keystone Motor Car Company for the addition of three stories to its four-story building on North Broad street. When this is completed the Quaker City agent for the Packard will have one of the largest local automobile establishments in the world.

Peerless and Pope-Hartford, Detroit—The J. H. Brady Auto Company, agent for the Peerless and Pope-Hartford automobiles, has removed to its new building at Jefferson avenue and Beaubien street. This company has secured the agency for the Hudson cars.

Regal, Detroit—The Regal Motor Sales Company has moved to its new garage at Alexandrine and Woodward avenues. It has recently been incorporated.

NEW AGENCIES ESTABLISHED

Chalmers-Detroit; Fort Worth, Tex.—Russells Auto Company, Second and Throckmorton streets.

Great Western: St. Louis, Mo.—The Albert Sterne Motor Car Company, 4130 Olive street.

Interstate: St. Louis—Lindsay Motor Car Company, 419 North Euclid avenue.

Rider-Lewis: Bellefontaine, O.—M. E. LeSourd, 300 Columbus avenue, east.

Mitchell: Waycross, Ga.—Gilbert M. Younglove, LaGrande building.

Rider-Lewis: Savannah, Ga.—Hazzard & Brocket, 320 Broughton street.

Pope-Hartford: Chicago.—Joseph Deibler, for the State of Illinois.

Rider-Lewis: Hackettstown, N. J.—J. W. Dalrymple.

Middleby: Newark, N. J.—M. and M. Auto Company.

Moon: Tampa, Fla.—Wilson, Trawick & Denham.

Lozler: Pittsburgh, Pa.—Banker Brothers.

RECENT INCORPORATIONS

Tribe Automatic Headlight Company, Worcester, Mass.—Capital \$200,000. To manufacture and sell headlights for automobiles, locomotives and street cars. President, Charles F. Pharaoh; treasurer, George T. Tribe; clerk, Edmund R. Cummins.

K. E. Auto & Electric Company, Birmingham, Ala.—Capital \$10,000. To deal in automobiles and electrical supplies, and to do repair work. Officers: President, Kyle Elliott; vice-president, T. G. Erwin; secretary and general manager, L. C. Kyle.

Consumers' Auto Supply Company, Pittsburgh, Pa.—Capital \$25,000. To manufacture, sell, and deal in all kinds of supplies for

automobiles. Incorporators: E. C. Neagley, M. L. McKain, B. L. Slonecker. Delaware corporation.

Phillip C. Traver Manufacturing Company, Far Rockaway, N. Y.—Capital \$50,000. To manufacture accessories for automobiles, bicycles and carriages. Incorporators: Phillip C. Traver, Lewis Pearsall, George Breng.

Memphis Taxicab Company, Memphis, Tenn.—Capital \$100,000. To operate taxicabs and other automobiles. Incorporators: S. M. Neely, N. C. Perkins, E. B. Le Master, G. G. Albon, S. H. Trezevant.

Plainfield Auto Bus Company, Plainfield, N. J.—Capital \$50,000. To operate automobiles and other automobiles. Incorporators: A. R. Force, A. Tepper, M. Mendel, F. C. G. Martin.

Custead Motor Vehicle Company, New York.—Capital \$100,000. To manufacture automobiles, etc. Incorporators: William D. Custead, Charles F. Di Dion, Arthur M. Von.

Carthage Automobile Company, Carthage, Miss.—Capital \$10,000. To operate an automobile line between Canton and Carthage. Incorporators: R. L. Jordan, J. A. Walker.

New York & Queens Auto Truck Company, New York City.—Capital \$10,000. To operate buses and trucks. Incorporators: E. J. Forham, H. H. Browne, J. J. Harper.

E. R. Thomas Motor-Branch, Buffalo, N. Y.—Capital \$100,000. To deal in automobiles. Incorporators: Edwin L. Thomas, J. M. Edsall, M. E. Dirnberger, Jr.

Regal Motor Car Company, Detroit.—Capital \$100,000. To manufacture automobiles. Incorporators: Charles E. Lambert, John E. Lambert.

Maxwell-Briscoe Motor Company, Detroit.—Capital \$1,500,000.

NEW TRADE PUBLICATIONS

Electric Welding Products Company, Cleveland.—Two booklets have been issued by the Electric Welding Products Company illustrating their finished steel bolts and screws, and their valve stems and other electrically welded materials. These books are handsomely gotten up, with fine typography and clear cuts, and thus altogether attractive. They treat of the methods of welding the products, as well as the reasons for using these in preference to cutting down bolts, etc., from solid stock. Valves may be made by this process with nickel steel heads and carbon steel stems, and brake or gear shifting levers of steel with brass or bronze handles. The books are intended for the automobile trade, dealing with products used in the construction of the cars.

Continental Caoutchouc Company, New York City.—Buff-colored folders, containing five photographs showing the different operations necessary in removing and replacing a deflated tire on a Continental demountable rim, have been issued by the Continental Caoutchouc Company. These are being sent to every automobile club in the country, and are artistically and neatly gotten up.

PARTRIDGE BEEFSTEAK DINNER

NEW YORK, June 21—As a farewell dinner before starting upon a vacation tour to Europe, E. S. Partridge, of the firm of Wyckoff, Church & Partridge, last Thursday evening gave a genuine "beefsteak" repast to more than a score of prominent New Yorkers. The gathering was at Luchow's in true Bohemian fashion, and with white aprons and hats on the host and guests, the steaks were served upon big kegs instead of the conventional tables. Those present were: E. S. Partridge, Judge Loren Zeller, Percy Yalden, J. E. Demar, B. F. Nathan, J. P. Goodwin, August Luchow, G. T. Stockham, E. Gibbs Murphy, George Rector, George Johnson, A. Weiss, James Chism, I. H. Manning, C. W. Wurster, H. M. Swetland, Oscar Warner, Arthur Lesser, C. G. Drum, Howard Drakely, G. H. Gantert, Alex. Dow, Morris Rothchild, A. W. Church, Arthur Hildebrand, Guy Vaughn, S. C. Carrie, H. E. Wagner and A. J. Pickard. As a mark of their esteem, the W. C. P. force presented Mr. Partridge with a fully equipped and very handsome traveling case.

Mr. Partridge sailed on Saturday and will be away about six weeks. He took with him a Stearns touring car equipped with Continental tires and a new model of the Warner instrument. With the car he will tour in England and upon the Continent and may establish agencies in London, Paris and Berlin, in answer to many queries received from Europe during the past year as to the Stearns product. One of the interesting news items which appeared at the dinner was that the third 1909 series of Stearns cars will contain some real surprises, and that the first will be ready for delivery by August 1, at which time Mr. Partridge will be back to supervise the distribution of the fall and winter allotment. During the past year the company has sold in this city and the East more than twice as many cars as it did the previous year and would like to have had more cars to sell. During the coming year, however, the firm has determined not to be caught napping and has already placed blanket orders to ship as many Stearns cars as the big Cleveland factory can produce for the eastern territory. The new yellow taxicabs have been very satisfactory.

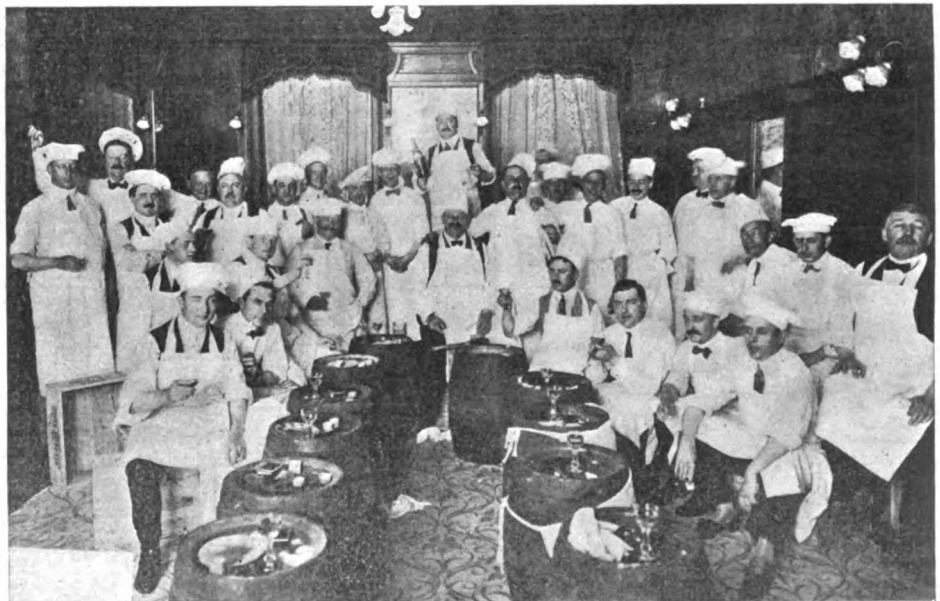

When the Guests Surrounded the Festal Board at the Recent Partridge Beefsteak Dinner

Information for Auto Users

Grade Percentage Indicator—There is but one standard for the measurement of grades, the rise in 100 feet, which, of course, is also the per cent. Every grade meter should read in terms of this, so that different slopes may be compared intelligently, although it is a fact that many of them do not. A new measuring instrument, known as a gradometer, has this as the principal feature. Not only does this new instrument measure and indicate the percentage of

the grade, but it indicates to fractions of 1 per cent. just as delicately as the higher amounts. The exterior form of the instrument is very pleasing, and, to prevent cheap copies being made, the makers have registered the shape. It is of highly polished brass, measuring 7 inches in height, with a 2½-inch dial. The latter is silvered to make the letters read more plainly. The method of attaching it to the dashboard, the only place for such a handy and handsome instrument, is by means of screws, three being necessary. It is made abroad and sold in this country by Samuel Buckley & Company, 225 Fifth avenue, New York City.



KIPLING GRADOMETER

A second new product is the dashboard switch. This consists of a large diameter plate, from the under side of which projects a hub. The latter houses the mechanism of the switch and protects it from dirt, dust and injury. Arranged to just project through a one-inch dashboard, this mechanism is very simple. A hard rubber handle is attached to a ferrule, which makes the contact with the body of the switch when the handle is pulled out. At the same

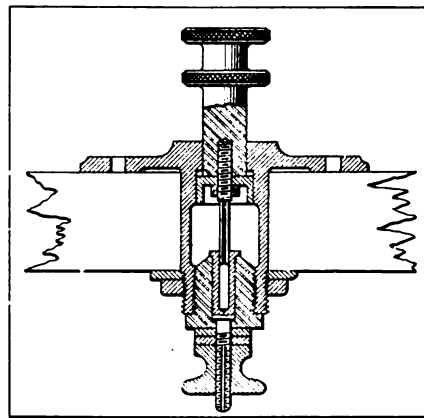

BOSCH DASH SWITCH IN SECTION

A New Ignition Lock—The name of Bosch has always been associated with articles of merit, and the latest products of the Bosch factory are no exception to this rule. In the key switch designed for use with dual ignition, is found something to fill a long-felt want. This is provided with a large, flat key, which may only be withdrawn when it is perpendicular. In this position the magneto windings are connected to the ground, while the battery circuit is opened. In this way it is impossible to operate the engine. With the key in position, a turn to the left puts the mag-

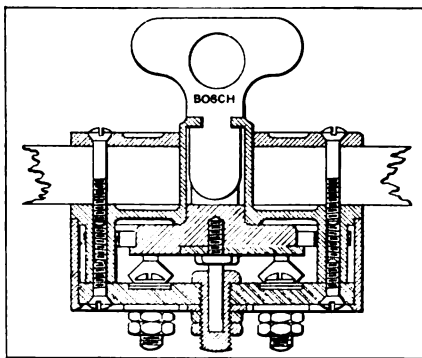

BOSCH IGNITION LOCKING SWITCH

neto back into business, or a turn to the right allows the use of the battery system. The key is spring-held in any one of the positions, which are regulated as well by stop pins abutting against the posts, to which holding screws are fitted.

time, the cable attached to the inside end of the ferrule is grounded. Both devices are sold in this country by the Bosch Magneto Company, 223-225 West Forty-sixth street, New York City.

Koen's Folding Table and Chairs—For the use of automobilists, campers, boatmen and others, where a portable chair or table is desired, the Buffalo General Manufacturing Company, Buffalo, N. Y., is marketing the Koen patent folding chairs and table. The chairs are of the revolving, as well as folding type, suitable for tonneau seats or for use in a motor boat. Four kinds are made, with the price depending upon the upholstery or general finish; and one is so designed as to fold up against the side of the car or boat; another to have the back fold upon the seat, mounted upon a pedestal. The table is applicable for places where light lunch is served, for office work and more especially for traveling or camping. It lends itself to ready adjustment and packing.

The Autoist's Rabbit Foot—Strange as it may seem in a non-superstitious people, there is at present an unprecedented demand for good luck emblems. To meet this demand all of the leading dealers are laying in large stocks of the various lucky charms now made. The Motor Car Equipment Company, 1727 Broadway, New York City, is going into this line very extensively, and in addition to Gobbo, "The God of Good Luck," is making up a number of emblems of dif-

ferent fraternal orders in various sizes and suitable for radiator caps. They include the emblems of the Masonic fraternity, Elks, Woodmen, Knights of Columbus, and many others. They are set out in all finishes, 24-karat gold, silver and antique brass.

K-W Magnetos to Supply Electric Lights—Automobilists are always glad to hear of a simple method of lighting their lamps by electricity, especially from a source which does not add complications. The K-W Ignition Company, Cleveland, O., manufacturers of the K-W magneto, announces that after extended experiments the K-W magneto has proven itself suitable for ignition and lighting purposes at the same time. Connections are made, as shown in the illustration, to electric bulbs in the searchlights, and the switch is located wherever convenient, but the lighting system is entirely distinct from that furnishing ignition. The company states that the tests failed to show any depreciation of the ignition current when the lights were turned on, and that the lights are also of ample power for use in the large searchlamps. In discussing the new system J. A. Williams, president of the company, says: "We have known that the K-W magneto would run lights successfully, in addition to ignition, but we have been conservative, and have made lengthy tests which have satisfied us that a combination is practical and we guarantee it. There is ample current to furnish both lights and ignition at the same time, and when the electric light is placed in a parabolic reflector the rays are thrown straight ahead and concentrated, so as to light objects several hundred feet away. When the motor is slowed down there is a slight variation in the light due to the change of speed, but it is very slight, and not enough to figure. The lights, on the other hand, do not have any effect upon the ignition, provided that the proper lamps are used. Another feature of the magneto is that the nature of the alternating current with the principle of the armature re-

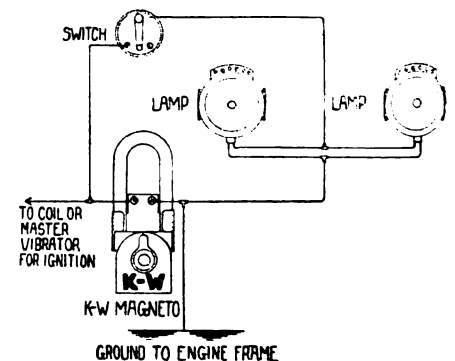

K-W MAGNETO ELECTRIC LIGHTING SYSTEM

action keeps the voltage within very close limits. Six-volt tungsten lamps of a capacity that will draw about five amperes as a total load are the best. If one lamp is used it should draw not more than five amperes; if two lamps are used, we suggest that they should be two and one-half ampere lamps; while for motorboats we would advise the use of one two-ampere lamp and three one-ampere lamps. The lamps should in any case be tungsten types, which give three or more times as much candle power as the ordinary carbon lights."

THE AUTOMOBILE

WEEKLY

PRICE TEN CENTS

VOL. XX.

JUNE 24, 1909

No. 25.

GRAY & DAVIS

1910 CLOSE COUPLED LAMP

MADE IN
ALL SIZES

DESIGN PATENT
APPLIED FOR

We will show on this page, three weeks from to-day, a picture of our new model Close Coupled Gas Lamp. The Gray & Davis double lighting feature will be the same, with improvements and refinements, and to those who want lots of light at night it will be a revelation.

The outside shell and hood of new and pleasing shape, we have worked on for several months and have succeeded in making a smooth, plain lamp, with all unsightly screws and rivets concealed. This makes a rich looking lamp, easy to clean and that does not catch the dirt.

GRAY & DAVIS
AMESBURY, MASS.

STROMBERG CARBURETORS

THREE REASONS WHY STROMBERG CARBURETORS ARE THE BEST

Power

A perfect mixture at all speeds is absolutely necessary in order that a motor may develop its maximum horse-power. On account of the design and control of the auxiliary air valve in a STROMBERG CARBURETOR, a perfect mixture is certain on any speed. For this reason the motor will give excellent service, equally well on low, intermediate or high speeds.

Speed

The design of the STROMBERG CARBURETOR compels it to automatically clear itself, and never allows it to become choked or filled when properly adjusted. This one thing alone means greater speed than any other; not only ability to retain high speed, but to speed up quickly after being slowed down.

Simplicity

There is only one absolute adjustment on a STROMBERG CARBURETOR, and that is to set the auxiliary air valve first for low speed with the knurled adjusting nut underneath, then for high speed with the nut above the valve. After a STROMBERG CARBURETOR is once adjusted it needs no further attention. Adjustments are self-locked.

MADE TO FIT ANY CAR

ORDER ONE FOR YOUR CAR TO-DAY

Catalog No. 1 describes and illustrates in detail. Send for it to-day

DISTRIBUTORS

Auto Equipment Co. . . . Philadelphia, Pa.
Way, Mitchell & Co. . . . Cleveland, Ohio
R. H. Combs St. Louis, Mo.
Stephenson Motor Car Co. . . Milwaukee, Wis.
Stoddard-Dayton Auto Co., . . Minneapolis, Minn.
Bertschy Motor Co. . . . Council Bluffs, Iowa
Kansas City Auto Co. . . . Kansas City, Mo.
Motor Equipment Co. . . . Seattle, Wash.
Western Rubber & Supply Co., Los Angeles, Cal.

STROMBERG MOTOR DEVICES CO.

Main Office and Factory

1253-1255 Michigan Ave., Chicago

NEW YORK BRANCH: Automobile Building, 64th Street and Broadway
BOSTON BRANCH: 319 Columbus Avenue
SAN FRANCISCO BRANCH: 307 Golden Gate Avenue

"SPECIAL"



"OFFSET"



"ROUND"



The justly
CELEBRATED
8-Day, High-Grade

"CHELSEA" AUTO CLOCK

(Trade Mark)

Clocks built with a view to stand the jars and jolts and rough riding of Automobiles. Reputation the highest. Used by parties demanding the BEST.

ALL SIZES STATED ARE THE APPROXIMATE DIAMETERS OF THE DIALS.
All are 8-day High-Grade. All are in DUPLEX (patent applied for) polished cast brass cases, the most thoroughly water-proof case on the market. The "SPECIAL" clocks show dial on an angle; its inner cased clock when removed from outer (locked) case is excellent for use on mantels, bureaus, etc., when touring; its outer case is screwed to dashboard by hidden screws. The "SPECIAL" clocks are in large demand from dealers for owners of finest cars.

The MOTOR CLOCK has the same clock movement which for years we have supplied for the road use on Locomotives, Steam Fire Engines, etc.; its dial is of same appearance as the AUTO Clock dial, but the Auto Clock movement has a somewhat finer train.

The 3 1-2 MOTOR "OFFSET" is likely to prove a quick, ready seller. Very attractive.

PRICE LIST

Size	"Round"	"Offset"	"Special"	"Limousine"
2 3-4-inch Auto Clock	\$28.00	\$28.00	\$38.00	\$28.50
3 1-2-inch Auto Clock	28.00	30.00	48.00	
3 1-2-inch Motor Clock	24.00	28.00	41.00	

"Chelsea"

Only made in 2 3-4-inch size in Limousine style.

YOU want the BEST? **CHELSEA CLOCK CO., 16 State St., BOSTON, U.S.A.** Ask for the "CHELSEA"
Largest makers in America of exclusively 8-Day—High-Grade Clocks—Mantel, Marine, Office, Ship's Bell Clocks, Auto Clocks, etc.

"LIMOUSINE"



Primarily intended for use inside the bodies of large enclosed cars, and for such use its case can be given a variety of fine finishes. It also makes an attractive clock for use on dashboards. Only made in 2 3-4-inch size.

INDEX TO ADVERTISERS

Abendroth & Root Mfg. Co. 51	Dixon Crucible Co., Joseph. 57	Long Mfg. Co. 78	Safety Device Co. 81
Acetylene Gas Illuminating Co. 49	Dixon Specialty Co. 78	Loring Auto Appliance Co. 49	Schrader's Sons, A. 49
Adams Co. 51	Doolittle Kim Co. 98	Lucas & Co., John. 56	Schubert Bros. Gear Co. 50
Air-Tight Steel Tank Co. 98	Driggs-Seabury Ordnance Corp. 76	M. & E. Mfg. Co. 56	Selden Motor Vehicle Co. 74
Aluminum Foundry Co. 56	Duplex Co. 70	McCue Co. 102	Shaler Co., C. A. 54
Ajax-Grieb Rubber Co. 51	Duplex Coil Co. 51	Maple City Mfg. Co. 63	Shortsville Wheel Co. 49
American Motor Car Co. 51	Dyke's Cor. School of Motor- ing 48	Masury & Son, John W. 90	Sireno Co. 91
Atwater-Kent Mfg. Works. 77	Edmunds & Jones Mfg. Co. 57	Mathewson Automobile Co. 92	Skinner & Skinner. 58
Atwood-Castle Co. cover	Eldredge Electric Mfg. Co. 49	Maxwell-Briscoe Motor Co. 113	Slama Tire Protector Co. 72
Austin Automobile Co. 75	Empire Tire Co. 71	Metz, Chas. H. 74	Smith Mfg. Co., I. J. 85
Austro-American Separator Co. 49	Everett-Metzger-Flanders Co. 73	Michelin Tire Co. 51	Spacke Machine Co., F. W. 78
Autocar Co. 106	Excelsior Supply Co. 62	Midland Motor Co. 114	Spare Motor Wheel of America 72
Auto Car Mfg. Co. 86	Excelsior Tire Co. 58	Miller, Chas. E. 91	Speed Changing Pulley Co. 72
Auto & Supply Mfg. Co. 49	Firestone Tire & Rubber Co. 66	Mitchell Motor Car Co. 85	Speedwell Motor Car Co. 69
Automobile Blue Book. 63	Fish, Geo. L. 95	Model Automobile Co. 74	Spicer Universal Joint Mfg. Co. 50
Automobile Trade Directory. 58	Fisk Rubber Co. 70	Moline Automobile Co. 74	Spltdorf, C. F. 78
Babcock Electric Carriage Co. 90	Fientje, Ernst 70	Moon Motor Car Co. 51	Sprague Umbrella Co. 72
Bacon & Fynney. 79	Fort Pitt Motor Mfg. Co. 92	Morrison-Ricker Mfg. Co. 86	Standard Co. 94
Baker Mfg. Co. 54	Foster Shock Absorber. 78	Morgan & Wright. 67	Standard Roller Bearing Co. 50
Baldwin Chain & Mfg. Co. 50	Fourteen-Eleven Co. 78	Mosler & Co., A. R. 91	Standard Sales Co. 49
Billings & Spencer Co. 48	Franklin Mfg. Co., H. H. 78	Moss Photo Engraving Co. 91	Standard Sheet Metal Co. 87
Bi-Motor Equipment Co. 48	Fried-Osterman Co. 69	Motor Car Equip. Co., 78-56-84-73 78	Standard Welding Co. 66
Black Mfg. Co. 70	G & J Tire Co. 80	Motz Clincher Tire & Rub. Co. 51	Stanley & Patterson. 81
Bongartz Co. 84	Gaeth Automobile Co. 58	Munch-Allen Motor Car Co. 79	Star Speedometer Co. 112
Borne Scrymser Co. 55	General Accumulator & Bat- tery Co. 88	Mutty Co., L. J. 50	Stearns Co., F. B. 98
Boston Auto Gage Co. 49	Goodrich Co., B. F. 52	N. Y. Sporting Goods Co. 49	Stein Double Cushion Tire Co. 79
Boston Y. M. C. A. 79	Goodyear Tire & Rubber Co. 92	N. Y. & N. J. Lubricant Co. 96	Stevens-Duryea Co. 105
Bowser & Co., S. F. 94	Gramm-Logan Motor Car Co. 51	National Brake & Clutch Co. 50	Stewart & Clark Mfg. Co. 61
Boyle & Co., John. 70	Gray & Davis. cover	National Tube Co. 85	Stitch-In-Time Vulcanizer Co. 57
Bretz, J. S. 99	Grossman Co., Emil. 97-104	National Motor Vehicle Co. 90	St. Louis Supplementary Spiral Spring Co. 90
Bowser & Co., S. F. 98	Grout Automobile Co. 100	Neustadt Auto & Supply Co. 71	Stromberg Motor Device Co. cover
Brown Co. 58	Ham Mfg. Co., C. T. 55	New Departure Mfg. Co. 100	Studebaker Automobile Co. 74
Brown-Lipe Gear Co. 66	Hansen Mfg. Co., O. C. 70	New Process Rawhide Co. 80	Swinehart Clincher Tire & Rubber Co. 69
Brownell Motor Co., F. A. 50	Hardy Co., R. E. 49	Nightingale Whistle Mfg. Co. 88	Syracuse Chemical Fire Ex- tinguisher Co. 84-87
Brush Runabout Co. 79	Harris Oil Co. 88	Nonkoroda Co. 63	Thomas Motor Co., E. R. 73
Buckeye Jack Mfg. Co. 72	Hart-Kraft Motor Co. 56	Nordyke & Marmon Co. 51	Timken Roller Bearing Axle Co. 104
Buckeye Mfg. Co. 63	Hartford Suspension Co. 85	North American Motor Corp. 103	Tiresele Mfg. Co. 67
Buffalo Specialty Co. 89	Haws, Geo. A. 55	Nuttall Co., R. D. 50	Tray Plate Battery Co. 72
Buick Motor Co. 82-83	Hayne's Automobile Co. 73	Oakes & Dow Co. 63	Trenton Rubber Mfg. Co. 51
Buob & Scheu. 67	Helnze Electric Co. 95	Oakland Motor Car Co. 80	Trimpont Mfg. Co. 67
Buffalo Electric Vulcanizer Co. 57	Henrick's Novelty Co. 66	Olds Motor Works. 51	Triple Tread Auto Tire Mfg. Co. 86
Burnett-Compound-Spring Co. 72	Hercules Electric Co. 62	Orange Machine & Mfg. Co. 71	Troy Carriage Sunshade Co. 66
Burrowes & Co., E. T. 64	Herschell-Spillman Co. 50	Outdoor Cooker Co. 69	Tucker, C. F. 49
Byrne-Kingston Co. 64-68	Herz & Co. 59	Overland Automobile Co. 111	Turnbull Wagon Co. 80
Cadillac Motor Car Co. 51	Hess-Bright Co. 97	Owen & Co., R. M. 51	Uncas Specialty Co. 62
Cameron Car Co. 66	Hill Dryer Co. 50	Packard Electric Co. 71	Universal Tire Protector Co. 80
Canton Drop Forging & Mfg. Co. 50	Hoffecker Co. 71	Packard Motor Car Co. 116	Van Wagner Mfg. Co., E. B. 56
Chadwick Engineering Works. 84	Hoffman, Geo. W. 49	Palmer & Singer Mfg. Co. 51	Veeder Mfg. Co. 93
Chelsea Clock Co. cover	Holtzer-Cabot Electric Co. 85	Pantasote Co. 58	Vehicle Specialty Corp. 66
Clark Carriage Co. 50	Holtzer-Cabot Electric Co. 85	Parish & Bingham. 50	Velle Motor Vehicle Co. 93
Cleanola Co. 84	Hotel Woodstock. 55	Parker Mfg. Co. 69	Victor Tire Traction Co. 51
Cleveland Puncture Proof Tire Co. 80	Hoyt Electrical Ins. Works. 49	Parker, Stearns & Co. 50	Volcano Spark Plug Co. 85
Coes Wrench Co. 45	Indestructible Steel Wheel Co. 50	Pennsylvania Auto Motor Co. 79	W. D. Spring Cushion Tire Co. 78
Cook's Sons, Adam. 78	Interstate Automobile Co. 72	Perfection Non-Skid Climber Co. 88	Waban Webbing Co. 50
Conn. Tel. & Electric Co. 101	Jackson Automobile Co. 51	Peerless Specialty Co. 84	Warner Instrument Co. 60
Continental Caoutchouc Co. 51	Jeffery & Co., Thomas B. 115	Peugeot Freres. 50	Weed Chain Tire Grip. 71
Continental Motor Mfg. Co. 58	Jewell Motor Car Co. 74	Pitcher & Stone. 70	Weston Elec. Instrument Co. 81
Corbin Motor Vehicle Corp. 74	K.-W. Ignition Co. 99	Pittsfield Spark Coil Co. 94	Western Motor Co. 69
Corcoran Lamp Co. 57	Karl Co., Adolph. 49	Portland Garage. 55	Wheaton & Utley. 85
Comet Electrical Mfg. Co. 60	Kemzite. 87	Prest-O-Lite Co. 98	Wheeler & Schebler. 107
Cornish Friedburg Motor Co. 51	Keystone Lubricating Co. cover	Prosser & Sons, Thos. 67	White Co. 108-109
Couvert Motor Vehicle Co. 51	Kimball Tire Case Co. 70	Puritan Gas Tank Co. 66	Whitlock Coil Pipe Co. 67
Crane Puller Co. 49	Kipling Gradometer. 54	Quincy-Manchester-Sargent Co. 55	Whitney Mfg. Co. 66
Cunningham, Son & Co., J. 102	Kissel Motor Car Co. 78	Raines & Co. 49	Willard Storage Battery Co. 89
Cullman Wheel Co. 50	Knapp-Greenwood Co. 57-67	Randall-Falchney Co. 57	Willett Engine & Carbureter Co. 86
Cutter, G. A. 79	Knox Auto Co. 101	Remy Electric Co. 77	Winton Motor Carriage Co. 79
Dayton Motor Car Co. 74	Kokomo Electric Co. 76	Republic Rubber Co. 94	Witherbee Igniter Co. 57
Dayton Rubber Mfg. Co. 51	Konigsow, Otto. 50	Rex Wrench Co. 70	Wyman & Gordon Co. 48
De Luxe Motor Car Co. 51	Lansing Wheelbarrow Co. 71	Robert Instrument Co. 49	Xargill Mfg. Co. 80
Detroit & Cleveland Nav. Co. 55	Leather Tire Goods Co. 69	Rockwood Mfg. Co. 63	York Motor Car Co. 87
Diamond Chain & Mfg. Co. 50	Lehman Mfg. Co., J. H. 49	Robinson & Sons Co., Wm. C. 55	Zimmerman Mfg. Co. 89
Diamond Rubber Co. 53	Leland Co., W. H. 80	Rome-Turney Radiator Co. 70	
Dietz Co., R. E. 103	Lexington Motor Car Co. 73	Royal Equipment Co. 78-49	
	Life Publishing Co. 49	Rushmore Dynamo Works. 110	
	Lobe Pump & Machinery Co. 49	S. M. Supplies Co. 72	
	Locomobile Co. of America. 51	Salisbury Wheel & Mfg. Co. 49	
	Long Arm System Co. 72		

FOR UNMATCHABLE QUALITY BUY

COES

STEEL HANDLE MODEL WRENCH

Coes New Auto Wrench

Sizes:
6-in. and 12-in.

Special Features:

Narrow Jaws Especially Made for Automobile Work, Without Sacrificing Strength

COES WRENCH COMPANY, Worcester, Mass.

6"-size jaw opens 1 1/4".
Takes any spark plug.
12" jaw opens 2 1/4".

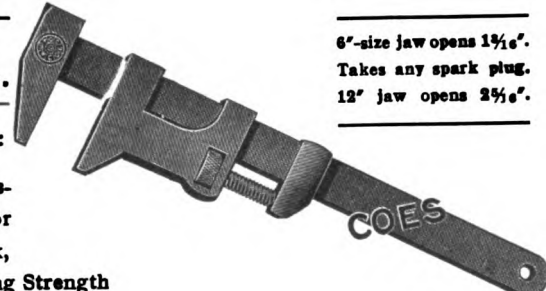

PLEASE MENTION THE AUTOMOBILE WHEN WRITING TO ADVERTISERS

SPECIAL NOTICES

Advertisements inserted under this heading at 20 cents per line; about 7 words make a line. Remittance should accompany copy. Replies forwarded if postage is furnished.

Cars for Sale

A 3-TON gasoline motor teaming truck. Famous Mfg. Co., East Chicago, Ind.

A 1909 PACKARD "30," seven-seated touring car, equipped with two large searchlights, gas tank, seat covers, Jones combination speedometer, with maximum hand, siren horn. Address "Packard," care The Automobile.

A BARGAIN.—My 1907 Autocar runabout, fully equipped; \$275 if sold immediately. L. France, 513 West 145th St., New York City.

A CLEARANCE SALE of standard make autos—all styles and prices. Taken in part payment for new cars and all thoroughly overhauled by our factory experts, with the company's name behind them. Thos. B. Jeffery & Co., 302-304 Wabash Ave., Chicago.

A LARGE LINE of second-hand gas and electric cars, all prices. Write for list. Buckeye Garage Co., 6112 Euclid Ave., Cleveland, O.

A ALL KINDS of cars at all kinds of prices, \$150 and up. Write us or call and we can satisfy you. Western Auto Sales Co., 309-310-311 Michigan Ave., Chicago, Ill.

A M LEAVING town and will sacrifice almost new seven-passenger touring car, 32-H.P., French rating; fully equipped. W. S., P. O. Box 15, Sta. R., New York City.

A M WILLING to sacrifice my '06 Pierce-Arrow seven-passenger touring car; in excellent condition, just repainted; has complete equipment. Address Box 758, care The Automobile.

A UTOMOBILES of all kinds bought and sold. Largest New England dealers. Braley & Myers, 66 Berkley St., Boston, Mass.

AUTO BARGAINS!

The Times Square Automobile Company announces the opening of their St. Louis branch house, 18th and Pine Sts., St. Louis, Mo., where, as has been our policy for nearly ten years in New York, and now in our third year in Chicago, it is our purpose to buy high-grade used cars from owners wanting quick cash, and in time sell these cars to the general public on but a small margin of profit, relying for our remuneration on quick sales and the volume of business, rather than large individual profits. With our vast experience we can judge good cars, and give our customers the benefit of our best efforts. We are the largest dealers in new and used cars in the world; no matter what car you want, we have it. We have at present on the floors of our various buildings an exceptionally large and good line of popular makes and reliable automobiles. If the saving of money is an object, you will do well to communicate with us either in person or by mail. The Times Square Auto Bulletin will prove valuable and interesting to you whether you are an owner or a prospective buyer. It contains 48 pages of live auto matter and describes 300 cars, giving particulars and prices. Single copies free. Deal with a responsible concern. The Times Square Automobile Co., 215 and 217 W. 48th St., New York; 1332 and 1334 Michigan Ave., Chicago, Ill.; corner 18th and Pine Sts., St. Louis, Mo.

A URBURN 1908 Touring Car, full equipment, top; run 1,760 miles; guaranteed perfect; want smaller car. A. F. Klett, Rexmont, Pa.

A UTOMOBILE BARGAIN.—\$1,000 will buy good as new \$5,000 touring car. "S. S.," care The Automobile.

BUGGY AUTO.—"Kiblingen," practically new; cost \$400, sell \$125; not good on our sandy roads; first check gets it. S. Parker, Pine Town, N. C.

CADILLAC one-cylinder touring cars, with gas lamps and tops; one 1906, in good condition; one 1907, overhauled, every worn part replaced, a guaranteed job, running boards, newly painted. Harry M. Eastman, Melrose, Mass.

CADILLAC—Light touring car, new, 24-H.P., two-cylinder engine; all the working parts are new; five tires, six tubes, in good shape; lamp, generator, etc.; car as good as new; \$550. Address Lock Box 136, East Palestine, Ohio.

COLUMBIA touring car, 2-cylinder, 18-H.P.; cape top, wind shield; good running order. 2923 N. 9th St., Philadelphia, Pa.

COLUMBIA Electric Victoria, 44-cell Exide battery; cost \$4,000, 1907; will sell for \$1,000. Mrs. Edw. Ellis, 215 Union St., Schenectady, N. Y.

CORBIN touring cars and runabouts, \$800 and up. Thoroughly overhauled by us and guaranteed. Corbin Motor Vehicle Cop'n of N. Y., 1888 Broadway, near 62d St., New York City.

EXCEPTIONAL BARGAIN! 1909 six-cylinder, Model H Franklin, seven-passenger touring car; absolutely new; with special blue-striped show body; tires not soiled; regular equipment, including seat covers, top, glass front, etc. Immediate response necessary; will consider exchange for Lozier or gilt-edge securities. Westcott Garage Company, Utica, N. Y.

FASTEST car in the world for sale, 120-H.P. Address A. Hon, 340 Willoughby Ave., Brooklyn, N. Y.

FIVE and seven-passenger high-grade touring cars. Factory overhauled and refinished. A better proposition by far than a cheap new one. Also many other desirable cars at prices that will surely interest you. E. R. Thomas Motor Co., Dept. S. H., 1200 Niagara St., Buffalo, N. Y.

FORTY-FIVE HORSE '07 Lozier, reasonable. Apply Wheeler, 1 West 103d St., New York.

I F LOOKING for a slightly used runabout or touring car, cheap, write me what you want. L. France, 513 West 145th St., New York City.

LARGE, two-cylinder, side-entrance car; perfect condition, complete; cape top, storm front, side aprons, three searchlights, three oil lamps, chains, tire covers, etc.; will be sold cheap or trade for real estate or stock. Walter Menge, L. B. 114, Dolgeville, N. Y.

MODEL F Stanley touring car, fine condition, top and speedometer. \$650. A. S. Lee, 52 Richmond St., Providence, R. I.

MODEL U Stevens-Duryea Little Six, thoroughly overhauled, complete equipment, will be sold at a bargain. Inquire Maine Motor Carriage Co., Portland, Me.

MODEL "K," thirty-horsepower, seven-seated White Steamer in first-class condition; equipped with top, gas lamps and generator; two extra tires, Jones combination speedometer and set of tools been used very little; first check for \$1,800 takes it. Address "K," care The Automobile.

MY 1907 light touring Knox car I offer for \$400 cash; in fine order and a bargain. L. France, 513 West 145th St., New York.

NEW 1909 Franklin G Runabout; top, glass front, gas tank and lamps; cost \$1,950; price \$1,600. Address "R," care The Automobile.

ONE NEW 1909 Model G Franklin, equipped with top, folding glass front, searchlights and generator. First check for \$1,650 takes it. Address "Franklin," care The Automobile.

ONE Model G White, equipped with 1908 flow motor and water heater; Fisk demountable rims and heavy cart type tires, 36x5, all around; one extra shoe, tube and rim; tire-carrying irons; Sprague glass front; extension top; large Rushmore headlights and generator; large Rushmore searchlight; toilet articles in the back; large revolving chairs; electric horn and regular horn; Sager supplementary springs all round; painted regular dark green; paint and varnish in first-class condition. Or will exchange for 1907 or 1908 Ford touring car in good condition. Thos. J. Northway, Rochester, N. Y.

ONE Waverly electric surrey with Exide battery, tires in good condition, canopy top, fine station wagon, ready to run. First check for \$300 gets it. The J. W. Bowman Co., 911 Boylston St., Boston, Mass.

REBUILT CARS guaranteed for one year. Get our weekly list, No. 13. Over 100 high-grade cars always in stock. Prices, \$125 up. International Automobile Co., 1243-47 Wabash Ave., Chicago, Ill.

SEVEN-PASSENGER Pope - Toledo, good condition, with top, \$900. A. S. Lee, 52 Richmond St., Providence, R. I.

SLIGHTLY used automobiles have no standard price. When owners are eager for quick sale, you get the lowest figures. But to get a bargain, avoid the dealer's profit. We sell cars direct for owners. The latter pay us 5 per cent. commission. Being under low expenses, and with quick sales, we can make this system profitable. Over 250 cars to select from, representing nearly every make. Prices, \$150 to \$2,500. If you cannot call send for bargain list. Manhattan Storage Co., 334-340 West 44th St., New York City.

STEVENS-DURYEA light six 1908 touring car with complete equipment, top, glass front, extra tires, etc.; in use less than a year; perfect condition; price \$2,200. C. S. Ransom, Albany, N. Y.

STUDEBAKER, 1909 40-H.P. touring car, with top and full equipment; car is practically new; price \$3,500. C. S. Ransom, Albany, N. Y.

TEN - PASSENGER automobile, Mitchell chassis, 30-H.P., four-cylinder, condition guaranteed, \$900. Stark-Summit Auto Co., Alliance, Ohio.

TO GET CASH quickly will sacrifice 1907 Thomas Flyer, 7-passenger touring car, New York-to-Paris Model, 60-H.P., absolutely perfect condition throughout; has top, glass front, trunk rack, slip covers, large Prest-O-Lite tank, Warner speedometer, Gabriel horn, clock, two extra shoes, two tire covers, tube case; finish automobile red, upholstering rub. P. O. Box 356, Reading, Pa.

TWO-CYLINDER, 30-H.P. Winton touring car, first-class condition; cheap for cash or might exchange. Particulars, address W. S. S., Box 13, Minoa, N. Y.

TWO-CYLINDER, 20-H.P., five-passenger automobile, equipped with Schebler carburetor, storage battery and headlights, in good condition throughout. W. J. Rickey, 1005 W. Washington St., South Bend, Ind.

WE WILL allow good price for your old car in exchange for new Frontenac. See them at our salesrooms, 1621 Broadway, near 50th St., New York. Abendroth & Root Mfg. Co.

WE HAVE for sale the following second-hand cars at bargain prices: 1907 Model D touring car; 1906 Model D touring car; 1907 Model G runabout, Franklin Automobile Company, 73d St., Amsterdam Ave. and Broadway, New York.

10-H.P., 1906, Model L Maxwell Runabout, \$200. 34-H.P., 1906, Lambert 4-cylinder car, runabout body, \$400. Butts, Oxford, New York.

1907 FOUR CYLINDER, seven-passenger Matheson car, thoroughly overhauled, in A1 condition; newly painted and varnished; will be sold at a great sacrifice. Inquire Maine Motor Carriage Co., Portland, Me.

1908 MITCHELL, five-passenger; perfect condition; fully equipped; \$1,000. W. W. Griffing, La Salle, Ill.

1908 BRUSH RUNABOUT, with 1909 transmission, in good condition, price \$250. 1906 Cameron runabout shaft drive, in good condition, price \$150. Box 73, Lemoyne, Pa.

Cars Wanted

A UTOMOBILES bought, sold, exchanged, sold on commission, or repaired; mail orders solicited. Hendry's 428 Golden Gate Ave., San Francisco, Cal.

PLEASE MENTION THE AUTOMOBILE WHEN WRITING TO ADVERTISERS

WANTED a touring car to hire for three months; can be shown at 43 Reynolds Terrace, Orange, N. J.

WANTED TO BUY—Two-cylinder Buick touring car; must be in first-class condition; state lowest cash price. Address "Buick," care The Automobile.

WANTED.—Four or five-passenger automobile. State year made, condition of tires, machinery and how equipped. Address 129 Van Buren St., Jamestown, N. Y.

WHO'S GOT four-cylinder National or Thomas car, 1908, to exchange for fine section North Dakota land at cash value; want for own use; will give good deal. Address Lock Box 29, Manlius, Ill.

WE WILL PAY full value in spot cash for your automobiles in quantities from one to one hundred. Call or mail descriptions. Broadway Mammoth Automobile Exchange, 245 West 56th St., New York City.

Garages For Sale

FOR SALE OR RENT.—Automobile garage, best location in city. 2552 Madison Ave., Baltimore, Md.

GARAGE in Washington, D. C.; capacity 20 cars; well established agency; long lease; permanent patronage; good reasons for selling. Address Box 10, care The Automobile.

SHENANDOAH Valley Garage, of Winchester, Va.; good business and location; further information, address N. S. Cooper, Winchester, Va.

Parts and Accessories

(FOR SALE)

AUTO TIRES—All the best makes of tires on hand at cut prices; a big stock of "specials" and "seconds" at "Bargain Counter Prices"; we will save you money on any make and any size; write or call. Broadway Mammoth Automobile Exchange, 245 West 56th St., New York.

AUTO Tire Repair Co. (not inc.), retreads and recovers run farthest. Exceptionally prompt service, good works, inviting prices. 1303 Michigan Ave., Chicago. Tel. Calumet 117. Largest dealers in "seconds repaired and slightly used tires and tubes" in the West.

AUTO TOPS, \$15; wind shields, \$13; 8-cylinder flying machine engine, \$300; 2-cylinder, 2-cycle, air-cooled engine, \$50; transmissions, \$18. Get our new list. Auto Parts Co., 52 W. Jackson Blvd., Chicago.

BARGAINS in lamps and repairing all kinds. J. C. Baker, 82 Public Square, Cleveland, Ohio.

BARGAINS—200 1908 folding wind shields; left-over stock, at cost of manufacture; will fit any car. Ogden Wind Shield Co., 1566 Ogden Ave., Chicago, Ill.

BARGAINS in new inner tubes; all guaranteed to hold air. Purchased at special sale:

28x2 1/2	28x3 1/2	30x4\$2.50
28x3	30x3	30x3 1/2 3.00
32x3 1/2	32x4	34x3 1/2 3.50
34x4	34x4 1/2	34x5 4.50
36x3 1/2	36x4	36x4 1/2 4.50

Write for prices on other supplies. We also repair any make of tire. All work guaranteed. Chicago Vulcanizing Co., 1400 Michigan Ave., Chicago, Ill.

BATTERY, 28 cells, National 9CB, 100 ampere, good condition, \$50. Address Box 275, Metuchen, N. J.

DON'T BE without a speedometer. I have a large number of slightly used speedometers (all makes) at very attractive prices, good as new. Let me know what make you want or send for lists. W. F. Whittaker, 513 West 145th St., New York City.

DRAGON REPAIR PARTS—We manufacture and keep on hand all repair parts for the Dragon cars. We make a specialty of repairing this machine. Philadelphia Machine Works, 67 Laurel St., Philadelphia, Pa.

EISEMAN magnetos for sale cheap. We have five four-cylinder and two six-cylinder Eise-man magnetos in perfect condition which we will dispose of at an exceptionally low figure if taken at once. Address Box 896, care The Automobile.

FORD RUNABOUT owners, now is the time to order your outfit to change your N. S. or R. into new "S" roadster, new fenders and rumble seats, dash hoods, folding hoods, glass fronts, tops, oilers, magnetos. Write for catalogue to-day. Auto Rebuilding Co., 1349 Michigan Ave., Chicago, Ill.

I OFFER my \$60 Jones speedometer for \$25; has never been used; this is a chance for somebody; first check takes it. L. France, 513 West 146th St., New York City.

RADIATORS, hoods, mud guards, metal dashes, gasoline and water tanks. If building or remodeling a car, it will pay you to write us, as we lead in this line. Auto Sheet Metal Works, 2230 Michigan Ave., Chicago, Ill.

RUMBLE SEATS and "baby" tonneaus, for Ford, Maxwell, Buick, Cadillac and other cars; fenders, radiators, hoods. We are the big mail-order rebuilding house. Send for catalogue. Auto Rebuilding Co., 1349 Michigan Ave., Chicago, Ill.

SECOND-HAND BARGAINS—4-H.P. Orient with two speeds in case, good as new, \$40; one 15-inch friction transmission, \$10; one 12-inch, \$9; one 4-H.P. Climax motor s. h., \$30. Climax Electric Works, New Salem, Mass.

SECOND-HAND and new rims, all kinds, 50c. up. Nadall-Van Sicklen Mfg. Co., 1233 Michigan Ave., Chicago.

TIRE SALE EXTRAORDINARY!—All brand new stock. Must sell; mail orders filled, subject to prior sale. Not the kind usually advertised.

Size.	Shoe.	Tube.	Size.	Shoe.	Tube.
32x4	\$3.75	28x2 1/2	\$7.50 \$2.00
34x4	18.00 4.00	28x3	9.00 2.25
34x4 1/2	19.00 4.00	30x3	10.00 2.50
34x5	18.00 4.00	30x3 1/2	13.00 3.00
36x3 1/2	12.00 3.00	32x3 1/2	15.00
36x4	16.00 4.00	34x2 1/2	12.00
36x4 1/2	16.00 4.00	30x4	3.50
		36x5	\$16.00; \$4.00	

A. H. Kasner, Oldest Tire Dealer in U. S., 152 Church St., New York City, near Chambers St.

WE HAVE on hand a full line of new and second-hand tubes at low prices. We sell and supply all makes of solid and pneumatic tires. Tire repairs our specialty. Chicago Tire Repair Co., Michigan Blvd., at 35th St., Chicago. Phone, Douglass 4592.

500 SECOND-HAND tires and tubes of all makes and sizes. Out-of-town orders given immediate attention. Repairing our specialty. Illinois Tire Co., 3111 Michigan Ave., Chicago, Ill.

1905 PACKARD chassis, \$50; Packard crankshaft, cylinders and camshaft, \$50; steering gear, \$15; pair front hubs, \$10; Stoddard-Dayton shaft drive new construction, \$60; Cadillac single cylinder new engine, \$125. Auto Repair Company, 813 N. Broad St., Philadelphia, Pa.

Parts and Accessories

(WANTED)

WANTED.—A 16 or 20-H.P. opposed second-hand engine. Fred Selby, Moberly, Mo.

Situations Wanted

A YOUNG man of 29, thoroughly experienced in sales and advertising work, with one of the largest automobile manufacturing firms, wishes to make a change. Correspondence invited. Box 177, care The Automobile.

EXPERIENCED chauffeur and repair man wants position on White steamer or in garage; have Massachusetts license. Irving Paul, School St., Worcester, Mass.

FIRST-CLASS DRIVER, 11 years' experience, machinist by trade, desires to drive cars in long runs or take up road or track racing. Address "W. S.," care The Automobile.

MECHANIC, practical auto repair, general worker, competent, good references, desires position. Address "Mechanic," care The Automobile.

SALESMAN.—I have traveled extensively on business for ten years; now I wish to enter the automobile field, selling them; good appearance, address and business reference. Address "Whitehall," care The Automobile.

TO AUTOMOBILE MANUFACTURERS.—Party well equipped to handle automobiles, with large exhibition rooms and garage wishes agency as follows:

Four-cylinder shaft-driven runabouts to sell for \$750 or under.

Runabout and touring cars to sell for \$850 or under, four-cylinder, shaft-driven.

Runabout and touring cars to sell for \$1,000 or under, four-cylinder, shaft-driven.

Runabout and touring cars to sell for \$1,250 or under, four-cylinder, shaft-driven.

Touring car to sell for \$1,500 or under, four-cylinder, shaft-driven.

Must be in 60-inch tread and 1910 models. Enclose specification and address "Distributor," care The Automobile.

Help Wanted

AGENTS WANTED—We have several White cars on hand, taken in trade for new models and since overhauled and refinished in our own shops. They are for sale at bargain prices and we will give attractive commissions to out-of-town dealers. Our stock includes 5 and 7-passenger touring cars and limousines. Write us for full details. The White Co., 62d St. and Broadway, New York City.

A HIGH-CLASS office man, large previous experience in handling correspondence, traveling men, etc. Excellent and permanent position for right man. Advise qualifications, etc. Timken Roller Bearing Axle Co., Canton, O.

AN EXCEPTIONAL opportunity is offered to a salesman calling upon the Automobile trade to handle in restricted territory a beautiful, rich, imported mat for covering the floor of tonneau or limousine. Address, giving qualifications, to J. M. Shoemaker, Imp., 270 Canal St., New York.

WANTED exclusive sales agency for New York and vicinity to handle first-class line of spark plugs now enjoying a good sale in the West. Address Auto Specialties Mfg. Co., Milwaukee, Wis.

WANTED.—Shop superintendent; must have experience in building the highest type of gasoline car and thoroughly competent to organize and handle men, also to establish a system of cost; a fine opening to the right man. Address "Superintendent," care The Automobile.

Repairing

AUTOMOBILE TIRES rebuilt, retreaded, relined, rim cuts and blowouts repaired, inner tubes repaired and respiced; all work thoroughly tested before shipment and fully guaranteed. Thomas Rubber Vulcanizing Co., 227 South St. Joseph St., South Bend, Ind.

COIL REPAIRING.—Is your coil in first-class shape? Ship it to us. We overhaul them and repair them; work guaranteed for two years; experts in charge of this department. Marinette Electrical Repair Co., Marinette, Wis.

TIRES REPAIRED.—Automobile owners, do you want your tires repaired or recovered by the people who know how? Give us a trial and be convinced. Inner tubes vulcanized at short notice. Juggkind & Vogler, 158 Chambers St., New York City. Telephone, 3386 Cortlandt.

Auto Schools

MEN from all parts of the U. S. are taking automobile instruction. A four weeks' course in July, morning, afternoon or evening. Send for booklet. West Side Y. M. C. A. Automobile School, 310 West 57th St., New York.

THE STEWART Automobile Academy, 231 West 54th St., New York; most modernly equipped motoring school in city; 1908-1909 motors, chassis and ignition systems; educated, practical instructors; for owners, prospective owners, women; separate courses for chauffeurs; modern cars for road work. Special rates for June, July, August. Telephone 5409 Columbus.

(Special Notices continued on page 48)

PLEASE MENTION THE AUTOMOBILE WHEN WRITING TO ADVERTISERS

(Special Notices continued from page 47.)

THE AUTOMOBILE INDUSTRY will soon be one of the largest in the country. No other industry can compare with its rapid development. There are unlimited opportunities for men in this new business. There is at the present time a big demand for trained men. If you are ambitious and want to get ahead, ask for our new booklet, "The New Profession for Men," N. Y. S. A. E., 145 West 56th St., New York.

Insurance

FIRE, theft, liability, collision, accident, property, damage, and transportation, fully covered, lowest rates. Colman Company, 185 Broadway. Phone, Cortlandt 3766, New York.

INSURANCE for Automobiles—Broad, safe policies at lowest prices; insurance against fire, self-ignited explosions, transportation hazards, theft, etc.; best services guaranteed, no matter where insurer is located. For particulars address W. H. Beals, 76 William St., New York City. Phone, 3052 John.

Books

"AUTO ECONOMY."—A unique little booklet which fits the pocket and means much to one interested in automobiles. Copy mailed free on request. Get it now. Auto Economy Co., 1426 Michigan Ave., Chicago, Ill.

THE AUTOMOBILE REPAIR GUIDE. New illustrated edition; provides for every emergency that may arise during the use of the car. Also contains automobile and motor boat laws. Technical terms are carefully avoided. Used by over 30,000 owners and chauffeurs. Price, 25 cents postpaid. Wm. B. Sanderson, Pub., 1265 Broadway, N. Y.

Miscellaneous

A PAYING taxicab and garage business located in N. Y. State; will explain to parties interested why business must be sold at once; excellent opportunity for right party. Address J. D., care The Automobile.

CONCERN manufacturing automobile accessories is open to considering the manufacture of any specialty or royalty or otherwise. Address Box 2153, Boston, Mass.

HIGH-CLASS wall paper store doing prosperous business, or will incorporate with first-class business man who will take management; sickness compels me to change climate; business nets over \$3,000 per year. (No agents.) W. N. Hanford, 642 Main St., Peoria, Ill.

IF YOU HAVE A GARAGE to heat, get our boiler catalogue with manufacturers' prices. American Home Supply Co., 111 West 125th St., New York.

STEAM CAR OWNERS.—Send for sample of engine and pump packing. R. A. Robbel, 221 East 31st St., Chicago, Ill.

GUN METAL YOUR BRASS.—Arsenal Liquid Gun Metal makes a gun metal enamel on brass and can be removed at any time without injury to lamps or radiator. The letter below will give you an idea of its popularity:

"Minneapolis, Minn., May 19, 1909.
"Arsenal Varnish Co., Rock Island, Ill.
"Gentlemen: Please send us 1 dozen cans of your Gun Metal by express at once. The sample can which we received a few days ago seems to be very satisfactory. It strikes the popular chord. Kindly give this immediate attention.
"Very truly yours,
"Maxfield Automobile Co."

If your dealer cannot supply you, send us \$1 and we will forward a can prepaid. Arsenal Varnish Co., Rock Island, Ill.

SHINEBRIGHT METAL POLISH is absolutely the best on the market; sample and quotation furnished upon request. Shove & Gage Co., Inc., Providence, R. I.

U-AUTO POLISH will keep the varnished parts of your automobile or carriage in excellent shape. Address Shove & Gage Co., Inc., Providence, R. I., for sample.

WANTED.—Automobile garage, portable, for runabout; state condition, size and price. Dr. Alfred C. Smith, Brockton, Mass.

SUBSCRIBE FOR THE AUTOMOBILE WEEKLY—THREE DOLLARS A YEAR

SEE PAGE 67—JUNE 17 ISSUE

LOOK AUTO OWNERS! BEGINNERS, CHAUFERS! MASTER THE AUTOMOBILE

Study during spare time at home.
Dyke's Course of Auto Instruction only \$10.00 now.
This Course is not one of theories, but rather a practical application of theories. I know it is the most practical and Comprehensive Correspondence Course in existence on the subject of the Automobile Construction. But this did not content me. I wanted a system of instruction that would surpass the training given by resident as well as other Correspondence Schools. The addition of the Working Models gives the Course unquestionable supremacy.



Different From a Book.
"Your Course of instruction on the Automobile purchased by me recently was beyond my expectations. I have read several Automobile Books, but this Course I find is different from matter obtained from reading a book. I find the instruction books prepared are so simple and plain that anyone can learn all about the Automobile with very little effort. The Working Models are helpful in picturing the details and further simplify the subject. The entire Course is interesting and instructive and the amount I paid you has been well invested.
Yours truly, C. B. CARTON.
Liberal Trial Offer. Testimonials from all.

FREE THIS AUTO BUTTON AND INSTRUCTIVE PAMPHLET SEND FOR IT TODAY
DYKE'S COURSE SCHOOL MOTORING 1103 BANK COMMERCE BLDG. ST. LOUIS

A. B. C. OF MOTORING

By SIGMUND KRAUSZ

A MANUAL of practical information for layman, auto novice and motorist, containing dictionary of terms, types of cars, anatomy of the automobile, motors, carbureter, ignition, cooling, tires, transmission, etc. Care of the machine, art of driving, troubles of the road, etiquette of automobiling, racing rules and statistics, foreign travel, clubs, manufacturers, trade papers, speed tables, and complete digest of motoring laws of thirty-five States and names of those having no laws.

Morocco Cover : : : Two Dollars
The CLASS JOURNAL COMPANY
231-241 West 39th Street, New York

NOW ON SALE

AUTOMOBILE CATECHISM

For the Use of Owners and Drivers of Cars Fitted with Internal Combustion Motors

By FORREST R. JONES, M.E.
President of the Manhattan Automobile School

THIS is the most practical, up-to-date work on the subject in the English language. It is published in pocket-book form, with high grade leather cover, and printed on especially tough paper, as it is intended to be the inseparable companion of the autoist when on tour. Not a line is wasted on obsolete constructions or descriptions of unfamiliar apparatus. It treats of the automobile in modern form and of all the troubles that may arise in the course of ordinary use and that may be remedied by the driver himself. It is written in plain language and is the most helpful, authoritative and comprehensive manual that has yet appeared. The subject-matter is in the form of question and answer, and an exhaustive cross index makes immediate reference possible in any particular case.

Size, 4 1-2 by 7 inches. Pages, 134.
With Drawings.
Price in genuine Morocco Cover, gilt edges, \$2.00
Including postage.

Order from the publishers
THE CLASS JOURNAL COMPANY
231-241 West 39th St., New York City.

The Wyman & Gordon Co.
MAKE
DROP FORGINGS
THAT ARE STRONG
FORGED WITHOUT WELDS
WORCESTER MASS. CLEVELAND OHIO.

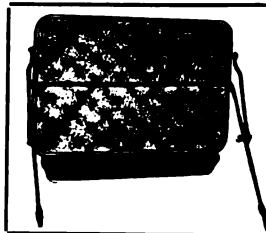

LINCOLN WIND SHIELD

(Folding Front)
French plate glass, polished brass tubing and will fit any car.
Price \$30. (Attached to car.)
PORTLAND divided drop shield, \$35.
Send for circular to-day giving guarantee.
Bi Motor Equipment Co., Boston, Mass.

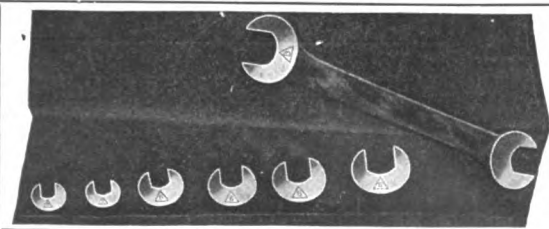

THIS IS THE WRENCH

we are listing in sets of seven (14 openings) from 7/16" to 1 1/4"; cut shows section of kit. We also put up these wrenches in millimeter sizes for use on foreign made cars. They are drop forged of just the right steel, for hard usage. Put up in canvas or drill bags. Write for circular of prices.

THE BILLINGS & SPENCER CO., Hartford, Conn.



PLEASE MENTION THE AUTOMOBILE WHEN WRITING TO ADVERTISERS

OUTFITS AND SUPPLIES



Tire Troubles? Use Permant
Demonstrated before Board of Governors Harrisburg Motor Club with great success.
For particulars write
THE ADOLPH KARL CO.
241 Washington St.
Newark, N. J.

J. H. LEHMAN MFG. CO.
170 Broadway, New York
Lehman Distributors and Timers
The "FULMINA"
High-Tension MAGNETO
All Types

CANDY CARBIDE
Trade Mark
No more trouble with generators. Sold only in 10-lb. cans, with green labels. Price \$2.00 each, from all Auto Supply Houses. A 10-lb. can, 3"x12", will make gas enough to fill up two of the largest gas tanks in the market.
ACETYLENE GAS ILLUMINATING CO.
405 Broome Street, New York.

LIFE

In the greatest medium for selling Automobiles and Accessories. I have figures which prove my claims. Address,
George B. Richardson, Manager Advertising Department.
LIFE PUBLISHING CO., 19 W. 31st St., New York City

THE Loring
SPEED-GAUGE
FOR AUTOMOBILES AND MOTOR CYCLES
Write for Catalogue
Loring Auto Appliance Co.
42 W. 43d St. New York City

SUBSCRIBE FOR THE AUTOMOBILE WEEKLY—THREE DOLLARS A YEAR



METAL POLISH
Highest Award
Chicago World's Fair 1893; Louisiana Purchase Exposition, St. Louis, Mo., 1904.
3-oz. Box for 10 cents. Sold by Agents and Dealers all over the world. Ask or write for free samples.
5-lb. Pails, \$1.00
GEO. W. HOFFMAN
Expert Polish Maker
Indianapolis, Indiana.
Sold by Dealers.
New York City Office.
1-3 Park Row.

STA-RITE (Trade Mark)

Ignition Plugs are now repaired perpetually, free of charge (when returned to factory) because "They Stay Right the Longest"
The E. E. HARDY CO., Incorp. 1900
Factory, 203 37th Street, Brooklyn, N. Y.
309 Fisher Building, Chicago
Half-Finch Separator-Double Porcelain Plug.
Price \$1.25

REMOVE
Fly Wheels, Cam, Gear or Sprocket instantly with
CRANE PULLER
Thousands in use. 2 or 3 arm
CRANE PULLER,
1089 Commonwealth Ave., BOSTON, MASS.

CHARGE your ignition battery at home from an alternating current with a
SIMPLICITY RECTIFIER
Cheap, durable and efficient; saves your time, money and battery.
THE AUTO & SUPPLY MFG. CO.
2368 Woodhill Rd., Cleveland, O.

Any Thread
75c
Postpaid
BUY A FRY
Strength—Simplicity
Ask your Dealer,
STANDARD SALES COMPANY,
Broadway and 57th St., N. Y.

TRY IT AND BE GLAD
"GLOBE" METAL POLISH
A SHAKE, A RUB AND YOUR SHINE IS THERE
RAIMES & CO. Ferry St., NEW YORK

Test your batteries with a meter that is accurate, durable and guaranteed
ROBERT VOLT-AMMETERS, \$6.00
" VOLT-METERS, \$4.00
" AMMETERS, \$4.00
including leather case.
Send for catalog
Robert Instrument Co.
66 Shelby St., Detroit, Mich.

"THE KING OF NOISE-PRODUCERS"
THE SIRENO HORN
THE SIRENO COMPANY
39-41 Cortlandt Street New York City

23,500 MAGNETIC
TRIUMPH GAGES
Now in Use. Order One To-day!
Boston Auto Gage Co.
10 Waltham St. BOSTON, MASS.

Automobile Wheels and Axles
SALISBURY WHEEL & MFG. CO.
MANUFACTURERS
JAMSTOWN, NEW YORK

1910 CARS
will require Tucker Oil Hole Covers. Manufacturers send for sample and prices now.
C. F. TUCKER, Hartford, Conn.

ESTABLISHED 1844.
SCHRADER
UNIVERSAL VALVES
TRADE MARK REGISTERED APRIL 30, 1895.
The Standard Automobile Valves for Automobile, Bicycle & Vehicle tires
Manufactured by
A. SCHRADER'S SON, INC.
28-32 Rose St. New York, U.S.A.

If you want good circulation on your automobile, launch or motor boat, use a
LOBEE PUMP
LOBEE PUMP AND MACHINERY CO.
130 Terrace, Buffalo, N. Y.

GIVE IT A TRIAL
The Raymond Brake
Simple—Strong—Sure
ROYAL EQUIPMENT CO.
155 Newstate Ave. Bridgeport, Conn.

WHEN WRITING TO ADVERTISERS PLEASE MENTION THE AUTOMOBILE.

Instruments that are made to STAY accurate
Eldredge Battery Voltmeter
For either primary or storage batteries. An instrument you can depend on. Dealers have them, Jobbers have them We have them
Eldredge Electric Mfg. Co.,
19 P. O. Square, Springfield, Mass.

AUTO NEW YORK GOODS
17 WARREN ST. NEW YORK
SEND FOR CATALOG.

The No-Shammy FUNNEL
Guaranteed to remove ALL WATER and DIRT from Gasoline. Price \$2.00. If your dealer cannot supply you we will ship direct prepaid.
ASTRO-AMERICAN SEPARATOR CO.
5717 Hough Av., Cleveland, O.

HOYT
Electrical Instrument Works
HOME OFFICE AND FACTORY:
PENACOOK, NEW HAMPSHIRE
BRANCHES:
101 Summer St., Boston, Mass. 1031 Broadway N.Y. City

PLEASE MENTION THE AUTOMOBILE WHEN WRITING TO ADVERTISERS



Drive Chains and Sprockets
of all kinds for
Automobiles
Baldwin Chain & Mfg. Co. Worcester, Mass.

Automobile Gears



If in a hurry, wire us
R. D. Nuttall Company
Pittsburg, Pa.

Standard Bearings
Stand The Test
27,000 miles continuous service without a replacement proves their superiority.
Standard Roller Bearing Co.
Philadelphia, Pennsylvania

SPECIAL DROP FORGINGS
IN QUANTITIES
Chrome Nickel and all Special Steels
Oil Treating and Annealing
THE CANTON DROP FORGING AND MFG. CO.
CANTON, O., U. S. A.

PARISH & BINGHAM
PRESSED STEEL
FRAMES ARE STANDARD
WRITE FOR ESTIMATES
CLEVELAND, - OHIO

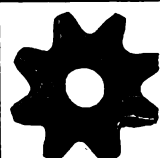

CULLMAN SPROCKETS
and Differentials in stock and to order also, Baldwin, Diamond and Whitney Chain.
CULLMAN WHEEL CO.
1027 Dunning St., Chicago

Send for new Catalog

HILL'S IMPROVED AUTO SPECIALTIES
Drip Pans, Measures and Funnels for Oil and Gasoline—Oily Waste Cans, etc.
Estimates furnished on special work
Dealers, write for our 1909 proposition
HILL DRYER COMPANY,
Worcester, Mass.

PRESSED STEEL
OTTO KONIGSLOW MFG. CO.
CLEVELAND

100 Manufacturers
Using and Testing
INDESTRUCTIBLE STEEL WHEELS
O. K. them in every way. Write us for information
INDESTRUCTIBLE STEEL WHEEL CO.
1224 Michigan Ave. CHICAGO

CORK INSERTS
For particulars apply to the
OWNER and PATENTEE
The NATIONAL BRAKE & CLUTCH CO.,
16 State St., BOSTON, MASS.

PEUGEOT CHAINS "Strongest in the World"
232 W. 58th STREET,
NEW YORK.

HERSCHELL-SPILLMAN MOTORS
AUTOMOBILE and MARINE
16-18; 24-30; Vertical Four and
45-55 H. P. Six Cylinder Types
HERSCHELL-SPILLMAN CO.
North Tonawanda, N. Y.

Quality Counts
There are many reasons for the popular endorsement of the BROWNELL Gasoline Motors. Ask any user, or write us, and we will tell you all about it.
4, 6 and 8 Cylinders. 14 to 180 H. P.
F. A. BROWNELL MOTOR COMPANY
634-686 Lexington Ave., Rochester, N. Y. ©

AUTO-TOP FABRICS OF EVERY DESCRIPTION
SAMPLES AND PRICES ON REQUEST
L. J. MUTTY CO., Boston

We can prove that
"The Duplex"
is superior to any Carburetor you ever saw or used
Write to Us To-day
THE DUPLEX COMPANY, BELFAST, MAINE.

SPICER UNIVERSAL JOINTS
Dust Proof—Oil Tight
SPICER UNIVERSAL JOINT MFG. CO.
7 Madison Avenue PLAINFIELD, N. J.
K. Franklin Peterson, 160 Lake St., Chicago, Ill.
L. D. Bolton, 519 Hammond Bldg., Detroit, Mich.
Thos. J. Wetzel, 17 W. 42nd St., New York City

AUTOMOBILE BODIES
in all styles, in the white or finished complete. Aluminum or wood panels
SCHUBERT BROS. GEAR CO., Oneida, N. Y.

The Complete Motorist
No theory, but all about an automobile—its history; its mechanism and how to select and run it. By A. B. FILSON YOUNG. 328 pages, profusely illustrated. Bound in cloth. Price, \$3.50. Address The Automobile, 231-241 West 39th Street, New York.



DIAMOND CHAINS
SAVE POWER
STRONG ACCURATE DURABLE
WE MAKE CORRECT SPROCKETS
DIAMOND CHAIN & MFG. CO.
230 W. Georgia St., INDIANAPOLIS, IND.

BULLET-PROOF
Inner Tube Protecting Webbing
3-inch 25c. per yard 4-inch 40c. per yard
WABAN WEBBING CO.
Boston, Mass.

WOOD BOWS for AUTO TOPS
S. N. BROWN & CO.
DAYTON, OHIO



\$14.00 and upwards
AUTOMOBILE Write for catalogue and prices
TOPS BUOB & SCHEU
1655 Court Street
Cincinnati, Ohio



Pure PS&Co Red
SEAMLESS
INNER TUBES
NOT THE CHEAPEST BUT THE BEST TUBE MADE
IMPORTED BY DOMESTIC
FARRIS, STEAMERS & COMPANY
286 SHEFFIELD AVE., BROOKLYN, N. Y.

PLEASE MENTION THE AUTOMOBILE WHEN WRITING TO ADVERTISERS



A Paradox - The ADAMS-FARWELL is air cooled and has light valves, but they never warp or need grinding. Get posted.

The Adams Co., Dubuque, Iowa

A SUPERB LINE OF CARS - The JACKSON
"No Sand too Deep - No Hill too Steep"
 2 Cyl. and 4 Cyl.
 Runabouts, Roadsters, Touring Cars
 18 H. P., 24 H. P., 30 H. P. and 36 H. P.
 Prices: \$850, \$950, \$1,250, \$1,600, \$2,000
Jackson Automobile Co., Jackson, Mich.

AJAX TIRES
 GUARANTEED FOR 5,000 MILES
Ajax-Grieb Rubber Company
 N. E. Cor. 57th St. and Broadway N. Y. City
 Factories: Trenton, N. J.

Cadillac "Thirty" \$1400.00
 The car that established a new standard in Automobile Values
Cadillac Motor Car Co., Detroit, Mich.

SEND 10c. For set of 12 Post Cards of the Locomobile Winning Vanderbilt Race.
 SEND 10c. For 11 color poster of The Finish of This Race.
The Locomobile COMPANY
 BRIDGEPORT, CONN.

Wheels fitted with
Continental
[Demountable Rims]
 in one week's time. Inquire of your nearest dealer
CONTINENTAL CAOUTCHOUC CO.
 1788-90 Broadway New York City

The Greatest Value Ever Offered
\$2,250
 4 Cylinder 35 H.P. Motor
Cornish-Friedberg Motor Car Co.
 1233 Michigan Avenue CHICAGO

THE MARMON
"A Mechanical Masterpiece"
The Easiest Riding Car in the World
 BUILT BY
NORDYKE & MARMON CO.
 Established 1851 INDIANAPOLIS, IND.
Write for Catalog.

DAYTON AIRLESS TIRES
 Try one Dayton Airless and you will do as hundreds of others have done—give your car a complete Dayton equipment at once or as your pneumatics go to pieces. Write for the literature, and what a few of the hundreds of delighted Dayton owners say.
THE DAYTON RUBBER MFG. CO., 1204 Kiser St., Dayton, O.
 New York: 1595 Broadway

We manufacture without doubt the **Best Transmission Axle in America.**
 Why not give us an opportunity to prove this?
Covert Motor Vehicle Co.
 Lockport, N. Y.

MoonCars
 IF YOU HAVE NOT SENT FOR OUR CATALOGUE DESCRIBING OUR WONDERFUL LINE, WRITE ME AT ONCE
MOON MOTOR CAR CO., ST. LOUIS, MO.
 Jos. W. Moon, Pres.

MICHELIN
 Michelin Tires are made in America, England, France, and Italy. It is granted that they are the best that brains can make or money buy. Sold in every country in the world where cars are used.
MICHELIN TIRE COMPANY
 Milltown New Jersey

Write for Our Large **Souvenir Catalog**
THE DE-LUXE MOTOR CAR CO.
 DETROIT MICH.

OLDSMOBILE
 You see them wherever you go
 They go wherever you see them
OLDS MOTOR WORKS
Lansing, Mich.
 MEMBERS A. L. A. M.

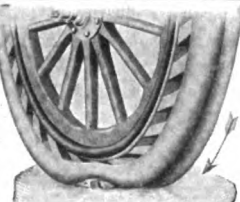

MOTZ CUSHION TIRES
 are puncture proof, resilient and there with the wear. What more can you ask? Fit clincher rims. Our tool applies the tire. Book-let J.
THE MOTZ CLINCHER TIRE & RUBBER CO.
 AKRON, OHIO.

PITTSBURG SIX FOR 1909 NOW READY
 6 Cylinders. 70 Horse Power. Fully Equipped. 3 Models
\$3,000 \$3,200 \$3,500
 Send for Catalog
FORT PITT MOTOR MANUFACTURING CO.
 New Kensington, Pa.

PALMER SINGER
PALMER & SINGER MFG. CO.
 1620-22-24 Broadway, New York
 1321 Michigan Ave., Chicago, Ill.

It's aggravating when your auto won't start
 It's dangerous when it won't stop
 USE
THERMOID BRAKE LINING
Trenton Rubber Mfg. Co., Trenton, N. J.

ABENDROTH & ROOT MFG. CO.
 1621 Broadway (near 50th St.) NEW YORK
FRONTENAC
 Pleasure Cars & Gasoline Commercial Trucks
 Can deliver immediately
 Touring Cars and Runabouts.
 AGENTS WRITE FOR PROPOSITION

REO \$500 and \$1000
 Gets-there-and-back, every day in the year, and that's what counts most. Send for catalogue.
R. M. OWEN & CO., Lansing, Mich.
 General Sales Agents for the REO Motor Car Co.

SILENT VICTOR
 Best anti-skid in the world, must be kept on tight, thereby not injuring the tire.
VICTOR TIRE TRACTION CO., Nashua, N. H.
 Excelsior Supply Co. Distr's, Chicago. W. J. Connel, Agt., Boston

THE GRAMM-LOGAN MOTOR CAR CO.
 ROWLING GREEN, OHIO
 Write for Circular describing our several models

Induction Coils
 Gives easily understood explanations of the operation of coils. Of great value to the autolst. By H. S. NORRIE. 265 pages. Numerous illustrations. Cloth bound. Price, \$1.00. Address The Automobile, 231-241 West 39th St., New York.

Let us send you a **DUPLEX COIL** to use on your car 30 days free in place of your present coil. If the Duplex Coil doesn't cure 90% of your engine troubles, send it back collect, and replace your old coil. Write on your business stationery, giving name of car, number of cylinders, and any good references and we'll send you a Duplex Coil by first express.
 Address Station N,
DUPLEX COIL CO., Fond du Lac, Wis.

PLEASE MENTION THE AUTOMOBILE WHEN WRITING TO ADVERTISERS



No Tire Troubles Whatsoever

The Philadelphia-Pittsburg
Endurance Run Was Another Victory

for

GOODRICH TIRES

Which Equipped Winning "Franklin" Car

Again, and again, and again, Goodrich Tires
prove as well as claim superiority

The B. F. GOODRICH CO., Akron, Ohio

The Largest in the World

Branches in All Large Cities

Rims branded in
the channel with
this copyrighted
mark have been
inspected and
pronounced per-
fect.



REG. U. S. PAT. OFF.

We guarantee our
rims only on tires
so branded.

A Triumph in Durability for Diamond TIRES

Their service record in both the Cobe and Indiana Trophy Races was unequalled, confirming the official tire test of the Chicago Automobile Club, when Diamond won over all comers with 200 per cent. margin.

With Diamond Demountable Rims

Lytle, driver of Apperson No. 8, changed a tire in 18 seconds. Best time made with any competing rim was 60 seconds.



We guarantee our tires only when on inspected rims. See that rims bear mark of inspection, as shown herewith.

THE DIAMOND RUBBER CO.

AKRON, OHIO

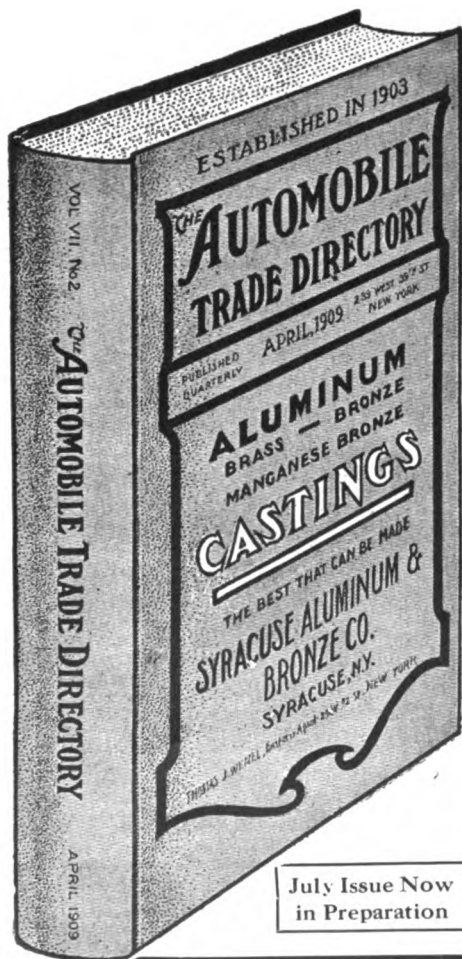

July Issue Now in Preparation

AMERICA'S Recognized Guide for those who Recommend, Specify and Buy practically all Material and Appliances used in this great and growing industry.

The most logical, economical and efficient medium for the use of manufacturers in the field it represents. The Automobile Trade Directory offers *the one* opportunity for the presentation of advertising to every buyer in this tremendous field—right at the psychological buying instant.

If there is any direct advertising merit in a publication with a circulation radius of action covering every possible buying unit in the United States—

If there is any business-bringing opportunity offered by a publication that is consulted daily, year in and year out, by buyers in the field in which you seek business—then THE AUTOMOBILE TRADE DIRECTORY will commend itself to your business judgment just as it has gathered over six hundred self-selective advertisers in the past seven years.

Advertising rates and full particulars sent on request.

THE AUTOMOBILE TRADE DIRECTORY

231-241 West 39th Street, New York, N. Y.

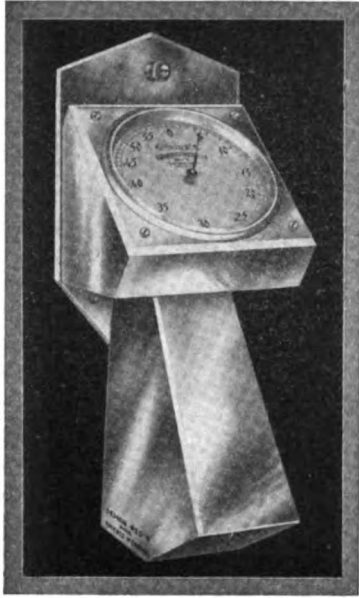

KIPLING'S GRADOMETER

PRICE
35.⁰⁰

Express Prepaid

WHAT IT IS

Design Reg'd and
Pat's Pending

It is the only instrument on the American market that records the "grade of hills"—and it records them to the fraction of 1%.
As in Railroad Recording it shows the PERCENTAGE OF GRADE—number of feet, rise within 100 feet—the standard measurement of all grades.
It is of highly finished brass, and of a registered design vastly different from any other motor fitting—an ornament to any car. It measures 7 inches high with a 2½-inch silvered dial, and in itself is complete—requiring only 3 screws to attach it to the Meter board.

WHAT A USER SAYS

Never before did I know hills were as interesting, but find the GRADOMETER now the most valuable accessory on my car.
It never grows monotonous, but proves mighty interesting to see how steep a hill I can climb on my first gear, and renews the interest again, when I switch to my intermediate, or low.
The ladies too watch the dial, and have great fun in guessing the grade, and often wager on what gear I must use to climb it.
I figure it has doubled our pleasure of motoring; it dispenses with guesswork and allows me to speak with positive authority on the grade I take, and I am very enthusiastic in its praise.

On Sale In—

ENGLAND
Sam'l Buckley & Co.
2 Soho Square, London

CANADA
Toronto Brass Mfg. Co.,
Toronto, Ontario

UNITED STATES
American Branch
Sam'l Buckley & Co.
225 Fifth Ave.
New York, N. Y.

Write to-day for booklet or tear out this page, and order for quick delivery.

Jobbers and Dealers—

Inquire for terms, as we can distribute to only a few of the larger centres this year.

Did You Ever Stop To Think

what caused that last blow-out in your casing? The tire was rotten. Yes, rotten.

Dirt and water had been forced into a cut, may be a mighty small one, that you had neglected to make impervious to dirt and water by filling up with new, live Para Rubber and Vulcanizing.

You didn't have a



"An Ounce of
Prevention"

The only portable vulcanizer that heats evenly and will not burn the repair in one spot and under-cure it in another. We guarantee the repairs to outlast the tire

The Tire Hand Book, "Care and Repair of Tires," free on request

C. A. SHALER CO. BOX R WAUPUN, WIS., U.S.A.

PLEASE MENTION THE AUTOMOBILE WHEN WRITING TO ADVERTISERS

The Automobile Handbook

A practical book for owners, operators, and mechanics. Includes road troubles, motor difficulties and other contingencies and how to handle them. By L. ELLIOTT BROOKS. 320 pages. Numerous illustrations. Full leather, limp. Price, \$1.50. Address The Automobile, 231-241 W. 39th Street, New York.

Sparks in Oil.



The Baker Multiple Point Enclosed Ignition Chamber Spark Plug

You, whose engine gives you oil troubles, try a "Baker." A permanent fixture—always clean—no bother, does not foul or short circuit.

Money refunded if Order one to-day and try it. not satisfactory.

THE
Baker Manufacturing Co.
(Inc.) 192 EAST ST., NEW HAVEN, CONN.

To obtain the best results use

COLONIAL MOTOR OIL

Ask for it. Try it.

Manufactured expressly for the use of automobiles by

BORNE, SCRYMSER COMPANY

NEW YORK BOSTON FALL RIVER PHILADELPHIA

AUTOLINE The Perfected Lubricating Oil for all types of Automobiles and Motor Boats.

TRADE MARK

"Ask the Garage Man for it." Will not Carbonize or Soot. Manufactured by

WM. C. ROBINSON & SON COMPANY

MAIN OFFICE, BALTIMORE, MD.

BRANCHES: Boston, Mass.; Philadelphia, Pa.; Pittsburg, Pa.; Cincinnati, O.; Indianapolis, Ind.; Terre Haute, Ind.

AUTOMOBILE TURNTABLE

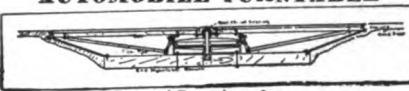

Patented December 28, 1905

The easiest running table made. Built strong, and the heaviest cars can be turned with ease.

Price of wood construction: 10 feet, \$175; 12 feet, \$200; and 15 feet, \$250.

Price of steel construction: 10 feet, \$200; 12 feet, \$275; and 15 feet, \$350.

Portland Garage Co., Portland, Me.

SPECIFY

STANWOOD STEPS

FACTORY SALES CORP'N

CHICAGO, ILL.

The Practical Gas Engineer

WHAT TO DO AND HOW TO DO IT.

A book of 150 pages, neatly bound in cloth. Sent postpaid for \$1.00. Address The Automobile, 231-241 W. 39th Street, New York.

Panhard Oil

"The Oil in the Checkered Can"

IS A 100% LUBRICANT

It will not char nor carbonize, doesn't gum the cylinders, prevents pitting and loss of power.

SAVES YOUR AUTOMOBILE

GEORGE A. HAWS, 76 Pine Street, New York

AUTOMOBILE RECORD

By SIGMUND KRAUSZ

EXPENSE account for fifty-two weeks, with columns for cost of gasoline, carbide, kerosene, repairs, replacements, daily runs, chauffeur's salary, garage expenses, speed record, starting point, destination, motor laws of thirty-five States and names of others having no laws. Totals of expenses and runs for any period shown at a glance.

MOROCCO COVER, ONE DOLLAR

The CLASS JOURNAL COMPANY
231-241 West 39th Street, New York

Comfort without Extravagance

Hotel Woodstock

127 West 43^d St., New York.

H. H. Valiquette, Manager.

Rooms, with bath, \$2.50 to \$3.50
Suits, \$5.00 to \$6.00



TIMES BUILDING TIMES SQUARE HOTEL WOODSTOCK

D & C LAKE LINES

GREAT LAKE TRIPS

All ports on the Great Lakes are reached regularly by the excellent service of the D & C Lake Lines. The ten large steamers are safe, speedy and comfortable. Every boat is of modern steel construction and equipped with the Clark Wireless Telegraph Service. The D & C Lake Lines operate daily trips between Buffalo and Detroit, Cleveland and Detroit, four trips per week between Toledo, Detroit, Mackinac and wayports, and two trips per week between Detroit, Bay City, Saginaw and wayports. Special steamer leaves Cleveland twice a week direct for Mackinac, stopping at Detroit every trip and Goderich, Ont., every other trip. Send two cent stamp for illustrated Pamphlet and Great Lakes Map.

Address: L. G. Lewis, G. P. A., Detroit, Mich.

RAIL TICKETS AVAILABLE ON ALL STEAMERS

P. H. McMILLAN, President
A. A. SCHANTZ, Gen. Mgr.

DETROIT & CLEVELAND NAVIGATION CO.



HAM'S LIMOUSINE

Manufacturers who are particular about their equipment are furnishing

HAM'S "COLD BLAST" AUTOMOBILE LAMPS

They cost him more, but the satisfaction is worth the difference.

If you don't get them it's your fault. Let us send you one of our Handsome New 1909 Catalogues. Address "Dept. B."

C. T. HAM MFG. CO.
ROCHESTER, N. Y.

PLEASE MENTION THE AUTOMOBILE WHEN WRITING TO ADVERTISERS

Give Your Car a Turkish Bath

Lucas Auto-Klean makes the Automobile sparkle from tire to roof with freshness and perfect cleanliness.

Instantly removes dust, grease and grime.

Its touch of velvet restores the original brilliancy of the polished parts—wood, metal or fabric—without the slightest injury.

Our manufacturing reputation of over 60 years is back of this product.

Test our statements by using a small can. We are anxious to accept your verdict.

Prices (Discounts to Dealers)

- 1 Gal. DUST-PROOF Cans, \$2.50 each
- ¼ " DUST-PROOF " 1.00 "
- 1 Pint DUST-PROOF " .60 "
- ½ " DUST-PROOF " .35 "

Write for descriptive folder and name of dealer or garage in your vicinity.

John Lucas & Co.

PHILADELPHIA

New York

Chicago

Boston



E. B. VAN WAGNER MFG. CO., STROUSE, N. Y.
Finished Die Moulded CASTINGS
 Timer Parts and Bearings Our Specialty
 30 years' experience in the Manufacturing of Alloy

ALUMINUM BRASS — BRONZE CASTINGS
 LARGEST PLANT IN U. S. UNEQUALED FACILITIES
 Low Freights. Let us quote on your requirements
ALUMINUM FOUNDRY CO. MANITOWOC, WIS.

SUBSCRIBE FOR THE AUTOMOBILE WEEKLY—THREE DOLLARS A YEAR

HART-KRAFT

COMMERCIAL POWER WAGONS

A revolution in commercial car construction—simplest, most efficient, most reliable—strong and durable. Practically perfect in every feature. Easiest to operate and most economical in up-keep; capacity 1,000 pounds.

A UNIT POWER PLANT

INTERCHANGEABLE, SELF-CONTAINED, places this vehicle in a class by itself.

We want live agents in all unoccupied territory. Here is unquestionably the biggest opportunity to make money ever presented as every prospective buyer of a light delivery car will decide in favor of the "HART-KRAFT" when its superiority is clearly explained. Write to us—we allow liberal terms to the right party.

HART-KRAFT MOTOR COMPANY

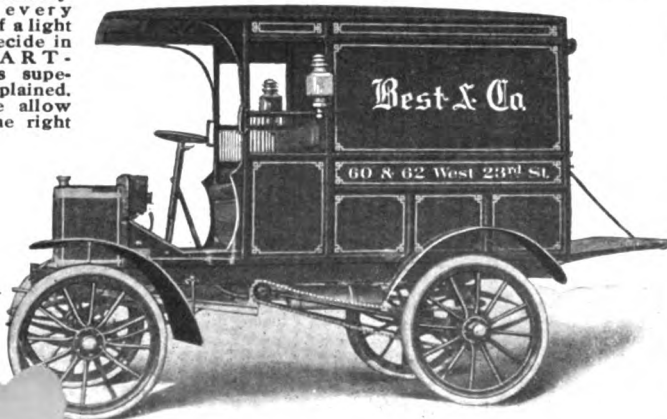

MODEL A-4, \$1,250

M. & E. OILSKIN REPAIR GLOVE
 ABSOLUTELY WATER AND GREASE PROOF
 OILSKIN is new and as durable as leather. The "M. & E." glove keeps the hands clean, keeps the cuffs clean—keeps the sleeves clean—keeps you in good humor—keeps the wash-bills down—and—well, you know the rest.
 Price, cash with order, single pair \$1, 3 dozen pairs \$5
 Express Prepaid—Try them—you'll never work around a dirty car hereafter without them—their advantages will prove so manifold to cleanliness and comfort. Order-to-day.
M. & E. MFG. CO., Ashland, Ohio.

\$1

The Practical Gas Engineer
 WHAT TO DO AND HOW TO DO IT. A book of 150 pages, neatly bound in cloth. Sent postpaid for \$1.00. Address The Automobile, 231-241 West 39th St., New York.

ROYAL VALVE TAP and DIE
 PRICE .15c
 The handiest little tool ever placed on the market for repairing tire valves.
THE MOTOR CAR EQUIPMENT CO.
 1727 Broadway NEW YORK 55 Warren St.

PLEASE MENTION THE AUTOMOBILE WHEN WRITING TO ADVERTISERS

TRADE MARK
STITCH-IN-TIME VULCANIZER CO.
ANYBODY CAN USE ONE

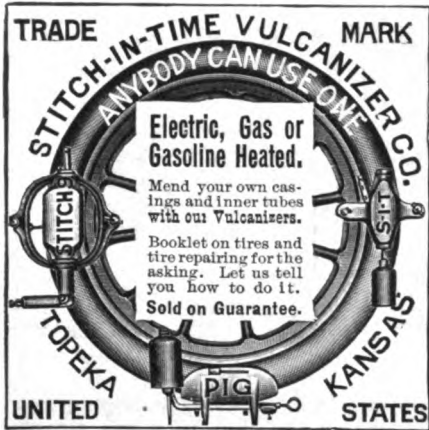

Electric, Gas or Gasoline Heated.
Mend your own casings and inner tubes with our Vulcanizers.
Booklet on tires and tire repairing for the asking. Let us tell you how to do it. Sold on Guarantee.

TOPEKA KANSAS
UNITED STATES

ALL METAL CONSTRUCTION
HANDY GUNS for UNHANDY PLACES



Handle Oils, Greases or Gasoline.
Manufactured By
The Randall-Faichney Co. Boston

LUBRICATION IS VITAL

and how to best accomplish it so as to get the most from your car is told in Dixon's attractive brochure, "Lubricating the Motor"—Copy 12-G free.

JOSEPH DIXON CRUCIBLE COMPANY
Jersey City, N. J.

UNUSUAL PLUG VALUE
is found in the WICO Type "C" at
\$1.00
BE CONVINCED



Witherbee Igniter Co., Springfield, Mass.

The Atwater Kent Spark Generator

MORE RELIABLE THAN THE MAGNETO

CORCORAN
CINCINNATI, OHIO.



No. 22
Auto Lamps of all Descriptions

WINESTOCK Quick Detachable Spark Plugs



DON'T SKIP



Contain both terminals in the detachable member.
Special Insulation (Non-Breakable) Adjustable Spark Gap used with battery or magneto. Gives the hottest spark of any plug made. Every plug absolutely guaranteed. For sale by all leading dealers.

Price \$1.75 Each

KNAPP-GREENWOOD CO., 1000 Boylston St., Boston, Mass.
249 West 57th Street, NEW YORK CITY 707 Shukert Bldg., KANSAS CITY, MO.

We Lead in Quality Style and Finish



1909 Catalogue Ready
Gas, Oil and Electric Lamps
EDMUNDS & JONES MFG. CO.
Detroit, Mich.

PLEASE MENTION THE AUTOMOBILE WHEN WRITING TO ADVERTISERS

TIRE AND TUBE BARGAINS

EXTRAORDINARY BARGAIN!!

\$25,000.00 HARTFORD TIRES AND TUBES \$25,000.00

Great purchase of Clinchers, Universals, Quick Detachables, 1905 Dunlops and Tubes. We guarantee to save you 50% off the regular prices. They are all guaranteed 1909 stock.

Let us know the size and style used and we will quote you a price. This is a great opportunity to save considerable money. We have all sizes on hand in the Bailey, Midgley and Plain Treads, also all styles of tubes.

60 per cent to 70 per cent off 1908 TIRES AND INNERTUBES

Biggest cut ever made on first class, fresh stock. All strictly first quality, fully guaranteed 1908 product of the most prominent manufacturers.

We absolutely guarantee them worth double the price asked for them. The extraordinary low figures at which we sell them, will move our limited stock quickly, and we would advise you to send in your order now. DO NOT DELAY.

Casings and tubes to fit any Clincher or Universal rim.

Size	CASING		TUBE	
	Reg. Price	Our Price	Reg. Price	Our Price
28 x 2 1/2	\$12.50	\$7.00	\$3.20	\$2.50
28 x 3	14.65	10.50	3.65	2.75
28 x 3 1/2	21.55	12.00	5.00	3.50
30 x 3 1/2	23.15	15.00	5.30	3.50
30 x 3	15.70	12.00	3.90	3.15
30 x 4	31.30	17.50	6.40	4.75
30 x 2 1/2	13.25	8.50	3.35	2.75
31 x 4	32.50	18.00	6.65	4.50
32 x 3	16.80	10.50	4.15	3.25
32 x 3 1/2	24.60	15.00	5.60	3.50
32 x 4	33.65	18.00	6.85	5.00
33 x 4	34.85	19.00	7.00	5.00
34 x 3	17.90	9.25	4.45	3.50
34 x 3 1/2	26.80	16.00	5.95	4.25
34 x 4	36.00	20.00	7.20	5.00
34 x 4 1/2	45.65	20.00	8.90	6.00
34 x 5	56.20	20.00	10.50	6.50
36 x 3 1/2	29.05	12.00	6.25	4.25
36 x 4	38.35	18.50	7.55	6.00
36 x 4 1/2	48.35	20.00	9.40	6.75
36 x 5	59.46	22.50	11.05	7.00

Write for Complete List

Write for prices on any make, size or style. We guarantee our prices lower than any dealer in the United States.

TERMS: Cash with order or C.O.D. if order is accompanied by 10% deposit. Money returned, if found unsatisfactory.

\$75.00 1909 Model Riverside Speedometer

Complete with all fittings for any make car, \$19.00. Send for illustration and descriptive matter pertaining to same.

EXCELSIOR TIRE CO.

1777 BROADWAY
NEW YORK.

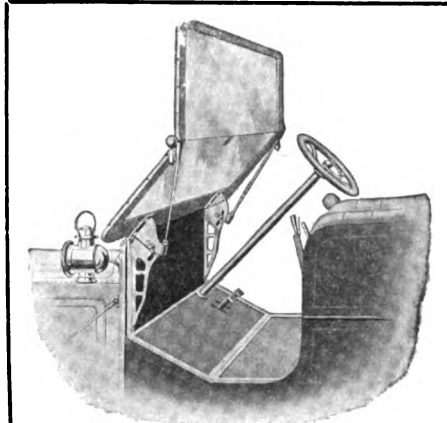

E. T. BURROWES & CO.'S

WIND SHIELDS AND EMERGENCY WHEELS

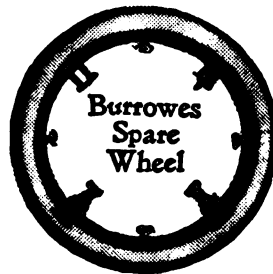

Write for Catalogs to PORTLAND, MAINE

To prevent the substitution of a cheap, inferior material, and to obtain the best made, SPECIFY and DEMAND.

Pantasote

FOR TOPS, SLIPCOVERS AND BOATS
THE PANTASOTE CO.
CHICAGO, NEW YORK, 10 Bowling Green Bldg.

Here it is in operation

BROWN INDICATOR



to test the air pressure in the tires and if found necessary to apply pump to instrument.

Can be found at all supply stores at the cost of \$3.00

The BROWN CO.
419 E. Water St.
Syracuse, N. Y.

THE SLAMA PROTECTOR

No punctures
No Skidding
All Steel Detachable
Positive Traction
Adjustable
Slipping Front or Sideways Impossible



Gives All Tires Indefinite Life
Never can Heat, Stretch or Soak Up Mud
Glass cuts or Side Wear from Ruts and Stones Entirely Defied

Protectors That Protect Without Penalties

For continuous service, rain or shine. The best anti-skid known. Protects the tire from wear by wagon ruts, rocky or rough roads, and eliminating the danger of punctures and blow-outs. Gives the easy riding qualities of pneumatic with care-free qualities of solid tires. Write today and profit by the information.

Slama Tire Protector Co.
617 E. 15th Street, Kansas City, Mo.

Continental Motors are Standard

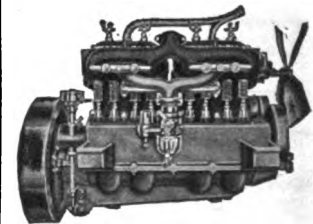

CAUSE—
We are Motor Specialists

RESULT—
There is more Motor Value in a Continental (24-40 H.-P.)

than in any other motor on the market.
Write for Catalogue.
CONTINENTAL MOTOR MFG. CO.
MUSKEGON, MICH.
K. Franklin Peterson, Western Representative, 166 E. Lake St., Chicago. Thomas J. Wetzel, Eastern Representative, 29 W. 42d St., New York.

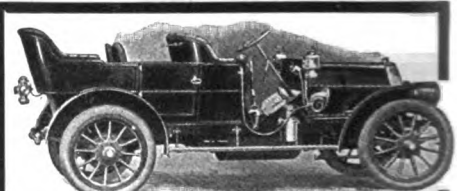

THE GAETH

invites comparison with any other car in its class on the market, knowing that not one has better features or construction. The Gaeth is the car of reliability, strength and efficiency. These are its cardinal points, maintained at all times and in all models. See any of these—Seven-Passenger, Short-Coupled Body or Tourabout—at your nearest Gaeth agency, or write for our handsome illustrated catalog. Any of these three models sell at \$3500 and are full value.

(The illustration above shows Seven-Passenger)
The Gaeth Automobile Co.
CLEVELAND, OHIO
Member A. M. C. M. A.

HERZ

HERZ

HERZ IGNITION MATERIAL

HERZ ROLLER TIMER

NEW!

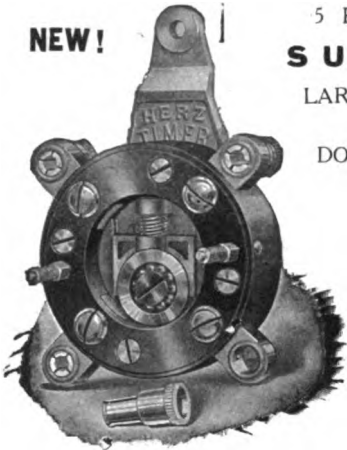

5 POINTS OF ABSOLUTE
SUPERIORITY:
 LARGE ROLLER Running on
STEEL BALLS
 DOUBLE BALL BEARING
Self adjusting
 NO LEVER
Positive drive
 SPRING CONNECTIONS
Throughout
 SMALL OUTSIDE
DIMENSIONS
Diam. 2 1/2 in.
PRICES
 1 Cyl., \$6.50 2 Cyl., \$7.00
 3 Cyl., 7.50 4 Cyl., 8.00

THE BEST ROLLER TIMER MADE

THIS WONDERFUL NEW CONTACT

THEY TALK ABOUT

IS NOW
EMBODIED
IN THE

Specify the Most
Economical Circuit
Breaker—The

HERZ STANDARD TIMER



HERZ STANDARD TIMER

IT NEVER
WEARS OFF!
IT NEVER
BURNS OFF!

WITH THE
NEW
PATENT
CONTACTS

IT'S THE BEST TIMER EVER MADE

IT'S MADE OF METAL WITH A TOOLSTEEL RIM—THE
FINEST SPECIAL STYRIAN TOOLSTEEL

FOR 15 YEARS STANDARD IN EUROPE AND AMERICA

HERZ-PLUG

"BOUGIE MERCEDES"



DOUBLE STONE
That never cracks
 NOT AFFECTED BY OIL
 ABSOLUTELY PROOF
AGAINST SOOT
 FORMS PART OF THE MOTOR
Same as the crank
 NEEDS NEVER TO BE
CLEANED
 HAS 6 GRADUALLY INCREAS-
ING SPARK GAPS
 WE ALSO HAVE A SPECIAL MOTOR CYCLE TYPE
ALL TYPES, \$1.50

AT ALL GOOD STORES OR MAILED, POSTPAID, BY US

ABSOLUTELY GUARANTEED FOR ONE YEAR

HERZ-DISTRIBUTOR

"COMPACT"

With a single
coil and 4
plugs, it gives
the most per-
fect, accurate
timing and
reliable ignition
outfit.

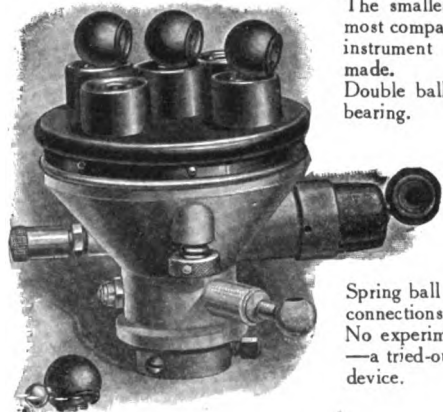

The smallest
most compact
instrument
made.
Double ball
bearing.

2, 3, 4 and 6
cylinders.

New reduced
prices.

Spring ball
connections.
No experiment
—a tried-out
device.

1/2 ACTUAL SIZE

THE IDEAL OUTFIT FOR DOUBLE IGNITION

HERZ & CO. CIVIL ENGINEERS 295 LAFAYETTE STREET NEW YORK

HERZ

LET US SEND YOU OUR "GOLD BOOK" — FREE

HERZ

PLEASE MENTION THE AUTOMOBILE WHEN WRITING TO ADVERTISERS

Only the WARNER Auto-Meter is Trusted on the Thomas Pathfinder's Terrific New York to Seattle Trip

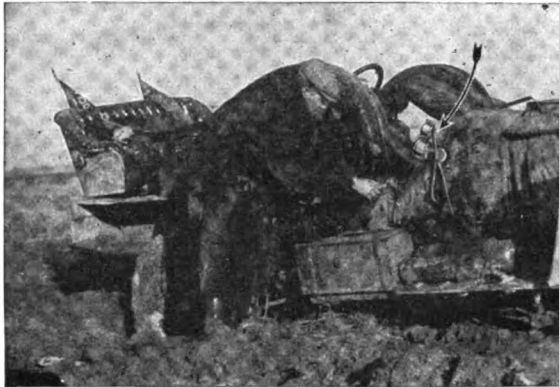

NOTE THE CONDITION OF THE ROADS

In all tests of endurance, in every kind of usage, the Warner Auto-Meter is the only speed indicator that can be trusted. It alone is accurate at all speeds and will remain accurate as long as you have a car to use it on.

The Warner Auto-Meter correctly indicates the slightest forward movement of the car and with equal accuracy every range of speed up to as fast as you dare to drive.

Because absolute accuracy was demanded at all speeds and under all conditions, The Warner Auto-Meter was selected for use on the New York to Seattle Thomas Pathfinder on its Crueling Trip. You will see by the accompanying illustration how terrific are the conditions met with. That the Auto-Meter, notwithstanding the obstacles, remains wholly trustworthy is only another proof of its unfailing reliability.

The Warner Auto-Meter Accurate At All Speeds

The Warner Auto-Meter, because of the Magnetic Induction principle upon which it works, is made so sturdy and strong, and with such refinements of construction, that practical tests have shown that it will withstand a MILLION MILES of the hardest kind of driving without appreciable wear or departing from absolute accuracy more than 10 feet to the mile.

We urge comparative tests.

Let us send you our Book, free, which tells about speed measuring instruments.



Auto-Meter
Model M
1909

The Warner Instrument Company Factory and Main Offices 514 Wheeler Avenue **Beloit, Wis.**

BRANCHES:

New York, 1902 Broadway. Philadelphia, 302 No. Broad Street. Indianapolis, 330 1/2 N. Illinois Street. Cleveland, 2062 Euclid Avenue. Seattle, 914 E. Pike Street. Detroit, 239 Jefferson Avenue. St. Louis, 3923 Olive Street. Boston, 925 Boylston Street. Pittsburgh, 3432 Forbes Street. San Francisco, 502 Van Ness Avenue. Buffalo, 722 Main Street. Chicago, 1502 Michigan Avenue. Los Angeles, 1212 S. Main Street. Cincinnati, 122 East 7th Street.

"ALL-IN-ONE" SPARK PLUG

Your motor is no better than the spark plug that makes the ignition—if the spark plug is good the motor is good—if the spark plug is bad the motor is bad, every time. So it behooves you to get a spark plug that is known to be right, that has its reputation already, that is making good 24 hours daily, 365 days in a year. That is the only kind of a spark plug you can afford to have.

This one spark plug, the one that has its reputation back of it instead of before it, is the

"ALL-IN-ONE"

3,000 Ford car owners use this spark plug and they are 3,000 "ALL-IN-ONE" enthusiasts. Any high-speed engine of any kind will be a better and more dependable engine by using these spark plugs.

The fastest motor boats in the United States use "ALL-IN-ONE" Plugs.

"ALL-IN-ONE" Spark Plugs are to be put on your motors and forgotten; they'll never need constant tinkering and adjustment, they'll take care of themselves. Put them on and leave them alone.

There is an "ALL-IN-ONE" Spark Plug for every spark plug purpose and they can be had from all dealers or from us direct at \$1.50 each.

To avoid delay kindly send money order or check with order.

COMET ELECTRICAL MFG. CO., Detroit, Mich.

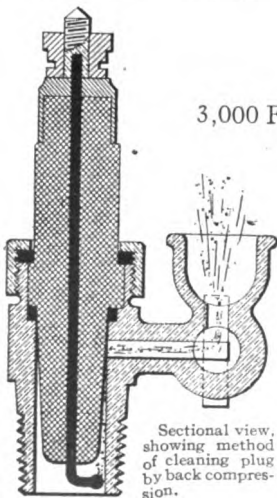

Sectional view, showing method of cleaning plug by back compression.



Exterior view, showing relative size of cap to plug.

AUTHORITATIVE

When it is a question of accuracy there is no appeal beyond the reading of a

Stewart Multipolar

IT IS THE FINAL ARBITER



STEWART SPEEDOMETER PLANT SHOWING NEW ADDITIONS

The fact that we are compelled to treble our present capacity speaks more strongly for the tremendous success of the **STEWART MULTIPOLAR** than any words of ours. Our present factory is by far the largest in the world devoted exclusively to the manufacture of speedometers. The additions now in course of erection will enable us to supply all demands.

Prove to yourself by a 30 days' trial that the Stewart Multipolar is deservedly the most popular speed indicator

Guaranteed for 5 years, and the guarantee is ironclad

60-mile Scale, **\$25.00**

75-mile Scale, \$40.00

90-mile Scale, \$75.00
(Diamond Bearings)

Stewart & Clark Mfg. Co.

506 Diversey Blvd., CHICAGO, U. S. A.

The principle of multipolar induction permits of infinitely precise calibration. *Absolute accuracy* at all speeds, from nothing to the limit of the instrument, is **GUARANTEED.**

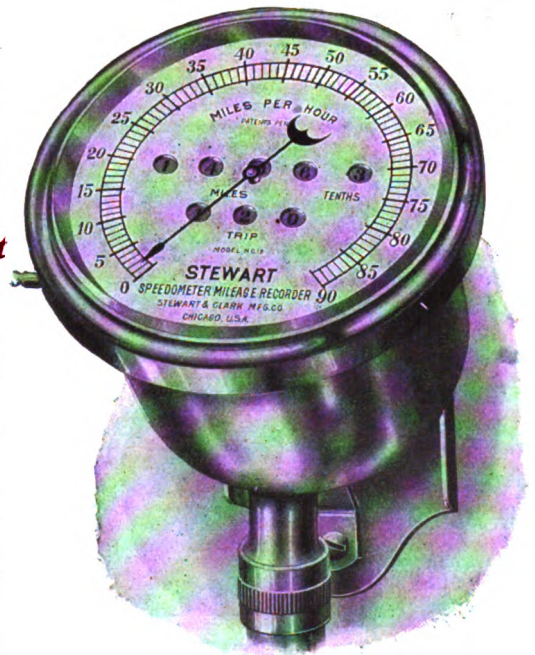

PATENTED OTHER PATENTS PENDING

PLEASE MENTION THE AUTOMOBILE WHEN WRITING TO ADVERTISERS

Buckeye Automobile JACKS

The Jack for Real Service

**STRONG,
SAFE AND
RELIABLE**

Made only by
Buckeye Jack Mfg. Co.

Louisville, Ohio

M. G. WEST & CO.,
San Francisco, Cal.,

Distributing Agents for
the Western Coast.



A. B. C. OF MOTORING

By SIGMUND KRAUSZ

A MANUAL of practical information for layman, auto novice and motorist, containing dictionary of terms, types of cars, anatomy of the automobile, motors, carbureter, ignition, cooling, tires, transmission, etc. Care of the machine, art of driving, troubles of the road, etiquette of automobiling, racing rules and statistics, foreign travel, clubs, manufacturers, trade papers, speed tables, and complete digest of motoring laws of thirty-five States and names of those having no laws.

Morocco Cover : : : : Two Dollars

The CLASS JOURNAL COMPANY
831-241 W. 39th Street, New York

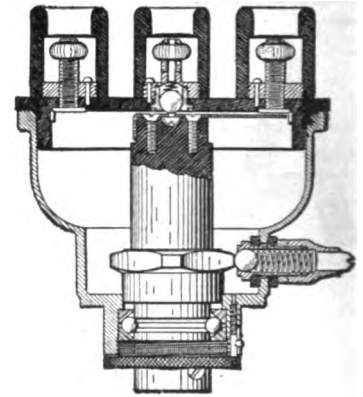

Leavitt Distributor

is built right and gets maximum results regardless of conditions. Its construction gives durability.

All aluminum body.
Rubber top.

Water and heat proof.

Sizes 2 to 8 cyl. (inclusive).

WRITE FOR CATALOG

UNCAS SPECIALTY CO., Norwich, Conn.
High-Grade Ignition Specialties

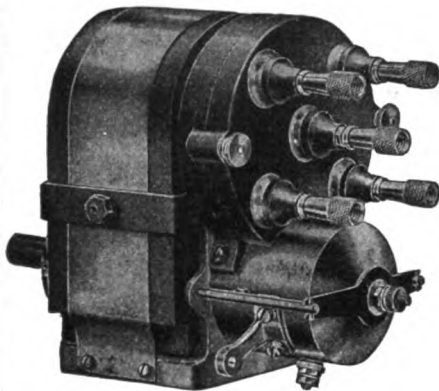

Announcement to Manufacturers

**LATEST!
BEST!
CHEAPEST!**

Kurtz

HIGH-TENSION MAGNETO

At the request of the Hess-Bright Mfg. Co., we have changed the name of our Magneto from Hess to Kurtz.

LATEST—Because it is.

BEST—Because we can produce a *hotter* spark at a *lower* speed. Our *armature* has *improvements* not found on any other Magneto. Has *one-third* less parts than any other Magneto, which means simplicity, and of course increases reliability. Constructed under our *original* patents, by which method we can reduce the number of parts as well as increase the efficiency.

CHEAPEST—Because it stands higher in efficiency and reliability. We can *afford* to sell cheaper, not by giving you something inferior, but can do it only by using our *patented construction*, and reducing the parts and complications to a minimum.

We have the largest line of Magnetos on the market. We *actually* sold more Magnetos for 1908 than any other concern. A strictly American product, guaranteed to have the efficiency and quality of the best on the market.

We are offering nothing freakish. Built on established principles. Efficiency and durability our one aim.

HERCULES goods sold absolutely on their merits. Write Dept. "T. A."

Hercules Electric Company
INDIANAPOLIS, INDIANA, U. S. A.

THE GAS ENGINE HANDBOOK

By E. W. ROBERTS, M. E.

A VERY useful manual of information about American practice in the construction and operation of stationary gas engines, for the use of the designer and engineer. Very little space is wasted on past history, for the book is of and for to-day. It contains many useful tables and formulas and a number of helpful drawings illustrate the text. Size, 3 1/2 by 5 1/2. Pages, 264.

Flexible Covers One Dollar Fifty

The CLASS JOURNAL COMPANY
831-241 W. 39th Street, New York

THE BEST OF EVERYTHING FOR EVERYBODY

THAT EVER DRIVES
A MOTOR MACHINE

WRITE FOR CATALOGUE TO

**EXCELSIOR SUPPLY
COMPANY**

Established 1876

233-235-237 Randolph St.
CHICAGO

TRADE
NONKORODA
MARK
AUTOMOBILE AND WATER
RADIATOR JACKET
COMPOUND

SUPPLY DEALERS
AND GARAGEMEN

No new specialty recently introduced has ever met with such quick success as has "Nonkoroda." Its advantages and necessity for its use in eliminating scale and corrosion and saving in repairs is so apparent to the motorist they all want it—willingly pay the \$1 for large canister.

We are advertising extensively. NOW WE WANT YOU TO REAP THE PROFIT by stocking and pushing its sale. Write to us TO-DAY for our liberal Agency proposition.

THE NONKORODA CO.
25-27 NEW CHAMBERS ST.
NEW YORK.

Auto Pump Oiler

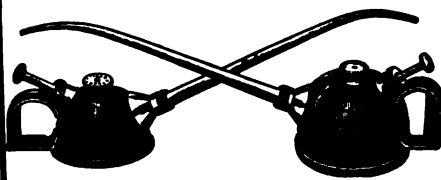

The only pump oiler on the market designed for automobile oiling. Pumps the oil to the bearings in just the quantity desired. Spouts from 3-inch to 9-inch and all interchangeable.

For Sale by All Leading Jobbers
MAPLE CITY MFG. CO.
Monmouth, Ill.

ROCKWOOD
Paper
Frictions



Friction Drives
are rapidly increasing in popularity. Give increased power efficiency and unlimited speed flexibility. Noiseless, light, economical and very simple. No gears to strip or burr. Rockwood Paper Frictions make the ideal friction drive.

Our booklet, "Friction Transmission," an engineering treatise devoted to this subject, contains formulas and other data for the designer. Sent Free on Request to those who state occupation and firm connected with. Assistance in designing cheerfully furnished.

The Rockwood Mfg. Co.
1917 English Ave.
Indianapolis, Ind., U. S. A.

"COMET"

SUREST IGNITION



\$1.25 \$1.25

MICA SPARK PLUGS

¶ A first class product does not need to cut prices to create sales;—when the whole appeal of the manufacturer is price, it is always well to go slow. In the matter of Spark Plugs, for instance, there is a tendency to cut prices all along the line;—to those who think, this suggests two things: that the goods are not worth the price that has been asked for them, and that the only way to create sales of dubious propositions is by a pocket-book appeal. This then, is to declare that the "COMET" and "Sootless" Mica Spark Plugs will not meet price competition. The "Comet" and "Sootless" will go the limit in competition on quality, but never on price. The "COMET" and "Sootless" is a full value for the prices asked—always has been—always will be, and the price is stationary, no cuts. The "COMET" and "Sootless" can't be made to sell any cheaper without taking out quality, and this we will never do. If you want spark plugs that are right in every last particular, including price, get the "COMET" or "Sootless." If you are guided by price alone, most any of the others will do. Proofs of "COMET" and "Sootless" superiority are sent to anyone interested. *Satisfied customers our best advertisement.*

Manufactured by **THE OAKES & DOW CO.**
15 CHARDON STREET, BOSTON, MASS.



\$1.50 \$1.50

Perfectly Gas and Pressure Tight

"SOOTLESS"

PLEASE MENTION THE AUTOMOBILE WHEN WRITING TO ADVERTISERS

KINGSTON OVER ALL

HE Chalmers-Detroit Car No. 19 equipped with the KINGSTON Floating Ball Type Single Adjustment Carburetor, on the Crown Point-Lowell Course, won the Indiana Trophy Cup, Friday, June 18th, from a field of 17 starters, embracing the pick of American light cars, most of whom were high-powered cars driven by professionals, as against the small Chalmers-Detroit driven by Joe Matson, an employee. The distance, 232.74 miles, covered in 4 hrs. 31 min. 21 sec. of steady running, lap after lap, showing but little variation in time and averaging

VICTORIOUS COMPETITION

51 $\frac{4}{10}$ miles per hour. But this is not all; the following DAY, Saturday, June 19th, the Cobe Cup race over the same course was contested by 12 high-powered cars manned by most noted drivers and the winning car in this event made but 49 $\frac{9}{10}$ miles per hour.

The moral is plain; if you are not using the Perfected Kingston Carburetor you are not getting all the power out of your motor.

MADE BY

BYRNE, KINGSTON & CO.

KOKOMO, IND., U. S. A.

WELDING BY ELECTRICITY
 INSURES
STRENGTH, ACCURACY AND DEPENDENCE
 THE STANDARD WELDING CO. CLEVELAND.

BROWN=LIPE GEARS
 STEERING—TRANSMISSION—DIFFERENTIAL. SYRACUSE, N. Y.

A PERFECT IGNITION SYSTEM To get all of the power out of your engine the first prime necessity is a nice, fine, fat, hot spark to ignite all of the gasoline vapor. Don't forget that there's just one way to be assured of this fat, hot spark and that is by using the **"EUREKA" JUMP SPARK MAGNETO**

The "EUREKA" does away with dry cells and storage batteries—which may or may not be right when you most need them—and makes an absolutely dependable Ignition System. One you can rely on all the time. The "EUREKA" will not only furnish the spark to fire the engine, but will also furnish three six-candle power lights. The "EUREKA" is no experiment: it has had its try-out; it has passed the severest tests and has always made good, and it doesn't cost much. Write to us to co-day and we'll cheerfully furnish full particulars. **HENRICKS NOVELTY CO., 127 S. Capitol Ave., Indianapolis, Ind.**



TROY TRIPLE AUTOMATIC WIND SHIELD

ANGLING TOP SASH — RAIN VISION — FOLDING
 EVERY POSITION ABSOLUTELY AUTOMATIC
 SOLID BRASS—NO SCREWS—CLEAN CUT—A BEAUTY
Only One of the "Troy" 1910's
 GET PRICES ON THIS FRONT — THE LEADER OF ALL SHIELDS — KING OF AUTOMATICS
 Mfd. by THE TROY CARRIAGE SUN SHADE CO., Troy, O.



Daylight Continuous!
Puritan Gas Tanks
 Manufactured by
PURITAN GAS TANK COMPANY, 45 MILK STREET, BOSTON, MASS.
 Agencies in leading cities. Don't have to cut prices. Send for description.

"WHITNEY" CHAINS

CAMERON AIR-COOLED CARS

Model	Cyl.	H.-P.	Type	Price
14	4	20-24	Runabout.....	\$950.00
14	4	20-24	Roadster.....	955.00
15	4	20-24	"Flyer".....	1,000.00
16	4	20-24	4 Pass. Roadster....	1,100.00
16	4	20-24	5 Pass. Touring....	1,100.00
11	6	30-36	3 or 4 Pass. Roadster	1,500.00
11	6	30-36	5 Pass. Touring....	1,500.00

Prices include full lamp equipment and High-Tension Magneto
CAMERON CAR COMPANY, Beverly, Mass.
 N. Y. Branch: Broadway and 64th Street. Works: Beverly, Mass. New London, Conn.



Model 14—Roadster.



Model 11—Touring 6-cyl.

Firestone TIRES
FIRESTONE TIRE AND RUBBER CO., Akron, Ohio

PLEASE MENTION THE AUTOMOBILE WHEN WRITING TO ADVERTISERS

WHITLOCK
 INTAKE EXHAUST
 BRASS BRONZE & ALUMINUM
 Whitlock Coil Pipe Co.

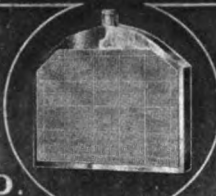

RADIATORS
 AND WATER PIPES
 CASTINGS. AUTOGENOUS WELDING
 Hartford, Conn.

BUFFALO ELECTRIC VULCANIZER CO.
 422 ERIE CO. BANK BLDG.

Every Automobile Owner—Every Garage should own a
BUFFALO ELECTRIC VULCANIZER
 Simplest, most durable and practical—Easily attached to electric light socket—Temperature regulated automatically
 We will sell you ONE for \$10 to introduce
 Every Vulcanizer Positively Guaranteed.
 Write today for our FREE booklet on "Tire Troubles."

BUFFALO ELECTRIC VULCANIZER CO.
 422 ERIE CO. BANK BLDG.

TRIMO



TRIMO PIPE WRENCH
 Made by **TRIMONT MFG. CO., Roxbury, Mass.**
 The Name **TRIMO** will be found on every **TRIMO WRENCH**
 All Parts Interchangeable. Send for Catalog No. 70

BOSTON SHOCK ABSORBER
 KNAPP, GREENWOOD CO.
 1000 Boylston St. - Boston, Mass.
 249 W. 57th St., N. Y. C. 707 Shukert Bldg., Kansas City, Mo.

"DON'T BE SHOCKED"! BUY THE

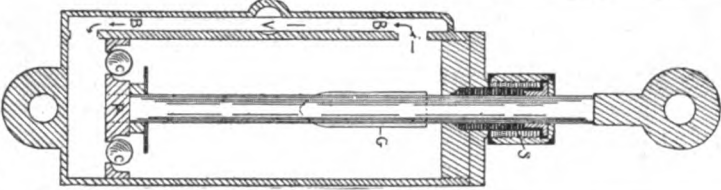

THE BOSTON PAT. APPLIED FOR

STOP!
 NO TIRESELE
 STAYS BEHIND

PUNCTURE AND POROUS TIRE TROUBLES OBTIATED INSTANTLY
 INCREASES LIFE OF TIRES
 REDUCES GREATLY CHANCE OF BLOWOUTS
 NO SPARE WHEELS NECESSARY
 ABOVE CLAIMS GUARANTEED
 Get It From Your Dealer or Send for Booklet

THE TIRESELE CO., 53-57 Bank St., Newark, N. J.
 NEW YORK, 1777 BROADWAY.

TIRESELE
 NO GUM



KRUPP AUTOMOBILE CRANK SHAFTS, STEEL FORGINGS AND FRAME MEMBERS, GEAR BLANKS. KRUPP BAR STEEL BALL MILLS, TUBE MILLS AND OTHER MACHINERY

Chrome Nickel Steel, Round Bars in Stock, having Minimum Elastic Limit 95,000 lbs. per square inch. This Steel can be Oil or Case Hardened so as to have an Elastic Limit of over 200,000 lbs.

Use this "Toughest Stuff" and eliminate the Breakages you are now having.

THOMAS PROSSER & SON, 28 Platt Street, New York

KRUPP STEEL LOCOMOTIVE TIRES AND CAR WHEEL TIRES, CRANK-SHAFTS, STEEL FORGINGS AND CASTINGS, STEEL TIERED CAR WHEELS, PROSSER BOILER TUBE EXPANDERS



"MADE IN SYRACUSE"—KNOWN EVERYWHERE

Why is it—that others were not advocated for use aboard the Auto and Boat? They never were—until after "The Syracuse Special" appeared. (Watch our imitators.)
 No Regular Extinguisher is practical. That's why "The Syracuse" is the only one specially designed. Not affected by Rough Roads and Heavy Seas. Reduce your Auto Insurance one-half. Ask us how. Every Garage should have our "Regular" Extinguisher. They Kill Fire Quick.
 Printed matter, prices, etc. by return mail. Write us to-day. Not to-morrow, and then wish you had. State, county and local agencies wanted in any unoccupied territory—For our full line.

THE SYRACUSE CHEMICAL FIRE EXTINGUISHER CO., Syracuse, N. Y., U. S. A.
 Factory and General Offices—100 W. Fayette St. Agencies all Principal Points.



THE PRACTICAL. To start, "turn bottom up" that's all.

MORGAN & WRIGHT TIRES ARE GOOD TIRES

PLEASE MENTION THE AUTOMOBILE WHEN WRITING TO ADVERTISERS

Those of You Who Have Never Seen The Official A. A. A. Automobile Blue Books

Published in Four Volumes under the Official Endorsement of the A. A. A. Each Volume Complete in Itself.

Observe how clear, concise and understandable is the text and maps as shown in the two sample pages below, illustrating the plan and purpose of this work. No autoist can afford to be without these volumes — their use is indispensable — their aid invaluable. Aside from suggesting delightful trips you never thought of, they tell you explicitly which are the best routes, the best roads, the best hotel and garage accommodations en route; in fact, *everything* the autoist needs to know for facilitating his tours and making them tours of pleasure, expediency and economy. Information as reliable and comprehensive as the personal travel of a corps of experienced editors and map-makers can make it. The four volumes, newly revised and enlarged for 1909, contain approximately 2,750 pages, 1,227 routes, 935 maps, covering 73,000 miles of roadway. Whether you contemplate a ten or a ten-thousand-mile trip, The Official A. A. A. Automobile Blue Books are indispensable to you.

BOUND IN GENUINE LEATHER. PRICE EACH, PREPAID, \$2.50

NEW YORK (SECTION No. 1). Covering New York State, Lower Canada and Trunk Lines to the Middle West.
NEW ENGLAND (SECTION No. 2). Covering New England with extension routes into the Canadian Provinces.

NEW JERSEY-PENNA. (SECTION No. 3). Covering New Jersey, Pennsylvania, Delaware, Maryland and Trunk Lines to the Middle West.
MIDDLE WEST (SECTION No. 4). Covering the Middle West with Extensions to Most Important Points, North, East, South and West.

For Sale at all Leading Bookstores, Hotels and Garages or by the Sole Publishers—

THE CLASS JOURNAL CO.

231-241 West 39th Street, New York or 1200 Michigan Avenue, Chicago

Size of each volume, 5½ x 9¼ inches.

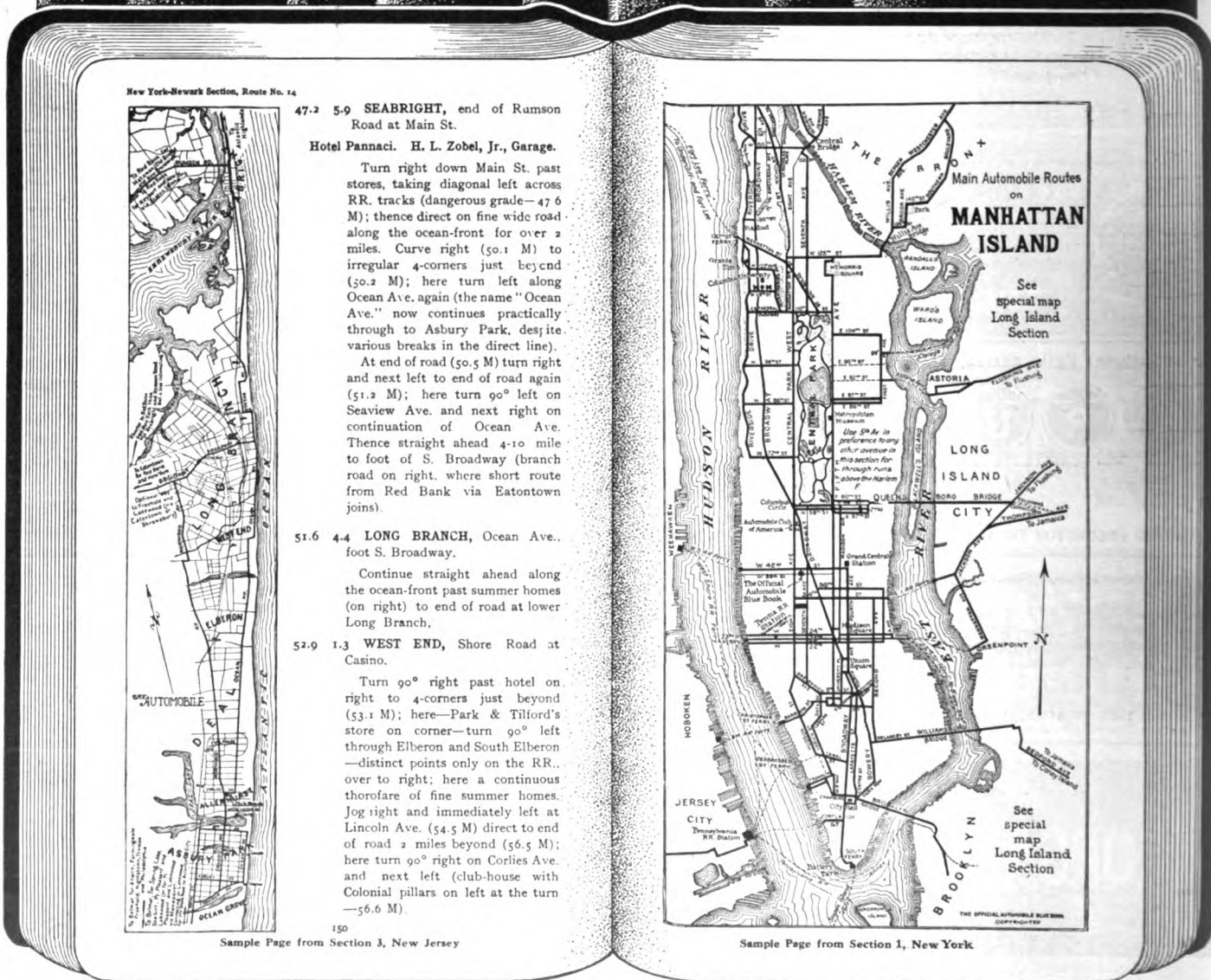

New York-Newark Section, Route No. 14



47.2 5.9 SEABRIGHT, end of Rumson Road at Main St.

Hotel Pannaci. H. L. Zobel, Jr., Garage.
Turn right down Main St. past stores, taking diagonal left across RR. tracks (dangerous grade—47.6 M); thence direct on fine wide road along the ocean-front for over 2 miles. Curve right (50.1 M) to irregular 4-corners just beyond (50.2 M); here turn left along Ocean Ave. again (the name "Ocean Ave." now continues practically through to Asbury Park, despite various breaks in the direct line).

At end of road (50.5 M) turn right and next left to end of road again (51.2 M); here turn 90° left on Seaview Ave. and next right on continuation of Ocean Ave. Thence straight ahead 4-10 mile to foot of S. Broadway (branch road on right, where short route from Red Bank via Eatontown joins).

51.6 4.4 LONG BRANCH, Ocean Ave., foot S. Broadway.

Continue straight ahead along the ocean-front past summer homes (on right) to end of road at lower Long Branch.

52.9 1.3 WEST END, Shore Road at Casino.

Turn 90° right past hotel on right to 4-corners just beyond (53.1 M); here—Park & Tilford's store on corner—turn 90° left through Elberon and South Elberon—distinct points only on the RR., over to right; here a continuous thorofare of fine summer homes. Jog right and immediately left at Lincoln Ave. (54.5 M) direct to end of road 2 miles beyond (56.5 M); here turn 90° right on Corlies Ave. and next left (club-house with Colonial pillars on left at the turn—56.6 M).

Sample Page from Section 3, New Jersey

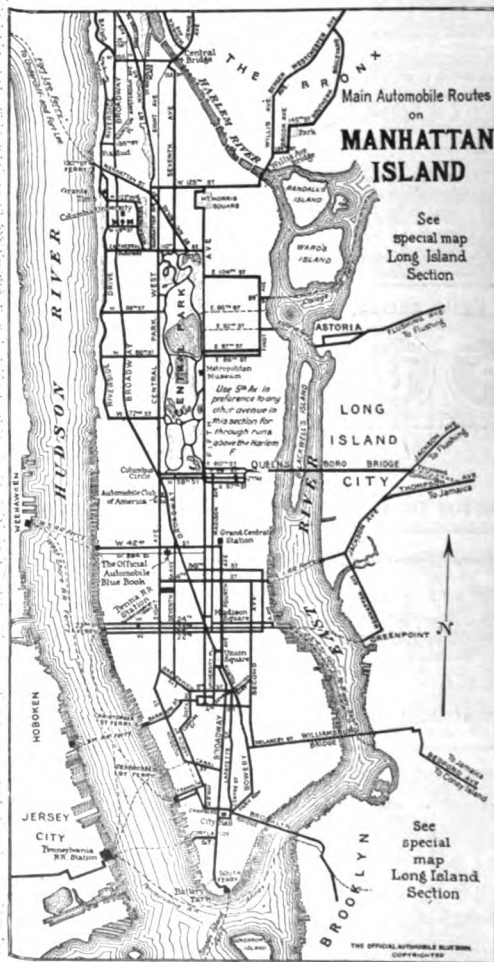

Sample Page from Section 1, New York

PLEASE MENTION THE AUTOMOBILE WHEN WRITING TO ADVERTISERS

THE RUTENBER LINE

Safest and Surest Line to Use for Traveling

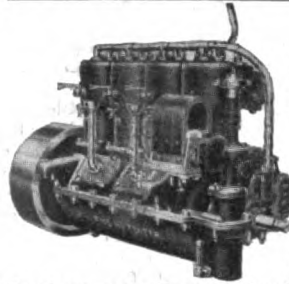

ALWAYS RELIABLE
1909 MODEL "W" 4x4
 Fully equipped with self-contained oiling system with Fan and Carburetor attached. The same high grade workmanship and reliability that always distinguishes the

RUTENBER MOTORS

which still hold the World's Record for the 24-hour Endurance Run. **Rutenber Motors** sell the car. Write us and we will prove it.
 Full line, from 25 H. P. to 60 H. P.

RUTENBER CARBURETORS

Best for your car. Economical and reliable. Write for catalog and information.
THE WESTERN MOTOR COMPANY, Logansport, Ind.

Speedwell

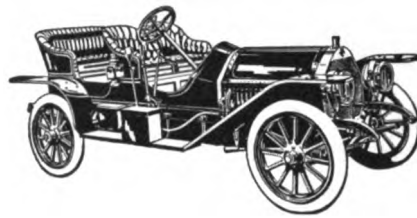

40-45 Horse-power.
4 Cylinders, completely equipped, except top.

The Best That Can Be Built, \$2,500

THE SPEEDWELL MOTOR CAR CO., Dayton, Ohio
 New York Office: 2002 Broadway, at 68th St.
 Chicago Office: 1355 Michigan Ave., at 14th St.



STANDARD (Trade-Mark) SPEEDOMETER

Made in 6 models and each includes our improved odometer with the quick re-setting trip dial and making, without question, the most attractive line of Speedometers, both in price, design and workmanship, of any instrument previously shown. The flexible shaft drive and equipment include our improved pivot drive. Send for circular showing '09 Models. Manufact'd by

PARKER MFG. CO.
 8 Cotton St., Boston, Mass.

MODEL 60.
 3-inch Dial Speedometer-Odometer \$30.00.

WOODWORTH TREADS



FOR TOURING
 PROTECT THE TIRE WHERE THE WEAR COMES. AFFORD MAXIMUM ECONOMY WHERE ECONOMY COUNTS

One-half to three-quarters of the Tire Bill saved and freedom from Punctures, Cut or Torn Tires and Skidding obtained when Woodworth Treads are used.

The only Tire Protectors which in no way injure the rubber shoe. Do not pay for the experiments of others. Woodworth Treads are the **Only Time Tried, Road Tested Tire Protectors.**

Patents on Woodworth Treads cover the only successful device yet made for Tire Protection. There can be no other just as good.

LEATHER TIRE GOODS CO., Niagara Falls, N. Y.
 New York Store, 1650 Broadway
 Chicago Branch, 477 Wabash Avenue

The AUTOMOBILE HAND-BOOK



By L. Elliott Brookes. 470 pages and over 180 illustrations. New 1909 enlarged edition. Popular edition, full leather limp, \$1.50, postpaid.

A work of practical information for the use of Owners, Operators and Automobile Mechanics, giving full and concise information on all questions relating to the construction, care and operation of gasoline and electric automobiles, including Road Troubles, Motor Troubles, Carburetor Troubles, Ignition Troubles, Battery Troubles, Clutch Troubles, Starting Troubles. With numerous tables, useful rules and formulas, wiring diagrams and over 180 illustrations.

The perusal of this work for a few minutes when troubles occur, will often not only save time, money and worry, but give greater confidence in the car, with regard to its going qualities on the road, when properly and intelligently cared for.

It may be stated that at the present time nearly all automobile troubles or breakdowns may, in almost every case, be traced to the lack of knowledge or carelessness of the owner or operator of the car, rather than to the car itself.

The Class Journal Company, 231-241 W. 39th St. New York

The Practical Gas Engineer

What To Do and How To Do It.
 A book of 150 pages neatly bound in cloth. Sent postpaid for \$1. Address Book Department, The Automobile, 231-241 W. 39th St., New York.



Enjoy That Outdoor Meal

You can serve a piping hot meal for a dozen persons at once with the **GEM COLLAPSIBLE COOKER**; you can fold it up and put it into your pocket when you've finished. You can set it up anywhere. It won't buckle out of shape and it's light as well as compact.

Outdoor season is here. Order NOW and enjoy yourself all summer. Price \$3.00 prepaid in neat canvas carrying case. Representatives wanted.

OUTDOOR COOKER CO.
 79 Cutler Bldg. Rochester, N. Y.

PRICE AUTO GLOVES



Lead all auto gloves in style, dress and appearance, as well as sterling wearing qualities. They are made entirely from the best quality of selected, washable, horsehide leather, tanned by our special process under our own supervision. Every seam is sewed with the best quality of stout linen thread, making these gloves as nearly rip-proof as it is possible for gloves to be made. Price Auto Gloves are made to wear and they do wear.

Dealers interested in KASAN goods will find our line the best made anywhere, the dressiest and most durable. Blacks and Tans, short and gauntlet styles. Pull out-seam gauntlets leather-bound.

On request, we will be glad to send our catalogue showing the complete line, in Horsehides and KASANS.

FRIED-OSTERMANN CO.

Succeeding The Henry W. Price Co.
ROCKFORD, ILL.
 Dept. 25

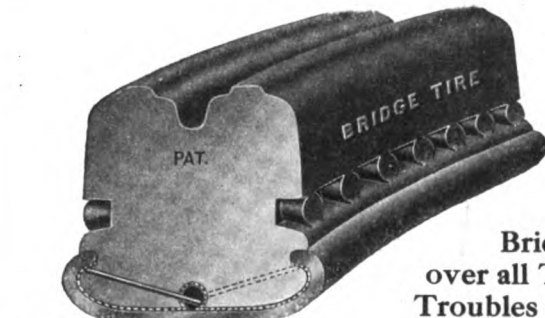

Bridge over all Tire Troubles with

Swinehart Bridge Tires

For Touring Cars, Runabouts and Electrics

The easiest riding cushion tire made, and the most durable. Secured to rims by the only tire fastening for clincher rims that is guaranteed. The cylindrical bridges are indestructible, therefore will not grind out. Tire troubles an impossibility. Investigate this tire before ordering your next tires. "Details in booklet C."

Swinehart Clincher Tire Co.

AKRON, O.

Chicago, 1720 Michigan Ave. New York, 875 7th Ave.



WHY BOTHER with gas lamps, or generators. Equip your Lamps with our **New Electric Lighting System** Cheap, Lasting and Powerful.

Modern Improvements on Automobiles means **ELECTRIC LIGHTS**

Push the button from the seat and you have a Clear, Bright Light for Sixty Hours.

Write us for full information.

BLACK MFG. CO., Fort Wayne, Ind.



HANSEN'S AUTO GAUNTLETS

"Built like a Hand" Most serviceable and most comfortable style made. Strap fastener on back. Made of genuine Hansen's Horsehide, always soft and flexible no matter how often cleaned or water soaked. Wears like iron.

\$3.50 per pair at your dealer's or sent prepaid. State size of kid glove and send outline sketch of hand with fingers spread. **Order style 390.**

O. C. HANSEN MFG. CO., 336 E. Water St., Milwaukee, Wis.

CHEAPER THAN THE
AUTOMOBILE CLUB OF AMERICA
Automobile Insurance

WRITE, CALL OR TELEPHONE

PITCHER & STONE

135 Broadway, New York City

TELEPHONE, 976 CORTLANDT

NOTICE.

CHANGE OF NAME

ROME-TURNEY RADIATOR COMPANY, ROME, N. Y.

Formerly Long-Turney Mfg. Co., Manufacturers of Home Spiral Tube Radiators and Condensers. We wish the trade to know that we have made extensive additions to our plant and with the added equipment, our facilities are ample to take care of the RUSH orders and contracts that buyers may be ready to place. Let us hear from you. Send us blue prints and allow us to estimate cost for your requirements.

ROME-TURNEY RADIATOR COMPANY, ROME, N. Y.



REX ADJUSTABLE WRENCH

All drop forge heads from high carbon steel.

Reversible Ratchet
Extension Handle

All Parts Warranted

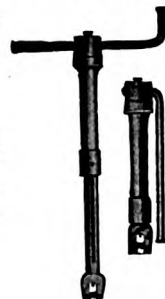

In material, workmanship and general utility, absolutely unequalled.

LIBERAL DISCOUNT TO DEALERS

Send for Catalog

REX WRENCH CO., 200 Summer St., Boston, Mass.



ARMOR-PLATE YOUR TIRES

—and you can drive over the worst roads you can find anywhere, over bottles and bones, nails and stones, car tracks and rocky ruts

Send for detailed information

The Kimball Steel Armor makes blowouts and punctures impossible and doesn't affect the resiliency. Cannot slip or skid.

You can use any old "thrown away" tire for years. It will make a new tire out of the old one, and will make a new tire outlast the best car made.

A Few Sections on that Weak Place will Show You. **Kimball Tire Case Co., 171 Broadway, Council Bluffs, Ia.**

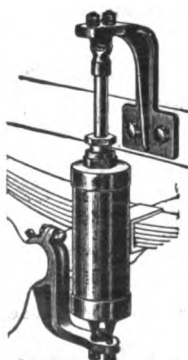

\$5000 NOBODY WANTS IT

Ask the Air Shock Absorber manufacturers of Boston why they do not want to back up their claims previously made. I challenged them \$5000 a side for a public test of 100,000 miles, their device against mine on general merits. They did not accept. They know as well as other Shock Absorber manufacturers that my Hydraulic Jounce and Recoil Preventers are the best for flexibility, durability and absolute comfort over all kinds of roads.

Noadjustment necessary. No rattle or noise. I can prove that I manufacture and sell more Shock Preventers than all Boston Shock Absorber manufacturers combined. Two months' free trial; two years' guarantee, or longer if desired. Ask the men who have them on their cars. This is not air used over again, but facts.

For further particulars and testimonials apply to

Ernest Flentje, 1643 Cambridge St., Cambridge, Mass.

Telephone 950 Cambridge

Branches: New York, 1926 Broadway, cor. 64th St.
Chicago, 3095 Sheridan Road, cor. Devon Ave.

Patented Sept. 29, 1908,
U. S. A., Germany,
France and England

JOHN BOYLE TRUNKS

Indispensable Attributes to Auto Travel, Comfort and Convenience

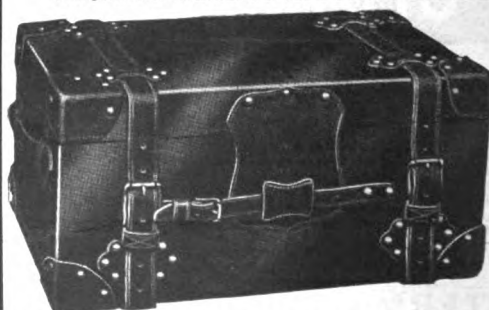

John Boyle Trunks are the superlative in Auto Trunk construction. Designed and made with a view to hard usage, each of the several models is a masterpiece of quality, style, lightness and strength, and are absolutely weather and dust-proof. Don't be wheedled into believing the imitations are "just as good"—they are NOT.

A good car deserves good Trunks—get the BEST—THE JOHN BOYLE MAKE—and secure lasting satisfaction.

Write for Style Book and Prices for the Various Makes of Cars.

JOHN BOYLE & CO., 112-114 Duane St., 70-72 Reade St., New York

Put a Turntable in Your Garage

Then you will never have to back your machine in or out. Ride in frontwards—turn the table around with one hand (it runs on ball bearings)—and there you are, ready to drive right out frontwards. Saves time and trouble. Avoids the risk of accidents due to driving out backward; removes the unpleasant chance of bowling someone over, or of running against the curb, or into some other obstruction that might cause a more or less expensive smash-up.

Of course you can see for yourself what a great convenience the turntable will be in a small garage, for it runs so easily on its bearings that a child can move it. The cost of these turntables runs from \$225 to \$275—a very small price for so great a convenience.

Public Garages particularly should ask for terms and specifications.

Write and ask us today for particulars.

Lansing Wheelbarrow Co., Dept. B, Lansing, Mich.
Warehouses at Kansas City, New York, Minneapolis, Chicago, Philadelphia and San Francisco.

IF

you are interested in automobiles or the purchase of supplies, send your name and address for OUR 1909 CATALOG and Special Price List—Mailed Free if you mention this paper.

Buy from Headquarters
We have no Branches

NEUSTADT AUTO & SUPPLY CO.

"THE GROWING HOUSE"
3948-50 Olive St., St. Louis, Mo.

THE AMERICAN



"NO NOISE BUT THE WIND"

THE TRAVELER

Underslung frame; 40-inch wheels; 50-60 H. P., four-cylinder motor, \$4000. Wherever you find an American, you will find it owned by he who will consider nothing short of the finest and best motor car. It is, in very fact, "a car for the discriminating few." Literature on request.

We have territory open for established and responsible dealers.

AMERICAN MOTOR CAR CO., Dept. E., Indianapolis, Ind.
Standard Manufacturers, A. M. C. M. A.

Don't Start Without Weed Chain Tire Grips

Not even for an afternoon spin. The weather is not settled—a rain storm may blow up any minute—then you'll need a set of Weeds. The genuine has BRASS PLATED CROSS CHAINS—see that you get them.

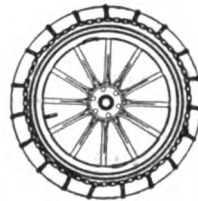

Weed Chain Dept.
United Manufacturers, Inc.
76th St. and Broadway, NEW YORK

Empire Tires

WEAR LONGEST

EMPIRE TIRE COMPANY

TRENTON, N. J.

AGENCIES

- | | |
|---------------------------------------|-------------------------------------|
| Atlanta, Ga., Dunham Rubber Co. | Norfolk, Va., Wm. H. Grover. |
| Atlantic City, N. J., | Philadelphia, Pa., |
| Penn Auto Supply Co. | Penn Auto Supply Co. |
| Buffalo, N. Y., Empire Sales Co. | Pittsburg, Pa., |
| Cleveland, O., | Consumers' Auto Supply Co. |
| Motor Supply Agency Co. | Portland, Me., James Bailey Co. |
| Denver, Col., Denver Auto Goods Co. | Providence, R. I., |
| Dallas, Tex., Mungler Auto Co. | Waltz Auto Supply Co. |
| Jacksonville, Fla., Savall Rubber Co. | St. Louis, Mo., Gorman Bros. |
| Kansas City Mo., Auto Specialty Co. | Savannah, Ga., Harris Tire Co. |
| Los Angeles, Cal., | Syracuse, N. Y., |
| Empire Tire and Rubber Co. | Central City Rubber Co. |
| Minneapolis, Minn., | Toledo, Ohio, |
| Empire Tire and Rubber Co. | W. G. Nagel Electric Co. |
| New Orleans, La., H. A. Testard. | Boise, Idaho, Randall-Dodd Auto Co. |

Packard Ignition Cable



is there in all weather conditions

ATTRACTIVE BOOKLET FOR THE ASKING

THE PACKARD ELEC. CO.,
302 Dana Avenue Warren, O.



The Steady Hand!

Steadiness
is
Reliability

THE HOFFECKER

is absolutely reliable from every point of view—accuracy of registration, ease in action, clearness of reading

Nothing moves the needle save the speed of the car

Send for Catalog

THE HOFFECKER CO.
Motor Mart, Boston, Mass.

"Little Giant" Air Compressors

are air compressors equal in every way to any compressors made and should have a place in every garage in the United States. It will pay for itself in a very short time through increased garage facilities.

Indispensable for inflating and testing automobile and bicycle tires, starting gas engines, operating brazing and heating machines, pneumatic tools, sand blasts, etc. Ask for details and prices.

We also make Jacks and Vises of an exceptional quality. Write for booklet.

Orange Mach. & Mfg. Co.
10-14 STETSON STREET
Orange, N. J.





"THE BEST IGNITION"

Because:

- 1—More durable.
- 2—Largest capacity.
- 3—Bigger results.
- 4—Every mechanical and electrical detail is perfect.

TRAY PLATE BATTERY COMPANY
Binghamton, N. Y.

6 VOLT 60 AMPERE SIZE

Save Your Money

HOW?

By cutting down your **Water and Electric Light Bills.** Overhead Vehicle Washers plain and with the electric lights. Also the Indestructible Vehicle Washer No. 3 with the **automatic water cut-off.** This cut-off is not on the end of the hose, but in the top of the washer. **SEND FOR CATALOG A.**



THE I. J. SMITH MFG. CO.
4287 Park Ave., NEW YORK

DON'T BUY UNTIL YOU ASK ABOUT

COL. SPRAGUE'S NEW WIND SHIELDS

GET OUR LOW PRICES ON GOOD GOODS

SPRAGUE UMBRELLA CO.
NORWALK, OHIO

The Leader in Brass

The Surprise in Wood

NOW IS THE TIME

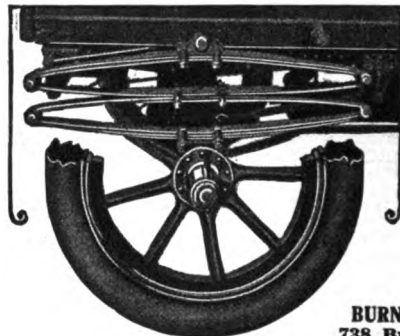

to equip your car with the Burnet Compound Inner Leaf Springs.

Do not wait, but get the car in readiness for the rough roads, mud and slush that are to come.

If a shock absorber is necessary on a Spring, it is an admission that the Spring itself is defective.

REMEMBER, no shock absorbers are needed for the Burnet Compound Springs. They, themselves, absorb the shocks and jolts, without impairing the proper flexibility of the Springs.

BURNET COMPOUND SPRING
738 Broad St., Newark, N. J.



GOBBO

The smiling god of good fortune, The original divinity of optimism, Whose cheerful countenance Brings good luck And happy days to all who Observe this rule of life: "BE CHEERFUL AND YOU WILL BE RICH IN EVERYTHING."

THIS IS THE MASCOT that has brought good luck to the Maxwell during the entire 10,000 mile non-stop engine run. Attach one to your radiator cap and you will have no hoodoo.

Price, \$1.00
Prepaid ready to attach.
Discount to Dealers.

The S. M. Supplies Co.
22-24 Lincoln St., BOSTON, MASS.

1910 CONTRACTS.

Now is the time to consider your 1910 requirements. We have standard designs which may interest you. Our new developments brought forth from time to time may be just what you want.

Material and workmanship the best. We manufacture AXLES (Front and Rear), TRANSMISSIONS, CONE CLUTCHES, STEERING REACHES, STEERING COLUMNS, HAND LEVERS, ETC.

Your inquiries are solicited.

THE "LONG-ARM" SYSTEM COMPANY
CLEVELAND, OHIO.



THE INTER-STATE

Nothing is slighted, nothing cheapened in the Inter-State. In every way the light-running, graceful, speedy Inter-State—\$1750 complete with Eisemann Magneto—finds its only competition in the high-priced high-grade cars.

Write for catalogue, to-day, before you think of spending your money for a cheaper car—or even a high-priced car. Dealers and Agents will appreciate the opportunity opened to them by the Inter-State. Address:

INTER-STATE AUTOMOBILE CO.
127 Willard Street, Muncie, Indiana

1909 MODEL "K" MOTOR
FOR HIGH WHEEL BUGGY AND LIGHT DELIVERY WAGON

14 H.P. Air Cooled 16 H.P. Water Cooled

Off-set Cylinders
Straight Connecting Rods
Mechanically Operated Valves
Perfectly Balanced; Thoroughly High Grade
Overall Dimensions
Length 27 3/4"
Width 15 1/2"
Depth, including Fly Wheel, 19 1/2"
Positively Guaranteed to cool Perfectly.

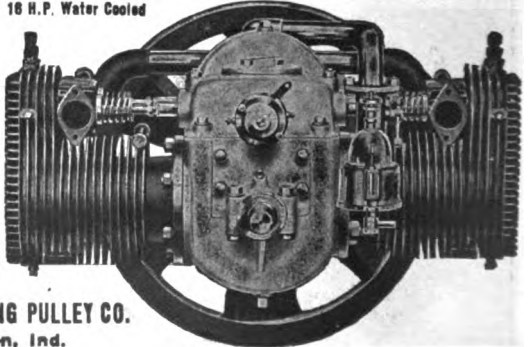

SPEED-CHANGING PULLEY CO.
Anderson, Ind.

PLEASE MENTION THE AUTOMOBILE WHEN WRITING TO ADVERTISERS

Unquestioned Proof



of the Efficiency and Absolute Reliability of the

Splitdorf Magneto

was again furnished in the strenuous journey of the E. M. F. Glidden Pathfinder, which was equipped with a SPLITDORF Magneto. 2,637 miles, 38 days of continuous driving, and perfect ignition throughout.

Do you want any better reason why you should equip your car likewise? Ask for Magneto Catalog.

C. F. SPLITDORF Walton Ave. and 138th St. New York
Branch: 1679 Broadway

"Get a Stepney Spare Wheel and Be in Line"

FOR FULL PARTICULARS GET OUR CATALOGUE FOR 1909

Spare Motor Wheel of America, Ltd.
236 Michigan Avenue, Chicago, Ill.

The 1910 Lexington

A BEAUTIFUL CAR in Three Models
Touring—Roadster—Short Coupled Body
Either, \$2,500

Although a newcomer, this car has already proven its sterling worth, on account of its being built along lines that have long ago been tried out, and found good. We are not "too original"—if we were we might make a mistake and you would be the loser, but have endeavored (and successfully) to build a car embodying in it the best qualities of the best cars—a car that will go any place (and back) without the addition of an expert chauffeur to keep it "tuned up"—a car the owner himself can drive, if he prefers, with pleasure and perfect satisfaction.

"TRY TO GET ONE"

THE LEXINGTON MOTOR CAR CO., Inc.
LEXINGTON, KY.

THE THOMAS FLYER

CHAMPION STOCK CAR OF THE WORLD

Send 10 cents in stamps to cover cost of mailing and we will send you a beautifully illustrated book on the New York-Paris Race

ADDRESS DEPT. A

E. R. THOMAS MOTOR CO.,
Member A. L. A. M. Buffalo, N. Y.



Looks Good!

Yes, and it works better than it looks. It is the new

GRAB PUMP CONNECTION

Fits every valve instantly. Simply clamps on and off. Leakage impossible. Nothing to wear out, nothing to get out of order. Taken all and all it is the best and simplest connection on the market.

PRICE 25 CENTS EACH

The Motor Car Equipment Co.
55 Warren St. New York 1727 Broadway

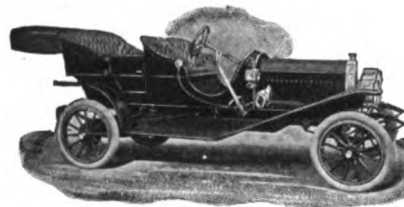

The Lambert Car

is a good car at a low price. Simple mechanical design, high-grade construction, style and comfort. Six models, ranging from the \$800 Lambert runabout to the big \$2,000 seven passenger Lambert. Transmission—the Lambert Friction Drive, more reliable, more efficient, than any other type of transmission. Write for Catalog. Openings for agents.

LAMBERT "30"—\$1250

other type of transmission. Write for Catalog.

BUCKEYE MFG. CO.

1815 Columbus Ave., ANDERSON, IND.

Standard Manufacturers A. M. C. M. A.

C. A. Eaton, 64 Pembroke St., Boston, Eastern Representative



\$1,250

F. O. B. DETROIT



Magneto Included

—of Course

Everitt-Metzger-Flanders Co.
DETROIT, MICHIGAN

42 Highest Awards and Perfect Scores

"Oldest Makers in America."



Kokomo, Ind.

Studebaker

**GASOLINE CARS
ELECTRIC PLEASURE VEHICLES
ELECTRIC POWER WAGONS**

Studebaker Automobile Co.

Factory **SOUTH BEND, IND.** General Offices **CLEVELAND, OHIO**

THE METZ PLAN CAR
is a stylish \$600 runabout that can be bought for \$350
The "Plan" is told in Book "J" **EQUIPPED WITH BOSCH MAGNETO, GOODRICH CLINCHER TIRES**

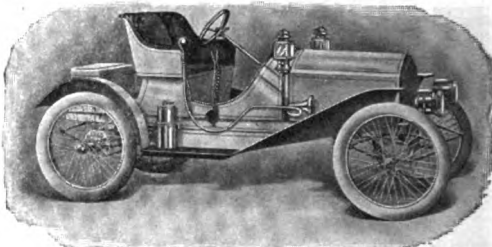

C. H. METZ **Waltham, Mass.**

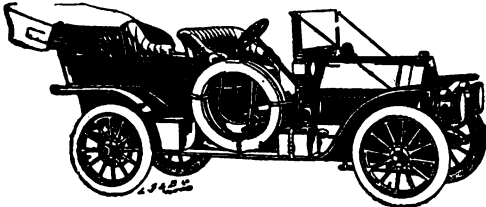

"Jewel 40"

Touring Car, Roadster and Baby Tonneau at \$3000. Limousine at \$4000.

A perfected car of highest grade; Bosch Magneto, Truffault-Hartford Shock Absorbers in addition to regular equipment.
No better car can be made at any price. We want agents where we are not now represented. Send for catalogue and particulars.

The Jewel Motor Car Co. 121 Walnut Street **MASSILLON, OHIO**

Write for Particulars of the GREAT WESTERN LINE. All with Magneto

A POSTAL—A CATALOG

No. 18—24 H.P. 2-cylinder	• •	\$1,350
No. 20—30 H.P. 4-cylinder	• •	1,600
No. 20A—30 H.P. 4-cylinder	• •	1,600
No. 21—40 H.P. 4-cylinder	• •	2,500
No. 24—45 H.P. 4-cylinder, 5 or 7 pass.	• •	3,000
No. 22—50 H.P. 4-cylinder, 7 pass.	• •	4,000

MODEL AUTOMOBILE CO.
97 SMITH STREET **PERU, IND.**

**ONE QUALITY FOR ALL MODELS
ONE PRICE FOR ALL BUYERS**

Stoddard-Dayton

Touring Cars, Roadsters, Runabouts, Limousine, Coupe and Landulet. A Line of American cars that **STAND OUT** :: Write for '09 Catalog

THE DAYTON MOTOR CAR CO., Dayton, Ohio

Write for Catalogue



AUTOMOBILES
New Britain, Conn.



The Only \$1500 Car That
has 14 inches road clearance. By that we don't mean axle clearance but 14 inches from lowest part of car to the ground. Don't be misled by axle clearance—there are other things still lower. Be sure and see the

Moline **THE CAR FOR ANYWHERE**

4 Cylinder 25-30 H.P.

The best car value anywhere. May we prove it by actual demonstration? Say the word, we'll do the rest. Catalog "A" free. Write-to-day
MOLINE AUTOMOBILE CO., East Moline, Ill.

THE SELDEN CAR
"Made by the Father of Them All"

A HIGH GRADE CAR A CAR OF QUALITY AT A MEDIUM PRICE

\$2000. F. O. B. Rochester N. Y. Agencies Wanted Everywhere

SELDEN MOTOR VEHICLE CO.
Geo. B. Selden, President **ROCHESTER, N. Y.**

Member Association of Licensed Automobile Manufacturers.
N. Y. Agency, Bryant Motor Co., 41 W. 43d St.

PLEASE MENTION THE AUTOMOBILE WHEN WRITING TO ADVERTISERS



KING of the ROAD AUSTIN

"The car that just suits everybody" has got to be a good car—a very good car—and there is no other that does this quite as well as the AUSTIN does. This pleasing condition didn't happen; it is the result of a firm, deliberate, predetermined intention to accomplish this very desirable end, and it has taken time and cash to bring it about. The AUSTIN is a car that squarely fills the need for as good a car as can be made at any price—yet in constructing AUSTIN cars manufacturing conditions exist that cheapen cost to the minimum without lessening quality one iota.

AUSTIN cars are no higher in price than the high-class American and foreign built cars, but even a casual examination will show them far greater value and far superior in every feature than any car built.

AUSTIN cars are for people who want quality—luxuriousness, style and perfect and easy operation, yet withal moderation in the matter of price. AUSTIN cars fulfill these conditions precisely, and if you contemplate buying a car, investigate "AUSTIN" cars carefully, and you'll find they are by far the "Cheapest" investment you can make. Seemingly a little high in first cost—but FIRST cost is all the cost—no endless expense in repairing this and replacing that, as in the low-grade cars.

At least get AUSTIN literature; it will greatly interest you, whether you buy or not.

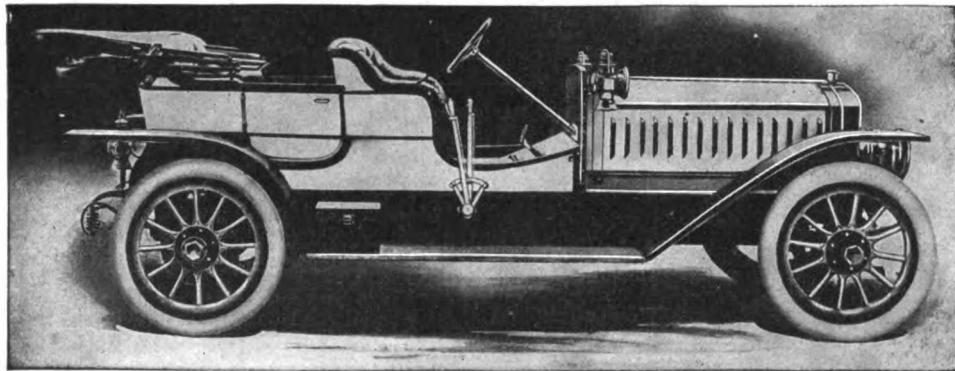

Model 45, \$3,000

Model 45, 45-50 H. P., 6-cylinder, 5-passenger Touring Car \$3,000.00

Model 50, 50-60 H. P., 4-cylinder, 7-passenger Touring Car 4,000.00

Model 60L, 60-90 H. P., 6-cylinder, 7-passenger Touring Car 6,000.00

We will be pleased to send detailed specifications to any enquirer on request, and arrange a trial run or personal inspection. Write to us.

AUSTIN AUTOMOBILE COMPANY

Grand Rapids, Mich.

Chicago Branch, 1420 Michigan Ave.

Boston, 24 Brook St., Newton Mass.

We Make Three Distinct Types of Radiators

WATCH THE "L" GROW

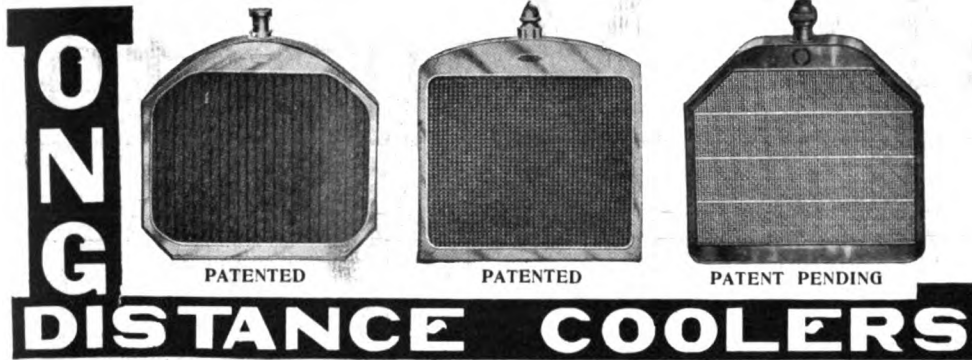

LONG'S RADIATORS

are the most efficient in point of radiation, workmanship and appearance. You can make no mistake in buying either of these types. For complete descriptive information

SEND FOR NEW CATALOGUE
LONG MFG. CO., Chicago

OUR FACILITIES FOR MAKING

DROP FORGED
PRESSED STEEL
HAMMER FORGED
MACHINED and GROUND

- Crank Shafts
- Control Levers
- Connecting Rods
- Gear Blanks
- Frames
- Rear Axle Housing
- Radius Rods
- Small Parts
- Cranks
- Front Axles
- Parts of All Descriptions

insure our customers against loss of material in process, also prevent delays.
We cordially invite an inspection of our works.

DRIGGS-SEABURY ORDNANCE CORPORATION, Sharon, Pa.
Send blueprints or sketches for quotation

KINGSTON

THE STANDARD IGNITION

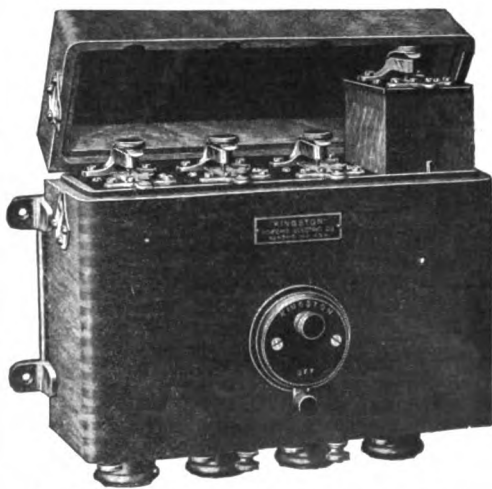

Kingston 4-cylinder Unit System Dash Coll.
The most popular coll on the market today

Kingston Spark Coils and Plugs have won success for many of the best American built cars and will do as much for yours if you but give them a chance. If you want the *best*—the one most efficient and dependable always under all conditions of service—then you will decide to use the KINGSTON line. Absolutely the most perfect of its kind, with a reputation for performance unapproached by any others.

We offer a most liberal proposition to live dealers, and it will pay to get our proposition.

It is easier to sell a high grade article at a fair price than a high grade article at a high price, or a low grade article at any price.

We want agents in every city in the United States.

KOKOMO ELECTRIC CO.
KOKOMO INDIANA

SOLE MANUFACTURERS



1/2-In Standard Pipe Thread
Actual Size

PLEASE MENTION THE AUTOMOBILE WHEN WRITING TO ADVERTISERS

REMY Magneto Wins Again!



Famous ignition system used on the car driven by Chevrolet to decisive victory in the Cobe Trophy Race at Crown Point, Indiana, June 19th.

Chevrolet chose the Remy Magneto for use in this event, despite the fact that attractive prizes were offered by other magneto firms

And proved the superiority to all other magnetos, foreign or American, of the Remy, the perfect mechanical ignition system!

Fifty thousand Remy 1910 magnetos are called for by contracts with two automobile manufacturers alone.

The Remy is the simplest ignition—has the broadest margins for dirt, oil and water and neglect—requires practically no care—can be installed by anybody.

Motorists everywhere are invited to take advantage of the Remy magneto service.

A competent corps of experts at our branch selling offices in New York, Chicago and Detroit, will help you solve your ignition troubles. Call or write to our nearest address

REMY ELECTRIC COMPANY, Dept. 12, Anderson, Indiana

BRANCH SELLING AGENCIES

1400-1402 Michigan Ave.
CHICAGO

Automobile Bldg., 64th and Broadway
NEW YORK

471 Woodward Ave.
DETROIT

Dixon's Auto Compound

Keeps your **Radiator** free from Scale Deposits and your **motor** absolutely cool. We guarantee it is harmless, and can in no way injure any part of your car. Will send sample can for \$1, if not satisfactory, will refund your money. We also manufacture

- Dixon Carbon Remover
- Dixon Grafite
- Dixon Grease
- Dixon Metal Polish

DIXON SPECIALTY CO.

776 Main St., BUFFALO, N. Y.

ALBANY GREASE

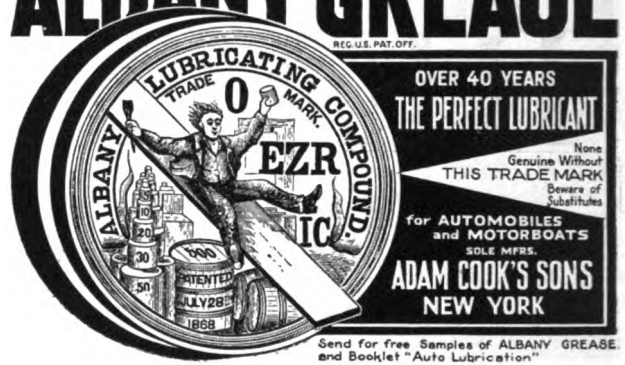

Send for free Samples of ALBANY GREASE and Booklet "Auto Lubrication"

SAVES A THOUSAND DOLLARS

KISSEL CAR



ROADSTER AND TOURING CARS \$2000

Model D. 9—A prepossessing car with every approved feature. 4 cylinder, 40 H.P., Timken roller bearing, 34 elliptic springs, selective type transmission, floating type rear axle, ATWATER-KENT GENERATOR or REMY MAGNETO, SINGLE NON-VIBBRATING COIL AND DRY CELLS.

Model L. D. 9—4 cylinder, 30 H. P. Roadster \$1350. Touring Car \$1500. The only low priced through and through quality car.

Model G.—An elaborate 6 cylinder, 60 H. P. Touring Car \$3000.

KISSEL MOTOR CAR CO.
122 Kissel Ave. Hartford, Wis.

TO RENT

Two of the finest stores for Automobiles or accessories in Automobile Row, Michigan Ave., Chicago. 50 x 165 feet and 25 x 165 (now occupied by leading manufacturers). For full particulars address:

The Fourteen-Eleven Company
1411 Michigan Ave., Chicago

Franklin Automobiles

We make strong claims for Franklin automobiles. But these claims are the history of the Franklin from the start seven years ago. Then as now the Franklin idea was common sense. The first Franklin, still in use, was light. It had the wood chassis frame, full-elliptic springs and air-cooled motor.

H H Franklin Manufacturing Company
Syracuse N Y

You Cannot Keep Your Brakes Free From Oil

But you can get a brake facing that oil does not injure.

Raybestos as a band brake facing.

Raybestos

is oil proof, mud-proof, dust-proof and almost wear-proof. It retains its "grip and hold" power to the very last. It is good for thousands of miles. We have an interesting booklet that covers this subject thoroughly; a post card request will bring it to you.

Royal Equipment Company, 155 Housatonic Ave., Bridgeport, Conn.

W-D SPRING CUSHION TIRE

Eliminates Tire Troubles

BEST TIRE for TOURING

No blowouts—no punctures—absolutely safe—no accidents—as resilient as the very best pneumatic.

Will fit any size or any make shoe. Better by far than anything on the market.

SPECIAL NOTICE
Before purchasing your new SHOES get important information from us. Representatives wanted in leading cities. Write for particulars at once.
W-D Spring Cushion Tire Co
General Offices 107 W. 27th St., N. Y.

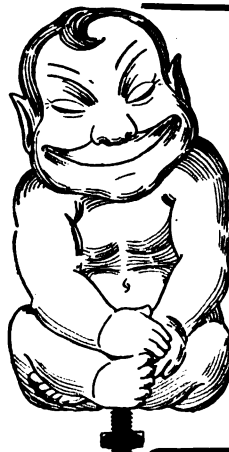

Ye Who Ride!

Have ye joined the "Gobboites"? Are ye a member of the "Happy Bunch"? If not, get in line. Be recognized by this emblem that ye are a good fellow and have a merry heart.

"Gobboites" Never Fear Accidents

Good Luck is always with them when "Gobbo" is on the radiator cap.

Two Sizes—3", 75c.; 5", \$1.50

Write to Head Scribe at

THE MOTOR CAR EQUIPMENT COMPANY
1727 Broadway, New York 55 Warren St.

PLEASE MENTION THE AUTOMOBILE WHEN WRITING TO ADVERTISERS



The most attractive agency proposition ever offered. Write to us to-day for full particulars—it may be the means of giving you a big, permanent, profitable business.

We make four models—"Keystone 6" 35-40 H. P.—Model "A" Tourist—Model "B" Roadster and 60 H. P. Speedster—all highest quality cars with graceful lines, comfortable, luxurious, easy to operate, and sold at the lowest prices for the quality offered of any cars to-day. Write to us—that's all—write to-day.

THE MUNCH-ALLEN MOTOR CAR CO., Du Bois, Pa.

WINTON SIX

GOES THE ROUTE LIKE COASTING DOWN HILL

Early deliveries of the new Winton Six are assured to dealers who contract for territory early. If you are interested in securing cars that will win business for you on sight, write us to-day.

THE WINTON MOTOR CARRIAGE CO.

Member A. L. A. M.

919 Bera Road,

Cleveland, Ohio

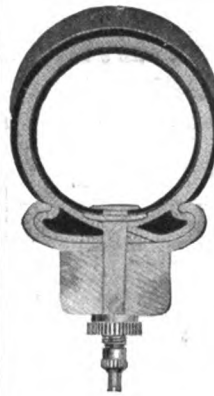

STEIN AUTO TIRES

Good Corn Cob Pipes Come from Missouri

That reminds us about people who want to be shown. They say, "Show me," "I'm from Missouri."

It always takes two to make a bargain. You say you're willing? So are we.

The next time you need tires for your Auto, buy a "Stein," and a make of tire that has given you the best results. After your experience with both you will say, "The Stein Tire has all the good merits, without the faults of other tires." One feature which impressed you forcibly, you had no punctures from pinching or chafing of inner tubes, and, having a heavy tread, it lasted you so long that you are now an ardent supporter of Stein tires.

THE STEIN DOUBLE CUSHION TIRE CO. AKRON, OHIO

TRAINING EFFICIENCY

OUR MEN GIVE THE BEST POSSIBLE SERVICE AND ARE RELIABLE

WE SUPPLY EXPERIENCED CHAUFFEURS AND SECOND MEN

ADDRESS 15 HARCOURT ST. BOSTON.

TEL B.B. 4126-1

THE BRUSH RUNABOUT

THE WORLD'S MOST WONDERFUL AUTOMOBILE



Wonderful in its simplicity, its staunchness, its reliability, its ease of riding, its convenience, and above all in its almost unbelievable economy. Nothing built compares with it in these respects, as even competitors admit, and the public knows.

Model B, price \$500, \$550

SEND FOR LITERATURE

Brush Runabout Co., 410 Baltimore Ave. DETROIT, MICH.

"Bay State" Autokit



A high-grade tool most attractively put up. Is very powerful and practical. Will reach and turn any nut in any place on the car. Has steel sockets, white nickel finish. Two sizes.

Large, \$12.00

Small, \$10.00

GEO. A. CUTTER, Sales Agent, Taunton, Mass.

PENNSYLVANIA

The Power of This Car is Tremendous

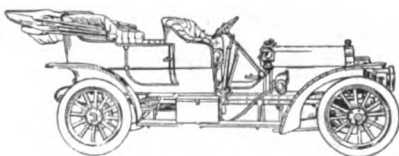

No Demand is too Great for it

PENNSYLVANIA AUTO MOTOR CO., Bryn Mawr, Pa.



AMERICAN CYCLOPEDIA

the AUTOMOBILE

Just from the press. 6 Large Volumes, 2,700 Pages, describing technically the motor car in every detail by the most celebrated automobile experts. Hundreds of illustrations and drawings.

Some of the Editors: T. H. RUSSELL, LL.B., M.E., CHAS. P. ROOT, CHAS. E. DURYEA, VICTOR LONGHEED
Not a luxury, but a necessity for every Owner, Repairman, Dealer, Chauffeur and Student.

Publishers' Advertised Price, \$18.50

Our Introductory Price, - - 12.00

This offer holds good to the first 100 subscribers

BACON & FYNNEY, 120 Boylston Street, Boston, Mass.

SEND NO MONEY—We pay express charges—look the books over for 5 days if you want them, send \$2 and \$2 per month until \$12 is paid. If not satisfactory, return at our expense.



AUTOMOBILE WHEELS
Not the ordinary kind
AUTO-BUGGY WHEELS
Superior in quality and workmanship
25 YEARS, EXPERIENCE IN WHEEL MAKING CERTAINLY IS AN ADVANTAGE; WE HAVE IT
We would be pleased to figure with you on your requirements
THE TURNBULL WAGON CO.,
DEFIANCE, OHIO.

LIGHT WEIGHT SILENCE SUCTION

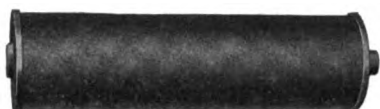

XARGIL VACUUM MUFFLER

"The Muffler with a Guarantee"

Many Muffler Manufacturers make extravagant claims as to silence and back pressure. On trial you find that the muffler does not fulfill the claims made for it but THEY HAVE YOUR MONEY and you have no recourse except to grin and bear it. WE KNOW that our muffler will do all that we claim for it and every muffler we retail is sold under the following broad

GUARANTEE.

We guarantee all goods sold by us to be exactly as represented and of good workmanship and material, and IF IN FIVE DAYS AFTER RECEIPT OF MUFFLER, THE PURCHASER FINDS THE MUFFLER UNSATISFACTORY IN ANY WAY, HE MAY RETURN THE MUFFLER TO US AND RECEIVE HIS MONEY BACK, LESS THE FORWARDING AND RETURN CHARGES.

Write us for Descriptive Booklet and Prices.

Xargil Manufacturing Co. Genesee St., Utica, N. Y.

GEARS AND GEAR CUTTING



Our equipment is suitable for making all shapes and sizes and in any quantity
THE NEW PROCESS RAW HIDE CO., Syracuse, N. Y.

Write for full particulars about the **OAKLAND "FORTY"**

4-cylinder, shaft drive. Also for a copy of "Oakland Toasts"

Oakland Motor Car Co.
204 Oakland Avenue Pontiac, Mich.

"Universal" Detachable Full Tread



The Tread with an ADJUSTABLE TENSION ANCHORAGE. Unlimited TENSION; Always ADJUSTABLE; A Positive Anchorage which Eliminates all possibility of TIRE INJURY from FRICTION AND ABRASION. Special STEEL BURR AND RIVET ARMOR all the way over, affording POSITIVE TRACTION, ABSOLUTELY NON-SKID and PUNCTURE PROOF. The SAFE AND SANE TIRE PROTECTOR FOR ALL POSSIBLE ROAD CONDITIONS.

Write for Descriptive Circulars and prices! It with our Special Introductory Proposition direct from the Factory to the User for 1909.

UNIVERSAL TIRE PROTECTOR CO., Angola, Ind.

WORCESTER ROTARY SWITCH



THE LATEST AND BEST OPERATION HAND OR FOOT
BAT. OFF MAG.

W. H. LELAND & CO.
WORCESTER, MASS.

TIRE TROUBLES ELIMINATED BY USING THE CLEVELAND Puncture Proof Tire



CROSS SECTION

A tire with all the resiliency of pneumatics, with ten times greater durability and with absolute freedom from punctures. You may run over nails, tacks or broken bottles without fear of hindrance incident to pneumatics. Made of the highest grade Up-River Para Rubber in special structural formation that renders all these claims possible and makes these the most desirable and economical tires you can use. You'll be interested in full facts—write for them to-day.

CLEVELAND PUNCTURE PROOF TIRE CO.
68 East Seventh Avenue, Columbus, O.

BUY TIRES BY THE MILE



Don't compare first costs. Find out how many miles of service the different makes of tires give—then figure the cost per mile. You will find that

G & J TIRES

Cost the least per mile without any exception and under all conditions. You can have G & J Tires on your new cars if you specify them. You will not get the best tire service unless you do.

Write for catalogue and prices.
G & J TIRE CO.,
INDIANAPOLIS, IND.

WESTON ELECTRICAL INSTRUMENT CO.

Electrical Measuring Instruments

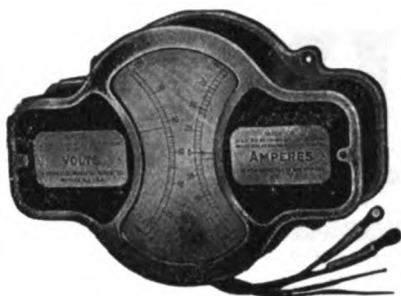

Combination Volt and Ammeter Model 39



Switchboard Instrument Model 159

FOR USE IN
Electrical Carriages and in Charging Stations

Send for Catalogue

Main Office and Works, Waverly Park, Newark, N. J.
New York Office, 114 Liberty Street

London Branch: Audrey House, Ely Place, Holborn.
Paris, France: E. H. Cadot, 12 Rue St. Georges.
Berlin: Weston Instrument Co., Ltd., Ritterstrasse, No. 88.

AUTOMOBILE WHEELS

MANUFACTURED BY

SHORTSVILLE WHEEL CO.

SHORTSVILLE,
NEW YORK

PATTERSON
WIRELESS
DRY
BATTERY
SYSTEM

If you were an Electrical Engineer you'd never let your new car come to you with Storage Batteries for Reserve Ignition.

You'd certainly prefer a Battery Set that requires attention only once or twice in the whole season!

—and that's all the Patterson Wireless Battery System requires. Its fundamental principle is a **SCREW TOP BATTERY CELL** which, without wires or binding posts, screws into a Solid Rubber Composition Plate, automatically making all connections. This moulded Rubber Plate forms a solid, substantial, **waterproof** cover for the Battery Box, and as all Contacts are moulded solid into this Rubber Plate, **no possible loosening of**

connections, bad contacts, trouble from dampness, or anything of this sort is possible. The Battery Cells are **SUSPENDED** from the Plate and do not rest on any surface where dampness can collect. Send for Bulletin 62.

STANLEY & PATTERSON, 23 Murray St., New York
NOTE—Battery Cells to fit "Patterson" Wireless Dry Battery Holders are now regularly manufactured by all prominent makers of Dry Cell Batteries throughout the country. When ordering Batteries simply specify that the "Patterson" Screw Top Cell is required in place of the old Binding Post Type of Cell. Do not forget that you can use old style binding post cells if, in an emergency, "screw top" are not at hand.

"You Screw the Battery In
—We've Done the Rest."



WHO FOOTS YOUR BILLS?

When the garage employees use your car or run the engine without load while standing on the washing platform who pays for the gasoline and the lubricating oil consumed? When they idly run the engine and clog the cylinders and valves with carbon deposits, who pays to have the engine taken down and the carbon cleaned out? When some one gets away with your car after you have left it standing at the curb, at whose expense is it recovered and who pays for the necessary repairing?

IT IS UP TO YOU!

The one way to stop all this is to equip your car with a **BREAK CIRCUIT AUTO LOCK** which absolutely makes it impossible for anyone to use your car or even start the engine without the use of one of the Yale keys furnished you with the locking device. **YOU ARE THEN MASTER OF YOUR OWN PROPERTY.**

The price of this device will be saved in a month's time and **YOU CAN PROVE IT BY COMPARING YOUR MAINTENANCE BILLS.** Communicate with nearest representative to you.

- Skinner & Skinner, 1427 Michigan Ave., Chicago, Ill.
- A. A. Duebel, Box 211, Cleveland, Ohio.
- G. L. Wands & Co., 303 Century Bldg., Denver, Colo.
- H. I. Sackett Electric Co., Buffalo, N. Y.
- F. E. Spelman, 127 Warren Ave., Boston, Mass.
- Geo. A. Deckert, 614 S. 8th St., Minneapolis.

Safety Device Company, Sole Manufacturers Indianapolis, U.S.A.

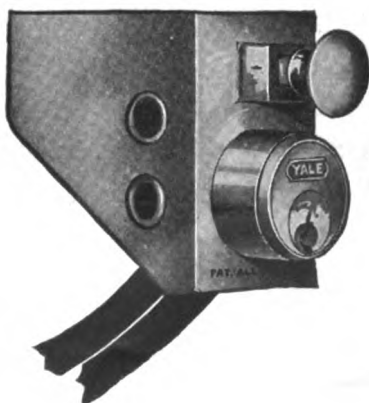

BUICK WINS C

Louis Chevrolet, driving a 30-horse power \$1,750 BUICK, won the Cobe Trophy Stock Car Race, defeating NINE cars of greater horsepower and greater price.

BUICK CARS ALWAYS LEAD IN
SPEED AND POWER CONTESTS

ALL THE WORLD

BUICK MOTOR COMPANY

Factories: FLINT, MICHIGAN

OBE TROPHY

30 H. P. Buick Beats
Two 40 H. P. Locomobiles

30 H. P. Buick Beats
Two 48 H. P. Knoxes

30 H. P. Buick Beats
Two 44 H. P. Stoddard-Daytons

30 H. P. Buick Beats
Two 53 H. P. Appersons

30 H. P. Buick Beats
One 24 H. P. Fiat

LOVES A WINNER

BRANCHES:—New York, Boston, Utica, Syracuse, Saginaw, Toledo, Atlanta, Albany, Indianapolis, Grand Rapids, Battle Creek, Chicago, Cleveland, Detroit, Washington, Buffalo, Philadelphia, St. Louis, Kansas City and Pittsburgh. Buick Automobile Co., Dallas, Texas, Distributors for Southwest.

Patent applied for

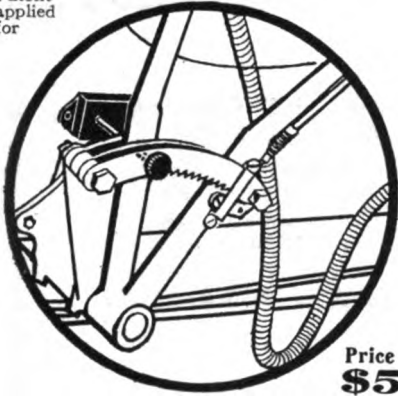

Price \$5

READ THIS

THE BONGARTZ COMPANY, City.

New York, March 11th, 1909.

Gentlemen:
Responding to yours of recent date I take pleasure in advising you of the very satisfactory results obtained with your "AUTO-LOCK." As you know, my new MAXWELL was stolen on December 14th last (the same day I bought the car), while standing on the curb on Broadway in New York. And yet, the car was equipped with a so-called "circuit-breaker," but—the thieves connected the wires and started away. A few days after this the Police found my car on 8th Avenue damaged—lamps, horn, in fact all brass parts taken away from it—a loss of some \$150. I then purchased one of your "AUTO-LOCKS" to protect my car, and I highly recommend it as a perfect Auto PROTECTOR, and think that every automobile owner should possess one. Yours very truly, LEOPOLD FRIEDMAN.

Don't you think it is wise to put a lock on your car now, before your car is damaged—or stolen? Is your car worth \$5.00 to you? Why take chances? Lock your car with a Bongartz "AUTO-LOCK" and your car will be safe under ALL circumstances. PRICE, \$5.00.

Send to-day for our catalog, it tells you more.
THE BONGARTZ COMPANY, THOROUGHFARE BUILDING BROADWAY & 57TH ST. NEW YORK



The Practical Gas Engineer

What To Do and How To Do It. A book of 150 pages neatly bound in cloth. Sent postpaid for \$1. Address Book Department, The Automobile, 231-241 W. 39th St., New York.



THIS OFFER IS WORTH 55 CENTS TO YOU

In order to give every automobile owner an opportunity to test the value of our products, we will send by express prepaid, to any point in the United States, the following:

- One 6 oz. can CLEANOLA..... 25c
- One 6 oz. can SPE-DE-SHYNE..... 15c
- Express charges prepaid by us..... 25c

Total value..... 65c

AND ALL FOR TEN CENTS AND YOUR DEALER'S NAME

Cleanola and Spe-De-Shyne are the most remarkable preparations ever offered for keeping automobiles perfectly groomed.

Cleanola renews all varnished surfaces; removes mud stains and rain spots; covers varnish cracks and scratches. Leaves hard, lustrous surface. Can be used with equally good results on Leather Tops and Seats. No acid or alkali.

Spe-De-Shyne imparts a brilliant lasting lustre to all metal surfaces. Dissolves oxidation and discoloration. Does not dry white. No acid, will not injure metal. Does not leave greasy surfaces.

THE CLEANOLA CO., Dept. "C," Fulton Building, Pittsburg, Pa.



Get a "C. K." Ammeter For Testing Your Batteries "SEEING IS BELIEVING"

- C. K. Ammeter, reg. to 30 Amperes, - - Price \$2.00
- C. K. Voltmeter, reg. to 8 Volts, - - - - - 2.00
- C. K. Volt-Ammeter, reg. 30 Amp.—8 Volts, " 2.75

The Motor Car Equipment Co.
1727 Broadway New York 55 Warren St.

WHY NOT

\$20

\$20



\$20

\$20

Buy a

Peerless Speedometer

What is the use of paying good money for a toy, when you can get a reliable speed indicator with combination odometer fully guaranteed with a 4 inch dial, 60 mile reading and all fittings ready to attach for \$18.00 and with maximum hand, \$20.00.

When ordering please state make and model of car together with size of tire.
Peerless Specialty Company, 1874 Broadway New York

'Phone 3872 Columbus Send for folder "D"
All makes of speedometers repaired and parts furnished

"MADE IN SYRACUSE"

Known and Sold EVERYWHERE

You will find it on page 67

Write us to-day—Reduce your AUTO INSURANCE ONE-HALF

THE PERFECTED



GREAT SIX

CHADWICK ENGINEERING WORKS
POTTSTOWN, PA.

Standard Manufacturers A. M. C. M. A.

New Catalog Ready for Distribution

THE fastest stock car in the world. Exclusive in design and construction. Six cylinders 5" bore, 6" stroke. Models for 1910 now ready.

PLEASE MENTION THE AUTOMOBILE WHEN WRITING TO ADVERTISERS

**E. Z. TIRE AUTOMOBILE PUMP
LET THE AUTO DO THE WORK**

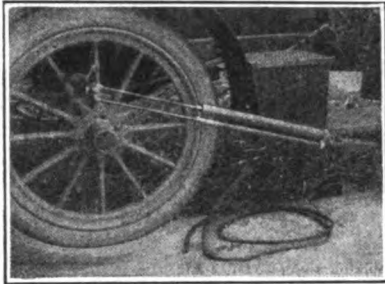

(Patented April 9th, 1909)

One size fits all machines.
THE SIMPLEST, BEST and CHEAPEST POWER PUMP made.
Price \$10.00
 Sent on receipt of price. If not as represented we will refund your money.
 Address Dept. A
Wheaton & Utley
 Sunbury, Ohio

**HOLTZER-CABOT
GAS ENGINE IGNITER**

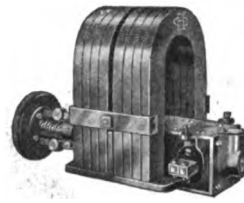

A high grade, low tension Magneto. for Wipe or Jump Spark Systems.

Double Brush Rigging.
 Extra Heavy Shafts.
 Self-feeding Grease Cups.
 High Efficiency.
 Dust and Moisture Proof.

SEND FOR NEW BOOKLET 30 B-9

THE HOLTZER-CABOT ELECTRIC CO.
 395-97 Dearborn St., Chicago, Ill. Boston (Brookline), Mass.

**TRUFFAULT-HARTFORD
SHOCK ABSORBER**

THE FACT THAT TWENTY AUTOMOBILE MANUFACTURERS USE THEM—IS THE BEST PROOF THAT THEY SHOULD BE ON YOUR CAR.

HARTFORD SUSPENSION COMPANY
 140 Bay Street, Jersey City, N. J.
 Branches in NEW YORK—212-214 West 88th Street
 BOSTON—319 Columbus Avenue

**Volcano
Spark Plugs**

will do the work when others fail



To prove this
TRY THEM

Volcano Spark Plug Co.
 Ashland, Ohio

At Dealer's or by Mail,
 \$1.50 Each

\$11,000,000

Worth of experience behind the new

\$1,500 Mitchell

This price includes \$300 worth of extra automobile value not included in other cars selling at this price. Learn what it is.

Write to-day for detailed description.

Mitchell Motor Car Co.
 544 Mitchell Street, Racine, Wis.
 Standard Manufacturers A.M.C.M.A.

Automobile Parts

WE MAKE AUTOMOBILE and MOTOR MACHINE PARTS like these shown in cut BETTER and CHEAPER than others, and give PROMPT deliveries because we have the facilities to turn out the work RIGHT.

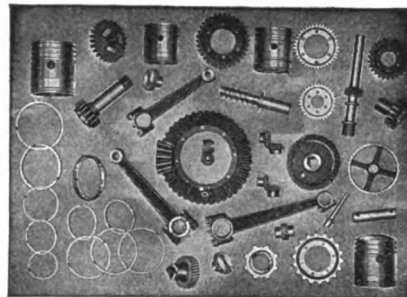

The latest and best machine tools only comprise our equipment.

GENERATED GEARS
 OF EVERY DESCRIPTION



FINISHED DIE-CAST BEARING BUSHINGS
 Made to Specification

Let us submit estimates based on your specifications and blue prints.

SPECIAL—Cams and complete Cam Shafts, Transmission Square Driving Shafts (all ground to dimension) made by special equipment of our own design.

THE F. W. SPACKE MACHINE CO.
 INDIANAPOLIS, IND.



For the convenience of customers desiring immediate delivery, stocks of Shelby Seamless Steel Tubing are kept in many large cities; the location of stock nearest to any specific point will be given on request.

DISTRICT SALES OFFICES

Atlanta, Chicago, Denver, New Orleans, New York, Philadelphia, Pittsburgh, Portland, San Francisco, St. Louis, Salt Lake City, Seattle.

PLEASE MENTION THE AUTOMOBILE WHEN WRITING TO ADVERTISERS

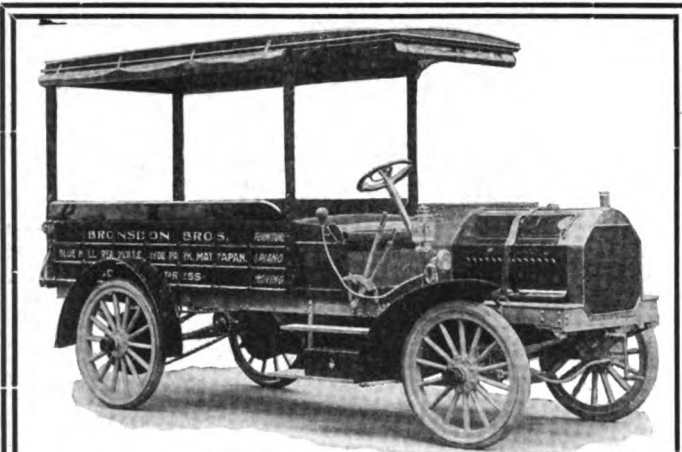

1 1-2 Ton, 4 Cyl., 30 H.P. Truck

MOTOR TRUCKS AND DELIVERY WAGONS

Why use horse-drawn vehicles when a motor-truck will do the work of three wagons. Our cars are built right in every detail, for we are the oldest manufacturers of commercial cars in America. Send for catalogue.

The Auto-Car Manufacturing Co., Buffalo, N.Y.

Distributing Agents

NEW YORK, Jewell Motor Car Co, 1662 Broadway
 BOSTON, J. Gilbert Miller, 73 Central Street
 PROVIDENCE, The Overland Motor Car Co., 17 Snow Street
 PITTSBURG, The Commercial Automobile Co., 1106 Keystone Bldg.

The Only Glove With The "Rist-Fit"

The comfortable GRINNELL "RIST-FIT" consists of a "V" of soft leather in the cuff, which permits a snug fit and keeps the gauntlet from sagging. Grinnell Gloves for Spring and Summer are VENTILATED by tiny perforations across the back, too small to admit dust.

Grinnell  "Rist-Fit" Auto Gloves

are made from the and coltskin leather

toughest "Reindeer" and are washable.

Get a Pair on Approval

Send us your dealer's name, also the size and style you desire. We'll forward a pair promptly, charges prepaid.

Morrison-Ricker Mfg. Co.

66 Broad St., Grinnell, Ia.



PATENTED

Prices \$2.50 Up

Originators and patentees of "Rist-Fit" and Ventilated Gloves.

The Willet Two-Cycle Engine

Nothing like it for Power, Flexibility, Construction, Durability and Smooth Running

W R I T E F O R C I R C U L A R

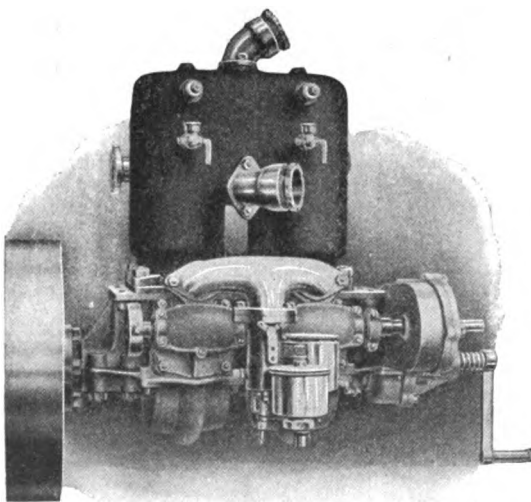

1 2 4 & 6 C Y L I N D E R S

ADDRESS AUTOMOBILE DEPARTMENT

WILLET ENGINE & CARBURETER CO.
 764 Ellicott Square, BUFFALO, N. Y.

Your Old Casing

is good enough for 5000 miles more if equipped with a

Triple Tread

3-ply steel studded, specially prepared leather and made a part of the old tire.

Puncture proof and non-skid. Costs very little more than the ordinary rubber retread.

Remember we guarantee Triple Tread 5000 miles



This is a worn out casing as it comes to us to be MADE NEW



Sectional View of Casing MADE NEW. Note the hardened steel anti-skid studs at the top, the split needle rivets just above the rim and the strip of canvas inside to protect inner tube



Send the Old Casing at once

Triple Tread Auto Tire Mfg. Co.

Phone Cal. 2456

1545 Michigan Ave., Chicago

When your old casing is MADE NEW it looks like this - Guaranteed 5000 miles.

Kemizite

**HEALS PUNCTURES
GUARANTEED
NON-INJURIOUS
AND TO WORK**

KEMIZITE is clean—odorless—and guaranteed non-injurious. Heals all punctures **instantly and forever**. Nothing escapes it. Not a cement or filler. Only a very small quantity needed occupying about 5% of tube capacity. Therefore, it does not reduce resiliency.

SAVES YOU MONEY by saving your tires—increasing mileage. Seventy-five per cent. of all blow-outs are directly traceable to punctures and slow leaks. **KEMIZITE** stops them.

THE MINUTE YOU want tire happiness, order **KEMIZITE**. It will cost you from \$10.00 to \$20.00, depending upon the size of your tires. You know what it's worth. If you must have further information, evidence, etc., first, write.

Auto Tire Security Company

1230 Michigan Ave., Chicago 14 Cambria St., Boston
Dept. A

Pullman AUTOMOBILES

Viewed from any standpoint you can't match the "PULLMAN" quality, the "PULLMAN" prices or the wonderful "PULLMAN" efficiency, design, simplicity of construction, ease of operation, economy of up-keep, durability; in fact "PULLMANS" are in every feature incomparably superior to any car yet designed at any where near "PULLMAN" prices. A model to meet every requirement at the right price.

\$1500 TO \$3500

RUNABOUTS TOURING CARS LIMOUSINES
FOUR AND SIX CYLINDERS



\$2000

Every step from the raw material to the finished car in the progress of the making of a "PULLMAN" Automobile is under the eye of an expert in **OUR OWN FACTORY**. We stand back of "PULLMAN" quality, which is the highest standard that can be produced. Not one part bought elsewhere and assembled, but all one perfected whole.

These are some of the reasons that enable us to give the "PULLMAN" quality and the "PULLMAN" prices.

In your own interest don't buy a car until you have full particulars of the "PULLMAN" make.

Information cheerfully furnished. Write to-day.

Agents wanted in unoccupied territory.

YORK MOTOR CAR COMPANY

YORK, PA.



FISK INNER TUBES TO FIT ANY TIRE

The Best by chemical analysis and by the test of actual wear.

Not one-tenth of one per cent. of our yearly output show any defect.

Ask your dealer for Fisk Inner Tubes.

THE FISK RUBBER COMPANY
2 Main St., Chicopee Falls, Mass.



Rayflex Flashlight No. 2

Case is made of vulcanised fibre in two sizes and colors, red and black fitted with tantalum lamps and our famous seamless battery cups. The only light fitted with these cells

Price, \$1.50

Write for jobbers' discount.

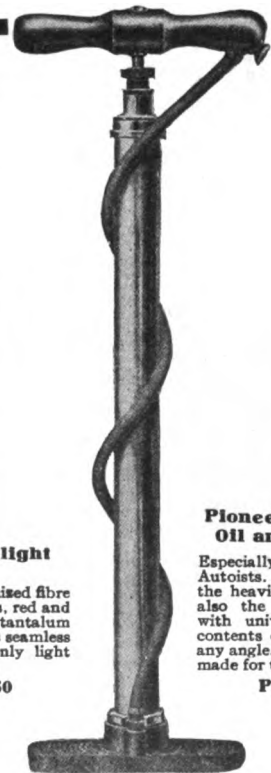

Pioneer Combination Oil and Grease Gun

Especially adapted for use by Autoists. Will lift and discharge the heaviest grease with ease, also the lightest oils. Fitted with universal ball nozzle—contents can be discharged at any angle. The best article ever made for this purpose.

Price, \$2.00

Write for illustrated circular and jobbers' discount

Pioneer No. 10

A brand new Pump especially adapted for inflating automobile tires. It is a compound Pump with only one cylinder—something never achieved before. There is absolutely no valves to get out of order, and no flanged joints, making it easy for anyone to take it apart and clean or repair. Its simplicity of construction is shown in the fact that it can be taken apart and reassembled in less than one minute.

Price, \$2.25

Write for illustrated circular and jobbers' discount

MANUFACTURED BY

THE STANDARD SHEET METAL CO., Passaic, N. J.

FOR THE TOURIST
OR GENERAL MOTORIST

HARRIS OILS

TRADE MARK - REG. U.S. PAT. OFF.

ARE UNEQUALED
IN LUBRICATING QUALITY
WHY?

Afford preservation of all wearing parts therefor saving TIME and MONEY.

POWER PRODUCING which by a smaller quantity is made greater.

Fulfills EVERY REQUIREMENT finally leaving spark plugs and cylinder walls FREE from deposit.

THE BEST OIL TELLS
SOLD EVERYWHERE

A. W. HARRIS OIL CO.,
324 SO. WATER ST., PROVIDENCE, R. I.

ECONOMICAL IGNITION Radium Magneto

The most durable and dependable because of most simple construction, of best materials. Generates a fast, fat, hot spark. Current discharged through transformer, making high tension and providing for double ignition by use of storage batteries. Starts on quarter turn. Imported ball bearings throughout. Write for circular.

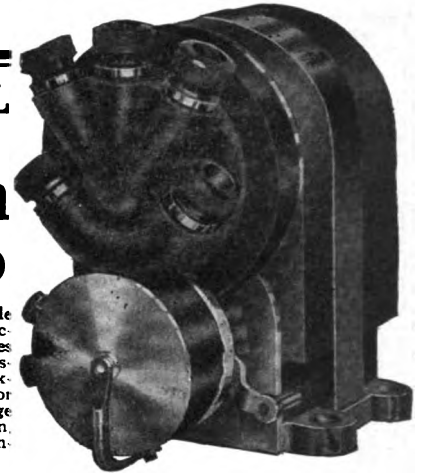

Decarbonizer Increases Hors Powe. 20%



Eliminates friction caused by carbon deposits on cylinder sides, piston rods, rings and valves by volatilizing carbon in which form it passes exhaust as smoke. Not harmful to metal. In general use among best informed automobilists. Sold by most dealers. Beware of imitations, dangerous to use. Get the genuine. Sample quart sent direct for \$1.50. Agencies open in some localities.

GENERAL
ACCUMULATOR & BATTERY CO.
150 Second Street, Milwaukee, Wis.

DON'T run risks of injury to your car, your driver and yourself, but avoid accidents, save wear and tear and run your auto on all sorts of roads, in all kinds of weather by equipping with



“PERFECTION”

Non-Skid Climbers

Simple, Certain, Practical.
Affords Positive Traction Regardless of Road Conditions.

It is the only device on the market that gives perfect satisfaction, and will outwear any other two pairs of climbers or chains made.

“Perfection” Non-Skid Climber's superiority lies in its simplicity of construction, ease of adjustment and absolutely infallible action. It has but three working parts, can be easily and quickly put on and taken off, and operates on a simple mechanical principle which

PATENTED JUNE 7, 1904—JULY 10, 1906

invariably, instantly and automatically checks all skidding and prevents wear of tires.

If your local dealer in automobile supplies cannot supply you with “Perfection” Non-Skid Climbers, accept no substitute but send direct to the factory. We will fill your order promptly and guarantee satisfaction.

PERFECTION NON-SKID CLIMBER CO.
EDON, OHIO

Pacific Coast Representative, PACIFIC SALES CORPORATION
50-56 Van Ness Avenue, San Francisco, Cal.

Live, Active Agents Wanted in Every Town

AVOID FOOLISH SIGNALS GET THE BEST



The “Nightingale” Whistle

The signal with a bird-like trill.
Has them all beaten a mile in penetration and a million miles in attractiveness. Attached to the exhaust before the muffler it throws the sound ahead.

Guaranteed to work satisfactorily on 1 and 2 cylinder cars.

Never clogs.

Made in four sizes. All the same price.

Complete Outfit **\$7.00** F. O. B. New York

Each genuine “Nightingale” is guaranteed and bears its name as imprint.

Nightingale Whistle Mfg. Co.
1697 BROADWAY NEW YORK

Zimmerman ^{HIGH WHEEL} Automobillos



MODEL I, \$750.00

13-H. P., 2-cylinder opposed type, air-cooled motor, 37-inch wheels
1 1/2-inch solid rubber tires



MODEL H, \$650.00

16-H. P., 2-cylinder opposed type, air-cooled motor, 37-inch wheels,
1 1/2-inch solid rubber tires

Ideal Machines for Business and Pleasure

Write for Our Handsome Catalog No. 9 which describes all our models

ZIMMERMAN MFG. COMPANY 411 Indiana Ave.,
Auburn, Indiana

Chicago Agency:
John Hemwall Automobile Co., 2279 Washington Boulevard

30 DAYS' Free Trial of the Thomas Shock Absorber

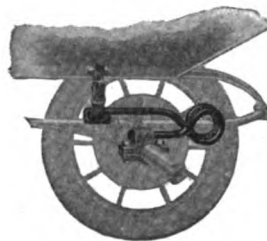

Send us the name, model and year of your car and we will ship you a set on 30 days' free trial. If satisfactory send check—otherwise return absorbers in 30 days.

The Thomas Shock Absorber will eliminate up-throw jolts and prevent breakage of springs, but will not interfere with the downward action of springs.

Write to-day for full particulars.

BUFFALO SPECIALTY CO.
Dept. R BUFFALO, N. Y.

Electric Ignition —For— Motor Vehicles

By W. HIBBERT, A.M.I.E.E.



THE book contains the substance of a series of lectures to automobilists on electric ignition applied to motor vehicles. The subject is dealt with in a very complete manner, but in such a way that a novice should have no difficulty in following the instruction. A precisely written introduction on electric ignition should remove all the difficulties which beset the beginner. The subjects dealt with in detail are: Batteries, commutator and coil; magnetic fields; synchronous ignition in multiple-cylinder engines; faults; and magneto methods of ignition. This last chapter explains in detail a few of the best-known makes of high and low-tension magnetos. Sixty-two diagrams illustrate the text.

128 Pages. Cloth Bound. \$1.00

The Class Journal Company 231-241 W. 39th St.
New York.

CLUSTER-LOOP

DOUBLE LOOPS
DOUBLE LIGHT

TUNGSTEN

LAMPS FOR
AUTO ELECTRIC
LIGHTING

THE MOST BRILLIANT LIGHT KNOWN
WRITE TO
THE WILLARD STORAGE BATTERY CO. Cleveland, Ohio.

MASURY

SUPERFINE
**AUTOMOBILE
 COLORS
 AND
 VARNISHES**

MANUFACTURED BY
JOHN W. MASURY & SON
 NEW YORK
 CHICAGO - ST. LOUIS - MINNEAPOLIS

— ESTABLISHED 1835 —

SUPPLEMENTARY SPIRAL SPRINGS



No. 2
 Outside Hanger,
 Carrying Spring
 on Stud End.



No. 4
 Platform Spring



No. 7
 Scroll End Spring



No. 3
 Full Elliptic

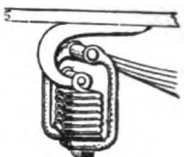

No. 6
 Curved Hanger,
 Shackles Attached
 to Hanger
 Below Spring End



No. 5
 Shackles Attached
 Direct to Spring
 Above Spring End

Saves your engine, saves your car, nerves and temper, the use reduces repair bills and the savings effected in all ways make SUPPLEMENTARY SPIRAL SPRINGS a paying investment. Ask for illustrated booklet and testimony of users.

**ST. LOUIS
 SUPPLEMENTARY
 SPIRAL SPRING CO.
 INC.**
 Main Office and Factory:
 4529 Delmar Ave.,
 ST. LOUIS, MO.
 200 Motor Mart Bldg.
 62d St. and Broadway
 NEW YORK

BOSTON, 89 Boylston Street.
 CHICAGO, 1018 Michigan Avenue
 PACIFIC COAST, 24 Stanyan Street,
 San Francisco, Cal.
 The T. Eaton Co., Toronto, Canada.



National

Just as Faultless as It Looks

Classy and Capable

Classiest looking car in America—you can see that at a glance.
 None runs more sweetly—your ears will tell you that whenever one passes.
 None has more speed. Please look up the big 1909 race and hill-climb records.
 None gives more satisfactory service—any National owner will tell you that.
 None is more carefully or honestly built—every Automobile Engineer knows that.

We are making prompt deliveries.

NATIONAL MOTOR VEHICLE COMPANY
 1000 E. 22d Street, Indianapolis, Indiana

1909 BABCOCK ELECTRICS

Perfect Electric Carriages in Every Part. Representing the Very Highest Development in Electric Motor-Car Design and Construction.

For reliability, ease of operation, cleanliness, high speed and comfort

BABCOCK ELECTRICS

are beyond comparison. They give more actual, dependable service, day in and day out the year through at a lesser proportionate cost of operation, than any other type of motor vehicle.

A few points of superiority are:

LUXURY	ECONOMY
SAFETY	SPEED
COMFORT	SILENCE
HILL CLIMBING	
STYLE	
DURABILITY	
	MILEAGE
	SIMPLICITY

Full information on request,
 Write to-day

Babcock Electric Carriage Co.
 BUFFALO, N. Y.

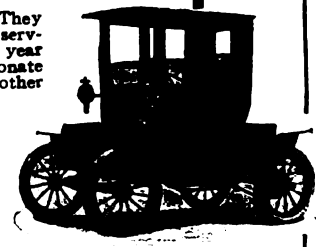

PLEASE MENTION THE AUTOMOBILE WHEN WRITING TO ADVERTISERS

SKINNER RECOIL CHECKS

THE GUARANTEED VOLT ELIMINATOR

A 30-DAY
FREE TRIAL
WILL CON-
VINCE YOU
THEY ARE A
NECESSITY TO
ENJOYABLE
MOTORING

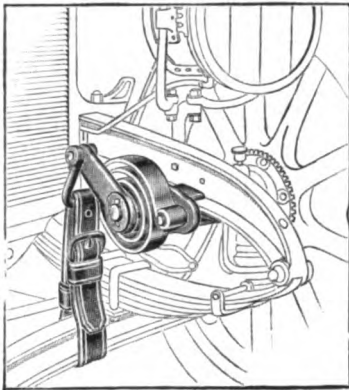

CLAMPS
TO
THE
FRAME
—
NO
HOLES
TO BE
DRILLED

\$20.00 SET OF FOUR

Does not interfere with or stiffen the springs, but prevents the reaction, and upthrow jolts. Write us! We will be glad to tell you about them.

SKINNER & SKINNER CO., Manufacturers
1429 Michigan Avenue, Chicago, Ill.
Eastern Representative, W. E. Baker, 1779 Broadway, N. Y. City

First on Land, First on Sea,
First in the Hearts of All Motormen

Mosler Spit Fire PLUGS

Lead the World

The Greatest Test of Endurance
the World Has Ever Known

A Triumph for the Spit Fire

The ONLY Plugs in the WORLD
that ACTUALLY Spit Fire

INSIST ON THE GENUINE, with Name on Porcelain and Base



REGISTERED TRADE MARK



PACKED IN THIS
BOX FOR YOUR
PROTECTION

A. R. MOSLER & CO., 163 West 29th St., New York

The Miller Porcelain Spark Plug

We have been manufacturing the well-known Miller Mica Spark Plug for the past five years, and it has proven to be one of the most serviceable and satisfactory plugs on the market. There has, however, been a constant demand for a first-class Porcelain Plug. On account of the demand for a Porcelain Plug we have done considerable experimenting, the result of which is the Spark Plug illustrated. We have arranged to manufacture this plug in large quantities and in this way have reduced the cost of manufacturing the Plug, and we offer one of the best Spark Plugs on the market at a low price. The material and workmanship are the finest on the market and are guaranteed



Price, 1/4 inch Pipe Thread or
Metric Thread.....\$0.75 each
Porcelain only..... .20 "

CHAS. E. MILLER
Manufacturer, Jobber, Exporter and Importer
HOME OFFICE, 97-99-101 READE STREET, NEW YORK CITY

BRANCHES: New York City, 924 Eighth Ave.; Philadelphia, Pa., 318-320 N. Broad St.; Cleveland, Ohio, 1829 Euclid Ave.; Boston, Mass., 202-204 Columbus Ave.; Detroit, Mich., 227 1/2 and 229 Jefferson Ave.; Buffalo, N. Y., 824 Main St.; Brooklyn, N. Y., 1392 Bedford Ave.

As perfect cuts as can
be produced for letter-
press printing.
Send us your orders.

MOSS

MOSS
PHOTO-ENGRAVING
CO.
295-309 LAFAYETTE ST.
(Corner Houston)
"Puck" Building, New York

Matheson

RECENT VICTORIES

FIRST AND SECOND

IN WASHINGTON-HAGERSTOWN 168 Miles Sealed Bonnet Contest, May 15th, 1909, Winning Washington Post Cup, against a field of 18 contestants.

PERFECT TIME AND ROAD SCORES

IN NORRISTOWN-HAGERSTOWN 400 Miles Endurance Contest, May 18-19, 1909, against a field of 32 contestants.

TWO MORE PERFECT SCORES

IN NEW YORK-BOSTON 247 Miles Endurance Contest, March 11th, 1909, against a field of 20 contestants.

FIRST, SECOND and THIRD TIME PLACES

IN PHILADELPHIA - WILKES-BARRE 300 Miles Mid-Winter Contest, against a field of 32 contestants, January 1-2, 1909, **only three of the 32 cars had perfect scores and**

THOSE THREE WERE MATHESONS

The Conclusion The Matheson Car has proved in every contest it has entered that it is far and away the most reliable and serviceable, as well as the most economical and the fastest touring car in the world.

50 H. P. Six Cylinder Shaft Drive, **\$3,000**
Equipped with choice of Touring, Tourabout, Toy Tonneau, Close Coupled or Runabout Bodies.

50 H. P. Four Cylinder Chain Drive, **\$5,000**
Equipped with Touring Body.

Limousine or Landaulet, **\$5,750**
Roadster or Tourabout, **\$4,750**

Matheson Automobile Co.

Main Sales Office: 1886-1888 Broadway

Factory: WILKES-BARRE, PA. NEW YORK CITY

HOW TO AVOID TIRE TROUBLES

To-day automobile troubles are largely tire troubles. Eighty per cent. of up-keep expense is tire expense. When you are tied up on a lonesome road 20 miles from nowhere—nine cases out of ten it's TIRES.

—And nine cases out of ten the blow-outs which waste money and kill pleasure were caused by *overloading*.

—Tops, glass fronts, gas tanks, searchlights, extra seats (an invitation for more passengers), storage batteries, extra casings and pounds of luggage are added to large and small cars alike.

—Before you know it your tires are carrying from 200 to 300 lbs. more than they were *ever built to carry*. The result is certain, quick destruction—heavy expense—trips of trouble instead of pleasure—and a world of humiliation for the man who owns the car. Rubber, strong as it is, has its limitations.



Goodyear Automobile Tires overcome these conditions because EVERY SIZE IS OVERSIZE. They are full 15% larger than any other automobile tire in the market sold for the same size. A Goodyear 4-inch tire measures almost 4 1/2 inches. If a set of tires of another maker will safely carry 2,000 lbs., Goodyear Tires of the same size will with equal safety carry 2,300 lbs.

But even if your tires are ample for their load—even if your car is not weighted down with accessories—think what the extra 15% means to you as a "margin of safety," to say nothing of comfort.

Every bit of material in the car you drive has a "margin of safety" of 5 to 7—it must be capable of bearing a strain 5 to 7 times greater than it will ever be subjected to. Tires alone are expected to work to the limit of their resistance. When you overload them there is no "margin of safety." It has been exceeded. You are taking chances every minute you drive.

Think carefully what this 15% oversize (to be secured only in Goodyear Tires) means to you.

To know all the good points of this wonderful tire, write for our helpful book, "How to Select an Auto Tire."

The Goodyear Tire & Rubber Company Freedom Street, Akron, Ohio

Branches and Agencies:—Boston, Mass., 261 Dartmouth St.; Cincinnati, Ohio, 317 E. 5th St.; Los Angeles, Cal., 949-51 S. Main St.; Philadelphia, Pa., Broad and Fairmount Ave.; New York City, 64th St. and Broadway; San Francisco, Cal., 506 Golden Gate Ave.; Chicago, Ill., 80-82 Michigan Ave.; Cleveland, Ohio, 2005 Euclid Ave.; Milwaukee, Wis., 188-192 8th St.; St. Louis, Mo., 3935-7 Olive St.; Buffalo, N. Y., 719 Main St.; Detroit, Mich., 251 Jefferson Ave.; Pittsburg, Pa., 5988 Centre Ave.; Omaha, Nebr., 2010 Farnam St.; Washington D. C., 1026 Connecticut Ave.; Atlanta, Ga., 90 N. Pryor St.; Louisville, Ky., 1049-51 Third St.; New Orleans, La., 706-16 Barronne St.; Memphis, Tenn., 181-5 Madison St.; Dallas, Tex., 111 N. Akard St.; Denver, Colo., 28 W. Colfax Ave.; Baltimore, Md., 991 Park Ave.; Kansas City, Mo., 16th and McGee Sts.; St. Joseph, Mo., 316-24 N. 2d St.; Providence, R. I., 366 Fountain St.

FIERCE!

"I get bumped worse than ever since putting on those Shock Absorbers. I should have taken the dealer's advice and put on

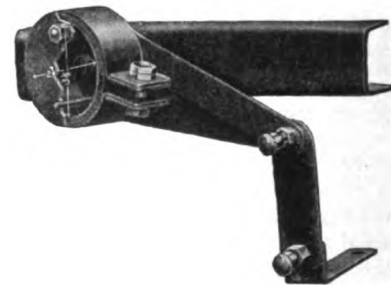

FOSTER SHOCK ABSORBERS

which don't throttle the springs, but allow them to act freely on smooth roads and only get busy when we hit the rough spots."

Built on right principle. Free in center and bind gradually going up and coming down.

ASK ANY MECHANIC

WRITE FOR BOOKLET AND PRICES

Agents Wanted Everywhere

FOSTER SHOCK ABSORBER

1410 EAST 40th STREET

CLEVELAND, OHIO

The White Line Radiator belongs
to the Stearns

STEARNS

The Stearns Motor Cars

Belong to People who have the Best

The F. B. Stearns Company

Factory and General Offices,
Euclid Ave., Cleveland, Ohio
Member Association of Licensed Automobile
Manufacturers

"CAR COMING!"

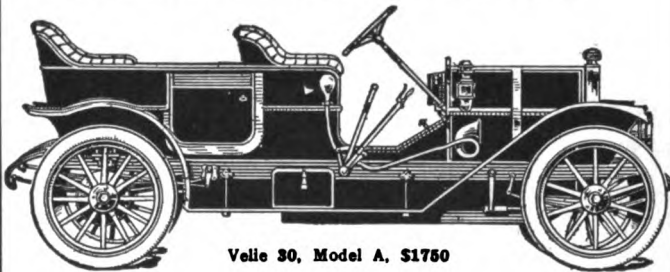

Velie 30, Model A. \$1750

You must see the Velie 30 if you want to know how good a car can be sold for \$1750. Same motor, same transmission, same axles as are used in the best \$2750 cars. Velie design is snappy and graceful—Velie workmanship is highest grade—Velie tests are positive and convincing—Velie guarantee (for one year, not ninety days), is most liberal.

The Velie Line includes touring car, tourabout, roadster with single or double rumble seat and toy tonneau, all with generous equipment.

Dealers and agents who are looking to the future as well as the present, will be interested in the Velie proposition.

Write for Catalogue

**VELIE
MOTOR
VEHICLE
CO.**

MOLINE, ILLINOIS

Following are Leading Distributors:
John Deere Plow Co., Kansas City, Mo.
Deere & Weber Co., Minneapolis, Minn.
John Deere Plow Co., Omaha, Neb.
Velie Motor Vehicle Co., Moline, Ill.
Velie Motor Vehicle Co., Chicago, Ill.
Kilbourne-Corlew Motor Co., Boston, Mass.
Overbaugh-Martin Motor Co., New York, N. Y.
Keystone Automobile Co., Pittsburg, Pa.
Standard Motor Car Co., San Francisco, Cal.
Standard Motor Car Co., Los Angeles, Cal.
Blue Grass Auto Co., Lexington, Ky.

Veeder Tachodometer

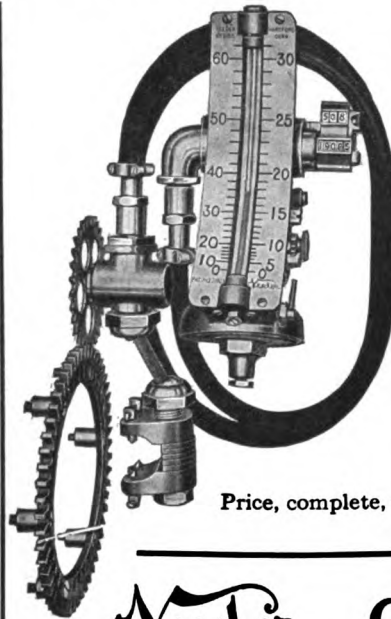

The most scientific and complete speed recording device of the age

The only permanently accurate speed indicator in the world.

Registers how far, total, and for each trip and shows exact speed at all times, in plain, readable figures, from zero to 62 miles an hour.

No springs, magnets or other variable elements. No delicate mechanism. Only one moving part. Ball bearing throughout

Price, complete, ready to put on any car, \$50.00

Veeder Odometer

Form D

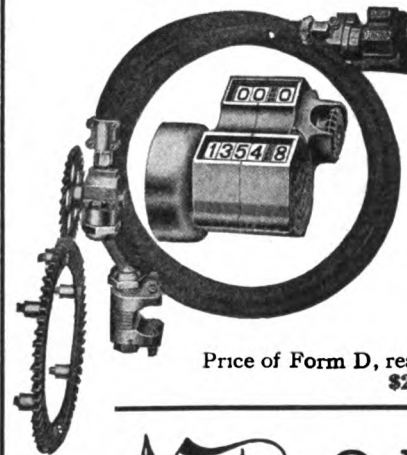

This instrument goes on the dash and has two registers, the upper being a trip register which may be set to zero at will, while the lower keeps a record of the total number of miles traveled.

Veeder Odometers and Tachometers are adaptable to any car and are acknowledged the best made. "Veeders" were an established success before the inferior imitations were even thought of.

No speedometers have ever equalled the "Veeder" in any feature.

Price of Form D, ready to put on any car, \$20.00

Veeder Odometer

Form B

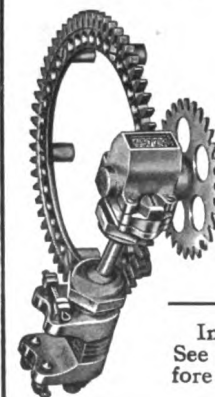

Same style and quality as above instruments, except this is intended as a single trip odometer and attaches to the steering-arm, making an accurate record of the number of miles traveled.

Like all Veeder products, this type of odometer is exceedingly popular because of its high efficiency and low price.

Price of Form B, ready to put on any car, \$10.00

In your own interest get full particulars. See a "Veeder" in operation if you can before buying any other device. *It will pay you*

THE VEEDER MFG. COMPANY

22 Sargeant St.,

HARTFORD, CONN.

Represented in Great Britain by Messrs. Markt & Co., Ltd., 6 City Road, Finsbury Square, London, E. C., England.

Republic Staggard Tread Tires

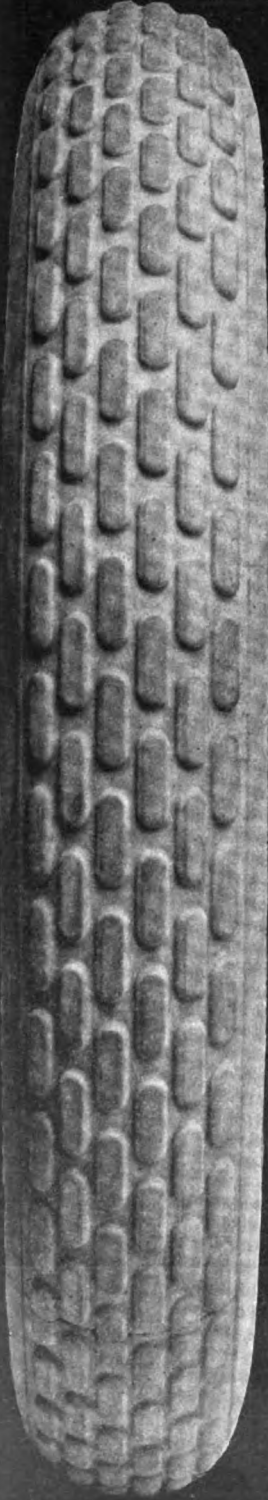

HERE is a Tire that gives the full mileage that a smooth tread tire gives and is also an anti-skid when the road is wet. No stopping to put on tire-chains. Other anti-skid tires are so short-lived that they are limited to use in wet weather.

Look up the Staggard Tread.

REPUBLIC
RUBBER
CO.

Youngstown
Ohio

New York City 229 W. 58th St.
Boston 735 Boylston St.
Chicago 116 Lake St.
Philadelphia 830 N. Broad St.
Cincinnati 8th and Walnut Sts.
Cleveland 5919 Euclid Ave.
Milwaukee 457 Milwaukee St.
St. Louis 3964 Olive St.
Detroit 216 Jefferson Ave.
Los Angeles 1046 So. Main St.
Denver 1721 Stout St.
San Francisco 166 First St.
Toledo 2815 Monroe St.
Indianapolis 208 S. Illinois St.
Pittsburg 627 Liberty Ave.
Seattle 1416 Broadway
St. Paul 186 E. 4th St.
Rochester 208 South Ave.
Kansas City 1512 Grand Ave.
Council Bluffs, Ia.

Republic Staggard Tread, Pat. Sept. 15, 22, 1908.

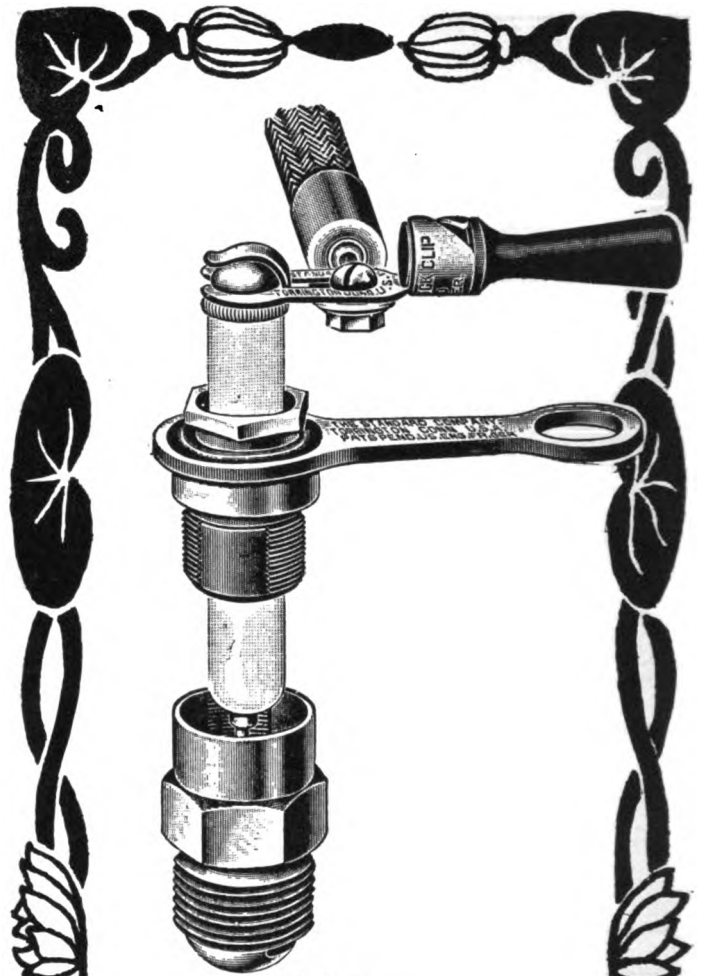

The
"Breech-Block"
Plug

\$1 EACH

THE STANDARD COMPANY
TORRINGTON
CONN.

*"If it's made by H-E-I-N-Z-E
it's right."*

SPECIFY
HEINZE NEW LOW
TENSION
MAGNETO

ON YOUR 1910 CAR

and get the one that the best posted ignition experts have decided is superior to all others, whether of American or Foreign make

SUPERIOR IN EFFICIENCY
SUPERIOR IN CONSTRUCTION
SUPERIOR IN OPERATION

NOTE

THIS IMPORTANT FEATURE
Will produce perfect ignition at
50 revolutions crank-shaft speed

The superiority of Heinze Coils made for us a reputation second to none in the ignition field, and with that reputation to sustain we offer you in the

NEW HEINZE
MAGNETO

absolutely the
MOST RELIABLE
MOST DURABLE
MOST EFFICIENT

Ignition Apparatus that it is possible to produce. Whether you are the owner of one car or the manufacturer of ten thousand cars, you cannot afford not to investigate our claims.

We issue an elegant loose leaf catalog which we will send upon request, if you will address DESK H,

HEINZE ELECTRIC CO.
Factory and Main Office:
LOWELL, MASSACHUSETTS

FISH

offers a cure for all kinds of Ignition Troubles.
For instance here is the

Fish Diaphragm Vibrator Coil Uses 35-100 of one ampere

All other vibratory coils stick. This one doesn't.

The best of them vibrate 14,000 times per minute. This one over 200,000 times per minute.

The points in all others get dirty. These don't.

All others need adjustment attention. This one doesn't.

Doesn't this mean something to you? It is dust-proof, water-tight and fool-proof.

Use it 30, 60 or 90 days if you choose and if you are not satisfied return it and get your money.

These coils give 100% hotter spark than any coil made.

1 cylinder dash coil..... \$15.00
2 cylinder dash coil..... 24.00

Write for Catalogue of Multi-Speed System for any number of Cylinders.

Also See Here!

The FISH TIMER
NEW and RIGHT

\$5.00

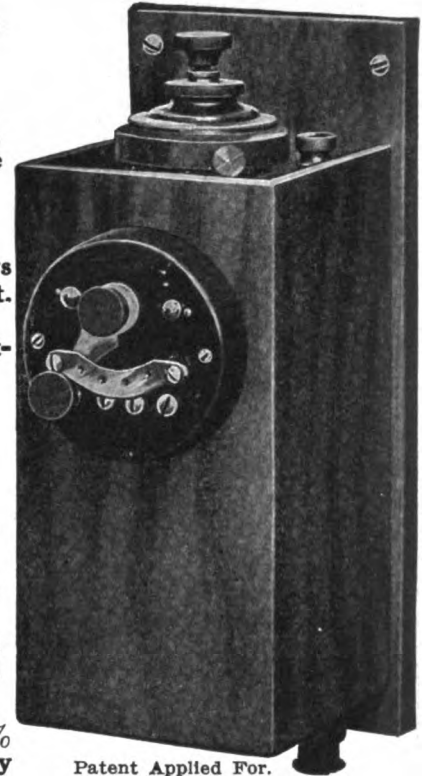

Patent Applied For.

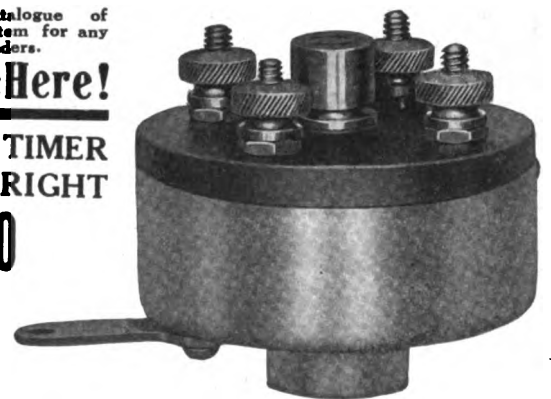

will not only outwear any other, but will outlive any motor on which it may be used

GUARANTEED

Money refunded if goods are in any manner not as represented. Is entirely self-enclosed and may be attached to any shaft in either a vertical or horizontal position in a very few minutes. Prices, adapted to either one, two or four cylinder motors, \$5.00 each.

Liberal Discounts to Dealers and Jobbers. Immediate Delivery.

GEO. L. FISH, Manufacturer
1427 Michigan Avenue, CHICAGO
Phone Calumet 3382

Develop More Power
Save Gasoline
Buy Less Oil

By Using

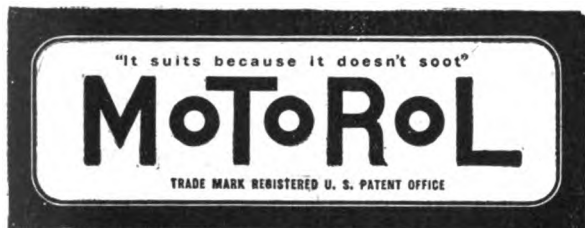

for cylinder lubrication. You'll get better results and greater economy.

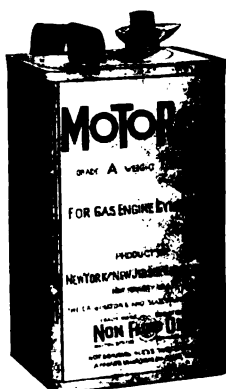

All carbon interference in your cylinders, such as interruption of ignition and fouling of valves and pistons, tends to materially reduce engine efficiency. On the other hand, some more or less non-carbonizing oils are low in lubricating value and do not prevent wear or promote cool running conditions.

MoToRoL has been refined to meet both requirements—freedom from carbon and high lubricating value. These qualities produce the highest efficiency and economy.

Ask your dealer. If he is not supplied, return attached coupon and secure free sample.

NEW YORK & NEW JERSEY LUBRICANT CO.

Originators and Sole Manufacturers of Non-Fluid Oils

165 Broadway, New York City

SALES AGENTS: UNITED MANUFACTURERS
 Broadway at 76th Street, New York

N. Y. & N. J. LUBRICANT CO.

165 BROADWAY Dept. E NEW YORK CITY

Please send me free sample of **MoToRoL**.

Name.....
 Address.....Car.....
 Dealer.....
 Address.....

THE SOLUTION OF YOUR
TIRE TROUBLE

isn't in better tires, for the tire makers have "gone their limit" to produce the strongest combination of rubber and fabric.

The Demountable and Quick Detachable Rim is the only logical solution. It is sure to come, and will be as much a part of the future equipment of an automobile as is the magneto to-day. So-called puncture-proof tires, solid tires, tire fillers and the like are but phases through which the automobile industry is rapidly emerging.

DOOLITTLE RIMS

DEMOUNTABLE—QUICK DETACHABLE

will solve your tire troubles just as they have thousands of English and Canadian motorists. Every man who sees it exclaims, "How simple; wonder why it wasn't thought of long ago!" All great inventions are reached by the simplest and most direct methods. Clumsy contrivances are but the natural outcome of a new industry.

WHAT THE DOOLITTLE RIM IS

A set consists of five rims which take any standard make of Clincher or Q. D. tire. The extra rim carries a fully inflated tire. When a puncture or blow-out occurs it takes **LESS THAN ONE MINUTE** to remove the damaged tire complete with its rim and substitute a new and fully inflated tire, mounted on the spare rim.

WHAT THE DOOLITTLE RIM WILL NOT DO

IT WILL NOT rust fast (this has been the one great drawback to all other demountable rims), because, should the rim freeze to the wheel, by our special Doolittle patent we can **EXPAND THE RIM** with a pressure of over ten tons. No rust can withstand this tremendous pressure.
 IT WILL NOT damage the tire and rim cutting is impossible.
 IT WILL NOT pinch your tubes.

Let us send you our Booklet which fully describes the **DOOLITTLE DEMOUNTABLE—QUICK DETACHABLE RIMS**

TO DEALERS—Now is time for you, Mr. Dealer, to get our special proposition. **DOOLITTLE RIMS** are bound to be one of the great factors in the automobile industry. There isn't a car owner who will not gladly make the change when you demonstrate how simple, safe and what a time saver these rims are. Write us to-day and let us give you full particulars—**DO IT NOW.**

THE DOOLITTLE RIM CO. LIMITED

1666 BROADWAY, NEW YORK
 TORONTO, CANADA COVENTRY, ENGLAND

PLEASE MENTION THE AUTOMOBILE WHEN WRITING TO ADVERTISERS

The Logical Shield For Your Car

MR., MRS., or MISS MOTORIST, the world is moving forward. What was good enough yesterday is not good enough *to-day*.

The Hydraulic

is the *only shield* that is mechanically up-to-date.



SEE the hydraulic pump at either end? They work like a door check. An easy downward pressure with *one finger*, and it falls down; the reverse operation brings it into use instantly. It works smoothly, without a jar or a jolt; and you need not fear a clatter of broken glass if you keep the pumps filled with oil.

41-inch size, \$35.00 44-inch size, \$37.50
 Either in 25-inch or 29-inch heights.

Above prices include all fittings and either Mahogany or Walnut filling-in boards, in 6, 9 or 12-inch heights.

Send for Catalog "A"

EMIL GROSSMAN COMPANY
 Manufacturer

232 West 58th Street, NEW YORK

CHICAGO BRANCH
 1436 Michigan Ave.

DETROIT BRANCH
 650 Woodward Ave.

HESS BRIGHT

YOU cannot afford to take chances with the bearings you put on your car; if you do, the chances are largely in favor of your ultimate disappointment and chagrin. Don't take these chances—you don't have to—just equip your cars with the world-famous

Hess-Bright Ball Bearings

and be sure. HESS-BRIGHT BALL BEARINGS are used on most of the good cars made here and abroad. They should be used on all cars, and will be eventually. There's no good reason why you shouldn't use them and no end of reasons why you should. The prime reason is that they are absolutely right; they are a development of years of intelligent effort, regardless of expense, directed along the line of producing the very best possible ball bearings that could be made. This means that the material from which the balls and bearings are made has had special making to meet the exacting requirements of such a bearing. It means that the balls are absolutely true, that they are hard, that the grooves in which the balls run are so made as to allow the balls to run smoothly and easily without slack; it means that a HESS-BRIGHT BALL BEARING will last and maintain its efficiency and that they are the only bearings you can afford to use on your cars whether the cars are high-priced or low. A treatise on Ball Bearings is sent on request. It will interest you. Write for it today.

HESS-BRIGHT
 Manufacturing Company
 2106 Fairmount Avenue
 PHILADELPHIA, PA.

Branch Office:
 1974 Broadway, NEW YORK CITY

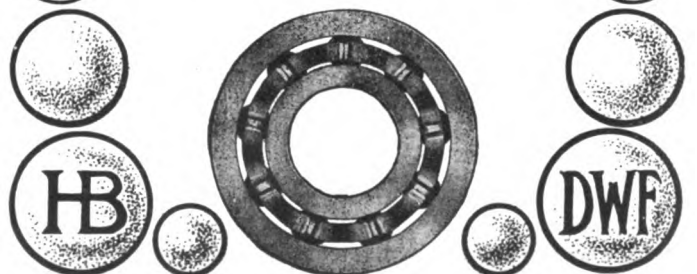

PLEASE MENTION THE AUTOMOBILE WHEN WRITING TO ADVERTISERS

BOWSER

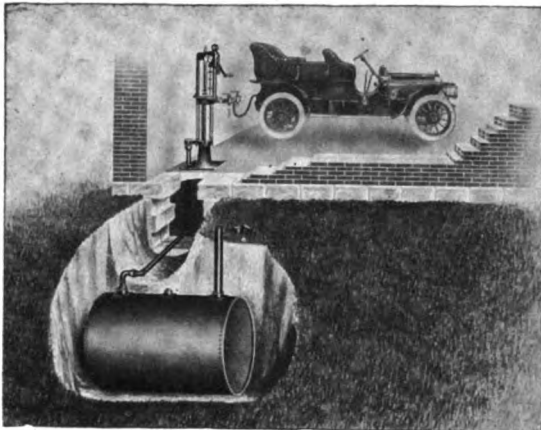

THE BOWSER
Long Distance Gasolene Storage
Outfit for Automobile and
Manufacturers' Use

SAFETY, ECONOMY and CONVENIENCE

Are among the many advantages embodied in the Bowser Gasolene Storage Equipment.

The Bowser System for Gasolene Storage is beyond question of a doubt the only practical method for storing gasolene.

The outfit saves its cost in one season by providing for purchases at quantity prices. It saves more by preventing evaporation. It protects life and property from fire and explosion.

The Bowser System provides a convenient and easy method for filling your car.

Every owner of an automobile using gasolene should have our catalog.

Send Postal for Catalog J.

S. F. Bowser & Co., Inc., Ft. Wayne, Ind. U. S. A.

Branch Offices:

225 Atlantic Ave.,
 BOSTON
 50 Church St.,
 NEW YORK

612 Howard,
 SAN FRANCISCO
 209-210 Fisher Bldg.,
 CHICAGO

1341 Arch St.
 PHILADELPHIA
 66-68 Fraser Ave.,
 TORONTO, ONT.

Prest-O-Carbon Remover



**Don't
 Tear Down
 Your Engine!**

An engine torn to pieces and scraped is seldom as good as before.

Prest-O-Carbon Remover chemically dissolves and removes every particle of carbon from cylinders, pistons, piston rings and valves.

For Auto, Marine and Stationary Engines

Cannot injure the metal; cleans one cylinder perfectly in an hour for 25 cents or less. Increases compression, power and durability. Does a better job than scraping. Simply apply with an oil gun.

We Will Refund Your Money if Prest-O-Carbon Remover doesn't do all we claim for it. Price: Gallon, \$3.75; Half Gallon, \$2.00; Quart, \$1.00. Beware of imitations containing kerosene or strong acids. If your dealer does not supply you promptly, send your order to us, to be shipped from our nearest office.

The Prest-O-Lite Co. 234 East South St
 Indianapolis, Ind.
 Branches at New York Boston, Philadelphia, San Francisco
 and Toronto
 Makers of Prest-O-Lite Gas Tanks.



**Any Old
 Tank**

will hold gasolene above ground. A riveted tank of the tin can variety can be

made air-tight by soldering it, and provided there is no pressure on it, it may remain air-tight. But put that tank underground and how long will it remain tight?

The weight of the earth will bulge it out of shape, starting the solder around the rivets, which means leakage

AIR-TIGHT STEEL TANKS

for Automobiles, Motor Boats, etc.

Placed Underground

are made of high-grade steel, 3-16 in. thick, brazed, without rivet or solder joint to leak, by a process we have successfully used in the manufacture of tanks for the largest railroad systems in the world for 20 years.

AIR-TIGHT STEEL TANKS

are sold on 30 days' trial with an absolute money back guarantee. Write for Illustrated Booklet, FREE.

The Air-Tight Steel Tank Co.

400 WOOD STREET
 PITTSBURGH, PA., U.S.A.



THE MASTER MAGNETO

MASTER—“One who has attained eminence in his art.”

Herr Unterberg for years designed and constructed the best known magnetos of the day, but sold under other names. What more natural than that he should place in the magneto now sold under his own name the result of all of his previous experience? RESULT:—In the dual type—THE MASTER INTERRUPTER, non-adjustable, indestructible and fool-proof—40,000 miles of use show no wear. The location of the MASTER BATTERY TIMER in the MAGNETO and THE MASTER DISTRIBUTOR, the insulation of which cannot be burned by high tension, sparks when the motor is started on the battery switch.

THE NEW U. & H. MASTER MAGNETO catalog illustrates and describes in detail these most important up-to-date magneto improvements.

J. S. BRETZ COMPANY
Sole Importers, Times Bldg., New York.

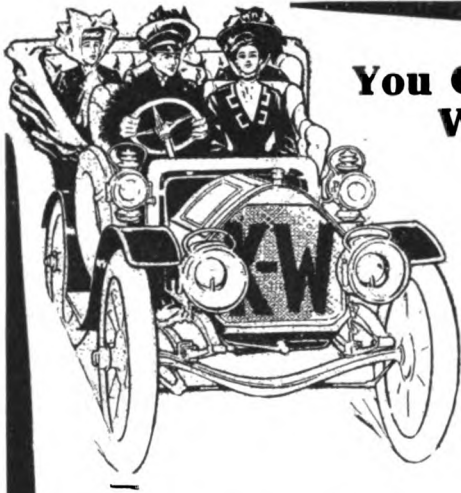

You Can Go **WHERE** You Like and Come Home **WHEN** You Like if your car is equipped with a

K-W MAGNETO

Just think of having a small, compact electric power plant on your car which will **always** furnish you with electric power for Ignition, which cannot get out of order, break down or deteriorate, and which will in addition to furnishing a **perfect** ignition give you

POWERFUL ELECTRIC SEARCHLIGHTS

Figure out for yourself what your battery current cost you last season—then figure out what your lighting bill was if you used Acetylene or Gas Tank—add to it the annoyance and trouble you had with both and then ask yourself if you can afford to be without the K-W Magneto when it costs only **\$35.00** and is **ABSOLUTELY GUARANTEED** to fulfil every claim we make for it.

No dry cells or storage battery for your ignition. No acetylene or gas tank for your lights. The K-W Magneto is

A COMPLETE LIGHTING AND POWER PLANT IN ONE

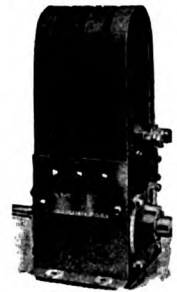

MODEL A
Belt Drive Jump Spark. Most simple and efficient magneto made.
Price, \$35.00

THE NEW K-W SPARK COIL

stands as high among coils as the K-W Magneto does in its class. The K-W Spark Coil is the only Spark Coil made from which **every drop of water and moisture has been removed.**

The K-W Spark Coil is an anhydrous coil, with a quick time constant. Has **extremely fast Hammer Break** Vibrator and gives a spark **many times hotter** than that produced by any other coil.

Contact points are of “Platino-Iridium,” an alloy having a value twice that of gold. Cannot “freeze” or “stick together” as ordinary “platinum” points do.

The K-W Spark Coil will not short-circuit and **cannot** be broken down.

The K-W Spark Coil is also made in a Synchronized Coil, having an extra unit or Master Vibrator. This extra unit can be furnished with the K-W Spark Coil or not as may be desired.

Write for prices and booklet to-day. K-W Ignition leads the world.

THE K-W IGNITION COMPANY, 34 Power Ave., Cleveland, Ohio, U. S. A.

N. Y. Agency: 1686 Broadway, New York

N. E. Agency: 70 Long Wharf, Boston, Mass.

Philadelphia Agency: Jas. L. Gibney & Bro., 215-217 North Broad Street

Chicago Agency: The Automobile Supply Co., 1339 Michigan Ave., Chicago, Ill.

For sale by the Canadian General Electric Co., Toronto, Canada



Four-cylinder Coil and Switch
Price, \$30.00
Other prices on application

PLEASE MENTION THE AUTOMOBILE WHEN WRITING TO ADVERTISERS

New Departure Bearings Stood the Test

Remarkable Demonstration of Combined Thrust and Radial Load Capacity

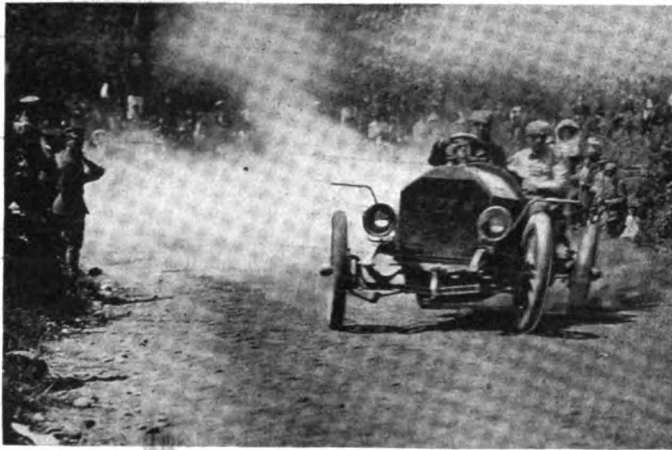

This cut shows the Allen-Kingston car taking the very bad right-angular curve at Sport Hill Climb, Bridgeport. The car travelled at a speed of 50 miles an hour and photograph shows the skidding of the rear wheels just before righting for the finish and winning its class event.

The car is mounted on NEW DEPARTURE "TWO-IN-ONE" ANNULAR BALL BEARINGS, demonstrating beyond the possibility of a doubt the ability of the New Departure bearing to take end thrust in wheels on high speed cars.

The bearings in the wheels of two other cars went down on this turn.

CATALOG—TREATISE ON REQUEST

The New Departure Mfg. Co., Bristol, Conn.

THE POWERFUL

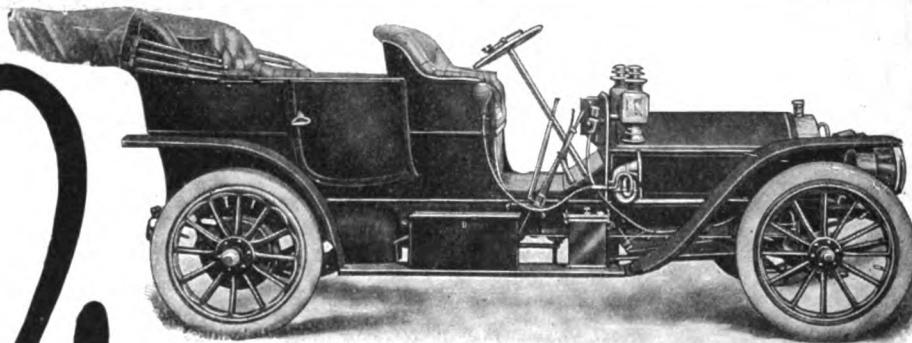

**PRICE
WITH FULL
EQUIPMENT
\$2,500**

Grout

**The Car for style,
power,
speed and wear**

Grout cars have withstood every test—reliability, hill-climb, endurance contest—and have shown the greatest ease of running, with least attention, mile after mile, of *any* standard car made. It's worth the trouble to find out all about the "Grout," even though you don't buy—we will cheerfully send full information on request.

GROUT AUTOMOBILE COMPANY, Orange, Mass.

AGENTS WANTED IN UNOCCUPIED TERRITORY—WRITE US.

PLEASE MENTION THE AUTOMOBILE WHEN WRITING TO ADVERTISERS

Knox

STOCK CARS

AT

**CLEVELAND, OHIO, Hill Climb
on Porter Hill, June 9, 1909**

**Knox Cars WIN every event
entered**

FOUR FIRSTS including:
FIRST in \$2,000 to \$3,000 Class.
FIRST in over 2,204 lbs. stock cars.

FIRST in piston displacement handicap.
FIRST in FREE-FOR-ALL.
Record of the Hill for Standing Start.

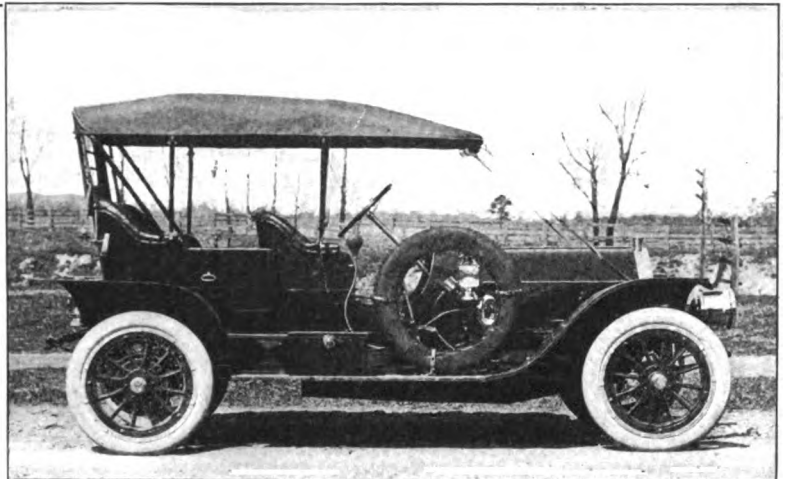

Knox 1910 Tonneauette

The persistency of Knox stock cars to win contests in competition with all makes is conclusive proof of the advanced ideas of construction.

Knox cylinder construction made with detachable heads, valves in the head, unit power plant, three point suspension, straight line shaft drive, a perfect lubricating system, and the use of the best material and skilled labor, coupled with years of experience building nothing but high-grade cars, are good reasons for their unapproachable record of success.

These undisputed facts, coupled with strictly up-to-date designs, quietness, easy riding qualities and the complete equipment of Knox cars, including Fisk demountable rims and tires, places them far in advance of all competition.

Write for 1910 Advance Information

KNOX AUTOMOBILE CO., Member **Springfield, Mass.**
A. L. A. M.

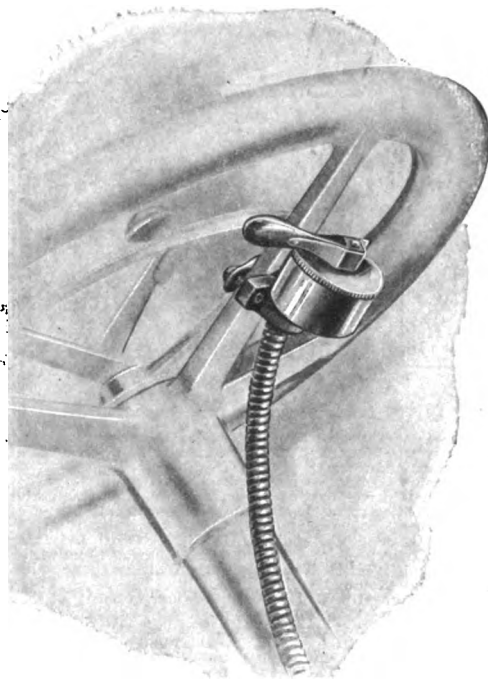

The
New



Steering Wheel Switch

**Control your Battery or Magneto
from the Steering Wheel**

The Connecticut Steering Wheel Switch is absolutely necessary. It should be part equipment of every car. It gives you control of your ignition right under your thumb—right where it ought to be—whether you are running on Battery, Magneto or both. With a dual system the Coil and Magneto can each be operated independently or both together.

**CONNECTICUT IGNITION DEPT.
UNITED MANUFACTURERS, INC.**

Broadway and 76th Street, New York

BRANCHES

CHICAGO—1421 Michigan Ave. CLEVELAND—1932 Euclid Ave.
PHILADELPHIA—422 Commerce St. DETROIT—225 Jefferson Ave.
BOSTON—109 Massachusetts Ave.
SAN FRANCISCO, CAL.—Hughson & Merton, 544 Van Ness Ave.

Price \$5.00

We suggest that you write for Bulletin No 50-B

PLEASE MENTION THE AUTOMOBILE WHEN WRITING TO ADVERTISERS

AUTOMOBILE BODIES

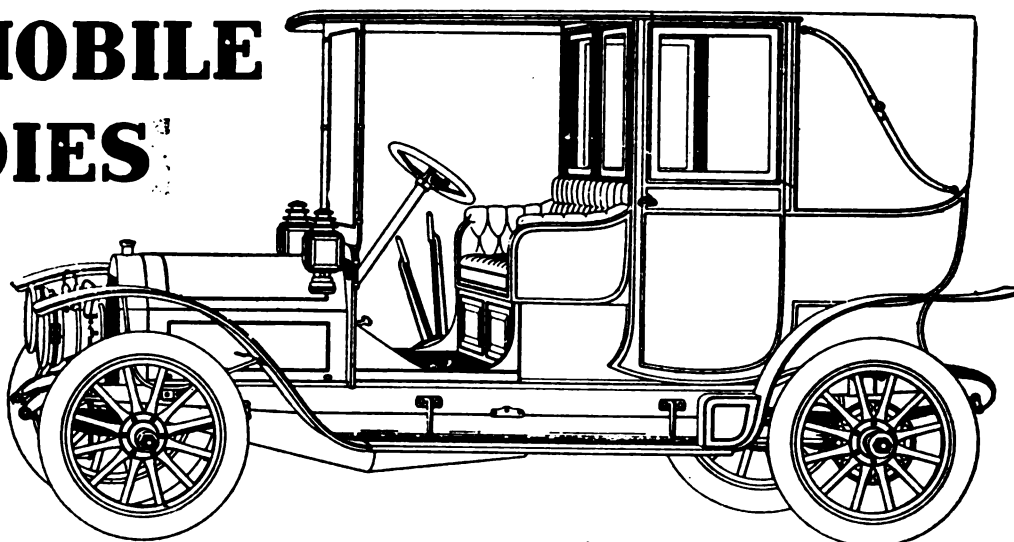

For more than seventy years we have been building coach work of dependable quality. We are now engaged in building bodies for motor carriages and are now prepared to do so in a prompt and efficient manner.

THE QUALITY will be the same as has enabled us to build up the largest coach business in America, and our prices will be most reasonable because we have the capital and facilities to do this kind of work at less cost than many, not equipped so favorably.

Let us show you designs.

JAMES CUNNINGHAM, SON & CO.
ROCHESTER, N. Y. 557 Wabash Ave., CHICAGO, ILL.

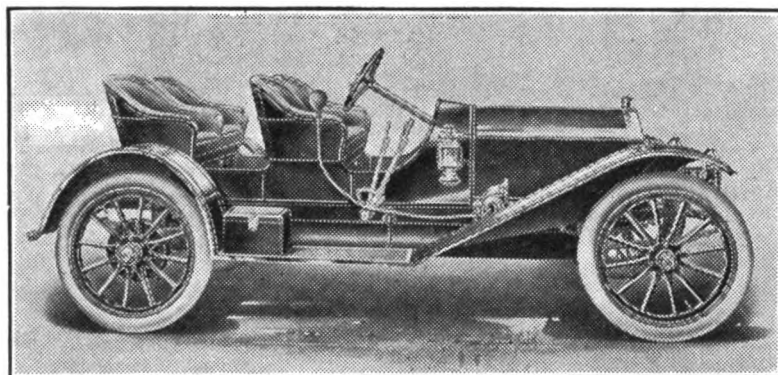

The McCue Car

Sixty-Seven Pounds Weight
to the Horse Power

SPECIFICATIONS

BODY—Aluminum and Wood Panel.

SEATS—Four persons.

WHEEL BASE—118 inches.

TRACK—56 inches.

TIRES—36 in. x 4 in., front and rear.

FRONT AXLE—I-Beam Section, large ball bearings in hubs and head of steering knuckle.

REAR AXLE—Floating Type, ball bearing throughout.

SPRINGS—Semi-Elliptic.

BRAKES—Foot Brake 14 in. expanding; emergency brake 10 in. expanding, fitted with fire-proof lining, brake shafts extending under car.

FRAME—Cold Rolled Pressed Steel, Channel Section.

MOTOR—Model R, 4-Cylinder, 4-Cycle, 4½ in. x 4½ in. Rated 29 H.P., actually develops 36 H.P.

IGNITION—Jump Spark, double system.

CURRENT SUPPLY—Bosch Magneto also Connecticut Coil and Battery to separate spark plugs.

LUBRICATION—Self-contained oiling system, circulation by splash and pump, gear driven.

MOTOR CONTROL—Quadrant with Spark and Throttle Levers on top of wheel.

CLUTCH—Cone Type, leather faced. Gettable Springs
TRANSMISSION—Selective Type, with annular ball bearings. Three speeds forward and reverse.

TRANSMISSION CONTROL—Side Lever.

DRIVE—Shaft drive to bevel pinion gears in differential, which connect with floating axles having hub clutches integral.

GEAR RATIO—3 to 1 or 3½ to 1.

STEERING GEAR—Right and Left Hand, External and Internal Nut.

STEERING COLUMN—2 in., set at 30 degrees, having 18-in. wheel with quadrant and levers for Motor control.

CARBURETOR—Automatic Float Feed.

GASOLINE FEED—Gravity Exhaust pressure optional

TANK CAPACITY—15 gallons.

EQUIPMENT—Bosch Magneto Connecticut Coil and Distributor, two large Gas Lamps and Generator Two Dash and a Tail Lamp.

TOP—Top and other equipment extra.

FINISH—Color Dark Blue.

WEIGHT—2,080 pounds.

CLEARANCE—12 in. under flywheel. Height from top to frame of floor 25 in.

PRICE—Finished \$2,250.

OPTION—Same Car with Model G 4½ in. x 5 in. 45 H.P. Motor, \$2,550.

CATALOGUE UPON APPLICATION

The McCue Company, Hartford, Conn.

NORTH AMERICAN MOTORS

**Large capacity—complete equipment. 4 and 6 Cylinders. 4x4½" and 5x5½"
For Truck, Automobile and Taxicab Service.**

Built with an intimate knowledge of work they have to perform.

Integral oiling system, oil tank only on the frame.

Fan fly wheel and self contained clutch without end thrust.

Side thrust on valve tappet and stem eliminated.

We believe our motors show the greatest detail refinement of any make of motor on the market.

Catalogue on Request

**North American
Motor Corporation**
77 Broad Street, Stapleton,
Borough of Richmond,
NEW YORK CITY

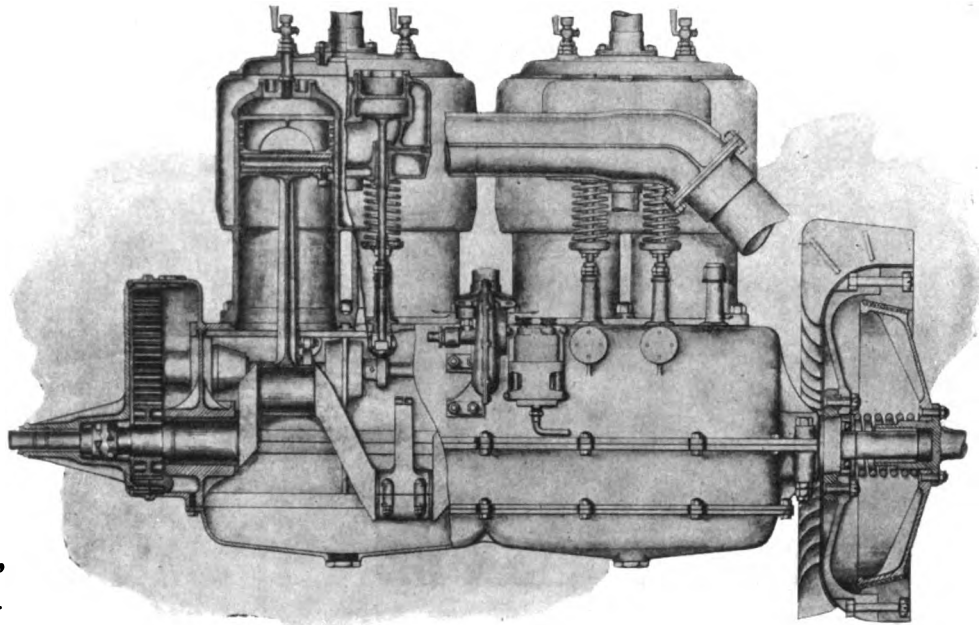

“DIETZ” LAMPS

**“DIETZ”
“Royal” Side Lamps**

BEAUTIFULLY MODELED lamps of 65 candle power, 14½" high, for kerosene. As in all other Dietz Lamps, great care is taken to have smooth, rounded surfaces and as few projections as possible that they may be easily kept clean, and present most graceful lines. These lamps are equipped with No. 1 “Royal” long cone burners, with ⅝" wick, regulated by knurled button under fount; removable silvered Reflectors; ruby rear signals, and a Combination Socket to take flat or round brackets. Door lens is 6⅞" diameter, and so constructed as to afford a spreading light of great intensity.

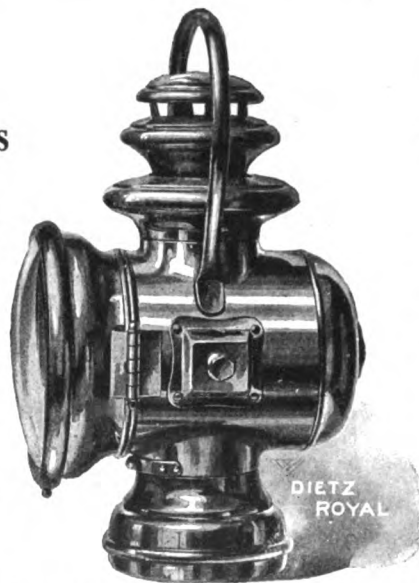

**QUALITY
Style—Efficiency**

CAN BE FITTED FOR ACETYLENE OR ELECTRIC BURNERS on order. Made regularly in polished brass, but also furnished in gun metal finish. For use on big, high-class cars and for those who, while desiring style and elegance, want reliability and efficiency in lighting. We invite correspondence with anyone interested. Write to us. A letter carries no obligation to go further, and may result in your getting next to the one thing that will perfect your lighting equipment.

**DIETZ
MOTOR CAR
LAMPS**

R. E. DIETZ COMPANY, Manufacturers, 60 Laight St., New York, U.S.A.
ESTABLISHED 1840 PIONEERS IN THE MOTOR LAMP INDUSTRY 1909 CATALOGUE ON REQUEST
GAS—OIL—ELECTRICITY A WIDE VARIETY OF CHOICE

**DIETZ
MOTOR CAR
LAMPS**

PLEASE MENTION THE AUTOMOBILE WHEN WRITING TO ADVERTISERS

A \$60,000 INSURANCE POLICY



This is the Axle No. 124 I-Beam Timken Front

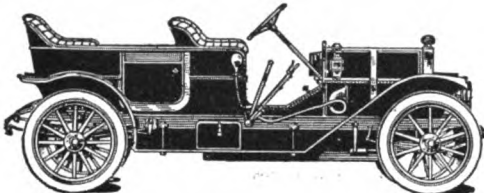

This is the car—Velie No. 30 Touring Car

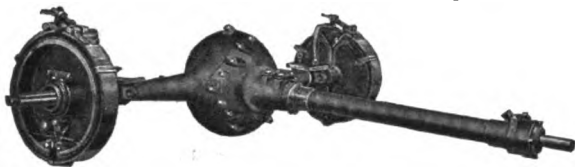

This is the Axle No. 525 Timken Rear

seems a large policy for a manufacturer to carry on each and every car he turns out. Yet, the wisdom of the manufacturer who paid \$60,000 more for axles for his 1909 output, can't be questioned when you know the axles were **TIMKEN AXLES**.

The extra amount paid by this manufacturer was in no wise an expense—it was more than an investment, it was insurance and investment both. That is really the reason why

Timken Axles and Roller Bearings

are in use on over **70%** of all the high grade automobiles and **90%** of the trucks built in this country. If you knew as much about **TIMKEN AXLES and ROLLER BEARINGS** as *The Velie Motor Car Co.* does, you too, would pay the difference. We will be glad to tell you.

THE TIMKEN ROLLER BEARING AXLE CO., Canton, Ohio

BRANCHES: 10 East 31st Street, New York City. 429 Wabash Avenue, Chicago, Ill.

I Will Keep Down That Up-Keep Expense!

MY cheery smile makes it almost unnecessary to say that the luxuries you love or the things you feel necessary adjuncts to modern motoring will not be lacking.



My suggestion is—
Send, 'phone or wire your dealer for a

Red Head

Spark Plug and let me do your sparking. I've been cut out to do this kind of work **efficiently, energetically and economically**. All sizes and styles,

\$1.00



Write for booklet "A"

EMIL GROSSMAN COMPANY

Manufacturer

232 West 58th Street, NEW YORK

CHICAGO BRANCH
1436 Michigan Ave.

DETROIT BRANCH
650 Woodward Ave.

STEVENS-DURYEA MOTOR CARS 1910

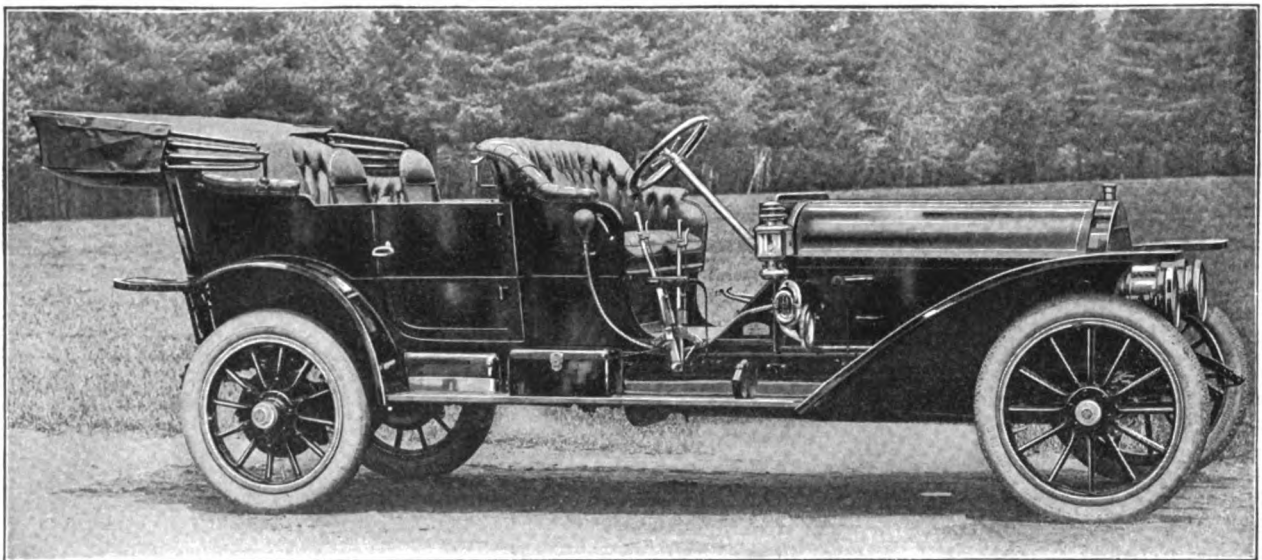

Model Y Six-Cylinder Forty H.P.

Over four years consistent Six-Cylinder Successes

STEVENS-DURYEA CO.

900 Main Street

CHICOPEE FALLS, MASS.

Members Association Licensed Automobile Manufacturers

The Autocar

1910 TYPE XX

\$1750.00

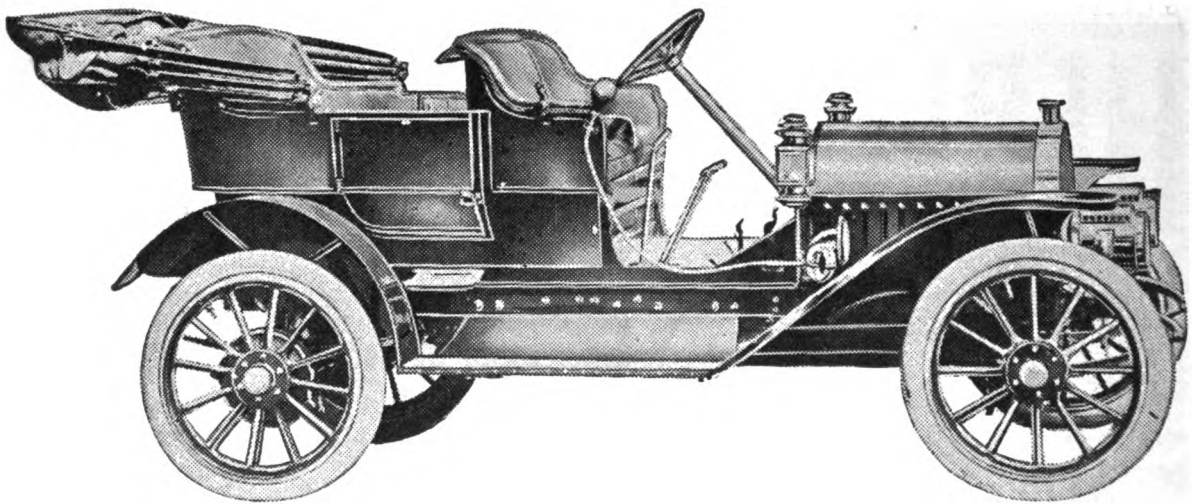

TYPE XX, 1910, 25.6 H. P. AUTOCAR, \$1750

Four Cylinders, 4" x 4 1-2". I Beam Front Axle. Semi-Floating Rear Axle.
Bosch Magneto—Dual System. 34" Wheels. Five Lamps and Generator.
Universal Rims. Adjustable Taper Roller Bearings Throughout.

We have good territory open for dealers

Write for catalogue and information

THE AUTOCAR COMPANY, Ardmore, Pa.

**40
MILES**

to the
GALLON

in a

**METZ
CAR**

equipped
with 1 inch

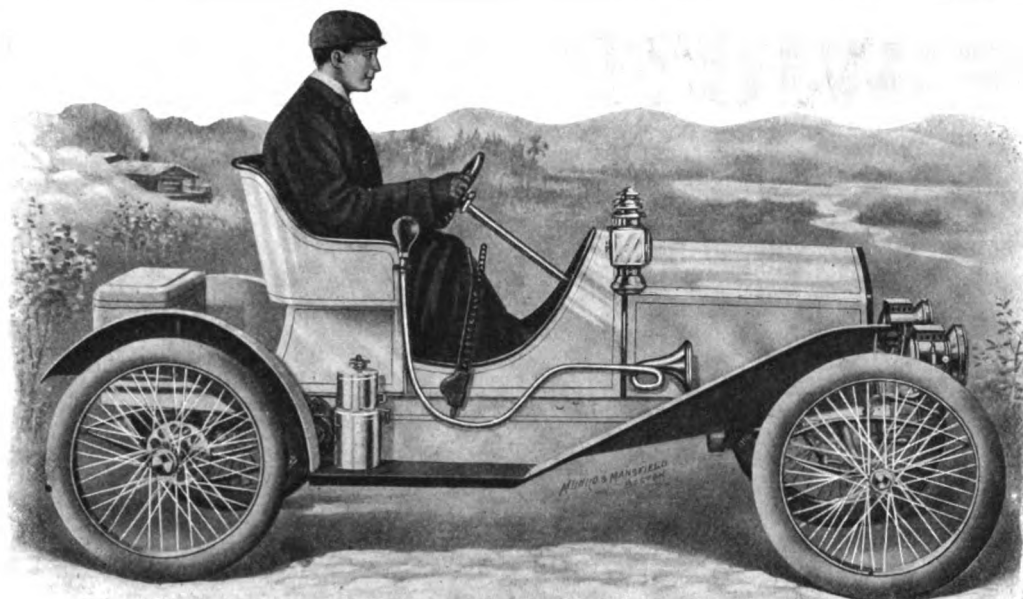

SCHEBLER  **CARBURETER**

"The Standard of the World"

"The Heart of the Automobile"

This remarkable record made by Mr. C. H. Metz driving a METZ CAR is FURTHER PROOF OF "SCHEBLER" CARBURETER EFFICIENCY—a performance of fact and worth more than a bushel of theories. And there's no end of FACTS and PROOFS of "Schebler" Carbureters supremacy. The fact that there are over half a million satisfied users to-day—the fact that many makers of automobiles who formerly made their own carbureters have abandoned their manufacture and adopted "Schebler"—the fact that the leading automobile makers of America use "Schebler" Carbureter exclusively—and the fact that most of the endurance runs, speed contests, hill climbs, etc., held in this country are won by cars equipped with "Schebler" Carbureter, all go to proclaim "Schebler" efficiency and reliability.

If you want the best results and the elimination of carbureter troubles get the BEST carbureter—the "Schebler"

WHEELER & SCHEBLER, MANUFACTURERS Indianapolis, Ind.

Sales Offices: Factory Sales Corporation, 1438 Michigan Ave., Chicago.

New England Office: W. J. Connell, Mgr., 36 Columbus Ave., Boston, Mass.

Eastern Office: E. J. Edmond, Mgr., The Motor Mart, 62d and Broadway, N. Y.

Canadian Office: Canadian-Fairbanks Co., Distributors for Dominion of Canada; General Office, Montreal.

For Sale by Any Reliable Dealer in Automobile and Marine Engine Supplies

WHITE STEAM CARS

FOR 1910

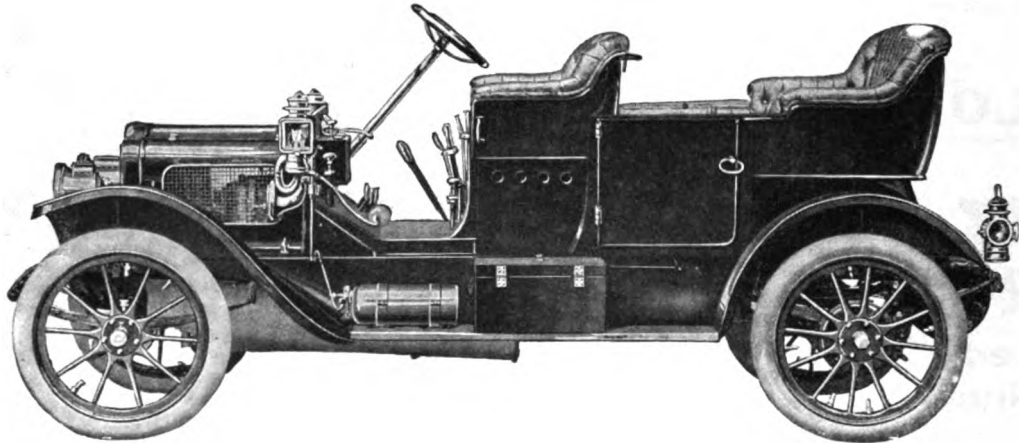

The White Steam Cars for 1910 will be made in two models—one of 40 horse-power, known as the Model "M-M" and selling at \$4000 and the other of 20 horse-power, shown above, known as the Model "O-O" and selling at \$2000. The new cars will closely resemble the Model "M" and the Model "O," respectively, of the past season.

The most important feature of the new models is that either kerosene or gasoline may be used as fuel. The necessary adjustments to a car so that the fuel may be changed from gasoline to kerosene, or vice versa, may be made in a few minutes. So completely have we solved the kerosene problem, that when a car is in operation it is practically impossible for any one to tell whether kerosene or gasoline is being used. By using kerosene, the drivers of White cars will enjoy the advantages of a very cheap fuel, which can be handled with impunity and which can be procured at every cross-roads store and at almost every farm-house.

The other new features comprise: a lengthening of the wheelbase of the 20 horse-power car to 110 inches, a pressed-steel frame and a further tilting of the steering post in the 40 horse-power car, and a slight modification of the design of the engine in both models, whereby the water pumps are driven from an eccentric located outside of the crankcase at the rear of the engine.

WRITE FOR DESCRIPTIVE CIRCULAR

THE WHITE COMPANY
CLEVELAND
OHIO

New York City, Broadway at 62d St.
 Boston, 320 Newbury St.
 Philadelphia, 629-33 N. Broad St.
 Pittsburg, 138-148 Beatty St.

Cleveland, 407 Rockwell Ave.
 Atlanta, 120-122 Marietta St.
 Chicago, 240 Michigan Ave.
 San Francisco, Market St. at Van Ness Ave.

PLEASE MENTION THE AUTOMOBILE WHEN WRITING TO ADVERTISERS

WHITE GASOLINE CARS FOR 1910

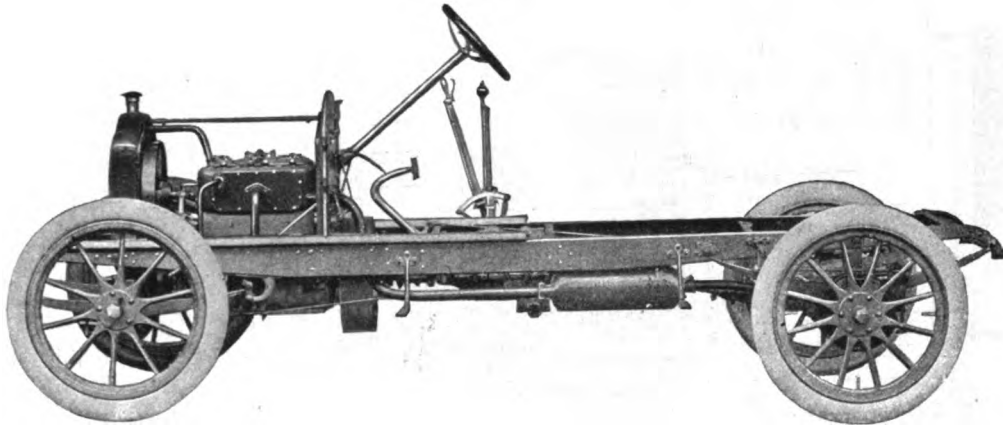

With the addition of a gasoline car to the White products, our extensive selling organization is in a position to meet the demands for all classes of cars. With our unequalled factory facilities, long experience in automobile building and thoroughly trained organization, unencumbered by any pre-conceived notions for or against any particular construction, we are in a position to furnish the best in gasoline car design, workmanship and material.

The White gasoline car is fitted with a four-cylinder, four-cycle engine of extremely simple and neat design. The car has a four-speed selective type transmission with direct drive on the third gear. The four cylinders are cast in one piece. The cylinder dimensions are 3 3-4 inch bore and 5 1-8 inch stroke. The crank-shaft has but two main bearings, which are annular ball-bearings of generous dimensions.

A feature of the car is the unusually small amount of piping and fittings under the bonnet. The valves are all on one side and are actuated by a single half-time shaft. The valve springs are not exposed to view but may be inspected or replaced by removing a side-plate. The above illustration of the chassis of the White gasoline car shows the left-hand side of the engine, on which side are located the valves, the spark plugs, the pipe leading from the centrifugal water pump to the water jacket, the gas intake pipe leading from the carburetor and the exhaust pipe. There is no piping on the right side of the engine, the only device on this side being the gear-driven Bosch magneto to which the timer is attached.

Every detail of the car is in accordance with the most advanced foreign practice and its many desirable features, not found on other American machines, ensure that it will be the popular medium-priced car of the year. It will be made in two types, differing in details of running gear and of body construction, but with identical power-plants. The prices of these two types will be \$2000 and \$2500 respectively.

WRITE FOR DESCRIPTIVE CIRCULAR

THE WHITE COMPANY
CLEVELAND
OHIO

New York City, Broadway at 62d St.
Boston, 320 Newbury St.
Philadelphia, 629-33 N. Broad St.
Pittsburg, 135-148 Beatty St.

Cleveland, 407 Rockwell Ave.
Atlanta, 120-122 Marietta St.
Chicago, 240 Michigan Ave.
San Francisco, Market St. at Van Ness Ave.

PLEASE MENTION THE AUTOMOBILE WHEN WRITING TO ADVERTISERS

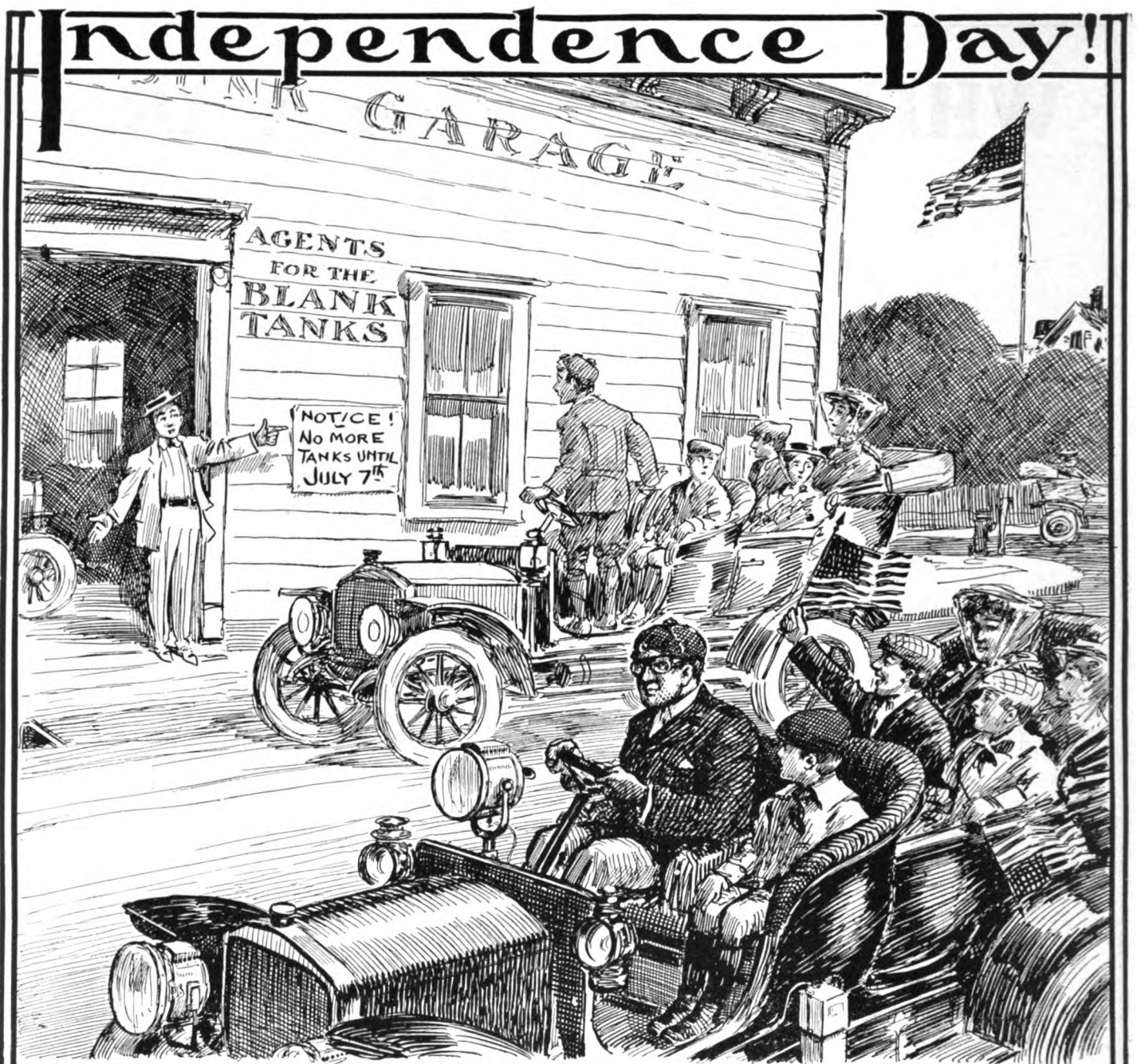

ARE YOU INDEPENDENT?

THE FOURTH is near at hand. Probably you are planning a three days' tour—from Saturday to Monday. No doubt your preparation will be thorough; you do not like to mar the pleasure of that once-a-year outing for your family or guests. You will forestall trouble and tune the car in every way you can.

What about the lamps? Is the zest of riding to be spoiled if night falls before you reach your destination? Are you going to start and stop by the clock instead of when you wish?

And the source of gas—Are you depending on scattered exchange stations where you may find a waiting list ahead of you? Or are you still temporizing with the sham generator that came with the car, and praying that luck will save you from the need of trying to use it?

RUSHMORE owners are INDEPENDENT—independent of the sun, independent of exchange stations, free to drive as far and as long as they please. With adequate Rushmore equipment—Headlights, Searchlight and Generator—daylight speeds are both easy and safe, and gas is to be had at negligible cost wherever carbide is sold.

The Rushmore Generator turns on and off like the gas in your house. It does not waste carbide, overheat or play tricks of any kind. It is the most reliable source of gas known.

RUSHMORE DYNAMO WORKS PLAINFIELD, N. J., U.S.A.—
LONDON. PARIS. CHICAGO
RUSHMORE

PLEASE MENTION THE AUTOMOBILE WHEN WRITING TO ADVERTISERS

Overland

THIS CAR
COSTS LITTLE TO KEEP

It's a car you can afford—capable—plenty of power and speed—yet remarkably economical.

There's no other car carrying as large a load that will go so far in a day on so little gasoline. No other car of the same size so saving of tires.

The first Overland sold has been on the road day-in-and-day-out, summer-and-winter—seen far harder service than you'll probably ever give your car—yet the cost for repairs has been scarcely worth counting; and to-day it's as strong-going, smooth-running, noiseless and easy-riding as any new car.

It is a car you can keep always on the go, all-day-long, day-after-day, without trouble or repair bills—a car always ready and reliable under all conditions, usual or unusual—with plenty of reserve power for hard climbs and heavy roads.

4 Cyl., 30 H.P.
Planetary Trans-Roadster
\$1250

4 Cyl., 30 H.P.
Planetary Trans-5 Passenger Tonneau
\$1400

4 Cyl., 30 H.P.
Selective Trans-Touring Car
\$1500

6 Cyl., 45 H.P.
Selective Trans-Touring Car
\$2250

Choice of bodies in each of these models.

Let us give you the name of the dealer in your territory so you can have a prove-up demonstration.

OVERLAND AUTOMOBILE CO.
INDIANAPOLIS, IND.

STOP!!

Go no further until you have read this offer of

A FREE TRIAL FOR THIRTY DAYS

Simply to prove our faith in the great efficiency and reliability of

THE "STAR" SPEEDOMETER

We ask you to take one and give it a tryout. Put it on your car and try it for registration at the highest speed you dare to go—try it at slow speed—try it for the registry of fractions of a mile—try it for a 10,000-mile run if you can work the 10,000 miles into a month. Forget that we claim the "STAR" to be a better speedometer than any made at prices double or treble our price

—prove us wrong if you can. There's the proposition—take a "STAR" and try it for a month on your own car in your own way. If it doesn't make good send it back to us and we'll return your money without a whimper. In this way you don't have to take our say so that the "STAR" is good—you are to believe only what is demonstrated on your own car right before your eyes, regardless of our claims of "STAR" Speedometer superiority. You can't ask for a fairer proposition than this, can you? Do we get the chance to make good? At least, write to-day for literature; it will greatly interest you.

You'd do well to send to-day and get your speedometer in shape now, for Summer touring.

Star Speedometer Co. Danville, Penna.

New York, 1755 Broadway Boston, Mass., 222 Eliot St.
Philadelphia, Pa., Geo. W. Nock Co., 126 N. 4th St.

DEALERS: If we can only get your letter of inquiry we know we can present you a proposition to push "STAR" Speedometers that will be mutually agreeable and result in much profit to each of us. You are doing yourself an injustice every day you let this opportunity pass. Write **TO-DAY**.



PLEASE MENTION THE AUTOMOBILE WHEN WRITING TO ADVERTISERS

Do You Belong to the "Maxwell" Family?

MAXWELL owners are a contented lot—for their's is a car to ride in, not to tinker over.

An owner's verdict is the final analysis of the value of an automobile. Since there are 14,600 satisfied MAXWELL owners it would be an easy matter for you to get an unprejudiced opinion.

The tour of the Maxwell Briscoe Motor Club is an indication of the confidence MAXWELL owners place in their cars.

Over 30 MAXWELLS assembled at Columbus Circle on June 14th for a week's tour through the Berkshire Hills of Massachusetts, and over the roads of New York, Connecticut, Pennsylvania and New Jersey—a thousand miles in all.

MAXWELL owners feel the spirit of cooperation extended them by the men who make the MAXWELL.

Why don't you join the MAXWELL Family? Let me send you our catalog and other literature.

Yours very truly,

Benj. Briscoe President

MAXWELLS range in price from \$500 to \$1,750. From 2-cylinder, 10 H. P. runabout to a big 4-cylinder 30 H. P. touring car or roadster. One of our six models will solve your automobile problem.

MAXWELL BRISCOE MOTOR CO.

P. O. Box 103, TARRYTOWN, N. Y.

PAWTUCKET, R. I.

Main Office and Factory

NEW CASTLE, IND.

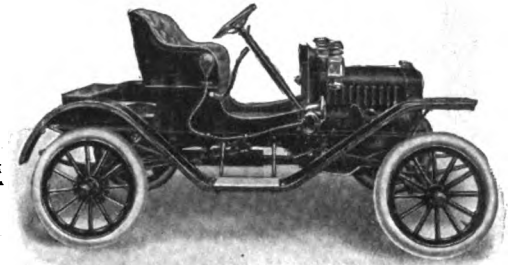

Model A—2 Cyl. 10 H.P.—\$550

This standard American runabout costs only \$550. It incorporates all the MAXWELL principles that have made these cars famous the world over. Equipped as per illustration with long fenders and running boards, oil lamps, etc.

Maxwell Junior, \$500

Equipped with plain mud guards only, oil lights, etc.

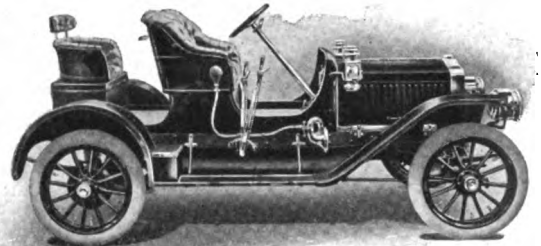

Model K. A.—4 Cyl. 30 H.P.—\$1,750

A gentleman's roadster of "class," equipped with gas lamps, generator and magneto. Same chassis as famous 10,000 mile Non Stop car.

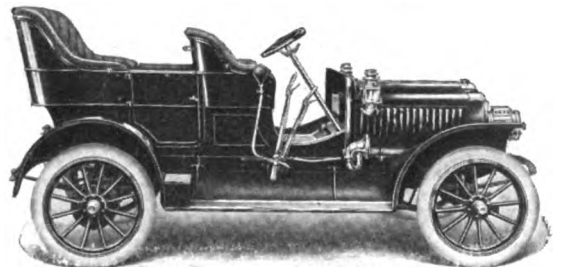

Model D. A.—4 Cyl. 30 H.P.—\$1,750

A powerful five-passenger touring car, combining MAXWELL reliability with speed and comfort. Duplicate of the world's record holding 10,000 mile Non-Stop MAXWELL. Equipped with gas lamps, generator and magneto.

PLEASE MENTION THE AUTOMOBILE WHEN WRITING TO ADVERTISERS

The Car of *Real Power*

MIDLAND

BUILT RIGHT

LOOKS RIGHT

STAYS RIGHT

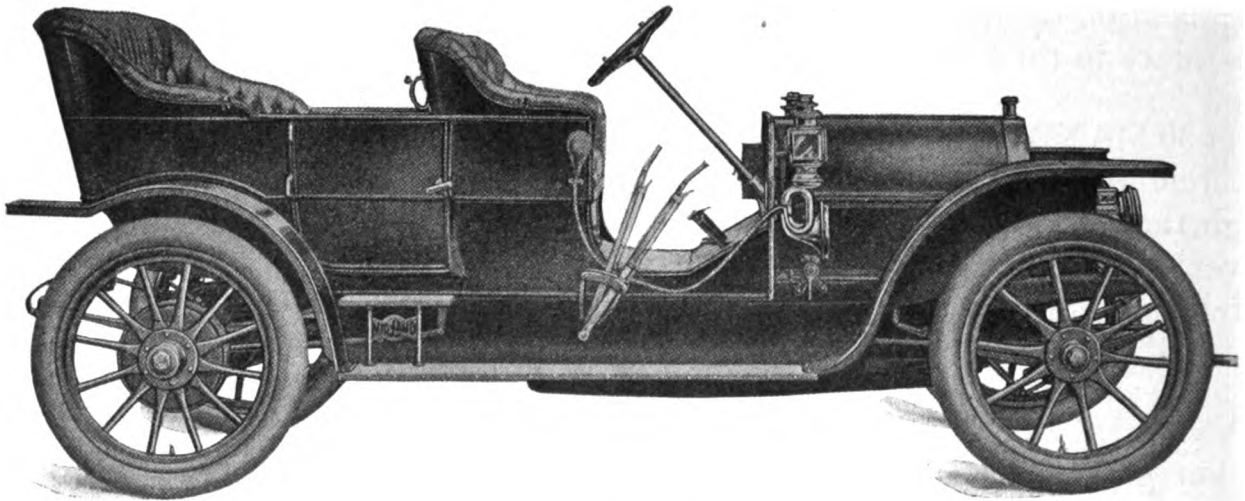

Model G 9, Five-Passenger Touring Car

IMMEDIATE DELIVERY

Motor, 4½ x 5½, 4 Cylinder
Wheels, 36 x 4
Wheel Base, 118"
Axles, I Beam Front, Full Floating Rear
Lubrication, Pumping Crank Case

Transmission Selective 3-Speed and Reverse
Bearings, Timken
Ignition, Magneto and Battery
Clutch, Disc Cork Inserts
Body, Full Size 5 Passenger

MIDLAND MOTOR COMPANY

FACTORY AND OFFICE: MOLINE, ILL.

NEW YORK CITY.—Midland N. Y. Co., 1783 Broadway
PATERSON, N. J.—E. K. Conover, 675 East 23d Street
PHILADELPHIA, PA.—Stoyle Vogel Auto Co., Broad and
Race Streets
BOSTON, MASS.—N. E. Motor Sales Co., 364 Columbus Ave.
MINNEAPOLIS, MINN.—Haynes Motor Car Co.

OMAHA, NEB.—Freeland Brothers & Ashley
STERLING, ILL.—Sterling Motor Company
CLEVELAND, O.—Wingle Motor Car Company
CHICAGO, ILL.—Kramer Motor Car Co., Evanston and Sheri-
dan Streets

PLEASE MENTION THE AUTOMOBILE WHEN WRITING TO ADVERTISERS

Rambler

The Car of Steady Service

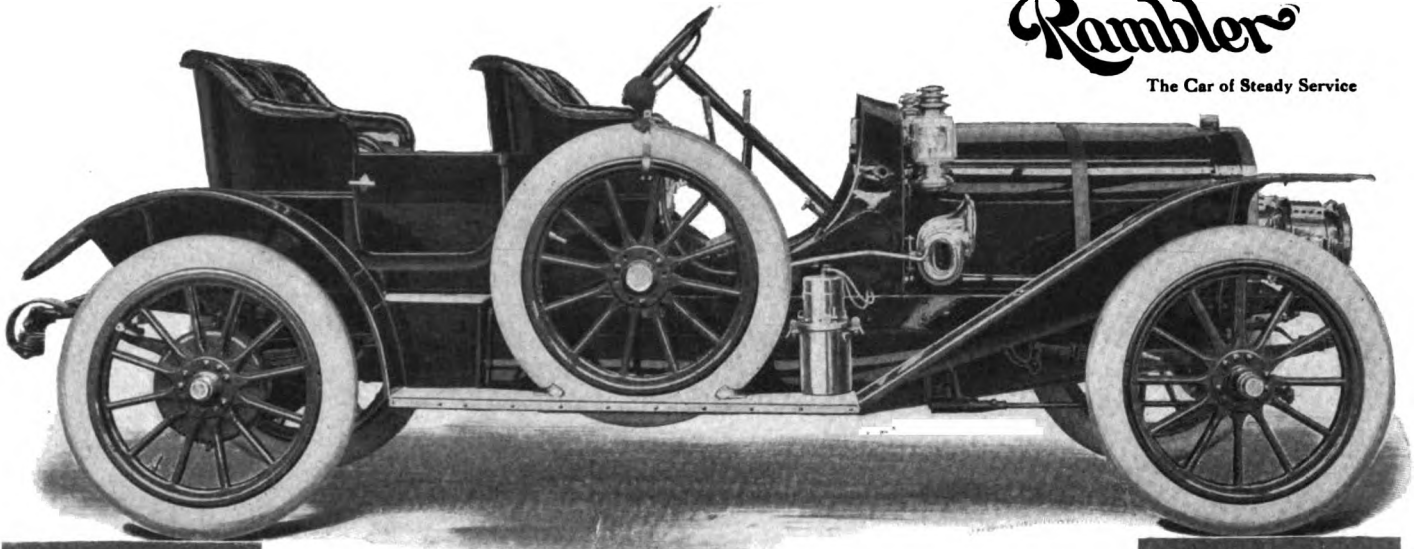

Model Forty-five, Four-Passenger Car, \$2,500.
With Lamps and Tools only.

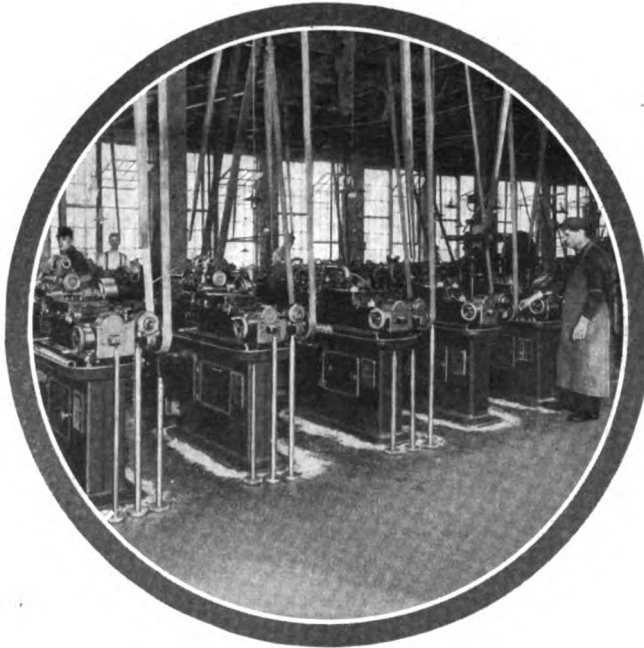

Automatic gear-cutters, Rambler Factory.

The application of automatic machinery throughout the Rambler Factory not only makes absolute accuracy and interchangeability of parts certain, but insures the most perfect product that skilled workmen, aided by complete factory equipment, can produce.

Representatives in all leading cities.

Thomas B. Jeffery & Company, Main Office and Factory, Kenosha, Wis.
Branches and Distributing Agencies: Chicago, Milwaukee, Boston, Cleveland, New York, San Francisco.

PLEASE MENTION THE AUTOMOBILE WHEN WRITING TO ADVERTISERS

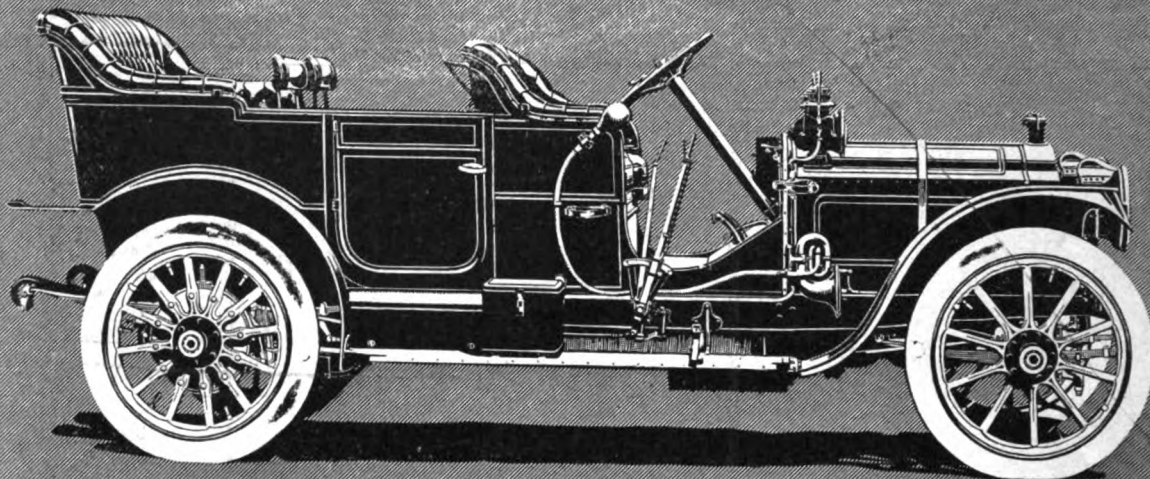

Packard

MOTOR CARS

1910



Packard Motor Car Company
Detroit, Michigan

PLEASE MENTION THE AUTOMOBILE WHEN WRITING TO ADVERTISERS



Take with you on
your Summer Tours
"The World's Great-
est Lubricant" and
rest care-free from
Lubrication Troubles

KEYSTONE GREASE

Can always be depended upon
to give perfect satisfaction

Sold at Auto Supply Stores and Garages or direct from

KEYSTONE LUBRICATING CO.
Philadelphia, Pa.

CHICAGO
1210 Tacoma Bldg.

NEW YORK
1777 Broadway

BOSTON
Oliver Bldg.

NEW ORLEANS
610-612 Chartres Bldg.

36
16

Atwood-Castle Co.

Quality

Lamps

We have never, in all of our experience of thirty-five years in lamp making, found it desirable or business-like to make cheap, flimsy lamps to meet competition in price. The watchword has been *quality* regardless of price, but always under most favorable manufacturing conditions for cheapening cost. No material has ever been too high priced to be of use if it would enhance the quality of our output; no skimping has been done to save a few cents and endanger this quality; no workmanship deviating in the least from the very best has ever been allowed.

Every Atwood-Castle Lamp that has gone forth from our factory has been as good a lamp as the best brains, capital, facilities and experience can make it.

This strict adherence to *quality* has been the means of making us a reputation as lamp builders held by no other lamp-making concern on earth. We're proud of our line of lamps—*there are none better*. We say this without qualification of any kind. For whatever purpose you may need a lamp on your car, there is an ATWOOD-CASTLE Lamp to fill the need, and it will fill the need better than any other lamp of any kind made by anyone.

ATWOOD-CASTLE CO.
Amesbury, Mass.

WESTERN OFFICE:
247 Jefferson Avenue
Detroit, Mich.

OUR NEW COMPLETE LINE FOR

1910

NOW READY

